

Oracle Utilities Billing Cloud Service User Guides

Oracle Utilities Billing Cloud Service is based on functionality in Oracle Utilities Customer to Meter. As such, both use the same user documentation. Oracle Utilities Billing Cloud Service User Guides comprise the following:

- Oracle Utilities Customer to Meter Business User Guide
- Oracle Utilities Customer to Meter Administrative User Guide

Refer to **Oracle Utilities Billing Cloud Service** in the *Business User Guide* and **Defining Oracle Utilities Billing Cloud Service Options** in the *Administrative User Guide* more specific information related to Oracle Utilities Billing Cloud Service.

Release 23A

F76023-01

Oracle Utilities Customer to Meter

Business User Guide

Release 2.9.0.1.1

F76345-01

April 2023

Also used with:

- Oracle Utilities Customer Cloud Service 23A
- Oracle Utilities Billing Cloud Service 23A
- Oracle Utilities Rate Cloud Service 23A

Oracle Utilities Customer to Meter Business User Guide

Release 2.9.0.1.1

F76345-01

April 2023

Documentation build: 3.23.2023 12:15:36 [X1_1679591736000]

Copyright © 2023 Oracle and/or its affiliates. All rights reserved.

This software and related documentation are provided under a license agreement containing restrictions on use and disclosure and are protected by intellectual property laws. Except as expressly permitted in your license agreement or allowed by law, you may not use, copy, reproduce, translate, broadcast, modify, license, transmit, distribute, exhibit, perform, publish, or display any part, in any form, or by any means. Reverse engineering, disassembly, or decompilation of this software, unless required by law for interoperability, is prohibited.

The information contained herein is subject to change without notice and is not warranted to be error-free. If you find any errors, please report them to us in writing.

If this is software or related documentation that is delivered to the U.S. Government or anyone licensing it on behalf of the U.S. Government, then the following notice is applicable:

U.S. GOVERNMENT END USERS: Oracle programs, including any operating system, integrated software, any programs installed on the hardware, and/or documentation, delivered to U.S. Government end users are "commercial computer software" pursuant to the applicable Federal Acquisition Regulation and agency-specific supplemental regulations. As such, use, duplication, disclosure, modification, and adaptation of the programs, including any operating system, integrated software, any programs installed on the hardware, and/or documentation, shall be subject to license terms and license restrictions applicable to the programs. No other rights are granted to the U.S. Government.

This software or hardware is developed for general use in a variety of information management applications. It is not developed or intended for use in any inherently dangerous applications, including applications that may create a risk of personal injury. If you use this software or hardware in dangerous applications, then you shall be responsible to take all appropriate fail-safe, backup, redundancy, and other measures to ensure its safe use. Oracle Corporation and its affiliates disclaim any liability for any damages caused by use of this software or hardware in dangerous applications.

Oracle and Java are registered trademarks of Oracle and/or its affiliates. Other names may be trademarks of their respective owners. Intel and Intel Xeon are trademarks or registered trademarks of Intel Corporation. All SPARC trademarks are used under license and are trademarks or registered trademarks of SPARC International, Inc. AMD, Opteron, the AMD logo, and the AMD Opteron logo are trademarks or registered trademarks of Advanced Micro Devices. UNIX is a registered trademark of The Open Group.

This software or hardware and documentation may provide access to or information about content, products, and services from third parties. Oracle Corporation and its affiliates are not responsible for and expressly disclaim all warranties of any kind with respect to third-party content, products, and services unless otherwise set forth in an applicable agreement between you and Oracle. Oracle Corporation and its affiliates will not be responsible for any loss, costs, or damages incurred due to your access to or use of third-party content, products, or services, except as set forth in an applicable agreement between you and Oracle.

Contents

Business User Guide.....	27
Customer to Meter Overview.....	27
Oracle Utilities Customer Care and Billing Overview.....	28
Oracle Utilities Meter Data Management Overview.....	29
Oracle Utilities Smart Grid Gateway Overview.....	29
Oracle Utilities Service Order Management Overview.....	29
Oracle Utilities Operational Device Management Overview.....	30
Oracle Utilities Market Settlements Management Overview.....	30
User Interface Standard Features.....	31
Page Components.....	31
The Application Toolbar.....	32
Home Icon.....	32
Menu.....	32
Admin Menu.....	33
Back and Forward Arrows.....	34
History Icon.....	35
Search.....	36
Help Menu.....	37
User Menu.....	38
Page Title Area.....	39
Page Actions Toolbar.....	39
Object Display Area.....	43
Multiple Tabs.....	43
Text Box.....	44
Date and Time Fields.....	46
Search Button.....	47
Context Menu Button.....	48
Go To Button.....	48
Broadcast Button.....	48
Embedded Help Icon.....	48
Work Lists.....	48
Scroll Bars with Dynamic Height.....	49
Sorting Functionality.....	50
Get More Functionality.....	50
Adding and Removing Rows Using Arrows.....	50
Reorganizing Items Using the Up and Down Arrows.....	51
Trees.....	51
Required Field Indicator.....	53
Accordion Windows.....	53
Dashboard Area.....	54
Script Area.....	54
Portal Pages.....	55
Portals Are Made Up Of Zones.....	55
Users Must Be Granted Security Access To Each Zone.....	56
Zones May Appear Collapsed When A Page Opens.....	56
Some Portals Allow User Customization.....	57
Dashboard Portal.....	57
Bookmarks Zone.....	58
Tags Zone.....	58
Collect Entity Zone.....	58
Current To Do Zone.....	58
Favorite Links Zone.....	60
Favorite Scripts Zone.....	60
Favorite Searches Zone.....	60
Switch Language Zone.....	60
To Do Summary Zone.....	60
Work List Zone.....	61
Zone Types and Characteristics.....	61

Common Characteristics of Zones.....	62
Explorer Zones.....	62
Map Zones.....	68
Tabbed Display Zones.....	68
Timeline Zone.....	69
Common Base Portals and Zones.....	70
All-In-One Portal.....	70
Separate Query and Maintenance Portals.....	70
Process Flow.....	71
Fixed Pages.....	72
Maintenance Pages.....	72
The Unique Identifier Area.....	72
Confirmation & Error Messages.....	72
Warning If Unsaved Changes Exist.....	72
Query Pages.....	73
The Search Area.....	73
User Preferences.....	73
User - Main.....	74
User - To Do Roles.....	75
User - Access Security.....	75
User - Bookmarks.....	76
User - Portal Preferences.....	76
User - Favorite Links.....	77
User - Favorite Scripts.....	78
User - Characteristics.....	78
User - Miscellaneous.....	78
Initiating Scripts.....	79
Shortcut Key Summary.....	80
Customer Information.....	83
Understanding The V.....	83
Persons.....	84
Accounts.....	84
Service Agreements (SAs).....	85
Premises.....	85
Service Points (SPs).....	86
Metered versus Item-Based versus Non-Badged Service Points.....	86
Service Points With Multiple Items.....	87
Putting It All Together.....	87
Sample V For A Residential Customer.....	88
Sample V For A Commercial Customer With Multiple Premises.....	88
How To Set Up Customer Hierarchies.....	89
Navigating The V.....	90
Control Central.....	90
Control Central - Search.....	90
Control Central - Account Information.....	93
Control Central - Customer Information.....	109
Control Central - Account Tree.....	111
Control Central - Premise Tree.....	111
Control Central - Bill/Payment Tree.....	111
Control Central - Payment Agreements.....	112
How To Add A New Customer From Control Central.....	112
Customer 360.....	113
Customer 360 - Unified Search.....	113
Customer 360 - Program Enrollment.....	114
Customer 360 - Customer Insights.....	115
Customer 360 - Customer Activity.....	115
Customer 360 - Financial Activity.....	116
Maintaining The V.....	117
Maintaining Persons.....	117
Person - Main Information.....	117
Person - Correspondence Information.....	121
Person - Characteristics.....	122
Person - Persons.....	123
Person - Person Portal.....	123

Maintaining Accounts.....	125
Account - Main Information.....	125
Account - Auto Pay.....	127
Account - Person Information.....	128
Account - Financial Balances.....	131
Account - Bill Messages.....	132
Account - C&C.....	132
Account - Budget.....	135
Account - Deposits.....	136
Account - Characteristics.....	137
Account - Alerts.....	137
Account - Account Portal.....	138
Account Management Portal.....	139
Account - SAs For A Debt Class.....	140
Using The Account/Person Replicator.....	140
Information Replicated for New Persons.....	141
Information Replicated for New Accounts.....	141
Maintaining Service Agreements.....	142
The Lifecycle Of A Service Agreement.....	142
Service Agreement - Main Information.....	145
Service Agreement - Rate Info.....	149
Service Agreement - SA / SP.....	152
Service Agreement - Chars, Qty & Rec. Charges.....	153
Service Agreement - Miscellaneous.....	154
Service Agreement - Contract Options.....	155
Service Agreement - TOU Contract Values.....	155
Service Agreement - Billing Scenario.....	156
Service Agreement - SA Portal.....	156
Maintaining SA Relationships.....	157
Service Provider SA Relationship.....	159
Maintaining Premises.....	160
Premise - Main Information.....	161
Premise - Characteristics.....	162
Premise - Miscellaneous.....	162
Premise - Geographic Data.....	163
Premise - Alternate Address.....	163
Premise - Premise Portal.....	164
Maintaining Service Points.....	164
Dashboard Portal.....	165
Current Context Zone.....	165
Customer Contact Zone.....	166
Financial Information Dashboard Zone.....	166
Alert Dashboard Zone.....	166
Customer Context Zone.....	166
Premise Context Zone.....	167
Setting Up Bill Print Groups.....	167
Bill Print Group - Main.....	168
Bill Print Group - SA Sub Group.....	169
Landlord Reversion.....	170
Setting Up Landlord Agreements.....	171
Using The Premise Replicator.....	172
Premise Replicator - Main Information.....	172
Premise Replicator - Premise.....	173
Premise Replicator - Premise SPs.....	173
Start/Stop.....	173
The Big Picture Of Starting Service.....	174
The Lifecycle Of A Pending Start Service Agreement.....	174
Starting Service and Field Activities.....	175
Activating Pending Starts.....	176
What Happens After A SA Is Started?.....	177
The Big Picture Of Stopping Service.....	177
The Lifecycle Of A Pending Stop Service Agreement.....	177
Stopping Service and Field Activities.....	178
Finalizing Pending Stops.....	179

What Happens After A Service Agreement Is Stopped?.....	181
Start/Stop Maintenance.....	181
Start/Stop - Main.....	181
Start/Stop - Start Confirmation.....	185
Start/Stop - Stop Confirmation.....	187
Start/Stop - Address/Phone.....	188
Start/Stop - Pending SA.....	190
Start/Stop - Pending Field Activity.....	192
How To.....	193
Customer Contacts.....	196
Person-Based Versus Premise-Based Customer Contacts.....	197
How Customer Contacts Are Created.....	197
Customer Contacts Are Used To Trigger Letters.....	197
A Customer Contact May Trigger Reminders.....	198
Customer Contacts Are Used To Record Notifications.....	198
Customer Contacts Can Be Used As Case Files.....	198
Maintaining Customer Contacts.....	199
Printing Letters.....	199
The Letter Extract Processes.....	199
BI Publisher Versus Document Composition Applications.....	200
Where Does The Address Come From?.....	200
Technical Implementation Of Online Letter Display.....	201
Reproducing The Letter Print Flat File.....	202
How To Reprint A Specific Letter.....	202
Letter Data Area Organization.....	202
Letter Extract File Structure.....	202
Extending Letter Record Types.....	203
Maintaining Declarations.....	203
Service Tasks.....	204
The Big Picture of Service Tasks.....	204
Searching and Viewing Service Tasks.....	204
Registration Points.....	204
Understanding Registration Points.....	205
Maintaining Registration Points.....	205
Consumer Contracts.....	205
Maintaining Consumer Contracts.....	205
Customer Service Requests.....	206
Understanding Customer Service Requests.....	206
About Starting, Stopping and Transferring Service Using Customer Service Requests.....	206
The Start Service Process and Request.....	207
The Stop Service Process and Request.....	208
The Transfer Service Process and Request.....	210
Additional Information About the Start, Stop, and Transfer Processes.....	211
Displaying Insights on Start and Transfer Service Processes.....	211
Maintaining Customer Service Requests.....	212
Maintaining Customer Service Request Person.....	213
Maintaining Customer Service Request Account.....	213
Maintaining Customer Service Request Premise.....	213
Maintaining Customer Service Request SA.....	213
Maintaining Customer Service Request Contract.....	213
Maintaining Customer Service Request Contract Product.....	214
Maintaining Customer Service Request Service Location.....	214
Asset Management.....	214
Assets.....	214
About Assets.....	214
Maintaining Assets.....	216
Asset Activities.....	217
About Asset Activities.....	218
Maintaining Asset Activities.....	218
Asset Activity Generators.....	219
About Asset Activity Generators.....	219
Maintaining Asset Activity Generators.....	220
Asset Completion Events.....	220
About Asset Completion Events.....	220

Maintaining Asset Completion Events.....	221
Asset Inbound Communications.....	221
About Asset Inbound Communications.....	221
Maintaining Asset Inbound Communications.....	222
Asset Locations.....	222
About Asset Locations.....	222
Maintaining Asset Locations.....	222
Asset Replication.....	223
About Asset Replication.....	223
Maintaining Asset Replication.....	223
Manufacturers.....	223
About Manufacturers.....	223
Maintaining Manufacturers.....	224
Mass Asset Disposition Update.....	224
Service History.....	224
About Service History.....	224
Maintaining Service History.....	225
Shipping Memos.....	225
About Shipping Memos.....	225
Maintaining Shipping Memos.....	226
Specifications.....	226
About Specifications.....	226
Maintaining Specifications.....	227
Device Management.....	227
Devices.....	227
About Meters.....	227
About Items.....	229
About Communication Components.....	229
Maintaining Devices.....	229
Device Configurations.....	230
About Device Configurations.....	230
Maintaining Device Configurations.....	230
Measuring Components.....	231
About Measuring Components.....	231
Physical Measuring Components.....	233
Scratchpad Measuring Components.....	234
Maintaining Measuring Components.....	235
Uploading Measurement Data.....	235
Requesting Measurement Data.....	236
Measuring Component Comparison Periods.....	237
About Measuring Component Comparison Periods.....	237
Maintaining Measuring Component Comparison Periods.....	238
Device Installations.....	238
Service Points.....	238
About Service Points.....	238
Maintaining Service Points.....	239
Service Point Quantities.....	240
About Service Point Quantities.....	240
Maintaining Service Point Quantities.....	241
Install Events.....	241
About Install Events.....	241
Maintaining Install Events.....	241
Correcting Cross Installed Meters.....	242
Route Management.....	245
About Route Management.....	245
Working with Route Management.....	245
Facilities.....	246
About Facilities.....	246
Maintaining Facilities.....	246
Network Locations.....	246
About Network Locations.....	246
Maintaining Network Locations.....	246
Measurements.....	247
Initial Measurement Data.....	247

About Initial Measurement Data.....	247
Processing Initial Measurement Data.....	248
Maintaining Measuring Component Dates.....	255
CSV Upload.....	259
Importing Data From External Systems.....	259
Final Measurements.....	259
About Final Measurements.....	259
Reader Remarks.....	261
Periodic Estimation.....	262
About Periodic Estimation.....	262
Measurement Reprocessing.....	269
About Measurement Reprocessing.....	269
Reviewing Measurements for Reprocessing.....	270
Consumption Sync.....	270
Introduction to Consumption Sync.....	271
VEE.....	272
Introduction to VEE.....	273
About VEE.....	273
Decision-Making VEE Rules.....	275
Validations.....	275
About IMD Validations.....	276
Reviewing and Resolving VEE Exceptions.....	277
Usage Transaction Validations.....	277
Estimations.....	277
About IMD Estimations.....	277
Usage Transaction Estimations.....	278
Editing.....	278
About IMD Editing.....	278
Editing Initial Measurements.....	279
Generating New Initial Measurements.....	279
Usage.....	279
Introduction to Usage Calculation.....	279
About Usage Calculation.....	279
Usage Subscriptions.....	281
About Usage Subscriptions.....	281
Maintaining Usage Subscriptions.....	281
Usage Subscription Market Participants.....	282
About Usage Subscription Market Participants.....	282
Maintaining Usage Subscription Market Participants.....	282
Usage Transactions.....	282
About Usage Transactions.....	282
About Usage Validations.....	286
Reviewing and Resolving Usage Transactions.....	287
Triggering Adjustment Notifications.....	287
Inventory of Other Usage Calculation Rules.....	288
Usage Requests.....	291
Usage Calculation Requests.....	291
About Usage Calculation Requests.....	291
Maintaining Usage Calculation Requests.....	291
Usage Subscription Quantities.....	292
About Usage Subscription Quantities.....	292
Maintaining Usage Subscription Quantities.....	292
Time of Use Maps.....	292
About Time-of-use Processing.....	292
About TOU Maps.....	293
Maintaining TOU Maps.....	293
Dynamic Options.....	294
About Dynamic Options.....	294
About Dynamic Option Events.....	294
Maintaining Dynamic Options.....	295
Maintaining Dynamic Option Events.....	295
Consumption Extract Requests.....	295
About Consumption Extract Requests.....	295
Maintaining Consumption Extract Requests.....	296

Contacts.....	296
About Contacts.....	296
Maintaining Contacts.....	296
360 Degree and Unified Search.....	296
Using 360 Degree Search.....	296
Using Unified Search.....	297
360 Degree Views.....	298
360 View Measuring Component.....	298
Using 360 Degree View Measuring Component.....	298
Applying Measurement Functions.....	299
360 Degree View Device.....	299
Using 360 Degree View Device.....	300
360 Degree View Service Point.....	300
Using 360 Degree View Service Point.....	300
360 Degree View Usage Subscription.....	301
Using 360 Degree View Usage Subscription.....	301
360 Degree View Contact.....	301
Using 360 Degree View Contact.....	301
Service Orders.....	301
About Service Order Activities.....	302
How Are Service Order Activities Created?.....	303
About Service Order Field Activities.....	303
What Happens After A Field Activity Is Completed?.....	304
About Appointments.....	304
Field Activity Maintenance.....	305
Lifecycle of a Field Activity.....	305
Field Activity - Main Information.....	305
Field Activity - Steps.....	306
Field Activity - Characteristics/Remarks.....	306
Field Activity - Field Activity Portal.....	307
Field Activity - Log.....	307
Outage Calls.....	308
Outage Call Zone.....	308
Outage Information.....	308
Job History.....	309
Call History.....	309
Planned Outages.....	309
Service Calls.....	309
The Service Call Process and Service Call Communication.....	310
Maintaining Service Call Communications.....	312
Billing.....	312
The Big Picture of Billing.....	312
An Illustration Of A Simple Bill.....	312
An Overview of the Bill Creation Process.....	314
Bill Errors.....	315
Bill Segment Errors.....	315
Bill Completion Errors.....	316
Cancel / Rebill Incorrect Bill Segments.....	316
Credit Notes - Presenting Cancellation Details on a Separate Bill.....	317
Credit Notes Are Only Possible if the Installation Option Is Turned On.....	317
Credit / Correction Notes and Auto Pay.....	317
Adjustments On Credit Notes.....	318
Credit Note Routing Suppression.....	318
Correction Notes - Presenting Correction Details on a Separate Bill.....	318
Correction Notes Are Only Possible if the Installation Option Is Turned On.....	319
Correction Notes Versus Credit Notes.....	319
Correction Notes and Auto Pay.....	319
How the System Requests How Much Was Consumed.....	319
Item Snapshot.....	320
Service Quantity Snapshot.....	320
Calculation / Audit Read Details.....	321
Calculation / Audit Usage Details.....	321
How To Override The Commodity Amount In A Bill Segment.....	322
How Rates Affect the Information on Bill Segments.....	322

Bill Frequency - Bill Cycle vs Bill Segment Duration.....	323
Ways To Control The Start Date Of A Bill Segment.....	323
Ways To Control The End Date Of A Bill Segment.....	323
Preventing Short Bill Segments.....	326
Prorating Charges When a Rate is Applied.....	326
Batch Billing.....	326
Window Billing And The Bill Cycle Schedule.....	326
Confirming A Batch Of Bills Before Completing Them.....	326
Canceling A Batch Of Bills After They're Complete.....	327
Reopening A Batch Of Bills After They're Complete.....	327
Fixing Errors Detected In Batch Billing.....	327
Completing Pending Bills.....	327
Billing Financial Transaction Considerations.....	328
Billing - Current Balance versus Payoff Balance.....	328
The Source Of GL Accounts On A Bill Segment's Financial Transaction.....	329
Determining the Statistical Quantity.....	330
The Source Of Bill Routing Information.....	330
Bill Messages.....	331
The Source Of Bill Messages.....	331
Substituting Field Values Into A Message.....	331
A Bill May Affect More Than Just Customer Balances.....	332
Auto Cancel / Rebill If A Service Agreement Is Stopped Retroactively.....	332
Cancel Historical, Estimated Bill Segments When a Real Read Is Found.....	332
Deposits May Be Refunded.....	333
FT Freeze Repercussions.....	333
Budget Billing.....	333
Account versus Service Agreement.....	333
How To Set Up A Customer To Participate In A Budget Plan.....	333
The Financial Impact Of Budget Plans.....	334
Budget Billing Background Processes.....	334
Canceling A Budget.....	335
Net Energy Metering.....	335
What Is Net Energy Metering?.....	335
Net Energy Metering Service Agreements.....	336
Net Energy Metering True Up.....	336
Setting Up the System for Net Energy Metering.....	337
Net Energy Metering Billing Examples.....	338
Using Billable Charges for Pass Through / Convergent Billing.....	341
Printing Bills.....	343
Bill Routings Are Created For Each Recipient Of A Bill.....	343
Bill Route Types Control The Information Merged Onto Bills.....	343
Technical Implementation Of Online Bill Display.....	344
Technical Implementation Of Printing Bills In Batch.....	345
Reproducing The Bill Print Flat File.....	345
How To Reprint A Specific Bill.....	345
Who Gets A Copy Of A Bill?.....	345
Final Bills and Bill Print.....	345
The Bill Extract Records.....	346
XML Bill Extracts.....	358
Sequential Bill Numbers.....	358
Sequential Numbers Are Only Assigned If The Installation Option Is Turned On.....	359
Pending Bills Do Not Have A Sequential Bill Number.....	359
When / How Is The Sequential Bill Number Assigned.....	359
Additional Functionality for Sequential Bill Numbering.....	360
Document Numbers.....	360
Document Numbers Are Only Assigned If the Installation Option Is Turned On.....	360
Pending Bills Do Not Have a Document Number.....	361
When/How Is the Document Number Assigned.....	361
Additional Functionality Exists When Document Numbers Are Used.....	361
Digital Signatures.....	361
Writing Off Bills.....	362
Idiosyncratic Manual Bill Cancellation.....	362
Maintaining Bills.....	362
Bill Lifecycle.....	363

Bill - Main Information.....	365
Generate.....	368
Freeze.....	369
Cancel Frozen.....	369
Freeze / Complete.....	370
Complete.....	371
Delete.....	371
Reopen.....	371
Credit Note.....	372
Correction Note.....	372
Write Off.....	373
Reverse Write Off.....	374
Cancel Bill.....	374
Bill - Bill Segments.....	374
Generate (Bill - Bill Segments).....	376
Freeze (Bill - Bill Segments).....	376
Delete (Bill - Bill Segments).....	376
Cancel/Rebill/Freeze (Bill - Bill Segments).....	377
Cancel (Bill - Bill Segments).....	378
Credit Note (Bill - Bill Segments).....	378
Correction Note (Bill - Bill Segments).....	379
Bill - Bill Routings.....	380
Bill - Bill Messages.....	381
Bill - Characteristics.....	382
How To.....	383
How To Create A Bill For All Service Agreements Linked To An Account.....	383
How To Create A Bill For A Specific Service Agreement.....	383
How To Create a Bill with no Bill Segments.....	384
How To Create A One-Time Invoice.....	384
How To Correct A Bill Segment That's In Error.....	384
How To Correct A Bill That's In Error.....	385
How To Cancel A Bill Segment.....	385
How To Cancel / Rebill A Bill Segment.....	386
How To Create A Credit Note.....	387
How To Create A Correction Note.....	387
How To Create An Off Cycle Bill Generator.....	388
How To Override The Items Billed On A Specific Bill Segment.....	388
How To Remove Unwanted Adjustments (or Payments) From A Completed Bill.....	389
How To Add An Adjustment (or Payment) To A Completed Bill.....	389
How To Reprint A Bill (For The Original Recipients or For Someone New).....	389
How To Add Ad Hoc Messages To A Bill.....	390
How To Remove A Completed Bill.....	390
How To Display A Bill On-line.....	391
Financial Transactions On A Bill.....	391
Maintaining Bill Segments.....	393
Bill Segment Lifecycle.....	393
Bill Segment - Main Information.....	395
Generate (Bill Segment).....	397
Delete (Bill Segment).....	397
Freeze (Bill Segment).....	398
Rebill (Bill Segment).....	398
Init Cancel (Bill Segment).....	399
Undo (Bill Segment).....	400
Cancel (Bill Segment).....	400
Credit Note (Bill Segment).....	400
Bill Segment - Read Details.....	401
Bill Segment - Item Details.....	401
Bill Segment - SQ Details.....	402
Bill Segment - Calc Lines.....	404
Bill Segment - Financial Details.....	406
Bill Segment - Bill Segment Messages.....	407
Bill Segment - Sub Bill Segments.....	407
Bill Segment - Bill Segment Portal.....	408
Bill Segment - Usage.....	408

Financial - Bill Segment Calculation Line Characteristics.....	408
Off Cycle Bill Generator.....	409
Off Cycle Bill Generator Query.....	409
Off Cycle Bill Generator Portal.....	409
Off Cycle Bill Generator Actions.....	409
Off Cycle Bill Generator Zone.....	410
Financial Transactions On Bill.....	410
Off Cycle Bill Generator Log.....	410
Multi Cancel/Rebill.....	410
Multi Cancel/Rebill - Main.....	410
Multi Cancel/Rebill - Graph.....	412
SA Billing History.....	412
Bill Exception.....	413
Bill Segment Exception.....	413
Maintaining Billable Charges.....	413
Billable Charge - Main.....	414
Billable Charge - Line Characteristics.....	415
Billable Charge - SQ Details.....	416
Billable Charge - Read Details.....	416
Uploading Billable Charges.....	417
Billable Charge Upload Background Processes.....	418
Process X - Populate BC Upload Staging.....	418
BCU1 - Validate & Populate Billable Charge Upload Staging.....	427
BCU2 - Create Billable Charge.....	428
BCUP-PRG - Purge Billable Charge Upload Objects.....	428
Billable Charge Upload Staging.....	429
Billable Charge Upload - Main.....	429
Billable Charge Upload - Lines.....	429
Billable Charge Upload - SQ Details.....	429
Billable Charge Upload - Read Details.....	430
Billable Charge Upload Exception.....	430
Budget Review.....	430
Payments.....	430
The Big Picture of Payments.....	431
A Payment Event Has Payments And Tenders.....	431
Multiple Tenders Used To Pay For Multiple Accounts.....	432
An Overview Of The Payment Event Creation & Allocation Process.....	432
Distributing A Payment Event.....	433
Distributing A Payment Amongst An Account's Service Agreements.....	434
Overpayment.....	436
Canceling A Tender Versus Canceling A Payment.....	436
NSF Cancellations.....	436
Transferring A Payment.....	437
Unbalanced Payment Events.....	437
How And When Payments Appear On Bills.....	438
Tender Management and Workstation Cashiering.....	438
Managing Your Cash Drawers.....	439
Turn Ins.....	441
Balancing By Tender Type.....	442
Cash Back.....	442
Managing Payments Interfaced From External Sources.....	443
Payment Financial Transaction Considerations.....	443
Payment - Current Balance versus Payoff Balance.....	444
The Source Of GL Accounts On A Payment Financial Transaction.....	444
A Payment May Affect More Than Just Customer Balances.....	444
Open Item Accounting and Match Events.....	444
FT Freeze Repercussions.....	444
Automatic Payments.....	445
How To Set Up A Customer To Pay Automatically.....	445
What Are Automatic Payments?.....	445
How And When Are Automatic Payments Created?.....	445
Automatic Payment Dates.....	447
How To Implement Maximum Withdrawal Limits.....	447
How Are Automatic Payments Cancelled?.....	447

Match Events Are Created For Open-Item Customers When An Automatic Payment Is Created.....	448
Pay Plans and Automatic Payments.....	448
Non-Billed Budgets and Automatic Payment.....	448
Downloading Automatic Payments and Interfacing Them To The GL.....	448
ACH Record Layouts.....	452
SEPA Direct Debit Record Layouts.....	455
Third Party Auto Pay Record Layouts.....	457
Third Party Payment Processing.....	458
One Time Payments.....	458
Account Verification.....	461
Automatic Payment Setup.....	461
Interfacing Automatic Payments To A Third Party.....	461
Highlighting Scheduled Payments.....	462
Automatic Payment Confirmations And Cancellations.....	462
Third Party Payment Tender Controls Processing.....	463
Issuing A Payment Advice Instead Of Creating An Automatic Payment.....	464
How To Set Up A Customer To Receive Payment Advices.....	464
Payment Advice Option Is For Bill-Related Automatic Payments Only.....	464
Maintaining Payment Events.....	464
Payment Lifecycles.....	465
Payment Event Lifecycle.....	465
Tender Lifecycle.....	465
Payment Lifecycle.....	466
Payment Event - Add Dialog.....	468
Add One-Time Payment.....	469
Payment Event - Main Information.....	471
Payment Event - Tenders.....	473
Payment Event - Characteristics.....	476
Exception.....	476
Payment Event Exception.....	476
Payment Exception.....	476
Resolving Exceptions Automatically.....	477
Payment Event Action Codes.....	477
Payment Actions.....	477
Payment Event Actions.....	478
Tender Actions.....	480
Payment Event Quick Add.....	480
Multiple Payment Events Dialog.....	481
Single Payment Event Dialog.....	483
Payment Quick Add.....	484
Maintaining Payments.....	486
Payment - Main.....	486
Payment - Pay Segments.....	488
Payment - Manual Distribution.....	489
Payment - Characteristics.....	491
Payment Action Codes.....	491
Distribute (A Payment).....	491
Redistribute (A Payment).....	492
Confirm (A Payment).....	492
Freeze (A Payment).....	492
Cancel (A Payment).....	492
Transfer (A Payment).....	492
Delete (A Payment).....	494
Payment Portal.....	494
Credit Card Payments.....	494
Non CIS Payments.....	494
Alternate Currency Payments.....	495
How To.....	495
How To Add A New Payment Event.....	495
How To Cash A Check.....	495
How To Allocate The Tender Amount To Multiple Accounts.....	496
How To Print Receipts And Endorsements.....	496
How To Cancel A Tender.....	497
How To Transfer A Payment From One Account To Another.....	497

How To Distribute A Payment To A Specific Service Agreement.....	498
How To Get An Unbalanced Tender Control In Balance (Fixing Over/Under).....	498
How To Add A Non-CIS Payment Using A Template.....	499
How To Authorize A Credit Card Tender.....	500
How To Reverse A Credit Card Tender.....	500
How To Process An Alternate Currency Payment.....	501
Financial Transactions On A Payment.....	501
Payment History.....	502
Payment Tender History.....	503
Payment / Tender Search.....	503
Maintaining Deposit Controls.....	506
The Lifecycle Of A Deposit Control.....	506
Deposit Control - Main.....	507
Deposit Control - Tender Control.....	508
Deposit Control - Tender Deposit.....	508
Deposit Control - Turn Ins.....	509
Deposit Control - Characteristics.....	509
Maintaining Tender Controls.....	510
The Lifecycle Of A Tender Control.....	510
Tender Control - Main.....	511
Tender Control - Tenders.....	512
Tender Control - Turn Ins.....	513
Tender Control - Exceptions.....	513
Tender Control - Characteristics.....	514
Interfacing Payments From External Sources.....	514
Interfacing Payments.....	514
Populating The Payment Upload Staging Records.....	514
PYUP-PRG - Purge Payment Upload Objects.....	523
Maintaining Deposit Control Staging.....	523
Payment Upload Staging.....	524
Payment Upload Exception.....	526
Interfacing Payments Using Distribution Rules.....	527
Populating The Payment Event Upload Staging Records.....	527
Payment Event Upload Staging.....	536
Adjustments.....	538
The Big Picture Of Adjustments.....	538
Adjustments - Current Balance versus Payoff Balance.....	538
When Current Balance Equals Payoff Balance.....	538
When Current Balance Differs From Payoff Balance.....	539
Adjustment Type And Balances.....	540
Canceling Adjustments.....	540
Transfer Adjustments.....	540
Calculated Adjustments.....	540
Adjustment Amount May Be Positive, Negative, Or Zero.....	541
Adjustment Type Controls Everything.....	541
Controls Which Balance(s) Are Affected.....	541
Defines The GL Account Affected By The Adjustment.....	541
Defaults The Adjustment Amount.....	542
Calculates The Adjustment Amount.....	542
Controls The Interface To A/P & 1099 Reporting.....	542
Controls Information Printed On The Bill.....	543
Controls If The Adjustment Can Be Frozen Prior To Bill Completion.....	543
Controls If The Adjustment Requires Approval.....	543
Unbilled Adjustments And Aged Debt.....	543
An Adjustment May Affect More Than Just Customer Balances.....	544
Maintaining Adjustments.....	544
The Lifecycle Of An Adjustment.....	544
Adjustment - Main Information.....	546
Adjustment - Characteristics.....	549
Adjustment - Transfer Adjustment.....	549
Adjustment - A/P Request.....	550
Adjustment - Adjustment Portal.....	551
Adjustment - Approval.....	551
Adjustment Information.....	551

Approval Request.....	552
Approval Request Log.....	552
Financial - Adjustment Calculation Line Characteristics.....	552
How and When To Use An Adjustment.....	552
How To Create A Transfer Adjustment.....	553
How To Create A Calculated Adjustment.....	553
How To Cancel An A/P Adjustment After It Has Been Selected By A/P.....	554
How To Correct Normal Service Agreement Debt.....	554
How To Apply Ad Hoc Fees To A Service Agreement.....	554
How To Apply Interest To A Deposit.....	554
How To Apply A Deposit To Outstanding Debt.....	555
How To Refund A Deposit With A Check.....	555
How To Write-Down Deposit Due.....	556
How To Refund A Credit Balance With A Check.....	556
How To Transfer A Credit Balance To A Service Agreement In Arrears.....	556
How To Change The Age Of Debt.....	556
How To Write-Down A Charitable Contribution Service Agreement Debt.....	557
How To Write-Off Debt.....	557
How To Cancel A Service Agreement's Budget.....	557
How To Adjust A Service Agreement On A Budget.....	558
How To Adjust An Installment Plan Service Agreement.....	558
How To Use An Adjustment To Change The GL Distribution.....	558
Interfacing Adjustments From External Sources.....	559
Interfacing Adjustments.....	559
Process X - Populate Adjustment Upload Records.....	559
Process C1-ADUP1 - Preprocess Adjustment Uploads.....	565
Process C1-ADUP2 - Upload Adjustments.....	567
Suspense Adjustments.....	568
What Are Suspense Adjustments?.....	568
How Are Suspense Adjustments Resolved?.....	568
Maintaining Adjustment Staging Control.....	568
Maintaining Adjustment Upload Staging.....	569
Credit & Collection.....	570
The Big Picture Of Credit & Collection.....	570
Automating Your C&C Activities.....	570
The Lifecycle Of A Collection Process And Its Events.....	570
What Is A Collection Process?.....	571
How Are Collection Processes Created?.....	571
How Are Collection Events Completed?.....	572
How Are Collection Processes (and their Events) Canceled?.....	572
What Happens If A Payment Is Not Received?.....	572
The Collection Process Background Processes.....	572
Account Debt Monitor.....	573
Collection Event Activator.....	573
Collection Process Monitor.....	574
The Lifecycle Of A Severance Process And Its Events.....	574
What Is A Severance Process?.....	575
How Are Severance Processes Created?.....	575
How Are Severance Events Completed?.....	576
How Are Severance Processes (and their Events) Canceled?.....	576
What Happens If The Customer Does Not Pay?.....	577
The Severance Process Background Processes.....	577
Severance Event Activator.....	578
Completing Severance Events That Are Dependent On The Completion Of A Field Activity.....	578
Set Trigger Date.....	578
The Lifecycle Of A Write-Off Process And Its Events.....	579
What Is A Write-Off Process?.....	580
How Are Write-Off Processes Created?.....	580
How Are Write-Off Events Completed?.....	580
How Are Write-Off Processes (and their Events) Canceled?.....	580
What Happens If The Debt Is Not Paid?.....	581
How Is Debt Referred To Collection Agencies.....	581
The Write-Off Process Background Processes.....	581
Write-Off Monitor.....	582

Write-Off Event Activator.....	582
Collection Process Maintenance.....	582
Collection Process - Main Information.....	583
Collection Process - SAs (Service Agreements).....	585
Collection Process - Events.....	586
How To Perform Common Collection Process Functions.....	587
How To Create A Collection Process.....	587
How To Change Collection Events.....	588
How To Cancel A Collection Process.....	588
Severance Process Maintenance.....	589
Severance Process - Main Information.....	589
Severance Process - Severance Events.....	591
Severance Process - Field Activity/Customer Contact.....	592
How To Perform Common Severance Process Functions.....	593
How To Create A Severance Process.....	593
How To Change Severance Events.....	593
How To Cancel A Severance Process.....	594
Write-Off Process Maintenance.....	594
Write Off Process - Main Information.....	594
Write Off Process - SAs (Service Agreements).....	596
Write Off Process - Events.....	597
How To Perform Common Write-Off Process Functions.....	598
How To Create A Write-Off Process.....	598
How To Change Write Off Events.....	599
How To Cancel A Write-Off Process.....	599
Writing Off Uncollectable Debt.....	600
Write Off - Main.....	600
How To Manually Write-Off Debt.....	600
Write Off - Write Off SAs.....	600
Collection Referral.....	601
Downloading Collection Agency Referrals.....	602
Collection Agency Extract Record.....	602
Payment Arrangements and Pay Plans.....	604
Setting Up Payment Arrangement Requests.....	604
Starting A Payment Arrangement Request.....	605
Maintaining Payment Arrangement Requests.....	605
Payment Arrangement Request Process Flow.....	605
Viewing Payment Arrangement Request History	606
Setting Up Payment Arrangements.....	606
Pay Arrangement - Main.....	606
How To Set Up A Payment Arrangement.....	608
How To Add Additional Debt To A Payment Arrangement.....	609
How To Break A Payment Arrangement.....	609
How To Cancel A Payment Arrangement.....	609
Pay Arrangement - History.....	610
Setting Up Pay Plans.....	610
Pay Plan - Main.....	611
How To Set Up A Pay Plan.....	612
Reviewing Pay Plans.....	612
Financial Transactions.....	612
The Big Picture Of Financial Transactions.....	612
Bill Segment Financial Transactions.....	612
Payment Segment Financial Transactions.....	613
Adjustment Financial Transactions.....	613
Financial Transactions And Aged Debt.....	613
Current Balance versus Payoff Balance.....	614
Adjustments - Current Balance versus Payoff Balance.....	614
Billing - Current Balance versus Payoff Balance.....	614
Payment - Current Balance versus Payoff Balance.....	614
The Source Of GL Accounts On Financial Transactions.....	614
Obscure Things That Can Happen.....	614
A Stopped Service Agreement May Be Closed.....	615
A Closed Service Agreement May Be Reactivated.....	615
A Write-Off Process May Be Deactivated If The SA Is Closed.....	615

A Reactivated Service Agreement May Be Closed.....	615
A Collection Process May Be Canceled When A Credit FT Is Frozen.....	615
A Severance Process May Be Canceled When A Credit FT Is Frozen.....	616
One Or More Algorithms May Be Executed.....	617
The Big Picture of Balance Control.....	617
The Balance Control Background Processes.....	617
Balance Control Information Is Available Online.....	618
The GL Interface.....	619
GLASSIGN - Assign GL Account Numbers To GL Details.....	619
GLS - Prepare FTs for Download.....	620
GLDL - Create General Ledger Download Flat File.....	620
Financial Transaction.....	621
Financial Transaction - Main.....	622
Financial Transaction - FT Process.....	624
Account Financial History.....	625
Account Bill / Payment History.....	625
SA Financial History.....	625
SA Non-Accrual Accounting Balance.....	626
Balance Control.....	626
Match Event.....	627
Match Event - Main.....	628
Match Event - FT Details.....	630
Match Event - Subtotals.....	633
How To Perform Common Match Event Functions.....	634
How To Find The Match Event Associated With A Financial Transaction.....	634
How To Dispute An Item.....	634
How To Match A Small Mismatch.....	634
Deposits.....	635
The Big Picture Of Deposits.....	635
Cash Deposits.....	635
Refunding Deposits.....	636
Partial Refunds.....	636
Total Amount To Bill.....	637
Current Balance versus Payoff Balance.....	637
Multiple Deposits Linked To A Single Account.....	638
Deposits and Credit & Collections.....	639
Deposit Seizures When Other SAs Are Stopped.....	639
Non-Cash Deposits.....	640
Third Party Deposits.....	640
Deposit Class Controls Everything.....	641
Controls Interest Calculation.....	641
Controls The Recommended Deposit Amount.....	642
Defines The Conditions That Cause The System To Recommend A New or Additional Deposit.....	642
Defines Automatic Refund Conditions.....	642
Controls How Deposits Are Refunded To A Customer.....	642
Deposit Background Processes.....	643
Deposit Interest.....	643
Deposit Refund.....	643
Review Deposits.....	643
Deposit Review.....	644
Statements.....	644
The Big Picture of Complex Statements.....	644
Constructing Statements.....	646
Producing Statements.....	646
Statement Cycles.....	646
Create Statements Background Process.....	647
Statement Routing.....	648
Where Are Statements Sent.....	648
On-Line Statement Production.....	648
How to Regenerate a Specific Statement.....	648
Printing Statements.....	649
Statement Route Types Control The Information Merged Onto Statements.....	649
Technical Implementation Of Online Statement Display.....	649
Technical Implementation Of Printing Statements In Batch.....	650

Reproducing The Statement Print Flat File.....	650
How To Reprint A Specific Statement.....	650
The Statement Extract Records.....	650
Statement Construct Maintenance.....	657
Lifecycle of a Statement Construct.....	657
Statement Construct - Main.....	658
Statement Construct - Details.....	659
Statement Maintenance.....	660
Lifecycle of a Statement.....	660
Statement - Main.....	660
Statement - Details.....	662
Sales & Marketing.....	662
The Big Picture of Campaigns, Packages, and Orders.....	663
An Overview of Campaigns, Packages and Orders.....	663
Supported Business Processes.....	664
Marketing to Prospects from a Marketing List.....	665
Marketing to Pre-Selected Customers.....	666
Real-Time Marketing of Additional Services to a Customer.....	667
Real-Time Marketing of Services to a Prospect.....	667
Setting up a New Customer Prior To Using Start/Stop.....	668
Examples of Campaigns and Packages.....	670
Campaigns Without Packages.....	670
Campaigns With Simple Packages.....	673
Campaigns With Complex Packages.....	675
The Big Picture Of Package Eligibility Rules.....	681
Criteria Groups versus Eligibility Criteria.....	682
Defining Logical Criteria.....	683
Examples Of Package Eligibility Rules.....	683
A Package That Is Always Eligible.....	684
A Package With A Time Span Comparison.....	684
A Package With Service Type Comparison.....	685
A Package With More Complex Operators.....	686
The Big Picture Of Campaign Eligibility Rules.....	687
Campaign Eligibility Rules Are Not Strictly Enforced.....	687
Campaign Eligibility Rules Are Defined Using Algorithms.....	687
Examples Of Campaign Eligibility Rules.....	688
A Campaign That Is Always Eligible.....	688
A Campaign That Is Never Eligible.....	688
A Campaign For Residential Customers.....	688
A Campaign For California, Residential Customers.....	688
Designing Campaigns and Packages.....	688
Determine The Place Of Start/Stop.....	689
Determine Which Types Of Service Agreements Are Created.....	689
Determine The Different Start Options That Exist For Each Type Of Service Agreement.....	689
Determine The SP Type (if any) For Each Service Agreement.....	690
Determine The Method Used To Create Each Service Agreement.....	690
Extract Algorithms From The Start Method.....	691
Determine Which Combinations Can Be Grouped Under A Package.....	691
Determine Package Eligibility Rules.....	691
Eligibility Rules For Package 1.....	692
Eligibility Rules For Package 2.....	692
Eligibility Rules For Package 3.....	693
Eligibility Rules For Package 4.....	694
Extract Algorithms From The Eligibility Rules.....	694
Extract Miscellaneous Fields From The Eligibility Rules.....	695
Determine Additional Information That Is Required If A Package Is Selected.....	695
Determine If There Are Additional Questions / Fields For Your Packages.....	695
Determine If Additional Instructions Should Be Shown.....	696
Determine If There Are Campaign-Level Fields / Questions.....	696
Determine The Properties Of Every Miscellaneous Field.....	697
Extract Characteristic From The Miscellaneous Fields.....	699
Extract Column References From The Miscellaneous Fields.....	699
Extract Algorithms From The Column References.....	700
Determine Account / Premise Dependency For Each Column Reference.....	701

Determine If Any Properties Are Overridden On Any Package.....	702
Determine The Eligibility Rules For The Campaign.....	702
Determine How The Campaign Behaves.....	703
Setup Sequence.....	703
Other Useful Information.....	704
Order versus Start/Stop.....	704
Orders Cannot Be Changed After They Are Completed.....	706
Premise and SP Characteristics May Be Populated From Postal Defaults.....	706
To Do List Processing.....	706
Hold and Cancel Reason Codes.....	706
Automatically Cancelling Old Orders.....	706
Additional Things Can Happen When An Order Is Completed.....	707
New Premises and Accounts Are Only Created if an Order is Completed.....	707
Premise Geographic Types Are Populated In An Unusual Way.....	707
Account And Premise Usage Are Controlled By The Campaign.....	708
Maintaining Orders.....	708
Lifecycle of an Order.....	708
Order User Interface Flow.....	709
Order - Main.....	710
Order - Main - Person Information.....	711
Order - Main - Service Address.....	714
Order - Main - Account Information.....	715
Order - Questions & Misc. Fields	716
Order - Log.....	719
Order - Package Confirmation.....	719
Order - Hold Dialog.....	720
Order - Cancel Dialog.....	721
Maintaining Campaigns.....	721
Lifecycle of a Campaign.....	721
Campaign - Main.....	722
Campaign - Questions and Misc. Fields.....	724
Campaign - Algorithms.....	725
Campaign - Package.....	726
Maintaining Packages.....	727
Lifecycle of a Package.....	727
Package - Main.....	727
Package - SAs To Create.....	728
Package - Questions & Misc Fields.....	729
Package - Eligibility.....	729
Package - Instructions.....	731
The Big Picture of Program Management.....	731
The Big Picture of Initiatives, Leads, and Representatives.....	732
The Big Picture of Initiatives.....	732
The Big Picture of Leads.....	737
The Big Picture of Sales Representatives.....	744
The Big Picture of Third Party Representatives.....	745
Maintaining Initiatives.....	747
Initiative Portal.....	747
How To Perform Common Initiative Functions.....	747
Maintaining Leads.....	754
My Leads.....	754
Lead Portal.....	754
How To Perform Common Lead Functions.....	755
Maintaining Sales Representatives.....	758
Sales Representatives Portal.....	758
How To Perform Common Sales Representative Functions.....	759
Maintaining Third Party Representatives.....	762
Third Party Representatives Portal.....	762
How To Perform Common Third Party Representative Functions.....	762
Rates.....	764
Calculation Rule-Based Rates.....	765
All Calculation Rule-Based Rates Share a Common Structure.....	765
Control Tables That Must Be Set Up Before Creating a Rate Schedule.....	766
Master Configuration.....	766

Defining Frequency Codes.....	767
Setting Up Bill Factors.....	767
An Overview of Bill Factors.....	768
The Structure of a Bill Factor.....	769
An Illustration of a Bill Factor and Its Characteristics.....	769
Deriving/Passing In Characteristic Values.....	771
Defining Bill Factors.....	771
Defining Bill Factor Values.....	775
Rate Schedule Execution.....	776
Understanding Calculation Groups and Rules.....	777
About Calculation Groups and Rules.....	777
Designing Calculation Groups and Rules.....	780
Analyzing Your Rates and Identifying Calculation Rules and Groups.....	780
Reusing Calculation Rules.....	781
Leveraging Eligibility Criteria to Dynamically Apply Calculation Rules.....	782
Case Study: Three Sample Rates.....	782
The Big Picture of Calculation Rule Eligibility Rules.....	785
A Rate Component is Eligible by Default.....	785
Defining Logical Eligibility Criteria.....	785
Examples of Calculation Rule Eligibility Rules.....	786
Working with Calculation Groups and Rules.....	788
Defining Calculation Groups.....	788
Searching and Maintaining Calculation Groups.....	788
Defining Calculation Line Category Types.....	790
Maintaining Calculation Line Category Types.....	790
Defining Calculation Rules.....	790
Searching and Maintaining Calculation Rules.....	794
Defining Calculation Rule Eligibility Criteria.....	795
Creating Rate Schedules.....	795
Defining Rate Schedules.....	795
Searching and Maintaining Rate Schedules.....	796
Base Package Calculation Rule Descriptions.....	797
Common Parameters.....	798
Calculation Rule Validation.....	799
Calculation Rules.....	800
Rate Check.....	819
About Rate Check.....	819
Performing a Rate Check.....	819
Viewing the Results of a Rate Check.....	820
Effective Dates and Price Proration.....	820
Types of Proration.....	820
Proration Factors.....	822
Overriding Proration Factors.....	824
Service Quantity Proration.....	824
Calculation Rule Value Proration.....	825
Bill Factor Value Proration.....	826
Example of Generating Prorated Bill Calculation Lines.....	826
Seasonal Proration.....	827
Price Changes and Interval Quantities.....	829
Setting Up Estimated Consumption for Items.....	830
Setting Up Degree Days (and Average Temperatures).....	830
United Kingdom VAT and CCL.....	830
UK VAT Overview.....	831
UK CCL Overview.....	831
UK VAT and CCL Bill Examples.....	831
Billing and UK VAT.....	833
Excess Credits and UK VAT.....	834
Setting Up The System For UK VAT and CCL.....	835
Quotes.....	839
The Big Picture Of Quotations.....	839
Basic Quotation Concepts.....	839
A Quote Shows How Bill Segments Might Look.....	839
Proposal Service Agreements Must Exist.....	840
Creating Quotes And Quote Details.....	844

Completing A Quote Creates Quote Routings (And More).....	844
Accepting / Declining Quote Details.....	845
Tinkering With Proposal SAs After Quote Generation.....	845
Closing Quotes.....	846
Alerts.....	846
Trees.....	846
Printing Quotes.....	846
Quote Routings Are Created For Each Recipient Of A Quote.....	846
Quote Route Types Control The Information Merged Onto Quotes.....	847
Technical Implementation Of Online Quote Display.....	847
Technical Implementation Of Printing Quotes In Batch.....	847
Reproducing The Quote Print Flat File.....	848
How To Reprint A Quote (For The Original Recipients or For Someone New).....	848
The Quote Extract Records.....	848
Maintaining Quotes.....	855
The Lifecycle Of A Quote And Quote Detail.....	855
Quote Lifecycle.....	855
Quote Detail Lifecycle.....	856
Quote - Main.....	856
Action Buttons On Quote Main.....	857
Quote Actions.....	857
Quote Detail Actions.....	859
Proposal SA Actions.....	859
Quote - Quote Details.....	859
Quote - Quote Routings.....	860
Service Credits.....	862
The Big Picture Of Service Credit Membership.....	862
Who are the Members?.....	862
Joint Membership.....	863
Changing the Membership Accounts.....	863
Membership Application.....	863
Creation of a Membership.....	864
Membership Fees.....	864
Stopping a Membership vs. Inactivating a Membership.....	864
The Big Picture of SC Events.....	865
Event Amounts May Contribute to a Balance.....	865
Events May Indicate a Fiscal Year.....	866
Events May Indicate a Subcategory.....	866
An Event May Cause Other Actions to Occur.....	866
Financial Transactions for an Event.....	867
How Events Are Created.....	867
Events Created by an Algorithm.....	867
Events Created as a Result of a Background Process.....	868
Creating Pending Events.....	868
Events May Be Transferred.....	868
CPCRALOC - Allocating Capital Credits.....	868
CPCRRETR - Capital Credit Retirement.....	870
Maintaining Service Credit Memberships and Their Events.....	871
Service Credit Membership.....	871
Lifecycle of a Membership.....	871
Service Credit Membership - Main.....	872
Service Credit Membership - Account.....	873
Service Credit Membership - Characteristics.....	873
Service Credit Membership - Membership Tree.....	873
Maintaining Service Credit Events.....	874
Lifecycle of a Service Credit Event.....	874
Service Credit Event - Main.....	874
Loans.....	876
The Big Picture Of Loans.....	876
Loans Are Service Agreements.....	876
Loan Interest Charges.....	876
Loan Amortization Schedules.....	877
Negative Amortization.....	877
Loan Overpayments.....	878

The Lifecycle Of A Loan.....	878
Finalizing And Closing A Loan.....	878
Navigating To The Loan Maintenance Page.....	878
Loan Maintenance.....	879
How To.....	881
How To Start A Loan Service Agreement.....	881
How To Modify The Terms Of A Loan.....	882
How To Adjust Loans.....	882
How To Stop A Loan Service Agreement.....	882
Non-Billed Budgets.....	883
The Big Picture Of Non-Billed Budgets.....	884
Non-Billed Budget Service Agreements.....	884
Which SAs Are Covered By A Non-Billed Budget?.....	884
Non-Billed Budgets Versus Other Plans For Payment.....	884
There Are Two Types Of Non-Billed Budgets.....	885
Navigating To The Non-Billed Budget Maintenance Page.....	885
Recommending Scheduled Payments.....	886
Maintaining Non-Billed Budgets.....	886
Non-Billed Budget - Main.....	886
Non-Billed Budget - History.....	887
How To.....	888
How To Start A Non-Billed Budget Service Agreement.....	888
How To Cancel / Stop Non-Billed Budget SAs.....	888
How To Renew Non-Billed Budgets.....	889
How To Set Up Automatic Payment For A Non-Billed Budget.....	889
Case Management.....	889
Background Topics.....	890
Case Type.....	890
Creating Cases.....	890
Log Information.....	890
Alerts.....	891
To Do's and Cases.....	891
Reports.....	891
Maintaining Cases.....	891
Case - Main.....	891
Case - Log.....	893
Premise Management.....	894
Overview.....	895
Define Premise Hierarchy.....	895
Manage Premises for a Landlord.....	895
Manage Groups of Premises.....	895
Premise Management Page.....	896
Start Service.....	898
Stop Service.....	899
Assign Parent Premise.....	899
Remove Parent Premise.....	900
Assign Landlord.....	900
Remove Landlord.....	900
Umbrella Agreement Management.....	900
Overview Of Umbrella Agreement & Terms Of Service.....	901
TOS Covered Entities.....	901
Rate Terms Overridden By Terms Of Service.....	901
Rate Schedule Override by TOS.....	902
Override Of Other Rate Terms By TOS.....	902
Umbrella Agreement Renewal.....	902
Umbrella Agreement Renewal Background Process.....	903
Umbrella Agreements & Proposals.....	903
Additional Umbrella Agreement Topics.....	903
Umbrella Agreement Alerts.....	903
Orders And Umbrella Agreements.....	903
Umbrella Agreement Reports.....	903
Umbrella Agreement Maintenance.....	904
Lifecycle Of An Umbrella Agreement.....	904
Umbrella Agreement - Main.....	904

Umbrella Agreement - Contacts.....	905
Umbrella Agreement - Characteristics.....	905
Terms Of Service Maintenance.....	905
Lifecycle Of Terms Of Service.....	906
Terms Of Service - Main.....	906
Terms Of Service - SAs.....	907
Overdue Financial Obligations.....	908
Overdue Processing Background Information.....	908
Overdue Process Maintenance.....	909
Overdue Process - Main.....	909
Overdue Process - Events.....	910
Overdue Process - Log.....	911
How To Perform Common Overdue Process Functions.....	912
How To Create An Overdue Process.....	912
How To Change Overdue Events.....	912
How To Cancel An Overdue Process.....	913
Cut Process Maintenance.....	913
Cut Process - Main.....	913
Cut Process - Events.....	915
How To Perform Common Cut Process Functions.....	916
How To Create A Cut Process.....	916
How To Change Cut Events.....	916
How To Cancel A Cut Process.....	917
Payment Arrangement for Bills.....	917
How To Set Up A Payment Arrangement.....	919
How To Add Additional Debt To A Payment Arrangement.....	919
How To Break A Payment Arrangement.....	919
How To Cancel A Payment Arrangement.....	920
Rebate Claims.....	920
Rebate Claim Query Portal.....	920
Rebate Claim Portal.....	921
Rebate Claim Zone.....	921
Rebate Claim Status.....	922
Rebate Claim Actions.....	922
Editing Rebate Claims.....	923
Verifying Rebate Claims.....	923
Approving Rebate Claims.....	923
Rejecting Rebate Claims.....	923
Noting Issues Related to a Rebate Claim.....	923
Canceling Rebate Claims.....	924
Adding Rebate Claims.....	924
Rebate Claim Line Zone.....	924
Adding Rebate Claim Lines.....	924
Deleting Rebate Claim Lines.....	925
Editing Rebate Claim Lines.....	925
Verifying Rebate Claim Lines.....	925
Rebate Claim Log Zone.....	926
Adding Rebate Claim Log Entries.....	926
Communications.....	926
Device Events.....	926
About Device Events.....	926
Processing Device Events.....	927
Activities.....	930
About Activities.....	930
Maintaining Activities.....	930
Communications.....	931
About Communication Out.....	931
About Communication In.....	932
Maintaining Communications.....	932
Completion Events.....	932
About Completion Events.....	932
Maintaining Completion Events.....	933
NotificationSuppressions.....	933
About Device Event Notification Suppressions.....	933

Maintaining Notification Suppressions.....	933
Integrations.....	933
Business Flags.....	934
About Business Flags.....	934
Maintaining Business Flags.....	934
Oracle Utilities Analytics Insights.....	934
Using the Meter Insights Investigation Viewer.....	934
Aggregations.....	936
Standard Aggregations.....	936
About Aggregations.....	936
Creating Aggregators.....	940
Base Product Aggregators.....	941
Maintaining Aggregations.....	941
Dynamic Aggregation.....	942
Dynamic Aggregation Overview.....	942
Understanding Dynamic Aggregation Execution.....	942
Dynamic Aggregation Processing.....	944
Types of Aggregations.....	949
Aggregation Measuring Components.....	952
About Aggregation Measuring Components.....	952
Maintaining Aggregation Measuring Components.....	952
Master Data Sync.....	953
Outage Storm Mode.....	953
About Outage Storm Mode.....	953
Reviewing Widespread Outages.....	955
Dashboards.....	955
About Dashboards.....	956
Using the Customer Operational Dashboard.....	956
Using the Meter Operational Dashboard.....	956
Using the Batch Performance Tab.....	957
Using the Meter Health Check Tab.....	957
Using the Service Order Operational Dashboard.....	960
Using the Service Order Trends Dashboard.....	961
Totals and Trends.....	961
Processing Statistics.....	961
About Processing Statistics.....	961
About Head-End System Processing Statistics.....	962
Consumption Statistics.....	962
Time Zone Support.....	962
Daylight Savings Time Support.....	962
Multiple Time Zone Support.....	964
Service Issue Monitors.....	967
About Service Issue Monitors.....	967
About Service Investigative Orders.....	968
Oracle Utilities Rate Cloud Service.....	968
Overview.....	968
Setting Up Rates with Oracle Utilities Rate Cloud Service.....	968
Using Rate Check with Oracle Utilities Rate Cloud Service.....	969
Oracle Utilities Billing Cloud Service.....	969
Overview.....	969
Billing Cloud Service Functional Areas.....	969
Settlement.....	970
Understanding Market Settlement.....	970
About Market Settlement Processing.....	971
Importing Data.....	971
Forecasting and Estimating Usage.....	971
Aggregating Data.....	972
Unaccounted for Energy (UFE) Calculations.....	973
Allocating Load via Market Products, Awards, and Contracts.....	974
Viewing Settlement Calculation Results.....	976
Viewing and Managing Settlement Processes.....	976
Settlement Data Snapshots.....	976
Attribute Values.....	976
About Attribute Values.....	976

Maintaining Attribute Values.....	977
Attribute Data Snapshots.....	977
About Attribute Data Snapshots.....	977
Maintaining Attribute Data Snapshots.....	978
Measurement Data Snapshots.....	978
About Measurement Data Snapshots.....	978
Maintaining Measurement Data Snapshots.....	982
Initial Measurement Snapshots.....	982
About Initial Measurement Snapshots.....	982
Maintaining Initial Measurement Snapshots.....	983
Interval Snapshot Mapping.....	983
About Interval Snapshot Mapping.....	984
Maintaining Interval Snapshot Mapping.....	984
Settlement Calculations.....	984
About Settlement Calculations.....	984
Settlement Subscriptions.....	986
About Settlement Subscriptions.....	986
Maintaining Settlement Subscriptions.....	986
Settlement Transactions.....	987
About Settlement Transactions.....	987
Settlement Transaction Communication.....	988
Maintaining Settlement Transactions.....	990
Settlement Items.....	991
About Settlement Items.....	991
Maintaining Settlement Items.....	991
Settlement Item Quantities.....	992
About Settlement Item Quantities.....	992
Maintaining Settlement Item Quantities.....	992
Settlement Billed Usage.....	992
About Settlement Billed Usage.....	993
Maintaining Settlement Billed Usage.....	993
Settlement Item Market Participants.....	993
About Settlement Item Market Participants.....	993
Maintaining Settlement Item Market Participants.....	994
Market Allocations.....	994
Market Contracts.....	994
About Market Contracts.....	994
Maintaining Market Contracts.....	994
Market Awards.....	995
About Market Awards.....	995
Maintaining Market Awards.....	995
Maintaining Market Allocations.....	995
Market Products.....	996
About Market Products.....	996
Maintaining Market Products.....	996
Data Access Restrictions.....	997
Using Data Access Restrictions.....	997
To Do Processing.....	998
Understanding To Do Processing.....	998
To Do Role.....	998
To Do Priority.....	998
Work Distribution.....	999
A User's Current To Do.....	1000
To Do Characteristics.....	1000
Related To Do Entries.....	1001
Complete A To Do.....	1001
Log Entry Events.....	1001
Managing To Do Entries.....	1002
To Do Management.....	1003
To Do Supervisor Functions.....	1005
Supervisor To Do Summary.....	1005
Supervisor User Summary.....	1006
Supervisor To Do Assignment.....	1006
To Do List Functions.....	1007

To Do Summary.....	1007
To Do List.....	1008
To Do Entry.....	1010
Adding a Manual To Do Entry.....	1011
To Do Search.....	1011
To Do Dashboard.....	1013
Reports.....	1016
About Reports.....	1016
Running Oracle Utilities Meter Data Management Reports.....	1017

Chapter 1

Business User Guide

Customer to Meter Overview

Oracle Utilities Customer to Meter is a next generation customer service and billing application that incorporates a modern meter data management system. This system is designed to scale with mass smart meter volumes while handling the complexity associated with a utility’s processes across multiple types of service, operating divisions, and jurisdictions. The new application components allow for traditional scalar meter functionality that is equivalent to prior versions of Oracle Utilities Customer Care and Billing; so, it can accommodate the many types of utility environments, and evolve with the business to include more advanced digital requirements.

The roles for each application area in Oracle Utilities Customer to Meter are defined as follows:

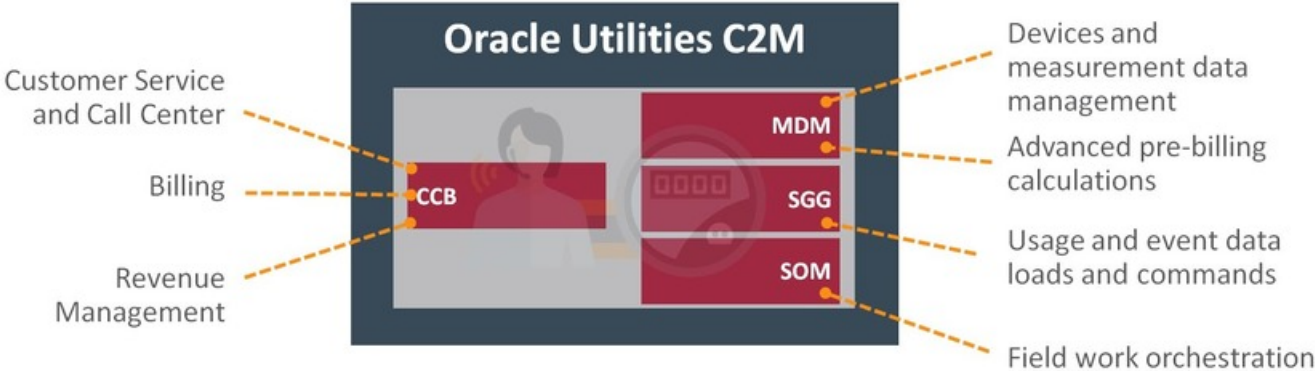

The application components have internal integration for master, admin, and transactional data. The primary transactions between them are for bill determinant processing with MDM and service order processing with SOM. These transactional processes can be initiated by the CCB solution, or from other external systems.

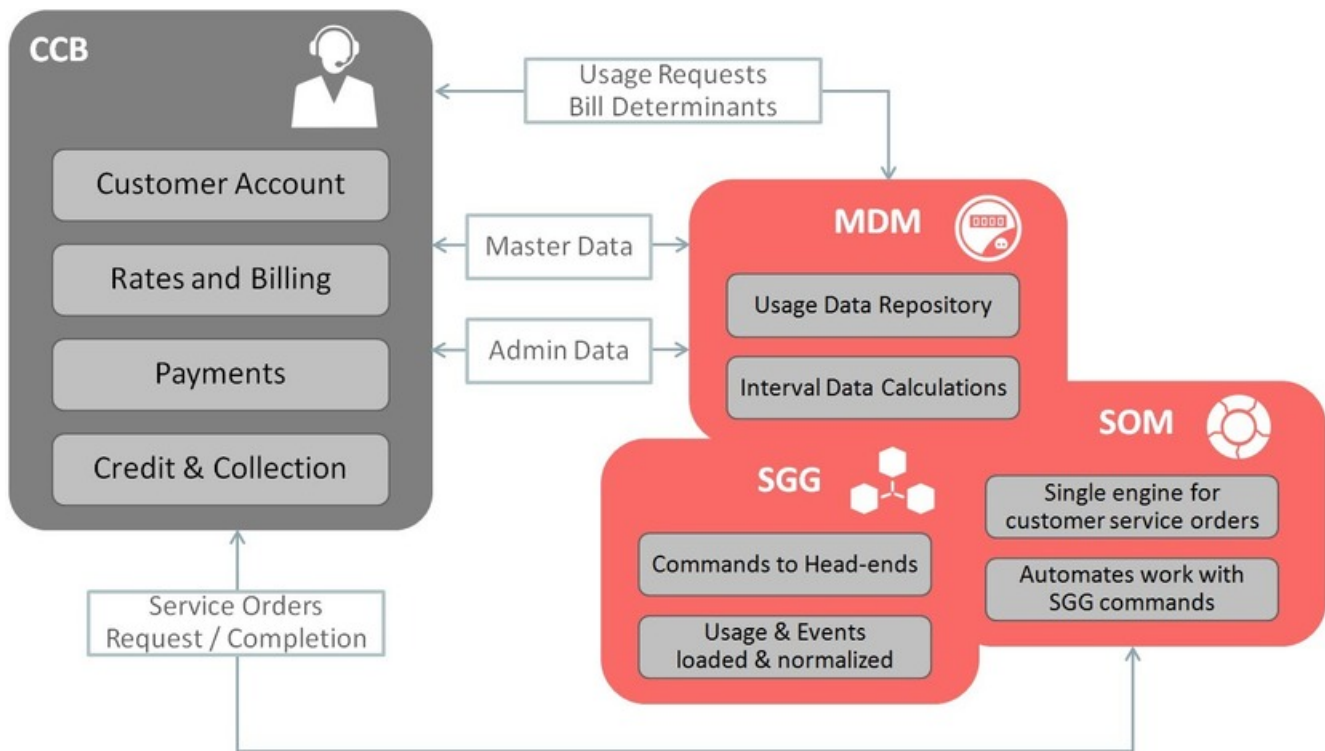

In addition, Oracle Utilities Customer To Meter can also include asset management functionality via Oracle Utilities Operational Device Management which provides the ability to handle large volumes of assets and to manage the receipt, installation, maintenance, tracking and removal of those assets.

Oracle Utilities Customer Care and Billing Overview

Oracle Utilities Customer Care and Billing (CCB) manages customer information and processes associated with the customer lifecycle including:

- Sales and marketing, and program management.
- Customer information for residential, commercial, and industrial customers; including, complex premise management, umbrella agreements, and quotations proposals.
- Starting and stopping service; including, order entry for eligible products and services.
- Customer care interactions for inbound communications (such as phone calls), outbound communications (such as letters or notifications), and case management (configurable customer processes).
- Advanced rating rules.
- Financial management for billing, budget plans, deposits, loans, and payment processing (including cashiering portals).
- Credit and collection for overdue receivables management.

Oracle Utilities Customer Care and Billing acts as a detailed sub ledger for accounts receivables with the ability to send results to a general ledger. It also provides a Control Central portal that increases productivity by providing a comprehensive view of the customer and their related account information so that most questions can be quickly answered without having to navigate through the system.

Oracle Utilities Meter Data Management Overview

Oracle Utilities Meter Data Management (MDM) acts as a consolidated usage measurement data repository with advanced validation, editing, and estimation (VEE) rules. These rules ensure accuracy and measurement compliance that is associated with advanced metering infrastructure (AMI), traditional one-way meters, and a rich usage calculation rules engine.

The following lists the most crucial business processes that are enabled within this system:

- Defining devices; such as, meters at customer locations, device configurations for measurement collection and command execution, customer service points, and effective device installations.
- Loading scalar readings, interval data, and events data from a Head End system or other source.
- Automatic validating, editing, and estimating (VEE) measurement data
- Robust editing capabilities for scalar readings and interval measurement data
- Calculating and publishing bill determinants and other transactions from measurement data. This data is then used in external systems; such as, billing, and pricing. It can also be applied to aggregation for settlement, load research, forecasting, and revenue management.
- Service Issue Monitor configurable process to identify and correct devices that may have operating issues.

The system has a 360 Degree View device portal that provides advanced navigation and operational analytics to improve operational efficiency. It is designed for handling large volumes of meter/device data to enable increased accuracy, flexibility, and scalability.

Oracle Utilities Smart Grid Gateway Overview

Oracle Utilities Smart Grid Gateway (SGG) is designed as a messaging broker to communicate with meters and other devices using a common interface. This allows the system to hide much of the background complexity that can occur when multiple head end or meter data collection systems are used.

SGG functionality covers the following types of standardized processing.

- Loading usage and event data records that are collected on a frequent basis.
- Providing normalized raw data to other applications that require information with the ability to filter based on requirements.
- Standardizing command and control use cases; such as, turning a meter device on or off, checking the current status of a device, and requesting a measurement on-demand via electronic messages to the corresponding head end system.
- Centralizing command and data exceptions with the ability to automate retry processing.

SGG delivers pre-built adapters that support integrations to leading metering technology vendors. It also provides an Adapter Development Kit (ADK) to easily integrate with other sources. The system can provide a single auditable link to devices across all systems, simplify integrating with other utilities applications, and allowing normalized protocols and data types. The platform can expand to allow other types of device and customer communications, beyond meters; or other types of distribution and network devices that are upstream from the metering technology.

Oracle Utilities Service Order Management Overview

Oracle Utilities Service Order Management (SOM) delivers a new approach to handling the most common customer service order use cases for smart metering technology and traditional metering. Rather than generating specific field activity tasks, Oracle Utilities CCB triggers field activity requests that are based on the classic customer scenarios: start service, stop

service, disconnect for non-payment, reconnect service, etc.. Oracle Utilities SOM receives these requests and determines whether the installed device technology can support electronic commands (sending messages via Oracle Utilities SGG), or not (meaning that a field visit is required to complete necessary tasks). Some situations may also require both automated and manual activities to occur, and in a specific sequence; such as, first replacing an old meter with a smart meter through a field visit, then sending a series of Oracle Utilities SGG messages to the new meter.

Oracle Utilities SOM continually monitors and initiates activities to get the service point, device, and completion fully processed; this includes obtaining supporting data, such as measurements needed for billing, in a manner that is appropriate for the associated meter's technology. As more smart devices are installed in the field, Oracle Utilities SOM provides increased savings by reducing field visits, and using more electronic messaging that take care of logic and error handling.

In addition to being initiated by the customer system, service order requests can also be initiated by other systems; for example,

- Oracle Utilities Meter Data Management might detect service issue through its monitoring processes
- Oracle DataRaker's advanced analytics might detect patterns with the meter, device, or customer behavior.
- Oracle Utilities Operational Device Management (ODM) might trigger operational processes; such as, periodic device testing or configuration parameter updates.

It is critical for customer service business processes to see all types of requests that are initiated by other systems and their current execution status. SOM assumes that a mobile workforce system is in use. These systems provide several important functions: they remove the need for printed service orders, handle the assignment and scheduling of work to crews, and provide appointment booking services.

Oracle Utilities Operational Device Management Overview

Oracle Utilities Operational Device Management provides functionality to handle large volumes of assets and to manage the receipt, installation, maintenance, tracking and removal of those assets.

The system supports the following business processes:

- Capturing device attributes and supporting any type of device
- Supporting integration with other utility applications requiring device information and configuration
- Supporting detailed smart device attributes
- Supporting detailed location management and tracking of individual devices throughout their lifecycle
- Capturing device configurations and settings
- Managing configuration between devices, components and software
- Tracking firmware and firmware versions on smart devices

Oracle Utilities Market Settlements Management Overview

Oracle Utilities Market Settlements Management (MSM) provides the core functionality for calculating and settling energy changes, also referred known as load settlement,

Market settlement is the process of reconciling the difference between a supplier's energy purchases and its customer's usage. Suppliers purchase energy via bilateral contracts and day-ahead market transactions. Any differences between these purchases and supplier customer usage must be determined by the market and charged or credited at real time prices. The supplier's customer usage is not directly determined by the market, but by numerous other market participants that track customer supplier enrollments, aggregate customer usage to the supplier, and submit supplier's usage schedule to the market.

Load settlement starts with the bottom up aggregation of actual load or estimated load for individual customer accounts or service points. Distribution and transmission losses are added in to calculate an unreconciled load amount. The market determines the total generation supplied to a zone and the difference with the unreconciled load is referred to as Unaccounted for Energy (UFE). The UFE is then allocated to suppliers on a load ratio share basis.

The load settlement process is typically performed multiple times. The “preliminary” load settlement is done soon after the Operational Day and is often based on estimated load. The “final” load settlement is done around 60 days after the Operational Day, so that actual data has been received and customer bills issued.

The market participant responsible for load settlement can differ per market. For example, load settlement for a large portion of the Texas market is performed by an Independent System Operator (ISO) known as the Electric Reliability Council of Texas (ERCOT), whereas in the PJM market (encompassing Pennsylvania, New Jersey, and Maryland) load settlement is the responsibility of the Electric Distribution Company (EDC). While there are significant differences between markets in how load settlement is preformed, the high-level process steps are basically the same.

User Interface Standard Features

This section describes basic system concepts, features, and standards of the user interface.

Page Components

Oracle Utilities Application Framework screens are comprised of the following main areas:

1. The Application Toolbar
2. The Page Title Area
3. The Object Display Area
4. The Dashboard Area

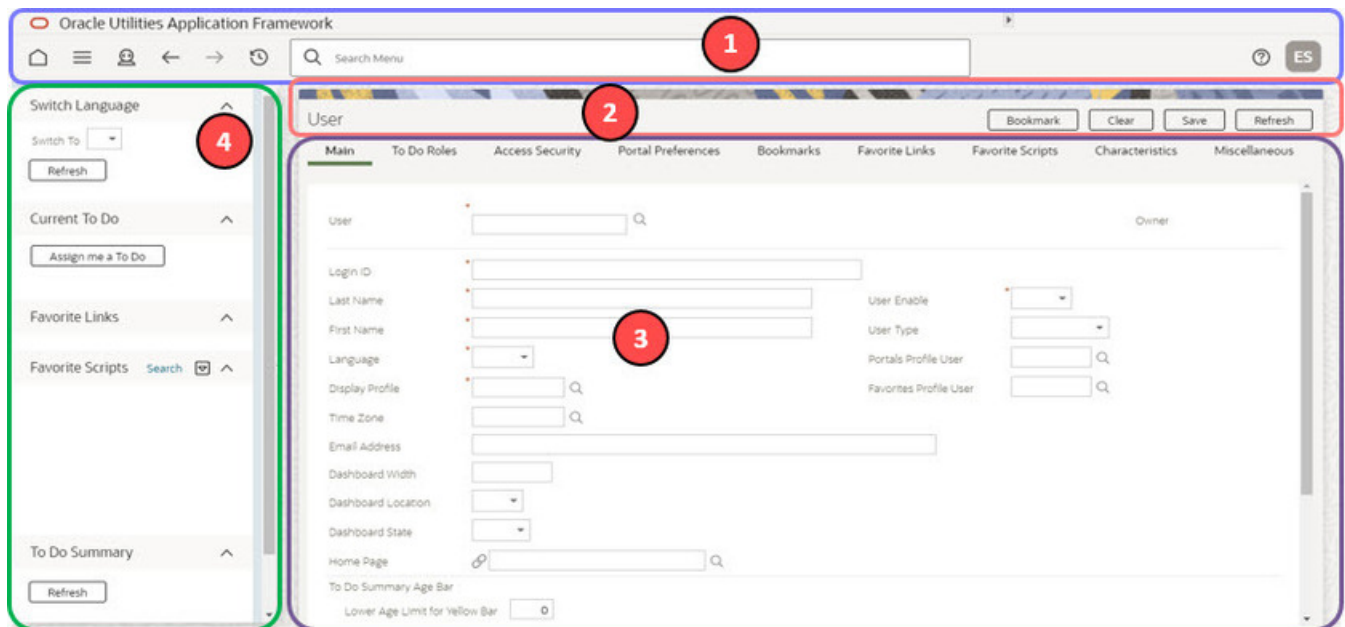

Keyboard Shortcuts	Description
Alt+[Moves the cursor focus to the next main page component based on the standard browser keyboard navigation "order".

Keyboard Shortcuts**Description**

Shift+Alt+[

Moves the cursor focus to the previous main page component based on the standard browser keyboard navigation "order".

NOTE: The look and feel of the application may be modified after the product is installed. See [Custom Look and Feel Options](#) for customization information, including how to change colors, fonts, and other system features. The information provided in this document represents features and functionality available only in the delivered product.

The next topics provide more information about each component and the Script area, which appears in the Object Display area when applicable.

The Application Toolbar

This section describes the features available on the application toolbar.

Home Icon



Click the **Home** icon, , on the Application Toolbar to open your home page. Your home page is defined in [User Preferences](#).

Keyboard Shortcut**Alternate Shortcut**

Alt+O

Alt+Shift+O

NOTE: Refer to [Shortcut Key Summary](#) for information about the alternate shortcut.

Menu



The Menu icon, , is available in the application toolbar to help you navigate to the different pages of the system. You only see the menu items that you have security access for.

Keyboard ShortcutCtrl+Alt+M

The menu list is organized by functional area. Clicking the Menu button displays each functional area. Clicking a functional area, in turn, displays a submenu that contains pages within that area.

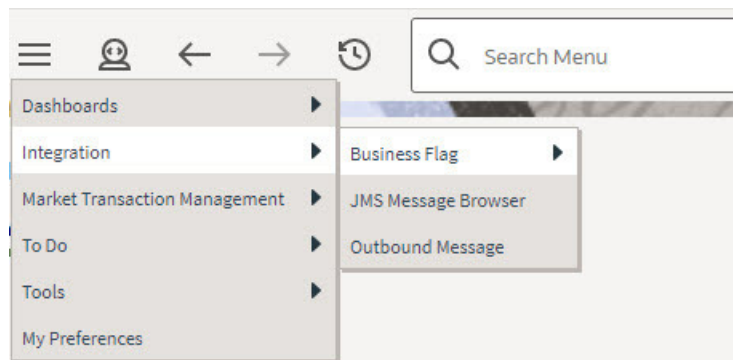

The pages within each functional area *typically* have two options: Search and Add. If the menu item does not have an Add or Search option, select the menu item itself.

How the Search and Add option behaves depends upon whether the maintenance page is fixed or portal-based.

Fixed:

- **Search:** Displays a pop-up search window for the user to enter the search criteria and select the entity to display. Once the entity is selected, the user is taken to the maintenance map with the data populated in the fields.
- **Add:** Displays the maintenance page with empty fields so that the user can complete the information and save the entity.

Portal-Based:

- **Search:** Displays a search portal where the user can enter the search criteria and select the desired entity. Once the entity is selected, the user is typically taken to a maintenance portal or the information is broadcast to other zones within the same portal.
- **Add:** Either navigates to a page where the user can select the entity type or business object, or directly to the input map where the user can enter and save the entity.

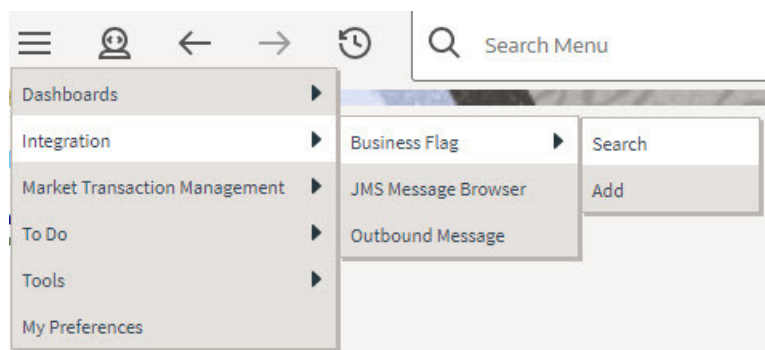

Users may also opt to use [Menu Item Search](#) to find a page.

Admin Menu



The Admin menu icon, , is available in the application toolbar to help you navigate to the different pages of the system. You only see the menu items that you have security access for. If you don't have security access to any of the entries in this menu, then the whole menu is suppressed.

Keyboard Shortcut

Ctrl+Alt+A

Depending on how your implementation has configured the Admin menu list, it may be organized either by functional area or alphabetically.

Clicking the Admin icon displays each functional area or alphabetical list. Clicking one of the options, in turn, displays a submenu that contains pages within that area. The following is an example of the Admin menu organized functionally.

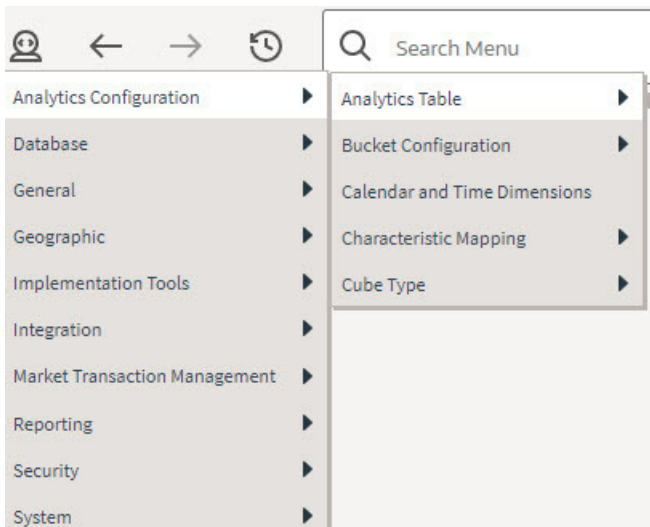

NOTE: Menu navigation paths referenced in the administrative user guide provide the functional grouping. If your implementation uses the alphabetic grouping, the page can be found in the alphabetic letter that is the first letter of the page name.

NOTE: Refer to [Installation Options](#) for information about the admin menu configuration options.

The menu lines displayed for each menu entry *typically* have two options: Search and Add. If the menu item does not have an Add or Search option, select the menu item itself. See [Menu](#) for more information about these options.

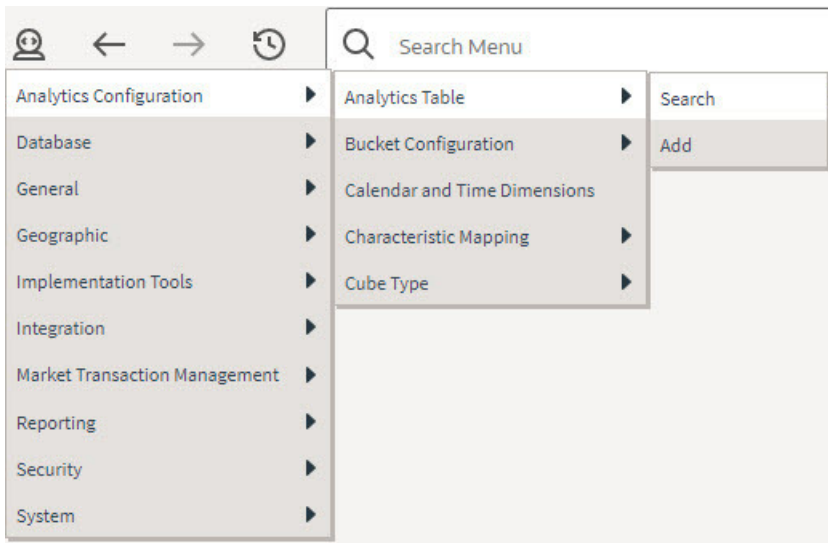

Users may also opt to use the [Menu Item Search](#) to find a page.

Back and Forward Arrows



The back and forward arrows, , in the application toolbar allow you to navigate between the most recently viewed pages.

Back

Click the **Back** arrow to open the previously visited page.

Keyboard Shortcut

Alt+B

Forward

Click the **Forward** arrow to return to the page that was most recently dismissed.

Keyboard Shortcut

Alt+G

The **back** and **forward** arrows are enabled in the toolbar only when page use warrants their appearance.

NOTE: Under certain circumstances, such as revisiting a page that was left unsaved after being loaded with default data, a page may not appear as it did when you left it.

History Icon

Click the **History** icon, , to display a list of previously visited pages. When you click on an entry in the list to return to an earlier page, all items above the selected page are removed from the list.

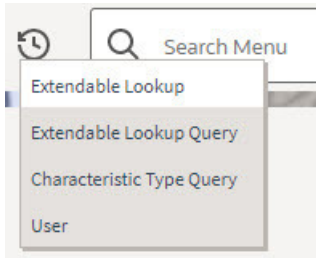

The **back** and **forward** arrows, as well as the **History** list, appear in the application toolbar only when page use warrants their appearance.

Note that if the page has been configured to display an information string in the [page title area](#), that information will also be visible in the History dropdown.

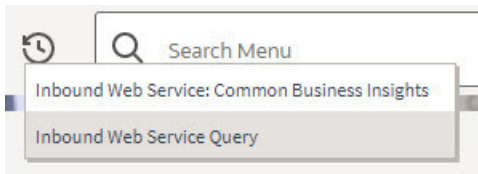

Keyboard Shortcut

Ctrl+Alt+H

Search

The toolbar Search field and search icon provide the ability to search for specific menu items or, depending on your product, certain business entities.

Menu Item Search

This search allows a user to enter the description of a menu item entry to navigate directly to the corresponding page or BPA script rather than using the menus to navigate to the desired page or script. Enter your search text starting with a slash "/" to indicate that the search is confined to menu items.

Keyboard shortcut:

Keyboard Shortcut

Ctrl+Alt+F



Typing text in the field shows menu items whose descriptions include the typed text.

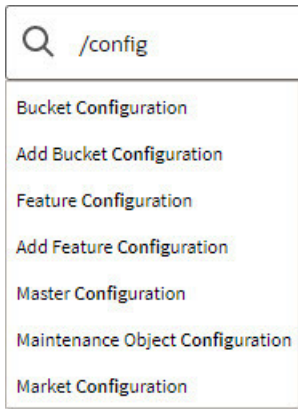

Q /config

- Bucket Configuration
- Add Bucket Configuration
- Feature Configuration
- Add Feature Configuration
- Master Configuration
- Maintenance Object Configuration
- Market Configuration

Note that only menu items within the [Menu](#) and [Admin Menu](#) that the user has security access for are included in the results. The text included in the search is taken from the menu item description. As described in [Menu](#), menu lines often have two sub item: Search and Add. In most instances, the description of the "Search" menu item is simply the menu entry text, for example **To Do Entry**. The description of the "Add" menu entry includes the word Add in front of the menu entry text, for example **Add To Do Entry**.

As mentioned in [Menu Item Suppression](#), menu items will not appear if it is associated with a module that is suppressed.

NOTE: When operating in debug mode, the description of the parent menu is displayed in parentheses after the menu item description.

Unified Search

If your product has implemented unified search, you may use the toolbar search box to search for business entities. The unified search feature is a simplified version of your product's main search that allows you to lookup up records using free form text without leaving your current page. For more complex queries, use the link provided as part of the search box to navigate to your product's advanced search portal.









The type of business entities you may query and the filters you may use depend on the specific unified search implementation of your product. For example, if your product supports a search for customers based on their name or address, you may type in part of a name or an address to find matching results. If a unified search option is not configured for your product or you do not have security access to use it then the search box may only be used for searching for menu items.

To search for business entities, you may enter your search criteria in the following ways:

- Type in your search text in **free form**. For example, if your product's unified search option supports a search for customers by name or address, the text you enter may be considered as part of a name or an address.
- Depending on your product's unified search configuration, you may use specific **hints** to explicitly identify your filtering criteria. For example, an address filter may be associated with the hint name "ad:" allowing you to be more explicit and enter "ad: main" to find records by their address. Click the search icon in the search input area to view the hints that are configured for this search. You can also click the up arrow adjacent to the hint to automatically populate the hint text into the search.

Hints

-  / Search Menu
-  **n:** Name
-  **ad:** Address
-  **ac:** Account ID
-  **id:** ID Number
-  **c:** Contact Info

- You may use free form text or hints but not both.

As you type in your text, the application attempts to find matching records and presents the top most results for your review. You may select a record from the results list to navigate to the corresponding portal.

If your product has configured more than one unified search that you are allowed to use, one of the searches is the default search. Click the search icon in the search input area to choose a different search option. After selecting a different option, the hints for the selected search are shown and the Advanced Search link will navigate to the query portal configured for the selected search.

Other Searches

Meter Unified Search

Asset Unified Search

Control Central Unified Search

Asset Location Unified Search

Refer to your specific product documentation for more information about your product's unified search features.

Refer to [Understanding Unified Search](#) to better understand unified search configuration.

Help Menu

The Help menu is available in the application toolbar to provide access to the following product support options. Open the

menu by clicking the Help icon



Help

Select the **Help** entry in the menu to launch the Oracle Help Center in a new tab. The application will automatically navigate to the context-sensitive help information within the help center. Alternatively, use the following shortcut key to launch help directly.

Keyboard shortcut:

Keyboard Shortcut

Alt+F1

Prepare Issue Details

Select the **Prepare Issue Details** entry in the menu to launch a script to capture details of an error that needs to be reported. Refer to [Prepare Issue Details](#) for more information on this option.

Enable | Disable Debug

If you have security access to the application service **F1OUDBUG**, you will see an option in the menu related to [debug mode](#) depending on its current state. If debug mode is currently not enabled, the entry says Enable Debug, otherwise it says Disable Debug.

About

Select the **About** entry in the menu to display a window that describes the current release information for your version of your product.

The about window shows a variety of information including:

- The logged in user ID
- The list of products installed in the application along with the release ID. This information comes from the [installation record](#). Note that in a Cloud installation, only the Cloud product name and release ID are displayed. The details of the products that make up the Cloud installation are not displayed (but are still visible on the installation record).

User Menu

The User menu is available in the application toolbar to provide access to user-specific options. Open the menu by clicking



the User icon .

NOTE: Configurable Menu. Additional menu entries may be visible in your implementation as this menu configuration allows for additional options to be defined.

Preferences

Select the **Preferences** entry in the menu to view or modify your settings in a form that appears in the **Main** tab in the object display area. Alternatively, use the following shortcut key to access preferences directly.

Keyboard Shortcut

Ctrl+Alt+P

Refer to [User Preferences](#) for more information.

Switch UI View

Select the **Switch UI View** entry in the menu to change the user experience from the current system default to the prior user experience or from the prior user experience to the current version. This option is only available for users that have access to the **F1UIVIEW** application service.

Logout

Select the **Logout** entry in the menu to complete your current session of the application. Clicking this item logs the current user out and displays the Welcome page so that another user can login. Alternatively, use the following shortcut key to logout.

Keyboard Shortcut

Ctrl+Alt+L

Page Title Area

The Page Title Area displays the page title and the page actions toolbar.

For certain pages in the system, the page title may be followed by an information string. It is only applicable to portal-based pages that display a single record. This information is only visible if the portal has been configured to display the primary key's information string. Typically only "stand alone" maintenance portals are configured to show the information string, whereas "all-in-one" portals are not configured this way.

FASTPATH: Refer to [Common Base Portals and Zones](#) for more information about standard base product portals.

NOTE: If an information string is long and would interfere with a page actions button, the information string will automatically be truncated and suffixed by an ellipsis, "...", indicating that more information is available. In this situation, the missing text can be viewed if the user hovers their mouse over the string.

The Page Actions Toolbar displays standard control options, such as Save and Duplicate. More detail about the actions that may appear are described in the following section.

Page Actions Toolbar

In the Page Title Area, control functions appear in the Page Actions Toolbar; such as, Clear, Save, Duplicate, Delete and Refresh buttons.

NOTE:

Buttons in the Page Title Area appear as the function is available to the user; for example, the Delete button will not appear if the user has made any changes to the page's content, or does not have the necessary security rights for this action.

In addition, other functions that are specific to a portal-based page may appear in the toolbar, if configured. For example, the ability to navigate to the Search zone for a specific maintenance object may be visible on the maintenance portal.

This section describes the standard features that are available in the Page Actions Toolbar.

Bookmark Button

Click the Bookmark button on the Page Actions Toolbar to save the current page and context to the bookmarks list.

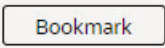

Bookmark

Keyboard Shortcut

Ctrl+Alt+B

NOTE: Secured. This button is secured using the application service **F1-BOOKMARKS**. Users that do not have security for the application service will not see the Bookmark button (or the corresponding dashboard zone).

After clicking the Bookmark button, you are prompted to provide a name for the bookmark. After saving, it is visible in the [Bookmarks Zone](#), allowing you to return to this page with this context loaded with one click.

NOTE: Unsaved data will not be included in the bookmark. If you view a record and make changes to data without saving the changes and then bookmark the page, the unsaved changes are not included in the bookmark information.

You may change the name of the bookmark or change the sequence of the bookmarks by navigating to the [User - Bookmarks](#) in the user preferences.

Next/Previous Item Buttons

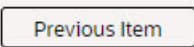

Previous Item

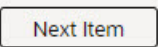

Next Item

The **Previous Item** and **Next Item** buttons appear in the Page Actions Toolbar under these conditions:

- You access a fixed page, meaning that it is not portal-based.
- You use a search page to display an item.
- There are multiple items in the search results list *below* or *above* the selected item.

If, for example, you enter search criteria of "Smith" on the User Search page, you might see the following results:

- Smith, Albert
- Smith, Peter
- Smith, Zane

If you select **Smith, Peter**, Peter's user information is displayed on the User page. If you then click the **Next Item** button, **Smith, Zane** will be displayed. In addition, because **Smith, Zane** is the last entry in the search results, the **Next Item** button is no longer needed and will not appear in the Page Actions Toolbar.

If you then click the **Previous Item** button, **Smith, Peter** will be displayed; click again and the **Smith, Albert** record will appear, and, because **Smith, Albert** is the first entry in the search results, the **Previous Item** button is no longer needed and will not appear in the Page Actions Toolbar.

Keyboard Shortcut

Alt+P

Alt+N

Alternate Shortcut

Alt+Shift+N

NOTE: Refer to [Shortcut Key Summary](#) for information about the alternate shortcut.

Duplicate Button

Click the **Duplicate** button in the Page Actions Toolbar to create a duplicate of the currently selected object.



Before the new object is added to the database, a dialog appears in which you must enter the unique identifier for the duplicate object. When you click OK, the system creates the record by copying the original record. It may be helpful to think of the duplication function as the equivalent of a "save as" action.

Keyboard Shortcut

Ctrl+Alt+D

NOTE: Copying ancillary information for a record sometimes requires confirmation during a duplication request. If so, you may also be asked if you also want to duplicate ancillary information. If, for example, you duplicate a user group, besides supplying the ID of the new user group, you are asked if all users in the original user group should be linked to the new user group.

This button does not appear in the Page Actions Toolbar when:

- Duplication is not supported for the current object.
- You are on a portal based page. (For these types of pages, if duplication is supported, the actions are defined in a zone on the portal.)
- You have made changes to the object without committing the changes to the database by clicking Save. (After making changes, you must either discard them using the **Refresh** button, or save them.)

Delete Button

Not all transactions have the capability to be deleted. Deletion is related to the business impact of the action. In some transactions, Delete is present for some scenarios and unavailable for others; for example, you may not be able to delete a record at a certain status level.

NOTE:

If you make a change to an object and do not save the changes to the database, you cannot delete the object until you either save the changes or refresh the object with the contents on the database.

Before you delete an object, the system verifies that the object is not referenced anywhere in the system. If it is, you cannot delete it. If, for example, you attempt to delete a user, the system ensures this user has not been referenced in a user group or on a To Do.

Depending on the type of page that you are using, the option to delete may vary.

- Fixed pages display a Delete button in the page actions toolbar when the option is available.

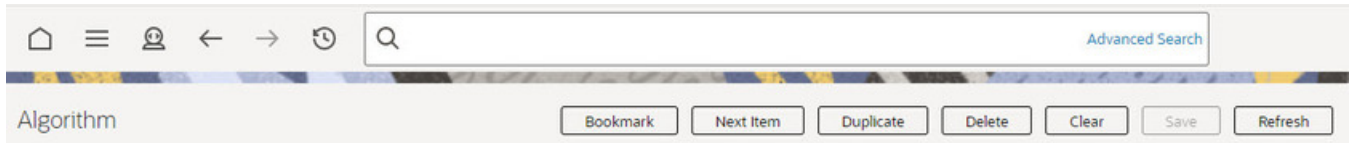

- Portal-based pages display the Delete button in the object-related map.

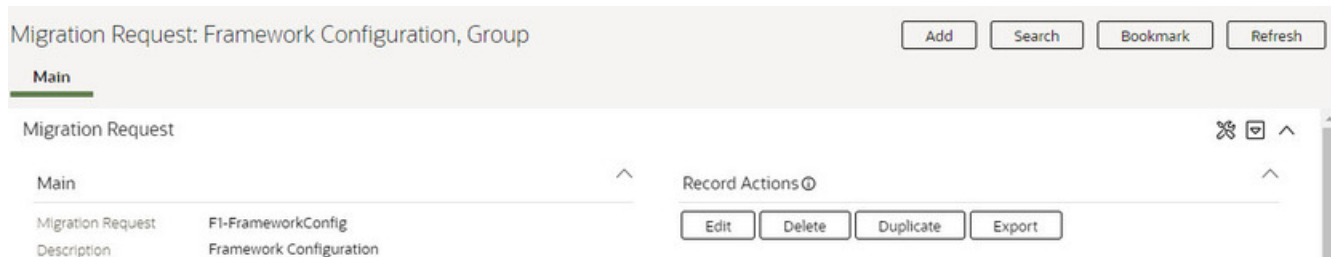

- List style fixed pages commonly display the Delete button (garbage can icon) next to the entity in the list.



In all cases, before the object is deleted, a confirmation dialog is displayed.

CAUTION: A timeout situation could occur as the system attempts to verify the use of the deleted object if the object is referenced in many places *and* involves large volumes of production data. If this timeout situation occurs, you must work with your database administration group to delete the offending object.

Clear Button

Click the **Clear** button to remove the values from the currently displayed object's fields. This action is typically used to clear input fields when adding a new object.

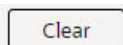

Keyboard Shortcut

Ctrl+Alt+C

Save Button

Clicking the **Save** button saves any changes you have made in the data on the current object.

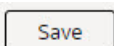

Keyboard Shortcut

Alt+S

Alternate Shortcut

Alt+Shift+S

NOTE: Refer to [Shortcut Key Summary](#) for information about the alternate shortcut.

The button does not appear unless:

- You enter a page in add mode and default values are loaded.
- You make changes to an object after it is displayed (note that you must tab or click out of the field before the Save button appears).

Refresh Button

Click the Refresh button to reload the values on the page with those from the database.

Refresh

CAUTION: All unsaved changes are discarded.

Keyboard Shortcut

Alt+R

Object Display Area

The Object Display Area contains the details of the object(s) currently being viewed or maintained. For example, if you display a portal, its zones are displayed in this area.

Because many of the page components follow Internet standards of operation, the behavior of these types of components are not explicitly described. This section focuses on special features that are unique to the application framework.

Multiple Tabs

When a page in the application includes a lot of information, the page may be implemented with vertical scrolling to allow the user to view all the information. Or alternatively, the page may be implemented with several tabs, allowing the user to navigate between tabs to view or update information. The following image is a section of the User page showing the multiple tabs.

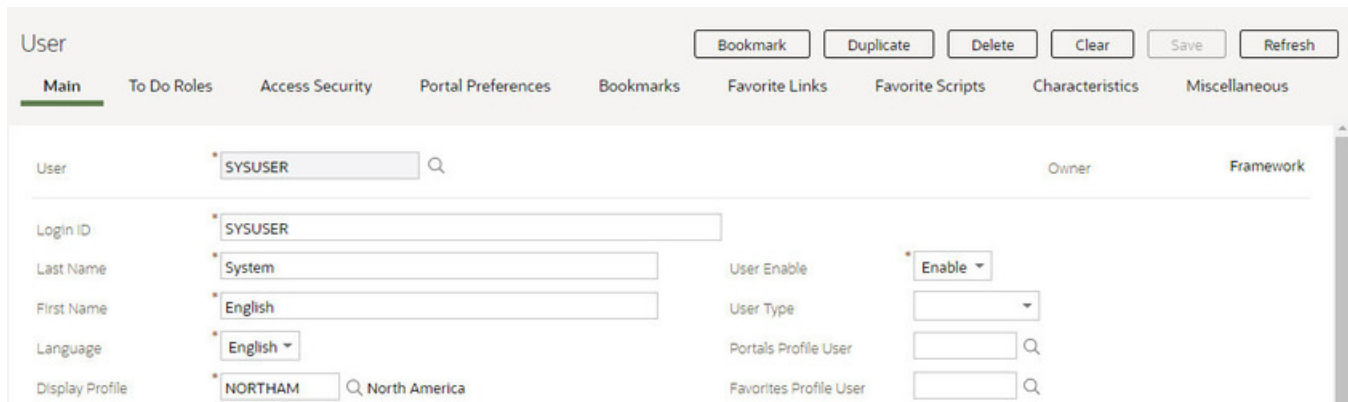

The screenshot shows a web application interface for managing a user. At the top, there is a header with the word "User" and a set of action buttons: "Bookmark", "Duplicate", "Delete", "Clear", "Save", and "Refresh". Below the header is a horizontal tab bar with the following tabs: "Main" (which is selected and underlined), "To Do Roles", "Access Security", "Portal Preferences", "Bookmarks", "Favorite Links", "Favorite Scripts", "Characteristics", and "Miscellaneous". The main content area displays a form for editing user details. The form includes a search field for "User" with the value "SYSUSER" and a magnifying glass icon. Below this are fields for "Login ID" (SYSUSER), "Last Name" (System), "First Name" (English), "Language" (English), and "Display Profile" (NORTHAM). To the right of these fields are "User Enable" (set to "Enable"), "User Type" (a dropdown menu), "Portals Profile User" (a search field), and "Favorites Profile User" (a search field). The "Owner" and "Framework" labels are also visible in the top right of the form area.

Figure 1: Multiple Tabs Example

The names of the tabs describe the type of information that will be displayed in the page when the tab is clicked. For example, if you click on the **Favorite Links** tab, the contents of the page show the favorite links configured for the user.

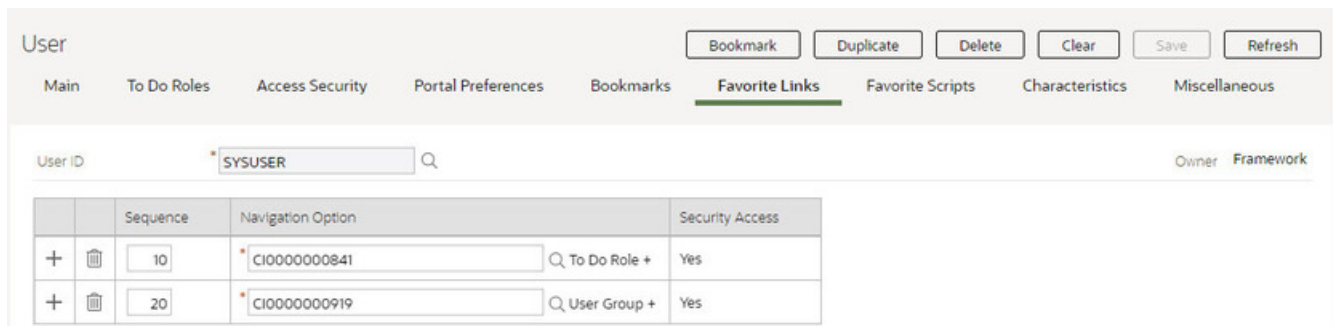

Figure 2: Multiple Tabs Example (After Favorite Links Tab Is Clicked)

NOTE: Hot key options. Rather than clicking on a tab, you can click **Alt+F2** or **Alt+Shift+F2** to scroll through the tabs. **F2** moves you through the tabs from left to right. **Shift+F2** moves you through the tabs from right to left.

NOTE: Hot key options. Use **Alt+** a number to navigate to the tab page whose relative position corresponds with the number. For example, if you press **Alt+6** on the above page, the **Favorite Links** tab will be displayed. **Alt+0** may be used to navigate to the tenth tab. If there are more than 10 tabs on a page, you must use the mouse or **F2 / Shift+F2** to display additional tabs. Note that the numeric keypad on your keyboard cannot be used to implement this function.

NOTE: Returning to a page that contains multiple tabs. If you return to a page (by clicking the **Back** arrow or the **History** icon), the page will be positioned on the last tab that was opened.

NOTE: Page versus Tab nomenclature. The documentation frequently refers to the contents of a given tab as a page. However, the page actually comprises the entire collection of tabs.

Text Box

The following is an example of a basic text box:

Description

If the text box is a large field, the text box may be configured to enable scrolling. In this situation, an expanded edit icon, (a pencil), will appear adjacent to it.

Detailed Description

This BO enter algorithm creates a To Do entry.

The To Do Type is set as follows:

- > If To Do Type Element Name is defined, the value is retrieved from this element in the object's related type.
- > If no Element Name is defined or no To Do Type is found on the related 'type', the To Do Type parm is used.
- > If no To Do Type is found, a log is added for the record with the error.

The To Do Role is set as follows:

- > If To Do Role Element Name is defined, the value is retrieved from this element in the object's related type.
- > If no Element Name is defined or no To Do role is found on the related 'type', the To Do Role parm is used.

Additional capabilities are provided to display and edit data in these text boxes:

- If the field contains more text than is visible, a pop-up that displays the full text appears when you hover your mouse over the text box. The text in the pop-up can be selected and copied.

Detailed Description

Java Class Name

		Sequence
+		* <input type="text" value="10"/>
-		* <input type="text" value="11"/>

This zone type is used to create an info zone. Info zones contain a list of information about a given object. For example, you could set up an info zone to produce a list of all contacts made by the customer in context.

Info zones offer many features that can be used to change how the list looks "on the fly" (by end users). For example, users can add additional columns to the list, change the sort order, ...

For a more detailed description of how these zones look and behave, open the help and navigate to the index entry titled "info zone configuration".

To set up a new zone, fill in the zone's parameters as per each parameter's Comments. For examples, please refer to the "tips" that appear in

* This zone type is used to create an info zone. Info zones contain a list of information about a given object. For example, you could set up an info zone to produce a list of all contacts made by the customer in context.

Info zones offer many features that can be used to change how the list looks "on the fly" (by end users). For example, users can add additional columns to the list, change the sort order, ...

For a more detailed description of how these zones look and behave, open the help and navigate to the index entry titled "info zone configuration".

To set up a new zone, fill in the zone's parameters as per each parameter's Comments. For examples, please refer to the "tips" that appear in the dashboard.

This zone's parameters support a single SQL statement. If you require a zone that is built using multiple SQL statements (e.g., if you need to retrieve rows from disparate sources), please use the Multi-SQL version of this zone type.

- If you click the expanded edit icon, an editable pop-up window appears. If the field is not protected as a result of business rules for the page, you may modify the text in this window.

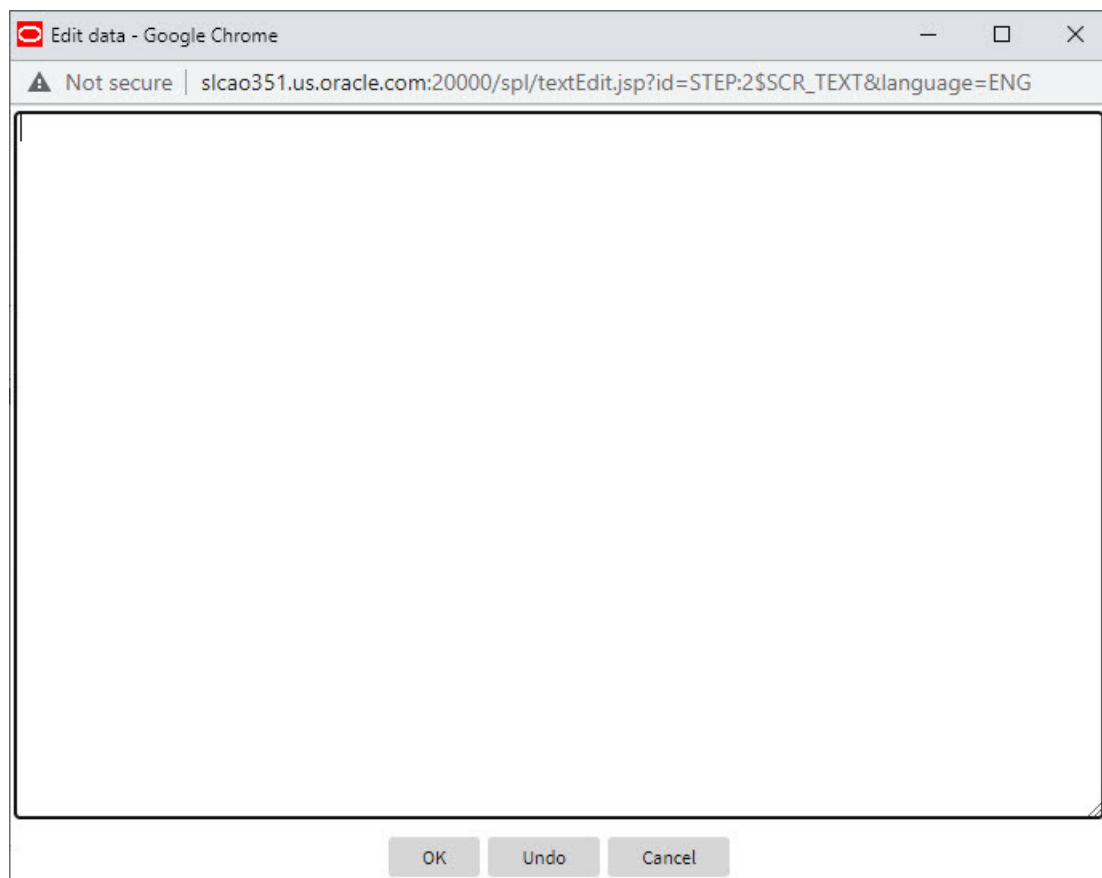

NOTE: The following table highlights special characters that are converted to equivalent standard characters when entered in a text box.

Entered Character Description	Unicode	Converted Character Description
Curly left double quote.	U+201D	Straight double quote.
Curly right double quote.	U+201C	Straight double quote.
Curly left single quote.	U+2019	Straight single quote.

Entered Character Description	Unicode	Converted Character Description
Curly right single quote.	U+2018	Straight single quote.
En dash.	U+2013	Simple hyphen.
Em dash.	U+2014	Simple hyphen.
Ellipse	U+2026	Three dots.
Middle dot (bullet / centered dot)	U+00B7	Asterisk.
Fraction 1/4 (using 1 character).	U+00BC	1/4 (using three separate characters).
Fraction 1/2 (using 1 character).	U+00BD	1/2 (using three separate characters).
Fraction 3/4 (using 1 character).	U+00BE	3/4 (using three separate characters).

Date and Time Fields

When both the date and time are required, the Date and Time fields typically look as follows:

Date / Time

When only the date is required, the Date field looks as follows:

Date

When only the time is required, the Time field looks as follows:

Time

If you click on the calendar icon or press the Enter key while the cursor is positioned to the left of the icon in a Date or Date and Time field, the following window appears:

← February 2022 →

Sun	Mon	Tue	Wed	Thu	Fri	Sat
30	31	1	2	3	4	5
6	7	8	9	10	11	12
13	14	15	16	17	18	19
20	21	22	23	24	25	26
27	28	1	2	3	4	5
6	7	8	9	10	11	12

TODAY CANCEL

Click or press enter to select the date and populate the input field. Use the left and right arrows to scroll back or forward a month. Click on the 'Month' text to bring up a range of months to select from. Click on the year to bring up a range of years to select from.

If you click on the clock icon or press the Enter key while the cursor is positioned to the left of the icon in a Time or Date and Time field, the following window appears:

12	01	02	03	04	05	06	07	08	09	10	11	AM
12	01	02	03	04	05	06	07	08	09	10	11	PM
:00	:05	:10	:15	:20	:25	:30	:35	:40	:45	:50	:55	↓

CANCEL

Select the hour then click or press enter on the minutes to select the time and populate the input field.

Search Button

The search button appears primarily as a magnifying glass.

Algorithm Type F1-BUNIMPAPP

When using a pop-up search window, the search button can appear as a button with its function labeled.

You can have the system search for an item that matches the data you entered using any of the following methods:

- Enter a value in the search field and press **Enter** while the cursor is in the search field. The system assumes you want to search for the value entered and pre-populates it in the search window's search criteria. If a unique match can be found, the system automatically populates the field with details corresponding to the record found. If a unique match cannot be found (either no matches or multiple matches), a search page opens containing selectable items.
- Click the Search button without entering a criteria. This will typically cause a pop-up search window to appear so that you can further refine your search.
- Enter a value and tab out of the search field. The system looks for a value that exactly matches what you entered. If it cannot find such a value, the search dialog will not be presented.

When an item is selected in the search page, the search page closes and the input field is populated with the value selected.

NOTE: Sorting columns within the search grid. You may click on the column heading of columns in a search grid to cause the contents of the grid to be sorted. Refer to [Sorting Functionality](#) for more information.

Context Menu Button

The Context Menu button is a small arrow that appears adjacent to an object's value or information string. An example is shown below:





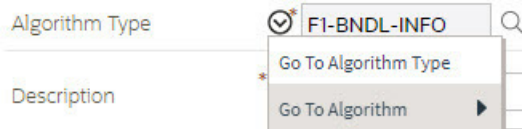

Context menus exist to help you navigate to other pages and populating the page with the current context (by passing the ID of the related object). In addition, the menu items offered in a Context Menu differ depending on the entity that the menu is related to; for example, when you click the Algorithm Type context menu, a pop-up menu similar to this appears:



Different context menus exist for each of the major objects in the system; for example, in Customer Care and Billing, the context menu for Premise contains premise-oriented menu items, whereas the context menu for Account contains account-oriented menu items.

Go To Button

Clicking a Go To button, , opens the page for the related object - it functions like a hyperlink.

		User Group	Expiration Date	Owner
+		 ALL_SERVICES <input type="text"/>  System User Group	* 12-31-2100 	Framework

Broadcast Button

Some zones have been configured to "broadcast" unique identifiers to other zones within the portal; if so, you'll see a broadcast icon, , in the first column. Clicking the icon causes specific zones to reload - these zones that have been configured to rebuild when the unique identifier is received. For example, you might have configured a zone to display the image of a bill when a bill ID is broadcast from an info zone.

Embedded Help Icon

The icon containing a small 'i' is an Embedded Help icon.



When an embedded help icon is clicked, a tool tip appears containing additional information.

Work Lists

The work list buttons can appear in a zone's column heading, .

Clicking the icon results in populating the dashboard [Work List Zone](#) with the entire column. The user may use the Work List zone to easily process entries one at a time without returning back to the source query zone.

NOTE: The Work List zone is populated only upon user request.

Scroll Bars with Dynamic Height

Sometimes the height of a grid isn't sufficient to display a grid's rows. When this occurs, a vertical scroll bar appears and an "expand button" appears above this bar, . For example, the following grid is not high enough to show all of the available dashboard zones:

Dashboard - 10 of 10 zones selected for display.

Zone	Display	Collapsed	Sequence	Refresh	Security Access
Switch Language	<input checked="" type="checkbox"/>	<input type="checkbox"/>	<input type="text" value="20"/>	<input type="text" value="0"/>	Yes
Bookmarks	<input checked="" type="checkbox"/>	<input type="checkbox"/>	<input type="text" value="0"/>	<input type="text" value="0"/>	Yes
Collect Entity	<input checked="" type="checkbox"/>	<input type="checkbox"/>	<input type="text" value="0"/>	<input type="text" value="0"/>	Yes

If you want to view all of the available zones without using the vertical scroll bar, you can click the expand button. When clicked, the height of the grid expands to show all rows in the grid:

Dashboard - 10 of 10 zones selected for display.

Zone	Display	Collapsed	Sequence	Refresh	Security Access
Switch Language	<input checked="" type="checkbox"/>	<input type="checkbox"/>	<input type="text" value="20"/>	<input type="text" value="0"/>	Yes
Bookmarks	<input checked="" type="checkbox"/>	<input type="checkbox"/>	<input type="text" value="0"/>	<input type="text" value="0"/>	Yes
Collect Entity	<input checked="" type="checkbox"/>	<input type="checkbox"/>	<input type="text" value="0"/>	<input type="text" value="0"/>	Yes
Current To Do	<input checked="" type="checkbox"/>	<input type="checkbox"/>	<input type="text" value="0"/>	<input type="text" value="0"/>	Yes
Favorite Links	<input checked="" type="checkbox"/>	<input type="checkbox"/>	<input type="text" value="0"/>	<input type="text" value="0"/>	Yes
Favorite Scripts	<input checked="" type="checkbox"/>	<input type="checkbox"/>	<input type="text" value="0"/>	<input type="text" value="0"/>	Yes
Favorite Searches	<input checked="" type="checkbox"/>	<input type="checkbox"/>	<input type="text" value="0"/>	<input type="text" value="0"/>	Yes
Tags	<input checked="" type="checkbox"/>	<input type="checkbox"/>	<input type="text" value="0"/>	<input type="text" value="0"/>	Yes
To Do Summary	<input checked="" type="checkbox"/>	<input type="checkbox"/>	<input type="text" value="0"/>	<input type="text" value="0"/>	Yes
Work List	<input checked="" type="checkbox"/>	<input type="checkbox"/>	<input type="text" value="0"/>	<input type="text" value="0"/>	Yes



Notice, after the grid is expanded, the grid's vertical scroll bar disappears and the button in the upper corner becomes a Collapse Button, . If you click the collapse button, the grid will return to its original height.

NOTE: Search grids. Expand all functionality is not available in search grids.

Sorting Functionality

Grids have a heading row that contains labels for the columns. By clicking a column heading, you cause the rows to be sorted in the order of the selected column. By clicking on a column more than once, you cause the rows to be sorted in reverse order. Clicking the heading a third time removes the sorting function and returns the grid to its default display organization.

The following shows how information look after organizing the grid, clicking the column heading, by algorithm type (notice the icon in the column name).

	Algorithm	Description 	Algorithm Type 
1	F1-OVRDT-ALG	Validates date in format YYYY-MM-DD	ADHV-DTD
2	F1-ACTIVEWS	Web Service - Verify Active Operations	F1-ACTIVEWS
3	F1-ATCHM-INF	Attachment Information	F1-ATCHM-INF
4	F1-ATSZCLVL	Attachment Size Class Validation	F1-ATSZCLVL
5	F1-BAT-LSDEF	Timed Batch - Service Level Based on 1.5 Timer Interval Factor	F1-BAT-LVSVC
6	F1-BFEMOLOG	Add Business Flag Error MO Log	F1-BFEMOLOG
7	F1-BFSTDNMVA	Business Flag Standard Name Validation	F1-BFSTDNMVA

NOTE: Sorting on dropdown values. If you attempt to sort a column that contains a dropdown value, the information is sorted in the order of the unique identifier associated with the dropdown value, not the description you see on the screen; for example, if you sort on a column containing unit of measure, the information will be sorted in the order of the unit of measure code, not the description that appears in the drop down. This means that the resultant sort will appear incorrect and therefore we discourage you from doing this.

Get More Functionality

Grids in fixed pages that can potentially contain a large number of rows have special processing that we refer to as Get More functionality. Rather than show every row, the system retrieves the first X records (where X varies from grid to grid, and from release to release) and appends a Get More button to the bottom of the grid:

Get More...

When you click the **Get More** button, the system appends the next X rows to the bottom of the grid.

NOTE: The absence of a "get more" button. For pages configured to include Get More, if no button appears at the bottom of the grid, this means all of the rows are displayed.

NOTE: Search grids. The Get More function is not available in search grids.

Adding and Removing Rows Using Arrows









In some editable grids, a new row can be added to another editable grid (the grid on the left) by clicking the Add item button, , of the desired row in the grid on the right:

	Sequence	Description		Sequence	Description
↩	10	Winter kWh charge, first 500	↩	5	Service Charge
↩	20	Winter kWh charge, remaining			

When the Remove item button is clicked, , the row is transferred from the grid on the right to the grid on the left. This change will not be committed to the database until you save the object being maintained

Reorganizing Items Using the Up and Down Arrows

Occasionally, rows can be repositioned in an editable grid by clicking up and down arrows. The following is an example of such a grid:

		Merge Type	Sequence	SQ Rule
	 	Original	10	DA Credits
	 	Original	20	Calc. Number of Days In Bill Period
	 	Original	30	Copy SQs from Master SA to sub SA

Notice the following about such a grid:

- The up arrow is dim in the first row. This is because it can't be moved further to the top.
- The down arrow is dim in the last row. This is because it can't be moved further down.
- The up and down arrows are usable in all other rows. Each time you click one of these arrows, the respective row is moved up or down one row.

NOTE: Reminder. When you move rows into a grid, the system does not apply the change to the database until you click the Save button (which commits the entire object to the database).

Trees

Trees are used to illustrate complex relationships between objects. The following is an example from Oracle Utilities Customer Care and Billing of a page with a tree that is expanded:

Account Tree

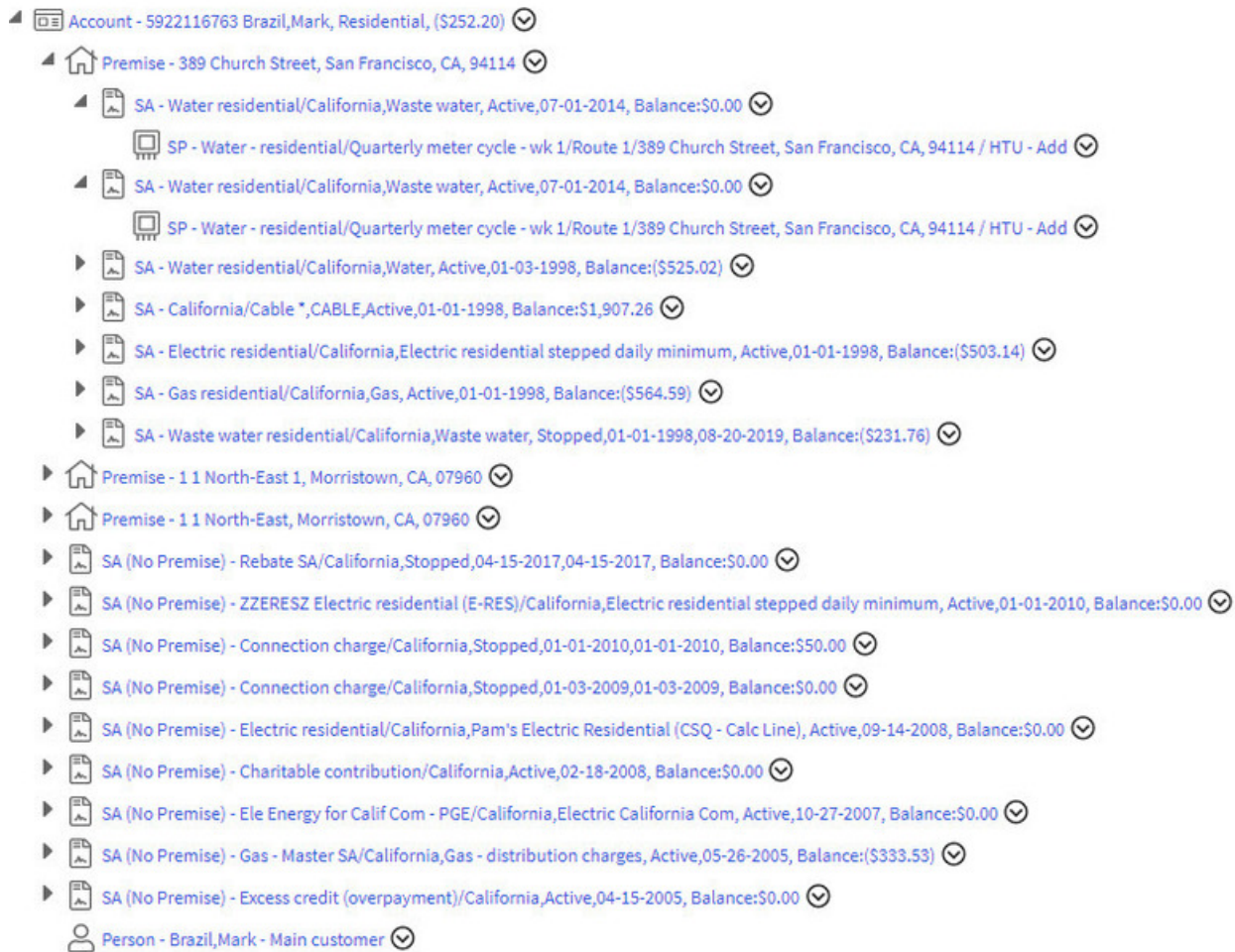

The following points describe how to use trees:

You can expand and contract the nodes in a tree by clicking on the icon that prefixes the node (you can also click the arrows to expand and contract a node).

NOTE: Expand all. If you press `Ctrl` while clicking on an icon that prefixes a node, all child nodes (and their children) expand.

You can click the context menu button to cause a context menu to appear. You can navigate to any of the pages that are presented on this menu. Refer to [Context Menu Button](#) for more information.

You can click on the information that appears in an underlined node to drill into the page in which the object is maintained. For example, if you click on the account information, you will be transferred to the Account - Main page.

NOTE: Important! If you make changes after expanding a tree's nodes (e.g., by drilling down on a Premise and changing the premise's address), the tree will contract to the first node if you return to the page.

Nodes in trees fit into two broad categories:

- **Information nodes.** Information nodes highlight the existence of other data. For example, on the Control Central - Bill Payment Tree, a node exists to highlight the existence of new financial transactions that were created since the last bill was completed.

- **Data nodes.** Data nodes show information about objects in the system. For example, data nodes exist on the Control Central - Bill Payment Tree that show bills and payments.

Required Field Indicator

An asterisk (*) is used to indicate that a field is required. The system determines this based on the field's configuration. When a field becomes required because of an algorithm and not the field's configuration, however, the system will not add an asterisk.

NOTE:

If a page includes a grid, fields within a row may be marked as required.

Operations 





		Operation Name	Description	Schema Type
<input type="checkbox"/>		<input type="text" value="*"/>	<input type="text" value="*"/>	<input type="text" value="*"/>

In this situation, the field(s) within the grid are **only** required if the row is being populated.

Accordion Windows

Accordion windows are used when the data held in an object's rows does not comfortably fit into a grid.

Each row in an accordion has a header that summarizes a row's details. When you click a header, the row expands to show the details. The following is an example of an accordion where all headers are collapsed (meaning that only summaries of the rows' details are shown):

<input type="checkbox"/> Steps	All 3 displayed	[Expand All]	[Collapse All]	<input type="button" value="Copy"/>	
<input type="checkbox"/> +  (10)	Edit data - Get the Physical BO for the MO				
<input type="checkbox"/> +  (20)	Edit data - Get the prime keys of the BO				
<input type="checkbox"/> +  (30)	Edit data - Read the BO				

When you expand a header, its details are exposed. For example, the following shows the same accordion after the third row is expanded:

<input type="checkbox"/>	Steps	All 3 displayed	[Expand All] [Collapse All]
<input type="checkbox"/>	+ <input type="trash"/>	(10)	Edit data - Get the Physical BO for the MO
Step Sequence *	<input type="text" value="10"/>		
Step Type *	Edit data		
Text	Get the Physical BO for the MO		
Edit Data Text	<pre> move "parm/mo" to "F1-RetrieveMOOption/input/mo"; move 'FIPB' to "F1-RetrieveMOOption/input/moOptionType"; move 'false' to "F1-RetrieveMOOption/input/isMultiple"; invokeBS 'F1-RetrieveMOOption' using "F1-RetrieveMOOption"; </pre>		
<input type="checkbox"/>	+ <input type="trash"/>	(20)	Edit data - Get the prime keys of the BO
<input type="checkbox"/>	+ <input type="trash"/>	(30)	Edit data - Read the BO

NOTE: You must expand to update. In order to update a row in an accordion, you must expand it.

Row Summary and Chunk Management

At the top of an accordion you'll find a summary of its rows. The format of this information differs depending on the number of rows and the size of the accordion:

- If the accordion contains every row, a summary of the total number of rows is displayed.
- If the accordion contains a subset of rows, you are presented with a summary of the rows AND you are provided with options to display different "chunks" of rows.
 - Click **First** to display the first "chunk" of rows (the size of a chunk differs depending on the accordion). This option is dimmed if the first chunk is in the accordion.
 - Click **Previous** to display the previous chunk of rows. This option is dimmed if the first chunk is in the accordion.
 - Click **Next** to display the next chunk of rows. This option is dimmed if the last chunk is in the accordion.
 - Click **Last** to display the last chunk of rows. This option is dimmed if the last chunk is in the accordion.

Dashboard Area

The dashboard is a [portal](#) that contains zones. These zones appear regardless of the object being displayed in the [Object Display Area](#). Refer to [Dashboard Portal](#) for a description of these zones. Every user has control over the zones that appear in their dashboard. Refer to [Portal Preferences](#) for more information about how a user can customize the contents of the dashboard.

The dashboard area is displayed before the Object Display area by default. (On the left for a left-to-right language and on the right for a right-to-left language). You have control over its location, width and more as part of your [user preferences](#).

Script Area

When a [script is initiated](#), the [object display area](#) shifts down to make room for the script area.

The information in the script area takes you through the steps in the selected business process (provided by your implementation team).

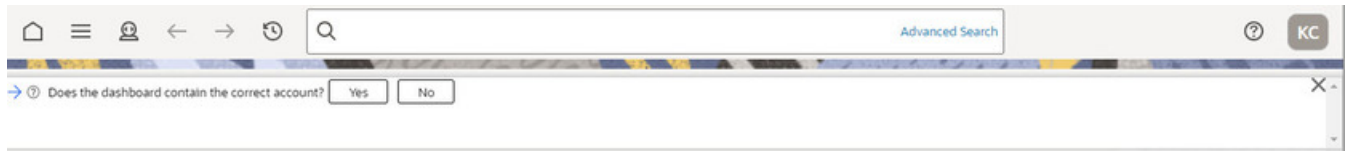

Portal Pages

This section describes using portals and zones to find and display information. This is the preferred technique used by the base product for building user interfaces.

Additionally, portals and zones may be configured by your implementation to supplement the base package provided functionality.

The contents of this section provide background information about portal page behavior.

Portals Are Made Up Of Zones

The term "zone" is used to describe a section on a portal. Each zone has a heading and content.

Keyboard Shortcuts	Description
Alt+]	Moves the cursor focus to the next zone on the page based on the standard browser keyboard navigation "order".
Shift+Alt+]	Moves the cursor focus to the previous zone on the page based on the standard browser keyboard navigation "order".

The following is a portal with seven zones:

- Switch Language
- Bookmarks
- Checked Out
- Current Context
- Current To Do
- Favorite Links
- Favorite Scripts

NOTE: This example may not be available in your application; it is used for illustration purposes only.

The screenshot shows a vertical sidebar with several sections:

- Current Context** (expanded): Contains three items with checkmarks: "Brazil,Mark", "5922116763 4 Brazil,Mark, Residential, (\$252.20)", and "11 North-East, Morristown, CA, 07960".
- Current To Do** (expanded): Contains a button labeled "Assign me a To Do".
- Customer Contact** (expanded): Contains a "Last" section with "175 days ago - Dandugula,Krishna", a "Type" dropdown menu, a "Comment" text area, and an "Add Contact" button.
- Eligible Scripts** (collapsed): Shown with a downward arrow.
- Favorite Links** (expanded): Contains two links: "User Group +" with a count of [1], and "To Do Role +" with a count of [2].

Users Must Be Granted Security Access To Each Zone

A user must be security granted access rights in order to see a zone on a portal.

FASTPATH: Refer to [Granting Access to Zones](#) for information .

Zones May Appear Collapsed When A Page Opens

Zones may be designed to appear collapsed (or minimized) when the portal is initially displayed. To view the information in a collapsed zone, the user can press the zone's expansion button, , to either expand or collapse the zone:

Favorite Links 

Favorite Links	^
To Do Role +	[1]
User Group +	[2]

A zone's data is only retrieved when it is expanded.

Some Portals Allow User Customization

There are some portals in each base product that are configured to allow user customization. In this case, the portal is visible on the user's portal preferences. For these portals each user has control over the following:

- Which zones appear on their portal
- The order in which the zones appear
- Whether the zones should be "collapsed" (i.e., minimized) when the portal opens.

Users define their preferences by clicking the [User Preferences](#) button. Pressing this button transfers the user to the [User Preferences](#) page on which their [Portal Preferences](#) can be defined.

Portals used for base product query and maintenance pages are typically configured to not allow user customization.

Dashboard Portal

The dashboard is a special portal that always appears on the desktop. Its zones contain tools and data that are useful regardless of the object being displayed.

NOTE:

Minimize the dashboard. You can minimize the dashboard by clicking on the vertical bar between the dashboard and the object display area. This causes the dashboard portal to disappear and displays a single vertical dashboard bar, allowing more of the page area to display. It also suppresses the refresh of the zones within the dashboard based on updates to the context. Clicking the dashboard bar restores the display of the dashboard portal. Maximizing the dashboard then refreshes the zones with the latest appropriate content.

Minimize the dashboard when launching the system. If desired, a URL parameter may be used to minimize the dashboard when launching the system, using the parameter `minDashboard=true`. Refer to [Creating Application Links in External Applications](#) for more information and examples.

Adjusting the dashboard width. You can adjust the width of the dashboard by moving the slider that separates the dashboard from the object display area. This also updates your user preferences with the new width.

Keyboard Shortcut

Alt+J

The contents of this section describe the zones that are provided by the framework product for this portal. Please note the following additional information about the dashboard portal that may impact how it appears.

- **Additional zones may be available in other products.** The zones described below are available in every base product. Please refer to the product-specific documentation for additional dashboard zones available in your product (open the help and navigate to the index entry labeled **Dashboard**).
- **Context Sensitive Zones may appear.** Some pages may define additional zones that should appear in the dashboard only if that page is displayed. These are referred to as Context Sensitive Zones.
- **Dashboard zones are configurable.** The dashboard portal is configured to allow a user to define preferences for it. Refer to [Portal Preferences](#) for more information.

NOTE: Security. As a general rule, dashboard zones each refer to a unique application service so that a security administrator may configure which users are allowed to have access to which zones. Note that the user portal preferences indicates which zones a user has security access to.

Bookmarks Zone

After clicking the [Bookmark](#) button and saving a bookmark, it is visible in the **Bookmarks** zone. Clicking one of the links in the zone navigates to the page where the bookmark was saved and loads the information related to the record that was displayed when the bookmark was saved.

Click the trash can icon to delete the bookmark.

Note that a user may change the name of the bookmark or change the sequence of the bookmarks by navigating to the [User - Bookmarks](#) in the user preferences.

Tags Zone

The **Tags** zone provides a quick way to associate the entity currently being displayed with an entity tag or remove any of the tags it current has. Tagging an entity may be useful to highlight various contexts in which it can be used, for example for testing or reporting purposes. Refer to [Defining Entity Tags](#) for more information.

Note that the zone is visible only when there is an entity in context, i.e. there is an entity to tag, and the user has application security access to this zone.

Collect Entity Zone

The **Collect Entity** zone provides a quick way to add or remove the entity currently being displayed to and from the [migration request](#) in context. This is mainly useful when reviewing data to export and while doing so maintain the export list. The zone automatically appears once an **Entity List** migration request is visited and set in context.

Current To Do Zone

The **Current To Do** zone is designed to streamline the process of working on To Do entries from assignment to completion. It displays key information about the user's current To Do entry and provides functions that help minimize the number of steps it takes to resolve the entry and potentially other entries related to it.

The following sections provide more detail about the zone.

Next To Do Assignment

Users may have the option to click the **Assign me a To Do** button to request the next To Do entry they should work on. This functionality is optional and can be configured to follow your organization's business rules in determining the next task for a user. For example, if your organization practices work distribution "on demand", this feature can be configured to find the highest priority entry a user can work on and assign it to the user. Refer to [work distribution](#) for more information on this business practice.

NOTE: Next To Do Assignment Rules Are In A Plug-in. Refer to [Installation Options](#) for more information on how to configure the system to take advantage of this function.

If the system is successful in determining the next entry the user should work on, this entry becomes the user's current To Do and its information is displayed on the zone.

User's Current To Do

The user's current To Do may be set using the Next Assignment algorithm, or by drilling in on a To Do from the To Do List or To Do Search page as described in [A User's Current To Do](#). Once a current To Do has been set, the zone displays details related to the To Do.

The **Message** describes why the entry exists. The message description allows the user to drill into the page on which the entry's respective object is displayed. For example, if the entry is associated with an asset that needs review, the user is brought to the asset page to view the information and potentially take action. If the **To Do type** has been configured to associate a **script** with this To Do entry's message number, then instead of being taken to the respective page, the associated script is launched.

Info displays the standard To Do information. An icon  appears if there are comments on the To Do and a Log Entry

icon  appears if there is a log entry of type **Forwarded**, **Sent Back** or **User Details** on the To Do. The description drills into the **To Do entry** page allowing the user to view more information about the entry or make changes to it as needed.

The user may use the **Complete** button in the zone to complete the current entry.

Next / Previous Buttons

The **Previous** and **Next** buttons are enabled on this zone under the following conditions:

- The user selected an entry either on the [To Do List](#) page or the [To Do Search](#) page.
- At least one other entry exists *below* (for Next) or *above* the entry selected (for Previous).

Clicking **Next** or **Previous** will bring the user to the transaction indicated on the To Do Entry's message, where its respective object is displayed. It also makes that To Do the Current To Do displayed in the zone.

Keyboard Shortcut	Comments	Alternate Shortcut
Alt+Y	Previous To Do	
Alt+Z	Next To Do	Alt+Shift+Z

NOTE: Refer to [Shortcut Key Summary](#) for information about the alternate shortcut.

NOTE: When a user drills down on a To Do entry from the To Do List page, the system automatically changes the status of the entry to **Being Worked**. If **Next To Do** or **Previous To Do** is subsequently used to scroll through this list, the system does *not* change the To Do entry's status. To change the status of these entries, the user must navigate to the [To Do List](#). On this page, multiple entries may be selected and their status changed with a single user-interface action.

Related To Do Entries

If the To Do entry has non-complete [related entries](#) a summary **Related To Do** description appears. The description states the total number of related entries, how many are still in **Open**, how many are assigned to current user and how many assigned to others. This hyperlink navigates to the [To Do Search](#) query allowing the user to review the related entries. At this point the user may decide to assign entries that can be positively identified as being caused by the same problem as the current To Do also to himself.

If at least one related To Do entry is **Open** or also assigned to the current user, the **Complete All** button is visible. If the user determines that the related To Do entries have been resolved with the appropriate action taken, the button may be used to complete in one step the current entry and all related entries that are **Open** or assigned to the current user.

If the related entries are not resolved with one action, the user may opt to use the **Complete** button to complete the current entry alone and work on related entries one at a time. Using the related To Do information hyperlink the user may navigate

to the To Do search page and drill into the first related To Do to work on using the message hyperlink. This entry now becomes the user's current To Do and the **Next** and **Previous** action buttons are set to scroll through the related entries list.

Favorite Links Zone

Each line in the **Favorite Links Zone** corresponds with one of the user's favorite links (e.g., transactions). Clicking on a line invokes the transaction. The first nine entries can be invoked by pressing an accelerator key (Ctrl + the number of the relative position of the link in the list). Note that the numeric keypad on your keyboard cannot be used to implement this function.

Users define their favorite links by clicking the [User Preferences](#) button. Clicking this button transfers the user to the [User Preferences](#) page on which their [Favorite Links](#) can be defined.

Favorite Scripts Zone

The Favorite Scripts zone lists the business process assistant (BPA) scripts that you have defined on your [user preferences](#). You can click on a script to [execute](#) it. You can click the **Search** button in the zone to search for other scripts.

NOTE: If you do not see the Favorite Scripts zone in your dashboard, navigate to User Menu and click the **Preferences** menu item to display the [User - Portal Preferences](#) page. Under the Dashboard Portal row, select the **Display** option for the Favorite Scripts zone.

Favorite Searches Zone

If you marked a saved search as a favorite using [Saved Searches](#) functionality, the search is visible in the **Favorite Searches** zone. Clicking one of the links in the zone navigates to the page where the search was saved and populates the filter values and executes the search.

Switch Language Zone

The **Switch Language** zone is used to switch the application's language. Only languages that are supported by your implementation will appear.

To switch the application's language, choose the desired language and press the **Refresh** button.

NOTE: If your implementation uses a single language, you should suppress this zone by [not granting security rights](#) to the zone's application service.

To Do Summary Zone

The **To Do Summary Zone** has several purposes:

- It presents a summary of the [To Do entries](#) that have been assigned to you and are **Being Worked On**.
- The colored "age bars" highlight the age of the To Do entries. The colors red, yellow and green are used to highlight the relative number of old, middle-aged and new To Do entries. The age associated with each of these colors is [user-configurable](#). Note, you can hover the cursor over an "age bar" to see the number of To Do entries.
- If you click on the To Do Type description, you'll be transferred to the [To Do Management](#) portal where these To Do entries will be displayed. From this page, you can drill down to the specific entries.

NOTE: Time saver! Use the worklist button when working on an entry in the [To Do Management](#) portal. All the individual To Do entries will be visible in the Worklist dashboard zone, allowing you to work through additional To Do entries without returning to the To Do Management portal.

Work List Zone

The **Work List** zone is populated when a user click the [Work Lists](#) icon in an info or query zone. When you click the link of the work list entry, the system does whatever it would have done if you had clicked on the hyperlink in the zone. The system marks the current entry with a star. It marks any previously worked entry with a checkmark.

Previous and Next buttons are available in the zone allowing you to go to the next or previous entry without having to locate it yourself and click the link.

You may actively mark an entry to be ignored by the Previous or Next button by clicking the icon column for that entry. An icon of an eye with a slash through it is visible. You can click the icon to re-include that entry in the previous / next action.

The work list stays populated until you either click the Clear link in the zone's dashboard or you overlay the work list by clicking a different column's work list icon.

The image shows a work list zone illustrating that the first entry was "visited", the second entry is the current one being viewed and the fourth entry is marked to skip or ignore.

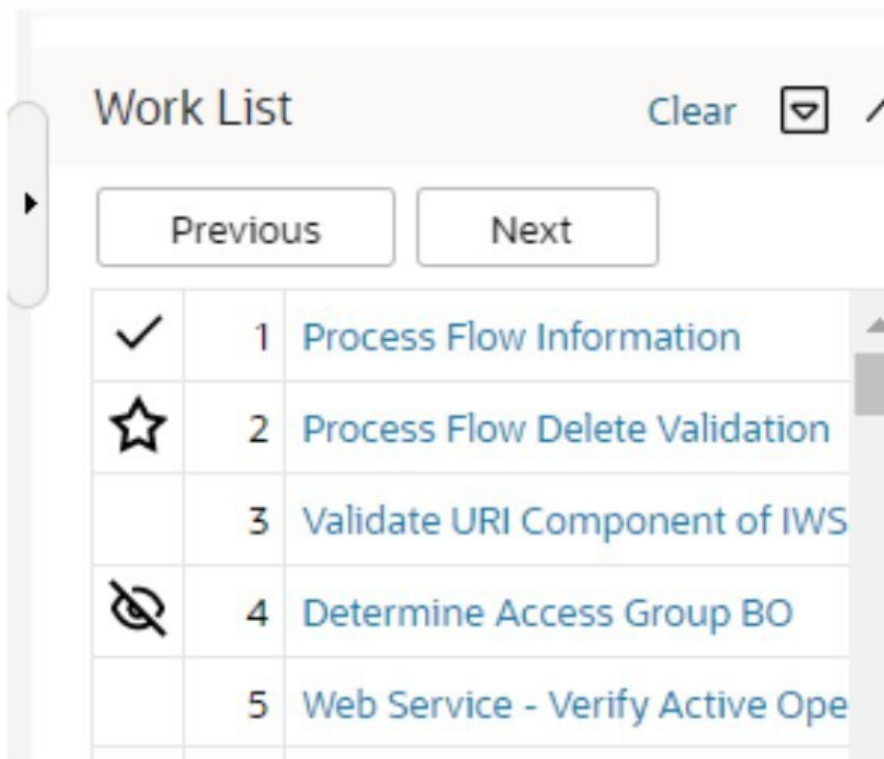

Zone Types and Characteristics

The topics in this section describe common zone types, function, and common characteristics.

FASTPATH: Refer to [The Big Picture of Portals and Zones](#) for a description of general portal and zone functionality.

Common Characteristics of Zones

The following topics describe common characteristics of all zone types supported by the base package.

Zone Visibility

A zone may be configured to dynamically be visible or completely hidden depending on the information being displayed. When hidden, not even the header is displayed.

For configuration information, refer to [Zone Visibility Service Script](#).

Control Zone Headers

A zone may reference a UI Map to define and control its header. This feature provides the means to achieve a uniform look and feel for the application as well as add functionality to the zone header beyond being just a title bar to open and close the zone. Refer to [UI Map](#) and to its context sensitive tips zone for more information on **Fragment** UI Maps and how they are used to construct zone headers.

Explorer Zones

The product provide several zone types that are used to find or display a set of information. These are called explorer zones. There are two types of explorer zones:

- **Info zones.** An info zone displays a list of information about an object. These types of zones often display information without requiring any input from the user.
- **Query zones.** A query zone allows users to find objects matching a given search criteria.

Virtually every aspect of an info or query zone is controlled by its zone [configuration](#). However, most share basic common components described in the subsequent sections.



Search Criteria / Filter Area

For query zones, the Search Criteria Area (also called Filter Area) contains the criteria used to find objects. The design of the zone controls the number and type of filters that appear in this area. After search criteria is entered, clicking the **Search** button causes the system to look for records that match the criteria. The results are shown in the Results Area.

The system automatically collapses the filter area to allow more space for displaying the results. At that time the **Expand Filters** button may be used to open the filter area to enter different criteria. When the filter area is expanded the **Hide Filters** button may be used to collapse the filter area again without performing a new search.

For info zones, the zone's configuration indicates whether or not a Filter area is applicable and if so, whether or not it is open or closed by default. If the filter area is configured, the [Show Filter](#) icon is visible in the zone header. Click this icon to expose the Filter Area, if it is not visible and click the icon to hide the Filter Area if desired. Use this area to filter the information that appears in the zone by different values. Click the **Search** button to rebuild the Results Area using the specified filters.

For example, the following shows an info zone listing user groups that do not have access to a given Application Service where a filter area has been configured to allow users to show user groups specific to a given user by ID or name.

User Groups not Linked   

Filters: Application Service CILZRBPP, User ID EUBALDO

	User Group	Description 	Grant Access
1	*PORTAL*	Portal System Default	<input type="button" value="Grant Access"/>

Use to show user groups with specific user

User ID

First Name

Last Name

The info zone includes configuration to indicate whether the filter area, when exposed, should be shown at the top of the zone (above the results) or at the bottom of the zone (below the results). For query zones, the search criteria is always displayed at the top.



NOTE: Press Enter. Rather than clicking the **Search** button, you can press **Enter** to trigger the search / info zone refresh.







Description Bar

The Description Bar describes the search criteria that were used to build the Search Results Area.

Results Area

The Results Area displays the appropriate list of objects. For an info zone, this is the list of appropriate objects with any input filter criteria considered. The following is an example of the results for an info zone. For a query zone, this is the list that matches the search criteria defined in the Filter Area. The following is an example of the results set of an Info Zone.

Business Objects with Status Reason   

	Business Object	Description	Statuses
 1	F1-BusinessFlagError	Business Flag Error	Discarded
 2	F1-CubeView	Cube View	Active, Inactive
 3	F1-GenericBISyncRequest	Generic BI Sync Request	Discarded, Cancel
 4	F1-MessageFromDevice	Message From Device	Canceled
 5	F1-MessageToDevice	Message To Device	Queued, Canceled, Processed
 6	F1-MigrDataSetExport	Migration Data Set Export	Canceled
 7	F1-MigrDataSetImport	Migration Data Set Import	Canceled, Completed

For a query zone, the columns that appear may differ depending on the search criteria. For example, if you search for a customer by their driver's license number, the resulting columns may be different than the ones displayed when you search by customer name.

The following points highlight details related to viewing and working with the result set:

- **Broadcast.** If the results set is configured to display a broadcast icon,  , it means that at least one other zone on the portal is configured to display data related to the record selected in the results list. Clicking this icon will cause the other zone or zones to be built or refreshed to display related data.
- **Hypertext.** One or more columns in the zone may be configured as hypertext. Clicking the hypertext will result in navigating to another page to display data related to that column based on the configuration for that column.

- **Maximum height.** The maximum height of the report area is controlled by the zone's configuration. A vertical scroll will appear when more rows exist than fit into the height.
- **Maximum rows.** The maximum number of rows that can appear is controlled by the zone's configuration. Excess rows are truncated before display. Please note, you can configure the zone to [download more rows to Excel](#) than appear in the Results Area.
- **Control column sorting.** By default zones are designed to allow a user to sort the results list by clicking any column heading. Clicking once sorts ascending. Clicking again sorts descending. However, a zone may be configured to not allow this type of sorting.
- **Work list.** Columns may be configured to enable the [work list](#) icon, . Clicking this pushes all the data into the [Work List zone](#).
- **Rearranging columns.** A zone may be configured to allow a user to rearrange columns and add or remove columns visible in the Result Area. Refer to [Column Configuration](#) for the details.

The type and variety of columns that appear in the Results Area is controlled by the zone's configuration.

Title Bar

The Title Bar contains the zone's description along with other icons and functions described in this section.

In the corner of the Title Bar, you'll see an indicator that tells you whether the zone is collapsed (e.g., minimized) or expanded. Each time you click the indicator, the zone toggles between expanded and collapsed. The following image shows a collapsed zone.

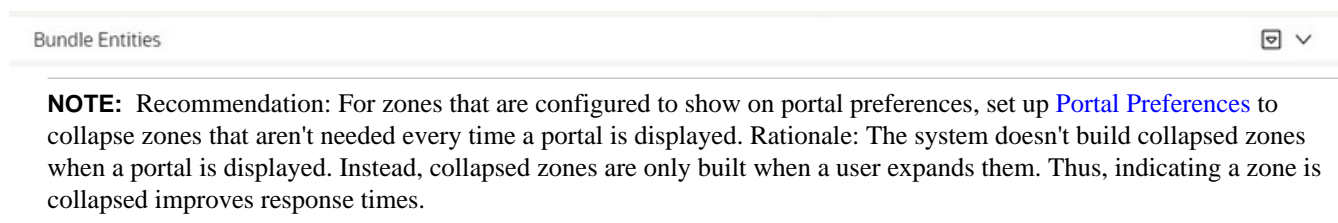

If the zone is configured with help text, a help icon appears to the right of the zone title. Click this icon to view the help text.

If a [saved search](#) is open for a zone, the name of the saved search is displayed after the zone title.

The following sections describe additional icons and tools visible on the title bar. Note that in addition to the information described in this section, additional actions that are specific to a zone may appear based on configuration. The actions may appear in the form of hypertext, an icon or a button.

Explorer Zone Menu

Click the Explorer Zone Menu icon  to list available tools. The following topics describe each tool.

Clear Filters

Click the **Clear Filters** link in the Explorer Zone menu to clear the filter values and zone data.

Export to Excel

Click the **Export to Excel** link in the Explorer Zone menu to download the zone's data to Excel. This link is hidden if the zone has been configured to not download rows to Excel.

Please note the following with respect to this feature:

- Clicking export performs the search because it is possible to configure a number of records for excel that differs from the number of records configured to display.
- Because the search is performed, you can request an export to Excel even without first searching on the zone. The filters populated (or not populated) at time of exporting are the ones used for the export. If the user did not search at all or did a search and then changed the filters and exported before searching again, the results in the export may not match what is visible on the zone.
- It is possible through zone configuration to mark columns that are visible to the user interface as suppressed in the export. Conversely, it's also possible to mark columns as suppressed on the user interface but included in Excel. As such, the columns visible in the export may not always match what is visible in the user interface. This applies when for zones that support [configurable columns](#). Columns removed from view through this technique are still included in the export if not marked to suppress.
- If the column results include any HTML, the HTML is stripped out before exporting to Excel.

Print

Click the **Print Zone** link in the Explorer Zone menu to print the zone.

Save Search Options

Query zones and info zones that include filter areas, allow a user to capture and save filter criteria so that the same search can be more quickly executed in the future. Users may save many different search options for the same zone. Users also have the option to nominate one search as the default so that this search is automatically loaded upon entering the zone. In addition, users may choose to set one or more searches as a Favorite, which causes the search to appear in the [Favorite Searches](#) zone in the dashboard. This allows a user to navigate to the portal for that zone and load the saved search in one click.

The Explorer Menu includes various options for supporting Saved Searches that are described below.

Note the following additional points about this functionality:

- **Click Search before Saving.** When a user wants to save a search, the search criteria should be entered and the **Search** button should be clicked prior to saving the search.
- **Criteria is saved, not results.** Although a user must click **Search** prior to saving the search, the system saves the criteria, but not the results. When returning to the query or info zone in the future and opening a given saved search, the results displayed will be the current records in the system that match the saved search criteria.
- **Multi-Query Zones.** When a user is on a multi-query zone, the searches are saved at the multi-query zone level so that all saved searches for the various search dropdowns for a given multi-query zone are visible in the Open Saved Searches menu option.
- **Functionality is Secured.** If for any reason an implementation wishes to restrict which users are allowed to save searches, the functionality is securable. Only users with **Inquire** access to the **F1_USRFAVSCH** application service will see these options in the explorer menu. This is the same application service that is used to provide access to the Favorite Searches dashboard zone.

Save As

The **Save As...** option in the Explorer Zone menu allows a user to save the current entered search criteria. This should be clicked after executing the search.

The user is prompted to provide a name for the search. This search is now available from the Open Saved Searches option. If desired, a user can also choose to make this search the Default or may choose to Add to Favorites.

This option is visible whether or not an existing saved search is loaded. When a saved search is loaded, this option allows a user to make changes to the search criteria and save a new search with that criteria.

Open Saved Search

The **Open Saved Search...** option in the Explorer Zone menu is visible if there are any saved searches for the zone that is currently visible. Select this menu entry to view the current list of saved searches for the zone. For multi-query zones, any saved search for any of the query zones that are part of the multi-query zone are visible. Choose the desired saved search. The criteria is updated with this information and the search is performed.

Save

The **Save** option in the Explorer Zone menu is visible if a Saved Search is already loaded. This option allows a user to save changes to the criteria of an existing saved search (overwriting the previously saved criteria).

Set As Default

The **Set As Default** option in the Explorer Zone menu is only visible if a saved search is loaded and it is not currently the default. Click this option to nominate this search to be the one that is loaded when navigating to this zone from the menu.

Remove As Default

The **Remove As Default** option in the Explorer Zone menu is only visible if a saved search is loaded and it is currently the default. Click this option to no longer load this search automatically when navigating to this zone from the menu.

Add To Favorites

The **Add To Favorites** option in the Explorer Zone menu is only visible if a saved search is loaded and it is not currently included in the favorite searches zone. Click this option to include this search in the [Favorite Searches](#) zone. Once a search is in the Favorite Searches zone, you can use the link to the search in the dashboard to navigate to the portal for this zone and load the saved search in one click.

NOTE: Not available for dependent zones There are some portals that include a zone that is not the main query or info zone on the portal, but is rather a zone providing additional information for a record that is displayed. If a zone like this has filter options or configurable columns, a user is able to save searches and mark one as a default, but will not be able to add the saved search to favorites because the zone is dependent on other data on the page that is not captured for the individual zone.

NOTE: Dashboard Zone Preferences. Be sure that your [portal preferences](#) are configured to include the Favorite Searches dashboard zone.

Remove From Favorites

The **Remove From Favorites** option in the Explorer Zone menu is only visible if a saved search is loaded and it is currently included in the [Favorite Searches](#) zone. Click this option when you want to keep the saved search but you no longer want it visible in your Favorite Searches zone. (Deleting a saved search that is also marked as a favorite will automatically remove the search from the favorite searches zone.)

Delete

The **Delete** option in the Explorer Zone menu is only visible if a saved search is loaded. Click this option to remove the currently opened saved search from the list of saved searches.

Note that if the saved search had been configured as favorite, deleting the saved search remove it from the favorite searches zone.

Show Filters

Click the **Show Filters** icon  to show the [Filter Area](#). This button only appears if the zone has been configured to have filters.

NOTE: If the zone is configured to have filters and the drag and drop (column configuration) area, only one or the other is shown at any given time. It means that a user can either change the filter criteria and refresh the search results or change the column configuration and refresh the results.

Show Column Configuration Area

Click the **Column Configuration** icon  to show the [Column Configuration Area](#). This button only appears if the zone has been configured to allow columns to be dragged and dropped into the Results Area.

NOTE: If the zone is configured to have filters and the drag and drop (column configuration) area, only one or the other is shown at any given time. It means that a user can either change the filter criteria and refresh the search results or change the column configuration and refresh the results.

The Open Zone Maintenance Icon

Click the **Go To Zone** icon  to switch to the zone's [zone maintenance](#) page. On this page, you can change the parameters that control the zone's behavior.

NOTE: Debug mode only. This icon only appears when the system operates in [Debug](#) mode.

Configurable Columns

Info zones and query zones may be configured to allow users to rearrange columns and to remove or add columns to the output. This is also referred to as "drag and drop" of columns.

When a zones is configured to support this functionality, the [Show Column Configuration Area](#) icon is visible in the zone title area. Click this icon to expose the Column Configuration Area, if it is not visible and click the icon to hide the Column Configuration Area if desired.

If configurable columns are allowed, a user may rearrange the order of columns currently displayed in the Results Area by clicking the column heading and "dragging" it to the desired location.

In addition, the column configuration area may display columns that are not currently in the Results Area. These are indicated by a cream background. A user can drag one of these columns to the results area and then click **Refresh** to rebuild the zone. To remove a column that is currently in the results area, click the trash can icon next to the column name in the column configuration area and then click **Refresh** to rebuild the zone.

The following is an example of how the Column Configuration Area looks:

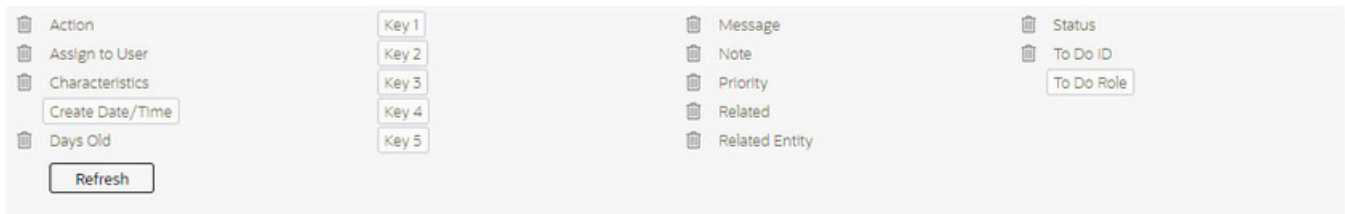

Multi-Query Zones

This type of zone combines individual Query Zones into a single query zone. A **Search By** dropdown, built from the zone descriptions of the individual Query Zones, allows you to select the desired query to execute. Selecting a specific Query Zone display the filters of that query in the filter area. At this point the zone simply executes the selected Query Zone, as if it was executed on a standalone zone. By default, the first query zone option is selected.

Search By

Asset Information

Asset Type

Detailed Description

Location

Asset Information

Asset Identifier

Asset Disposition

Asset Specification

Employee Information

Install Date

Asset Maintenance Specification

Asset Attribute

Map Zones

A map zone displays information related to one or more objects. For objects that are maintained using portal-based pages, the standard display of the object is using a map zone. Map zones may be configured to display an explicit map or may dynamically display the map based on the configuration of the record being displayed.

Because the information displayed in a map zone is configured using HTML, virtually any format supported by HTML is possible. The following is an example of a typical map zone used to display information about an object.

Migration Request: Framework Configuration, Group

Add Search Bookmark Refresh

Main

Migration Request

Main

Record Actions

Edit Delete Duplicate Export

Migration Request Description

FI-FrameworkConfig

Framework Configuration

A [tool tip](#) can be used to display additional help information for the details shown in a map zone. The tool tip may appear adjacent to the section header or adjacent to individual elements on a map.

NOTE: You can customize the help icon or disable map help using the [Custom Look and Feel](#) feature configuration.

Open Map Maintenance Icon

Click the **Go To Map** icon to switch to the [UI map](#) maintenance page. On this page, you can view the HTML configuration for the zone. Note that for map zones that display a business object configured without a map, the elements displayed are automatically rendered. In this case, no icon is visible.

NOTE: Debug mode only. This icon only appears when the system operates in [Debug](#) mode.

Tabbed Display Zones

This type of zone combines individual [map zones](#) into a single zone, allowing for complex of information to be organized and displayed in different tabs.

Tab labels are built from the zone descriptions of the individual zones and become the zone's title. Selecting a specific tab displays the information managed by the underlying zone. By default, the first tab is selected.

Timeline Zone

A timeline zone is used to show events over time for multiple types of data. This type of zone is helpful for providing a consolidated view of separate events occurring in time that may in fact impact each other. For example, in the billing system, a timeline can show bills, payments and collection processes for the same time period.

The topics in this section describe the functionality available in timeline zones.

Timelines Zones Are Configured By Your Implementation Team

The product provides support for creating timeline zones. However, whether timeline zones are configured for your implementation and on which portals they may be visible will depend on your specific configuration. Refer to [Configuring Timeline Zones](#) for general information about configuring timeline zones. Refer to your specific edge application's documentation for details about what type of timeline information is provided out of the box.

You Can Move Through Time

You can click the controls at the top of a timeline zone to change the date-range of the zone's information. To reposition the timeline to a specific date, selected the desired month and year at the top of the zone and click the search arrow.

Controls at the top right of the zone allow you to navigate through time.

- To go back one year, click the double-left arrow.
- To go back one month, click the single-left arrow.
- To go to today, click the middle dot.
- To go forward one month, click the single-right arrow.
- To go forward one year, click the double-right arrow.

Timelines Can Have Many Lines

Depending on how a timeline zone is configured, it will typically have one or more "lines" that show when significant events have occurred. Each line represents a specific type of data. The data may be related to a specific maintenance object, for example, payments may be displayed in one line and bills in another. It may also be possible to create multiple lines for different types of records for the same maintenance object. For example, if your product provides an algorithm to display cases, it may support defining a different entry for each case type.

Each Line Shows Events

Each line on a timeline may contain zero or more events where each event shows the date when the event occurs. For example, the payment line in a timeline has a separate event for every payment received from the customer. Each line's description contains the number of events on the line.

CAUTION:

If a line has more events than can fit onto a timeline, the line will show the first "chunk" of events and a message will appear in the "more info area" explaining that some events have been truncated. If this happens and the truncated events are in a later period, you can reposition the timeline's base period to show the truncated events.

Hovering Over An Event Shows the Event Information

When you hover over an event's date icon, a pop-up widow appears showing details of the event. The following information may appear:

- The event date.
- The event "hover text". Typically the standard information string is shown for each event.

- The event's common "information string" appears. This information is hypertext to allow for easy access to the transaction on which the object is maintained.
- Additional information may appear. This is dependent on the particular timeline algorithm. Refer to each timeline algorithm's description to find out if additional information appears in the pop-up area under any conditions.
- If the algorithm has configured BPA scripts that can be executed to perform business processes on the object, the BPA script description appears prefixed with a "wizard's hat" icon.

Common Base Portals and Zones

The following sections describe common standards followed by the product for base query and maintenance dialogue.

All-In-One Portal

The all-in-one portal is used for low volume objects, where a small number of records are expected.

For example, many control tables use this style of portal. In this portal, rather than separate query and maintenance portals, a single portal allows a user to find a record and maintain the record. A zone listing all existing records is displayed when first entering the portal. A user can perform actions on existing records or add new records from there. More details about the list zone are provided below.

Refer to [Maintenance Portal](#) for information about zones commonly found on maintenance portals.

The all-in-one portal will typically provide the ability to add a new record. This may be a button in the Page Action area or a hyperlink defined directly on the list zone's header area.

List Zone

This info zone appears when first entering the portal and displays a row for each record.

The following functions are commonly available in a list zone:

- A broadcast icon is included in each row. Clicking this icon opens other zones that contain more information about the adjacent record.
- An **Edit** icon may be included in each row. Clicking this icon launches the maintenance BPA script to modify the adjacent record.
- A **Duplicate** icon may be included in each row allowing the user to duplicate the adjacent record without having to first display the record.
- A **Delete** icon may be included in each row allowing the user to delete the adjacent record without having to first display the record.
- If the record has a simple BO lifecycle of **Active** and **Inactive**, the list zone may include a button to **Activate** or **Deactivate** the adjacent record.

Separate Query and Maintenance Portals

For high volume objects where more sophisticated search criteria is needed to find a particular record, separate portals are provided to search for the record and to maintain it.

The query portal contains a zone to search of the object that you wish to maintain. Additional information about the query portal's search zone is provided below. Clicking an appropriate record in the search results navigates to the object's stand-alone maintenance portal.

The query portal will typically provide the ability to add a new record. This may be a button in the Page Action area or a hyperlink defined directly on the list zone's header area.

Query Portal Search Zone

The query portal contains one zone used to search for the object.

The zone may be a standard query zone or may be a multi-query zone providing one or more ways to search for your record.

Once the search results are displayed, click on the hypertext for the desired record's information string to navigate to the stand-alone maintenance portal.

Maintenance Portal

A maintenance portal refers to a page that is used to view and maintain a specific record. These types of records are governed by a business object, which defines the user interface layout for both the display of the record and the add or update of the record.

An all-in-one portal is a type of maintenance portal where the maintenance zone is displayed once a record has been broadcast from the list zone. For the separate query and maintenance portal dialogue, the maintenance portal includes only zones relevant for the specific record selected.

Maintenance portals may have multiple tabs to display information relevant for the object. Often, if the object has a Log, the log is on a separate tab. (However, there may be some maintenance portals that include the log zone on the Main tab.)

The stand-alone maintenance portal is typically configured with the ability to navigate back to the query portal using either a **Search** button in the Page Actions area or using a **Go To Search** hyperlink in the main zone's header area. The stand-alone maintenance portal may also include the ability to add a new record using an Add button in the Page Actions area. (If not, a new record can be added by navigating through the menu or by navigating to the query portal where an Add hyperlink may be found.)

The following sections describe zones that are common to portals used to maintain a record. Note that additional zones may exist for specific all-in-one portals or stand-alone maintenance portals based on the particular functionality. Refer to the documentation for each portal to understand the specific zones that are provided.

Object Display Zone

This is a zone that displays the object being maintained.

An object being displayed may or may not allow for actions or updates to be made. Typically there is a Record Actions section in the display area that presents the valid actions. Depending on the functionality, the actions may prompt the users to input values required for that action.

Log Zone

If the maintenance object for the record includes a status, it typically has a log that records important events in its lifecycle.

This log is shown in an info zone on the portal, either on the Main tab or on a separate Log tab. A link appears in the zone's title bar to allow the user to add a new manual log entry.

Process Flow

This portal is used to guide a user through the steps needed to complete a process flow. If the process flow type is configured to keep a record of a completed process flow then this portal may also be used to display the details of such record.

Refer to [Understanding Process Flows](#) for more information.

Each type of process flow is assumed to be configured with designated custom menu options that allows you to launch a new process flow of that type as well as review saved off and completed records. When reviewing existing process flow records, you are brought to a query portal with options for searching for a specific record. You may **Resume** a saved off but not yet finalized process flow or review a complete one.

The **Process Flow** zone on the portal's **Main** tab page assists the user in completing the process flow as well as displays the information captured on a completed process flow.

Fixed Pages

There are some pages in the system that are built using a fixed page metaphor. All user interfaces implemented in this way function in a similar manner. This section describes functionality to these types of pages.

NOTE: Not all pages in the application use this metaphor. The preferred metaphor for pages in the system is to use portal-based pages. For more information see [Common Base Portals and Zones](#).

Maintenance Pages

Maintenance pages are used to maintain (add, change, etc.) the information in the system using a fixed page metaphor. This section focuses on functionality common to all maintenance pages using this metaphor.

The Unique Identifier Area

Every object in the system must have a unique identifier. For some objects, typically administrative or control table data, the unique identifier is defined by the user creating the record. Other objects, typically master or transaction entities, the unique identifier is assigned by the system after the record is saved.

Where the identifier is displayed depends upon whether the ID is user-defined or system generated.

Pages displaying objects with a user defined identifier (such as To Do Type) typically display the identifier on the left along with a search button. For master and transaction tables, (such as To Do Entry) the unique identifier is typically found in the upper right corner of the screen along with a search button and is labeled as the entity's ID. In this case, if there is an information string associated with the object, it is displayed on the left.

If the object being maintained has an associated context menu, a [Context Menu Button](#) is displayed appear.

Confirmation & Error Messages

Whenever a database modification action is requested, the system first validates the data to be put on the database.

First, the system validates the information. If there are errors, the first error encountered is displayed in a window. In addition to the error message, the error window also contains the error number and the identities of the programs that detected the error. If you don't understand an error and you have to call product support, please supply them with this information.

If there are no errors, the system is modified.

Warning If Unsaved Changes Exist

If you make any changes to an object and you don't commit these changes to the database, the following warning appears: "You have unsaved changes that will be lost if you continue. Press OK to continue anyway."

If you want to commit the changes, click **Cancel**. You will then return to the page and can make further changes or press Save. If you want to discard your changes and transfer to the new page, click **OK**.

CAUTION: This warning is not displayed if you are working on a *new* object on a fixed page and you navigate to a different page. Information about new objects is preserved in memory in anticipation of your return to the page. For example, if you are in the middle of adding a new user and you want to quickly reference information on a different page, you will not receive the above warning because your information will be saved. If you use the back button to return to the user page, all of the information you were adding will be present and you can enter the rest of the new user's data.

Query Pages

Query pages are used to display record sets in the system. Most query pages function in a similar manner. This section focuses on functionality common to all of the system's query pages.

The Search Area

The upper right corner of the screen is almost always the identifier of the object associated with the search. In Oracle Utilities Customer Care and Billing for example, the unique identifier on the Account Financial History page is the Account ID.

To the right of the unique identifier is a [Search button](#). This button is used to search for a different object than the one whose data is being displayed in the page.

If the object being displayed has an associated context menu, a [Context Menu Button](#) is displayed.

User Preferences

The Preferences (or My Preferences) transaction and the User Maintenance transactions are the same except that with My Preferences, only the following items can be modified:

- Main Tab
 - Language
 - Display Profile
 - Time Zone
 - Email Address
 - Dashboard Width
 - Dashboard Location
 - Dashboard State
 - Home Page
 - To Do Summary Age Bar Parameters
- Bookmarks
 - All information can be modified
- Portal Preferences
 - All information can be modified
- Favorite Links
 - All information can be modified
- Favorite Scripts

- All information can be modified

User - Main

This page lets you view or define user information and access settings.

To open the page, use one of the following navigation options:

- The **Admin > Security > User > Search** menu item.
- The **Menu > My Preferences** menu item.
- The **User Menu > Preferences** menu item in the application toolbar.

Note that some fields are only modifiable when the page is opened from the from the **Admin** menu.

Description of Page

Basic user identification information is viewed or set in the **First Name**, **Last Name**, **User ID**, and **Login ID** fields, all of which are modifiable only when the page is opened from the **Admin** menu. User and logon IDs must be unique. The Login ID is the ID that the user uses to log in to the system. The User ID is the ID that is used throughout the application when users are assigned to tasks or when the user ID is stamped on records when logging add or update actions.

Language defines the language in which the user's screen prompts and messages appear.

Set **User Enable** to allow the user to access the system.

NOTE: This field, available only when the page is accessed through the **Admin** menu, provides special field-level security. A user can change the field only if the **Enable/Disable** access mode is set.

Display Profile defines the [display options](#) for the user.

The next group of fields is used to view or set user preferences. For example, you can set up [portal preferences](#) on a "template user" and indicate that specified users will inherit their portal preferences from the template. Doing so provides consistency in the application of account information and dashboard zones. This fields are modifiable only when the page is accessed through the **Admin** menu.

- Set **User Type** to **Template User** if the user's preferences are to match those of other users.
- If a user's [portal preferences](#) are to be inherited from a "template user", use the **Portals Profile User** to define the user ID of the template user. If applied, the specified user will inherit portal preferences from the **Portals Profile User** and will be unable to customize those preferences.
- If a user's [favorite links](#) are to be inherited from a "template user", use the **Favorites Profile User** to define the user ID of the template user. If applied, the specified user will inherit favorites preferences from the **Favorites Profile User** and will be unable to customize those preferences.

The **Time Zone** associated with the user may be defined. Implementations may use this information for features and functions where the user's time zone impacts display of data. Refer to [Designing Time Zones](#) for more information about the use of time zones.

Email Address captures the user's email address.

Dashboard Width defines the number of pixels to use for the user's [dashboard](#) area. A setting of 250 is recommended as a minimum. Depending on the width of a user's monitor, a higher setting (such as 250) will display more information without compromising the space on the main area of the application. Setting the value to 0 will suppress the dashboard. The width setting is updated in background to retain the value based on dynamic sizing.

Dashboard Location governs whether the dashboard appears before or after the main page area. If no value is specified, the default position of the dashboard is after the main page area.

Dashboard State indicates whether the dashboard is open or closed. The state is updated in background to retain the value based on dynamic opening or closing of the dashboard.

Home Page defines the page that appears when the user starts a session or clicks the [Home](#) link.

The To Do entry fields control how To Do entries are aged in respect of the "age bars" that appear on [To Do Summary](#), [To Do Supervisor Summary](#) and the [To Do Summary Dashboard Zone](#).

- Use **Lower Age Limit for Yellow Bar** to define the number of days old a To Do entry must be to be considered "yellow" in the age bar. To Do entries below this limit are considered "green" in the age bar.
- Use **Upper Age Limit for Yellow Bar** is the high limit for the "yellow" bar. To Do entries older than this are considered "red" in the age bar.

The **User Group** collection defines the group(s) with which the user is associated and the date (if any) when the user's association expires. This feature is modifiable only when the page is accessed through the **Admin** menu. For more information, see [The Big Picture Of Application Security](#). Assignments of users in a user group can also be established or maintained through the [User Group - Users](#) page.

NOTE: The ability to maintain the user groups on this page requires special field-level security. A user can change the field only if the **System Administration** access mode is set.

If your implementation has configured [Object Erasure](#) for the User maintenance object, the **Object Erasure Schedule** dashboard zone is visible displaying the erasure status for this user record, if applicable. Refer to [Erasing User Information by Obfuscation](#) for more information on object erasure for User records.

User - To Do Roles

Open the User page and then navigate to the **To Do Roles** tab to define the To Do roles assigned to the user.

The information on this page cannot be modified if accessed through **My Preferences**.

FASTPATH: A user's To Do roles control the types of **To Do** entries the user can access. For additional information on To Do roles, see [To Do Entries Reference A Role](#).

Description of Page

The grid contains the user's To Do roles. To modify a To Do role linked to the user, simply move to a field and change its value. To remove a To Do role, click the - (minus) button. To add a new To Do role, click the + (plus) button and enter the role.

Where Used

Every **To Do** entry references a role. A To Do role has one or more users (and a user may belong to many To Do roles). Users who are part of the To Do role assigned to a To Do entry may work on the To Do entry. For more information on this feature, see [The Big Picture Of To Do Lists](#).

User - Access Security

Open the User page and then navigate to the **Access Security** tab to define a user's security rights. You cannot modify this page if you accessed it through **My Preferences**.

FASTPATH: Refer to [The Big Picture of Application Security](#) for more information about data access roles and access groups.

Description of Page

Use the **Default Access Group** to define the access group that is defaulted on new records added by this user that are subject to [row security](#).

The scroll area contains the **Data Access Roles** to which this user belongs. A user's data access roles play a part in determining the accounts whose data they can access.

To add additional data access roles to this user, click the + button and specify the following:

Enter the **Data Access Role**. Keep in mind that when you add a **Data Access Role** to a **User**, you are granting this user access to all of the accounts linked to the data access role's access groups.

Use **Expiration Date** to define when the user's membership in this data access role expires.

NOTE: You can also use [Data Access Role - Main](#) to maintain a data access role's users.

The tree highlights the **Access Groups** to which the above **Data Access Roles** provide access.

User - Bookmarks

This page is used to manage a user's bookmarks that are created when a user clicks the [Bookmark](#) button and saves a bookmark. From this page the user can delete a bookmark, change the name of the bookmark or change the sort sequence.

Open the User page and then navigate to the **Bookmarks** tab to modify or delete a bookmark.

Description of Page

Sequence is the sort sequence associated with the bookmark. Bookmarks with the same sequence are then sorted alphabetically.

Name is the user-defined name assigned to the bookmark. This is the text that is visible in the [Bookmarks](#) dashboard zone.

NOTE: Favorite Links vs. Bookmarks. Favorite links are configured through the user page and define pages that a user can navigate to. They do not define context (although some pages may use information currently in global context when navigating). Some users may not be allowed to configure their own favorite links and would see the favorite links associated with a profile user. Bookmarks are created using a bookmark button available on each page. The bookmark saves navigation information, context information and also captures some information about the state of a page. Bookmarks are not governed by any user profile configuration.

User - Portal Preferences

The base product contains several [portals](#) that allow users to customize them via portal preferences. Portal preferences allow users to control:

- Which zones appear on the portal
- The order in which the zones appear
- Whether the zones should be "collapsed" (i.e., minimized) when the portal opens.

NOTE: You may not be able to change your portal preferences. If a note appears immediately before the list of portals, a system administrator has configured your user ID to reference a **Portals Profile User** (this is defined on the **Main** tab). Preferences set in this way cannot be modified. System administrators do this in order to enforce a common look-and-feel throughout the user community.

Open the User page and then navigate to the **Portal Preferences** tab to modify a user's preferences.

Description of Page

The [accordion](#) contains a row for every portal configured to show on user preferences and to which you have access. To change how a portal's zones appear, expand the respective row and change the elements accordingly. The remainder of this section describes how you can configure how a portal's zones appear.

Zone lists all of the [zones](#) in the portal.

Place a check under **Display** if the zone should be displayed on the portal.

Place a check under **Initially Collapsed** if the zone should be minimized when the portal is initially opened. Setting zones as initially collapsed is a good idea to save space and to help pages to load more quickly. Refer to [Zones May Appear Collapsed When A Page Opens](#) for more information.

CAUTION: Recommendation. It is recommended that you set your preferences to collapse zones that you don't use often. This is because the system doesn't perform the processing necessary to build collapsed zones until you ask to expand a zone. Opening a page with zones collapsed accelerates the response times of portal.

Use **Sequence** to control the position of the zone in respect of the other zones. This field is disabled if **Display** is not checked. Duplicate **Sequence** numbers are allowed.

For zones displaying data that is changing often, use **Refresh Seconds** to define in seconds how often the zone is refreshed. The minimum valid value is 15. The maximum valid value is 3600 (1 hour). A value of 0 indicates no automatic refresh.

Security Access indicates whether the user has access rights to a zone. Refer to [Granting Access To Zones](#) for more information.

User - Favorite Links

This page is used to define a user's favorite transactions and URLs. Each such link appears as an entry in the [Favorite Links Zone](#) in the [Dashboard](#) area.

NOTE: A hot key can be used to execute a favorite link. Rather than clicking a button in the favorite links zone, you can invoke your first nine favorite links by pressing `Ctrl + a number` (where the number corresponds with the relative position of the transaction in your list of favorites). Note that the numeric keypad on your keyboard cannot be used to implement this function.

Open the User page and then navigate to the **Favorite Links** tab to modify a user's favorite links.

Description of Page

NOTE: You may not be able to change your favorite links. If a **Note** appears beneath your **User ID**, your user id has been setup to reference a specific **Favorites Profile User** as defined on the **Main** tab. If a system administrator has setup your user ID in this way, your preferences may not be changed. System administrators may apply this feature in order to enforce a common look-and-feel throughout the user community.

Each row references a [Navigation Option](#). The navigation options supplied with the base package correspond with the system's menu items. This means you can setup a favorite link to open any transaction in the system (in either **add** or **update** mode).

NOTE: Favorite links can point to other places. The navigation options supplied with the base package always open a transaction's **Main** tab. If you find yourself continually accessing a different tab page, you can have your implementation team create a new navigation option that references the desired tab page. Once this navigation option is set up, you can reference it as one of your favorite links. In addition, it's also possible for your implementation team to setup navigation options that open a URL outside of the system. For example, your implementation team could setup a navigation option to a credit rating company's website. Once this navigation option is set up, you can reference it as one of your favorite links.

Use a **Sequence** to control the order in which the navigation option appears in the [Favorite Links Zone](#).

Security Access indicates if you have been given security rights to the respective transaction. Refer to [The Big Picture Of Application Security](#) for more information.

NOTE: Favorite Links vs. Bookmarks. Favorite links are configured through the user page and define pages that a user can navigate to. They do not define context (although some pages may use information currently in global context when navigating). Some users may not be allowed to configure their own favorite links and would see the favorite links associated with a profile user. Bookmarks are created using a bookmark button available on each page. The bookmark saves navigation information, context information and also captures some information about the state of a page. Bookmarks are not governed by any user profile configuration.

User - Favorite Scripts

This page is used to define a user's favorite scripts. Each script is displayed in the **Favorite Scripts** zone on the **Dashboard** portal where it can be used to [initiate a script](#).

NOTE: A hot key can be used to execute a favorite script. Rather than selecting a script from the business process assistant, you can invoke your first nine favorite scripts by pressing `Ctrl + Shift + a number` (where the number corresponds with the relative position of the script in your list of favorites). Note that the numeric keypad on your keyboard cannot be used to implement this function.

Open the User page and then navigate to the **Favorite Scripts** tab to modify a user's Favorite Scripts.

Description of Page

NOTE: You may not be able to change your favorite scripts. If a **Note** is displayed on top of the grid, your user id has been setup to reference a specific **Favorites Profile User** as defined on the **Main** tab. If a system administrator has setup your user ID in this way, your preferences may not be changed. System administrators may apply this feature in order to enforce a common look-and-feel throughout the user community.

Each row in the grid contains one of your favorite **Scripts**.

Use the **Sort Sequence** to control the order in which the scripts appear in the [business process assistant menu](#).

Security Access indicates whether you have access to the script's application service. Refer to [The Big Picture Of Application Security](#) for more information.

User - Characteristics

Select **Admin > Security > User > Search** and navigate to the **Characteristics** tab to define characteristic values for the user. You cannot modify this page if you accessed it through My Preferences.

Description of Page

Use the characteristics grid to capture additional information about the user.

You can only choose **Characteristic Types** defined as permissible for the user record. Refer to [Setting Up Characteristic Types & Their Values](#) for more information.

Enter a valid **Characteristic Value** for the selected characteristic type. You may enter more than one characteristic row for the same characteristic type, each associated with a unique **Sequence** number. If not specified, the system defaults it to the next sequence number for the characteristic type.

User - Miscellaneous

Select **Admin > Security > User > Search** and navigate to the **Miscellaneous** tab to view additional information associated with a user.

User Id, First Name and Last Name are displayed. Depending on your implementation, additional zones may appear on the User Portal

If additional zones appear, use the embedded help for information about the fields managed on the zone.

Initiating Scripts

Your implementation team can set up business process assistant (BPA) [scripts](#) to walk you through business processes. Once scripts have been set up, you can initiate a script using any of the following methods:

- You can define a list of your "favorite scripts" on your [user preferences](#). You can then invoke any of the scripts from the Favorite Scripts zone on the dashboard portal. You can also invoke any of your first 9 favorites by pressing `Ctrl + Shift + a number` (where the number corresponds with the relative position of the script in your list of favorites). For example, if you press `Ctrl+Shift+2` and you've setup your "favorite scripts" to be **Start Autopay** and **Stop sending marketing information**; the **Stop receiving marketing information** script is invoked. Note that the numeric keypad on your keyboard cannot be used to implement this function.
- You can configure a menu item to launch a script by referencing a [navigation option](#) that is a **script** navigation option type.
- The system creates [To Do entries](#) to highlight tasks that require attention (e.g., bills in errors, accounts without bill cycles, etc.). Users can complete many of these tasks without assistance. However, you can set up the system to automatically launch a script when a user selects a To Do entry. For example, consider a To Do entry that highlights a bill that's in error due to an invalid mailing address. You can set up the system to execute a script when this To Do entry is selected. This script might prompt the user to first correct the customer's default mailing address and then re-complete the bill. Refer to [Executing A Script When A To Do Is Launched](#) for more information.
- You can indicate that a script should be [launched upon entering the system](#). This functionality enables an external system to launch the system and immediately launch a script.
- The following [hot keys](#) cause an interactive menu is displayed:
 - `Ctrl+Alt+Q`
 - `Ctrl+Shift+S`

Description	Eligible
Account Sync on CS Req Account page	Eligible
Accounting Calendar Maintenance	Eligible
Activity Asset Completion Action	Eligible
Activity Resource Requirement - Add User Log Entry	Eligible
Add Crew Type Resources	Eligible

The menu allows you to search for a script using any word in its description. Note, if you've turned on **Search only Eligible Scripts**, your search is limited to [eligible scripts](#). Note, the system displays an indication if each script in the grid is **Eligible** or **Ineligible** in this section.

You can initiate a script from this area by clicking on it.

When a script is initiated, this menu closes and the [object display area](#) shifts down to make room for the script area.

NOTE: Securing scripts. Only scripts the user is allowed to execute are displayed. Refer to [Securing Script Execution](#) for more information.

NOTE: Customize the script area. Using the [Height](#) step type, an individual script may be configured to use more or less of the script area than the standard script area. It is also possible to configure a script to hide the script area altogether.

The information in the script area takes you through the steps in the selected business process (note, your implementation team controls the information that appears in the script area).

The following points highlight useful information common to all scripts:

- **Return focus to script area.** Often during a script the focus moves from the script area to another section of the page. For example, you might be required to fill in data for a new record being added. When you are ready to return to the script area, rather than using the mouse to return to the area, you can press `Ctrl+Shift+F`. The focus returns you to either the first available input field or to a "default" button if no input field is available.
- **The Continue button.** Many steps in a script ask you to click the **Continue** button when you're ready to restart a script. For example, a step may ask you to confirm a customer's automatic payment information and then click **Continue** when you're ready for the script to restart. Rather than using the mouse to click this button, you can press `Ctrl+Shift+C`.
- **Selected button changes color.** When you click a button in the script area, the button selected changes color so that you can easily see which option you selected.

FASTPATH: Refer to [The Big Picture Of Scripts](#) for more information about scripts.

NOTE: You can abort a script at any time by clicking the red X button in the upper right corner of the script area (or by pressing `Ctrl+Shift+X`).

Shortcut Key Summary

The following table summarizes the keyboard shortcuts (hot keys) available in the system:

NOTE: It is possible that your specific product supports additional shortcut keys. Refer to your product documentation for more information.

NOTE: It is possible that some of the following system accelerator keys may duplicate shortcuts, or hot keys, that are predefined within your browser. If this is the case, the browser's functionality commonly takes precedence.

NOTE: It is possible that your implementation uses one of the accelerator keys listed below for a different purpose. For example, in some languages, a shortcut key may be used for a special character in the alphabet not included on all keyboards. It is possible to turn off any of the `Alt+letter` shortcuts and `Ctrl+Alt+letter` shortcuts listed below using a properties file entry. The property is `ouaf.shortcut.ignore.altKeys=` where one or more letters may be entered separated by a comma. When setting this property, the system automatically enables a 'potential alternate key' for certain functions (see the table below). Refer to the *Server Administration Guide* for more information about the property.

Accelerator Key	Potential Alternate Key (see Note above)	Function
<code>Ctrl+Alt+A</code>		Opens the Admin Menu .
<code>Alt+B</code>		Returns to the previous page on which you were working. This is the equivalent of clicking the Back arrow.

Accelerator Key	Potential Alternate Key (see Note above)	Function
Ctrl+Alt+B		Launches the Bookmark dialog. This is the equivalent of clicking the Bookmark button.
Alt+C, Ctrl+Alt+C, Alt+Shift+C		Clears the currently displayed object from the page. This is the equivalent of clicking the Clear button.
Ctrl+Shift+C		If the current step in the Script area has a Continue button, this shortcut is equivalent to clicking Continue .
Ctrl+Alt+D, Alt+D		Creates a duplicate of the object being displayed. Equivalent to clicking the Duplicate button.
Ctrl+Alt+F		Positions the user's cursor to the Search input field.
Ctrl+Shift+F		If the Script area is open and you are working on a different area of the page, this key returns focus to the script area. Focus returns to either the first available input field or to a "default" button if no input field is available.
Alt+G		Returns to the most recent page that was displayed when the Back arrow was clicked. Equivalent to clicking the Forward arrow.
Ctrl+Alt+H		Opens a dropdown list of recently-visited pages, the equivalent of clicking the History icon.
Alt+J		Minimizes the dashboard . It also expands the dashboard, if it was minimized.
Alt+K		Transfers you to To Do Entry - Main for the current item in the To Do list. Pressing Alt+K while on this page takes you to the first To Do entry on the list.
Ctrl+Alt+L		Logs the user out of the system. This is equivalent to clicking the Logout menu item.
Ctrl+Alt+M		Opens the Menu .
Alt+N	Alt+Shift+N	Displays the next entry in the search results. Equivalent to clicking Next Item .
Alt+O	Alt+Shift+O	Navigates to the user's home page. Equivalent to clicking the Home icon.
Ctrl+Alt+P		Opens your User Preferences page. Equivalent to clicking the Preferences menu item.
Alt+P		Displays the previous entry in the search results. Equivalent to clicking Previous Item .
Ctrl+Alt+Q		Opens the business process assistant , where you can select a script that walks you through a business process.
Alt+R Ctrl+Alt+R		Refreshes the page with the last saved version of the object being displayed in the page. Equivalent to clicking the Refresh button.
Alt+S	Alt+Shift+S	Saves any changes that you've made on the database. Equivalent to clicking the Save button.
Ctrl+Shift+S		Opens the business process assistant , where you can select a script that walks you through a business process.
Alt+X	Alt+Shift+X	Opens the To Do Summary .
Ctrl+Shift+X, Ctrl+Shift+Z		If the Script area is open, equivalent to clicking the Close button in the script area. If a pop-up window is open, this closes the window.

Accelerator Key	Potential Alternate Key (see Note above)	Function
Alt+Y		Displays the previous item in the To Do list. Equivalent to clicking the Previous button in the Current To Do zone.
Alt+Z	Alt+Shift+Z	Displays the next item in the To Do list. Equivalent to clicking the Next button in the Current To Do zone.
Alt+Insert		Inserts a new row into an editable grid if the insertion point is in the grid. Equivalent to clicking the Insert button.
Alt+Delete		Removes a row from an editable grid if the insertion point is in the grid. Equivalent to clicking the Delete button.
Alt+[Navigates to the next main page component area of the application. Refer to Page Components for the list of the main page components. Using Shift+Alt+[reverses the sequence of navigation.
Alt+]		Navigates to the next zone . When you are on a portal with zones, this key brings you to the next zone in the portal. If you are on the last zone in the portal, the key brings you to the first zone on the dashboard, if visible. Keying through all the zones on the dashboard brings you to the first zone on the portal displayed in the main area. If the page displayed is a fixed page rather than a portal, this key will only navigate within the dashboard. Using Shift+Alt+] brings you to the previous zone.
Alt+F1		Invokes online Help for the application. Equivalent to clicking the Help entry in the Help menu.
Alt+1 ...Alt+9, Alt+0		These keys are only applicable when a page / portal with multiple tabs is open. The shortcuts open the tab page whose relative position corresponds with the shortcut number. For example, if you press Alt+3 on a page with multiple tabs, the third tab is displayed. Alt+0 navigates to the 10th tab. If there are more than ten tabs on a page, you must use the mouse or F2/Shift+F2 to display additional tabs. Note that you cannot use the numeric keypad for these shortcuts.
Ctrl+1 ...Ctrl+9		Invokes the favorite link whose relative position corresponds with the shortcut number. For example, if you press Ctrl+3, the transaction for your third "favorite link" is invoked. Note that you cannot use the numeric keypad for these shortcuts.
Ctrl+Shift+1 ... Ctrl+Shift+9		Invokes the favorite script whose relative position corresponds with the shortcut number. For example, pressing Ctrl+Shift+2 selects the second of your "favorite scripts". The numeric keypad cannot be used for these shortcuts.
Alt+left arrow		Populates a scroll area with the previous entry. Equivalent to clicking the scroll control  .
Alt+right arrow		Populates a scroll area with the next entry. Equivalent to clicking the scroll control  .
Enter when in a field with an adjacent Search button		Invokes the search. Equivalent to clicking the Search Button .

Accelerator Key	Potential Alternate Key (see Note above)	Function
Enter when a row in a search result grid is highlighted		Selects the item and closes the search. Note that after selecting an item from the search results, you can press Alt+N or Alt+P to scroll up or down through other items in the result grid without returning to the search results.
Enter when a menu item is highlighted		Selects the menu item.
Enter when the insertion point is within a tree node		Equivalent to clicking on the item in the tree: <ul style="list-style-type: none"> • If the insertion point is on a node image, the node is either expanded or collapsed, dependant on its current state. • If the insertion point is on a context menu, the context menu is opened and normal menu processing applies. • If the insertion point is on a "link" element, normal navigation processing occurs.
Tab when a row in a search result is highlighted		Highlights the next row.
Shift + Tab when a row in a search result is highlighted		Highlights the previous row.
Space when the insertion point is on a button		Equivalent to pressing the button.
Space when the insertion point is in a date/time field		Opens the date/time selection window.
Space when the insertion point is in a check box		Toggles the check box between checked and unchecked.
Page Up while in a list grid		Scrolls the contents of the list grid up approximately one page.
Page Down while in a list grid		Scrolls the contents of the list grid down approximately one page.
Up or Down Arrow when in a dropdown list		Moves to the next or previous value in the list. You can also press a letter key to locate the next value starting with that letter.
Up or Down Arrow keys when in search results		Highlights the next/previous row in search results.
Up, Down, Left or Right Arrow when using a menu		Highlights other menu items.
Esc when using a menu		Closes the menu.
Alt+F2		Opens the next tab page when viewing a page / portal with multiple tabs.
Shift+Alt+F2		Opens the previous tab page when viewing a page / portal with multiple tabs.

Customer Information

We use the term **customer information** to reference the demographic, geographic, and financial objects that form the core of your CIS system. In this section, we describe how to maintain these objects.

Understanding The V

The "V" is the shape of a diagram we use to illustrate the objects that form the core of the system: **Person, Account, Premise, Service Agreement, and Service Point**. These objects hold demographic, geographic, and financial information

about your company's customers and properties. The following diagram illustrates the objects in the "V", as well as important objects related to the "V" objects (**bill, payment, meter, field activity, meter read**).

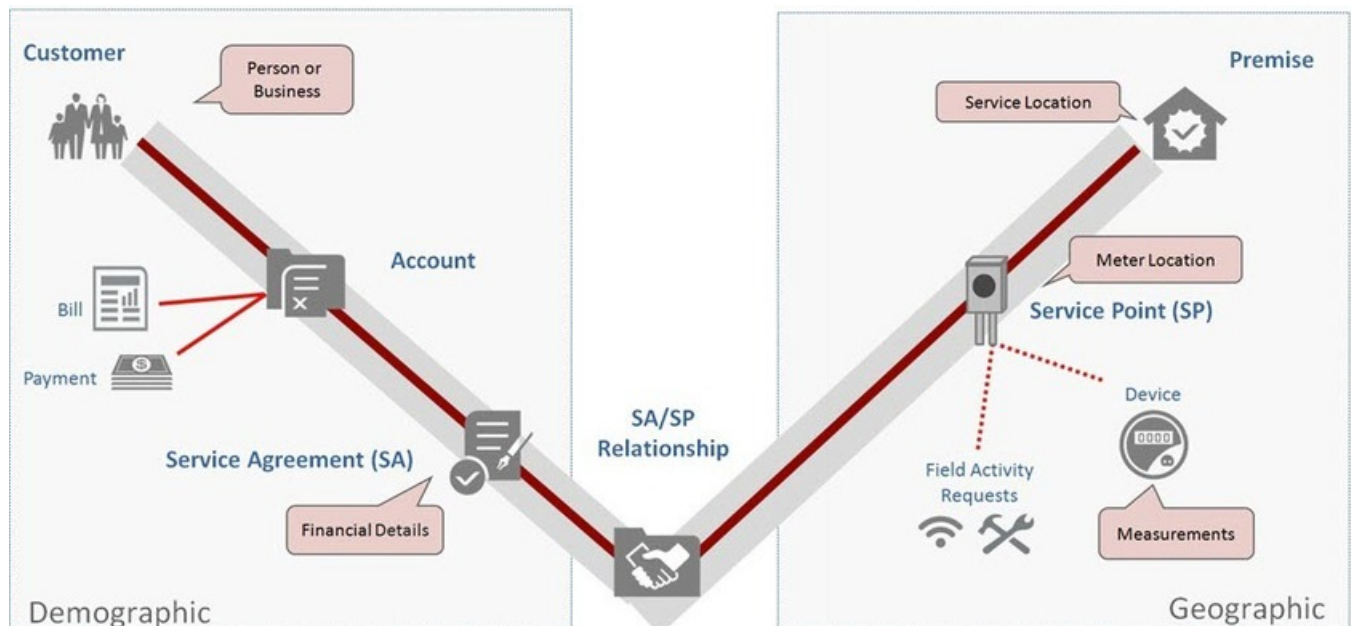

You must intuitively understand the concepts embodied in the "V" before you can perform the business processes in the system. In this section, we provide an overview of these objects. In later sections, we describe how you maintain this information.

Persons

A person exists for every individual or business with which your company has contact. Besides customers, persons exist for landlords, contractors, accountants at corporate customers, third party guarantors, energy distributors, collection agencies, etc.

On a person is maintained demographic information like Name, Mailing Address, Phone Numbers, Email Address, and Life Support Details.

Most persons are linked to at least one [account](#) because, without an account, the person cannot receive a bill. There are rare examples of persons without accounts; for example, collection agencies that don't receive bills, and parent companies that receive statements (as opposed to bills).

FASTPATH:

Refer to [Maintaining Persons](#) for more information about persons.

Accounts

Accounts are the entities for which bills are created. You must create at least one account for every customer. The account contains information that controls when bills are created and how they are formatted.

Every account must reference at least one [person](#) because the person contains the customer's demographic information (e.g., names, phone numbers, forms of ID). We refer to this individual as the "main" person linked to the account. In addition to the "main" person, an account may reference other types of persons, e.g., the billing contact, the third party guarantor of the account's debt, persons who receive copies of bills, etc.

Most accounts are linked to at least one [service agreement](#) because, without a service agreement, there is nothing on which a bill can be based. An account without a service agreement may exist; you just won't be able to do much in the system with such an account.

FASTPATH:

Refer to [Maintaining Accounts](#) for more information about accounts.

Service Agreements (SAs)

Think of a service agreement as a contract between your company and a customer. The service agreement contains the terms and conditions controlling how the system calculates charges for the specific service supplied to the customer.

Every [account](#) should have at least one service agreement (otherwise, the account has no financial obligations with your company). There is no limit to the number of service agreements that may be linked to an account. However, most residential customers have X service agreements where X is the number of services sold by your company. For example, if your company sells both electricity and gas, most accounts will have two service agreements.

A separate service agreement is required for every service supplied to every account. Why? Because a variety of fields may differ for each service agreement:

- Obviously, the price of the service is different.
- The credit and collection criteria may be different.
- The general ledger account to which the resultant revenue and/or receivable are linked is different.
- The sales tax could be different for each good / service / location.
- The service point measuring consumption will frequently be different.
- The list goes on...

Service agreements that bill for premise-based services are linked to one or more [premises](#) via their [service points](#). When you link a service point to a service agreement, you are telling the system that the service agreement's account will pay for the service point's service.

FASTPATH:

Refer to [Maintaining Service Agreements](#) for more information.

Premises

A premise is created for every location to which your company supplies service. On a premise is maintained geographic information like:

- The address.
- Characteristics that determine tax jurisdictions.
- Descriptions of unusual situations associated with a property.
- The list goes on...

Most premises have at least one [service point](#) because, without a service point, there are no services supplied to the premise. A premise without service points may exist; you just won't be able to do much in the system with such a premise.

FASTPATH:

Refer to [Maintaining Premises](#) for more information about premises.

Service Points (SPs)

Think of a service point as a specific location at a premise where your company supplies service. A service point contains information describing the type of service and how it is measured.

A [premise](#) should have at least one service point (otherwise, there are no services supplied to the premise). However, it is permissible for a new premise to exist without service points until you are ready to physically start service at the premise.

A premise may have many service points. However, most residential premises have X service points where X is the number of services sold by your company. For example, if your company sells both electricity and gas, most of your premises will have two service points.

Separate service points are required for every service supplied to a premise. Why? Because a variety of fields may differ for each service point:

- Basic information about the Service Point, including time zone, market, parent Service Point (if applicable), and status.
- Information related to field work that is performed at the current Service Point, including applicable warnings or instructions.
- The measurement cycle, route, and route sequence for the Service Point.
- Basic characteristics about the service; for example, pipe size, take point, and amperes.

When you link a service point to a [service agreement](#), you are telling the system that the service agreement's account will pay for the service point's service.

The following topics describe the relationship between a service point and the physical devices that may be installed at the service point.

Metered versus Item-Based versus Non-Badged Service Points

There are three major categories of service points:

- Those where consumption is measured (e.g., electricity, gas, water) by a meter. We refer to these types of service points as **metered**. A metered service point may have zero or one meter installed at any instant in time. Over time, a metered service point may have many meters installed and removed.
- Those where consumption is not measured, but where there exists some type of badged (i.e., uniquely identified) item that impacts billing and dispatching (e.g., streetlights, a security camera). We refer to these types of service points as **item-based**. An item-based service point may have zero or one badged item installed at any instant in time. Over time, an item-based service point may have many badged items installed and removed.
- Those where one or more non-badged items (i.e., items without a unique identity) that have some impact on billing or dispatching exist. We refer to these types of service points as **unbadged**. At a single instant in time, a non-badged service point may have many unbadged items installed at it. Refer to [Service Points With Multiple Items](#) for an illustration of such a service point.

NOTE:

Multiple unbadged items can also be defined on metered and item-based service points. Under some billing scenarios, you may define non-badged items on a metered or item-based service point. For example, assume you have an item-based service point that exists to support lamp service. Also assume that the rate for lamp service is based on the type of lamp and the number of feet of electric wire between the pole and the power source. To define the number

of feet of wire, you could create a non-badged item type called WIREFEET and indicate the number of feet on the item-based service point. On this service point, you can also keep track of the specific lamp that's installed.

Service Points With Multiple Items

An example will help explain a single service point with multiple non-badged items. Assume you have a parking lot with 4 lights, none of which are badged.

A Premise With One Service Point Where The Service Point Has Multiple Items

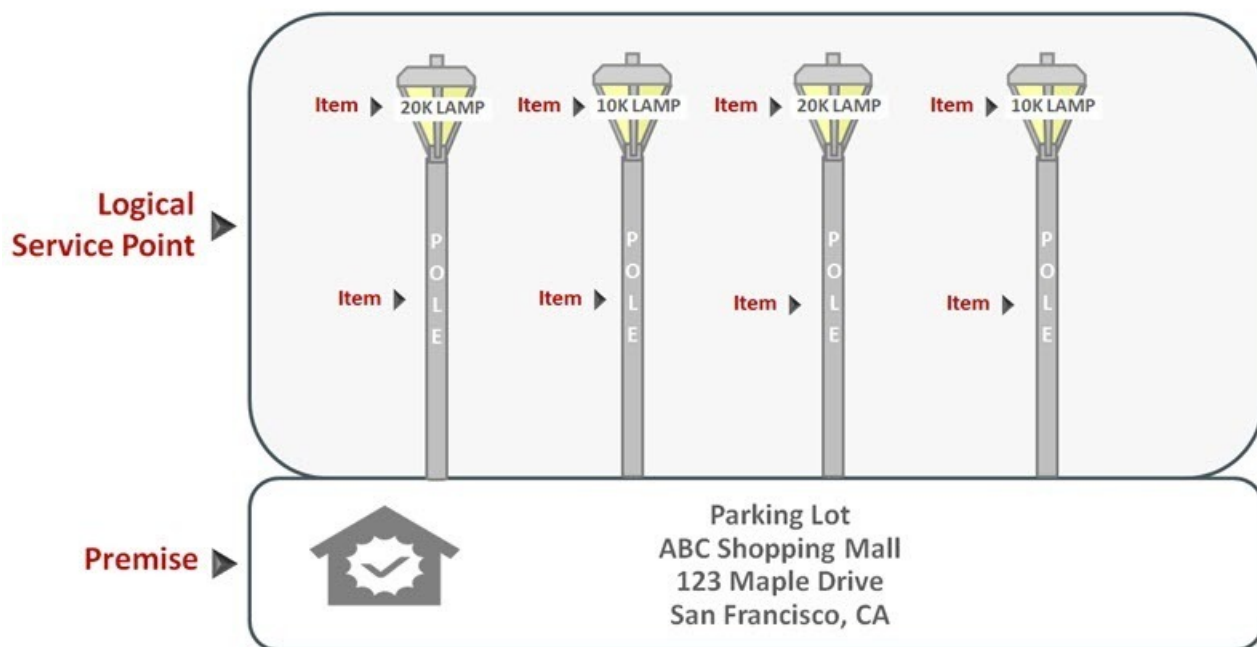

You can set up the above example with one premise with a single non-badged service point. On the service point, you create one item for each type of item in the parking lot:

- 20K lumen lamp
- 10K lumen lamp
- pole

For each type of item, you indicate the quantity that exist in the parking lot:

- 20K lumen lamp - 2
- 10K lumen lamp - 2
- pole - 4

Putting It All Together

To help you understand the significance of the "V", consider a few scenarios:

- When a new residential customer starts service, you create both person and account objects for the new customer. In addition, you also create service agreements and link them to the appropriate service points. You won't have to create a new premise and service points because the customer is probably moving into an existing house.
- If the residential customer moves within your service territory, you don't have to set up new person or account objects. You also don't have to set up new premise and service point objects if the customer is moving into an existing house. You only have to create new service agreements and link them to the appropriate service points (and the system does most of the service agreement set up processes for you).
- A business with a single location uses the same "V" objects as does a residential customer. If the business expands and starts using services at other locations, you simply link new service agreements to the existing account. You don't have to redefine person or account information.

NOTE:

Bottom line. A person and an account are needed for every customer. After these exist, future service requests simply involve stopping existing service agreements and starting new ones. You typically won't have to add or modify premise or service point information unless new locations are built.

FASTPATH:

For more information, refer to [Maintaining The "V"](#), [Navigating The "V" Using Control Central](#), [The Big Picture Of Starting Service](#), and [The Big Picture Of Stopping Service](#).

Sample V For A Residential Customer

The following illustration shows a simple residential customer's "V" objects.

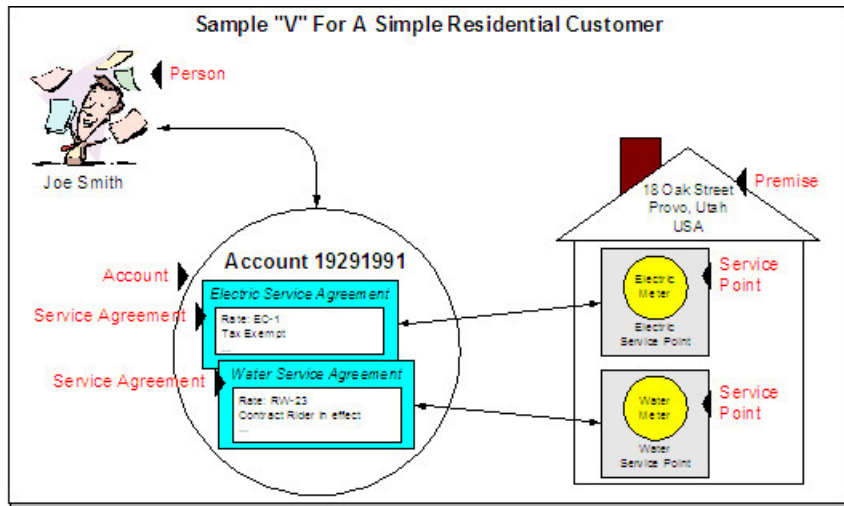

Sample V For A Commercial Customer With Multiple Premises

The following illustration shows the "V" objects for a commercial customer who pays for service at two premises.

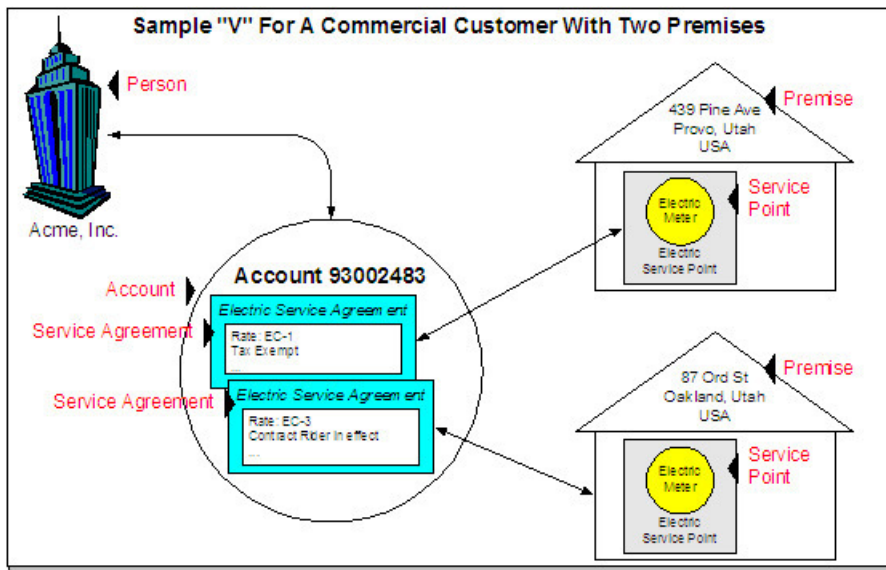

NOTE:

The above example shows a separate service agreement per premise. If your rates allow, you could link both premises to a single service agreement.

How To Set Up Customer Hierarchies

Consider the following customer hierarchy:



The above hierarchy shows a parent company (Michelin Inc) with two subsidiaries. Each subsidiary, in turn, could have their subsidiaries, and these subsidiaries can have their own subsidiaries ...

You must set up a person for every individual and business in a hierarchy. After the basic demographic information is defined, you define each person's children using the [Person to Person](#) page.

NOTE:

A script can be used to set up a hierarchy. The demonstration database contains a [script](#) that guides users through the process of setting up a hierarchy. Please speak to your implementation staff if you'd like to import this script for use in your implementation.

After a hierarchy is set up, the system displays its members in the [Person Tree Zone](#) (this is a zone on the [Customer Information Portal](#)). In addition, if the persons in a hierarchy have accounts, summary information about these accounts is displayed in the [Account Summary Zone](#).

While hierarchies would typically be set up to define parent companies and subsidiaries, you can use this functionality for many other purposes. For example, a customer relationship manager could set up a hierarchy containing their "important" customers. To do this, they'd need to create a "dummy" person for the parent and then link the "important" customers to it. After this hierarchy is set up, the manager could see a summary of these customers in the [Account Summary Zone](#) whenever they display the "dummy" person.

Navigating The V

The product provides two options for Navigating the V:

- Control Central
- Customer 360

Control Central is the name given to the functionality that helps you:

- Find a person.
- Find an account.
- Find a premise.
- View information about a person / account / premise.
- View alerts and messages about a person / account / premise.
- Navigate to pages that contain information related to a person / account / premise.

Customer 360 is an updated and more configurable alternative to Control Central. The Customer 360 functionality works in conjunction with Unified Search, which provides for a more sophisticated, single-box search for customers or premises. Once Unified Search has populated a customer and/or premise, you are brought to the Customer 360 portal to see an overview of the customer.

FASTPATH:

For more information about the relationships between persons, accounts, and premises, see [Understanding The "V"](#).

Control Central

The following sections describe Control Central features.

Control Central - Search

Open **Menu** > **Control Central Search** to find a customer and/or a premise.

Keyboard Shortcut

Alt+L

Alternate Shortcut

Alt+Shift+L

NOTE: Refer to [Shortcut Key Summary](#) for information about the alternate shortcut.

NOTE: Automatic transfer to Control Central — Account Information. You are automatically transferred to [Control Central - Account Information](#) when an account / premise is selected on this page.

The contents of this section describe how to use control central search.

Search Facilities

Control Central allows users to search for a person, account and/or premise using a variety of search criteria.

The following search options are provided in the base product:

- **Name and Address:** searches for an accounts, person and / or premise using a person's name and / or a service address.
- **Account ID:** searches for an account using an Account ID.
- **Person Contact:** searches for accounts / persons using a person contact.
- **Phone Number:** searches for accounts / persons using a phone number.
- **Person ID Type/Value:** searches for accounts / persons using a person identifier.
- **Geo Type/Value:** searches for a premise using the geographic identifier of the premise or of one of its service points.

Refer to each search option's zone help for details on the search criteria.

From the search results lists, you can select a record to navigate to [Control Central - Account Information](#), where information about the customer is displayed. You can also navigate to other pages in Control Central to view more information about the account, person and / or premise.

NOTE:

Automatic transfer to Account Information tab. If your search criteria result in a single customer being retrieved, you are automatically transferred to [Control Central - Account Information](#) with that customer's information displayed.

Meter Search

Control Central does not provide an option to search using a meter ID. If you know the meter's identifier, transfer to [360 Search by Device](#) and search for the meter. Use the hyperlinks to navigate to [360 Degree Views](#), to see more details about the meter and its related measuring component(s) and service point.

Item Search

Control Central does not provide an option to search using an item ID. If you know the item's identifier, transfer to [360 Search by Device](#) and search for the item. Use the hyperlinks to navigate to [360 Degree Views](#), to see more details about the item and its related service point.

Search Options

The **CIS Division** filter can be specified to limit the search to accounts or premises in a particular CIS Division. The matching is done on either the account's CIS Division or the premise's CIS Division depending on whether the search is account-oriented or premise-oriented:

- If searching by only a name, the search results that have an associated account will be matched on the account's CIS Division.
- If searching by a name and any of the address constituents, the search results that have an associated account will be matched on the account's CIS Division.
- If searching by only the address constituents, the search results will be matched on the premise's CIS Division, regardless of whether or not the premise is linked to an account.

The **Show All Premises** search option controls whether you see all of an account's premises in the [search results](#). If turned on, every premise linked to an account is shown in the search results. If turned off, only one premise is shown per account (and this premise is selected at random).

This switch pertains to the following search methods:

- Search by name only (i.e., all address constituents are left blank)
- Search by account ID
- Search by person phone number
- Search by person identifier

This switch does NOT pertain to the following search methods as these are premise-oriented, not account-oriented:

- Search by name when any address constituent is entered
- Search by address constituents only (i.e., name is blank)
- Search by geographic identifier

The benefit of turning this switch off is that an account will be immediately selected when you enter unique account-oriented search criteria. For example, if you specify an **Account ID** and press enter, the system automatically selects the account; you don't have to wait for the search results to be populated with the multitude of premises linked to the account (and then select one of the rows). Please note, an alert highlights if the selected account has other premises.

NOTE:

Default. The first time you open this page, **CIS Division** and **Show All Premises** are defaulted from your [user preferences](#). When you return to this page, the last values are defaulted.

The **Expand Results** search option is available if your implementation has enabled expanded / fuzzy searching. (Refer to [Advanced Search Options](#) for more information.) This functionality relies on special indexes configured in the database, to attempt to include similar words or alternate spellings of a supplied search value. This expanded searching is applied only to searches by name and / or address constituents.

Wild Cards

The control central searches against **Name**, **Address**, and **City** support wild cards. The wild card character is % and represents any number or character. The system always appends a % for you when you use these search methods. Examples will help clarify this functionality:

- If you enter a B, the system searches for B% (and will find all objects that begin with B).
- If you enter B%N, the system searches for B%N%. It will find anything that
 - Starts with a B, and
 - has zero or more other characters followed by an N.
- If you enter %B the system searches for %B%. It will find anything with a B in it, no matter what it starts and ends with.

NOTE:

Certain wildcard searches can result in lengthy response times. If you use the wildcard character to prefix your search criteria (e.g., %San Fran), lengthy response times can result. Why? Because the system will have to look at EVERY customer in the system before it can return the results.

Search Results

The search results at the bottom of the page contain persons, accounts, and premises that match your search criteria. The information displayed in this area differs depending on the type of search you perform. You can perform searches on a customer's name, address, phone number, person contact, person identifier and geographic value.

The information strings that display in the **Person/Account** and **Premise** columns vary depending on what context information is present:

- For a person that is not linked to an account, the Person/Account information string will include the text 'No Account Information' and the Premise column will be blank.
- For an account that does not have a service agreement, the Person/Account information string will include the text 'No Service Agreement' and the Premise column will be blank.
- For an account with a service agreement that is not currently linked to a service point, the Premise column will display 'No Premise Information'.
- For a premise that is not linked to an account, the Person/Account column will display 'No Person Information'.

NOTE:

The first 300 matches are retrieved and displayed. The base search zones are configured with the *Number of Rows to Display* and *Number of Rows to Retrieve for SQL* parameters set to 300. If you do not find the account / person / premise you are looking for in the set of results, refine your search criteria. A *Control Central Search Factor* feature configuration option (in the *General System Configuration* feature type) controls the maximum number of indexed results that will be evaluated by name and/or address before filtering is done. For instance, if the search factor is set to 3000 and a search is for 'Smith%' on '%Main St', the search will get the first 3000 'Smith%' from the name index and the first 3000 '%Main St' from the address 1 index. Then it will filter out non-matching combinations. Regardless of the resulting set, the search will not return more than the Number of Rows to Retrieve for SQL, which is set to 300. The search factor can be set to any number from 301 to 50000. Note that the higher the factor used, the more possibility of affecting performance. If this option is not specified, the default is 3000.

Automatic selection if only one match. You don't have to select a record if there is one and only one object that matches your search criteria. The system automatically selects it and transfers you to [Control Central - Account Information](#).

Use Tab and Enter to select an account / person / premise. You don't have to use the mouse to select a record when multiple matches are returned. The system highlights the first row in the search results. If this is the account / person / premise you are looking for, press **Enter** to select it. If not, press **Tab** until you've highlighted the desired record and then press **Enter** to select it.

Use the Work List dashboard zone to navigate to any account / person in the search results. When you select a record from the search results, you are automatically transferred to [Control Central - Account Information](#). If you want to look at a different account that appeared in the search results, you do not have to return to the **Main** tab. You can use the **Work List** dashboard zone to load another account without leaving the [Control Central - Account Information](#) page. To build the work list, run the search and click on the Work List button that appears in the **Person/Account** column heading. This will copy over the contents of the **Person/Account** column into the **Work List** zone in the dashboard. Refer to [Work Lists](#) for more information.

Control Central - Account Information

Once [Control Central - Search](#) has populated an account, you are brought to the Account Information page to see an overview of the account.

Keyboard Shortcut**Alternate Shortcut**

Alt+I

Alt+Shift+I

NOTE: Refer to [Shortcut Key Summary](#) for information about the alternate shortcut.

The following points should be noted about this page:

- Selecting an account on control central causes the [global context](#) information to be refreshed. Various zones available on this page use the value in the global context to display relevant data for the appropriate account, person and premise.
- This portal page may be configured by the user. Refer to [Each User Can Customize Which Zones Appear](#) for information about how to configure which zones appear.
- The Go To Control Central option on the account context menu navigates to this page.

The contents of this section describe the zones that are available on this portal page.

Account Activity History Zone

The **Account Activity History Zone** is a grid that summarizes a variety of account-related events (in reverse chronological order). Clicking on an information hyperlink transfers you to an appropriate page. The following table lists the type of information that may appear in this zone and the portal to which you will be transferred on click of the information hyperlink.

Activity Label	What Is Displayed	Drill Down Transfers You To
Severance Event. <i>One row is displayed for every Pending and Awaiting Field Activity Completion severance event linked to the account's service agreements.</i>	The severance event's description, status and trigger date (if non-blank). If the event is dependent on earlier events, the earlier events' type and status is appended	Severance Process - Events
Severance Process. <i>One row is displayed for every Inactive severance process linked to the account's service agreements. Inactive processes are displayed (as opposed to active) because active severance processes have pending events and pending events are shown separately.</i>	The severance process's SA type description, severance process template description, status and create date/time	Severance Process - Main
Collection Event. <i>One row is displayed for every Pending collection event linked to the account.</i>	The collection event's description, status and trigger date	Collection Process - Events
Collection Process. <i>One row is displayed for every Inactive collection process linked to the account. Inactive processes are displayed (as opposed to active) because active collection processes have pending events and pending events are shown separately.</i>	The collection process's control, template, status, status reason and create date/time	Collection Process - Main
Overdue Event. <i>One row is displayed for every Pending overdue event linked to the account.</i>	The overdue event's information based on the overdue event type's Event Information algorithm, if configured. Otherwise, default overdue event information.	Overdue Process - Events
Overdue Process. <i>One row is displayed for every Inactive overdue process linked to the</i>	The overdue process's information based on the overdue process template's Overdue	Overdue Process - Main

account. Inactive processes are displayed (as opposed to active) because active overdue processes have pending events and pending events are shown separately.	Process Information algorithm, if configured. Otherwise, default overdue process information.	
Cut Event. One row is displayed for every Pending cut event linked to the account.	The cut event's information based on the cut event type's Event Information algorithm, if configured. Otherwise, default cut event information.	Cut Process - Events
Cut Process. One row is displayed for every Inactive cut process linked to the account. Inactive processes are displayed (as opposed to active) because active cut processes have pending events and pending events are shown separately.	The cut process's information based on the cut process template's Cut Process Information algorithm, if configured. Otherwise, default cut process information.	Cut Process - Main
Write-off Event. One row is displayed for every Pending write-off event linked to the account.	The write-off event description, status and trigger date	Write-off Process - Events
Write-off Process. One row is displayed for every Inactive write-off process linked to the account. Inactive processes are displayed (as opposed to active) because active write-off processes have pending events and pending events are shown separately.	The write-off process template's description, status and create date/time	Write-off Process - Main
Customer Contact. One row is displayed for every customer contact associated with the main customer linked to the account.	The main name of the person associated with the customer contact, the customer contact's class and type, and the customer contact's date	Customer Contact - Main
Field Activity. One row is displayed for every unique non-cancelled field activity linked to the account's non-cancelled/non-closed service agreements.	If the field activity not Canceled, the field activity type is orchestrated by Service Order Management (SOM) and the field activity is synchronized: SOM field activity information, Outbound Communication information. Otherwise, premise information and field activity information (from installation options)	Field Activity - Main
Pay Plan. One row is displayed for every non-cancelled pay plan linked to the account	The pay plan's type, status, date, and amount	Pay Plan - Main
Payment Arrangement. One row is displayed for every non-cancelled payment arrangement (i.e., service agreement with a special role of Payment Arrangement) linked to the account	The service agreement's division, SA type, status, start option (if applicable) and effective period.	Payment Arrangement - Main
Credit Rating History. One row is displayed for every credit rating transaction that affects the account's credit rating	The effect on the account's credit rating, the end date, creation date and the process that created the transaction.	Account - C&C
Cash-Only History. One row is displayed for every credit rating transaction that affects the account's cash-only score	The effect on the account's cash-only score, the end date, creation date and the process that created the transaction.	Account - C&C
Case. One row is displayed for every case associated with the account.	The case's information based on the Case Information algorithm, if configured on installation options. Otherwise, default case information.	Case - Main

Rebate Claim. *One row is displayed for every rebate claim.* The rebate claim's standard information. Rebate Claim

Business Flag. *One row is displayed for every business flag.* The business flag's standard information. Business Flag

WARNING:

The first 25 rows are displayed when this zone is initially built. If more rows exist, a **Next** button appears. If you click this button, the system appends the next set of records.

Account Financial History Zone

The **Account Financial History Zone** lists an account's financial events in reverse chronological order. You can use this grid to both view high-level information about these events and to transfer to the respective page in which an object is maintained.

NOTE:

Approximately a year and half is shown. This zone shows all financial transactions within 20 months of the latest financial transaction. This limitation exists to prevent this zone from becoming unmanageably long.

The following columns are displayed in the grid:

Arrears Date This is the date the event starts aging. This column will be blank if the FT has not started aging yet.

Financial Transaction Type This column indicates the type of financial event: Bill, Payment, Bill Cancellation, Pay Cancellation, Adjustment, and Adjustment (Cancel). If the event is related to an adjustment, the adjustment type's description is displayed instead of "Adjustment".

Current Amount This column shows the financial event's effect on the account's current balance.

Current Balance This column shows the account's current balance after the financial event.

Payoff Amount This column shows the financial event's effect on the account's payoff balance. **Payoff Amount** will be dimmed if it is the same as its **Current Amount**.

Payoff Balance This column shows the account's payoff balance after the financial event. **Payoff Balance** will be dimmed if it is the same as its **Current Balance**.

If you need to see more information about a specific financial transaction, press the go to button to transfer to the respective page in which the information is maintained.

FASTPATH:

For information about current and payoff balance, refer to [Current Amount versus Payoff Amount](#).

WARNING:

The first 25 rows are displayed when this zone is initially built. If more rows exist, a **Get All** button appears. If you click this button, the system retrieves a maximum of 750 rows.

Alert Zone

The **Alert Zone** is a grid that contains messages highlighting a variety of situations. Clicking on the hyperlink transfers you to an appropriate page.

Account alerts are implementation-specific. On [Account - Alerts](#), a user can define account-specific alerts that should be displayed whenever the account is selected. The [Alert Types](#) control table contains the possible alert messages.

Alerts are produced from one of two sources.

- Alerts are primarily produced by plugging in alert algorithms on the [installation record](#). The alerts are shown based on the configured sequence on the installation record. Refer to Count Customer Contacts of a Given Type (CC-NBR-VALID) and Count Pay Plans with a Given Status (PP BY STATUS) for examples of such algorithms.
- Alerts can also be created by system-generated alerts, which are also referred to as legacy alerts. To enable the system-generated alerts, set the Use Legacy Alerts **Option Type** on the General System Configuration [Feature Configuration](#) to Y. When this feature is enabled, the system-generated alerts are executed before the plug-in alert algorithms.

NOTE:

A plug-in version for each of the system-generated alerts is provided with the product in addition to many without a system-generated equivalent. If the legacy alert feature is enabled, you would not use the equivalent plug-in alert algorithm, otherwise, these alerts may appear twice on the **Alert Zone**.

You can introduce your own alert algorithms to highlight additional alert conditions based on your business rules.

The table below lists the system-generated alerts that may appear if the use legacy alert feature is enabled and the page to which you will be transferred if you click on the hyperlink. The table below lists alerts in alphabetical order, but it includes a column indicating the order in which the alert will appear.

Alert Text	Order	Description	Drill Down Transfers You To
Account alerts	6	Appears for each user-defined alert associated with an account.	Account - Alert
Account has Multiple Premises	24	Appears when the account has service agreements whose service points reference multiple premises	Control Central - Account Tree
Account SA(s) linked to Umbrella Agreement	41	Appears when the account has one or more service agreements linked to a non-canceled terms of service record for an umbrella agreement that is in effect on the current date.	Terms of Service - Main
Active Write Off Process	10	Appears when an account has an active write off process . Refer to How Are Write off Processes Cancelled for information describing when a write-off process is deactivated.	Write Off Process
Appointment Exists	37		Appointment
Auto-Pay Active: <i>auto pay method description</i>	25	Appears when the account has an automatic payment option effective on the current date. The auto pay method description (i.e. Direct Debit or Payment Advice) appears only if payment advice functionality is enabled. Refer to Payment Advices for more information on payment advice functionality.	Account - Auto Pay

Cash-Only Account	11a	Appears when the account's cash-only score exceeds the cash-only threshold on the installation record. Refer to How are credit rating transactions created for information describing how a cash-only score is affected by various system and user events.	Account - C & C
Collection Process Active	8	Appears when an account has an active collection process . Refer to How Are Collection Processes Cancelled for information describing when a collection process is deactivated.	Collection Process
Collection Referral Active	9	Appears when the account has active collection agency referrals .	Collection Agency Referral
Comment Exists On Account	5	Appears when a free-form comment has been entered for the account (on Account - Main)	Account
Credit rating: NNNN	11b	Appears when the account's credit rating falls below the credit rating threshold on the installation record or the account's CIS Division. Refer to How are credit rating transactions created for information describing how a customer's credit rating is affected by various system and user events.	Account - C & C
Field Activity Pending	19	Appears when any of the premise's service points have a pending field activity	Field Activity
Field activity type alert message	12	Appears when the premise has a service point with a completed field activity whose type has been marked with an alert message (refer to Field Activity Type)	Field Activity
Held Order Exists	32	Appears when the person has a held order .	Order
Installation dynamic alerts	42	You can install plug-in algorithms on the installation record that will create alerts (if given situations exist). Refer to Count Customer Contacts of a Given Type (CC BY TYPCL) and Count Pay Plans with a Given Status (PP BY STATUS) for examples of such algorithms	Varies by plug-in

Landlord Exists	27	Appears when a landlord is linked to the premise	Premise
Last Contact: <i>days old - user name who added the contact</i>	3	Appears when the person and/or premise has a customer contact . The "days old" presents how old the contact is (based on the contact's date). The word Today is shown if the last contact was on the current date. The word Yesterday is shown if the last contact was on the current date - 1 day. If neither is applicable, the number of days old is shown.	Customer Contact
Life Support / Sensitive Load on Person	1	Appears when any of the account's persons has life support or sensitive load information	Person
Life Support / Sensitive Load on Premise	2	Appears when the premise has life support or sensitive load information	Premise - Misc.
Multiple Financially Resp	26a	Appears when the account has more than one financially responsible person linked to it	Control Central - Account Tree
Non-cash Deposit	15	Appears when the account has non-cash deposits effective on the current date	Account - Deposit
n Open Contact(s) for Person / n Open Contact(s) Premise	4	Appears if there are open customer contacts associated with the person and/or premise. Refer to Customer Contacts Can Be Used As Case Files for more information.	Customer Contact
Pending Order Exists	31	Appears when the person has a pending order .	Order
Pending Proposal SA Exists	36	Appears when the account has a proposal service agreement in the pending state. Refer to Proposal SA State Transition for more information.	Service Agreement
Pending Quote Exists	34	Appears when the account has a pending quote. Refer to Quote Lifecycle for more information.	Quote
Pending SA Relationships	16	Appears when the account has SA relationships that are pending	SA Relationship
Pending Start	17	Appears when there is a service agreement in the state of pending start linked to the account. Refer to The Lifecycle Of A Pending Start Service Agreement for more information.	Start/Stop

Pending Stop	18	Appears when there is a service agreement in the state of pending stop linked to the account. Refer to The Lifecycle Of A Pending Stop Service Agreement for more information.	Start/Stop
Person is linked to Multiple Accounts	22	Appears when the person has multiple accounts. A person's accounts are maintained on the Account - Person page.	Control Central - Customer Information
n Persons on Account	26c	Appears when the account has multiple persons linked to it. An account's persons are maintained on the Account - Person page.	Control Central - Account Tree
Premise has Multiple Accounts	23	Appears when the premise has service points that are linked to non-closed non-canceled service agreements that are linked to different accounts.	Control Central - Premise Tree
Premise has n Child Premise(s)	40	Appears when the premise is defined as the parent premise for one or more premises. Refer to Define Premise Hierarchy for more information.	Premise Management
Premise is linked to Parent Premise	39	Appears when the premise defines a parent premise. Refer to Define Premise Hierarchy for more information.	Premise
Quotable Proposal SA Exists	35	Appears when the account has a proposal service agreement in the quotable state. Refer to Proposal SA State Transition for more information.	Service Agreement
Quote Awaiting Customer Response Exists	33	Appears when the account has a complete quote with a quote detail that references a quotable proposal SA. Refer to Quote Lifecycle for more information.	Quote
Reactivated SAs Exist	21	Appears when any of the account's service agreements exist in the state of reactivated (i.e., a financial transaction has been generated after the service agreement was closed). Refer to The Lifecycle Of A Service Agreement for more information.	Service Agreement
SA type alert message	13	Appears when the customer has a service agreement with an SA type that has been marked with	Service Agreement

an alert message (refer to [SA Type - Details](#))

Note that if the account in control central has more than one service agreement, pressing the drill down button will also launch the service agreement search dialog.

SA type description and status of a non-billed budget service agreement	14	Appears for every pending start, pending stop, and active Non-Billed Budget that is linked to the account.	Non-Billed Budget Service Agreement
Seasonal Address Exists	38b	Appears if the person has a seasonal address and there is no seasonal address active on the current date.	Person - Correspondence Info
Seasonal Address Currently Effective (MM/DD - MM/DD)	38a	Appears if the person has an active seasonal address that is effective on the current date. The date range that the seasonal address is effective is included in the alert.	Person - Correspondence Info
Severance Process Active	7	Appears when any of the account's service agreement has an active severance process Appears when an account has an active severance process . Refer to How Are Severance Processes Cancelled for information describing when a severance process is deactivated.	Severance Process
Statement Construct Active	28	Appears if the person has an active statement construct	Statement Construct
Third Party Guarantor	26b	Appears when the account has a third party guarantor. An account's third party guarantors are maintained on the Account - Person page.	Control Central - Account Tree

Applicable Campaigns Zone

The **Applicable Campaigns Zone** lists the campaigns that may be of interest to the customer. If you press a campaign's Add Order button, you will be transferred to the [Order transaction](#) where you can walk the customer through the campaign's provisions and determine if they are interested in its goods and services.

FASTPATH:

Refer to [The Big Picture Of Campaign Eligibility](#) for more information.

WARNING:

The first 25 rows are displayed when this zone is initially built. If more rows exist, a **Get All** button appears. If you click this button, the system retrieves a maximum of 750 rows.

Bill Graph Zone

The **Bill Graph Zone** illustrates the ending balance and new charges on each of the customer's historical bills.

NOTE:

Approximately a year and half is shown. This zone shows all bills within 20 months of the latest bill. This limitation exists to prevent this zone from becoming unmanageably wide.

For [balance-forward accounts](#), both ending balances and current charges are shown in the graph. For [open-item accounts](#), only the current charges are shown in the graph.

The following points describe unique features of this zone:

- If you hover the mouse over a bar in the graph, summary information about the bill will display.
- If you click on a bar in the graph, you will be transferred to the bill page with the respective bill displayed.

Billed Consumption Zone

The **Billed Consumption Zone** illustrates the amount of consumption on each of the customer's historical bills. Up to three units of measure (UOM) are shown for each bill. The system uses the graph UOM's defined on the SA types associated with the customer's active service agreements. If more than three graph UOM's are detected for a customer, the system uses those associated with the service agreement types with the highest bill print priorities.

The following points describe unique features of this zone:

- If you hover the mouse on a bar in the graph, summary information about the bill will display.
 - If you click on a bar in the graph, you will be transferred to the bill page with the respective bill displayed.
-

NOTE:

Approximately a year and half is shown. This zone shows all bills within 20 months of the latest bill. This limitation exists to prevent this zone from becoming unmanageably wide.

Current Customer Zone

The **Current Customer Zone** contains basic information about the Person / Account / Premise on which you are working.

Person This part of the context area contains the person's standard information. Note, this information is formatted by a plug-in algorithm on the [installation record](#). Refer to the base package's person information algorithm (PERS-INFO) for an example. If you prefer different formatting logic, your system administrator should configure the system appropriately

Account ID This part of the context area contains the unique identifier of the account and the name of its main customer.

Adjacent to the account ID appears a "check digit". This is for information purposes only and is not needed to operate the system. Refer to the Description of Page section under [Account - Main](#) for a description of how "check digit" is calculated.

Premise This part of the context area contains the premise address. The address information is formatted by a plug-in algorithm on the [installation record](#). Refer to the base package's premise format algorithm (PREM-INFO) for an example. If you prefer a different format, your system administrator should configure the system appropriately

Below **Premise**, the account's **Current Balance** and **Payoff Balance** are displayed. **Payoff Balance** will be hidden when it's the same as the **Current Balance**. Refer to [Current Amount versus Payoff Amount](#) for more information.

Aged Debt Bar If the account's **Current Balance** is greater than zero, a colored bar is displayed adjacent. This bar provides information about the age of the account's debt.

The number of segments that appear in this bar is dependent on the elements of the customer's aged balance. The following segments may appear:

- disputed debt (If you handle disputed debt as described in [Disputing Items](#)),
- new charges and debt between 0 and X days old (where X is the account's customer class's bill due days),
- debt between X to 30 days old,
- debt between 31 to 60 days old,
- debt older than 60 days

NOTE:

If you hover the mouse pointer over a segment of the bar, the respective amount of debt will appear. If you click on the arrears bar you will be taken to the [Account Financial History](#) page. Note that information about debt balances by age is not applicable to [open-item accounts](#).

Start Service Push this button if you want to start service for the account and the service isn't at a premise (e.g., a deposit). Refer to [The Big Picture Of Starting Service](#) for more information.

Stop Service Push this button if you want to stop service for the account at the premise. Refer to [The Big Picture of Stopping Service](#) for more information.

Credit and Collections Info Zone

The **Credit and Collections Info Zone** is a grid that contains a variety of credit & collections-oriented events. Pushing the button adjacent to the information transfers you to an appropriate page. The following table lists the type of information that may appear in this zone and the page to which you will be transferred if you push the adjacent button.

Activity Label	What Is Displayed	Drill Down Transfers You To
Severance Process. <i>One row is displayed for every Active severance process linked to the account's service agreements.</i>	The severance process's description and create date/time	Severance Process - Main
Collection Process. <i>One row is displayed for every Active collection process linked to the account.</i>	The collection process's description and create date/time	Collection Process - Main
Write-off Process. <i>One row is displayed for every Active write-off process linked to the account.</i>	The write-off process's description and create date/time	Write-off Process - Main
Overdue Process. <i>One row is displayed for every Active overdue process linked to the account.</i>	The overdue process's standard information string (this is dynamic as is constructed by an algorithm)	Overdue Process - Main
Cut Process. <i>One row is displayed for every Active cut process linked to the account's service agreements.</i>	The cut process's standard information string (this is dynamic as is constructed by an algorithm)	Cut Process - Main

Pay Plan. <i>One row is displayed for every Active pay plan linked to the account</i>	The pay plan type's description and create date/time	Pay Plan - Main
Payment Arrangement. <i>One row is displayed for every non-cancelled, non-closed payment arrangement (i.e., service agreement with a special role of Payment Arrangement) linked to the account</i>	The service agreement's SA type description, start date and status	Payment Arrangement - Main

WARNING:

The first 25 rows are displayed when this zone is initially built. If more rows exist, a **Get All** button appears. If you click this button, the system retrieves a maximum of 750 rows.

Customer Information Zone

The **Customer Information Zone** is a grid that contains information about the current person and account. Pushing the button adjacent to the information transfers you to an appropriate page. The following table lists the type of information that may appear in this zone and the page to which you will be transferred if you push the adjacent button.

NOTE:

Rows are suppressed if the related data is blank for the person / account.

Label	What Is Displayed	Drill Down Transfers You To
Account ID	The account's unique identifier (i.e., account ID) is displayed	An account context menu has been provided (allowing you to drill to a variety of account-oriented pages)
Main Customer	The main customer's name. Note, the person's name is formatted by a plug-in algorithm on the installation record . Refer to the base package's name format algorithm (PERS-INFO) for an example. If you prefer different formatting logic, your system administrator should configure the system appropriately	A person context menu has been provided (allowing you to drill to a variety of person-oriented pages)
Set Up Date	The account's setup date	Account - Main
CIS Division	The account's CIS division	Account - Main
Customer Class	The account's customer class	Account - Main
Bill Cycle	The account's bill cycle	Account - Main
Current Credit Rating	The account's current credit rating	Account - C&C
Next Credit Review Date	The next date on which the account's debt will be reviewed by the account debt monitor . Refer to When Is An Account's Debt Monitored for more information.	Account - C&C
<i>A separate row is displayed for each characteristic linked to the account. Each row's label is the characteristic type's description. If the characteristic is future</i>	The characteristic's value	Account - Characteristic

dated, the effective date enclosed in parentheses prefixes the description.

Auto Pay Source	The account's auto pay source	Account - Auto Pay
<i>A separate row is displayed for each miscellaneous person linked to the account. Each row's label is the person relationship type's description.</i>	The main name of the miscellaneous person	A person context menu has been provided (allowing you to drill to a variety of person-oriented pages)
Budget Plan	The account's budget plan	Account - Budget
<i>A separate row is displayed for each characteristic linked to the person. Each row's label is the characteristic type's description.</i>	The characteristic's value	Person - Characteristic
<i>A separate row is displayed for each telephone number linked to the person. Each row's label is the phone type's description.</i>	The telephone number	Person - Main
<i>A separate row is displayed for each identifier linked to the person. Each row's label is the ID type's description.</i>	The person identifier value NOTE: The system supports encryption for Person Identifier. If your implementation has configured the system to encrypt Person Identifier, the data will be displayed with a masked value; such as, *****.Refer to Encrypting Sensitive Data for more information.	Person - Main
Email Address	The person's email address	Person - Miscellaneous
Service Provider.	The service provider's name and a description of the service provider's billing relationship as of the effective date.	SA Relationship - Main

WARNING:

This zone does not support [User Interface Masking](#). If your implementation masks any of the information that appears on this zone, you must disable it and implement a zone that will mask your data appropriately. The demonstration system provides a sample zone that your implementation can import and then customize if necessary; this zone's code is CI_CIMAP. To disable the base package zone simply deny access to its associated application service. You should only grant access to your new Customer Information zone.

Financial Information Zone

The **Financial Information Zone** is a grid that contains financial information related to the account. Clicking the hyperlink transfers you to the appropriate page. The following table lists the type of information that appears in this zone and the page to which you are transferred if you click the adjacent icon.

NOTE:

Rows are suppressed if the related data is blank for the person / account.

Label	What Is Displayed	Drill Down Transfers You To
-------	-------------------	-----------------------------

Current Balance	The account's current balance. If the account's current balance is greater than zero, a colored bar is displayed adjacent. This bar provides information about the age of the account's debt. Refer to Current Customer Zone for more information about this bar.	Clicking on the Arrears Bar or the hyperlink takes you to Account Financial History - Main
Payoff Balance	The account's payoff balance. It will only be displayed if the amount differs from the current balance.	Not applicable
Last Bill	The date and amount of the account's last bill along with its due date.	Bill - Main
Last Payment	The date and amount of the account's last payment.	Payment Event - Main
Previous Bill	The date and amount of the bill prior to the last bill for the account.	Bill - Main
Next Bill Date	The next date on which a bill is scheduled to be produced for the account (based on the account's bill cycle's schedule)	Not applicable
Pending Bill Exists	The date of the pending bill. This row only appears if there is a pending bill associated with the account	Bill - Main
Freezable Bill Segments	If freezable bill segments exist, this row contains the number of segments and their total amount.	Bill Segment - Main
Incomplete Adjustments	If incomplete adjustments exist, this row contains the number of adjustments and their total amount.	Adjustment - Main
Freezable Adjustments	If freezable adjustments exist, this row contains the number of adjustments and their total amount.	Adjustment - Main
Payment(s) Pending Upload	<p>Appears when the account has a pending payment staging record (i.e., the account has an external payment that has not been uploaded into the system). To prevent payments from being created and frozen before the actual payment is received, external payments are not uploaded into the system until their accounting date is reached.</p> <p>Note that the amount displayed represents the amount tendered for the account, but does not reflect how the payment may be distributed (i.e., the payment may be distributed to other accounts).</p> <p>For information about payment staging records, refer to Interfacing Payments from External Sources.</p>	Payment Upload Staging
Incomplete Payment(s)	Appears when the account has payments that are incomplete. This row contains the number of payments and their total amount.	Payment - Main

Note, incomplete [automatic payments](#) that are pending distribution are not included in this alert as they are highlighted on the **Auto Pay will be distributed on** described below.

Payment(s) with Errors	Appears when the account has payments that are in error. This row contains the number of payments and their total amount.	Payment - Main
Freezable Payments)	If freezable payments, this row contains the number of payments and their total amount.	Payment Event - Main
Auto Pay will be created on	This row shows the date that the next auto pay will be created. This alert will appear after a bill is completed for an account on auto pay and when your installation option's Auto Pay Creation Option is Create on Extract Date. If the installation option is Create at Bill Completion, then the Autopay will be created immediately at bill completion time and no information is displayed here. Refer to How And When Are Automatic Payments Created? for more information.	Bill - Main
Auto Pay will be distributed on	This row shows the date that the next auto pay will be distributed. This alert will appear after a bill is completed for an account on auto pay and when your installation option's Auto Pay Creation Option is Create on Extract Date. If the installation option is Create at Bill Completion, then the payment for the Autopay will be created immediately at bill completion time and no information is displayed here. Refer to How And When Are Automatic Payments Created? for more information.	Payment Event - Main

Premise Information Zone

The **Premise Information Zone** is a grid that contains information about the current premise. Pushing the button adjacent to the information transfers you to an appropriate page. The following table lists the type of information that may appear in this zone and the page to which you will be transferred if you push the adjacent button.

NOTE:

Rows are suppressed if the related data is blank for the premise.

Label	What Is Displayed	Drill Down Transfers You To
Premise Information	The premise's address. Note, the address information is formatted by a plug-in algorithm on the installation record . Refer to the base package's premise format algorithm (PREM-INFO) for an example. If you prefer a different format, your system administrator should configure the system appropriately	A premise context menu has been provided (allowing you to drill to a variety of premise-oriented pages)

CIS Division	The premise's CIS division	Premise - Main
A separate row is displayed for each characteristic linked to the premise. The label in each row is the respective characteristic type's description.	The characteristic's value	Premise - Characteristic
Landlord	The name of the premise's landlord	Landlord Agreement
Service Point Information. <i>Note, a separate row is displayed for each service point linked to the premise</i>	The service point's type and service cycle (if specified)	A service point context menu has been provided (allowing you to drill to a variety of service point-oriented pages)
Device <i>This row is displayed if a device is currently installed at the service point. If so, this row's label is indented and displayed beneath the related service point</i>	The device's badge number, device type, installation date, and status.	A meter configuration context menu has been provided (allowing you to drill to a variety of meter configuration-oriented pages)
Next Meter Read. <i>This row is displayed if the service point references a service cycle.</i>	The next scheduled meter read date and an indication of the service point's <i>service cycle</i>	No drill down is available
Item Information This row is displayed if an item is currently installed at the service point. If so, this row's label is indented and displayed beneath the related service point.	The item's type, badge number, and status.	An item context menu has been provided (allowing you to drill to a variety of item-oriented pages).

SA Premise List Zone

The **SA Premise List Zone** contains a row for each non-cancelled, non-closed service agreement linked to the account. The **Premise** (if any), **Current Balance**, **Payoff Balance**, and **SA Information** is displayed for each service agreement.

The service agreements appear in the following order:

- Service agreements linked to the premise on which you're working appear first.
- Next appear service agreements linked to the account that don't have a premise (deposits, charitable contributions, etc.).
- Following this are the remaining service agreements linked to the account.

NOTE:

Dimmed Payoff Balance. A service agreement's **Payoff Balance** will be dimmed if it is the same as its **Current Balance**. Refer to [Current Amount versus Payoff Amount](#) for more information.

WARNING:

The first 25 rows are displayed when this zone is initially built. If more rows exist, a **Get All** button appears. If you click this button, the system retrieves a maximum of 750 rows.

Service Credit Membership Zone

The **Service Credit Membership Zone** contains a row for each pending and active [service credit membership](#) linked to the account. It will also show any inactive membership that contains a balance. The **Service Credit Membership Type**, **Membership Status** and **Balance** (if applicable) are displayed for each membership.

Scheduled Payments Log

This zone displays an account's pending payments. It includes the following

- Pending one time payments initiated from a third party payment processing system.
- Pending one time payments initiated from web self-service
- Pending bill-related automatic payment records

Refer to [Third Party Payment Processing](#) for more information on third party payment processing.

Timeline Zone - Account Info

If your implementation team has configured one or more timeline zones, they may be visible on this page. Timeline zones show when significant events have occurred in the past and when significant events will occur in the future. For example, a timeline can show when payments and bills have been received for a customer.

Refer to [Timeline Zone](#) for a detailed explanation of how a timeline zone displays its information and other functionality that it supports.

Refer to [Configuring Timeline Zones](#) for how to add and change timeline zones.

Control Central - Customer Information

Once [Control Central - Search](#) has a person context, you can navigate to this page to view an overview of the related persons, customer contacts, accounts, premises, and service agreements linked to the account.

NOTE:

User configurable. Refer to [Each User Can Customize Which Zones Appear](#) for information about how to configure which zones appear.

Description of Page

NOTE:

Navigation hint. The Go To Control Central option on the person context menu navigates to this page.

A mouse with a roller is useful. This page can extend vertically past the normal desktop boundary. You will find that a mouse with a "roller" will facilitate navigating through the page.

The contents of this section describe the zones that are available on this portal page.

Communication History Search

Search Fields:

The following options allow you to search for and find the desired communications:

- **Search By** (dropdown) allows you to specify the type of communication that you want to find. You can search for Customer Contacts, Notifications from Oracle Utilities Notification Center and Lead Event logs, or all communications, which combine the previous two.

- **Start Date** and **End Date** allow you to set a targeted range of communications.
- **Search By Context** (dropdown) allows you to specify whether the communication is associated to the Person, Account, or Premise.
- **Hide Notification Logs** allows you to display the search results with or without the log entries.

NOTE: The Hide Notification Logs option displays when applicable to the selected Search By option.

Results Grid:

The following details are displayed for each communication:

- **Date / Time:**
 - For a customer contact related entry, the Customer Contact Date / Time for the communication
 - For lead / lead event related entries, the Log Date / Time where the Log Type is Notification for the communication
- **Details:**
 - For a customer contact related entry, the Contact Class Description / Contact Type Description is displayed
 - For lead / lead event related entries, the Log Messages for both the lead / lead event for the communication is displayed. There will be one entry for the lead and another for the lead event. If the lead / lead event created a customer contact for a communication, then an entry for the customer contact will also exist.
- **Related Object:**
 - For a customer contact related entry, a hyperlink to the customer contact record
 - For lead / lead event related entries, there will be one entry for the lead and another for the lead event.
 - For the lead related entry, a hyperlink to the lead related to the communication
 - For the lead event related entry, a hyperlink to the lead event related to the communication

Person Tree Zone

The [tree](#) in this zone shows a great deal of information including:

- All accounts linked to the person in context. Refer to [Understanding The V](#) for more information.
- Customer contacts linked to this person.
- The [hierarchy](#) of parents and children linked this person.
- All aliases linked to this person.

You can use this tree to both view high-level information about these objects and to transfer to the respective page in which an object is maintained.

Active Account Summary Zone

The **Active Account Summary Zone** lists all accounts related to the person in context where they are the main customer on the account. In addition, accounts linked to this person's [children](#) also appear in this zone, and if a child has children, the grandchildren's accounts are included. In fact, the system will look for accounts up to five levels deep (meaning that the great, great grandchildren's accounts will be included in this zone).

NOTE:

Only accounts linked to child persons with a financial relationship are shown. When you set up a [customer hierarchy](#), you can define both subsidiaries and "key contacts" (i.e., individuals that you contact at a company). As described above, this zone will include accounts related to these subsidiaries and key contacts. However, you might not want to include the personal accounts related to the key contacts in this zone. You can control which accounts appear in this zone when you set up a hierarchy. You do this by turning on the Financial Relationship switch for those [persons](#) whose accounts should be included.

The following columns are displayed in the grid:

Account Info This column contains the standard account information.

Current Balance and **Arrears** This column contains the account's current balance. If the account's current balance is greater than zero, a colored bar is displayed in the **Arrears** column. This bar provides information about the age of the account's debt. Note that information about debt balances by age is not applicable to [open-item accounts](#). Refer to [Current Customer Zone](#) for more information about this bar.

Last Billed Info This column contains information about the last completed bill sent to the account.

Last Contact Info This column contains information about the last customer contact associated with the account's main customer.

Timeline Zone - Customer Info

Your implementation may have configured this page to show one or more timeline zones. Refer [Timeline Zone - Account Info](#) for a description of how to use these zones.

Control Central - Account Tree

Once [Control Central - Search](#) has an account context, you can navigate to the **Account Tree** to see an overview of the persons, premises, and service agreements linked to the account.

Description of Page

This page is dedicated to a [tree](#) that shows the various objects linked to an account. You can use this tree to both view high-level information about these objects and to transfer to the respective page in which an object is maintained.

Control Central - Premise Tree

Once [Control Central - Search](#) has a premise context, you can navigate to the **Premise Tree** to see an overview of the accounts, service points, and service agreements linked to the premise.

Description of Page

This page is dedicated to a [tree](#) that shows the various objects linked to a premise. You can use this tree to both view high-level information about these objects and to transfer to the respective page in which an object is maintained.

Control Central - Bill/Payment Tree

Once [Control Central - Search](#) has an account context, you can navigate to the **Bill/Payment Tree** to see an overview of the financial transactions linked to the account.

Description of Page

This page is dedicated to a [tree](#) that shows the account's bills and payments. You can use this tree to both view high-level information about these objects and to transfer to the respective page in which an object is maintained.

For [balance-forward accounts](#), bill nodes contain the balance presented on the respective bill, and pay nodes contain the amount of the respective payment. However, for [open-item accounts](#), the tree behaves differently:

- The amount on bill nodes is equal to the sum of the current charges, adjustments and corrections on the bill.
- Each bill or payment will contain an indication if all of its financial transactions are fully matched. If not, the node will become red to highlight that unmatched financial transactions exist.
- If a bill or payment node is expanded, a summary of the match status of its financial transactions is shown.
- Credit and correction notes appear as separate nodes.

Control Central - Payment Agreements

Once [Control Central - Search](#) has an account context, you can navigate to the **Payment Agreements** page to see an overview of the account's payment arrangement requests and/or pay plans.

The contents of this section describe the zones that are available on this portal page.

Payment Arrangement Requests

This zone shows the account's in-progress and finalized (e.g. granted, denied, canceled, etc.) payment arrangement requests.

You can use this zone to: view high-level information about the payment arrangement request, navigate to the **Payment Arrangement Request** or start a payment arrangement request.

The **Broadcast** icon on each row displays the [Payment Arrangement Request Details](#) zone that shows summary information about the payment arrangement request.

The **New Payment Arrangement** action located at the header of this zone is used to start a payment arrangement request.

Refer to this zone's embedded help for information on other available actions.

Payment Arrangement Request Details

This zone is displayed when a Payment Arrangement Request is broadcast from the [Payment Arrangement Requests](#) zone.

It shows key information about the selected payment arrangement request.

Pay Plan Tree

This zone shows the pay plans linked to an account. It displays both current and past (expired) pay plans.

You can use this tree to both view high-level information about these objects and to transfer to the respective page in which an object is maintained.

How To Add A New Customer From Control Central

There are three ways to add a new customer from control central:

- You can add a new customer by invoking the [Person](#) and [Account](#) pages from the Menu dropdown. This is not the recommended approach, as it requires several screen interactions; either of the following approaches is preferable.

- If your team has set up sales and marketing campaigns, you can use the [order](#) transaction to add a new customer. Refer to [Order User Interface Flow](#) for more information. Refer to [Sales & Marketing](#) for background information about sales and marketing campaigns.
- Adding a Person from Control Central. You navigate as follows:
 - You start from [Control Central - Search](#). On this page, you determine if the customer already has an account. If so, select it and you're done. If not, proceed to the next step.
 - Click the + button adjacent to the Name field to transfer to [Person - Main Information](#) page (with the name you entered already defaulted). Use the Person pages to record all relevant information about the new customer.
 - Enter the customer's names, phone numbers, and IDs. Click Save (or press ALT+S) to add the person and account. The value of **Add Account and Start Service** is defaulted to "on" and the **Customer Class** defaults based on the **Person Type**. This means that when you click save the following will happen: a new person is added, a new account is added, the new person is linked to the new account, and you will be automatically transferred to [Start/Stop](#) where you can start service. (**Note:** This is the default behavior of the system. However, an implementation can define different functionality by setting up a [customer information options](#) feature configuration.

NOTE:

Default. When the system links the person to the account, it defaults the relationship type from the installation options. A different relationship type can be defined for persons versus businesses on the installation record.

If you need to tinker with information on the account, transfer to account maintenance (use the context menu) and make any necessary changes.

Customer 360

Use the unified search box to find a customer and/or premise. After selecting a search result, you are brought to the Customer 360 portal to see an overview of the customer.

Refer to [Search](#) for details on how to use the unified search box.

Customer 360 - Unified Search

Use the unified search box to find a customer or premise, in addition to the standard search for menu items. For more complex queries, click the **Advanced Search** to navigate to the advanced search portal.

The contents of this section describe how to use unified search for Customer 360.

Unified Search - Filters and Hints

Depending on the text entered into the toolbar search box, filter rules are dynamically performed to evaluate which filter is applied when searching for a customer.

The following filters and associated filter rules are used:

Filter	Filter Rule
Name	Minimum of 5 characters excluding whitespaces
Address	One or more numeric characters followed by space and an alphanumeric character
Account ID	10 numeric characters
ID Number	Social Security Number: 3 numeric characters followed by a dash, 2 numeric characters, a dash and 4 numeric characters

Phone Number	Plus character and 1-3 numeric characters (country code, optional) followed by a space, period, dash or open parentheses, 3 numeric characters (area code), followed by a space, period, dash or close parentheses, followed by 3 numeric characters (exchange code), followed by a space, period or dash, followed by 4 numeric characters (subscriber number).
Email Address	Non-whitespace characters followed by an @ sign, non-whitespace characters, a period, non-whitespace characters

To search explicitly using a specific filter, precede the filter value with one of the following predefined hints:

Filter	Hint	Examples
Name	n:	n:brazil
Address	ad:	ad:123 main
Account ID	ac:	ac:1234567890
ID Number	id:	id:123-45-6789
Contact Info	c:	c:555-2287 c:mbrasil@oracle.com

For more information on configuring unified search, filters, and hints, refer to [Understanding Unified Search](#).

Unified Search - Search Results

When a search filter is applied, search results matching your search criteria are populated below the toolbar search box. The information displayed in this area can include the person, account, or premise information. Additionally, the search filter and search filter value that was used for determining the matching search criteria is displayed. Select the customer or premise to navigate to the Customer 360 portal.

NOTE: The first 300 matches are retrieved and displayed. The base search zones are configured with the **Number of Rows to Display** and **Number of Rows to Retrieve for SQL** parameters set to 300. If you do not find the account / person / premise you are looking for in the set of results, refine your search criteria.

Customer 360 - Program Enrollment

The Program Enrollment Zone contains messages highlighting a variety of insights related to the account in context. Insight Types associated to the Insight Class of Program Enrollment are displayed.

The base product provides Insight Types for: Auto Pay Enrollment, E-Bill Enrollment, Budget Billing Enrollment and Customer Web Enrollment. Refer to the Insight Type configuration in the application, for more details.

NOTE: For more information about Insight Types and Insight Groups, see [Contextual Insights](#).

The following provides high-level steps to define insight types that can be associated to the program enrollment zone:

- Define new Insight Types. For the program enrollment zone, the insight types are intended to be defined with a visual structure of List Insight. Specify an insight algorithm that receives account as input context value.
- Define an Insight Group that references the **Program Enrollment** insight class. Configure the valid visual structure as List Insight.
- Associate the insight types to the insight group.

Customer 360 - Customer Insights

The Customer Insights Zone contains messages highlighting a variety of insights related to the customer (person, account, premise) in context. Insight Types associated to the Insight Class of Customer Insights are displayed.

NOTE: For more information about Insight Types and Insight Groups, see [Contextual Insights](#).

The following provides high-level steps to define insight types that can be associated to the customer insights zone:

- Define new Insight Types. For the customer insights zone, the insight types are intended to be defined with a visual structure of List or Card. Specify an insight algorithm that receives person, account or premise as input context values. The base package provides algorithm type C1CIALERT (Contextual Insight - Control Central Alert) for exposing control central alerts as contextual insights.
- Define an Insight Group that references the **Customer Insights** insight class. Configure the valid visual structures as List or Card.
- Associate the insight types to the insight group.

In addition to the Customer Insights zone, contextual insights can be configured to potentially render within certain areas of the other Customer 360 zones. The following table lists the available insight classes included in the base package and the associated UI placement within the corresponding customer 360 zone that insights can render. Additionally, the intended valid visual structures are listed as a guideline when defining the associated insight group. Follow the steps as described above to define insight types and insight groups for these zones.

Insight Class	Zone	UI Placement	Input Context	Valid Visual Structures
Customer Context (Upper)	Customer (dashboard zone)	Upper section of the zone, under person name field	PER_ID, ACCT_ID	Badge
Customer Context (Lower)	Customer (dashboard zone)	Bottom section of the zone, under person name field	PER_ID, ACCT_ID	Inline
Financial History	Financial Activity	Upper section of Financial History tab, above the financial history fields	ACCT_ID	Inline
Usage and Billing	Financial Activity	Upper section of Usage and Billing tab, below the filters	ACCT_ID	Inline
Payment Agreements	Financial Activity	Upper section of Payment Agreements tab	ACCT_ID	Inline
Credit and Collections	Financial Activity	Upper section of Credit and Collections tab, above the credit and collections trees	ACCT_ID	Inline

Customer 360 - Customer Activity

The Customer Activity History Zone is a grid that summarizes a variety of account-related events (in reverse chronological order). Use the Filter By drop down to select or deselect activity types to display. Clicking on the activity record transfers you to an appropriate page.

This zone displays similar information as the [Account Activity History Zone](#), with a number of additional activity types added. The following table lists the additional types of information that may appear in this zone and the page to which you will be transferred when selecting the activity record:

Activity Label	What Is Displayed	Drill Down Transfers You To
Bill. One row is displayed for every Completed bill linked to the account.	The bill amount, bill due date, number of days in the bill period, and bill date.	Bill
Payment. One row is displayed for every Frozen payment linked to the account.	The payment amount, the payment events tender type(s), payment status, and payment date.	Payment
Self Service Task. One row is displayed for every self service task linked to the account.	The self service task type description, self service task status, and creation date time.	Self Service Task
Business Flag. One row is displayed for every SP-based business flag linked to the accounts SA/SP's.	The business flag type description, status, and create date/time	Business Flag
Device Event. One row is displayed for every device event pertaining to paired device event types (e.g., power outage/restoration) and device event types configured to trigger service issue monitors.	The device event type description, status, and event date/time	Device Event
Service Order Field Activity. One row is displayed for every service order field activity that is not linked to a parent orchestrator activity.	The activity type description, service address information, status	Activity
Service Order Orchestrator Activity. One row is displayed for every service order orchestrator activity.	The activity type description, service address information, status	Activity

Customer 360 - Financial Activity

The Financial Activity Zone provides an overview of Usage and Billing, Financial History, and Payment Agreements linked to the account.

The **Usage and Billing** tab provides a graphical view of bills and metered usage. Use the Cost / Usage drop down to toggle between graphs. If the account is associated to multiple premises, use the Premise drop down to view a particular premise.

NOTE: Usage and Billing settings are configured by adding or changing the Billing and Usage Display Configuration. You can access the portal through **Admin > General > Master Configuration**.

The **Financial History** tab shows financial detail highlights and lists the account's financial events including charges, payments, and adjustments in reverse chronological order. The financial details highlight section contains the following financial information about the account:

- Current Balance
- Last Bill
- Next Bill Date
- Autopay Source
- Deposit Amount
- Payoff Amount

- Payoff Balance
- Current Credit Rating
- Next Credit Review Date

You can use the financial history grid to both view high-level information about these events and transfer to the respective page in which an object is maintained. Additionally, charge and payment events may be expanded for viewing additional details.

The **Payment Agreements** tab lists scheduled payments for the account's active payment arrangements and/or pay plans, and whether the scheduled payment has been received.

The **Credit & Collection** tab appears when the customer in context is active in a collections, severance, overdue, cut, or write-off process. The tab contains a tree showing the respective process and associated events, along with badge insights alongside each node indicating its status.

NOTE: Refer to the [C1-CollectionsSeveranceProcess](#), [C1-OverdueCutProcessTree](#), and [C1-WriteOffProcessTree](#) [tree](#) definitions for more information about the Credit & Collections node definitions and hierarchy.

Maintaining The V

As described in [Understanding The "V"](#), the "V" objects are those that form the core of your business processes. In this section, we describe the pages that maintain these objects.

NOTE:

Start/Stop Also Maintains The "V". The [Start/Stop Pages](#) also maintain many of the objects in the "V". For example, service agreements are created behind-the-scenes when you start service for a customer. This means you won't have to use most of the pages described in this section as part of your day-to-day activities. Rather, they exist in case you need to override what the system automatically set up for you.

Maintaining Persons

On the person page, you define demographic information about your customers and every other individual or business with which your company has contact. The topics in this section describe the person page.

FASTPATH:

For more information about persons and their place in the "V", refer to [Understanding The "V"](#). For more information about how most persons are added, refer to [How To Add A New Customer From Control Central](#). For more information about how a person is required to set up a customer, refer to [Customer Overview](#).

Person - Main Information

The Main page contains core person information like names, telephone numbers, and forms of identification. Open this page using **Menu > Customer Information > Person > Search**.

Description of Page

Person Information contains basic information about the person. These values only appear after the person exists in the database. The **ID** is a system-assigned random number that stays with a person for the life of the system.

NOTE:

Formatting is performed by a plug-in. The format of **Person Information** is controlled by a plug-in algorithm on the [installation record](#). Refer to the base package's person information algorithm (PERS-INFO) for an example. If you prefer different formatting logic, your system administrator should configure the system appropriately.

The following information may be recorded about a person:

Person/Business indicates if the entity is a person or a business. Valid values are: Person, Business. This value controls how the person's primary name is validated.

Life Support / Sensitive Load indicates if the person has life support or sensitive load equipment. Valid values are: LS/SL (i.e., the person has life support / sensitive load equipment), None. If the customer has LS/SL equipment, make a note of the type of equipment in the **Life Support / Sensitive Load Notes**.

A premise can also have life support / sensitive load information. If the equipment is physically linked to the premise (e.g., a hospital has life support equipment), you should NOT specify the life support information on the person. Rather, transfer to [Premise - Misc](#) and specify life support information on the premise.

NOTE:

Alert and C&C. If the base package's C1-LSSL-PER algorithm is enabled on the installation record, and life support / sensitive load information is specified, an alert will appear when the person is displayed on control central. In addition, if a person has life support or sensitive load equipment, it is possible for a different credit & collection severance process to be kicked off if the person's account associated has overdue debt. Refer to [Designing Your Severance Procedures](#) for more information.

Person Names are used by [Control Central](#) to look for accounts and persons. In addition, a person's primary name is the addressee on the person's bill unless overridden by the Override Mailing Name (maintained on the **Misc** tab). The following fields display:

- Use **Name Type** to indicate if the name is an Alias, Alternate Representation, Doing Business As, Legal, or Primary name. Note, for new persons, a value of Primary is defaulted. The values for the name type field are customizable using the Lookup table. This field name is NAME_TYPE_FLG
 - Use **Person Name** to define the person's name. Note well, the name is case sensitive.
-

NOTE:

Alternate representations of a person's name. You would use an Alternate Representation for a person's name when you have an alternate ways to define the person's primary name. Alternate representations are typically used in countries that use multiple character sets (e.g., the Primary name is entered in Chinese, the Alternate Representation is entered in English). When a person has an alternate name, both the main and alternate names can be used to search for a person. The Alternate Representation **Name Type** only appears if you have enabled alternate names on the installation record. Refer to the description of the Alternate Representation field under [Installation - Main](#) for more information.

Validation and formatting are performed by plug-ins. The validation that is applied to **Person Name** (e.g., a comma separating the last and first name - Smith,Patricia) is controlled by a plug-in algorithm on the [installation record](#). More than one algorithm can be plugged into this plug-in spot. Algorithms plugged into this plug-in spot can also perform formatting such as removing special characters that your implementation's business rules do not allow in person names. Other algorithms can be configured to remove or replace text.

- The **Do Not Format** switch can be used to bypass any person name formatting done by the algorithms described above. Validation such as requiring name separator is still applied, but no further formatting is applied. Setting the switch only applies while the record is being saved and is then reset. The switch is reset because the formatting is only applied when the record is subsequently changed. This switch is only shown if the Enable Person Name Format Bypass **Option Type** on the Customer Information Options [Feature Configuration](#) has been enabled

NOTE: The Person Phone grid appears when the Legacy Person Phone and Email **Option Type** on the Customer Information Options [Feature Configuration](#) has been enabled.

Person Phone numbers are used by [Control Central](#) to look for accounts and persons. The following fields display:

- **Phone Type** indicates the type of phone number, e.g., Home, Mobile, Business, ...
- Use **Phone Number** to define the telephone number. Enter the telephone number in the format described by the **Phone Format**.

NOTE:

Formatting is performed by a plug-in. The format that is applied to a **Phone Number** is controlled by the algorithm that is plugged in on the respective [Phone Type](#). If you prefer a different format, your system administrator should configure this algorithm appropriately.

- Enter the **Extension**, if any, of the telephone number.

Person Contacts provide a central location to capture contact information such as phone numbers and email addresses. Any contact information can be captured. Person Contacts are used on contact preferences for notifications.

While person contacts can be used in lieu of a person phone and all system processes such as start/stop and orders support person contacts, your implementation may still opt to use person phone. Functionality has been provided to create and maintain person contacts from person phone records. When a person contact type is associated with a phone type, the person contact cannot be deleted nor can the fields maintained via person phone be edited. Refer to [Maintaining Person Contact via Person Phone](#) for more information.

Person contacts can also be edited or created from the Account Contact Information Zone. (*See [Account - Account Portal](#) for more information.*)

- **Contact Routing** represents a general grouping of person contacts such as email or phone. It is displayed on this page, and is defined on the person contact type.

NOTE: Contact Routings of type whose Contact Routing type is *Self Service User* can be viewed here and not elsewhere in the system. Furthermore, they can be viewed, but not edited, added, or deleted.

- **Person Contact Type** indicates the type of contact such as, home phone, cell phone, or work email.
- **Contact Information** contains the specific contact information such as, the phone number or email address. Enter the contact information in the format described.

NOTE:

Formatting is performed by a plug-in. The format that is applied to **Contact Information** is controlled by the algorithm that is plugged in on the respective person contact type (refer to [Setting Up Person Contact Types](#) for more information). If you prefer a different format, your system administrator should configure this algorithm appropriately.

- Enter the **Extension**, if any, of the contact information. (This field is only active when the contact's contact routing is phone or fax.)
- The **Primary** switch must be set for exactly one person contact for each contact routing.
- **Do Not Disturb (From)** and **Do Not Disturb (To)** indicate the times when a person contact should not be used. (**Note:** these fields are active when the Person Contact Type's Allow Do Not Disturb information is set to *Optional*.)
- **Contact Status** indicates the option contact's status. The initial status can be defaulted from the Person Contact Type. The status can be manually maintained, as appropriate. (**Note:** This dropdown is enabled when the Person Contact Type allows Status to be used. It is also disabled when the person contact type's status is configured to be controlled by a process such as an Opt-In process.) See [Person Contact Status Can Be Controlled By A Process](#) for more information.

- **Opt-in** provides functionality to initiate an opt-in process for person contact types configured to support opt-in. This is used to obtain permission to use the person contact type to send notifications. (Note: The functionality on this page is not the primary way of initiating an opt-in process.) See [Person Contact Status Can Be Controlled By A Process](#) for more information about Opt-In Processes.
- **Active/Inactive** defaults to Active. Most contact preferences will remain active. When the contact information changes, the information on the existing contact should be updated.

WARNING:

It is strongly recommended that existing contacts are updated whenever possible such as when a person's phone number or email address changes. When a person no longer has a contact such as an alternate phone number, the contact should be deleted. Inactive should only be used when the person contact cannot be deleted because it is referenced on another object such as a contact preference.

- **Contact Nickname** (*display only*) if your implementation is using self-service, users can assign nicknames to contacts and they are shown here.

A **Person's ID's** have several uses:

- They are used by [Control Central](#) when you look for a customer / premise based on their ID.
- They are used to highlight potential duplicate persons.
- [Control Central](#) displays a person's **primary** identification in the search results area to help a user identify the customer when multiple customers match the search criteria.

NOTE:

Person ID may be required or optional. The person ID usage flag on the [installation record](#) indicates whether at least one id for a person is required or optional.

NOTE: The system supports encryption for Person Identifier. If your implementation has configured the system to encrypt Person Identifier, the data will be displayed with a masked value; such as, *****.Refer to [Encrypting Sensitive Data](#) for more information.

The following fields are used to define a person's ID(s).

- Turn on **Primary ID** for the piece of **ID** that is the primary means of identifying the customer.
- Indicate the **ID Type**. The **ID Type** defaults from the [Installation Record](#) based on the **Person Type** (Person versus Business).
- Enter the identification number in the adjacent fields. Please note that if the **ID Number** should be formatted (e.g., dashes in an American social security number), you do not have to enter the dashes. Rather, you can enter the information as a contiguous value and the system will format this for you. The format is shown in the adjacent **Identifier Format** column.

NOTE:

Formatting is performed by a plug-in. The format that is applied to an **ID Number** (e.g., dashes in an American social security number) is controlled by the algorithm that is plugged in on the respective **ID Type**. If you prefer a different format, your system administrator should configure this algorithm appropriately.

If you want to add an account for the person when you save the person information, turn on **Add Account and Start Service**. When this switch is on, you must also define the new account's **Customer Class**. If this information is specified, the system creates a new account and links the person to the account using the relationship type from the installation options. In addition, you will be transferred to [Start / Stop](#) where you can start service for the newly added account.

If you have set the Installation Option CIS Division Control flag, you must first define the new account's **CIS Division**. The values are restricted to the user's CIS Division(s). See [Users and CIS Division](#) for more information. The value is defaulted to user's primary CIS Division. The new account's Customer Class must then be defined.

NOTE:

Default note. The account's customer class defaults from the [Installation Record](#) based on the **Person Type** (Person or Business). If shown, the customer class defaults first from the CIS Division and then from the Installation Record, each based on the **Person Type** (Person or Business)

A message appears in the lower right corner of the page that describes the number of accounts the person has. You can click the adjacent go to button to transfer to [Control Central - Customer Information](#) on which all of a person's accounts appear.

Person - Correspondence Information

This page contains information that may be used to address [bills](#), [letters](#), [quotes](#) and [statements](#). Use **Menu > Customer Information > Person > Search** and navigate to the **Correspondence Info** page.

Description of Page

If the person does not want their primary name (defined on the Main page) used on [bills](#), [letters](#), [quotes](#) and / or [statements](#), specify the desired name in **Override Mailing Name 1, 2, and 3**.

Specify the **Override Mailing Address** fields if the person wants their bills, letters, quotes, and / or statements sent to an address other than their service addresses (for example, a post office box). In addition, if the person's account doesn't already indicate that the person's mailing address should be used, you must update this person's account(s). This information resides in the Address Source field on [Account - Person](#).

NOTE:

Both the [Start/Stop](#) and [Order](#) transactions allow you to update the person's **Override Mailing Address** and their account's address source using a single transaction.

Address isn't everything. In addition to defining the person's **Override Mailing Address**, there may be additional tasks you must perform in order to route information to this address. Refer to the following links for more information: [where are bills sent](#), [where are letters sent](#), [where are quotes sent](#) and [where are statements sent](#).

If you enter an **Override Mailing Address**:

- The **Country** defaults from your [installation options](#).
- The address constituents may differ depending on the **Country**. Refer to [Defining Countries](#) for more information on the address constituents.
- If you have set up [postal defaults](#), the system will default the address constituents when you tab out of the postal code.
- The Validate button on the person page will only be available if you have set the Allow Address Validation option type to Y on the General System Configuration feature configuration. Once clicked, the Address Validation Script on the General System Configuration feature configuration will be invoked to validate the entered address. Refer to [Implementing Address Validation](#) for more information.

Specify the customer's **Email Address** if you communicate with the customer via Email. In addition to defining the person's **Email Address**, your correspondence routing software must support sending the information via Email. Refer to the following links for more information: [where are bills sent](#), [where are letters sent](#), [where are quotes sent](#) and [where are statements sent](#).

NOTE: The Email Address field appears when Legacy Person Phone and Email **Option Type** on the Customer Information Options Feature Configuration has been enabled.

Define the **Language** in which the person prefers their bills and correspondence printed.

NOTE:

Default note. The person's language defaults from [Installation Options - Person](#).

FASTPATH:

Refer to [Customer Language](#) for more information on options for supporting multiple languages for your customers.

Define the person's **Time Zone** preference if it is different from the installation's time zone. Refer to [Installation Options – Framework, Main Page](#) for more information. The time zone appears as part of the display anywhere the Do Not Disturb start and end information is displayed; for example, in the Person Portal or Account Portal.

NOTE: Default Note. The Time Zone defaults to blank, which indicates that the installation's time zone will be used.

The **Seasonal Addresses** scroll is only used if the person wants their correspondence sent to an alternate address during predefined periods. For example, the customer may want their bills sent to their vacation cottage during the summer. Please be aware of the following:

- Seasonal addresses will only be used if the customer's bills, statements, quotes, and / or letters are routed via the postal service. For example, if you route bills to the customer via Email, the seasonal address will never be used to route bills to the customer. Refer to the following links for more information: [where are bills sent](#), [where are letters sent](#), [where are quotes sent](#) and [where are statements sent](#).
- You don't have to specify a seasonal address for every part of the year. For example, if the customer wants their bills sent to their service address except during the summer, you need only enter a seasonal address for the summer.
- You can enter a seasonal address with or without an **Override Mailing Address**. If an **Override Mailing Address** is not specified, the person's correspondence will be addressed as per the instructions on the person's account(s). These instructions reside in the Address Source field on [Account - Person](#).
- You can enter multiple seasonal addresses if the customer so desires.
- The **Seasonal** period is defined in the two adjacent fields. The first field contains the day and month when the season starts; the second field contains the day and month when the season ends. The day and month should be entered in the format defined in your [display profile](#).
- The **Status** of the address must be Active. You can set the status to Inactive if you want a seasonal address ignored (alternately, you can just remove the seasonal address).
- The **Country** defaults from your [installation options](#). The address constituents may differ depending on the **Country**. Refer to [Defining Countries](#) for more information on the address constituents.
- If you have set up [postal defaults](#), the system will default the address constituents when you tab out of the postal code.

Person - Characteristics

The characteristics page contains information that describes miscellaneous information about the person. Use **Menu > Customer Information > Person > Search** and navigate to the **Characteristics** page.

Description of Page

NOTE:

You can only choose characteristic types defined as permissible on the person record. Refer to [Setting Up Characteristic Types & Their Values](#) for more information.

The following fields display:

Effective Date Define the date on which the characteristic becomes effective. The effective date defaults from the [Installation Record](#).

Characteristic Type Indicate the type of characteristic.

Characteristic Value Indicate the value of the characteristic.

Person - Persons

This page is used to define this person's relationship with other persons. For example, if the person being maintained is a conglomerate, you can define its subsidiaries on this page. Refer to [How To Set Up Customer Hierarchies](#) for more information about hierarchies.

NOTE:

You're defining "child relationships". It's important to understand that the persons being defined on this page's grid should be thought of as "children" of the person on the top of the page.

Children may have children. It's possible for one of the children to have children itself (for example, if you have a situation where a subsidiary of a conglomerate itself has subsidiaries). To define a child's children, simply display the child person on this page and then define its children.

Equal relationships. It's possible to link persons where no hierarchy is implied by the relationship (e.g., spouses). There are two ways to do this: 1) you can nominate one spouse as the "parent" and the other as the "child" or 2) you can define the spousal relationship for both persons (i.e., you would define Robert Chopin as the husband of Jeanette Chopin, and Jeanette Chopin as the wife of Robert Chopin). If you choose the latter approach, a recursive relationship will exist.

WARNING:

If your organization enters multiple levels of person, we want to note that we do not prevent recursive relationships. This means that you could set up a nonsensical situation where person 2 is a child of person 1 and person 1 is a child of person 2.

Use **Menu > Customer Information > Person > Search** and navigate to the Persons page.

Description of Page

The grid contains the "children" associated with the "parent" person who is defined at the top of the page. The following fields display:

Child Person This is the unique identifier of the "child" person. This person's main name appears adjacent.

Child Information An informational message appears to highlight if the child person itself has children. You can click the corresponding go to button to view the child's children.

Relationship Type Indicate the type of relationship between the parent and the child person.

Start Date Indicate the date on which this relationship began. This field defaults from the [Installation Record](#).

End Date If the relationship expires, indicate the date the relationship stops.

Financial Relationship Turn on this switch if the child person has account(s) and information about these account(s) should be displayed when the parent person's hierarchy is displayed in the [Active Account Summary Zone](#).

Person - Person Portal

Select **Menu > Customer Information > Person > Search** and navigate to the **Person Portal** page to view additional information associated with a Person.

Depending on your implementations requirements, you may define additional zones to appear on this Portal.

The contents of this section describe the zones that are available on this portal page.

General Information

Person ID, Person Info are displayed.

Customer Notification Preferences

The Customer Notification Preferences Zone displays notification preferences for the customer in context.

The following table lists the notification types that may appear in this zone and the page to which you will be transferred to if you click on a hyperlink (if applicable).

Type	What Is Displayed
Bill Routing for each account the person receives a copy of the bill. Type hyperlink navigates you to the Account – Persons tab	Customer Information: Customer Information hyperlink navigates you to the Account Contact Method: Bill Route Type specified on the account Contact Information: Contact details for the Bill Route Type defined for the account
PPB New Charge if the person has an active prepaid biller. Type hyperlink navigates you to the Prepaid Biller Task	Customer Information: Customer Information hyperlink navigates you to Prepaid Biller Task Contact Method: Notification Preference for how the customer will be notified each time a new charge is calculated (specified on the Prepaid Biller Task) Contact Information: Contact details for the new charge Notification Preference
PPB Payment Request if the person has an active prepaid biller. Type hyperlink navigates you to the Prepaid Biller Task	Customer Information: Customer Information hyperlink navigates you to Prepaid Biller Task Contact Method: Notification Preference for how the customer will be notified when their prepaid balance is less than the required minimum balance (specified on the Prepaid Biller Task) Contact Information: Contact details for the payment request Notification Preference
Quote Routing for each account where the person receives a copy of quotes. Type hyperlink navigates you to the Account – Persons tab	Customer Information: Customer Information hyperlink navigates you to the Account Contact Method: Quote Route Type specified on the account Contact Information: Contact details for the Quote Route Type defined for the account
Statement Routing for each statement the person will receive. Type hyperlink navigates you to the Statement Construct – Main tab	Customer Information: Customer Information hyperlink navigates you to Person Contact Method: Statement Route Type specified on the statement construct Contact Information: Contact details for the Statement Route Type defined for the statement construct for each statement

Self-Service Notification Preferences

This zone displays active notification preferences for the customer in context and is only applicable if your implementation integrates with [Oracle Utilities Customer Self Service](#).

The applicable notification types (self-service task types) are defined on the [Self-Service Integration master configuration](#).

The following details are displayed for each active notification task (self service task) and the page to which you will be transferred if you click on a hyperlink (if applicable):

- Notification Task Information – Summary information for each of the customer’s active notification tasks. The hyperlink navigates you to the notification task (self-service task).
- Account Info – Details of the account linked to the notification task (self-service task). The hyperlink navigates you to the account.
- CSS Web User – End customer’s User ID supplied by Oracle Utilities Customer Self Service when the customer registers for the notification task (self-service task).

- Delivery Types – List of customer’s preferred communication channels specified on the notification task (self-service task).

Self Service Payment Options

This zone provides the ability to add, edit, and delete payment options used in customer self-service. This information is only applicable if your implementation integrates with [Oracle Utilities Customer Self Service](#).

Refer to the zone help for more details.

Maintaining Accounts

The account record contains information that controls billing and collection processes. You should only need to use this page if you need to fine-tune the information that the system has set up by default because:

- Most accounts are created when you [add a new person](#) or when you [complete an order](#) for a new customer.
- Many fields are populated behind-the-scenes as part of the [service activation process](#).

The topics in this section describe the pages on which account related information is maintained.

FASTPATH:

For more information about accounts and their place in the "V", refer to [Understanding The "V"](#).

Account - Main Information

The Main page contains core account information. Open this page using **Menu > Customer Information > Account > Search**.

Description of Page

The primary name of the **Account's** main customer and the **Account ID** are displayed on every tab in this page. These values only appear after the account exists on the database. The **Account ID** is a system-assigned random number that stays with an account for life.

NOTE:

Formatting may be performed by a plug-in. The basic information about an account that appears at the top of this page (and on many other pages in the system) may be formatted by a plug-in algorithm on the [installations record](#). Refer to the base package's account information algorithm (C1-AC-INFO) for an example. If you prefer different formatting logic, your system administrator should configure the system appropriately.

A "check digit" is displayed adjacent to the account ID. This is for information purposes only, and is not needed to operate the system. The following points describe how the check digit is calculated for an Account ID equal to 0011883422

- Calculate the sum of the first and every alternate digit in the account id. $A = 14 = 0+1+8+3+2$
- Calculate the sum of the second and every alternate digit in the Account ID and multiply by 2. For example, $B = 30 = (0 + 1 + 8 + 4 + 2) * 2$
- Add A and B. For example, $C = 44 = 14 + 30$
- Count the number of digits used to calculate B that are greater than 4. For example, $D = 1$ since only 8 is greater than 4.
- Multiply D by 9. For example, $E = 9 = 1 * 9$
- Subtract E from C. For example, $F = 35 = 44 - 9$

- Subtract the units position of F from 10 to find the check digit. For example, check digit = 5 = 10 - 5 (5 is subtracted from 10 because F = 35 and there the units position is 5).

NOTE:

Technical note. The above is calculated in the common routine called CIPCACDN .

Set Up Date is the date the account was initially set up. This is purely informational.

Currency Code defines the currency in which the account's financial transactions are expressed. All rates and payments associated with this account must be denominated in this currency.

NOTE:

Default note. The currency defaults from the [Installation Record](#) and may be overridden here.

Customer Class plays a part in:

- If and when a customer is subject to late payment charges.
 - The account's default collection class and when the account debt monitor reviews an account. Refer to [The Big Picture of Credit & Collections](#) for more information about how and when an account's debt is reviewed.
 - And several other functions. Refer to and [Setting Up Customer Classes](#) for more information.
-

NOTE:

Default note. The customer class defaults from [Installation Options - Account](#) (Person Customer Class) and may be overridden at will. If you have set the Installation Option CIS Division Control flag, the customer class defaults first from the CIS Division and then from the Installation Record. When this option is set, the CIS Division is shown on the page before customer class. You may only select Customer Classes with the account's CIS Division.

CIS Division defines the jurisdiction that governs this account. You may only select **CIS Divisions** associated with the account's [Customer Class](#). If you have set the Installation Option CIS Division Control flag, you need to choose the CIS Division before choosing the Customer Class. The values are restricted to the user's CIS Division(s). See [Users and CIS Division](#) for more information. The value is defaulted to user's primary CIS Division. This field is updated behind the scenes every time a service agreement is activated (the system uses the **CIS Division** associated with the service agreement's SA type). If you have assigned a **CIS Division** and do not want the system to change it when a service agreement is activated, turn on **Protect CIS Division**. If the CIS Division's **Restrict to Account CIS Division** flag is set to *Restricted*, the Protect CIS Division is turned on and cannot be turned off.

NOTE:

CIS Division governs many functions. An account's CIS Division impacts its subsequent bill due dates, late payment charge dates, credit & collections review dates, its default budget plan, the roles assigned to To Do entries, and the calendar of workdays. Refer to [Setting Up CIS Divisions](#) and [Setting Up Customer Classes](#) for more information.

Access Group controls which users are allowed to view and update this account's information (including bills, service agreements, payments, and premises). The system defaults this value from one of three sources, stopping after an access group is determined. The first is the Customer Class Control – Determine Access Group system event. The next is the access group defined directly on Customer Class Control. Lastly, it is defaulted from the user's [default access group](#). Refer to [The Big Picture of Row Security](#) for a complete description of how account security is implemented in the system.

The optional Account **Management Group** controls the roles assigned to [To Do entries](#) associated with an account. Refer to [Setting Up Account Management Groups](#) for more information.

Enter a **Comment** to define unusual information about the account. If this field is populated, an alert will highlight such in the [Alert Zone](#).

Bill Cycle controls when a bill is produced for an account. This field is updated behind the scenes every time a service agreement with a service point is activated. The route the system takes to do this update is as follows:

- It looks for all service points linked to the service agreement.
- It extracts the *service cycle* from one of the service points.
- Finally, it takes the bill cycle from the *service cycle*.

NOTE:

The list of bill cycles is restricted to those without a CIS Division and those with a CIS Division that matches the account's CIS Division. When the account does not have a CIS Division, the list is not restricted.

While this is a little complicated, it makes sense because it keeps the bill cycle in sync with the *service cycle*.

If you have assigned a bill cycle and do not want the system to change the bill cycle when a service agreement is activated, turn on **Protect Bill Cycle**.

If you want to stall billing until after some future date, enter the date in **Bill After**. Note that the bill's cutoff date should be after this date, for the account to bill.

Mailing Premise ID defines the address on bills for persons who have their bill sent to the account's mailing premise. This field may be updated behind the scenes when a service agreement is activated. The word "may" is used because the system will only update an account's mailing premise if there are no active service agreements currently linked to the account. Refer to [Account - Person Information](#) for more information about how to define where a person has their correspondence and bills sent.

If you do not want the mailing premise to change when a service agreement is activated, turn on **Protect Mailing Premise**.

If a user should review the account's printed bills before they are sent to the customer in an on-going basis, enter this user's ID in **Bill Print Intercept**. This User ID will then be copied to future [Bill - Bill Routing](#) pages when they are created. If the user no longer desires to intercept future bills, their User ID can be removed from this field.

The balances shown in the scroll are the total amounts of debt belonging to every debt class linked to the account's service agreements. The following information is displayed:

- **Debt Class** is the debt class associated with the account's service agreement(s).
- **Current Balance** is the amount of debt the customer currently owes.
- **Payoff Balance** is the amount the customer would owe if they wanted to pay off their debt.

To see summary information about the service agreements that contribute to the financial totals click the go to button adjacent to the respective amount.

WARNING:

If you do not understand the difference between payoff balance and current balance, refer to [Current Amount versus Payoff Amount](#).

Account - Auto Pay

The Auto Pay page is used when an account pays their bills automatically (e.g., by direct debit or credit card).

FASTPATH:

Refer to [How And When Are Automatic Payments Created](#) for more information.

Open **Menu** > **Customer Information** > **Account** > **Search** and navigate to the **Auto Pay** page to maintain this information.

Description of Page

The **Account Auto Pay** scroll defines the bank account / credit card from which the customer's automatic payments are debited. Multiple auto-pay options may exist if the customer changes auto-pay options over time. The following fields display:

- **Start Date** is the date on which the automatic payment information comes into effect. The system creates an automatic payment for any bill produced for this account with a due date on/after this date and on/before the **End Date**. If **End Date** is not specified, this means the automatic payment option applies indefinitely. You need only specify an **End Date** if the customer wants to stop paying automatically.
- **Auto Pay ID** is the unique, system-assigned identifier of the auto-pay record. This value is assigned after the information is saved on the database and may not be modified.
- Use **Auto Pay Source** to define the source of the funds used to satisfy the automatic payment request. For example, if a customer indicates that they want to use their checking account to pay their bill, you would specify the **Auto Pay Source Code** associated with their bank. The source's description and external source ID (e.g., bank routing number) are displayed adjacent.
- Use **Auto Pay Method** to specify whether you want the system to process automatic payments as Direct Debit or Payment Advice. This field is visible only if feature configuration is set up to support payment advice functionality. Refer to [Payment Advices](#) for more information on the payment advice functionality.
- Use **External Account ID** to define the customer's bank account / credit card number.

NOTE:

The system supports encryption for the External Account ID. If your implementation has configured the system to encrypt the External Account ID, the data will be displayed with a masked value; such as, *****. Refer to [Encrypting Sensitive Data](#) for more information

- You will be required to define an **Expires On** date if the **Auto Pay Source Code** references a tender type that requires an expiration date (e.g., if the Auto Pay Source is a credit card company).
- Enter the **Name** of the customer as it appears in the financial institution's system. This name is routed to the financial institution.

NOTE:

Default note. The **Name** will default to the primary name of the main customer linked to the account after you enter a **Start Date**. This defaulting is only possible for accounts that exist on the database.

- In some locales, customers can define a **Maximum Withdrawal Amount** to limit the amount of money that is automatically debited from their account. Refer to [How To Implement Maximum Withdrawal Amounts](#) for more information.
- Use **Comments** to describe anything interesting / unusual about the automatic payment request.

Account - Person Information

The Account Persons page contains information about the person(s) linked to the account.

NOTE:

Both customers and non-customers (e.g. the accounting service that handles the bills of a commercial customer) can be linked to an account.

When you add an account from [Person - Main](#) or from [Order - Main](#) the system automatically links the person to the account, so you typically won't have to open this page. However, if you need to link multiple persons to an account (e.g.,

because you need to send a duplicate of the account's bill to someone other than the main customer) or change information about a person on an account, open **Menu > Customer Information > Account > Search** and navigate to the **Persons** page.

Customer Self Service and Account - Person Information:

It is possible that an implementation may have configured the system to integrate with Customer Self-Service. Account - Persons can be created through the self-service application and will use a reserved relationship type that is defined on the self-service master configuration.

Records with this relationship type can be thought of as "owned by the self-service application." Changes to fields on the page are disabled because the record can be deleted by the self-service application.

You can change the relationship type to another value, which will indicate that the record is no longer owned by self-service. Self-service can no longer delete this record and changes are allowed to the fields on the page. Please note that the relationship cannot be changed back to the self-service designation

Description of Page

The **Account Persons** scroll contains one entry for every person linked to the account. The following fields display:

Person ID The unique identifier of the person linked to the account. The person's name is displayed adjacent.

Main Customer Turn on this switch if the person is the main customer on the account. Only one person on an account may be designated as the main customer.

The significance of the main customer is that its name will appear adjacent to the account ID throughout the system.

Financially Responsible Turn on this switch if the person is financially responsible for the account's debt.

This switch is on and gray if the person is the **Main Customer** because the main customer is always financially responsible. If multiple persons are linked to the account, you use this switch to indicate which ones are financially responsible versus those that are linked for other purposes.

Third Party Guarantor Turn on this switch if the person is a third party guarantor of the account's debt. This switch is off and gray if the person is the **Main Customer**.

Relationship Type Define the relationship between the person and the account. Refer to [Setting Up Account Relationship Codes](#) for information about setting up relationship types.

NOTE:

Default note. When the system links the person to the account when you add an account from [Person - Main](#), it defaults the relationship type from the [Installation Record](#).

Self-Service Role indicates that the Account - Person record has a corresponding entry in the self service application and contains the value for the access in self-service. If there is no corresponding entry in self-service, this field will not display. If configured in the Self-Service Master Configuration, a hyperlink appears allowing direct access to self-service.

Prefix/Suffix and Pfx/Sfx Name Use these fields if you need to append additional information to a customer's name when correspondence or bills are sent to this person. For example, if the account has declared bankruptcy you might attach "Debtor In Possession" to the person's name. Use **Prefix/Suffix** to indicate if the **Pfx/Sfx Name** should be appended to the front or the back of the customer's name.

Receives Copy of Bill Turn on this switch if the person receives a copy of the account's bills. Turning off this switch grays the remaining fields. This switch is on and gray if the person is the **Main Customer** because the main customer always receives a copy of the bill.

FASTPATH:

Refer to [The Source Of Bill Routing Information](#) for more information about how the remaining information is used to format the address of a bill.

Bill Route Type Indicate how the bill is sent to the customer. This field's value defaults from the [Installation Record](#).

- If the **bill route type** you select indicates that bills are routed via Fax, the person's fax number is displayed adjacent The fax number displayed is from a fax person contact associated with an active contact preference, the person's primary fax person contact identified by the contact routing, or a person's fax phone type identified by a flag on the phone type. Which is shown is dependent on how your system is configured.
- If the **bill route type** you select indicates that bills are routed via Email, the person's [Email address](#) is displayed adjacent. The email address displayed is from an email person contact associated with an active contact preference, the person's primary email person contact identified by the contact routing, or a person's email. Which is shown is dependent on how your system is configured.
- If the **Bill Route Type** you select indicates that bills are routed via the Postal service, you must choose an appropriate **Address Source** to define which address should be used.

Refer to [Setting Up Bill Route Types](#) for more information about bill route types.

Bill Format Indicate if the customer should receive a Detailed or a Summary bill.

NOTE:

The values for this field are customizable using the Lookup table. The values need to match the formats supported by your bill print software. This field name is BILL_FORMAT_FLG.

Number of Bill Copies Indicate how many copies of the bill the person receives.

Customer PO ID Indicate the purchase order ID the customer wants printed on their copy of the bill.

NOTE:

Receives Copy of Quote and **Quote Route Type** only appear if the quotation Contract Management module is not [turned off](#).

Receives Copy of Quote Turn on this switch if the person receives a copy of the account's quotes. Turning off this switch grays the remaining fields. This switch is on and gray if the person is the **Main Customer** because the main customer always receives a copy of the account's quotes.

FASTPATH:

Refer to [Printing Quotes](#) for more information about how the remaining information is used to format the address of a quote.

Quote Route Type Indicate how the quote is sent to the customer. This field's value defaults from the [Installation Record](#).

- If the **quote route type** you select indicates that quotes are routed via Fax, the person's fax number is displayed adjacent. The fax number displayed is from a fax person contact associated with an active contact preference, the person's primary fax person contact identified by the contact routing, or a person's fax phone type identified by a flag on the phone type. Which is shown is dependent on how your system is configured.
- If the **quote route type** you select indicates that quotes are routed via Email, the email address displayed adjacent. The email address displayed is from an email person contact associated with an active contact preference, the person's primary email person contact identified by the contact routing, or a person's email. Which is shown is dependent on how your system is configured.
- If the **quote route type** you select indicates that quotes are routed via the Postal service, you must choose an appropriate **Address Source** to define which address should be used.

Refer to [Setting Up Quote Route Types](#) for more information about quote route types.

Receives Collection and Overdue Notices Turn on this switch if the person receives letters (i.e., notifications) initiated by collection, severance, write-off, overdue and cut events. These events will send letters to the main customer and any other person linked to the account that **Receives Notifications**. This switch is on and gray if the person is the **Main Customer**

because the main customer always receives notifications. Refer to [Printing Letters](#) for more information about how letters are produced by the system.

Address Source If the **Bill Route Type** or the **Quote Route Type** you selected indicates that bills / quotes are routed via the postal service, you must choose the appropriate **Address Source**.

Choose Mailing Premise on Account if bills / quotes should be sent to the address associated with the Mailing Premise on the first page. This address is displayed adjacent.

Choose Person if bills / quotes should be sent to the [person's mailing address](#). This address is displayed adjacent.

Choose Account Override if bills / quotes should be sent to an override address specified below. Typically, you would only choose this option if the person has multiple accounts and each account's bills / quotes should be sent to a different address. If you choose this option, the bottom of this page will become populated with fields that should be used to specify this override address.

Override address constituents If you selected an **Address Source** of Account Override, you must enter the address to which bills / quotes will be sent in the address constituents. The number and type of address constituents is based on the [Country](#). These fields will be invisible for other **Address Sources**.

Note, the **Country** defaults from [Installation Options - System](#). The City, County and State default based on the **Country** and **Postal** if a [Postal Default](#) exists for the postal code.

The Validate button on the account page will only be available if you have set the Allow Address Validation option type to Y on the General System Configuration feature configuration. Once clicked, the Address Validation Script on the General System Configuration feature configuration will be invoked to validate the entered address. Refer to [Implementing Address Validation](#) for more information.

Allow Communication Preference: Turn on this switch if person contacts can be used on communication preferences for this account. The switch is on and disabled when the person is the **Main Customer** because their contact information can always be used on contact preferences for notifications.

Account - Financial Balances

The financial balances page is an information-only page that subdivides an account's debt by debt class. The balances shown on this page are the total amounts of debt belonging to every debt class linked to the account's service agreements.

NOTE:

The source of debt class. An account's debt comes from its service agreement(s). Every service agreement has an SA type. Every SA type references a debt class.

Open **Menu** > **Customer Information** > **Account** > **Search** and navigate to the **Financial Balances** page.

Description of Page

The account's **Current Balance** displays at the top of the page.

The **Debt Class Balances** scroll contains one entry for every debt class linked to the accounts non-closed / non-cancelled service agreements. The following information is displayed for each debt class.

- **Debt Class** is the debt class associated with the account's service agreement(s). To see summary information about the service agreements that contribute to the debt class totals click the adjacent Go To button.
- **Current Balance** is the amount of debt the customer currently owes.
- **Payoff Balance** is the amount the customer would owe if they wanted to pay off their debt. Payoff balance is only displayed if it differs from current balance.

WARNING:

If you do not understand the difference between payoff balance and current balance, refer to [Current Amount versus Payoff Amount](#).

- The **Debt Class Arrears** shows the age of all amounts that make up the current balance.
 - The **Days Old** and **Amount** information shows the age of the debt class's debt.
-

NOTE:

Information about debt balances by age is not applicable to [open-item accounts](#).

Account - Bill Messages

The Account Message page contains information about the message(s) to appear on an account's bills. Both one-time and permanent messages may be defined. This information is used when the system assembles messages to appear on an account's bill. Refer to [The Source of Bill Messages](#) for more information about bill messages.

Open **Menu** > **Customer Information** > **Account** > **Search** and navigate to the **Bill Messages** page.

Description of Page

The following fields are displayed:

Bill Message The message code and description of the message that appears on the customer's bill.

Bill Message Type Use Temporary to indicate the message should only be linked to the next bill produced for the account. Use Permanent if the message should appear on every bill. Note, a value of Temporary defaults.

Account - C&C

The Credit Rating page contains the credit rating transactions that impact an account's credit rating and cash-only score. To view or modify these transactions, open **Menu** > **Customer Information** > **Account** > **Search** and navigate to the **C&C** page.

Description of Page

Collection Class controls how the account's debt is compared against collection criteria to determine if a collection process should be started. Refer to [The Big Picture of Credit & Collections](#) for more information about how and when an account's debt is reviewed.

NOTE:

Default note. The **Collection Class** defaults from the account's customer class when the account is first added. It may be overridden at will.

If you need to prevent an account from being reviewed by credit and collections processes (i.e., the [account debt monitor](#) and the [write-off monitor](#)), use **Postpone Credit Review Until** to define the future date when these processes can again review the account's debt.

Last Credit Review Date is the date when the account's debt was last reviewed by the [account debt monitor](#) (ADM).

NOTE:

Forced ADM review. If you want the account debt monitor to review an account's debt the next time it runs, simply change the **Credit Review Date** to a date in the distant past (e.g., 1/1/1900). The next time the ADM background

process runs with the Include Minimum Days Review (Y/N) set to Y, it'll see that a great deal of time has passed since the last time it reviewed the account's debt and review it (and then set the **Credit Review Date** accordingly).

The account's **Current Credit Rating** is displayed. For an explanation of how this number is derived, see [How is an account's credit rating calculated?](#).

The account's **Current Cash-Only Score** is displayed. For an explanation of how this number is derived, see [How is an account's cash-only score calculated?](#).

The **Credit Rating History** scroll contains one entry for each credit rating history record associated with the account. The following fields display:

Start Date This is the first date the credit rating transaction affects the account's credit rating and cash-only score.

End Date This is the last date the credit rating transaction affects the account's credit rating and cash-only score.

The Created On message is formatted using an algorithm on the [Installation Options](#).

Affect Credit Rating By This is the effect of the credit rating transaction on the account's credit score. This should be a *negative* number because the *lower* the score the worse the credit rating.

An account's credit rating is equal to the start credit rating amount defined on the [installation record](#) plus the sum of credit rating demerits that are currently in effect. When an account's credit rating is less than the credit rating threshold defined on the [installation record](#), the account's credit rating is displayed as an alert in the [Alert Zone](#).

Affect Cash-Only Score By This is the effect of the credit rating transaction on the account's cash-only score. The *higher* the score, the greater the chance this account will be marked as cash-only. Therefore, a *positive* number should be used to make the score go up.

An account's cash-only score is equal to the start cash-only score defined on the [installation record](#) plus the sum of cash-only points that are currently in effect. When an account's cash-only score exceeds the cash-only threshold score defined on the [installation record](#), the account is flagged as cash-only in the [Alert Zone](#) and on the payment event page.

Comments Enter comments to clarify the reason(s) for the creation of the transaction.

How are credit rating transactions created?

Credit rating transactions may be created as follows:

- Certain types of severance events add credit rating transactions. The number of credit rating and cash-only points is defined on the [severance event type](#).
- Certain types of severance events add credit rating transactions. The number of credit rating and cash-only points is defined on the severance event type.
- Certain types of write-off events add credit rating transactions. The number of credit rating and cash-only points is defined on the [write-off event type](#).
- If a payment tender is canceled with a cancellation reason that indicates the cancellation was due to non-sufficient funds, a credit rating transaction is created. The number of credit rating and cash-only points is defined on the [payment cancellation reason code](#).
- You may configure your system to create a credit rating transaction when a pay plan is broken. To do this, you must plug in an appropriate Broken Algorithm on the [pay plan type](#).
- A user may create credit rating transactions at their discretion.
- Algorithms may add credit rating transactions. The system provides sample overdue event and cut event activation algorithms that add credit rating transactions. Refer to C1-OE-CR-RT and C1-CE-CR-RT for more information. Some examples of algorithms your implementation may decide to introduce: the creation of a late payment charge. To do this you could introduce a new adjustment freeze algorithm.

NOTE:

Created By Flag. The credit rating transaction includes a **Created By** flag that is customizable using the Lookup table. This field name is CR_RAT_CRE_BY_FLG. If your implementation uses algorithms to create credit rating history transactions, you may consider adding appropriate values to the Created By flag. Also note that the Created By flag includes the value Other , which may be used by your implementation specific algorithms if you do not want to add a new custom value.

How is credit rating calculated?

An account's credit rating is calculated by summing the Affect on Credit Rating from credit rating transactions effective on the current date. This value is added to the beginning credit rating defined on the installation record. The result is the customer's current credit rating.

NOTE: CIS Division can override the beginning credit rating. The system processes first check the account's CIS Division to see if the beginning credit rating has been specified on the CIS Division.

What impact does credit rating have in the system?

The following points describe the impact of an account's credit rating:

- An account's current credit rating is displayed in the Control Central Alert area when it's less than the threshold credit rating defined on the installation record.
- An account's credit rating may affect how the account's debt is collected. We used the word "may" because an account's credit rating will only affect collection criteria if you set up your collection processes to do this.

FASTPATH:

For more information, refer to [Designing Your Collection Class Control Overrides](#).

How is cash-only score calculated?

An account's cash-only score is calculated by summing the Affect on Cash-Only Score from credit rating transactions effective on the current date. This value is added to the beginning cash-only score defined on the installation record. The result is the customer's current cash-only score.

NOTE: CIS Division can override the beginning cash-only score. The system processes first check the account's CIS Division to see if the beginning cash-only score has been specified on the CIS Division.

What impact does cash-only score have in the system?

If an account's current cash-only score exceeds the cash-only threshold on the installation record, and the base package's C1-CASH-ACCT algorithm is enabled on the installation record:

- The customer is flagged as cash-only in the Control Central Alert area.
- If a user attempts to add a payment whose tender type is a cash-equivalent, a warning is issued.

Account - Budget

The Budget page contains information about all service agreements linked to an account that are eligible to participate in a budget billing plan. Refer to [Budget Billing](#) for more information about how this information affects the account's bills.

NOTE:

You are actually changing service agreements. When you change a service agreement's budget amount on this page, you are actually changing the service agreement's recurring charge amount. Refer to [Service Agreement - Recurring Charge](#) for more information.

Eligible service agreements. It's important to be aware that some service agreements linked to an account may not be eligible for budget plans. For example, assume you have a customer with a deposit service agreement and one or more utility service agreements. This customer will be billed for their deposit regardless of the utility service agreements' budget amounts. You define whether a service agreement may participate in a budget plan on the service agreement's SA type.

Open **Menu** > **Customer Information** > **Account** > **Search** and navigate to the **Budget** page to view this information.

Description of Page

The appearance and dialogue of this page differs slightly for an account with a small number of service agreements (100 or less) versus a large number of service agreements (more than 100).

- For an account with a small number of service agreements, the user may click the **Recommend Budget** button to generate a **New Budget** for each service agreement. At that point the service agreement's budget amount has not been updated. The user may review the calculated amounts; make desired changes and then click Save to update the budget amount for the service agreements.
-

WARNING:

You must save the page in order for the budget changes to take effect.

- For an account with a large number of service agreements, the user may click the **Calculate and Apply New Budget** button. At that point the system will calculate the recommended budget and update the **Budget Amount** on all the eligible service agreements. To change the budget amount for one or more of the service agreements, the user navigates to the service agreement page using the drill down button adjacent to the service agreement in question.

Click **Cancel Budget** to have the system set the **New Budget** amount to zero for all the account's service agreements on budget.

NOTE:

Budget Recommendation. Though this page lists all SAs eligible for a budget, the budget recommendation only calculates a budget amount for SAs whose start and end date (if any) includes the budget date.

Budget Plan controls how the account's debt is managed for budget-related purposes. Specifically, it controls how the recommended budget amount is calculated and how / when the customer's budget is periodically changed.

NOTE:

Default note. Budget plan defaults based on the account's customer class / division combination.

The list of budget plans is restricted to those without a CIS Division and those with a CIS Division that matches the account's CIS Division. When the account does not have a CIS Division, the list is not restricted

Use **New Budget Date** to define the effective date of any changes to the customer's budget amount (this date is the effective date on the respective service agreements' recurring charge history).

The system displays the sum of the service agreements' current budget amounts in **Current Account Budget**.

For accounts with a small number of service agreements, the system displays the sum of the service agreements' new budget amounts in **Recommended Account Budget**.

The grid that follows contains a row for each service agreement linked to the account that is eligible to participate in a budget billing plan:

SA Information This is a concatenation of basic information about the service agreement.

Last Changed Date This is the date when the service agreement's budget amount (i.e., recurring charge amount) was last changed.

Current Budget This is the existing budget amount (i.e., recurring charge amount) for the service agreement.

Recommended Budget For accounts with a small number of service agreements, the service agreement's budget amount (i.e., recurring charge amount) will be changed to reflect this value when the page is changed. The effective date of the change is defined in **New Budget Date**.

Account - Deposits

The Deposits page contains information about all cash and non-cash deposits linked to an account.

NOTE:

Cash versus Non-cash Deposits. Non-cash deposits (e.g., letters of credit, surety bonds, 3rd party deposits) can be added and maintained on this page. Cash deposits are maintained using service agreements. Refer to [Cash Deposits](#) for information about how to add and maintain cash deposits.

Open **Menu > Customer Information > Account > Search** and navigate to the **Deposits** page to view this information.

Description of Page

The following fields appear in the **Deposit Summary**:

Cash Deposits On Hand The total amount of cash deposits currently held for the account. This value is equal to the sum of the payoff balances from all service agreements whose SA type has a special role of Cash Deposit. Refer to [Cash Deposits](#) for information about how to add and maintain cash deposits.

Cash Deposits Requested This value is equal to the sum of Total Amount to Bill from all service agreements whose SA type has a special role of Cash Deposit. Refer to [Cash Deposits](#) for information about how to add and maintain cash deposits.

Non-Cash Deposits The total amount of active non-cash deposits currently held for the account. This value is equal to the sum of non-cash deposits displayed in the scroll below (note, non-cash deposits can be maintained in the same scroll).

Total Deposits on Hand This is the sum of cash and non-cash deposits held for the account.

Turn on **Do Not Review or Refund** if this account should not be considered by the Deposit Review background process (this process highlights customers who require an additional deposit) or by the Deposit Refund background process. Refer to [The Big Picture Of Deposits](#) for more information about these processes.

The **Non-Cash Deposit** scroll contains an entry for every non-cash deposit linked to the account. Refer to [Non Cash Deposits](#) for more information.

To modify a non-cash deposit, simply move to a field and change its value. To add a new non-cash deposit, click the + button and then fill in the information for each field.

Start Date This is the date the non-cash deposit is effective.

End Date This is the expiration date of the non-cash deposit.

Non Cash Deposit Type Select the appropriate non-cash deposit type. The value selected is important as it controls whether the system requires a **Third Party Deposit** and whether the system will create a To Do entry near the expiration date of the deposit. Refer to [Setting Up Non-Cash Deposit Types](#) for more information.

Deposit Class Select the deposit class in which this non-cash deposit should be included. This value is used when the system amalgamates an account's total deposits when checking if the account holds an adequate deposit (amalgamation and recommendation happens within a deposit class). Refer to [Deposit Class Controls Everything](#) for more information about the significance of deposit class.

Deposit Amount Indicate the amount of the non-cash deposit.

Document Number Enter the document number, if any, associated with the non-cash deposit (e.g., the letter of credit number, the surety bond number, etc.).

Third Party Deposit SA If a 3rd party has paid the cash deposit for the account, reference the deposit SA associated with the 3rd party. Refer to [3rd Party Deposits](#) for more information about how 3rd party deposits are maintained in the system.

Comments Enter any free-form comments about the non-cash deposit.

Account - Characteristics

The characteristics page contains information that describes miscellaneous information about the account. Use **Menu > Customer Information > Account > Search** and navigate to the **Characteristics** page.

Description of Page

NOTE:

You can only choose characteristic types defined as permissible on the account record. Refer to [Setting Up Characteristic Types & Their Values](#) for more information.

The following fields display:

Effective Date Indicate the date on which the characteristic value becomes effective. Note, the effective date defaults to the account's setup date (defined on the **Main** page).

Characteristic Type Indicate the type of characteristic.

Characteristic Value Indicate the value of the characteristic.

Account - Alerts

The alerts page contains information that describes various alerts assigned to the account. Use **Menu > Customer Information > Account > Search** and navigate to the **Alerts** page.

Alerts assigned to an account appear in the [Alert Zone](#). They are used to bring important information to the attention of any customer service representative who looks at the account.

Description of Page

The following fields display:

Alert Type Indicate the type of alert to show on Control Central.

Start Date Indicate the date on which the alert starts showing in Control Central. The current date defaults.

End Date Indicate the date on which the alert stops showing in Control Central. The alert is shown through the end date. You can leave this field blank if the alert should be effective indefinitely. The date defaults to the **Start Date** plus the **Alert Type's** alert period.

Account - Account Portal

Select **Menu** > **Customer Information** > **Account** > **Search** and navigate to the **Account Portal** page to view additional information associated with an Account.

Depending on your implementations requirements, you may define additional zones to appear on this Portal.

The contents of this section describe the zones that are available on this portal page.

General Information displays Account ID and Account Info

Account Contact Information Displays person contacts that are associated with the account in context. Only records for persons that allow communication preferences are shown.

- This zone provides the ability to add or edit existing person contacts. The edit functionality is limited. This provides a convenient way to edit basic information for person contacts. When adding a person contact, person contact types associated with phone types are not available.
- Full maintenance of person contacts can be performed on the *Person – Person Contacts* page.

Push Communication Preferences Displays contact preferences and opt-out preferences for push-based notification types; meaning, those notifications that customers do not need to subscribe in order to receive. You can maintain the customer's preferred method(s) of contact (the preferences) for receiving these notifications, or process a customer's request to opt out of receiving them.

NOTE:

Push notifications have parent and individual notification types. Communication preferences are established for parent notification types. The individual notification types reference a parent notification type and define the message to be sent using the preferences established for the parent. As mentioned, for push notifications a subscription is not needed; a default contact can be determined in the absence of contact or opt-out preferences.

Not all notification types are relevant to all customers. Notification types can be configured with a suppression criteria algorithm that can prevent some notification types from appearing. It is possible that a notification type was suppressed after active contact preferences were set up. These notification types and their contact preferences are also shown when the filter is set to show inactive preferences.

-
- Refer to [Push vs. Subscription Notification Types](#) and [Parent vs. Individual Push Notification Types](#) for more information.
 - Please see the zone's help text for information about this zone's fields.

Subscription Communication Preferences Zone displays contact preferences for subscription-based notification types - meaning those notifications to which customers need to subscribe in order to receive them. You can maintain the customer's preferred method(s) of contact (the preferences) for receiving these notifications. A notification for subscription-based notification cannot be sent without an active contact preference. Opting out is not applicable to subscription-based notification types.

NOTE:

Unlike push notifications, communication preferences are established for the subscription notification types, which also defines the message to be sent.

Not all notification types are relevant to all customers. Notification types can be configured with a suppression criteria algorithm that can prevent some notification types from appearing. It is possible that a notification type was suppressed after active contact preferences were set up. These notification types and their contact preferences are also shown when the filter is set to show inactive preferences.

-
- Refer to [Push vs. Subscription Notification Types](#)
 - Please see the zone's help text for information about this zone's fields.

Account Management Portal

The Account Management portal is used to maintain multiple accounts linked to a particular customer.

Open this page using **Menu > Customer Information > Account Management**

Some examples of customers with large numbers of accounts include:

- Public school districts with many school locations
- Corporate entities with many franchise locations
- Large apartment complexes with many open units
- Service providers billed for many end customers
- Cities, counties, or townships (for street lights, sewer service, etc.)

You can select one or more accounts to update, or you can broadcast an account's service agreements for group SA maintenance. Update actions can be performed on either accounts or SAs. The following items are examples of the account information that can be updated:

- Mailing address
- Characteristics
- Autopay information
- Bill cycle
- Account management group

The following items are examples of the service agreement information that can be updated:

- Rate schedules
- Contract riders and contract values
- Tax exemptions
- Characteristics

When you update information, you can select an account or SA to use as a template, and use this as a basis for updating multiple accounts. The system will copy information from the template to the selected accounts or service agreements. Refer to the embedded help on the Update Details page for more information about using a template to update accounts.

Description of Page

Use the Account Search zone to search for a person. The **Person ID** is required. **Include Hierarchy** determines whether you wish to search for accounts directly linked to the person id specified, or if you want to find all accounts in the hierarchy using person to person relationships. You can also enter one or more of the following values to further restrict the list of accounts returned: **Customer Class, Account Management Group, Bill Cycle or Characteristic Type/Value.**

Once a person is selected, you can view and maintain the accounts and the service agreements associate with the person. Click the broadcast icon next to an account to view SAs for the account. The Service Agreement List zone includes a summary listing of the non-closed, non-canceled service agreements of the broadcast account.

Select one or more accounts and click **Update Accounts** to modify account information. Select one or more service agreements and click **Update Service Agreements** to modify service agreement information. Refer to the embedded help on the Update Details page for descriptions of the values that can be updated.

The Person Tree zone, similar to that of Control Central, shows the hierarchy of child persons for the person that has been broadcast.

Account - SAs For A Debt Class

This is an information-only page that shows an account's service agreements grouped by debt class.

NOTE:

The source of debt class. An account's debt comes from its service agreement(s). Every service agreement has an SA type. Every SA type references a debt class.

To access this page, drill down on a debt class shown on **Menu > Customer Information > Account > Search.**

Description of Page

The **Account ID** and the primary name of the account's main customer are displayed.

Debt Class is the debt class associated with the account's service agreement(s).

NOTE:

An account may have service agreements that belong to other debt classes. Navigate to [Account - Main Information](#) to see a list of all debt classes associated with an account.

The **Service Agreement** scroll contains one entry for each service agreement that belongs to the **Debt Class**. The following information is displayed for each service agreement.

- **SA** (service agreement) **Info** is a concatenation of important details about the service agreement.
 - **Premise** defines the service agreement's main premise.
 - **Current Balance** is the amount of debt the customer currently owes.
 - **Payoff Balance** is the amount the customer would owe if they wanted to pay off their debt. Payoff balance is only displayed if it differs from current balance.
-

WARNING:

If you do not understand the difference between payoff balance and current balance, refer to [Current Amount versus Payoff Amount](#).

- **SA Arrears** displays the age of the amounts that make up the current balance.
 - The **Days Old** and **Arrears Amount** information shows the age of the service agreement's debt.
-

NOTE:

Information about debt balances by age is not applicable to [open-item accounts](#).

Using The Account/Person Replicator

There are two different ways to use this transaction:

- You can make many copies of a given Person / Account combination. This may be required if your company works with third party agencies who enroll customers on its behalf. In this situation, the third party agency may receive blocks of pre-allocated account numbers to be used when they enroll a customer. When a customer signs up, the person information can be updated with information about the newly enrolled customer.
- Perform the following steps if you need to create many copies of a given person and account:

- [Add a new person and account](#) if you don't already have a customer to serve as your "template".
- Use the Account/Person Replicator to create copies of the person and the account as described below (and make sure to use the Replicate Acct and Person option).
- You can create many Accounts for a single Person. This may be required if you have a customer who wants many separate accounts rather than a single consolidated account.
- Perform the following steps if you need to create many copies of a given account for a specific person:
 - Select the account that serves as the template account for the person. Note, this account must be linked to the person who wants the many accounts.
 - Use the Account/Person Replicator to create copies of the account as described below (and make sure to use the Replicate Account Only option).

Use **Menu > Customer Information > Account/Person Replicator** to open this page.

Description of Page

Choose the **Account** that serves as the template account.

NOTE:

Recommendation. Carefully verify that the template account you have chosen is correct before you save the replicated accounts. After you save the replicated accounts, any corrections could prove time consuming.

At the top of the page, indicate the **Number** of accounts and persons to **Replicate**.

Indicate the **Main Person Name Base**, which will be used as the main person name for all the new persons to be created. This field will be protected if you choose a **Replicate Type** of Replicate Account Only (as no persons are created).

Use **Replicate Type** to define if you want to create multiple copies of an account for a given person or if you want to create many new person / account combinations. See the description that appears above for more information about this field.

After entering the above, click the **Replicate** button to generate your new accounts and persons. The grid displays informational messages describing what will happen when you click save. For example, it will verify how many accounts will be created, the person whose record will be copied, the name that will be used on all the new persons, etc..

If everything looks clean, click **save**.

Information Replicated for New Persons

Except for the main name, which you indicate in the **Main Person Name** field, all information for the main person linked to the account will be copied to the new persons.

WARNING:

This copy includes the person's identification number. This will result in multiple persons with the same identification number. You should ensure that the identification number for your template person is a temporary number. When you sign up your actual customer, be sure to update the identification number to a valid number for the person.

Information Replicated for New Accounts

Although most information for an account will be copied, not all information will be. The following points describe the information that is NOT copied on newly replicated accounts:

- Mailing premise will be set to blank

- Setup Date is set to the current date
 - Credit Review Date and Postpone Credit Review Until Date will be set to blank
 - Auto Pay information will not be copied
 - Credit Rating History will not be copied
 - Non-cash deposit information will not be copied
-

NOTE:

that all miscellaneous persons linked to the account (i.e., those who are not flagged as Main Customers) will be linked to the new accounts. With this functionality, for example, you can create a person for a third party enroller and link this enroller to the template account. This enroller will then be linked to all the new accounts.

Maintaining Service Agreements

A service agreement contains the terms and conditions controlling how the system calculates charges for a specific service supplied to a customer. The topics in this section describe the pages on which service agreement related information is maintained.

NOTE:

The system creates most service agreements behind the scenes. Most service agreements are created "behind the scenes" by the system as part of the Start Service and Order completion processes. You should only have to access the service agreement pages if you need to fine-tune what the system defaults. Refer to [Start/Stop](#) and [Maintaining Orders](#) for the details.

Service Agreement and Usage Subscription. A Usage Subscription will exist for each 'usage-oriented' service agreement.

FASTPATH:

For more information about service agreements and their place in the "V", refer to [Understanding The "V"](#). For more information about the source of information defaulted onto service agreements, refer to [Setting Up Start Options](#).

For more information about Usage Subscription, refer to [About Usage Subscriptions](#).

WARNING:

Take special care when adding a new service agreement to specify the appropriate Division and SA Type as it will affect how the customer is billed, what rate can be specified, how overdue debt is collected, and much more. After the service agreement is activated, you may not change its SA type.

The Lifecycle Of A Service Agreement

The following diagram shows the possible lifecycle of a service agreement.

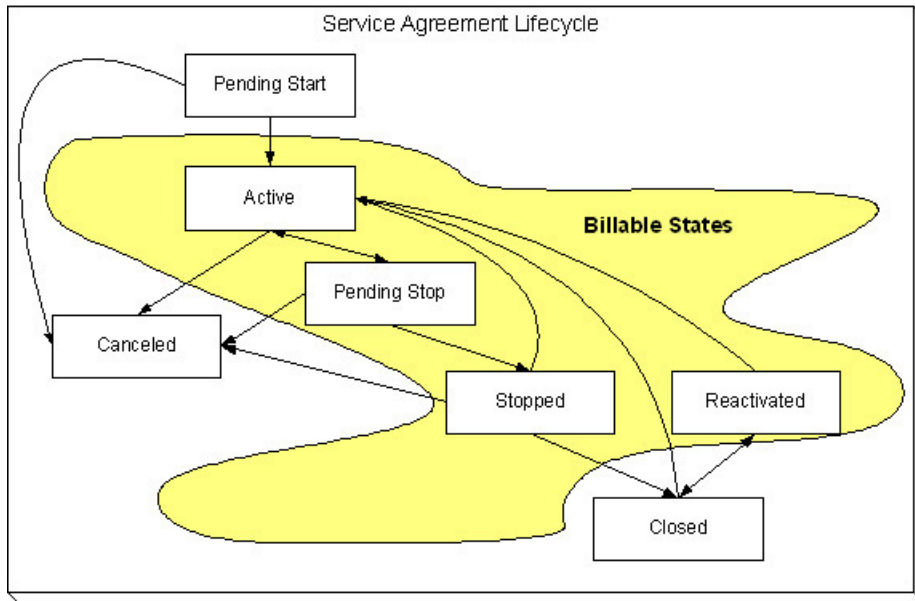

Pending Start When you initiate a request to start service, the system initiates a service agreement in the state of Pending Start. A pending start service agreement remains in this state until everything necessary to start service is defined in the system.

Active The system automatically changes the state of Pending Start service agreements to Active when everything necessary to start service exists in the system. Refer to [Activating Pending Starts](#) for more information. While in this state, the system bills the service agreement's account for the service.

Pending Stop When you initiate a request to stop service, the system progresses the service agreement to the Pending Stop state. A pending stop service agreement remains in this state until everything necessary to stop service is defined in the system.

Stopped The system automatically changes the state of Pending Stop service agreements to Stopped when everything necessary to stop service exists in the system. Refer to [Finalizing Pending Stops](#) for more information. The service agreement remains in this state until it is paid in full.

A service agreement can be automatically stopped depending on the SA Type configuration of the **Stop Option Flag**. Service agreements configured to automatically stop will be stopped when all SP related SAs of the account are stopped. For example, if an account has a cable service and a charitable contribution service agreement then the charitable contribution service agreement can be configured to automatically stop when the cable service agreement is stopped. The stop date of the charitable contribution will be set equal to the stop date of the electric SA.

Closed The system moves a service agreement to the Closed state when it no longer has a financial balance.

Reactivated The system moves a service agreement to the Reactivated state if a financial transaction is created after a service agreement is Closed (e.g., when a payment is canceled after the service agreement is closed). Please be aware that Reactivated service agreements are processed by the [Write Off Monitor](#).

When the service agreement once again has a zero balance (e.g., because the customer pays or the debt is written off), the service agreement returns to the Closed state.

Cancelled You may Cancel a service agreement if it shouldn't exist (because the customer doesn't want service). While cancellation doesn't physically remove a service agreement from the database, most queries and trees suppress information about canceled service agreements. This means cancellation is a nice way to logically delete undesired service agreements.

You'll notice in the above diagram that you can cancel an Active, Pending Stop or Stopped service agreement. You may only do this if the service agreement's financial transactions and non-billed billable charges are all cancelled.

You should rarely have to change a service agreement's status. Why? Because the system changes the status behind-the-scenes when various events take place. For example,

- When you request a service start using the Start/Stop page, the system creates a service agreement in the pending start state.
- If you cancel a pending start before service is activated, the system automatically changes the state of the service agreement to cancelled.
- When everything necessary to start service exists, the system automatically changes the state of the service agreement to active.
- When you request a service stop using the Start/Stop page, the system changes the state of the stopped service agreement to pending stop state.
- When everything necessary to stop service exists, the system automatically changes the state of the service agreement to stopped.
- When a final payment is received and the stopped service agreement's balance becomes zero, the system automatically changes the state of the service agreement to closed. The system can also close a service agreement as part of the write-off processing.
- If the payment bounces, the system automatically changes the state of the service agreement to reactivated. And the system will change it back to closed when the account's balance returns to zero.
- If a billable charge is interfaced into the system, the system automatically changes the state of the service agreement to reactivated.

You may need to manually change a service agreement's state for the following reasons:

- If a service agreement was activated inadvertently, you may cancel it (and therefore logically remove it from the system) after canceling all of its financial transactions. You do this by clicking the cancel button on the service agreement page. You may also cancel an incorrect service agreement if the status transitions to pending stop or stopped before you have a chance to correct the mistake.
- If you don't want to wait for the system to automatically activate a pending start service agreement, you may push the activate button on the service agreement page. You might do this in order to create a bill for an impatient customer.
- If you don't want to wait for the system to automatically finalize a pending stop service agreement, you may push the stop button on the service agreement page. You might do this in order to create a real time final bill for a customer.
- If you don't want to wait for the system to automatically close a stopped service agreement, you may push the close button on the service agreement page.
- Sometimes a service agreement is closed or stopped by mistake. You can activate a stopped, closed, or reactivated service agreement using the **Reinstate SA** button on the service agreement page. Using the **Reinstate SA** button retains the current service's billing history.

NOTE:

One time invoices (i.e., one-time billable charges) are interesting. One-time invoice service agreements follow the above lifecycle; it's just that they do it quickly. You see, when a one-time invoice service agreement is created, both its start and stop dates are known (they are the invoice date). If you followed the above state transition discussion, you'll understand that the system progresses these invoices from pending start to stopped when the service agreement is activated.

Renewing Service Agreements

Some service agreement types (e.g., non-billed budgets) may allow or require renewal. If renewal is optional, a renewal date may be specified when the service agreement is created. If renewal is required, you must specify a renewal date.

The [SA renewal background process](#) initiates the renewal for all active service agreements when the renewal date is reached (i.e., the renewal date is on or before the process date). When a service agreement is renewed:

- The SA renewal algorithm (specified on the SA type) is executed. The SA renewal algorithm can be used to customize the processing required to renew an SA.
- If the SA renewal algorithm is successful, the renewal and expiration date (if calculated by the renewal algorithm) on the service agreement are updated with the values returned from the renewal algorithm.
- If the renewal process is not successful, a To Do list entry (of type TD-SARN) is created for the account and service agreement.

Expiring Service Agreements

Service agreements may specify an expiration date. Some service agreement types (e.g., Non-Billed Budgets) require an expiration date. The [SA expiration background process](#) initiates the request to stop service for all active SAs when the expiration date is reached (i.e. the expiration date is on or before the process date).

Service Agreement - Main Information

The Main page contains basic service agreement information. Open **Menu > Customer Information > Service Agreement > Search** to maintain this information.

Description of Page

SA (service agreement) **Info** and **SA ID** are displayed on every page. These values only appear after the service agreement exists on the database. The **ID** is a system assigned random number that stays with a service agreement for life. The **SA Info** is a concatenation of important details about the service agreement and its account.

NOTE:

Formatting may be performed by a plug-in. The contents of **SA Info** may be formatted by a plug-in algorithm on [SA Type](#). Refer to the base package's C1-SAT-INFO for an example. If such an algorithm is not plugged-in on the SA Type, the system looks for a corresponding algorithm on the [installation record](#). Refer to the base package's C1-SAI-INFO for an example. If you prefer different formatting logic, your system administrator should configure the system appropriately.

SA Status defines the state of the service agreement. The system typically changes the state of a service agreement behind-the-scenes. If you can't wait for the system, use one of the adjacent buttons:

- Click the **Activate SA** button to activate a Pending Start service agreement.
- Click the **Cancel SA** button to cancel a Pending Start or Active, Pending Stop or Stopped service agreement.
- Click the **Initiate Stop** button to populate the **End Date** and change the state of the service agreement to Pending Stop.
- Click the **Stop SA** button to stop a Pending Stop service agreement.
- Click the **Close SA** button to close a Stopped or Reactivated service agreement.
- Click the **Reinstate SA** button to reinstate a Closed, Reactivated, or Stopped service agreement to an Active service agreement.

FASTPATH:

Refer to [The Lifecycle of a Service Agreement](#) for more information about **SA Status**.

If the [quotation](#) module is not [turned off](#), a "real" service agreement can be created when a [proposal service agreement](#) is [accepted](#). If the service agreement you've displayed was created in such a way, information about the **Proposal SA** will appear beneath **SA Status**.

Enter the **Account ID** that is financially responsible for the service agreement. If you change a service agreement's **Account ID**, you are effectively transferring this service agreement (and its debt) to the new account.

Indicate the **CIS Division** and **SA Type**. These fields are very important as they control numerous aspects of the service agreement's behavior. These fields are gray when the status is not Pending Start.

NOTE: If the service agreement's account's CIS Division's **Restrict to Account CIS Division** flag is set to *Restricted*, the CIS Division is set to the account's CIS Division and cannot be changed.

FASTPATH:

For more information about what the SA type controls, refer to [Setting Up SA Types](#).

The **Start Date** defines when the financial relationship begins. The **End Date** defines when the financial relationship terminates. If the end date is blank, the service agreement has not yet been terminated.

Use **Maximum Bill Threshold** if you want the system to generate a bill error when a bill segment is produced in batch that exceeds a given value. These bill errors will appear on the standard billing queries and To Do lists. If, after reviewing the high value bill segment, a user truly intends to send the bill out, they should regenerate the bill. Refer to [How To Correct A Bill Segment That's In Error](#) for more information.

NOTE:

Default note. The value of **Maximum Bill Threshold** defaults from the service agreement's SA type.

If the **SA Type** has a special role of Bill Determinants Required, you must enter the **Cutoff Time** and **Start Day Option** that is used on a bill determinants usage request.

- The **Cutoff Time** is entered in "legal time". This value defaults from either the start option or the [installation record](#).
- For **Start Day Option**, you may choose Current Day or Previous Day. This value defaults from either the start option or the [installation record](#).

Use **Customer Read** to define if the customer reads their own meter. Valid values are: Yes, No.

Turn on **Allow Estimates** if it's OK for the billing process to use estimated usage from Oracle Utilities Meter Data Management for this service agreement. If the SA type does not allow estimates, this field will be gray.

If you've set up the system to use [start options](#), you can have the system default many fields by copying the terms from a start option when service is started using either [Start / Stop](#) or the [Order](#) transaction. The **Start Option** field contains the last start option whose field values were copied to the service agreement. If you need to change a service agreement's terms by applying a different start option, you can. Refer to [Changing A Start Option](#) for a description of how to do this.

If the service agreement's rate uses premise-based characteristics for taxation and other purposes, **Characteristic Premise ID** defines the premise that supplies these characteristics. This field also defines the premise under which the service agreement's bill segments are classified and is used to identify where the service agreement's service is located on various windows. This field is gray if the service agreement's SA type doesn't require a characteristic premise. For more information about rates and their use of characteristics, refer to [Setting Up Bill Factors](#).

NOTE:

Selecting a characteristic premise. If the service agreement has service points, only premises associated with these service points may be selected as a **Char Premise**. If the service agreement doesn't have service points, any premise may be selected.

Your conversion process will fill in **Old Account ID** for service agreements that were converted from your legacy CIS system. The [payment upload process](#) uses this field to locate the accounts for payments that reference a legacy account number.

If the service agreement requires a total amount to bill, the amount is displayed. This field is typically only used on loan or cash deposit service agreements. It holds either the loan amount or the desired cash deposit. If you increase this field's value, the customer will be billed for any difference between the new amount and the total amount billed (and paid for) to date. The label that appears for this field is defined on the SA type (on the Billing tab). We recommend that the system be set up so that this label is very specific, for example:

- It should be called **Cash Deposit Amount** if the total amount to bill is for a deposit.
- It should be called **Loan Amount** if the total amount to bill is for a loan.

Number of Payment Periods only appears for loan SA types. It displays the number of periods specified when the loan was first activated. (The number of payment periods may have been subsequently changed on [Loan maintenance](#).)

If the service agreement uses a recurring charge, the current recurring charge amount is displayed. Transfer to the [Service Agreement - Recurring Charge](#) to update this value. This field is not visible if the service agreement's SA type doesn't allow recurring charges. The label that appears for this field is defined on the SA type (on the Billing tab). We recommend that the system be set up so that this label is very specific, for example:

- It should contain **Budget Amount** if the recurring charge is for a budget.
- It should contain **Installment Amount** if the recurring charge is used for a deposit being paid in installments.
- It should contain **Payment Amount** if the recurring charge is used for a loan.

SA Relationship ID contains the ID of the SA Relationship that is associated with a sub service agreement. This field is only visible on sub service agreements. Refer to [Sub Service Agreements](#) for more information.

CIAC Review Date displays the last date that the Contributions In Aid of Construction (CIAC) review process ran for this service agreement. This field is only visible if the SA type indicates this is a CIAC service agreement. Refer to [CIAC Segmentation](#) for more information on CIAC.

Deposit Interest Calculated contains the last date the system applied interest. This field is only visible if the SA type has a special role of Cash Deposit.

The **Scheduled Payment Autopay** flag determines if the Non-Billed Budget scheduled payments are excluded from automatic payment or included by automatic payment. If the account is not set up for automatic payment for the period that covers the Non-Billed Budget, this flag cannot be set. This field is only visible if the SA has a special role of Non-Billed Budget.

The **NBB Recommendation Rule** displays the description of the non-billed budget recommendation rule used for this SA. This field is only visible if the SA has a special role of Non-Billed Budget.

Expiration Date contains the date at which the service agreement is set to expire.

Renewal Date contains the date at which the service agreement is to be renewed. Renewal date is disabled if renewal is not allowed on the SA type.

Debt Class indicates the debt class into which the service agreement's current balance is categorized by credit and collections. A service agreement's debt class is defined on its SA type. Refer to [Different Collection Criteria For Different Customers And Different Debt](#) for more information about debt class.

Current Balance indicates the amount the customer currently owes for the service.

Payoff Balance indicates the amount the customer would owe if they wanted to close the service agreement. This value is only displayed when it differs from current balance.

FASTPATH:

Refer to [Current Amount versus Payoff Amount](#) for more information.

The **Days Old** and **Arrears Amount** information shows how old the current balance is. This information will be blank if the current balance is a credit.

NOTE:

Information about debt balances by age is not applicable to [open-item accounts](#).

This bottom of this page contains a [tree](#) that shows the various objects linked to the service agreement. You can use this tree to both view high-level information about these objects and to transfer to the respective page in which an object is maintained.

The topics that follow describe miscellaneous features on this page.

Changing A Start Option

If the service agreement is in the pending start state, you can use the [Start/Stop - Pending SAs](#) page to change the service agreement's SA type and/or start option.

If the service agreement is in the active or pending stop states and if the SA type uses [start options](#), a button appears on Service Agreement - Main called **Apply New Start Option**. When clicked, the **Apply New Start Option** dialog box opens.

The fields in this dialog box allow you to define a **Start Option** whose terms should be copied to the service agreement as of a given effective date (**Apply Start Option on**). Because most terms on a service agreement are effective-dated, it's important that you understand the following ramifications of applying a start option (note, we use the word "terms" to generically reference any of the fields that can be defaulted from a start option):

- Terms are reused if **Start Option** contains the same value as defined in the service agreement. For example,
 - If the **Start Option** references the same rate as defined in the service agreement, a new rate record will NOT be created.
 - If the **Start Option** references a contract rider that's currently defined in the service agreement, a new rider will NOT be created.
- Terms that support explicit expiration (i.e., those with an end date) are expired if they are not referenced on the new **start option**. For example, if the service agreement has a rider that is not referenced on the new **start option**, it will be expired.
- Terms that support implicit expiration (i.e., those without an end date) are left unchanged if they are not referenced on the new **start option**. For example, a service agreement characteristic that isn't referenced on the new **start option** will NOT be modified when a new start option is applied.

NOTE:

Only start options related to the service agreement's SA type can be used. It should be noted that only start options related to the service agreement's SA type can be specified. If the service agreement is in the pending start state, you can change the service agreement's SA type on the **Main** tab or via [Start/Stop - Pending SAs](#). If the service agreement is active, you may not change its SA type.

When you click **OK** a warning window will appear that summarizes the changes that will be made to the service agreement. After confirming what will be changed, click **OK** to change the service agreement's terms. The **Start Option** that is shown on the **Main** tab will now reflect the start option whose terms were just applied.

The Impact of Proposal Service Agreements

If the [quotation](#) module is not [turned off](#), you may display a [proposal service agreement](#) on Service Agreement - Main. This section describes how Service Agreement - Main differs when a proposal service agreement is displayed.

The **SA Status** section is replaced with a section that shows the status of the proposal service agreement (proposal SA).

Proposal SA Status defines the state of the proposal service agreement. The [Quote Maintenance](#) transaction typically changes the status of a proposal SA when users accept, decline and cancel quote details. If you wish to change the status of a proposal SA independent of this transaction, you can press one of the adjacent buttons

- Click the **Activate** button to change the status from Pending to Quotable. Note, you can set up the system to automatically make newly created proposal SAs quotable by plugging in the appropriate Proposal SA Creation algorithm on the SA's SA type.
- Click the **Accept** button to change the status from Quotable to Accepted. When you accept a proposal SA, you will be asked to supply the **Start Date** of the real service agreement that will be created.
- Click the **Decline** button to change the status from Quotable to Declined. When you decline a proposal SA, you will be asked to supply a **Decline Reason**.
- Click the **Cancel** button to change the status from Quotable to Canceled.
- Click the **Reactivate** button to return a Canceled or Declined proposal SA to the Quotable state.

FASTPATH:

Refer to [Proposal SA State Transition](#) for more information about **ProposalSA Status**.

If the proposal SA has been declined, the **Decline Reason** appears beneath **Proposal SA Status**. Refer to [Accepting / Declining Quote Details](#) for more information.

If the proposal SA was changed after a quote detail was generated using the proposal SA's terms, a **Remark** appears beneath **Proposal SA Status** highlighting such.

NOTE:

Changing A Start Option. You can [Apply A New Start Option](#) on pending and quotable proposal SAs.

If a real service agreement was created when the proposal SA was accepted, **Real SA ID** appears and contains the ID of the real service agreement. Refer to [Accepting / Declining Quote Details](#) for more information.

Service Agreement - Rate Info

The rate info page contains the service agreement's rate and information needed by the rate to calculate the service agreement's bill segments. This information is only displayed if the service agreement's SA type allows a rate.

Open **Menu > Customer Information > Service Agreement > Search** and navigate to the **Rate Info** page.

Description of Page

The **Rate** grid controls the rate used to calculate the service agreement's bill segments. Multiple rows will only exist if the service agreement's **Rate** changes over time.

A service agreement's **Rate** is populated by the system when service is started. The method used to populate the initial **Rate** depends on how service is started and whether you use start options:

- If the service agreement's SA type uses [start options](#):
 - If the [Order](#) transaction is used to start service, the rate is populated using the [start option](#) associated with the package that was selected by the user when the order was completed.
 - If [Start/Stop](#) is used to start service, the rate is populated using the start option selected by the user when service was initiated.
- If the service agreement's SA type does not use [start options](#), the [SA type's default rate](#) is populated on the service agreement.

Billing selects a single rate from the **Rate** grid when it calculates a bill segment for the service agreement. If multiple rates are defined in this grid, the rate is selected based on the service agreement's SA type's [Rate Selection Date](#). The following fields display:

- **Effective Date** is the date the rate becomes effective. The service agreement's start date defaults.
- **Rate Schedule** defines the rate used to calculate the service agreement's bill segments. Note, you can only choose rates defined as permissible on the service agreement's SA type; the permissible rates are shown in the adjacent tree.

NOTE:

Possible override. If your service agreement is linked to a terms of service record, it is possible that the rate used by the system could get [overridden by one referenced on the terms of service](#). If the rate is overridden by the TOS, the tree on this page indicates the rate source.

The **Contract Rider** grid contains the contract riders that are in effect for the service agreement. This information is defaulted when service is started using a start option (using the contract rider information defined on the [start option](#)). You should only have to access this section if you need to fine-tune what the system defaults.

Billing uses this information when it calculates a bill segment for the service agreement if:

- The rate used to calculate the bill segment contains a calculation rule that references a bill factor.
- The referenced bill factor requires a contract rider to levy the associated charge.

If a **Contract Rider** does not exist or is not effective, the charge associated with the calculation rule is not applied to the customer's bill.

To modify a contract rider linked to the service agreement, simply move to a field and change its value. To remove a contract rider, click the - button. To add a new contract rider, click the + button and fill in the information for each field. The following fields display:

- Use **Start Date** to define the date on which the contract rider becomes effective. The service agreement's start date defaults.
- Use **End Date** to define the date on which the contract rider expires. This field need only be specified if the contract rider expires on an explicit date.
- Use **Bill Factor** to define the type of rider. You may only reference **Bill Factors** designated as being applicable for contract riders. Note, the **Bill Factors** linked to the rate that are marked with contract rider applicability are shown in the adjacent tree under the Contract Rider node.

The **Contract Values** grid contains the contract values that are in effect for the service agreement. This information is defaulted when service is started using the contract value information defined on the [start option](#) used to start service (if any). You should only have to access this page if you need to fine-tune what the system defaults.

Billing uses this information when it calculates a bill segment for the service agreement if:

- The rate used to calculate the bill segment contains a calculation rule that references a bill factor.
- The referenced bill factor uses a contract value to define the amount charged.

The following fields display:

- Use **Start Date** to define the date on which the contract value becomes effective. The service agreement's start date defaults.
- Use **End Date** to define the date on which the contract value expires. This field need only be specified if the value rider expires on an explicit date.
- Use **Bill Factor** to define the type of value. You may only reference **Bill Factors** designated as allowing values in contract terms. Note, the **Bill Factors** linked to the rate that are marked as allowing values in contract terms are shown in the adjacent tree under the Contract Value node.
- Use **Value** to define contract value.

FASTPATH:

For more information about contract values, refer to [Defining General Bill Factor Information](#).

The **Tax Exemptions** section contains the taxes from which the service agreement is all or partially exempt.

Billing uses this information when it calculates a bill segment for the service agreement if:

- The rate used to calculate the bill segment contains a calculation rule that references a bill factor.
- The referenced bill factor can have tax exemptions that limit the amount of the charge.

If the bill factor doesn't have a tax exemption or there are none that are effective during the bill period, the tax is levied in full. If the service agreement is exempt, the appropriate charge associated with the tax is calculated. We strongly recommend using the "%T" substitution character in the [Description on Bill](#) on tax-exemptible calculation rules so that an appropriate tax exemption message appears on the customer's bill.

The following fields display:

- Use **Start Date** to define the date on which the tax exemption becomes effective.
- Use **End Date** to define the date on which the tax exemption expires.
- Use **Bill Factor** to define the tax from which the service agreement is exempt. You may only reference bill factors designated as being tax exemptible. Note, the **Bill Factors** linked to the rate that are marked as tax exemptible are shown in the adjacent tree under the Tax Exemption node.
- Use **Percent Exempt** to define the customer tax exemption percent (e.g., 90 means the customer is 90% exempt and will only pay 10% of the normal tax rate).
- Use **Tax Exempt Type** to specify the type of exemption.
- Use **Tax Certification** if the customer has a tax exemption certificate.

Rate Information Tree

The [tree](#) shows the service agreement's permissible rates and the related types of contract riders, contract values and tax exemptions that are possible given these rates.

- The Permissible Rates node displays all the rate schedules associated with the service agreement's SA Type.
- The Effective Rate Schedule node indicates the rate schedule currently effective.
- The Contract Rider node displays the bill factors linked to the service agreement's rate(s) that may have contract riders defined for them. If you expand a node, you can see the individual calculation rule(s) on which the bill factor is specified. If the service agreement has a value defined for the contract rider that is currently in effect, it is also shown.
- The Contract Value node displays all the bill factors linked to the service agreement's rate(s) that may have contract values defined for them. If you expand a node, you can see the individual calculation rule(s) on which the bill factor is specified. If the service agreement has a contract value defined that is currently in effect, it is also shown.
- The Tax Exemption node displays all the bill factors linked to the service agreement's rate(s) that may have tax exemptions defined for them. If you expand a node, you can see the individual calculation rule(s) on which the bill factor is specified. If the service agreement has a tax exemption defined for the bill factor that is currently in effect, it is also shown.

If the service agreement is currently linked to a terms of service record for an effective umbrella agreement, additional information is displayed in the tree.

- The Permissible Rates node displays the rate source value associated with the service agreement's SA Type.

- If the terms of service record linked to the service agreement has a template SA and the rate source is Check TOS First, then SA , the Effective Rate Schedule node displays the rate schedule for the template SA. An additional node indicating whether the rate source is the template SA or the current SA is displayed below.
- The Contract Rider, Contract Value and Tax Exemption nodes include the terms of service usage value from the bill factor.

FASTPATH:

Refer to [Rate Terms Overridden By Terms Of Service](#) for more information.

Service Agreement - SA / SP

The SA / SP page contains the service points that are linked to the service agreement. This information is only displayed if the service agreement's SA type allows service points.

This information is updated by the system when service is started. You should only have to access this page if you need to fine-tune what the system defaults.

WARNING:

You must understand the "V" very well before attempting to maintain this information. Refer to [Understanding The "V" for more information](#).

Use **Menu > Customer Information > Service Agreement > Search** and navigate to the **SA/SP** page

Description of Page

Billing uses **SA / SP** information to amalgamate consumption when it calculates a bill segment for the service agreement. The following fields are displayed:

Service Point ID The identity of the service point. The type and location of the service point is displayed adjacent. This field is gray after the service point is committed to the database.

Meter/Item Info The meter / item that is currently installed at the service point is displayed.

How to Use (SP) Indicates how billing uses the consumption associated with the service point. This field is gray for item-type service points. Valid values are: Add, Check, Subtract. Add service points have their consumption added to the total amount of consumption billed under a service agreement. Subtract service points have their consumption subtracted from the total amount of consumption billed under a service agreement. Check service points are ignored by billing.

Use Percent Indicates the percentage of this service point's consumption that is billed under the service agreement. This field is gray for item-type service points.

Start Date/Time The date and time the service point's consumption starts being billed under the service agreement. This is defaulted from the service agreement's start date.

NOTE:

For SAs whose type has a special role of Bill Determinants Required, the time component of the start date/time does not necessarily reflect the SA's cutoff time.

Start Meter Read is not applicable for Customer to Meter (C2M).

Stop Date/Time The date and time the service point's consumption stops being billed under the service agreement. This is defaulted from the service agreement's end date.

NOTE:

For SAs whose type has a special role of Bill Determinants Required, the time component of the stop date/time does not necessarily reflect the SA's cutoff time.

Stop Meter Read is not applicable for Customer to Meter (C2M).

The **Field Activity** grid contains the list of field activity requests that have been generated in respect of this SA / SP. Refer to [Field Activities to Start Service](#), [Field Activities to Stop Service](#) and [The Big Picture Of Severance Events](#) for more information.

Field Activity The unique ID of any field activity associated with starting, stopping, investigating, or severing the service at the service point.

Field Activity Type Indicates why the field activity is linked to the SA/SP. Valid values are Start Activity, Stop Activity, Severance Activity, Cut Process, or Service Activity.

The **Characteristics** grid contains characteristics that are only applicable for a given SA / SP combination. These are typically only used for obscure SA/SP relationships for which unusual pricing terms

NOTE:

You can only choose characteristic types defined as permissible on the SA/SP record. Refer to [Setting Up Characteristic Types & Their Values](#) for more information.

The following fields display:

Effective Date Indicate the date on which the characteristic value becomes effective. The service agreement's start date defaults.

Characteristic Type Indicate the type of characteristic.

Characteristic Value Indicate the value of the characteristic.

Service Agreement - Chars, Qty & Rec. Charges

This page contains the Characteristics, Contract Quantities and Recurring Charges that are in effect for the service agreement.

Use **Menu > Customer Information > Service Agreement > Search** and navigate to the **Chars, Qty & Rec. Charges** page.

Description of Page

The **Characteristics** grid contains information that describes miscellaneous information about the service agreement. This information is defaulted when service is started using the characteristics defined on the [start option](#) used to start service (if any). You should only have to access this section if you need to fine-tune what the system defaults.

NOTE:

You can only choose characteristic types defined as permissible on the service agreement record. Refer to [Setting Up Characteristic Types & Their Values](#) for more information.

The following fields display:

Effective Date Indicate the date on which the characteristic value becomes effective. The service agreement's start date defaults.

Characteristic Type Indicate the type of characteristic.

Characteristic Value Indicate the value of the characteristic.

The **Contract Quantity** grid contains the contract quantities that are in effect for the service agreement. This information is defaulted when service is started using the contract quantities defined on the [start option](#) used to start service (if any). You should only have to access this section if you need to fine-tune what the system defaults.

Billing may use this information when it calculates a bill segment for the service agreement if the rate has pre-processing calculation groups. Refer to [All Calculation Rule-Based Rates Share a Common Structure](#) for more information about pre-processing calculation groups.

The following fields display:

Effective Date The date this quantity becomes effective. The service agreement's start date defaults.

Contract Quantity Type The type of contract quantity.

Contract Quantity The contract quantity.

The **Recurring Charge** section contains effective-dated information that defines the recurring charge amount used to calculate the service agreement's bill segments. This information is only displayed if the service agreement's SA type allows a recurring charge amount.

A service agreement's recurring charge amount history is updated by the system behind-the-scenes as part of the Start Service process. The budget recalculation process can also update this information. You should only have to access this section if you need to change a service agreement's recurring charge amount on some future date.

Billing uses recurring charge information to select the appropriate recurring charge when it calculates a bill segment for the service agreement. To modify a recurring charge, simply move to a field and change its value. To change the recurring charge amount effective on a given date, click the + button to insert a row, then fill in the information for each field. The following fields display:

Effective Date The date the charge becomes effective. The service agreement's start date defaults.

NOTE:

Recurring charge changes during a bill period. Only one recurring charge will be used on any bill segment. The system selects the recurring charge value effective on the end date of the bill segment.

Recurring Charge Amount The recurring charge amount.

Service Agreement - Miscellaneous

The miscellaneous page contains information that describes miscellaneous information about the service agreement. Use **Menu > Customer Information > Service Agreement > Search** and navigate to the **Misc** page.

Description of Page

Start Requested By displays the information entered in the Requested By field on the Start Stop page when this SA was started.

Stop Requested By displays the information entered in the Requested By field on the Start Stop page when this SA was stopped.

Select the **SIC** associated with the customer. This is typically only used for commercial and industrial customers.

Enter a **Business Activity** associated with the customer. This can be used to further define what types of activities are served by this contract.

The bill message grid contains information about the message(s) to appear on a service agreement's bill segments. Both one-time and permanent messages may be defined. This information is used when the system assembles messages to appear on an account's bill (as part of bill completion). Refer to [The Source Of Bill Messages](#) for more information. The following fields are displayed:

- For **Bill Message**, select a message code to appear on the customer's bill.

- For **Bill Message Type**, use Temporary to indicate the message should only be linked to the next bill produced for the account. Use Permanent if the message should appear on every bill. Note, a value of Temporary defaults.

The terms and conditions (T&C) grid contains the service agreement's T&C's. This information is defaulted when service is started using a start option (using the T&C information defined on the [start option](#)). You should only need to change this information if you need to fine-tune the defaults. Refer to [Legal Terms and Conditions May Be Specified on Service Agreements](#) for more information. The following fields display:

- Use **Start Date** to define the date on which the T&C becomes effective. The service agreement's start date defaults.
- Use **End Date** to define the date on which the T&C expires. This field need only be specified if the T&C expires on an explicit date.
- Use **Terms and Conditions** to define the type of T&C.

Service Agreement - Contract Options

The contract options page contains the contract options and contract option events for service agreements that request usage (or billing determinants) based on interval data.

Open this page using **Menu > Customer Information > Service Agreement > Search** and then navigate to the **Contract Options** page.

Description of Page

The **Contract Option** collection contains effective-dated information that defines the contract options linked to the service agreement. The following information may be defined for each contract option:

Contract Option Id This is the id of the contract option to link to the service agreement. The **SA Contract Option ID** is displayed adjacent. This is the unique identifier of the SA / contract option record.

Effective Date/Time This is the date and time that the contract option is in effect for the service agreement.

Expiration Date/Time This is the date and time that the contract option is no longer in effect for the service agreement.

The **Override Events Collection** contains information about the override events for a shared contract option.

If a contract option event for a shared contract option should not be applicable to this service agreement, enter the **Contract Option Event ID**, the **Override Date/Time** that the override is effective and the **Status**. The status value of Active means that the override is in effect. The status value of Inactive 'cancels' the override, meaning that the event is applicable to this service agreement.

If seasonal time shift records are linked to both the base time zone and to the time zone on the service agreement's characteristic premise, the **Seasonal Time Shift** associated with the time zone on the characteristic premise is displayed.

The **Seasonal Time Shift Remark** indicates whether the data is displayed and should be entered in legal time or standard time. If the data is displayed in legal time use the **Show in Standard** button to toggle to standard time. If the data is displayed in standard time use the **Show in Legal** button to toggle to legal time.

NOTE:

This tab may not appear. This tab is suppressed if the interval billing Complex Billing module is [turned off](#).

Contract Option and Dynamic Option. A Dynamic Option will exist for each Contract Option.

FASTPATH: For more information about Dynamic Option, refer to Dynamic Option.

Service Agreement - TOU Contract Values

This page is not applicable for Customer To Meter (C2M).

TOU Contract Values Tree

This page is not applicable for Customer To Meter (C2M).

Service Agreement - Billing Scenario

NOTE:

This tab may not appear. This tab is suppressed if the quotation Contract Management module is [turned off](#).

This page allows you to define a [proposal service agreement's](#) billing scenario. Refer to [Proposal SAs Contain Billing Scenarios](#) for more information.

Open this page using **Menu > Customer Information > Service Agreement > Search**, then navigate to the **Billing Scenario** page.

Description of Page

This page is protected if the service agreement being displayed is not a [proposal service agreement](#).

When a quote is generated for a proposal SA, the system creates a simulated bill segment for each billing scenario linked to the proposal SA. Each simulated bill segment shows the prospect how much their bill would be if the pricing terms on the proposal SA were applied to the billing scenario's consumption in the related time period.

NOTE:

You should not have to enter this information from scratch. You can set up the system to automatically generate billing scenarios when a proposal SA is created. Refer to [Proposal SAs Contain Billing Scenarios](#) for the details.

The following information is defined for each billing scenario:

- **Start Date** and **End Date** define the simulated bill segment's period.
- The grid contains the consumption that will be priced during this period:
 - **Unit of Measure** is the unit of measure of the service quantity.
 - **TOU** is the time-of-use code of the service quantity.
 - **SQI** is the service quantity identifier of the service quantity.
 - **Initial Service Quantity** is the initial quantity passed to the rate (and massaged by the rate's pre-processing calculation group(s), if any exist).
 - **Service Point ID** is used if your rate uses pre-processing calculation groups that require characteristic values from the service point or premise. For example, the calculation rule that converts CCF to therms uses a bill factor to store the conversion factor. This bill factor may have been configured to use characteristics on the service point / premise (e.g., the conversion factor may differ based on the storage location associated with the service point).

Service Agreement - SA Portal

Select **Menu > Customer Information > Service Agreement > Search** and navigate to the **SA Portal** page to view additional information associated with an SA.

Depending on your implementation's requirements, you may define additional zones to appear on this Portal.

The contents of this section describe the zones that are available on this portal page.

General Information displays **SA ID** and **SA Info**.

Consumer Contract Products displays the service agreement's consumer contract products. **Add**, **Edit** and **Delete** actions are provided.

Maintaining SA Relationships

The SA Relationship page contains information about a specific relationship between a service provider and a customer.

WARNING:

The following page looks deceptively simple. It's not. Refer to [The Big Picture of SA Relationships and Service Providers](#) for more information.

Open **Customer Information, SA Relationship** to maintain this information.

Description of Page

The **SA Relationship Info** is a concatenation of important information about the SA relationship record. The **SA RelID** is a system-assigned random number that stays with a SA relationship record for life. This value is assigned when the record is added to the database.

SA Relationship Status defines the state of the SA relationship. The buttons are used to change the state:

- Click the **Activate SA Rel** button to activate a **Pending** SA relationship. This button is only enabled when the status of the SA relationship is **Pending**.
- Click the **Cancel SA Rel** button to cancel an **Active** or **Pending** SA relationship. This button is only enabled when the status of the SA relationship is **Active** or **Pending**.

NOTE:

Automatic SA Relationship creation and activation. The system automatically creates and activates required SA Relationships when the Activate SA background process sees that there are required SA relationships for the master SA Type.

Account ID is the account associated with the **Service Agreement ID**. This field is protected after the SA relationship has been added to the database.

Use **Service Agreement** to define the "master" service agreement ID that has a relationship. This field is protected after the SA relationship has been added to the database.

Premise is a display-only field that shows the **Service Agreement's** characteristic premise (i.e., the primary premise associated with the service agreement).

Use **SA Relationship Type** to define the type of relationship. This field is only enabled if:

- A **Service Agreement ID** is specified, and
- The status of the SA Relationship is not **Canceled**, and
- All sub SAs in the grid at the bottom of the page (if any) are **Canceled**.

Enter the **Effective Date** of the relationship. This field is only enabled if:

- A **SA Relationship Type** is specified, and
- The status of the SA Relationship is not **Canceled**.

Usage defines how this relationship is used. The following options are available:

- **Relationship With SP**. Use this option if this relationship is used to define a relationship between a customer and a service provider.

- **Expire SA Relationship.** Use this option if this relationship expires any prior relationship between a customer and a service provider and there is no relationship with a service provider going forward.

If the **SA Relationship Type**'s Service Provider Model is **Market Service Provider**, the following fields are enabled:

- **Market** identifies the market in which the service provider participates. Selecting a value will enable **Provider Configuration Option**.
- **Provider Configuration Option** specifies a service provider's billing/payment relationship within the specific market. Selecting a value will enable the **Market Relationship Service Provider**.
- **Market Relationship Service Provider** specifies the 'It's Us' service provider, meaning the utility company who is implementing this system. This is either a distributor or a retailer, depending on the utility's role in the market. The selection list consists of service providers with the selected billing/payment relationship for the selected market.

NOTE: Refer to [Setting Up Market SA Relationship Options](#) for more details on Service Provider Market Options.

The **Service Provider** associated with this relationship is the one who provides the related service, if any. You can only choose service providers who are linked to the "master" service agreement's SA type and the above **SA Relationship Type**. In addition, if the **SA Relationship Type**'s Service Provider Model is **Market Service Provider**, the service provider must also be valid for the selected **Market**, **Provider Configuration Option** and **Market Relationship Service Provider**. The **Service Provider** field is only enabled if:

- Usage is **Relationship with SPR**, and
- A **SA Relationship Type** is specified, and
- The **SA Relationship Type**'s Service Provider Model is **Market Service Provider** and **Market, Provider Configuration** and **Market Relationship Service Provider** are specified, and
- The status of the SA Relationship is not **Canceled**, and
- All sub SAs in the grid at the bottom of the page (if any) are **Canceled**.

If the **Service Provider** reads the customer's meter (as defined on the service provider's record), the customer's override **Read Cycle** should be defined. This field is only enabled if:

- A **Service Provider** is specified, and
- The **Service Provider** has the ability to override the service point's *service cycle*, and
- The status of the SA Relationship is not **Canceled**

The **Account Number in Provider's CIS** is the customer's ID in the service provider's system. This field is only enabled if:

- A **SA Relationship Type** is specified, and
- The status of the SA Relationship is not **Canceled**.

The **Create Sub SA** button is used to create [Sub Service Agreements](#) for a service provider for which your organization provides billing services. This button will be gray if:

- You do not provide billing services for the service provider (i.e., the service provider doesn't have a billing relationship of **It's Us** or **We Bill For Them**), or
- If the SA relationship's **Status** is not **Active**, or
- If the status of the master **Service Agreement** is not **Active**, **Pending Start**, or **Pending Stop**.

The grid at the bottom contains the sub service agreements (if any) that exist when your organization provides billing service for the **Service Provider**. You can click the Go To button on a row to transfer to the sub service agreement. Refer to [Sub Service Agreements](#) for more information. Note: you can click the **Create Sub SA** button to create sub service agreements for a service provider.

NOTE:

Automatic sub SA creation. The system will automatically create sub service agreements for you. It does this when the Analyze SA Relationships background process (known by the batch control ANLYZSAR) sees that a new SA relationship has been activated.

Service Provider SA Relationship

Use this page to manage a service provider's SA relationships and customers. You can view a given service provider's SA relationships of a given type that is in effect on a specified date. You can expire existing relationships or add new relationships. This page is particularly useful for managing [negotiated terms](#).

Open **Menu > Customer Information > Service Provider SA Relationship** to view this information.

Description of Page

Select the **SA Relationship Type**.

If the **SA Relationship Type**'s Service Provider Model is **Market Service Provider**, the following additional inputs are required:

- **Market** identifies the market in which the service provider participates. Selecting a value will enable **Provider Configuration Option**.
- **Provider Configuration Option** specifies the service provider's billing/payment relationship within the specific market. Selecting a value will enable the **Market Relationship Service Provider**.
- **Market Relationship Service Provider** specifies the 'It's Us' service provider, meaning the utility company who is implementing this system. This is either a distributor or a retailer, depending on the utility's role in the market. The selection list consists of service providers with the selected billing/payment relationship for the selected market.

NOTE: Refer to [Setting Up Market SA Relationship Options](#) for more details on Service Provider Market Options.

Select the **Service Provider**. If the SA Relationship Type's Service Provider Model is **Market Service Provider**, the service providers to choose from are those that are valid for the selected **Market, Provider Configuration Option, SA Relationship Type** and **Market Relationship Service Provider**.

Enter an **Effective Date**. This date filters the results so that only those SA relationships that are in effect on this date are shown.

Use **SA Filter** to restrict the SA relationships that are shown in the grid based on criteria of the related master service agreement. The following options are available:

- **Address**. Use this option to restrict SA relationships to those whose service agreements are linked to service points associated with a given **Address, City** and/or **Postal** code. Note, you can specify any combination of these fields.
- **All**. Use this option if you do not wish to restrict SA relationships based on service agreement attributes.
- **Geographic Type**. Use this option to restrict SA relationships to those whose service agreements are linked to premises or service points associated with a given **Geo Type** and **Value**.
- **SA Type**. Use this option to restrict SA relationships to those whose service agreements are linked to a given **CIS Division** and **SA Type**.

Don't forget to click the search button after changing the filters.

The **Select All / Clear All** buttons are used to select / unselect the SA relationships in the results grid. These buttons are enabled if there is at least one SA relationship in the results grid.

The grid that follows contains a line for each SA relationship that has a status of pending or active that meets the search criteria. Canceled SA relationships are not shown. If an SA relationship has more than one sub-SA, additional lines are used to show the additional sub-SA information. The following information appears in the grid:

- Select box. Use this checkbox to select SA relationships that you want to expire using the **Expire SA Relationship(s)** button.
- Click the go to button to transfer to the [Account - Main page](#) where you can perform maintenance functions on the account listed under Account Information.
- The **Account ID** column shows the account of the master SA linked to the SA relationship.
- The **Account Information** column shows information about the account identified by the account ID.
- Click the go to button to transfer to the [Premise - Main page](#) where you can perform maintenance functions on the premise listed under Premise Information.
- The **Premise Information** column shows information about the premise of the service point linked to the master SA of the SA relationship. If the master SA is linked to multiple service points, one is selected at random.
- The **Premise ID** column shows the ID of the premise whose premise information is shown.
- Click the go to button to transfer to the [Service Agreement - Main page](#) where you can perform maintenance on the service agreement listed under SA Information.
- The **SA Information** column shows information about the master SA that the SA relationship is linked to.
- The **SA ID** column shows the ID of the master SA that the SA relationship is linked to.
- Click the go to button to transfer to the [Service Agreement - Main page](#) where you can perform maintenance on the service agreement listed under Sub SA Information.
- The **Sub SA Information** column shows information about the sub SA linked to the SA relationship.
- The **Sub SA ID** column shows the ID of the sub SA linked to the SA relationship.
- Click the go to button to transfer to the [SA relationship page](#) where you can perform maintenance functions on the SA relationship listed under SA Relationship Information.
- The **SA Relationship Information** column shows information about the SA relationship meeting the search criteria.
- The **SA Relationship ID** column shows the ID of the SA relationship meeting the search criteria.

Following the grid is a section with action buttons that allow you to add or expire relationships for the given service provider:

- Press the **Expire SA Relationship(s)** button to expire the SA relationships that you have selected with the checkbox. You will be asked to confirm the date that you want the selected SA relationships to expire. Each selected SA relationship is expired by creating a new SA relationship without a service provider, i.e., its **Usage** is **Expire SA Relationship**. This new SA relationship will be effective the day after the expiration date you specify. This is because an SA relationship that expires on a given day is deemed to be effective until the end of that day.
- Note that you can only expire SA relationships where the SA type and SA relationship type allow gaps in the relationship.
- Press the **Add SA Relationship** button to add a new SA relationship for the service provider and SA relationship type entered above. Enter the effective date for the new SA relationship and the service agreement that the new SA relationship is for. After confirmation, a new SA relationship is added in a pending status. Note that if there is an existing SA relationship with the same effective date whose **Usage** is **Expire SA Relationship**, this relationship is replaced by a new SA relationship with the given service provider.

Maintaining Premises

The premise record contains geographic information about your service addresses.

The following methods list the various ways in which premises can be created:

- A premise can be added via the [premise replicator](#).

- A premise can be added when an [order](#) is completed.
- A premise can be added using this transaction.

The topics in this section describe the premise maintenance transaction.

FASTPATH:

For more information about premises and their place in the "V", refer to [Understanding The "V"](#). For more information about the relationships between premises, service points, meters and items, refer to [An Illustration Of A Premise](#).

Premise - Main Information

The Premise page contains basic premise information. Open **Menu > Customer Information > Premise > Search** to maintain this information.

Description of Page

Basic information about the **Premise** and the premise's unique identifier (i.e., the **Premise ID**) are displayed on every page. These values only appear after the premise exists on the database. The ID is a system assigned random number that stays with a premise for life.

NOTE:

Formatting is performed by a plug-in. The basic information about a premise that appears at the top of this page (and on many other pages in the system) is controlled by a plug-in algorithm on the [installation record](#). Refer to the base package's premise format algorithm (PREM-INFO) for an example. If you prefer a different format, your system administrator should configure the system appropriately.

Indicate the **Premise Type** to categorize the type of premise.

The address's constituent fields vary based on the **Country**. Please refer to the [Country](#) page for more information.

NOTE:

Default note. A premise's **state, city, county, division, characteristics, trend area** and **geographic data** default from your postal default information. Refer to [Setting Up Premise & Service Point Postal Defaults](#) for more information. If you change the premise's postal code, the system will default geographic values based on the new postal code.

Use **CIS Division** to define the jurisdiction in which the premise is located if the premise type allows CIS Division. This defaults based on the **Country** and the **Postal**, but can be overridden here. If your implementation has set the Installation Option Control By CIS Division flag, the values are restricted to the user's CIS Division(s). See Users and CIS Division for more information. The value is defaulted to user's primary CIS Division, but that can be overridden by the postal defaults

The Validate button on the premise page will only be available if you have set the Allow Address Validation option type to Y on the General System Configuration feature configuration. Once clicked, the Address Validation Script on the General System Configuration feature configuration will be invoked to validate the entered address. Refer to [Implementing Address Validation](#) for more information.

Indicate whether the address is a valid **Mailing Address**. Premises that are valid mailing addresses may be specified as the mailing premise on an account. Refer to [Account - Person Information](#) for more information.

Use **Landlord Agreement** to define the landlord agreement that covers the premise, if any.

NOTE:

Landlord reversion. When you specify a landlord agreement on a premise, you are telling the system that service associated with the premise's service points should be reverted to the landlord's account when a tenant stops service. The system uses this information during the stop service process to automatically create pending start service agreement(s) for the landlord.

Managing a large number of premises for the same landlord If the [premise management](#) module is not [turned off](#), the [premise management](#) page helps you to [manage the premises linked to the landlord](#).

If the [premise management](#) module is not [turned off](#), you may reference a **Parent Premise** to include this premise in a [premise hierarchy](#).

At the bottom of this page is a [tree](#) that shows the various objects linked to the premise. You can use this tree to both view high-level information about these objects and to transfer to the respective page in which an object is maintained.

Premise - Characteristics

The Characteristics page contains information that controls taxation and other rate options that differ based on geography. Use **Menu > Customer Information > Premise > Search** and navigate to the **Characteristics** page.

Description of Page

Many charges that appear on bills associated with consumption at this premise are controlled by the premise's characteristic values (e.g., the taxing city defines the city tax percent applied to the premise's consumption). Refer to [An Illustration Of A Bill Factor And Its Characteristics](#) for more information.

Characteristics also matter if your rates were set up to convert measured consumption into some other unit of measure before charges can be calculated (e.g., converting a cubic foot of gas to its therm value). Refer to [All Calculation Rule-Based Rates Share a Common Structure](#) for more information about pre-processing calculation groups.

NOTE:

You can only choose characteristic types defined as permissible on the premise record. Refer to [Setting Up Characteristic Types & Their Values](#) for more information.

The following fields display:

Effective Date Indicate the effective date of the characteristic type and value. The effective date defaults from the [Installation Record](#) when you are adding a new premise. The effective date defaults to the current date when you are changing an existing premise.

Characteristic Type Indicate the type of characteristic.

Characteristic Value Indicate the value of the characteristic.

NOTE:

Default note. A premise's characteristics default from your postal default information. Refer to [Setting Up Premise & Service Point Postal Defaults](#) for more information. If you change the premise's postal code, the system will default characteristic values based on the new postal code.

Premise - Miscellaneous

The Miscellaneous page contains information meter read controls and life support information related to the premise. Use **Menu > Customer Information > Premise > Search** and navigate to the **Misc** page.

Description of Page

Turn on **OK to Enter** if the meter is located in the interior of the premise and your company has permission to enter.

Indicate a **MR Warning** if a specific warning should be downloaded to the person who reads the meter.

Indicate a **MR Instruction** if specific instructions should be downloaded to the person who reads the meter. Meter read instructions and warnings are downloaded as part of the meter read download.

Use **Instruction Details** to provide more detailed instructions to the individual who reads meters at this premise.

Turn on **Key at Premise** if the meter is secured in a locked area and your company has the key. If this field is turned on, you may also specify the **Key ID**.

Trend Area is not applicable for Customer to Meter (C2M).

Indicate if the premise has life support or sensitive load equipment. Valid values are: LS/SL (i.e., the premise has life support / sensitive load equipment), None. If a value of LS/SL has been selected, define the type of equipment in **Life Support / Sensitive Load Notes**.

NOTE:

A person can also have life support / sensitive load information. If the equipment is personal (i.e., it travels with the person as they move from premise to premise), you should NOT specify the life support information on the premise. Rather, transfer to [Person - Main](#) and specify life support information on the person.

Alert and C&C. If the base package's C1-LSSL-PREM algorithm is enabled on the installation record, and life support / sensitive load information is specified, an alert will appear when the premise is displayed on control central. In addition, if a premise has life support or sensitive load equipment, it is possible for a different credit & collection severance process to be kicked off if the account associated with the premise has overdue debt. Refer to [Designing Your Severance Procedures](#) for more information.

Premise - Geographic Data

The Geographic Data page contains information that defines where the premise is located. Use **Menu > Customer Information > Premise > Search** and navigate to the **Geographic Data** page.

Description of Page

Enter the **Time Zone** in which the premise is located. This value defaults from your [postal defaults](#).

The geographic information is used by [Control Central](#) to look for premises. The following fields display:

Geographic Type Indicate the type of geographic data.

Geographic Value Specify the coordinate value. If the entered value must be in a specific format, a description of the required format is displayed adjacent. For example, if you see the format 99A 99A 99 9, you must enter 2 numbers, followed by a letter, followed by a space, followed by 2 numbers, followed by a letter, followed by a space, followed by 2 numbers, followed by a space, followed by a single number.

NOTE:

Formatting is performed by a plug-in. The format that is applied to a **Geographic Value** is controlled by the algorithm that is plugged in on the respective [Geographic Type](#). If you prefer a different format, your system administrator should configure this algorithm appropriately. Note, algorithms of this type will NOT convert the input value into the relevant format (i.e., you must enter the information in the exact format dictated by the algorithm).

Default note. A premise's geographic data defaults from your postal default information. Refer to [Setting Up Premise & Service Point Postal Defaults](#) for more information. If you change the premise's postal code, the system will default geographic values based on the new postal code.

Premise - Alternate Address

WARNING:

This tab only appears if you have enabled alternate addresses on the installation record. Refer to the description of the Alternate Representation field under [Installation - Main](#) for more information.

This page is used when you have an alternate way to define a premise's address. This is typically used in countries that use multiple character sets (e.g., the **Main** address is entered in Chinese, the **Alternate Address** is entered in English). When a premise has an alternate address, both the main and alternate addresses can be used to search for a premise.

Open **Menu** > **Customer Information** > **Premise** > **Search** and navigate to the **Alternate Address** page to maintain this information.

Description of Page

The remaining fields on the page are used to define the premise's alternate address.

The address's constituent fields vary based on the **Country**. **Country** is always protected on this page because a premise's alternate address must be located in the same country as its main address. Please refer to the [Country](#) page for more information about address constituents.

NOTE:

Default note. An alternate address's **state**, **city** and **county** default from your postal default information. Refer to [Setting Up Premise & Service Point Postal Defaults](#) for more information.

The **Swap Main / Alt Address** button becomes enabled when you've entered an **Alternate Address**. When clicked, the contents of the address on the **Main** tab are swapped with the **Alternate Address**.

Premise - Premise Portal

Select **Menu** > **Customer Information** > **Premise** and navigate to the **Premise Portal** page to view additional information associated with a Premise.

Depending on your implementations requirements, you may define additional zones to appear on this Portal.

The contents of this section describe the zones that are available on this portal page.

General Information

Premise ID, **Premise Info** are displayed.

Maintaining Service Points

Refer to [Maintaining Service Points](#) in the [Device Installation](#) chapter for information about the **Service Point** zone and maintaining service points.

Service point records contain information describing the services supplied to a premise.

The following methods list the various ways in which service points can be created:

- A service point can be added when a premise is created using the [premise replicator](#).
- A service point can be added when an [order](#) is completed.
- A service point can be added using this transaction.

FASTPATH:

For more information about service points and their place in the "V", refer to [Understanding The "V"](#). For more information about the relationships between premises, service points, meters and items, refer to [An Illustration Of A Premise](#).

Dashboard Portal

The [Dashboard](#) is a portal that always appears on the Oracle Utilities Customer Care and Billing desktop. Its zones contain tools and data that are useful regardless of the object being displayed.

NOTE:

User configurable. Refer to [Each User Can Customize Which Zones Appear](#) for information about a user can configure which zones appear.

Global context. The system automatically refreshes the values saved in [global context](#) with information about the object that appears in [Object Display Area](#). Various zones available in the dashboard portal have been designed to display data related to a person id, account id or premise id, which are populated by the base global context algorithm C1-GLBL-CTXT.

The contents of this section describe the zones that are available on this portal.

NOTE:

Other zones exist. The zones described below are unique to Oracle Utilities Customer Care and Billing. Please see [Core Dashboard Zones](#) for a description of other zones that can appear on the dashboard.

Current Context Zone

The **Current Context Zone** contains basic information about the customer on which you are working.

A maximum of six rows may appear:

- The first row contains a person [context menu](#) and the person's name. You can click on the person's name to transfer to the [Person - Main](#) page. Note, the person's name is formatted by a plug-in algorithm on the [installation record](#). Refer to the base package's name format algorithm (PERS-INFO) for an example. If you prefer different formatting logic, your system administrator should configure the system appropriately.
- The second row contains an account [context menu](#) and the account's:
 - ID and check digit
 - The primary name of the main customer
 - Customer class
- The third row contains a premise [context menu](#) and the premise's address and premise type. Note, the address information is formatted by a plug-in algorithm on the [installation record](#). Refer to the base package's premise format algorithm (PREM-INFO) for an example. If you prefer a different format, your system administrator should configure the system appropriately.
- The fourth row contains a service point context menu and the service point's information; including:
 - Premise address
 - Service point type
 - Measurement cycle and route

- Status of the service point
- The fifth row contains a device context menu and the device's information; including:
 - Badge number
 - Device type
 - Device installation date/time
 - Status of the device
- The last row contains a measuring component context menu and the measuring component's information; including:
 - The associated device's badge number
 - Measuring component type

NOTE: If a premise has multiple service points, only one will be displayed in the Current Context Zone.

Customer Contact Zone

The **Customer Contact Zone** has three purposes:

- It shows the age of the **Last** customer contact associated with the person displayed in the Current Context zone. The word Today is shown if the last contact was on the current date. The word Yesterday is shown if the last contact was on the current date - 1 day. If neither is applicable, the number of days old is shown.
- It shows the name of the person who added this contact.
- It greatly simplifies the addition of a new customer contact. To add a new contact, simply select the **Type** of customer contact, enter a brief **Comment**, and press the **Add Contact** button.
- After the contact is added, you can click the hyperlink in the **Last** area to go to the newly added contact where you can set up [reminders](#) or indicate the contact should [remain open until future resolution](#).

Financial Information Dashboard Zone

The **Financial Zone** that appears on the dashboard contains the same information that is described in the [Financial Information Zone](#) on the account information portal.

Alert Dashboard Zone

The **Alert Zone** that appears on the dashboard contains the same information that is described in the [Alert Zone](#) on the account information portal.

Customer Context Zone

Along with the [Premise Context Zone](#), the Customer Context Zone is an alternative to the Current Context Zone. It contains basic information about the customer on which you are working. When a person or account is in context, the following information appears:

- Customer Name
- Primary Person Identifier

- Account ID. When the person in context is the main customer on multiple accounts, this will appear as a drop down, allowing for selection and switching between these accounts in context.
- Current Balance
- Aged Debt Bar. If the account's Current Balance is greater than zero, a colored bar is displayed adjacent. This bar provides information about the age of the account's debt.
- CIS Division. This appears only when multiple divisions exist.
- Customer Class
- Related Financially Responsible Persons

NOTE: The base package delivers this zone configured on the Dashboard Portal but with the **Display** turned off by default. To enable the Customer Context zone, navigate to your [User - Portal Preferences](#), open the Dashboard portal settings and turn on the **Display** option for the Customer Context zone.

Premise Context Zone

Along with the [Customer Context Zone](#), the Premise Context Zone is an alternative to the [Current Context Zone](#).

The zone contains a tree that shows the various objects linked to the premise in context as well as any additional premise(s) associated to the account in context. You can use this tree to both view high-level information about these objects and to transfer to the respective page in which an object is maintained.

NOTE: Refer to the C1-PremiseTree [tree](#) definition for more information about the premise tree node definitions and hierarchy.

Moving Service options are used to initiate start, stop, or transfer service requests.

NOTE: The base package delivers this zone configured on the Dashboard Portal but with the **Display** turned off by default. To enable the Premise Context zone, navigate to your [User - Portal Preferences](#), open the Dashboard portal settings and turn on the **Display** option for the Premise Context zone.

Setting Up Bill Print Groups

Bill print groups allow you to categorize an account's service agreements into groups for bill print purposes.

NOTE:

Bill print groups are optional. Typically, only accounts with many SAs will use bill print groups because the standard bill print priority is sufficient for accounts with a limited number of SAs. Refer to [SA Type - Billing](#) for more information about the standard bill print priority.

Let's use an example to clarify the bill print group concept. Consider a local government's account. This account would have many service agreements (some for the police department, others for the court system, others for the department of public works, etc.).

If you don't create a bill print group for this customer, their bill segments will be printed in the order dictated by each segment's service agreement's SA type's bill print priority. If you create a bill print group for this customer, you can define the customer's desired categories (e.g., police, courts, DPW, etc.) and then link each of the account's SAs to the appropriate category.

NOTE:

Nomenclature. We refer to the categories under a bill print group as "subgroups". A bill print group can have an unlimited number of subgroups. When you create a subgroup, you define its relative bill print priority and the associated verbiage to print on the bill (assuming you print information about the subgroup on the bill).

We'd like to highlight the following characteristics of bill print groups:

- A bill print group is associated with a specific account. If multiple customers have the exact categorization preferences, you will have to set up multiple bill print groups.
 - Over time, a customer could have many bill print groups. This would happen if a customer's bill categorization preferences change over time. We'd like to stress that while an account can have multiple bill print groups, only one will be used by the bill print process (the one effective on the bill date).
 - Bill print groups only affect printed bills. Bill print groups do not affect the order in which service agreements appear on the bill maintenance transaction.
 - If new service agreements are added after a bill print group is set up for an account, they will not be linked to a subgroup. If you neglect to link the new service agreements to one of the bill print group's subgroups they will be printed under the "default" subgroup (every bill print group must have one default subgroup to cater for this situation).
-

WARNING:

While the system supports the definition of bill print groups and the categorization of an account's service agreements into the various subgroups, the base package's bill print extract does NOT take advantage of this information.

The topics in this section describe how to set up a bill print group and how to link an account's service agreements to its subgroups.

Bill Print Group - Main

Open **Menu > Customer Information > Bill Print Group > Search** to maintain an account's bill print group and subgroups. After defining this information, transfer to the **SA Sub Group** page to link the account's service agreements to the subgroups.

Description of Page

The **Bill Print Group ID** is displayed on every page. This value only appears after the bill print group exists on the database. The ID is a system-assigned random number that stays with a bill print group for life.

Enter the **Account ID** associated with the bill print group.

Use **Effective Date** to define when the bill print group is effective for the account. This date is important as it allows a customer to change their preferences over time. For example, if the customer wants to change the number of subgroups on a given date, you would simply add a new bill print group effective on this date and then define the new subgroups (and link each service agreement to one of the subgroups).

Use **Status** to define if the bill print group is Active or Inactive. You would only use the Inactive value if the bill print group is no longer needed (as there is no delete action on this transaction).

Enter a brief **Description** of the bill print group.

Use **Comments** to describe anything special about the bill print group.

The grid contains the bill print group's subgroups. The following information should be defined for each subgroup:

- **Bill Print Sub Group.** This is the unique identifier of the bill print subgroup.
- **Sub Group Bill Print Priority.** This is the relative print priority of the subgroup in respect of the other subgroups.

- **Use as Default.** Turn on this switch for the default sub group. A bill print group must have one and only one default subgroup. The default group is used by the bill print process if it detects a service agreement that is not linked to a subgroup (it links this service agreement to the default subgroup).
- **Sub Group Description.** This is a brief description of the subgroup.
- **Description on Bill.** This is the verbiage that will print on the bill (assuming you print something on your bills for the subgroup).

After defining the bill print group's subgroups, navigate to the **SA Sub Group** tab to link the account's service agreements to the subgroups.

Bill Print Group - SA Sub Group

This page is used to link the account's service agreements to one of the bill print group's subgroups.

Open **Menu > Customer Information > Bill Print Group > Search** and navigate to the **SA Sub Group** page to maintain this information.

Description of Page

The **Bill Print Group's ID**, **Account ID** and **Effective Date** are displayed at the top of the page.

The filters control the service agreements that appear in the **SAs in Bill Print Group** grid. The following points describe the various options:

- Use the **SA Filter** to define the types of service agreements that appear in the grid. The following options are available:
 - **Address.** Use this option to restrict service agreements to those linked to service points associated with a given **Address**, **City** and/or **Postal** code. Note, you can specify any combination of these fields.
 - **All.** Use this option if you do not wish to restrict service agreements based on service agreement attributes.
 - **Bill Print Sub Group.** Use this option to restrict service agreements to those that are linked to a given **Bill Print Sub Group**.
 - **Geographic Type.** Use this option to restrict service agreements to those linked to service points associated with a given **Geo Type** and **Value**.
 - **SA Type.** Use this option to restrict service agreements to those linked to a given **CIS Division** and **SA Type**.
- Use **Status Filter** to restrict the service agreements based on their status. The following options are available:
 - **All.** This option shows all service agreements regardless of status.
 - Refer to [Service Agreement Lifecycle](#) for the various status values.

Don't forget to click the search button after changing the filters.

The **SAs in Bill Print Group** contains an entry for every non-cancelled service agreement linked to the account that is linked to one of the bill print group's subgroups. The following information appears in the grid:

- Use **Bill Print Sub Group** to define the subgroup associated with the service agreement.
- Use **Sequence** when there is more than one service agreement in the subgroup. The sequence controls the order in which the service agreement's financial information appears on the bill.
- The **SA Information** column provides a brief description of the service agreement.
- The **Service Agreement** column contains the unique identifier of the service agreement.
- The **Premise Information** column contains the characteristic premise associated with the bill segment's service agreement.

The next set of filters control the service agreements that appear in the **SAs Not in Bill Print Group** grid. The following points describe the various options:

- Use the **SA Filter** to define the types of service agreements that appear in the grid. The following options are available:
 - **Address.** Use this option to restrict service agreements to those linked to service points associated with a given **Address, City** and/or **Postal** code. Note, you can specify any combination of these fields.
 - **All.** Use this option if you do not wish to restrict service agreements based on service agreement attributes.
 - **Geographic Type.** Use this option to restrict service agreements to those linked to service points associated with a given **Geo Type** and **Value**.
 - **SA Type.** Use this option to restrict service agreements to those linked to a given **CIS Division** and **SA Type**.
- Use **Status Filter** to restrict the service agreements based on their status. The following options are available:
 - **All.** This option shows all service agreements regardless of status.
 - Refer to [Service Agreement Lifecycle](#) for the various status values.

Don't forget to click the search button after changing the filters.

The **SAs Not in Bill Print Group** contains an entry for every non-cancelled service agreement linked to the account that is NOT linked to one of the bill print group's subgroups. The following information appears in the grid:

- Use **Bill Print Sub Group** to define the subgroup associated with the service agreement.
- Use **Sequence** when there is more than one service agreement in the subgroup. The sequence controls the order in which the service agreement's financial information appears on the bill.
- The **SA Information** column provides a brief description of the service agreement.
- The **Service Agreement** column contains the unique identifier of the service agreement.
- The **Premise Information** column contains the characteristic premise associated with the bill segment's service agreement.

Landlord Reversion

Landlord reversion occurs when a landlord would like to have service reverted to their name when a tenant moves out. The landlord defines their reversion preferences using a [landlord agreement](#).

- A landlord's preferences can differ for each type of service. For example, you can indicate that a specific landlord always wants electric and gas service reverted to their account when a tenant stops service. However, they do not want water service to revert.
- A landlord's preferences can also be seasonal. For example, you can indicate water service should only revert to the landlord's account during the winter.

The account to use for the reversion of service is defined on the landlord agreement.

Assuming that you have plugged-in a landlord reversion algorithm on [SA type](#), the system uses the information defined on landlord agreement to create a pending start service agreement(s) for the landlord when service for the existing tenant is stopped.

The following examples illustrate how your organization's landlord reversion algorithm might handle various scenarios for a premise that defines a landlord agreement that indicates service should be reverted:

- When the existing customer calls to stop service and no new customer is scheduled to move in, a pending start service agreement is created for the landlord.
- When a new customer calls in to start service
 - If the start date matches the outgoing customer's start date, the pending start service agreement for the landlord is canceled

- If the start date is earlier than the outgoing customer's stop date, the pending start service agreement for the landlord is canceled and the stop date of the outgoing customer is changed to match the new date
- If the start date is later than the outgoing customer's stop date, the pending start service agreement for the landlord is updated with a stop date that matches the new customer's start date
- If changes are made to start or stop dates for the tenants' service agreements, a service agreement for the landlord may need to be created or canceled
 - If the change in dates causes a gap in service that did not exist before, a landlord service agreement is created to cover the gap
 - If the change in dates means that the tenants are now starting and stopping on the same date (and there used to be a gap), a landlord service agreement is canceled
- If the new customer cancels their pending stop, a landlord service agreement is created (if one did not exist) or the landlord SA's stop date is removed (if the new customer's start date resulted in a gap that was being covered by the landlord).

Setting Up Landlord Agreements

The landlord agreement page is used to maintain a landlord's service reversion preferences.

NOTE:

A landlord could have many landlord agreements. A landlord will have at least one landlord agreement. However, if the landlord has different service reversion preferences for different properties, you can create multiple landlord agreements - one for each set of preferences. After a landlord's reversion preferences have been defined, link the landlord agreement record to the respective premises.

Use **Menu > Customer Information > Landlord Agreement > Search** to maintain a Landlord Agreement.

Description of Page

Landlord and **Landlord ID** only appear after the landlord is added to the database. **Landlord ID** is a system-assigned random number that stays with the landlord agreement for life. **Landlord** is the description of the landlord agreement.

If the [premise management](#) module is not [turned off](#), a message is displayed indicating the number of premises linked to this landlord. Clicking the hyperlink message text transfers you to the [premise management](#) page, which helps you to [manage the premises linked to the landlord](#).

Enter a **Description** of the landlord agreement.

Use **Account ID** to define the account to use when service is reverted to the landlord. This should be one of the landlord's accounts.

The grid that follows contains one row for each type of service to be reverted to the landlord's account. Any service point whose service type is not referenced in this scroll will NOT revert to the landlord's account when a tenant stops service. For each row define the following:

- **Service Type** defines the type of service point that will revert to the landlord's account when a tenant stops service. Note, a service point inherits its service type from its SP Type.
- Turn on **Seasonal** if the service should only revert to the landlords account during a specific season of the year. When turned on, you must define the **Start Month/Day** and the **End Month/Day** of the effective season.

NOTE:

The month and day must be entered in the format MM/DD. For example, if a season starts on March 1, you must enter the value as 03/01.

Using The Premise Replicator

You use the premise replicator to create many copies of a premise and its service points.

Perform the following steps to replicate a premise:

- Add a [premise](#).
- Add one or more [service points](#) to the premise.
- Use the [premise replicator](#) to create copies of the premise and its service points.

The topics in this section describe how to use the premise replicator.

Premise Replicator - Main Information

You use this page to create many copies of a given premise and its service points.

WARNING:

The system warns you if you attempt to create. However, this is just a warning as you may want to generate similar premises and then update them with, for example, a unique apartment number on [Premise - Main Information](#).

Use **Menu > Customer Information > Premise Replicator** to open this page.

Description of Page

Choose the **Premise** that serves as the template premise.

NOTE:

Recommendation. Carefully verify the template premise using the other pages in this page before you save the replicated premises. After you save the replicated premises, any corrections could prove time consuming.

The two sections at the top of the page determine the number of replica premises to be created and the address information that will be set up for each premise. The left section is used to define how the system will create the part of the address that is *different* for each replica premise. The right section defines the parts of the address that will be the *same* for each replica premise.

In the left section:

Use the **Replicate** option to control how the position of the replicated number in the first address line:

- Choose Street Number if the replicated number should prefix the **Base** value in the first address line of the premise. For example, if you have a **Start #** of 1020 and a **Base** value of Main St and you choose the Street Number option, the first replicated premise will be 1020 Main St.
- Choose Apartment Number if the replicated number should suffix the **Base** value in the first address line of the premise. For example, if you have a **Start #** of 1020 and a **Base** value of 101 Main St, Apt. and you choose the Apartment Number option, the first replicated premise will be 101 Main St, Apt. 1020 .

Indicate the **Number Of Premises** you wish to create.

Use **Base** to define the information that will appear at the end of the first address line on each of the replicated premises. Use **Start #** to define the number assigned to the first copy of the premise. Use **Increment** to define the value to increment successive numbers by. The first and last address lines to be created by the replicator are displayed below.

For example, if the first address you want to create is 101 Derby St, and the last address is 199 Derby and you want to do the odd numbered side of the street, you'd enter the following parameters:

Number of Premises would be 50

Address Suffix would be Derby St

Start From would be 101

Increment by would be 2

The right section displays the rest of the address information that will be copied onto each replicated premise. This information is defaulted from the template premise that you selected. The Address 1 field is not shown because you define the information to be entered there in the previous section, as explained above. The remaining fields, however, may be edited if so desired.

After entering the parameters, click the **Replicate** button to generate your new premises. You can use the sections at the bottom of the page to view the premises that will be created when you click save. The left section will show how Address Line 1 will look on the first 10 premises. If you are creating more than 10 premises, the right section will show how Address Line 1 will look on the last 10 premises. If everything looks clean, click save.

Premise Replicator - Premise

The Premise page is a display only page provided to let you confirm that the premise you selected on the add dialog is the one to be used as the template by the replicator. Use **Menu > Customer Information > Premise Replicator** and navigate to the **Premise** page.

Description of Page

This is a display only page that displays key information about the premise being replicated.

Premise Replicator - Premise SPs

This is a display only page provided to let you confirm that the premise you selected on the add dialog is the one to be used as the template by the replicator. Use **Menu > Customer Information > Premise Replicator** and navigate to the **Premise SPs** page.

Description of Page

This is a display only page that displays the details about the template premise's service points.

Start/Stop

The topics in this section describe how to start and stop service.

WARNING:

Please see [Order versus Start/Stop](#) for a discussion of the pros and cons of using the order transaction versus the start/stop transaction to start service.

The Big Picture Of Starting Service

Almost all requests to start service involve a conversation between a customer and a customer service representative (CSR). During this conversation, the following is defined:

- WHO will pay for the service (i.e., the account).
- WHERE the service is consumed (i.e., the premise). Note, this is only required for premise-oriented services.
- WHEN the service is requested (i.e., the start date).
- WHAT TYPE of service is desired (i.e., the service agreement and service points).
- HOW MUCH will be paid for the service (i.e., the rate and contract riders).

After the conversation is complete, one or more service agreements in the state of pending start will exist. If the service agreement uses service points, field activities may also be created.

In this section, we provide background information about the start process. For information about the page used to start service, refer to [Start Stop Maintenance](#).

The Lifecycle Of A Pending Start Service Agreement

When you request a new service for a customer, a pending start service agreement is created. The following diagram illustrates the lifecycle of a typical pending start service agreement:

The Lifecycle Of A Pending Start Service Agreement

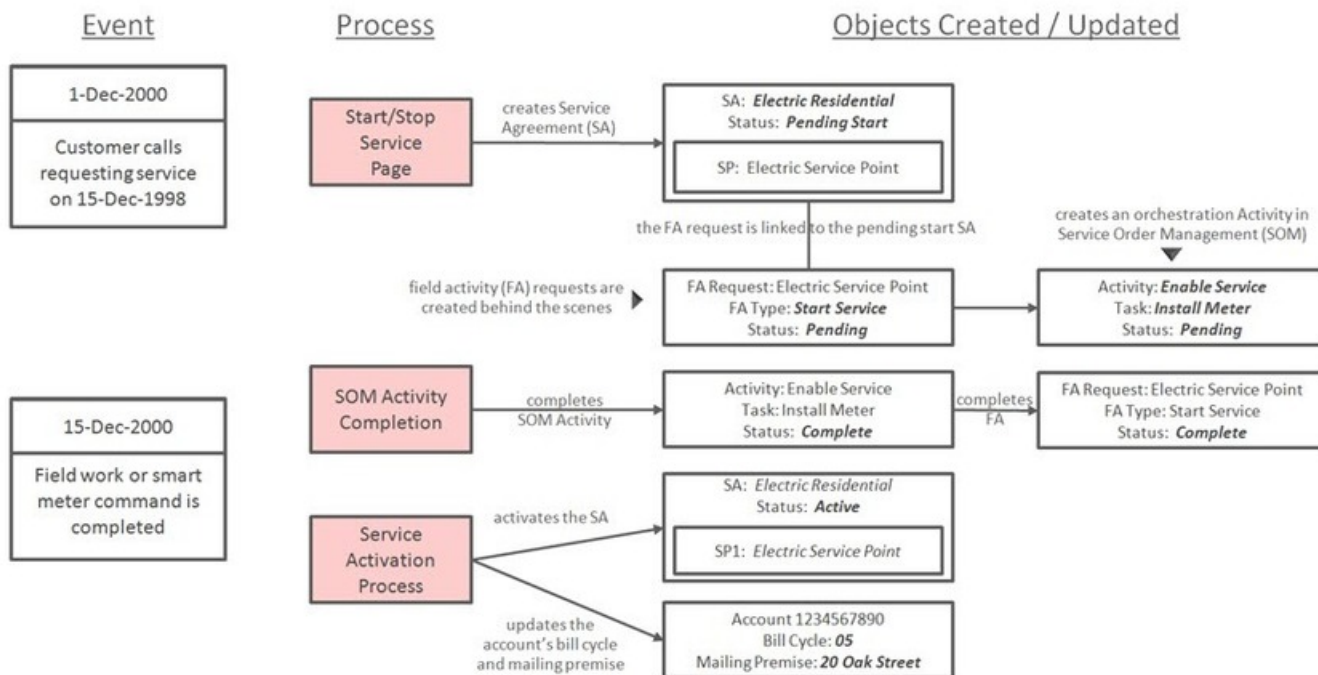

The above diagram is referenced in the topics that follow.

Starting Service and Field Activities

When you initiate a request to start service, the system creates a service agreement in the state of pending start. If the service agreement is service point-oriented, pending field activity requests necessary to start will be created at some point prior to the service agreement being activated. The question is when? The contents of this section provide information about when they are created and what types of activities are created.

FASTPATH:

When you enable the Control Central alert algorithm, C1-PEND-STRT, an alert displays when there is a pending start service agreement linked to the account. This algorithm is plugged-in on the [installation record](#).

What Type Of Start Field Activities Are Created

The type of customer event (such as, start service, stop service, and cut for non-payment) dictate the type of field activity request generated. If you've setup your system properly, the system creates the appropriate orchestration activity for the field activity request, based on the type of service point, state of the service (such as, disconnected-no meter and connect-meter installed) at the service point, state and capabilities of the device;. You shouldn't have to be aware of field activity requests and orchestration activities.

In addition to being linked to the service points, these field activity requests are also linked to the service agreement / service point relationship so that the system can automatically activate the service agreement when the field activity requests are complete.

NOTE:

Back-to-Back. We use the term **back-to-back** to describe the situation when a single field activity supports both the stop and start service requests. The fieldwork algorithm delivered with the base package sets up a back-to-back situation by default when it is aware of both the start AND stop customers at a premise.

FASTPATH:

For more information about the field activities associated with your SP types, refer to [Setting Up Field Activity Type Profiles](#). Refer to [The System Activates Most Service Agreements Behind-The-Scenes](#) for information about how the system monitors field activities linked to a service agreement.

When Start Field Activities Are Created

Field activity requests will be created when the pending start service agreement is created if the following conditions are true:

- The Create Field Activity Start Stop switch is enabled on the installation record. Refer to [Installation Options - Main](#) for more information.
- The appropriate create fieldwork creation algorithm is defined on the service agreement's SA type. Refer to [SA Type - Algorithms](#) for more information.

If the Create Field Activity Start Stop switch is NOT enabled on the installation record, field activity requests will NOT be created when the pending start is saved. Rather, a background process (PSASPM) creates the field activity requests shortly before the start date. The number of days before the start date on which field activity requests will be created is defined on the service agreement's SA type's fieldwork creation algorithm.

NOTE:

A fail safe. If any person or process attempts to activate a pending start service agreement and neither of the above events has taken place, field activities will be created when the user attempts to activate the pending start. The creation of the field activities will prevent the service agreement from being activated as described under [The System Activates Most Service Agreements Behind The Scenes](#).

WARNING:

Field activity requests will only be created if you have defined the appropriate field work creation algorithm on the service agreement's SA type. The algorithm that is supplied with the base package checks if the service agreement / service point already has a start field activity request, if so, field activity requests will not be created (the field work has already been initiated).

Activating Pending Starts

When you initiate a request to start service, the system initiates a service agreement in the state of pending start. A pending start service agreement remains in this state until everything necessary to start service is defined in the system. At that time, the service agreement can be activated.

What Is Necessary To Start Service?

The service agreement's SA type defines what is necessary to start service:

- For SA types that have service points, all field activity requests linked to the service point must be complete before the service agreement can be activated.
- For SA types that don't have service points (e.g., charitable donations, deposits, one-time charges), everything necessary to activate the service agreement is defined when you initiate the request to start service. These types of service agreements can be activated immediately.

The System Activates Most Service Agreements Behind-The-Scenes

Service agreements are activated by one of the following methods:

- The SA activation background process ([SAACT](#) or [C1-ACTSA](#)) automatically activates pending start service agreements once it detects that everything necessary to start service is defined in the system. This is the most common method for activating service agreements. This process runs as often as your organization desires (but it should run at least daily).

NOTE:

Sub SAs are not handled by the SA activation background process. If your organization uses the [SA relationship](#) functionality and you have service providers that necessitate [sub service agreements](#), you should be aware that the SA activation background process only activates normal and master SAs; sub SAs are activated by the [analyze SA relationships](#) background process (described in the next bullet point).

- If your organization uses the [SA relationship](#) functionality and you have service providers that necessitate [sub service agreements](#), the analyze SA relationships background process ([ANLYZSAR](#)) automatically activates pending start sub SAs if their master SA is active.
- You can automatically activate a service agreement when it's created if you plug-in an SA creation algorithm of type SACR-AT on the SA type. Because everything necessary to start service must be defined in the system before a

service agreement can be activated, this method only works for SA types that don't have service points (e.g., charitable donations, deposits, one-time charges, etc.). If this algorithm is not plugged in on an SA type, service agreements of that type are activated by the SA activation background process or manually.

- You can activate a service agreement manually (assuming everything that's necessary to activate service is in place). Simply open [Service Agreement - Main](#) and click the **Activate SA** button. This is only necessary if you do not want to wait until the SA activation background process next runs.

What Happens At Activation Time?

When a service agreement is activated, the following takes place:

- The service agreement's state is changed from pending start to active.
- If the account's bill cycle is not protected and the service agreement has a metered service point, the bill cycle will be changed to reflect the service point's *measurement cycle's* bill cycle.
- If the account's mailing premise is not protected and the service agreement has a service point whose premise is a mailing premise, the mailing premise is changed to reflect the service point's premise.
- If the account's division is not protected, the division is changed to reflect the service agreement's SA type's division.
- If there is a start adjustment defined on the service agreement's start option, an adjustment is levied.
- The main customer's billing address is changed to reflect the value specified on the Start/Stop page (and this may involve changing the main customer's override mailing address on their person record).

What Happens After A SA Is Started?

FASTPATH:

Refer to [The Lifecycle Of A Service Agreement](#) for more information about a service agreement's lifecycle.

The Big Picture Of Stopping Service

To stop service you must define:

- WHO pays for the service (i.e., the account).
- WHEN service should stop (i.e., the stop start date).
- WHAT services to stop (i.e., the premise or specific service agreements).

After the above is defined in the system, the state of one or more service agreements will be changed to pending stop. If the service agreement uses service points, field activities may also be created.

In this section, we provide background information about the stop process. For information about the page used to stop service, refer to [Start Stop Maintenance](#).

The Lifecycle Of A Pending Stop Service Agreement

When you request to stop service for a customer, the status of an existing service agreement becomes pending stop. The following diagram illustrates the lifecycle of a typical pending stop service agreement:

The Lifecycle Of A Pending Stop Service Agreement

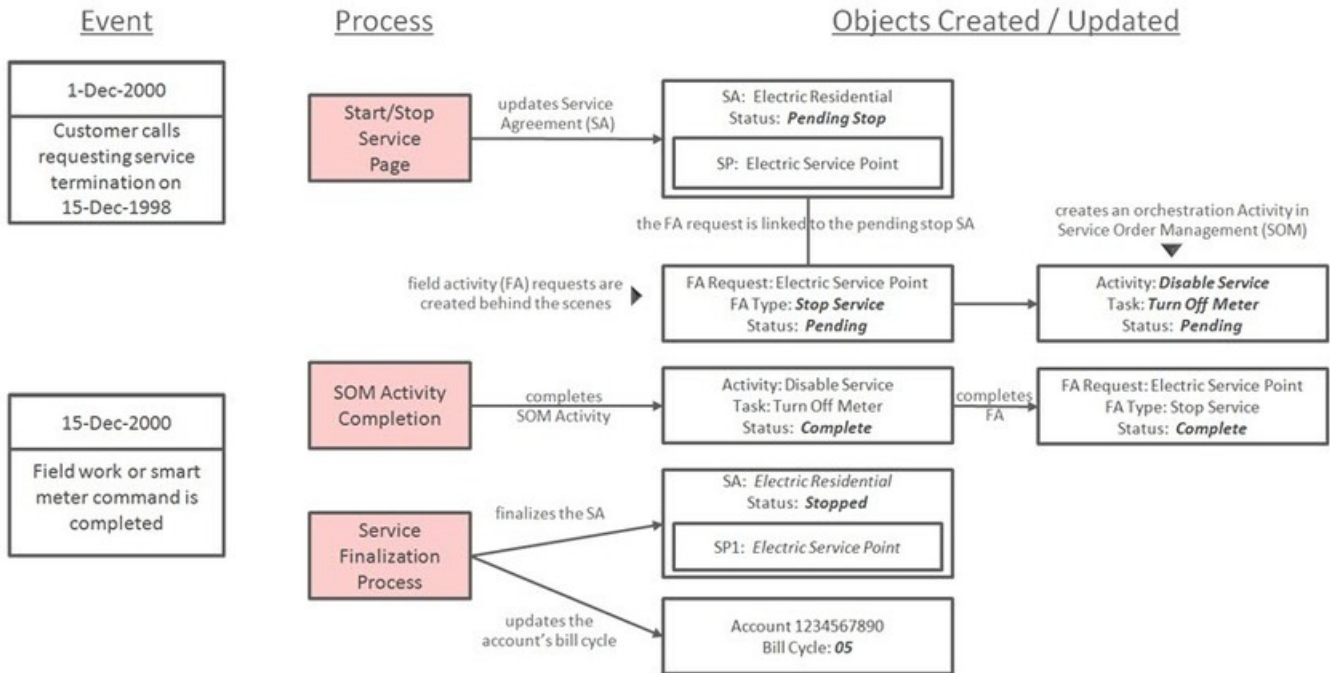

The above diagram is referenced in the topics that follow.

Stopping Service and Field Activities

When you initiate a request to stop service, the system changes the service agreement to the state of pending stop. If the service agreement is service point-oriented, pending field activity requests necessary to stop will be created at some point prior to the service agreement being stopped. The question is when? The contents of this section provide information about when they are created and what types of activities are created.

What Type Of Stop Field Activities Are Created

The type of customer event (such as, start service, stop service and cut for non-payment) dictate the type of field activity request. If you've setup your system properly, the system creates the appropriate orchestration activity for the field activity request, based on the type of service point, state of the service (such as, disconnected-no meter and connect-meter installed) at the service point, state and capabilities of the device. You shouldn't have to be aware of field activity requests and orchestration activities.

In addition to being linked to the service points, these field activity requests are also linked to the service agreement / service point relationship so that the system can automatically stop the service agreement when the field activities are complete.

NOTE:

Back-to-Back. We use the term **back-to-back** to describe the situation when a single field activity supports both the stop and start service requests. The fieldwork algorithm delivered with the base package sets up a back-to-back situation by default when it is aware of both the start and stop customers at a premise.

FASTPATH:

For more information about the field activity requests associated with your SP types, refer to [Setting Up Field Activity Type Profiles](#). Refer to [The System Finalizes Most Service Agreements Behind-The-Scenes](#) for information about how the system monitors field activity requests linked to a service agreement.

When Stop Field Activities Are Created

Field activity requests will be created when the pending stop service agreement is recorded when the following conditions are true:

- The Create Field Activity Start Stop switch is enabled on the installation record. Refer to [Installation Options - System](#) for more information.
- The appropriate create fieldwork creation algorithm is defined on the service agreement's SA type. Refer to [SA Type - Algorithms](#) for more information.

If the Create Field Activity Start Stop switch is NOT enabled on the installation record, field activity requests will NOT be created when the pending stop is saved. Rather, a background process (PSASPM) creates the field activity requests shortly before the stop date. The number of days before the stop date on which field activities will be created is defined on the service agreement's SA type's fieldwork creation algorithm.

NOTE:

More information about the Create Field Activity Start Stop switch on the installation record. When this switch is on (and the user doesn't override it), pending field activity requests will be created when a start or stop is recorded (as opposed to shortly before the start/stop date).

A fail safe. If any person or process attempts to finalize a pending stop service agreement and neither of the above events has taken place, field activity requests will be created when the user attempts to finalize the pending stop. The creation of the field activity requests will prevent the service agreement from being stopped as described under [The System Finalizes Most Service Agreements Behind The Scenes](#).

WARNING:

Field activity requests will only be created if you have defined the appropriate field work creation algorithm on the service agreement's SA type. The algorithm that is supplied with the base package checks if the service agreement / service point already has a stop field activity request, if so, field activity requests will not be created (the field work has already been initiated).

Finalizing Pending Stops

When you initiate a request to stop service, the system changes the service agreement's state to pending stop. A pending stop service agreement remains in this state until everything necessary to stop service is defined in the system. At that time, the system automatically changes the state of the service agreement to stopped, and at that time the service agreement can be final billed.

So, how does the system know that "everything necessary" is in the system? In this section we provide the answer and explain the many other things that may take place at pending stop finalization.

The System Finalizes Most Service Agreements Behind-The-Scenes

The SA activation background process ([SAACT or C1-STPSA](#)) finalizes a pending stop service agreement when everything necessary is in place. The service agreement's SA Type defines what's necessary:

- For SA Types that don't have service points (e.g., charitable donations, deposits, third party billing), everything necessary to finalize the service agreement is defined when you initiate the request to stop service. These types of service agreements can be finalized immediately.
- For SA Types that have service points, all field activity requests linked to the service point must be complete.

When the SA activation background process detects that everything necessary to stop service is in place, it automatically stops the service agreement. This process runs as often as your organization desires (but it should run at least daily).

NOTE:

Sub SAs are not handled by the SA activation background process. If your organization uses the [SA relationship](#) functionality and you have service providers that necessitate [sub service agreements](#), you should be aware that the SA activation background process only stops normal and master SAs; sub SAs are stopped by the [analyze SA relationships](#) background process.

You can stop a service agreement real-time (assuming everything that's necessary to stop service is in place). Simply open [Service Agreement - Main](#) and click the **Stop** button.

What Happens At Finalization Time?

When a service agreement is finalized, the following takes place:

- If the service agreement's SA type has a [SA Stop algorithm](#), the algorithm is executed.
- If the service agreement is for a [non-billed budget](#) (i.e., the SA type has a special role of Non-billed Budget), the system removes all covered SAs from the Non-Billed Budget. Refer to [Stopping Non-Billed Budgets](#) for more information.
- If the service agreement is covered by a [non-billed budget](#), the SA is removed from the Non-Billed Budget. Refer to [Stopping a Covered SA](#) for more information.
- When the last active service agreement covered by a non-billed budget is stopped, the Non-Billed Budget will be [stopped](#) (i.e., its state will be changed from active to pending stop).
- The service agreement's state will be changed from pending stop to stopped.
- If the service agreement has an active severance process, the process and its severance events will be canceled.
- If the service agreement is linked to an active collection process, the service agreement is "removed" from the collection process. If the collection process has no other active service agreements, it is canceled.
- When the last service agreement linked to an account is stopped, the account's bill cycle will be changed so that the account will be final billed when billing next executes. The system selects the latest open bill cycle where the Freeze and Complete switch value matches the value of the Freeze and Complete switch of the account's current bill cycle. In addition, the account's protect bill cycle flag is set to No so that the next time this account starts service, its bill cycle will be set based on the new service point's service cycle.
- The main customer's billing address will be changed to reflect the value specified on the Start/Stop page (and this may involve changing the main customer's override mailing address on their person record).
- If the service agreement is for a deposit (i.e., the SA type has a special role of Cash Deposit), the system calculates interest through the stop date. In addition, the SA's current balance is synchronized with its payoff balance (using the sync adjustment code defined on the service agreement's SA type).
- When the last active service agreement governed by a deposit class is stopped, all active deposit service agreements governed by the same deposit class will be stopped (i.e., their state will be changed from active to pending stop). These pending stop deposit service agreement will then be stopped (as per the above points).

- When a service agreement is stopped, the system automatically cancels the budget. Refer to [Canceling A Budget](#) for more information.

What Happens After A Service Agreement Is Stopped?

FASTPATH:

Refer to [The Lifecycle Of A Service Agreement](#) for more information about a service agreement's lifecycle.

Start/Stop Maintenance

You use the start/stop page to both start and stop service.

This page handles a variety of scenarios, including:

- Starting some or all services at a premise. Note, the system will automatically stop the existing customer when you indicate a new customer is starting.
 - Stopping some or all services at a premise. Note, the system will automatically revert service to a landlord's account when you indicate a tenant is stopping.
 - Starting non-premise-oriented services.
 - Stopping non-premise-oriented services.
 - Changing the mailing address associated with the account's main customer.
-

FASTPATH:

Refer to [The Big Picture Of Starting Service](#) for more information about starting service. Refer to [The Big Picture Of Stopping Service](#) for more information about stopping service.

The topics in this section describe the start/stop page in detail.

Start/Stop - Main

FASTPATH:

The **Description of Page** section that appears below simply describes the fields on this page. Refer to [How To](#) for a description of how to perform common start/stop functions.

Use **Menu > Customer Information > Start/Stop** to open this page.

Description of Page

The **Account ID** and the primary name of the **Account's** main customer are displayed at the top of the page.

If the total number of pending start/stops for the account does not exceed the start stop details threshold defined in [Installation Options](#), the grid contains an entry for every Pending Start and Pending Stop service agreement linked to the **Account ID**.

If information appears on the right portion of the grid, that means that "reciprocal relationships" exist. The following points describe potential reciprocal relationships:

- A reciprocal will be shown for a Pending Start service agreement if the Pending Start service agreement has at least one service point and if another service agreement is found that satisfies the following criteria:
 - The status of the service agreement is not Canceled or Active ,
 - The service agreement is linked to all of the Pending Start service agreement's service points (and all SA/SP records have the same stop date as defined on the qualifying service agreement).
 - The service agreement's stop date is on/before the start date.
 - The service agreement's SA type has a service type that is the same as the Pending Start service agreement's service type.
- Note: if multiple service agreements meet the above criteria, the latest qualifying service agreement is shown as the reciprocal.
- A reciprocal will be shown for a Pending Stop service agreement if the Pending Stop service agreement has at least one service point and if another service agreement is found that satisfies the following criteria:
 - The status of the service agreement is not Canceled
 - The service agreement is linked to all of the Pending Stop service agreement's service points (and they all have the same start date as defined on the qualifying service agreement).
 - The service agreement's start date is on/after the stop date.
 - The service agreement's SA type has a service type that is the same as the Pending Stop service agreement's service type.
- Note: if multiple service agreements meet the above criteria, the earliest qualifying service agreement is shown as the reciprocal.

NOTE:

If multiple reciprocals exist for a given SA, none of the reciprocals will be shown. In this situation, an appropriate message is displayed highlighting this situation. The existence of multiple reciprocals is rare, but it could happen, for example, if multiple customers are paying for a service point's service (where one customer pays for 60% of the metered consumption and the other pays for the remaining 40%).

The following columns appear in the grid:

Drill Down (button) Click this button to drill down into details of the pending start/stop SA. This button transfers you to the **Pending SA** tab.

Action An icon will be displayed to highlight if the associated SA is a pending start or a pending stop. The start icon (green octagon) appears if the SA is a pending start. The stop icon (red octagon) appears if the SA is a pending stop. If there is a reciprocal SA for the pending **start**, the stop icon appears adjacent; clicking it will cause the SA grid to scroll to the left (so that you can see the pending stop). If there is a reciprocal SA for the pending **stop**, the start icon appears adjacent; clicking it will cause the SA grid to scroll to the left (so that you can see the pending start).

Date This is the start date for pending start service agreements and the stop date for pending stop service agreements.

Cancel Turn on this switch if you wish to cancel the pending start/stop.

NOTE:

Field activity requests will be cancelled too. If you cancel a pending start/stop that has field activity requests, the field activity requests will also be cancelled. Refer to [Starting Service and Field Activities](#) for the details about how the system automatically creates the field activity requests to support start service requests. Also, refer to [Stopping Service and Field Activities](#) for the details about how the system creates the field activity requests to support stop service requests.

System-generated reciprocals will be cancelled too. If you cancel a pending start/stop that has a SYSTEM-GENERATED reciprocal SA, the reciprocal will also be cancelled.

Premise Information If a characteristic premise is linked to the service agreement, summary information about the pending start/stop SA's characteristic premise is displayed.

SA Information Summary information about the pending start/stop SA is displayed.

Action If this column is blank, then there is no reciprocal start/stop for the service agreement whose details appear to the left. If this column is not blank, then the information that appears to the right describes the reciprocal SA of the SA to the left. If a reciprocal SA exists, two icons will always appear: if a start and stop combination appears, the SA to the left is a pending stop (and clicking the stop icon will cause the pending stop to appear); if a stop and start combination appears, the SA to the left is a pending start (and clicking the start icon will cause the pending start to appear).

Date This is the start date for pending start service agreements and the stop date for pending stop service agreements.

Cancel Turn on this switch if you wish to cancel the pending start/stop.

NOTE:

Field activity requests will be cancelled too. If you cancel a pending start/stop that has field activity requests, the field activity requests will also be cancelled. Refer to [Starting Service and Field Activities](#) for the details about how the system automatically creates the field activity requests to support start service requests. Refer to [Stopping Service and Field Activities](#) for the details about how the system creates the field activity requests to support stop service requests.

System-generated reciprocals will be cancelled too. If you cancel a pending start/stop that has a SYSTEM-GENERATED reciprocal SA, the reciprocal will also be cancelled.

Account Info The name of the main customer associated with the reciprocal's service agreement's account is displayed.

Premise Information Summary information about the pending start/stop premise is displayed.

SA Information Summary information about the pending start/stop SA is displayed.

If the total number of pending start/stops for the account exceeds the start stop details threshold defined in [Installation Options](#), the **Total** number of **Pending Starts** and **Total** number of **Pending Stops** is displayed together with a grid containing a summary of the pending start and pending stops.

The grid contains an entry for every group of Pending Start / Pending Stop service agreement linked to the **Account ID** with the same pending start / pending stop date, action, premise, and CIS division/SA Type.

The following columns appear in the grid:

Date This is the start date for pending start service agreements and the stop date for pending stop service agreements.

Action An icon will be displayed to highlight if the associated SA(s) are pending start or pending stop. The start icon (green octagon) appears if the SA(s) are a pending start. The stop icon (red octagon) appears if the SA(s) are a pending stop. Click the icon to navigate to the [Start Stop - Pending SA](#) tab where the associated pending start / pending stop service agreements will be displayed.

Premise Information Summary information about the pending start/stop premise is displayed.

CIS Division / SA Type This is the CIS division and service agreement type of the pending start / pending stop service agreements.

Total This is the total number of service agreements with the same **Date**, **Action**, **Premise**, and **CIS Division / SA Type**.

Following the Pending Start / Pending Stop grid are two sections; one is used to start service, the other is used to stop service.

The following points describe the fields in the start service section (refer to [How To](#) for a description of how to perform common start functions).

- Use **Start Date** to define the date on which you want service to commence.

- Use **Start Method** to define what you want to start. Valid values are:
 - Start Premise SPs. Use this method if you want to start selected services at a premise. This method allows you to control the display of the service agreements to be started, providing a manageable view when there are many service agreements to be started at a premise.
 - Start a Premise. Use this method if you want to start services at a premise.
 - Start a SA. Use this method if you want to start a non-premise-oriented service (e.g., a deposit, a charitable contribution, a one-time charge).
- If you have selected the Start Premise SPs or Start a Premise option, use **Address** and **City** to select the premise. Refer to [Control Central - Search](#) for suggestions in respect of how to use these fields. The selected address and premise ID appear below the selection.

NOTE: If the service agreement's account's CIS Division's **Restrict to Account CIS Division** flag is set to *Restricted*, the premise search is restricted to the premises without a CIS Division and those whose CIS Division matches the account's CIS Division,

- If you have selected the Start a SA option, use **CIS Division** and **SA Type** to define the type of service agreement you wish to start.

NOTE: If the service agreement's account's CIS Division's **Restrict to Account CIS Division** flag is set to *Restricted*, the CIS Division is set to the account's CIS Division and cannot be changed.

WARNING:

Take special care when adding a new service agreement to specify the appropriate CIS Division / SA Type as it will affect how the customer is billed, what rate can be specified, how overdue debt is collected, and much more. After the service agreement is activated, you may not change its SA type.

- Use **Requested by** to define who requested the stop (e.g., Customer, Jane Smith).
- Click the **Start** button to start service. When you click this button, the [Start Confirmation](#) page appears.

The following points describe the fields in the stop service section (refer to [How To](#) for a description of how to perform common stop functions).

- Use **Stop Date** to define the date on which you want service to stop.
- Use **Stop Method** to define what you want to stop. Valid values are:
 - Stop Selected SAs. Use this method if you want to stop selected service agreements linked to the account.
 - Stop a Premise. Use this method if you want to stop ALL services at a premise.
 - Stop a SA. Use this method if you want to stop a specific SA.
 - Stop all Active SAs. Use this method if you want to stop ALL service agreements linked to the account.
- If you have selected the Stop a Premise option, choose the **Premise ID**. You can optionally choose a specific premise if you selected the Stop Selected SAs option.
- If you have selected the Stop a SA option, choose the **SA ID**.
- Use **Requested by** to define who requested the stop (e.g., Customer, Jane Smith).
- Click the **Stop** button to stop service.

NOTE: Manual date entry is disabled on the start and stop dates and the date picker must be used when the Disable Manual Date Entry **Option Type** on the Customer Information Options [Feature Configuration](#) has been enabled.

Start/Stop - Start Confirmation

The Start SA Confirmation page appears after a user clicks the **Start** button on [Start/Stop - Main](#). This page presents a summary of the service agreement(s) that will be created if the **Start** button on this page is clicked. Refer to [How To](#) for a description of how to perform common start functions.

Description of Page

The **Account ID** and the primary name of the account's main customer are displayed at the top of the page.

The **Start Date** is the date on which the service is scheduled to start.

Start Requested By contains the name of the person who requested the start.

The **SAs to Start** scroll contains an entry for every service agreement that will be created if you click the **Start** button. If you do not want a service agreement to be created, click the - button (or turn off **Start this SA**). If you'd like to start a non-premise oriented service agreement, click the + button. The following fields appear on this page:

Start this SA Turn this switch on if you want this type of service agreement to be created. Turn this switch off if you do not want this type of service agreement to be created.

If you used a **Start Method** of Start a SA on the Start/Stop page, this switch will be turned on by default.

If you used a **Start Method** of Start a Premise (or Start Premise SPs) and this is the first customer at a premise, this switch will be turned on for all service agreements that appear in the scroll. However, if there was a previous customer at the premise, this switch is only turned on for those types of service agreements used by the previous customer (we assume the new customer only wants the services used by the previous customer). Service agreements that are possible, but were not used by the previous customer, will appear in the scroll with this switch turned off.

CIS Division / SA Type These fields define the type of service agreement that will be created. If you change the CIS Division, you must change the SA Type to reflect one of the services that the division manages.

NOTE: If the service agreement's account's CIS Division's **Restrict to Account CIS Division** flag is set to *Restricted*, the CIS Division is set to the account's CIS Division and cannot be changed.

If the SA is linked to a service point, the SA types are restricted based on the type(s) of service points (SP) the system has associated with the service agreement (as indicated in the message box). If there are no SPs, only SA types that don't use SPs are displayed. If there is a single SP, only SA types valid for the related SP Type are displayed. If there are multiple SPs, only SA types valid for all related SP Types are displayed.

Start Option Some SA Types have [start options](#). A start option defines the rate and contract terms defaulted on the service agreement. This field will be gray if the SA type does not use start options.

Total Amount to Bill Use this field if the service agreement is supposed to bill a given amount over its lifetime. This is typically used for deposit service agreements to define the amount of the deposit that should be billed. If the deposit is billed in installments, the installment amount is specified in the next field. This field is gray if the respective SA type doesn't use the Total Amount to Bill option.

 This button is only appears if the SA type has a "special role" of Cash Deposit and references a deposit class. When clicked, the system attempts to calculate a recommended deposit amount by calling the recommended deposit amount algorithm that is plugged in on the SA type's deposit class.

Customer Read Use this value to define if the customer reads their own meter. Valid values are Yes and No. This field does not appear for some SA types.

Allow Estimates Turn on this switch if it's OK for the system to use estimated usage from Oracle Utilities Meter Data Management for this service agreement's agreement consumption if a real meter read is missing at billing time. If the SA type does not allow estimates, this does not appear.

Recurring Charge Amount This field's label is dynamic based on the content of the Recurring Charge Amount Label on the respective SA Type. This field is gray if the respective SA type doesn't use the Recurring Charge option. This field is typically used only for the following types of service agreements:

- Service agreements on a levelized payment plan. This field contains the amount charged each month for the service regardless of the actual amount owed.
- Merchandise service agreements on an installment plan. This field contains the installment amount.
- Deposit service agreements on an installment plan. This field contains the installment amount.
- Charitable contribution service agreement. This field contains the contribution amount.

NOTE:

Default note. The recurring charge amount defaults based on the **Start Option**.

SIC Select the SIC code associated with the customer. This is typically used only for commercial and industrial customers.

Business Activity Enter a description of the business activity at the location where this service is being started.

SA Information This is a display-only area that provides information about the specific pending start SA. For example, information about the service points linked to the SA will be displayed for SP-oriented service agreements.

Messages This is a display-only area that provides information about the account's start/stop situation in general. For example, if there are multiple accounts paying for service at the premise an appropriate message will be displayed.

When you click the **Start** button, the system performs the following for every service:

- A service agreement is created effective on the start date.
- If a start option is specified, the service agreement's rate and contract terms are populated using information on the option. If a start option is not specified, the service agreement's rate is populated with the SA type's default rate.
- Service points are linked to the service agreement (if the service agreement is service point-oriented). The SA/SP start date for each service point is the same as the SA's start date.

If you use a **Start Method** of Start Premise SPs on [Start/Stop - Main](#), the **SAs to Start** are displayed in a grid; you can control the service agreements that appear using filter options. You may want to use the filter if you have a premise with a large number of service agreements to start.

Premise Info displays summary information about the premise at which services are to be started.

The section beneath **PremiseInfo** provides you with options that control which service agreements appear in the grid. The following points describe the various options:

- Use the **SP Type Filter** to restrict the service agreements that appear in the grid based on the SP type of the service points that will be linked to the service agreement. The following options are available:
 - All. Use this option if you do not wish to restrict service agreements based on service point type.
 - Specific SP Type. Use this option to restrict service agreements to those that will be linked to service points of a specific **SP Type**.
- Use the **Geographic Type Filter** to restrict the service agreements that appear in the grid based on a geographic type and value of the service points that will be linked to the service agreement. The following options are available:
 - All. Use this option if you do not wish to restrict service agreements based on a geographic type and value.
 - <Geographic Type>. Use this option to restrict service agreements to those that will be linked to service points associated with the selected geographic type and **GeographicValue**.
- Select whether to Include or Exclude service agreements that are linked to service points where **Service Exists Already**. These service agreements are those that would be not be started by default. Refer to the description of the **Start this SA** checkbox for more information on service agreements that would be not be started by default.

Don't forget to click the search button after changing the filters.

The **Select All / Clear All** buttons are used to select service agreements to start. These buttons are enabled if at least one service agreement is displayed in the grid.

NOTE:

30 service agreements at a time. Clicking **Select All** selects the first 30 service agreements in the grid. If more than 30 service agreements exist, you must select and start them in batches.

The grid that displays contains the **SAs to Start** that match your filter criteria. Click the drill down button to open the **Start SA Confirmation Details** page.

The fields in the grid on the Start SA Confirmation page and on the Start SA Confirmation Details page are as described above for the **SAs to Start** scroll. Differences are highlighted here:

SP Info This is summary information about the service point at which service is to be started.

SP Identifier The service point's SP type's identifying geographic type and value. Refer to [Understanding Service Point Types](#). Up to three geo types and values are displayed in the SAs to Start grid.

Click the **Start** button on the Start SA Confirmation page to start the selected SAs. Click on the **Close** button to return to the main page - any changes made on this page since the last time you clicked **Start** are discarded.

Start/Stop - Stop Confirmation

If you choose the stop method of Stop Selected SAs, the Stop SA Confirmation page appears after a user clicks the **Stop** button on [Start/Stop - Main](#). This page presents a summary of the service agreement(s) that will be stopped if the **Stop** button on this page is clicked. Refer to [How To](#) for a description of how to perform common start stop functions.

Description of Page

The **Account ID** and the primary name of the account's main customer are displayed at the top of the page.

The **Stop Date** is the date on which the service is scheduled to stop.

Requested By contains the name of the person who requested the stop.

The section beneath **Requested By** provides you with options that control which service agreements appear in the grid. The following points describe the various options:

- Use the **Premise Filter** to restrict the service agreements to those that are linked to a specific characteristic premise. The following options are available:
 - All. Use this option if you do not wish to restrict service agreements based on premise.
 - No Premise. Use this option to restrict service agreements to those that do not have a characteristic premise.
 - Specific Premise. Use this option to restrict service agreements to those with a characteristic premise of **Premise ID**.
- Use the **SA Type Filter** to restrict service agreements to those of a given SA Type.
 - All. Use this option if you do not wish to restrict service agreements based on SA Type.
 - Specific SA Type. Use this option to restrict service agreements to those of a given **CIS Division** and **SA Type**.
- Use the **Geographic Type Filter** to restrict the service agreements that appear in the grid based on the geographic type and value of the service points that are linked to the service agreement. The following options are available:
 - All. Use this option if you do not wish to restrict service agreements based on a geographic type and value.
 - <Geographic Type>. Use this option to restrict service agreements to those that will be linked to service points / premises associated with the selected geographic type and **Geographic Value**.

Don't forget to click the search button after changing the filters.

The **Select All / Clear All** buttons are used to select service agreements to stop. These buttons are enabled if at least one service agreement is displayed in the grid.

NOTE:

30 service agreements at a time. Clicking **Select All** selects the first 30 service agreements in the grid. If more than 30 service agreements exist, you must select and stop them in batches.

The grid that follows contains the service agreements to stop that match your filter criteria. The following information appears in the grid:

Select Box Use this checkbox to select service agreements that you want to stop.

Premise Information Summary information about the pending stop premise is displayed.

SA Information Summary information about the pending stop SA is displayed.

SP Identifier The service point's SP type's identifying geographic type and value. Refer to [Setting Up Service Point Types](#). Up to three geo types and values are displayed.

Click the **Stop** button on the Stop SA Confirmation page to stop the selected SAs. Click on the **Close** button to return to the main page - any changes made on this page since the last time you clicked **Stop** are discarded.

Start/Stop - Address/Phone

Open **Menu > Customer Information > Start/Stop** and navigate to the **Address/Phone** page to change basic information about a customer while you are starting or stopping service.

NOTE:

A subset of person and account information. This page features a subset of person and account fields that typically change when a customer moves. You can always use the [Person](#) or [Account](#) transactions to change this information.

This information is held in limbo. The information on this page will only be updated on the respective person / account when the first service agreement linked to the account is activated or stopped (i.e., this information is held in limbo until the pending start / pending stop is activated / stopped).

Main customer information. The information on this page is associated with the account's main customer (as defined on [Account - Person Information](#)). If you need to change information about any other person linked to the account, you must transfer to [Account - Person Information](#) and make the changes there.

Use **Bill Route Type** to indicate how the bill is sent to the customer. If the **Bill Route Type** you select indicates that bills are routed via fax, make sure you specify a fax number in the **Telephone Numbers** below (note, the system knows which of a [person's phone numbers](#) is a fax number by the phone type). If the **Bill Route Type** you select indicates that bills are routed via Email, make sure to specify the person's **Email Address** below. If the **Bill Route Type** you selected indicates that bills are routed via the postal service, select the appropriate **Address Source**. You have the following options:

- Choose Mailing Premise on Account if bills should be sent to the [account's mailing premise](#). This address is displayed below.
- Choose Person if bills should be sent to the [person's mailing address](#). This address is displayed below.
- Choose Account Override if bills should be sent to the [account person's override address](#). This address is displayed below. Typically, you would only choose this option if the person has multiple accounts and each account's bills should be sent to a different address.

If the **Address Source** is Person or Account Override , the respective address fields are displayed and may be changed. If the **Address Source** is Mailing Premise on Account, the account's mailing premise is displayed and cannot be modified. Refer to [Premise - Main Information](#) for information about these fields.

NOTE:

Default note. If you switch the **Bill Route Type** from a non-postal to postal routed, the **Address Source** defaults to the bill address source defined on the account (if one exists) or Mailing Premise on Account if bill address source is not specified for the main customer.

NOTE:

By default, the **Address Source** field is protected on Start/Stop– Address/Phone page if the **Bill Route Type** is set to a value other than Postal. To enable the **Address Source** field for all **Bill Route Types** in most circumstances, set the Always Enable Address Source option type on the General System Configuration feature configuration to Y.

Regardless of the **Always Enable Address Source** option value, **Address Source** and **Address Information** are displayed but both are disabled when **Bill Routing Method** is *Not Postal* and **Quote Routing Method** (on Account – Persons page) is *Postal*. A message “*The Main Person receives Quotes at this address. To edit it, go to the 'Persons' tab on the Account.*” is displayed next to the **Address Source**.

FASTPATH:

Refer to [Setting Up Bill Route Types](#) for more information about bill route types.

NOTE:

The person contact collections appears when the Legacy Person Phone and Email Option Type on the Customer Information Options [Feature Configuration](#) has **not been** enabled.

The person contacts, from the [Person - Main](#) page are displayed so that you can review and update them as necessary.

NOTE: The Email Address field appears when the Legacy Person Phone and Email Option Type on the Customer Information Options [Feature Configuration](#) has been enabled.

Specify the customer's **Email Address**. This can be used to route bills to the customer via email (if your bill routing software supports this function).

Telephone Numbers are used by [Control Central](#) to look for accounts and persons. If the person has more than 20 phone numbers, the first 20 will be shown as display only with a message indicating that more phone numbers exist until you save your start or stop. Once the start or stop has been saved, you are able to modify the phone number collection.

NOTE: The Person Phone grid appears when the Legacy Person Phone and Email **Option Type** on the Customer Information Options [Feature Configuration](#) has been enabled.

The following fields display:

- **Phone Type** indicates the type of phone number, e.g., Home, Mobile, Business, ...
 - Use **Phone Number** to define the telephone number. Enter the telephone number in the format described by the **Phone Format**.
-

NOTE:

Formatting is performed by a plug-in. The format that is applied to a **Phone Number** is controlled by the algorithm that is plugged in on the respective [Phone Type](#). If you prefer a different format, your system administrator should configure this algorithm appropriately.

- Enter the **Extension**, if any, of the telephone number.
-

Start/Stop - Pending SA

If you need to change additional information about the pending start or stop SAs, navigate to the **Pending SA** tab. Alternatively, you can click the Drill Down button on the SA grid of the **Main** tab.

Description of Page

If the total number of pending start/stops for the account does not exceed the start stop details threshold defined in [Installation Options](#), an entry appears in the scroll for each entry in the SA grid on the main page. Use the **Pending Start/Stop SA** navigation arrow buttons to select the pending SA you want to review or modify. This page is split between the primary SA on the top, and the reciprocal SA on the bottom. The following fields are available.

Primary SA:

SA Info Summary information about the pending start/stop SA is displayed.

Cancel Turn on this switch if you wish to cancel the pending start/stop.

Date This is the start date for pending start service agreements and the stop date for pending stop service agreements.

Reason This column indicates if the pending start/stop is System Generated or Customer Requested. System-generated starts are created when a tenant stops service at a premise covered by a landlord agreement. System-generated stops are created when a customer requests a start at a premise where the existing customer hadn't already requested a stop.

CIS Division / SA Type These fields define the type of service agreement that will be created. These fields will be gray if the service agreement is pending stop.

If you change the CIS Division, you must change the SA Type to reflect one of the services that the division manages.

If the SA is linked to a service point, the SA types are restricted based on the type(s) of service points (SP) the system has associated with the service agreement (as indicated in the message box). If there are no SPs, only SA types that don't use SPs are displayed. If there is a single SP, only SA types valid for the related SP Type are displayed. If there are multiple SPs, only SA types valid for all related SP Types are displayed.

Start Option Some SA Types have [start options](#). A start option defines the rate and contract terms defaulted on the service agreement. This field will be gray if the SA type does not use start options or if the service agreement is pending stop.

Premise Summary information about the pending start / stop premise is displayed.

Reciprocal SA:

SA Info Summary information about the pending start/stop SA is displayed.

Cancel Turn on this switch if you wish to cancel the pending start/stop.

Date This is the start date for pending start service agreements and the stop date for pending stop service agreements.

Reason This column indicates if the pending start/stop is System Generated or Customer Requested. System-generated starts are created when a tenant stops service at a premise covered by a landlord agreement. System-generated stops are created when a customer requests a start at a premise where the existing customer hadn't already requested a stop.

CIS Division / SA Type These fields define the type of service agreement that will be created or stopped. This field will be gray if the service agreement is pending stop.

If you change the CIS Division, you must change the SA Type to reflect one of the services that the division manages.

If the SA is linked to a service point, the SA types are restricted based on the type(s) of service points (SP) the system has associated with the service agreement (as indicated in the message box). If there are no SPs, only SA types that don't use SPs are displayed. If there is a single SP, only SA types valid for the related SP Type are displayed. If there are multiple SPs, only SA types valid for all related SP Types are displayed.

Start Option Some SA Types have [start options](#). A start option defines the rate and contract terms defaulted on the service agreement. This field will be gray if the SA type does not use start options or if the service agreement is pending stop.

Premise Summary information about the pending start / stop premise is displayed.

Account The name of the main customer associated with the reciprocal's service agreement's account is displayed.

If the total number of pending start/stops for the account exceeds the start stop details threshold defined in [Installation Options](#), the pending start/stop SAs and their reciprocal SAs are displayed in a grid; you can control the service agreements that appear using filter options.

The section beneath **Account** provides you with options that control which service agreements appear in the grid. The following points describe the various options:

- Use the **SA Action Filter** to restrict the service agreements that appear in the grid to pending starts or pending stops. The following options are available:
 - All. Use this option if you do not wish to restrict service agreements based on SA Action.
 - Start. Use this option to restrict service agreements to pending starts.
 - Stop. Use this option to restrict service agreements to pending stops.
- Use the date filter to restrict service agreements to those that will start or stop between the **From Date** and the **To Date**.
- Use the **Premise Filter** to restrict the service agreements to those that are linked to a specific characteristic premise. The following options are available:
 - All. Use this option if you do not wish to restrict service agreements based on premise.
 - No Premise. Use this option to restrict service agreements to those that do not have a characteristic premise.
 - Specific Premise. Use this option to restrict service agreements to those with a characteristic premise of **Premise ID**.
- Use the **SA Type Filter** to restrict service agreements to those of a given SA Type.
 - All. Use this option if you do not wish to restrict service agreements based on SA Type.
 - Specific SA Type. Use this option to restrict service agreements to those of a given **CIS Division** and **SA Type**.
- Use the **Geographic Type Filter** to restrict the service agreements that appear in the grid based on the geographic type and value of the service points that are linked to the service agreement. The following options are available:
 - All. Use this option if you do not wish to restrict service agreements based on a geographic type and value.
 - <Geographic Type>. Use this option to restrict service agreements to those that will be linked to service points / premises associated with the selected geographic type and **Geographic Value**.

Don't forget to click the search button after changing the filters.

The **Select All** / **Clear All** buttons are used to select service agreements if you plan on issuing any of the mass update actions at the bottom of the page. These buttons are enabled if at least one service agreement is displayed in the grid.

NOTE:

30 service agreements at a time. Clicking **Select All** selects the first 30 service agreements in the grid. If more than 30 service agreements exist, you must select and start them in batches.

The grid that displays contains the service agreements that match your search criteria. Click on the drill down button to open the **Pending SA Details** page.

Please refer to the **Pending Start/Stop SA** scroll for a description of the fields in the pending start/stop SA grid on the Pending SA tab and on the Pending SA Details page. Additional fields are described here:

Pending SAs Grid:

- **Select box.** Use this checkbox to select service agreements for mass update.
- The **Action** icons highlight if the associated SA is a pending start or a pending stop and if there are reciprocal SAs. Refer to the action icon on [Start Stop - Main](#).

Mass Update Buttons:

Use the **Cancel Selected** button to cancel the selected pending start/stops together with any associated reciprocal pending start/stops. This button is enabled if you have selected one or more pending SAs.

Use the **Change Start/Stop Date** button to change the start/stop date for the selected pending start/stop service agreements. If a selected start/stop has a reciprocal SA, its start/stop date is also changed. This button is enabled if you have selected one or more pending SAs.

Start/Stop - Pending Field Activity

When you start/stop service point-oriented service, field activity requests are typically created. You can view every non-cancelled, non-complete field activity linked to the account's service agreements on the **Pending Field Activity** page.

NOTE:

The field activity requests are NOT limited to those associated with starting / stopping service. So, if a customer has a pending "cut for non payment" field activity request, it would also appear on this page.

Description of Page

An entry appears in the scroll for every Pending field activity request linked to the account's service agreements. The information in the **Field Activity** column contains a summary of the field activity request and its service point. The information in the **How Used** column describes the purpose of the field activity request (such as, Start Activity, Stop Activity, and Severance Activity).

If the total number of pending start/stops for the account exceeds the start stop details threshold defined in [Installation Options](#), you can control the field activity requests that appear using filter options.

The section beneath **Account** provides you with options that control which field activity requests appear in the grid. The following points describe the various options:

- Use the **Schedule Date** filter to restrict the field activity requests that appear in the grid to those that are scheduled between. The following options are available:
 - All. Use this option if you do not wish to restrict field activities to a specific schedule date.
 - Specific Date. Use this option to restrict the field activities to those with a schedule date between the **From Date** and the **To Date**.
- Use the **Premise Filter** to restrict the field activity requests to those that are linked to service points at a specific premise. The following options are available:
 - All. Use this option if you do not wish to restrict field activity requests based on premise.
 - Specific Premise. Use this option to restrict field activity requests to those linked to a service point at the given **Premise ID**.
- Use the **SP Type Filter** to restrict field activity requests to those that are linked to service points of a given SP Type.
 - All. Use this option if you do not wish to restrict field activity requests based on SP Type.
 - Specific SA Type. Use this option to restrict field activity requests to those of a given **SP Type**.
- Use the **Geographic Type Filter** to restrict the field activity requests that appear in the grid based on the geographic type and value of the service points that are linked to the service agreement. The following options are available:
 - All. Use this option if you do not wish to restrict field activity requests based on a geographic type and value.
 - <Geographic Type>. Use this option to restrict field activity requests to those that are linked to service points / premises associated with the selected geographic type and **GeographicValue**.

Don't forget to click the search button after changing the filters.

How To

The topics in this section describe how to perform common start/stop functions.

How To Start Service At A Premise

The following instructions specifically reference the *Start a Premise* Start Method. You can also use the *Start a Premise's SPs* Start Method and its corresponding user interface.

You navigate through the pages as follows:

- Use [Control Central - Search](#) to look for the customer. If the customer exists, click the Start Service button to transfer to Start/Stop. If the customer doesn't exist, add a new person/account by following the instructions under [How To Add A New Customer From Control Central](#).
- Specify the **Start Date**, **Start Method** (Start a Premise), and select a premise (by entering the premise **Address** and clicking the search button).
- Click the **Start** button to review the various service agreements that will be created.

NOTE:

Service agreements are created. Each row in the scroll is associated with a service agreement. When you close the page, the system creates new service agreements in the state of pending start.

- If you're starting service at a premise, the system automatically populates the Start Confirmation page with information about every service agreement to be created. To do this, we make a basic assumption - the customer wants every service at the premise. If this assumption is incorrect, simply remove the service agreement from the scroll (by turning off the **Start this SA** switch) before closing the page.

NOTE:

Automatically stop the existing customer. If there's a customer currently paying for service at the premise, the system automatically sets up the stop information for the existing customer. The stop date of the existing customer is the start date of the new customer. If you don't want to stop the existing customer, simply indicate such in the scroll.

WARNING:

Take special care when adding a new service agreement to specify the appropriate CIS Division and SA Type as it will affect how the customer is billed, what rate can be specified, how overdue debt is collected, and much more. After the service agreement is activated, you may not change its CIS Division / SA type.

FASTPATH:

Refer to [Starting Service and Field Activities](#) for the details about how the system automatically creates the field activity requests to support start service requests.

How To Stop Service At A Premise

The following instructions specifically reference the *Stop a Premise* Stop Method. You can also use the *Start Selected SAs* Stop Method and its corresponding user interface.

You navigate through the grid as follows:

- Use [Control Central - Search](#) to find the customer. Click the Stop Service button to transfer to Start/Stop.
- Specify the **Stop Date**, **Stop Method** (Stop a Premise), and select a **Premise** (the premise will have been pre-selected for you if you drilled down from Control Central).
- Click the **Stop** button to stop service at the premise.
- When you click the stop button, the system changes the status of each service agreement to pending stop and sets the stop date accordingly. If we stopped a service agreement that we shouldn't have, simply cancel the stop by checking the **Cancel** column in the grid (and save the page)

NOTE:

Landlord reversion. If you stop service at a premise that references a landlord agreement, the system will automatically create pending start service agreements for the landlord for those service types covered by the landlord agreement.

FASTPATH:

Refer to [Stopping Service and Field Activities](#) for the details about how the system creates the field activity requests to support stop service requests.

How To Start A Deposit

Charging a customer for a deposit involves creating a service agreement. Deposit service agreements are just like other service agreements in many ways:

- The system bills the customer for the deposit using information on the service agreement.
- The customer pays for the billed amount.
- If the customer doesn't pay, credit & collections starts a collection process to encourage the customer to pay.

Deposit service agreements differ from regular service agreements in the following ways:

- Deposit service agreements typically don't cause a receivable account to be affected when the deposit is billed. It is only when the deposit is paid that a financial transaction occurs (debit cash, credit deposit payable).
- Deposit service agreements have a credit balance when the billed amount is paid (the deposit paid by the customer is a liability of your company - it owes the customer this money).
- Deposit service agreements may be billed in installments or in a lump sum.

Creating a deposit service agreement involves the following steps:

- Select the account on Control Central and open Start/Stop.
- Enter a **Start Date** and **Start Method** of Start a Premise.
- Indicate the premise that the deposit service agreement will cover using the Address and click the **Start** button.
- After you click the **Start** button, the Start Confirmation page will appear:
 - Choose an appropriate **CIS Division / SA Type** for the deposit service agreement.
 - If **Start Options** have been created for the CIS Division / SA Type, you need only select the appropriate option and close the page. The system will use the information on the start option to populate the service agreement's billing parameters (e.g., the total deposit due, the installment amount, etc.).
 - If **Start Options** have not been created for the CIS Division / SA Type, you must define the total amount of the deposit and the installment amount, if any. You define the total amount of the deposit in **Total Amount To Bill**. You can have the system recommend a deposit amount by pushing the  that appears adjacent to this field.

- If you allow the customer to pay the deposit in installments, define the Installment Amount (the prompt for this field is defined on the SA type and therefore will differ depending on how you've set up the system). After defining this information, close the page. The system will use the information you entered to create a deposit service agreement.

NOTE:

The above information related to starting a deposit assumes that the deposit SA Type is set up as a premise-based service. If your company does not associate a deposit with a specific premise, you will need to set up your SA Type for the deposit accordingly. Then, you will need to use a Start Method of Start a SA.

How To Start A Charitable Contribution

If a customer elects to contribute money to a charitable organization, you must create a service agreement. Charitable contribution service agreements are just like other service agreements in many ways:

- The system bills the customer for the elected contribution amount using information on the service agreement.
- The customer pays the billed amount.
- If the customer doesn't pay, credit & collections may start a collection process to encourage the customer to pay (depending upon how the charitable contributions debt class has been set up on your system).

Charitable contribution service agreements differ from regular service agreements in the following ways:

- Charitable contribution service agreements typically don't cause a receivable account to be affected when the charitable contribution is billed. It is only when the charitable contribution is paid that a financial transaction occurs (debit cash, credit charitable contribution payable).
- Charitable contribution service agreements have no balance when the billed amount is paid because the money is being forwarded to a charity.

Creating a charitable contribution service agreement involves the following steps:

- Select the account on Control Central and open Start/Stop.
- Enter a **Start Date** and **Start Method** of Start a SA.
- Indicate the **CIS Division / SA Type** of the charitable contribution agreement and click the **Start** button.
- After you click the **Start** button, the Start Confirmation page will appear:
 - If **Start Options** have been created for the CIS Division / SA Type, you need only select the appropriate option and close the page. The system will use the information on the start option to populate the service agreement's billing parameters (i.e., the charitable contribution amount to be periodically billed).
 - If **Start Options** have not been created for the CIS Division / SA Type, you must define the charitable contribution amount (the prompt for this field is defined on the SA type and therefore will differ depending on how you've set up the system). After defining this information, close the page. The system will use the information you entered to create a charitable contribution service agreement.

How To Start A One-Time Charge Service Agreement

You create a one-time charge (i.e., billable charge) whenever a customer should be charged for a service that occurs outside the normal course of business. For example, you would create a billable charge to charge a contractor for the repair of a ruptured gas line.

A billable charge must reference a service agreement. This service agreement behaves just like any other service agreement:

- **Bill segments are created for the service agreement.** Whenever billing is performed for an account with billable charge service agreements, the system creates a bill segment for each unbilled billable charges.
- **Payments are distributed to the service agreement.** Payments made by an account are distributed to its billable charge service agreements just like any other service agreement.
- **Overdue debt is monitored.** The credit and collections process monitors billable charge service agreements for overdue debt and responds accordingly when overdue debt is detected.

Therefore, in order to levy a one-time charge, the customer must have a billable charge service agreement. If one already exists (because of a previous billable charge), you don't have to create a new service agreement. Rather, transfer to the Billable Charge page and add a billable charge for the service agreement. If the customer doesn't already have billable charge service agreement, create one by performing the following steps:

- Select the account on Control Central and open Start/Stop.
- Enter a **Start Date** and **Start Method** of Start a SA.
- Indicate the **CIS Division / SA Type** of the billable charge service agreement and click the **Start** button.
- After you click the **Start** button, the Start Confirmation page will appear. Simply close the confirmation page to save the agreement.
- After the billable charge service agreement has been created, add a billable charge to it (the easiest way is to use the SA context menu). Refer to [Maintaining Billable Charges](#) for more information.

How To Start Service When Multiple Service Points Measure Consumption

When you start service at a premise, the system automatically links service points to service agreements in the same manner as existed for the previous customer. So, if the previous customer amalgamated consumption of three service points and billed this under a single service agreement, the system will create the same configuration for the new customer.

This works fine when the unusual service point configurations have already been set up for the previous customer. However, it doesn't work when the premise is new. So, if you have a new premise that has multiple service points whose consumption needs to be amalgamated under a single service agreement, do the following:

- Start service for only one of the service points to be linked to the service agreement. When you start service, the system creates a service agreement, links the service point to it, and links a field activity to the service point.
- For every service point that wasn't linked to the service agreement:
 - Link the service point to the pending service agreement This task is done on [Service Agreement - SA / SP](#).
 - After linking all the service points to the pending service agreement, manually activate the service agreement. This task is done on [Service Agreement – Main](#). While the service agreement might not be truly activated at this time, this step ensures necessary field activity requests are created behind the scenes.

field activity requests

NOTE:

That's it. The activation process will automatically activate the service agreement when the fieldwork is complete on all of its service points.

Customer Contacts

Customer contacts are used to record when and why a customer contacted your company. They can also be associated with person, accounts, and premises. This information can be used for both audit and statistical purposes. The topics in this section provide details about how customer contacts are created and used in the system.

Person-Based Versus Premise-Based Customer Contacts

Customer Contacts can be linked to the person, account, and premise.

- If a person is associated with the customer contact, it is considered to be a person-based contact regardless of whether an account and/or premise are also associated with the contact.
- If only a premise is associated with the customer contact, the system will designate the contact as premise-based.
- Contacts that have an account associated with them must also have a person associated and the contact will become person-based. There are no account-based customer contacts.

Customer Contacts that are associated with a person, account, and/or premise can be accessed through each entity's context menu.

How Customer Contacts Are Created

You can add a Customer Contact at any time using either of the following methods:

- Use the [customer contact maintenance](#) page.
- Use the [Customer Contact Zone](#) on the dashboard.

When customer contacts are created through the Customer Contact dashboard zone, the system populates person, account, and/or premise based on context.

In addition to manually adding customer contacts, your implementation team can set up plug-in algorithms that create customer contacts when certain events transpire. For example, you can plug-in an algorithm on the [customer class](#) object that creates a customer contact whenever an order is completed. Because the number and type of plug-ins can be customized for your implementation, we cannot provide a concise list of all such algorithms.

In addition to the above, a variety of events can trigger the creation of a customer contact. Refer to [Customer Contacts Are Used To Trigger Letters](#) for the details.

Customer Contacts Are Used To Trigger Letters

In order to send a letter to a customer, a customer contact must be created for the customer. These types of customer contacts reference a customer contact type that, in turn, references a [letter template](#). The letter template controls the type of information that is merged into the "form letter" and how the letter is physically produced. Refer to [Printing Letters](#) for more information about letter templates and how letters are physically produced.

Because these letters are being sent to a customer, the customer contact that triggers a letter must be person-based. See [Person-Based Versus Premise-Based Customer Contacts](#) for more information.

Customer contacts that trigger letters can be produced by any of the method described under [How Customer Contacts Are Created](#). While a user can create this type of customer contact (e.g., if a customer requests a form to sign-up for automatic payment), the primary sources of customer contacts that trigger letters are via system events and algorithms. Besides algorithms, the following system events may generate customer contacts automatically:

- **Collection events.** When a customer falls in arrears, the system creates a collection process. A collection process is a series of events meant to encourage the customer to pay their outstanding debt. A classic collection event is one that creates a customer contact that, in turn, causes a letter to be sent to the customer requesting payment. These customer contacts are created with person and account populated. Refer to [The Big Picture Of Collection Events](#) for more information.

- **Severance events.** The last event in a collection process typically creates a severance process for each service agreement that's in arrears. A severance process is a series of events that leads to service being severed. A classic severance event is one that creates a customer contact that, in turn, causes a letter to be sent to the customer warning of impending cutoff (or telling them they've been cutoff and the terms necessary to reinstate service). These customer contacts are created with person and account populated. Premise is also populated if the service agreement being severed is associated with a premise. Refer to [The Big Picture Of Severance Events](#) for more information.
- **Write-off events.** After a customer has been final billed, a write-off process will be created. A write-off process is a series of events that leads to the debt being written off. A classic write-off event is one that creates a customer contact that, in turn, causes a letter to be sent to the customer informing them of that their debt has been referred to a collection agency. These customer contacts are created with person and account populated. Refer to [The Big Picture Of Write Off Events](#) for more information.
- **Overdue events.** Overdue processes can be used to collection on past due debt. An overdue process is a series of events that are used to collect on debt. Some overdue events may create a customer contact that, in turn, causes a letter to be sent to the customer. These customer contacts are created with person and account populated. Refer to [The Big Picture Of Overdue Events](#) for more information.

Your implementation team can introduce plug-in algorithms to create a customer contact when certain events take place. If the created customer contact references a letter template, a letter will be triggered. Because the number and type of plug-ins can be customized for your implementation, we cannot provide a concise list of all such algorithms.

Algorithms that are delivered with the product populate person, account, and/or premise based on the information available when the customer contact is created. For example, the field activity remark algorithm populates the premise and also the person and account if the field activity's service point is linked to a service agreement. From the service agreement the account and account's main person are obtained and used on the customer contact.

A Customer Contact May Trigger Reminders

If you want the system to remind you (via a [To Do entry](#)) about a customer-related issue, you can set up a "reminder" on a customer contact. To do this, follow these steps:

- Determine if you need a new customer contact or if you can reuse one that already exists. If you need a new customer contact, use any of the "online methods" described under [How Customer Contacts Are Created](#).
- Refer to the embedded help on the Customer Contact Reminders zone on the Customer Contact portal for more information about using reminders.

Customer Contacts Are Used To Record Notifications

Notification types may reference a customer contact type that is used to create a record of notifications of that type. This is supported for both message-based and template-based notifications. Refer to [Template-Based vs. Message-Based Notification Types](#) for more information.

Customer contacts create from template-based notifications contain more notification details and support an integration that updates the customer contact with information from an integration system such as *Oracle Integration Cloud* and also from the system responsible for delivering the notification. Customer contacts may also be added and updated by an integration system to record notifications initiated from an external system such as outage notifications that originate from a network management system.

Customer Contacts Can Be Used As Case Files

If a customer calls with a complaint (e.g., they suspect their bill is too high), you can start a "case file" for the complaint by creating a customer contact. This customer contact should be marked as "open".

NOTE:

Alerts. Customer contacts that are marked as being open cause an alert to appear when the customer is displayed on control central.

Over time, as you work on the case, you can add entries to the customer contact's log to describe your progress.

You can use the customer contact's [reminder](#) functionality to remind you to check out the case on a future date (or dates).

When the case is resolved, you simply turn off the customer contact's open indicator and add an appropriate entry to the log describing the resolution.

Maintaining Customer Contacts

Customer contacts are used to record when and why a customer contacted your company. This information is used for both audit and statistical purposes. The topics in this section describe how to maintain customer contacts. Refer to [The Big Picture Of Customer Contacts](#) for background information about customer contacts.

To view and maintain customer service requests, open **Menu > Customer Information > Customer Contact > Search**. You are brought to a query portal with options for searching for customer contacts.

Once a customer contact has been selected, you are brought to the maintenance portal to view and maintain the selected record.

The following zones are displayed:

- **Customer Contact**
- **Customer Contact Reminders**

Refer to the zones' embedded help for more information.

Printing Letters

As described under [Customer Contacts Are Used To Trigger Letters](#), you must create a customer contact whenever you want to send a letter to a customer. The contents of this section describe the technical implementation of letter production.

The Letter Extract Processes

Customer contacts that trigger letters reference a [customer contact type](#) that, in turn, references a [letter template](#). Two background processes are provided with system that control the information extracted into a file.

C1-LTPEX – Letter Extract

This process produces a letter extract file based on letter extract records that are configured with each letter template. Each letter template can be configured with a different set of record type. Some record types have configuration options such as which characteristic types to extract or how to identify the object to extract. This is a highly configurable extract that should reduce the need for a custom solution.

The record layouts can be viewed in the application on the Letter Template Extract Record List zone on the letter template portal.

NOTE:

This batch does not utilize the extract algorithm plug-in spot on letter template. The sample Online Letter Image algorithm provided with the system calls the letter template extract algorithm plug-in spot and is not compatible with this solution.

LTRPRT – Letter Extract

This process uses the extract algorithm on the letter template and is responsible for extracting the information merged onto your letters. These algorithms create the "flat file records" that are passed to your letter print software.

Additionally, the extract algorithm can be called if your letter print software has the ability to construct a real-time image of a letter (in a PDF). You can plug-in an Online Letter Image algorithm on the [Installation Record](#). This type of algorithm calls the letter template's extract algorithm to extract the information that is merged onto the letter. Refer to [Technical Implementation of Online Letter Production](#) for the details.

NOTE:

Alternate print / routing methods. If you require different print formats, you must create new letter extract algorithms and plug them in on your [letter template](#).

NOTE:

This process is not intended for new implementations. For information related to the record layouts produced by the sample algorithms provide for use with this process, please refer to the documentation supplied with CC&B 2.7.0.1 and earlier.

BI Publisher Versus Document Composition Applications

Using BI Publisher as your external reporting tool to display an online letter image differs from using document composition applications as follows:

- An extract file is not required when using BI Publisher. The sample reports provided to use with these external report tools do not have to extract information from another object to merge into a letter.
 - Generating letters in batch is not supported yet.
-

FASTPATH:

Refer to [Letter Print - BI Publisher Sample Welcome Letters - CI_LTRGN_ENG REPORT](#) for more information.

Where Does The Address Come From?

The following points describes the source of a letter's address:

- For letters generated as a result of collection events, severance events, write-off events and overdue events, the address is extracted as follows:
 - The respective [Account - Person](#) record is retrieved for the letter recipient (note, the account ID is retrieved from the related collection / severance / write-off / overdue process).
 - If the person has a [seasonal address](#) effective on the business date, the letter's address is the respective seasonal address.
 - If the address source is Mailing Premise on Account, the letter's address is the [account's mailing premise](#).

- If the address source is Account Override, the letter's address is the override address on the respective [Account - Person](#) record.
- If the address source is Person, the letter's address is the [person's mailing address](#).
- If the address source is not defined, the [person's mailing address](#) is used.
- If an address was not populated as a result of the above, the letter is not produced and a warning is issued by the background process responsible for creating the letter extract file.
- For all other types of letters, the address is extracted as follows:
 - If the letter's person has a [seasonal address](#) effective on the business date, the letter's address is the respective seasonal address.
 - If the letter's person has a [mailing address](#), it is used.
 - Otherwise, the system checks if the letter's person has at least one account where the person is the main customer and the account has at least one active service agreement. If so, the logic described above is executed for the first such account found.
 - If an address was not populated as a result of the above, the letter is not produced and a warning is issued by the background process responsible for creating the letter extract file.

Technical Implementation Of Online Letter Display

Users can view an image of any letter that is sent to a customer if you plug-in an Online Letter Display algorithm on the [Installation Record](#)

NOTE: Some display algorithms rely on the extract algorithm on each [letter template](#). Algorithms of this type format the records that contain the customer information that is passed to your printing software.

The system can make a call to an external system to retrieve a letter image. Many letter print vendors support this functionality.

The system provides an Installation – Online Letter Display algorithm type (C1GENLTTRURL) that can generate a dynamic URL.

- The algorithm of this algorithm type supports dynamic variables such as the customer contact ID and static variable such a vendor or implementation supplied security key.
- The algorithm constructs a URL including generating HASH or security keys.
- The system displays the retrieved image in a separate browser session.
- Refer to the algorithm type description for information about this algorithm type.

The system can interact with either document composition applications, or a reporting engine (such as BI Publisher).

The system provides an Installation – Online Letter Display algorithm type (C1-LT-DISP) that interacts with Documaker to render an online image of your letter. The following points describe what takes place when clicking **Display Letter**.

- The algorithm based on this algorithm type calls the letter extract algorithm on each [letter template](#).
- The letter extract algorithm will construct the information that appears on the letter
- The constructed information is passed to document composition software that will reconstruct the letter's image in a PDF format.
- The system displays the PDF in a separate browser session. Note that the client must have Adobe Acrobat Reader installed to view PDF files.

The system provides an algorithm that interacts with BI Publisher to render an online image of a letter. The following points describe what takes place when clicking Display Letter when these sample algorithms are used.

- The sample Online Letter Display algorithm C1-ONLTR-RPT is executed.
- This algorithm calls the letter extract algorithm. The sample letter extract algorithm C1-LTTEX-RPT is supplied for displaying letters via BI Publisher. This is not actually extracting data because when you use BI Publisher, the report itself is responsible for extracting and formatting the data. The base product algorithm supplied returns the appropriate report code to the Online Letter Display algorithm, which in turn returns the report code to the customer contact page.
- A user exit on the customer contact page invokes BI Publisher and displays the letter in a separate browser session.

FASTPATH: Refer to [Letter Print - BI Publisher Sample Welcome Letters - CI_LTRGN_ENG REPORT](#) for more information.

Reproducing The Letter Print Flat File

You can reproduce the flat file containing the information sent to your printing software at any time. Simply request the respective extract batch process and specify the run number associated with the historic run.

How To Reprint A Specific Letter

If you need to reprint a specific letter, navigate to [Customer Contact - Main](#) and turn on the **Reprint** switch (and save the customer contact). Alternatively, if your implementation has [enabled the online creation of letter images](#), you can also click the **Display Letter** button on this page and then print the resultant PDF on your local printer.

Letter Data Area Organization

The following refers to logic supported by letter extract process C1-LTPEX – Letter Extract. Refer to [The Letter Extract Processes](#) for more information.

The letter extract records are defined using data areas. There is an organizing data area that includes a detail data area and optionally a characteristic data area. The detail data area contains the individual elements. Using the account record as an example, the organizing data area is “Account Letter Extract Record” and includes two other data areas, “Account Details Letter Extract” and “Account Characteristics Letter Extract”. This was done to:

- Ensure that characteristic records are extracted directly after their associated record.
- Properly sequence parent records followed by their characteristic then followed by a child record and its characteristic.
- Allow custom extensions to the detail record. See [Extending Letter Record Types](#) for more information.

The characteristic data area is only included on objects with a characteristic collection. For consistency, objects without a characteristic record still follow same pattern with an organizing and detail data area. There are two special records, the end of letter record and the summary record that do not follow this pattern.

Letter Extract File Structure

The following refers to logic supported by letter extract process C1-LTPEX – Letter Extract. Refer to [The Letter Extract Processes](#) for more information.

The letter extract file structure is impacted by the extract format. The extract batch, contains a File Format parameter that supports XML, CSV, and fixed position extract formats.

When the format is set to XML, the organizing data area as described in [Letter Data Area Organization](#), is treated as a single schema. The included data areas are nested within the organizing data area. For example, an account record configured with two characteristics to extract will be nested in a single schema with a detail group and two occurrences of the characteristic list group.

When the format is set to CSV or fixed position, the included data areas are treated as an individual schema so that each record is extracted on a separate row. For example, an account record configured with two characteristics to extract will produce three rows in the extract file.

Extending Letter Record Types

The following refers to logic supported by letter extract process C1-LTPEX – Letter Extract. Refer to [The Letter Extract Processes](#) for more information.

Each record type has a business object that defines the format and the logic to extract records of that type. The BO Extract Record plug-in spot contains the logic to populate the record's data area. This plug-in spot supports multiple algorithms. Each business object is delivered with one algorithm configured for this plug-in spot that contains the logic to populate the record type's elements.

As described in [Letter Data Area Organization](#), there is a detail data area that contains the individual elements for a record type. If your implementation wants to extend a delivered record type, define a custom data area that extends the detail data area. The organizing data area should not be extended. To populate the custom data area, create an additional algorithm for the Extract Record plug-in spot. The record's schema is passed into the plug-in spot so subsequent algorithms have access to values defined by previous algorithms.

Maintaining Declarations

The declaration page allows you to define a declaration percentage for a combination of account, premise, service type, declaration type and date range. The declaration may be used by algorithms to adjust certain calculations in the system. For example you may give certain customers a reduced VAT rate. The declaration is used to indicate the reduced rate for the qualifying customer.

Open **Menu** > **Customer Information** > **Declaration** > **Add** to create a new declaration.

NOTE:

Applicable for UK market. This page is intended for the United Kingdom market. Other markets may disregard this transaction.

Description of Page

The **Declaration Info** is a concatenation of important information about the declaration record. The **DeclarationID** is a system-assigned random number that uniquely identifies this record.

Use **Account ID** to indicate the account for this declaration.

Use **Premise ID** to indicate the premise for this declaration.

The **Service Type** controls the service agreements covered by this declaration. All service agreements for this account and premise whose service point is for this service type are covered.

Use the **Declaration Type** to indicate the type of declaration. The system includes the declaration types CCL Relief and Reduced Rate VAT.

NOTE:

The values for this field are able to be customized using the Lookup table. This field name is DCL_TYPE_FLG.

Enter the **Start Date** and **End Date** to indicate the effective period of this declaration. The start date defaults to the current date.

Enter the **Declaration Percentage**.

If this declaration is related to an external document, indicate the **Document Reference**.

This bottom of this page contains a [tree](#) that shows information about all the declarations linked to this account. You can use this tree to both view high-level information about these objects and to transfer to the respective page in which an object is maintained.

Service Tasks

The topics in this section describes service tasks.

The Big Picture of Service Tasks

Service tasks are records that can be used to perform a variety of tasks. Examples include:

- Task-related records performed by users of other Oracle Utilities applications, such as Oracle Utilities Customer Self Service.
- Task-related records performed by Oracle Utilities Customer Care and Billing to manage specific processing, such as net energy metering true-ups, or prepaid billing to create bill segments for smart meter prepaid service agreements.

For additional information about Service Tasks, see [Defining Service Tasks Options](#)

Searching and Viewing Service Tasks

Use this procedure to search for and view service tasks using the Service Task Query portal.

1. Select **Menu** , then **Service Task**.
2. Enter your search criteria.
Base package search options include customer name, external ID and service task ID.
Self-service task search criteria include service task type.
3. Click **Refresh**.
4. In the search results list, click the link for the service task you want to view or edit. The selected service task opens in the Service Task portal.

Registration Points

Understanding Registration Points

Deregulated markets operate by passing transactions between market participants to manage market processes. Markets use a unique market identifier for market participants to identify the customer or premise that the transaction applies to.

Some markets will identify a customer at a premise and the unique identifier will change with each new customer at the same premise. Other markets will identify the premise as the unique identifier and all customers at that premise will use the same identifier.

A registration point can manage a unique identifier at the premise level, service point level or the service agreement level. Therefore, providing the ability to operate in all markets.

Registration points can be associated directly with market transactions and/or market processes. Transactions can be implemented to trigger from changes to a registration point, or any object associated with the registration point. Transactions from Market Participants are received and validated against the registration point and can update the registration point directory or associated objects.

A registration point search portal provides a central location for all transactions associated with a customer and/or premise to be viewed in a single location.

For implementations operating in deregulated markets, refer to your implementation documentation for further details relating to registration point(s) constructed for your market(s).

Refer to [Understanding Market](#) for more details on markets.

Maintaining Registration Points

This portal is used to display and maintain a Registration Point.

Refer to [Understanding Registration Points](#) for more details.

To view and maintain registration points, open **Menu > Customer Information > Registration Point > Search**. You are brought to a query portal with options for searching for registration points.

Once a registration point record has been selected, you are brought to the maintenance portal to view and maintain the selected record.

The following zones are displayed:

- **Registration Point**
- **Registration Point Attributes**
- **Registration Point Characteristics**
- **Market Messages and Market Processes**
- **Registration Point Relationships**

Refer to the zones' embedded help for more information.

Consumer Contracts

Maintaining Consumer Contracts

This portal is used to display and maintain a Consumer Contract.

Refer to [Understanding Consumer Contracts](#) for more details.

To view and maintain consumer contracts, open **Menu > Customer Information > Consumer Contract > Search**. You are brought to a query portal with options for searching for consumer contracts.

Once a consumer contract record has been selected, you are brought to the maintenance portal to view and maintain the selected record.

The following zones are displayed:

- **Consumer Contract** shows the details of the consumer contract.
- **Consumer Contract Milestone** shows the significant dates on which specific actions will take place for the consumer contract.
- **Consumer Contract Product** shows the related contract product versions
- **Consumer Contract Change Request** shows the related consumer contract change request(s) that created and/or updated the consumer contract.

Refer the zones' embedded help for more information.

Customer Service Requests

Understanding Customer Service Requests

Customer service requests can be used to orchestrate complex customer related processes that can create or update multiple objects.

- Customer service request person
- Customer service request account
- Customer service request premise
- Customer service request service agreement
- Customer service request consumer contracts
- Customer service request contract product
- Customer service request service location

An implementation can add custom components to use the customer service request objects to add or update persons, accounts, premises and contracts.

To see the available customer service request types in your implementation, refer to the Customer Service Request business objects in the application.

About Starting, Stopping and Transferring Service Using Customer Service Requests

The system is delivered with step-by-step processes to facilitate start, stopping and transferring service. A few different objects are used to comprise these processes. These objects are designed to work with each other – like a matched set.

A **Process Flow Type** controls the user experience by combining a series of panels that create the steps of the flow. The process flow guides the user to gather information based on configured business rule. It also orchestrates performing business logic contained in plug-in spots to progress the process flow. For example, it uses a chosen premise to then

show the user the available services to start at that premise. Along the way, the process flow creates and interacts with an underlying transaction.

A **Customer Service Request** is a lifecycle-based transaction that is created by the process flow. The customer service request is comprised of a parent request and child objects to record, update, and provide processing for persons, accounts, service agreements, and premises. The customer service request lifecycle continues after the process flow is complete and until all associated services are activated, stopped, or canceled.

A **Customer Service Request Type** contains the business rules that the process flow and customer service request jointly interpret, apply, and enforce. The customer service request type's business rules settings are called controls. They along with the plug-in spots, define the type's behavior. Some configuration is used by the process flow and some by the customer service request. For example, the customer service request type has controls that impact the fields used to search for a person and a plug-in spot used to create pending start service agreements.

The Start Service Process and Request

When starting service, the system creates a start service process flow and assigns it a customer service request type. The process flow type (start service process) and customer service request type (start service request type or request type) are determined from the action method with Action Method Role of **Start Service**. See [Action Method](#) for more information about setting up action methods. The customer service (start service) request parent and child business objects are defined on the request type.

The system is delivered with the following objects that are used to start service

- Process Flow Type **C1-STARTSERVICEREQUEST**.
- Customer Service Request Type business object **C1-StartServiceRequestType**
- Customer Service Request business object **C1-StartServiceRequest**
- Customer Service Request Person business object **C1-CustSvcRequestPerson**
- Customer Service Request Account business object **C1-CustSvcRequestAccount**
- Customer Service Request Premise business object **C1-CustSvcRequestPremise**
- Customer Service Request Start SA business object **C1-StartServiceRequestSA**

The start service process can be initiated via BPA script (refer to script C1StaActMtdR).

Start Service Process

The start service process contains five steps or panels. The logic that is enabled is defined in the request type. The following overview of the four panels assumes the request type has enabled the described functionality. This is meant to illustrate the full features provided with the start service process. The request type can be configured to accommodate your business rules.

Move-to Premise Address. This panel is used to search for the starting premise. This is the first step to ensure that the new or existing customer's Move-to Premise Address exists and is in your service territory.

Customer Identification. This panel is used to create a new person and/or account or ensure a person's existing account is eligible for service. If the start service process began without an existing person in context, a person search is provided to ensure the person is in fact not in your system to help prevent creating duplicate person records. If no person is found, the information used to search for the person such as their name, phone number, or ID is used to create a new person. If an existing person is found, the start process then continues as if the person was provided when the process began.

Regardless if an existing person is being used or a new person is being added, the start process determines if a credit or ID check needs to be performed and if it does, performs it. It then checks to see if the person has accounts that are eligible for service. For example, accounts used for bankruptcy or accounts that have been dormant for too long might not be eligible for service. A control determines if a new account can be created even if an existing account is eligible for service. This is useful to prevent duplicate accounts for the same person, unless your business rules allow it. The start process then uses the

previous information to determine if a deposit is required. For more information, please see [Verifying Identity, Checking Credit and Requiring Deposits when Starting Service](#).

Before transitioning to the next panel, this panel interacts with the start service request to create person and account records. When a new person or account is added, their record will exist in the system after this point, even if this process is not completed.

Services to Start. On this panel the services to start are selected. After inputting a start date, the panel displays services to start in three different groupings.

If a deposit is required, the first section is shown. The start process defaults the deposit service agreement request type, calls the deposit calculation plug-in spot on deposit class, and defaults installments information amounts if configured on the request type. The start process enforces rules pertaining to installment amounts. While not common, additional deposit SAs can be added.

The next section shows the eligible services to start at the premise. This is based on the premise's SPs. This section is built by calling the algorithm in configured in the **Determine Services to Start** plug-in spot defined on the request type. It returns the default SA Type(s) for each service point based on the existing or prior service or the initial services defined on the SP Type if this is the first service at this SP. The start SA box is usually checked by default and can be unchecked to start only some of the eligible services at the premise. In rare cases, the start SA box is unchecked by default if some services are on and some services are off at the premise. This is done to replicate the current service at the premise by default. Entries cannot be removed or added to this collection of eligible services to start. Field service notes can be entered for the premise or service point.

The third service section is where additional services such as charity can be started. Additional services can default from the request type or be added. The search is designed to exclude deposit and SP-based services shown in the prior sections.

At the end of the panel, premise attributes such as indicating if life support equipment is at the premise or if there are specific field warnings relevant to the premise.

Person and Account Details. This panel is where all other person and account information is gathered. This includes all person contact information, other names, other person identifies, alternate mailing address, paperless billing enrollment, autopay enrollment and updates, adding other persons on the account, and more.

Review and Submit. This panel provides an opportunity to review the information before submission.

When the start process is finished, a **Summary** is shown. The start service information is copied to the start service parent and child requests. The start service process is completed, and the start service request takes over.

Start Service Request

The start service request lifecycle is comprised of this logic:

- The start service request first checks to see if there are pre-requisites to starting service. See [Introducing Your Business Rule Before Starting or Transferring Service](#).
- Once any prerequisites have been completed, the request applies any person and account updates gathered during the start service flow. It then creates the pending start SAs by calling the algorithm plugged into the **Process Services to Start** plug-in spot on the request type.
- The request then monitors the pending SAs for activation.
- Once all services are active, premise updates are applied.
- The start request is then complete.

NOTE: For more details, see the start service request business object detailed description.

The Stop Service Process and Request

When stopping service, the system creates a stop service process flow and assigns it a customer service request type. The process flow type (stop service process) and customer service request type (stop service request type or request type) are

determined from the action method with Action Method Role of **Stop Service**. See [Action Method](#) for more information about setting up action methods. The customer service (stop service) request parent and child business objects are defined on the request type..

The system is delivered with the following objects that are used to stop service

- Process Flow Type **C1-STOPSERVICEREQUEST**.
- Customer Service Request Type business object **C1-StopServiceRequestType**
- Customer Service Request business object **C1-StopServiceRequest**
- Customer Service Request Person business object **C1-CustSvcRequestPerson**
- Customer Service Request Account business object **C1-CustSvcRequestAccount**
- Customer Service Request Premise business object **C1-CustSvcRequestPremise**
- Customer Service Request Start SA business object **C1-StopServiceRequestSA**

The stop service process can be initiated via BPA script (refer to script C1StpActMtdR).

Stop Service Process

The stop service process contains three steps or panels. The logic that is enabled is defined in the request type. The following overview of the two panels assumes the request type has enabled the described functionality. This is meant to illustrate the full features provided with the stop service process. The request type can be configured to accommodate your business rules.

Services to Stop. This panel is used to choose the services to stop for the account. After entering a stop date, the algorithm in configured in the **Determine Services to Stop** plug-in spot defined on the request type is called. It returns the stoppable services for the account. The services at the premise in context are selected to stop by default. Other premises and non-premise-based service can also be selected to stopped but are not selected by default. Non-premise-based services with a characteristic premise matching the premise in context are defaulted to stop.

Field service notes can be entered for the premise or service point where service is being stopped.

Additionally, as customers stop service at a premise, some premise attributes such as indicating if life support equipment is at the premise or if there are specific field warnings relevant to the premise may need to be updated. Premise updates can be made for any premise where service is being stopped.

Person and Account Details. This panel has the same features as the same panel in the Start Service Process. The options presented are controlled by the stop request type

Review and Submit. This panel provides an opportunity to review the information before submission.

When the stop service process is finished, a **Summary** is shown. The stop service information is copied to the stop service parent and child requests. The stop service process is completed, and the stop service request takes over.

Stop Service Request

The stop service request lifecycle is comprised of this logic:

- The stop service request applies any person and account updates gathered during the stop service flow. Services that are chosen to stop are transitioned to pending stop by the algorithm plugged into the **Process Services to Stop** plug-in spot on the request type.
- The request then monitors the pending stop SAs to check when they have stopped.
- Once all services are stopped, the request applies any premise updates.
- The stop request is then complete.

NOTE: For more details, see the stop service request business object detailed description.

The Transfer Service Process and Request

When transferring service (starting and stopping service for the same customer), the system creates a transfer service process flow and assigns it a customer service request type. The process flow type (transfer service process) and customer service request type (transfer service request type or request type) are determined from the action method with Action Method Role of **Transfer Service**. See [Action Method](#) for more information about setting up action methods. The customer service (transfer service) request parent and child business objects are defined on the request type.

The system is delivered with the following objects that are used to transfer service:

- Process Flow Type **C1-TRANSFERSERVICEREQUEST**.
- Customer Service Request Type business object **C1-TransferServiceRequestType**
- Customer Service Request business object **C1-TransferServiceRequest**
- Customer Service Request Person business object **C1-CustSvcRequestPerson**
- Customer Service Request Account business object **C1-CustSvcRequestAccount**
- Customer Service Request Premise business object **C1-CustSvcRequestPremise**
- Customer Service Request Start SA business object **C1-StartServiceRequestSA**
- Customer Service Request Stop SA business object **C1-StopServiceRequestSA**

The transfer service process can be initiated via BPA script (refer to script C1TrnActMtdR).

Transfer Service Process

The transfer service process contains five steps or panels. The logic that is enabled is defined in the request type. The transfer process combines panels from the start and stop processes into one process.

Move-to Premise Address. This panel is the same as the same panel used in the Start Service Process.

Services to Start. This panel is the same as the same panel used in the Start Service Process. The options presented are controlled by the transfer request type.

Services to Stop. This panel is the same as the same panel used in the Stop Service Process. The options presented are controlled by the transfer request type.

Person and Account Details. This panel is similar to the same panel in the Start and Stop Service Processes. The only notable difference is that this panel allows for the creation of a customer contact for the starting and stopping service. The options presented are controlled by the transfer request type.

Review and Submit. This panel provides an opportunity to review the information before submission.

When the transfer service process is finished, a **Summary** is shown. The transfer service information is copied to the transfer service parent and child requests. The transfer service process is completed, and the transfer service request takes over.

Transfer Service Request

The transfer service request lifecycle is comprised of this logic:

- The transfer service request first checks to see if there are pre-requisites to starting service. See [Introducing Your Business Rule Before Starting or Transferring Service](#).
- Once any prerequisites have been completed, the request applies any person and account updates gathered during the transfer service flow. It then creates the pending start SAs by calling the algorithm plugged into the **Process Services to Start** plug-in spot on the request type. Next it creates the pending stop SAs by calling the algorithm plugged into the **Process Services to Stop** plug-in spot on the request type.
- The request then monitors the pending start SAs for activation and the pending stop SAs for stopping.

- The move-to premise is updated as soon as one of its SAs are Active. Each move-from premise is updated as soon as one of its SAs are Stopped.
- The transfer request is completed when all of the following are true:
 - All premises are updated
 - All SAs to start are Active
 - All SAs to stop are Stopped.

NOTE: For more details, see the transfer service request business object detailed description.

Additional Information About the Start, Stop, and Transfer Processes

The following explains some of the more intricate details performed during the start, stop, and transfer processes.

Override Mailing Address

By default, the main person on an account's mailing address source is the mailing premise on the account. Other person's on the account do not default the address source and one must be chosen. Aside from the mailing premise on the account, the system stores a mailing address information on the person and directly on the account person record, which is called Account Override. The account/person record indicates the address source for that account/person.

Your business rules may define where alternate mailing addresses are stored or when each is used. The request type defines which alternate location is used or if both are used. When adding an alternate mailing address, the address is stored in the preferred location or if both are enabled, Person or Account Override must be selected.

Existing data might not reflect your current business rules. For example, the request type is set to Account Override, but the address source is already set to Person. In this case, the process behaves as if both sources are enabled and a message is shown to indicate that the current address is stored in the source not supported by the request type. The process does not require the source to be changed.

Default Bill Route Type

When a new person and account are added or when a new person is linked to an account as an other person, the bill route type is defaulted from the installation record.

Paperless Billing

The processes allow customers to enroll in paperless billing if not already enrolled. If the current bill route type's routing method is email or fax, the customer is considered already enrolled. When enrolling, the bill route type defined on the request type is used.

Autopay Enrollment

The processes allow customers to enroll, check, or stop automatic payments. If enrolled, the details of the current record are shown. Changing the enrollment expires the currently effective and creates a new record effective the following day. To stop automatic payments, uncheck the box next to the enrollment details and the current record is expired.

Displaying Insights on Start and Transfer Service Processes

The Start and Transfer Service Processes can display insights about the premise, account and the services at the premise.

The insights are shown when a premise is selected from the search results for the Move-to Premise Address and on the header of subsequent panels – i.e. Customer Identification, Services To Start and Account Details.

The base product provides Insight Classes for each category of insights (premise-based, account-based and service-based), as well as Insight Types that can be linked to the Insight Groups for these Insight Classes.

The following are the steps to enable insights on Start and Transfer Service processes:

- Add an Insight Group for the **Start/Stop/Transfer Insights - Account-Based** Insight Class. Link the Highlight Account Info - Inline (C1-ACCTINFO-INLINE) Insight Type to the Insight Group.
- Add an Insight Group for the **Start/Stop/Transfer Insights - Premise-Based** Insight Class. Link one or more of the following insight types:
 - Highlight Unique Accounts Had Service At Premise - Inline (C1-UNACCTSP-INLINE)
 - Highlight Life Support/Sensitive Load on Premise - Inline (C1-PREMLSSL-INLINE)
 - Highlight Open Cases - Inline (C1-CASEOPEN-INLINE)
 - Highlight Open Business Flags - Inline (C1-OPBUSFLG-INLINE)
 - Highlight Field Activity Type - Inline (C1-FLDACTTY-INLINE)
 - Highlight Pending Field Activity - Inline (C1-PENDFA-INLINE)
 - Highlight Premise Link To Parent Premise - Inline (C1-PRMPNT-INLINE)
 - Highlight Child Premises - Inline (C1-PRMCHILD-INLINE)
 - Highlight Premise Linked to Multiple Accounts - Inline (C1-PRMACCTS-INLINE)
 - Highlight Landlord - Inline (C1-LANDLORD-INLINE)
- Add an Insight Group for the **Start/Stop/Transfer Insights - Service-Based** Insight Class. Link the Highlight Premise Service Info - Inline (C1-PREMSVC-INLINE)

Maintaining Customer Service Requests

This portal is used to display and maintain a Customer Service Request.

Refer to [Understanding Customer Service Requests](#) for more details.

To view and maintain customer service requests, open **Menu > Customer Information > Customer Service Request > Search**. You are brought to a query portal with options for searching for customer service requests.

Once a customer service request record has been selected, you are brought to the maintenance portal to view and maintain the selected record.

The following zones are displayed:

- **Customer Service Request** zone shows the details of the customer service request.
- **Customer Service Request Person** shows the related person(s). Select a record to go to the specific portal where the details can be viewed and maintained.
- **Customer Service Request Account** shows the related account(s). Select a record to go to the specific portal where the details can be viewed and maintained.
- **Customer Service Request Premise** shows the related premise(s). Select a record to go to the specific portal where the details can be viewed and maintained.
- **Customer Service Request SA** shows the related service agreement(s). Select a record to go to the specific portal where the details can be viewed and maintained.
- **Customer Service Request Contract** shows the related contract(s). Select a record to go to the specific portal where the details can be viewed and maintained.
- **Customer Service Request Contract Product** shows the related contract product(s). Select a record to go to the specific portal where the details can be viewed and maintained.

- **Customer Service Request Service Location** shows the related service location(s). Select a record to go to the specific portal where the details can be viewed and maintained.
- **Customer Service Request Related Object** shows other related entities.

Refer to the zones' embedded help for more information.

Maintaining Customer Service Request Person

This portal is used to display and maintain a Customer Service Request Person.

This portal is displayed when a record is selected from the **Customer Service Request Person** zone on the Customer Service Request portal. Refer to [Maintaining Customer Service Requests](#) for more details.

The **Customer Service Request Person** zone shows the details of the related person. Refer to the zone's embedded help for more information.

Maintaining Customer Service Request Account

This portal is used to display and maintain a Customer Service Request Account.

This portal is displayed when a record is selected from the **Customer Service Request Account** zone on the Customer Service Request portal. Refer to [Maintaining Customer Service Requests](#) for more details.

The **Customer Service Request Account** zone shows the details of the related account. Refer to the zone's embedded help for more information.

Maintaining Customer Service Request Premise

This portal is used to display and maintain a Customer Service Request Premise.

This portal is displayed when a record is selected from the **Customer Service Request Premise** zone on the Customer Service Request portal. Refer to [Maintaining Customer Service Requests](#) for more details.

The **Customer Service Request Premise** zone shows the details of the related premise. Refer to the zone's embedded help for more information.

Maintaining Customer Service Request SA

This portal is used to display and maintain a Customer Service Request SA.

This portal is displayed when a record is selected from the **Customer Service Request SA** zone on the Customer Service Request portal. Refer to [Maintaining Customer Service Requests](#) for more details.

The **Customer Service Request SA** zone shows the details of the related SA. Refer to the zone's embedded help for more information.

Maintaining Customer Service Request Contract

This portal is used to display and maintain a Customer Service Request Contract.

This portal is displayed when a record is selected from the **Customer Service Request Contract** zone on the Customer Service Request portal. Refer to [Maintaining Customer Service Requests](#) for more details.

The **Customer Service Request Contract** zone shows the details of the related contract. Refer to the zone's embedded help for more information.

Maintaining Customer Service Request Contract Product

This portal is used to display and maintain a Customer Service Request Contract Product.

This portal is displayed when a record is selected from the **Customer Service Request ContractProduct** zone on the Customer Service Request portal. Refer to [Maintaining Customer Service Requests](#) for more details.

The **Customer Service Request Contract Product** zone shows the details of the related contract product. Refer to the zone's embedded help for more information.

Maintaining Customer Service Request Service Location

This portal is used to display and maintain a Customer Service Request Service Location.

This portal is displayed when a record is selected from the **Customer Service Request Service Location** zone on the Customer Service Request portal. Refer to [Maintaining Customer Service Requests](#) for more details.

The **Customer Service Request Service Location** zone shows the details of the related service location. Refer to the zone's embedded help for more information.

Asset Management

NOTE: The asset management functionality described in this section is available only to cloud implementations using Oracle Utilities Customer Cloud Service or Oracle Utilities Meter Solution Cloud Service.

Assets

About Assets

In Oracle Utilities Customer To Meter, an asset is any operational device used in a metering system, such as a smart meter, analog meter, communication component, or communication relay.

The status and location of assets are carefully monitored and recorded as they move in and out of service or go for maintenance or repair. This type of asset will be tracked at a location with a disposition such as in receipt, in stores, in repair, retired or rejected. If the tracked asset is installed, or put in service, it will be related to an asset location. Tracked assets utilize more statuses and a status reason to more carefully track the asset as it moves from receipt to retirement.

Assets are defined by the following:

- **Asset Type:** The [asset type](#) on which the asset is based.
- **Status:** The current status of the asset (In Receipt, In Stores, Installed, In Repair, Retired, Rejected, or Pending Disposition)
- **Device:** The device associated with the asset. When assets are created (either manually or through [asset replication](#)), a corresponding device is created (see [Assets and Devices](#) below for more information).
- **Specification:** The asset's [specification](#). This is used to determine the template device used when creating [devices](#) based on the asset or its asset type.
- **Identification:** Identifiers (such as Badge Number or Serial Number) and other information used to identify the asset

- **Settings:** Firmware and configuration settings used with smart meter assets
- **Asset Disposition Detail:** Details regarding the disposition and location of the asset.

NOTE: The **Asset** portal may display information beyond that described here that is not used with Oracle Utilities Customer To Meter.

Components

Components are devices or other objects that are attached to another device, usually an asset.

One of the most common examples of components are the electronic reading devices (ERTs) that are often attached to analog meters. However, a component can be any asset attached to another asset.

Example of components in Oracle Utilities Customer To Meter include:

- **Communication Relays:** Communication relays transmit messages between various points to facilitate communication between units. These typically use the same fields and statuses as meters.
- **Communication Components:** Communication components are devices that can be attached to an analog meter to connect the meter to the “smart” communication grid. These use the same fields and statuses as smart meters with the exception that they are never installed directly at a location, but are instead attached to another asset.

Since they are always attached to another device, components cannot be installed at a location. However, they may be received, tracked, maintained and inspected like any other device. Given this, activities and work orders can be created to perform these tasks on components.

Detaching components involves either moving the component to a new asset or transferring to a storeroom. The process within the system is to search for and select the component and then "detach" it from the asset where it currently resides.

Asset Hierarchy

Assets typically exist within a structured relationship based on the relationship between the asset and its locations and organizations, or “nodes”. The hierarchy is represented in a nested format on the **Tree View** tab on the **Asset** portal. This view displays which assets are in a location, which assets are attached to other assets, and where assets belong within organizations. Clicking the broadcast icon next to any element within the tree displays a list of assets and components related to that element in the hierarchy. Clicking the actual link for an element navigates to the associated record for the element.

Assets and Devices

When assets are created (or replicated) in Oracle Utilities Meter To Customer, a related **device** is created. The way in which the device is created is based on the configuration of the asset, its asset type, and its specification.

- For assets with specifications that include **Configuration Mapping** details, the type of device created is based on the template device identified in the **Configuration Mapping** section of the **specification** referenced on the asset or associated with the asset type.
- For assets that have no template device configured, the type of device created is based on the asset type of the asset and the **Value Mappings** defined for the “Asset Type/Device Type” value of the ODM-MDM Mapping Field Values extendable lookup.

Device identifiers for devices created via an asset can not be changed in the **Device** portal. These identifiers must be changed in the **Asset** portal.

NOTE: If an asset is deleted, its related device is also deleted.

Asset Status and Disposition

An asset’s Status defines its current state in the system (In Receipt, In Stores, Installed, In Repair, Retired, Rejected, or Pending Disposition).

An asset's Disposition indicates where the asset is and what is being done to the asset. This includes its status and location, as well as the date/time at which the asset was moved to its current location. In the case of components, disposition is also used to track the assets to which a component is attached.

The [Mass Asset Disposition Update](#) portal can be used for moving many assets of the same type from one location to another location.

The disposition of assets with related devices is updated to "Installed" when their related device is installed at a service point. The update to the device's install event triggers the update to the asset disposition, changing its **Status** and **Asset Disposition** to "Installed" and its **Location** to the service point with an effective date matching the install event's **Installation Date/Time**.

Pre-Assembled Meters

Assets received with communication modules already attached are known as "pre-assembled meters". When a pre-assembled meter asset is installed at a service point, the attachment date and time of the equipment, which is effectively the device installation date and time, will not be reflected on the asset component. This means that the asset component retains the original attachment date time upon its receipt and storage. Subsequent online user actions such as updating the attachment date and time deleting equipment deletion from the device (undo attachment), are also not reflected on the asset component.

However, removing the meter from the service point is considered the same as detaching equipment and is are reflected on the asset component, regardless of whether the equipment is physically detached from the meter in the field or not. Recording the equipment detachment in this manner is done to support potential equipment reuse on a replacement meter.

Maintaining Assets

You use the **Asset** portal is used to display and maintain assets.

Refer to [About Assets](#) for additional functional information.

You can access the portal from **Menu > Asset Management > Asset**. You are brought to a query portal with options for searching. Once your record has been selected you are brought to the maintenance portal to view and maintain the selected record.

The following zones may appear as part of the portal's **Main** tab page:

- **Asset:** This zone displays the basic attributes of the asset.
- **Attached Components:** This zone displays a list of any components that are installed on the asset.
- **Disposition History:** This zone displays a log of the status and location changes for the life of the asset.

The following zones may appear as part of the portal's **Device** tab page:

- **Device:** This zone defines the basic attributes of the device
- **Device Configuration List:** This zone lists the device configurations for the device
- **Device Activities:** This zone lists activities related to the device in date descending order
- **Device Events:** This zone lists the most recent device events associated to the device in descending order
- **Device Exceptions:** This zone lists the first 50 VEE exceptions for all measuring components for the device, sorted by the exception creation date in descending order

The following zones may appear as part of the portal's **Maintenance** tab page:

- **Asset Service History:** This zone displays a log of the service history that has been recorded for the life of the asset.
- **Activity History:** This zones displays a log of the activities that have been performed on the asset over the life of the asset.

The following zones may appear as part of the portal's **Tree View** tab page:

- **Asset Hierarchy:** This zone displays the service point at which the asset is currently installed (if applicable). Clicking the broadcast icon opens the **Installed Assets** zone, which displays a tree view of all of the assets installed at the service point.
- **Currently Installed Assets:** This zone displays a list of all assets currently installed in this location.
- **Installed Assets:** This zone displays a tree view of all of the assets installed at the service point.

The following zones may appear as part of the portal's **Log** tab page:

- **Asset Log:** This zone displays the server logs for the asset.
- **Asset Sync Requests:** This zone displays a list of synchronization requests related to the asset. Synchronization requests are used to synchronize the asset with an associated device.

NOTE: The **Asset** portal may display tabs and zones beyond those described here. These tabs and zones are not used with Oracle Utilities Customer To Meter.

Working with Assets

A number of actions are available for an asset depending on its status:

Action	Allowed Statuses	Details
Store	In Receipt	Moves the asset to a storage ("out of service") location and sets the asset's status to "In Store"..
	Installed	
	In Repair	
	Retired	
Reject	In Receipt	Sets the status of the asset to "Rejected" (used if an asset fails an inspection)
	In Store	
Install	In Store	Installs the asset at an asset location (service point) and sets the asset's status to "Installed".
Repair	In Store	Sets the status of the asset to "In Repair".
	Retired	
Retire	In Store	Sets the status of the asset to "Retired".
	In Repair	
Pending Disposition	In Store	Sets the status of the asset to "Pending Disposition".
	Installed	
	In Repair	
	Retired	
Change Location	In Store	Changes the storage location of the asset.

NOTE: If an asset is deleted, its related device is also deleted.

Asset Activities

About Asset Activities

Asset activities are used for creating field work tasks related to an asset or asset location, such as installation or removal of a meter to and from its service point. It may also be used for creating field work tasks for a specific location unrelated to an asset such as trimming trees near power lines, fixing a street light pole, repairing fire hydrant leaks, and so on.

The base package includes an asset activity type business object (W1-SOMActivityType) and a corresponding asset activity business object (W1-SOMActivity), used in the integration or consolidation of Operational Device Management activities with and [Service Order Management](#) activities related to field work.

When an asset activity (based on the asset activity type and asset activity business objects referenced above) is created and enters the “Communication in Progress” state, the activity is synchronized with Service Order Management, creating a [service order field activity](#) with a [field task type](#) that corresponds to the asset activity’s type.

Once the field activity has been created, Service Order Management is responsible for dispatching the request to the field work system. When the task is completed, Service Order Management receives the completion information from the field work system, completes the service order field activity and sends the completion information to Operational Device Management to complete the corresponding asset activity.

Asset activities (based on the (W1-SOMActivity business object) are defined by:

- **Status:** The current status of the asset activity
- **Emergency:** A flag that indicates if the asset activity is an emergency or not
- **Originating Activity:** The activity that triggered the creation of the asset activity (if applicable)
- **Location:** The location where the asset activity is to be performed
- **Asset:** The asset associated with the asset activity
- **Activity Generator:** The [asset activity generator](#) that created the asset activity (if applicable)
- **Service Date/Time:** The date and time at which the field work associated with the asset activity is to be performed
- **Address Information:** The address where the field work associated with the asset activity is to be performed
- **Contact Information:** Contact information (customer name and phone number) related to the asset activity

Maintaining Asset Activities

You use the **Field Activity Query** and **Field Activity** portals to display and maintain asset activities.

Refer to [About Asset Activities](#) for additional functional information.

You can access the portal by selecting **Menu**, then **Asset Management**, then **Asset Activity**. You are brought to the **Field Activity Query** portal with options for searching.

The following zones may appear as part of the portal’s **Main** tab page:

- **Activity:** This zone displays the basic attributes of the asset activity.
- **Completion Information Entry:** This zone displays a list of completion events that must be processing to finalize the asset activity
- **Attachments:** This zone displays a list of attachments (if any) related to the asset activity.

The following zones may appear as part of the portal’s **Log** tab page:

- **Activity Log:** This zone displays the server logs for the asset activity.

NOTE: The **Field Activity** portal may display tabs and zones beyond those described here. These tabs and zones are not used with Oracle Utilities Customer To Meter.

NOTE: For asset activities that have been synchronized with Service Order Management, you are brought to the **Activity** portal to view and maintain the selected record. See [About Service Order Field Activities](#) for more information.

Asset Activity Generators

About Asset Activity Generators

Asset activity generators are used for mass generation of activities. An Asset Generator Criteria business object is selected when creating asset activity generators, and is used for entering the criteria values for searching assets and asset locations that will be linked to the activities to be created. Such criteria includes location type, asset identifiers, location identifiers, address components, asset disposition, indication if asset is installed or not, asset type, specification and among others. Required information also includes, the activity type, disposition of the created activities, maximum number of activities that will be created, and an indication if the activities will be created via batch processing.

The base package the following set of activity generator business objects containing the various criteria:

- **Asset Criteria** (W1–AssetCriteriaActGenerator): used to define asset-related criteria used to select the assets for which activities will be created (for example, activities for all assets for a certain asset type, a specified current disposition or condition, or whose identifiers contain specific characters, and so on)
- **Asset List** (W1–AssetListActGenerator): used to define a list of assets for which activities will be created
- **Component Criteria** (W1–CompnCriteriaActGenerator): used to define component-related criteria to select the components for which activities will be created (for example, asset inspection activities for all assets for a certain component type, a specified current disposition or condition, or whose identifiers contain specific characters, and so on)
- **Component List** (W1–CompnAssetListActGenerator): used to define a list of assets for which activities will be created
- **Location Criteria** (W1–NodeCriteriaActGenerator): used to define location-related criteria to select the asset locations for which activities will be created (for example, activities for all locations where assets are current installed, locations of a specific type, or whose identifiers contain specific characters, and so on)
-

Asset activity generators are defined by:

- **Status:** The current status of the asset activity generator
- **Batch Generation Requested:** A flag that indicates if the activities created by the asset activity generator should be generated via batch processing
- **Generator Information:** Details related to the specific activity generator business object (Asset List, Asset, Location, etc.) used by the asset activity generator
- **Activity Information:** Details for the types of activities created by the asset activity generator, including activity type, default disposition, activation and work lead days (defaulted from the asset activity type), and the maximum number of activities to be created

Specific asset activity generators contain additional information based on their business object. For instance, asset activity generators based on the Location Criteria business object includes **Location Information** and **Address Information** sections.

Maintaining Asset Activity Generators

You use the **Activity Generator** portal is used to display and maintain asset activity generators.

Refer to [About Asset Activity Generators](#) for additional functional information.

You can access the portal by selecting **Menu**, then **Asset Management**, then **Asset Activity Generator**. You are brought to a query portal with options for searching. Once your record has been selected you are brought to the maintenance portal to view and maintain the selected record.

The following zones may appear as part of the portal's **Main** tab page:

- **Activity Generator:** This zone displays the basic attributes of the asset activity generator.
- **Activity Information:** This zone displays summary information about the activities created by the activity generator.

The following zones may appear as part of the portal's **Activities** tab page:

- **Activities:** This zones displays a list of the activities created by the activity generator.

The following zones may appear as part of the portal's **Log** tab page:

- **Activity Generator Log:** This zone displays the server logs for the asset activity generator.

NOTE: The **Activity Generator** portal may display tabs and zones beyond those described here. These tabs and zones are not used with Oracle Utilities Customer To Meter.

Asset Completion Events

About Asset Completion Events

Asset completion events are used to execute business events within the application. For example, completion events may be configured for several types of asset processing such as asset update, state transition, replication, service history and activity creation.

These are created automatically by the inbound communication through the completion event types configured on the activity type of the activity that the inbound communication is attempting to complete.

NOTE: Since these records are most often created by the system, most users will only rarely be manually creating or updating asset completion events.

Asset completion events are defined by:

- **Status:** The current status of the asset completion event
- **Execution Sequence:** The sequence number for the asset completion event
- **Inbound Communication:** The asset inbound communication that created the asset completion event
- **Relationship Information:** The asset, component, location, or service history associated with the asset inbound
- **Event Information:** Information about the asset completion event, including date and time of completion and any comments

Maintaining Asset Completion Events

You use the **Completion Event** portal is used to display and maintain asset completion events.

Refer to [About Asset Completion Events](#) for additional functional information.

You can access the portal by selecting **Menu**, then **Asset Management**, then **Asset Completion Event**. You are brought to a query portal with options for searching. Once your record has been selected you are brought to the maintenance portal to view and maintain the selected record.

The following zones may appear as part of the portal's **Main** tab page:

- **Completion Event:** This zone displays the basic attributes of the asset completion event.
- **Completion Event Related Objects:** This zone displays objects related to the asset completion event, such as a device, service point, or initial measurement.
- **Attachments:** This zone displays attachments, if any, related to the asset completion event.

The following zones may appear as part of the portal's **Log** tab page:

- **Completion Event Log:** This zone displays the server logs for the asset completion event.

NOTE: The **Completion Event** portal may display tabs and zones beyond those described here. These tabs and zones are not used with Oracle Utilities Customer To Meter.

Asset Inbound Communications

About Asset Inbound Communications

Asset inbound communications are used to stage the completion of an asset activity. This is typically created automatically by the system following the completion of the corresponding field activity in the field work system (such as Oracle Field Service Cloud).

NOTE: Since these records are most often created by the system, most users will only rarely be manually creating or updating asset inbound communications.

Asset inbound communications are defined by:

- **Status:** The current status of the asset inbound communication
- **Initiating Activity:** The asset activity, typically a field activity, that triggered the creation of the asset inbound communication
- **Event Information:** Information about the completion event associated with the asset inbound communication, including date and time of completion and any comments
- **Relationship Information:** The asset, component, location, or service history associated with the asset inbound communication
- **Asset Identifier Information:** Identifier types and values used to establish a connection between an asset and a corresponding entity in an external system
- **Attached to Asset Identifier Information:** Identifier types and values used to establish a connection between a component and related asset, and a corresponding entity in an external system

- **Location Identifier Information:** Identifier types and values used to establish a connection between a location and a corresponding entity in an external system
- **Activity Type Identifier Information:** Identifier types and values used to establish a connection between an asset activity type and a corresponding entity in an external system
-

Maintaining Asset Inbound Communications

You use the **Inbound Communication** portal is used to display and maintain asset inbound communications.

Refer to [About Asset Inbound Communications](#) for additional functional information.

You can access the portal by selecting **Menu**, then **Asset Management**, then **Asset Inbound Communication**. You are brought to a query portal with options for searching. Once your record has been selected you are brought to the maintenance portal to view and maintain the selected record.

The following zones may appear as part of the portal's **Main** tab page:

- **Inbound Communication:** This zone displays information for the asset inbound communication.
- **Communication Tree:** This zone displays a tree of objects related to the asset inbound communication, including its parent activity.

The following zones may appear as part of the portal's **Log** tab page:

- **Inbound Communication Log:** This zone displays the server logs for the asset completion event.

NOTE: The **Inbound Communication** portal may display tabs and zones beyond those described here. These tabs and zones are not used with Oracle Utilities Customer To Meter.

Asset Locations

About Asset Locations

Asset locations define the physical location where an asset is installed. In Oracle Utilities Customer To Meter, asset locations are [service points](#), and specify the address where a device is installed.

In Oracle Utilities Customer To Meter, asset locations are created when a service point is created, and are maintained using the [Service Point](#) portal. If the service point has a contact associated with it, a corresponding contact will be created for the asset location. See [About Contacts](#) and [Maintaining Contacts](#) for more information about creating and maintaining contacts used with asset locations.

Note that an asset location is the physical location where assets or components can be installed, whereas [Out of Service Locations](#) are for receipt, storage, repair, retirement, transport (on vehicles) and other dispositions.

Maintaining Asset Locations

You use the **Asset Location** portal is used to search for asset locations.

Refer to [About Asset Locations](#) for additional information about asset locations.

You can access the **Asset Location** portal from **Menu > Asset Management > Asset Location**. You are brought to a query portal with options for searching. Once your record has been selected you are brought to the [Service Point](#) portal to view and maintain the selected record.

NOTE: In Oracle Utilities Customer To Meter, asset locations are created and/or updated when a service point is created and/or updated. If the service point has a contact associated with it, a corresponding contact will be created for the asset location. See [About Contacts](#) and [Maintaining Contacts](#) for more information about creating and maintaining contacts used with asset locations.

Asset Replication

About Asset Replication

As devices and other assets are received in large quantities, the **Asset Replication** portal allows for the receipt, inspection, storage and other processing of these assets in batches.

Using asset replication functionality your organization can complete processes such as:

- Replicating assets in the same lot/pallet
- Selecting assets for testing or inspection
- Mass updating asset disposition such as rejecting or accepting a lot or pallet

This processing creates new asset IDs, badge numbers and serial numbers for assets based on general information that is entered related to each batch. When a new replication event is created it is tied to a replication activity type to determine default settings and attributes for the replication. The actual asset information can be entered manually or uploaded via a CSV file.

Assets can then be moved between locations, or dispositioned using [Mass Asset Disposition Update](#).

Maintaining Asset Replication

You use the **Asset Replication** portal is used to display and maintain asset replication activities.

Refer to [About Asset Replication](#) for additional functional information.

You can access the portal from **Menu > Asset Management > Asset Replication**. You are brought to a query portal with options for searching. Once your record has been selected you are brought to the maintenance portal to view and maintain the selected record.

The following zones may appear as part of the portal's **Main** tab page:

- **Asset Replication:** This zone displays the basic attributes of the asset replication activity.
- **Completion Event:** This zone displays a list of completion events related to the asset replication activity.

Manufacturers

About Manufacturers

Manufacturers are the companies that makes assets (devices, communication components, transformers, etc.).

An asset is related to a manufacturer through the asset's specification.

Each manufacturer can have zero or more models defined. Models for a single manufacturer can have diverse service types.

Maintaining Manufacturers

You use the **Manufacturer** portal is used to display and maintain manufacturers.

Refer to [About Manufacturers](#) for additional functional information.

You can access the portal from **Menu**, then **Asset Management**, then **Manufacturer**. You are brought to a query portal with options for searching. Once your record has been selected you are brought to the maintenance portal to view and maintain the selected record.

The following zones may appear as part of the portal's **Main** tab page:

- **Manufacturer:** This zone displays the basic attributes of the manufacturer.
- **Manufacturer Models:** This zone displays a list of models associated with the manufacture. To add or edit models available for the manufacturer, click **Edit** in the zone title bar.
- **Manufacturer Specifications:** This zone displays a list of specifications associated with the manufacturer. Use the **Specification** portal to add or edit the specifications associated with the manufacturer.

Mass Asset Disposition Update

You use the **Mass Asset Disposition Update** portal is used to update the disposition of a group of assets.

More specifically, Mass Asset Disposition is used for moving many assets of the same type from one location to another location. In a mass disposition task, the target is always a single asset location. For example, if a pallet of meters has been received in the receiving asset location, mass disposition can be used to move this batch of assets to a storage asset location or an out of service location.

Refer to [About Assets](#) for additional functional information.

To use the **Mass Asset Disposition Update** portal:

1. Select **Menu > Asset Management > Mass Asset Disposition Update**.
You are brought to a query portal with options for searching assets
2. Enter search criteria appropriate to the asset you wish to update and click **Search**.
3. From the list of search results, select the assets you wish to update and click **Change Disposition**. The **Mass Asset Disposition Update** screen opens.
4. Enter the date and time at which the update should take effect in the **Effective Date/Time** field.
5. Select the new disposition for the assets from the **Asset Disposition** drop-down list.
6. Select the new location for the assets from the **Location** drop-down list or field.
7. Select or enter other data as appropriate (based on the new disposition). For instance, if you select "Rejected" you must also select a reason from the **Reason** drop-down list.

Service History

About Service History

Service history is used to capture and record relevant information regarding service or maintenance on assets. Typically it is used to record inspection feedback, pass/fail details, downtime, parts failure information, maintenance or service logs, or other information regarding service on the asset.

Types of service history might include:

- Asset downtime
- Failure details
- Asset maintenance
- Visual inspection
- Leak detection
- Smart meter test
- Battery replacement
- ..., and so on.

Service history records can be manually created or automatically generated as the result of completion events being processed for activities. If the service history type has any schedule defined, a set schedule may also be established to create regular service history for repeated tasks such as inspection or regular maintenance. Service history types linked to asset types control which service history can be created for assets.

Maintaining Service History

You use the **Service History** portal is used to display and maintain service history records.

Refer to [About Service History](#) for additional functional information.

You can access the portal from **Menu > Asset Management > Service History**. You are brought to a query portal with options for searching. Once your record has been selected you are brought to the maintenance portal to view and maintain the selected record.

The following zones may appear as part of the portal's **Main** tab page:

- **Service History**: This zone displays the basic attributes of the service history record.

Shipping Memos

About Shipping Memos

Shipping memos are records of stock items being shipped from an internal storeroom, whether from storeroom to storeroom or from storeroom to vendor.

Shipping memos can be created for both standard and tracked stock items and enables storeroom managers and shipping clerks a way to manage and track stock items being shipped between locations.

Some uses for shipping memo include the following:

- Tracking stock items returned to vendors for credit, replacement, or repair
- Helping to manage the return of repaired or replacement stock items back into inventory

Oracle Utilities Customer To Meter uses the following types of shipping memos:

- **General**: the shipping memo category that should be used when manually creating shipping memos

Oracle Utilities Work and Asset Management and Oracle Utilities Operational Device Management include additional types of shipping memos.

Maintaining Shipping Memos

You use the **Shipping Memo** portal is used to display and maintain shipping memos.

Refer to [About Shipping Memos](#) for additional functional information.

You can access the portal from **Menu > Inventory > Shipping Memo**. You are brought to a query portal with options for searching. Once your record has been selected you are brought to the maintenance portal to view and maintain the selected record.

The following zones may appear as part of the portal's **Main** tab page:

- **Shipping Memo:** This zone provides information about the shipping memo, such as shipping category, shipping memo number, ship to details, and tracking information.
- **Shipping Lines:** This zone provides links to the shipping line and stock items associated with the shipping memo.

Specifications

About Specifications

Specifications are used to define the manufacturer, model, and other information about a set of assets.

- Specifications can include attachments which support the specification definition or provide the actual specification from the manufacturer.
- Specifications may also include default in service and out of service maintenance schedules for assets or components linked to the specification. When the specification is associated with the asset or component, the related maintenance schedule becomes in effect for the asset or component.

Specifications are defined by the following:

- **Asset Type:** The [asset type](#) associated with the specification. This links the specification to assets (assets of the specified asset type reference the current specification).
- **Manufacturer:** The manufacturer associated with the specification.
- **Detail:** Additional details pertaining to the specification. Details can include
 - **Model:** The model number for the specification. Used with item specifications.
 - **Configuration Mapping:** Details of the template device used when creating devices ([meters](#), [items](#), or [communication components](#)) based on assets that reference this specification. This includes:
 - **Configuration:** The type of configuration
 - **Device Identifier Type:** The device identifier type (Asset ID, Badge Number, Serial Number, etc.) used to identify the template device
 - **Identifier Value:** The value for the specified device identifier type used to identify the template device (for example, the Badge Number of the template device)
- **Firmware Information:** Details concerning the firmware specifications associated with the specification (not used with analog meter specifications)

The base package includes the following specifications, each based on a different business object. The table below lists the base package specifications and the business objects for each.

Specification	Business Object
Analog Meter Specification	W2-ManualMeterSpecification
Item Specification	W1ItemSpecification
Communication Component Specification	W2-CommunicationComponentSpec
Communication Relay Specification	W2-CommunicationRelaySpec
Firmware Specification	W2-FirmwareSpecification
Analog Meter Specification	W2-ManualMeterSpecification
Smart Meter Specification	W2-SmartMeterSpecification

Maintaining Specifications

You use the **Specification** portal is used to display and maintain specifications.

Refer to [About Specifications](#) for additional functional information.

You can access the portal by selecting **Menu**, then **Asset Management**, then **Specification**. You are brought to a query portal with options for searching. Once your record has been selected you are brought to the maintenance portal to view and maintain the selected record.

The following zones may appear as part of the portal's **Main** tab page:

- **Specification:** This zone displays the basic attributes of the specification.
- **Specification Assets:** This zone displays a list of assets that reference the specification.

Device Management

Devices

About Meters



Meters are a type of device, which can be physical or virtual objects, that can produce data to be handled by the system.

A meter can have one or more device configurations over time. A meter's measuring components (if applicable) are associated with the device via device configurations.

A meter's device category (defined as an option on the device's business object) defines the broad category to which a particular device belongs. This option is used by smart meter commands and other processes when determining how the system should behave when executing processes based on the category of device. For example, when viewing items via the Device portal, certain item-specific zones appear that are not displayed when viewing meters or communication components. The base package supports the following device categories for meters:

- **Smart Meter:** these meters are associated to a head end system and support smart meter commands. The measuring components associated to these devices are expected to be read very frequently. These meters support periodic estimation.
Refer to [About Periodic Estimation](#) for additional functional information about how the periodic estimation can fill in missing reads for both interval and scalar measuring components.
- **AMR Meter:** these meters may also be associated to a head end system but they do not support smart meter commands. The measuring components are read frequently.
- **Manual Meter:** these meters are seldom read and do not support smart meter commands.

Attributes used to define devices include the following:

- Basic information about the Device including type of device (Smart Meter, Manual Meter, and so on), Manufacturer, and Model
- One or more device identifiers such as serial number, badge number, meter number, etc.
- For smart meters the device can also specify a head end system and an incoming data shift. Note: these fields are only necessary when there is no fallback defined on the device type.

Refer to [Initial Measurement Data](#) for additional functional information about how the device's head end system and incoming data shift can impact processing.

About Communication Modules

Communication modules enable automatic meter reading for manual meters, and handle electronic transmission of measurement data and events for meters that are not capable or not enabled to handle this data. Devices of this sort are attached to manual meters as equipment, and in the case of modules that measure consumption or other data, are associated to the physical meter's scalar measuring components.

Communication modules associated with a manual meter are defined in the **Device Equipment** list on the Manual Meter business object (D1-ManualMeter). See the embedded help for more information.

Creating Measuring Components for Communication Modules

Measuring components used with communication modules must be scalar register measuring components (based on the D1-Register business object) and must be defined on the manual meter's device configuration.

If the communication modules will also record interval consumption, create an interval channel measuring component (based on the D1-IntervalChannel business object) add it to the manual meter's device configuration, and add it as the register measuring component's **Consumption Reference Measuring Component**.

Measurement and Device Event Processing for Communication Modules

The IMD Seeder and Device Event Seeder support payloads that reference the communication module identifiers currently attached to a physical meter, instead of the physical meter's identifier.

Based on the physical meter and the communication module currently attached to it, the seeders can identify the physical meter's register (or related interval) measuring component and use it for instantiating the initial measurement or device event.

Devices and Characteristics

Characteristics can be defined for devices using the **Device Characteristics** zone on the **Device** portal. Only characteristics of types defined for the device's type in the **Valid Device Characteristic Types** zone on the Device Type portal can be defined for the device.

About Items



While the most common type of devices are meters, there are many other devices that can be involved with a customer's service. These other devices are referred to simply as "items", and are used to represent lamps, poles, current transformers, backflow devices, pulse initiators, etc.

Items can be either "badged" or "unbadged". "Badged" items are those that have unique identifiers, and are represented by device records. Device records are not created for "unbadged" items. "Badged" items are installed at service points in much the same way as meters are installed (though they use an item-specific install event). For "unbadged" items, "multi-item" service points are used to define the number of each type of item that is installed at the service point.

These "badged" items are not directly measured and therefore do not have a measuring component. Instead there is configuration on the device type that will identify an effective dated average daily usage. Using the average daily usage the item's consumption will be calculated. The total consumption for a given period will always be equal to the average daily usage multiplied by the duration of the period. However, when the consumption for a period is turned into an interval curve there are two ways this can be done:

- **Use Straight Line:** the consumption will be evenly divided amongst the intervals (thus producing a straight line when graphed)
- **Use Profile:** a profile measuring component will be used to align the consumption to a curve. This is useful because it can more accurately identify the hours where consumption has occurred.

Refer to [About Service Points](#) for additional functional information about "unbadged" items.

About Communication Components

Communication components are devices attached to meters. A communication component may handle electronic transmission of measurement data, events, and commands in situations in which the underlying meter is not capable or not enabled to handle this data. Devices of this sort are sometimes referred to as ERT (Electronic Receiver/Transmitter) meters, or communication modules (for example, the term "gas module" may refer to a communication module attached to a gas meter).

Maintaining Devices

This portal is used to display and maintain a Device.

Refer to [About Meters](#), [About Items](#), and [About Communication Components](#) for additional functional information.

You can access the portal by selecting **Menu**, then **Device**, then **Device**. You are brought to a query portal with options for searching. Once your record has been selected you are brought to the maintenance portal to view and maintain the selected record.

The **Device** portal includes the following zones:

- **Device:** defines the basic attributes of the device
- **Device Configuration List:** lists the device configurations for the device

- **Device Attachments:** lists attachments related to the device
- **Device Activities:** lists activities related to the device in date descending order
- **Device Exceptions:** lists the first 50 VEE exceptions for all measuring components for the device, sorted by the exception creation date in descending order
- **Device Events:** lists the most recent device events associated to the device in descending order
- **Device Characteristics:** displays characteristics defined for the device. To add device characteristics, click the **Edit** link in the zone title bar.

NOTE: Only characteristics of types defined for the device's type in the **Valid Device Characteristic Types** zone on the **Device Type** portal can be defined for the device.

NOTE: When asset management functionality is installed with Oracle Utilities Meter Solution Cloud Service, devices are maintained using the **Device** tab of the **Asset** portal (see [Maintaining Assets](#)).

Device Configurations

About Device Configurations

Device configurations represent specific configurations of a device as of a certain time.

Over time, a device can have many configurations. Device configurations are effective-dated allowing a device to retain its identifiers (such as serial number, badge number, etc.) even while the quantities it measures change over time.

Each device configuration can have one or more measuring components associated with it.

Attributes used to define device configurations include the following:

- The device configuration type
- The parent device
- The effective date and time of the device configuration
- The time zone in which the device operates

Refer to [Multi Time Zone Support](#) for additional information on the importance of the Device Configuration time zone.

Maintaining Device Configurations

You use the Device Configuration portal to maintain device configurations.

Refer to [About Device Configuration](#) for additional functional information.

You can access the portal from **Menu > Device > Device Configuration**. You are brought to a query portal with options for searching. Once your record has been selected you are brought to the maintenance portal to view and maintain the selected record.

This portal includes the following zones:

- **Device Configuration:** Defines the basic attributes of the device configuration
- **Measuring Components:** Lists the measuring components for the device configuration

- **Scalar Readings:** Displays a list of scalar readings for scalar measuring components associated with the current device configuration. To create a new reading for scalar measuring components associated with the device configuration, click **New Reading**. To edit an existing reading, click the edit icon for the reading you wish to edit.

NOTE: The Scalar Readings zone is available only with Oracle Utilities Meter Data Management.

Measuring Components

About Measuring Components

Measuring components are single points for which data will be received and stored in the system.

A measuring component can be associated to a device, which can have one or more measuring components, or it can be "virtual" or "stand-alone," meaning that it is not associated to a device.

The base package supports the following types of measuring components:

- **Physical:** Physical measuring components are those that physically exist, and that are linked to a device that can be configured differently over time. Interval channels and scalar registers are examples of physical measuring components. Note: The terms register and channel are synonyms for measuring component.
- **Standalone:** A standalone measuring component is used to record measurements for something that does not have a physical presence or is not associated to a particular device or service point. For example, you might create a standalone measuring component to record the average daily temperature supplied by a weather station. Standalone measuring components can be identified through **Standalone Identifier**.
- **Scratchpad:** Users create scratchpad measuring components based on physical measuring components to experiment with measurement manipulation functions.
- **Aggregator:** An aggregator measuring component holds summarized usage from other measuring components. For example, aggregator measuring components could be configured to hold total consumption for each postal code within a service territory. Head end system processing statistics used by Oracle Utilities Smart Grid Gateway are stored as aggregated measurements for aggregator measuring components. Refer to [About Aggregations](#) for additional functional information about aggregation measuring components.

Attributes used to define measuring components can include the following:

- The measuring component type
- The device configuration to which the measuring component is associated
- Details concerning how the measuring component is read, such as the number of digits, the type of read out (dials or digital), the meter multiplier, etc.
- The VEE groups used for validation and estimation of measurement data. Refer to [About VEE](#) for details about the types of VEE groups supported.

Scalar vs. Interval

Beyond the four types described above, measuring components generally fall into one of two primary classes of: scalar measuring components, and interval measuring components.

- **Scalar measuring components** are measured at unpredictable intervals. For example, "once a month" is not a predictable interval as the amount of time between reads is unpredictable and inconsistent.
- **Interval measuring components** are measured at predictable intervals, such as every 15 minutes, every 30 minutes, every hour, etc.
- The terms "interval size" and "seconds-per-interval" (SPI) are used to define the size of an interval measuring component's intervals.

- Note: A device may have any combination of interval and/or scalar measuring components

Measuring Component Measurements

Measuring components are configured to measure specific types of quantities. These include:

- **Unit of Measure:** The unit of measure for the quantity being recorded. Examples include kilo-watt hours (kWh), kilowatts (kW), therms, cubic feet (CCF), temperature (Fahrenheit or Celsius), etc.
- **Time of Use:** Modifiers for a given unit of measure that indicate a period of time during which a quantity has been used, such as On-Peak (meaning during a time when the greatest quantity of some consumable is being used), Off-Peak (meaning during a time when the least amount of some consumable is being used), etc.
- **Service Quantity Identifiers:** Used to further distinguish between measured quantities that have identical UOM/TOU combinations, including situations in which the distinguishing identifier of a UOM is not accurately described as a TOU. Generally, SQI is only used when multiple measuring components measure the same thing, but in different ways. A meter that measures both generation KWH and consumption KWH could use SQIs to differentiate between the two.

The combination of UOM, TOU and SQI define what a measuring component measures. TOU and SQI are optional, but UOM must be defined for all measuring components. For example, consider a meter (as illustrated in the image below) with two measuring components, both measuring the same unit of measure (kWh), but each measuring component measures consumption in different time of use (TOU) periods (peak and off-peak).

Subtractive vs. Consumptive Measurements

Another attribute that defines how measuring components measure quantities is the distinction between subtractive and consumptive measuring components.

A subtractive measuring component's usage is equal to the current reading (also known as the Stop or End Measurement or Reading) minus the previous reading (also known as the Start Measurement or Reading). To put this more simply:

Usage = End Reading - Start Reading

Most residential scalar meters are subtractive and in some cases interval meters can be subtractive as well . The table below lists a series of measurements for a subtractive measuring component.

Date	kWh (Reading)	Usage
01/01/2010	0	
01/31/2010	1000	1000 kWh
03/02/2010	1780	780 kWh
04/01/2010	2700	920 kWh

A consumptive measuring component's usage is equal to its current measurement. Most residential interval meters are subtractive. For scalar, consumptive measuring components are often used to measure demand, such as KW. The table below lists a series of measurements for a consumptive scalar measuring component.

Date	KW (Reading)	Usage
01/01/2010	0	0 KW
01/31/2010	10	10 KW
03/02/2010	10	10 KW
04/01/2010	13	13 KW

Physical Measuring Components

Physical measuring components are associated to the meters installed at service points. Through a device configuration there can be one-to-many measuring components in place at a given point in time. Much like other measuring components these are either scalar or interval and either consumptive or subtractive.

NOTE: Refer to [About Measuring Components](#) for additional information about scalar versus interval and consumptive versus subtractive measuring components.

The base product supports a core set of physical measuring components, as described in the following sections.

Interval Channel

These measuring components represent consumptive data that is recorded on a regular and consistent frequency as defined by the interval size. By definition interval data must fall on a specific interval boundary. For example, a meter that receives data once per hour cannot have a measurement at 1:30. Rather, the data must fall on either 1:00 or 2:00 not in between.

Data for interval channels is expected to be contiguous. However, in situations where it is not, there is no impact to the calculation of those intervals subsequent to the missing intervals. This is because the calculation of each interval is independent to all other intervals.

If there is a gap in the intervals it can be estimated through the periodic estimation process.

Interval Channel - Subtractive

These measuring components have behavior characteristics of both interval channels and registers. Like the interval channel they receive data on a regular and consistent frequency that is expected to be contiguous. Like a register they use a subtractive consumption calculation and provide rollover validation.

Unlike the interval channel when there are missing intervals there is an impact on the calculation of those intervals subsequent to the missing intervals. This is because the calculation of a given interval is always computed by subtracting its reading from the last known prior reading. The following table describes an example of that scenario:

Date/Time	Reading Condition	Reading	Measurement Condition	Usage
01/01/2010 12:00AM	Regular	0	Regular	0 kWh
01/01/2010 01:00AM	Regular	10	Regular	10 kWh
01/01/2010 02:00AM	Regular	20	Regular	10 kWh
01/01/2010 03:00AM	Regular	30	Regular	10 kWh
Missing measurements				
1/01/2010 12:00PM	Regular	120	Combined Quantity	90 kWh

Notice that the consumption for the 01/01/2010 12:00PM interval has become overloaded and covers the entire period for which no intervals have had been received. Also take note that the measurement condition is assigned a unique condition of Combined Quantity to signify that the consumption covers more than one interval.

A similar situation can arise when there has been an underestimation of consumption for a particular meter:

Date/Time	Reading Condition	Reading	Measurement Condition	Usage
01/01/2010 12:00AM	Regular	0	Regular	0 kWh
01/01/2010 01:00AM	System Estimate	10	System Estimate	10 kWh
01/01/2010 02:00AM	System Estimate	13	System Estimate	3 kWh

01/01/2010 03:00AM	System Estimate	16	System Estimate	3 kWh
1/01/2010 04:00AM	Regular	40	Estimated	24 kWh

To help avoid these situations where an interval becomes overloaded with usage due to missing or estimated intervals the subtractive interval channel has the ability to initiate the calculation of missing intervals or re-calculation of estimated intervals when processing newly received intervals.

NOTE: Refer to [Understanding Measuring Component Types](#) link for additional information about how to configure subtractive interval measuring component types to perform prior and subsequent estimation.

Register

A register, often referred to as scalar, measuring component is used to represent infrequently received data from a meter. Typically these types of measuring components will only be read once per month aligning to the billing period for the customer.

The physical meter these measuring components represent often have dial readings where there are a finite number of digits that can register the consumption. When the maximum amount has been measured the meter will rollover and start counting once more from zero. To appropriately handle these scenarios this type of measuring component can be defined with a rollover tolerance that allows the system to accurately identify an invalid reading from a standard rollover. For example when a meter has 6 dials (a maximum of 999,999):

- Going from a reading of 999,990 to 20 would likely be valid and represent consumption of 30.
- Whereas going from a reading of 999,990 to 800,000 would be an invalid reading since it would represent consumption of 810,000.

Given the infrequent nature of these measuring components they are not eligible for the periodic estimation process.

Register - Auto-Read

An automatically read register processes nearly identical to a register. The key difference between these two types of measuring components is that the automatically read variant is expected to be read on a frequency of at least once per day.

These measuring components are eligible for periodic estimation since the information about their reading schedule allows for missing readings to be detected and estimated.

Given the frequency these meters are read and the nature of subtractive consumption calculation they can be configured to re-estimate any past or future estimates when actual data has been received. The actual readings allow these estimates to be refined since the total consumption for the estimated period can be calculated (current reading - last reading prior to estimation).

NOTE: Refer to [Periodic Estimation](#) for additional functional information about how the periodic estimation can fill in missing reads for both interval and scalar measuring components.

Scratchpad Measuring Components

Scratchpad measuring components provide users with a means to manipulate "scratchpad" measurement data without affecting existing "live" measurement data. Examples of measurement manipulation might include experimenting with the impact of executing the "spike smooth" function on an initial measurement, or adding or removing intervals to or from the measurement.

Scratchpad measuring components are defined by the same attributes as "regular" measuring components, with the following additional attributes:

- **User:** The name of the user who created the scratchpad. All scratchpad measuring components "belong" to a user.
- **Source Measuring Component:** The measuring component upon which the scratchpad is based.

Like "regular" measuring components, scratchpad measuring components can be related to a device through a device configuration, but scratchpad measuring components are not considered "active" for purposes of install events, and are not used in usage calculations for usage subscriptions.

Like "regular" measuring components, scratchpad measuring components are viewed and maintained using the Measuring Component portal, and measurement data for scratchpad measuring components can be viewed using the Initial Measurement portal or the 360 Degree View.

Maintaining Measuring Components

You use the **Measuring Component** portal to maintain measuring components.

Refer to [About Measuring Components](#) for additional functional information.

You can access the portal from **Menu > Device > Measuring Components**. You are brought to a query portal with options for searching. Once your record has been selected you are brought to the maintenance portal to view and maintain the selected record.

This portal includes the following zones:

- **Measuring Component:** defines the basic attributes of the measuring component
- **Initial Measurement Data History:** lists the last 50 initial measurements for the measuring component in reverse chronological order.
- **Measuring Component Profile Use:** lists all profile factors on which the measuring component is referenced as a factor value.
- **Measurements:** lists final measurements for the measuring component, including any derived values for each measurement. Note: depending on the type of measuring component this zone may be the Interval, Scalar, or Subtractive Interval variant.
- **Device Configuration Overview:** Displays an overview of the measuring component's parent device's configurations over time, including the measuring components associated with each configuration, and service points (along with the relevant install events) at which the device's configurations have been installed over time, if any exist.
- **Data Requests:** Lists data requests for the measuring component. Applicable only for Standalone Data Request measuring components (based on the Standalone Data Request MC business object)
- **Measuring Component Comparison Period Details:** Lists comparison periods for the measuring component (created when the current measuring component is compared to another measuring component via the Interval Proxy Day Estimation VEE rule)

Uploading Measurement Data

Measurement data for a measuring component can be manually uploaded in comma separated values (CSV) format. This can be used to import data from external sources, such as weather systems or other market participants such as system operators in a settlement market.

This feature is accessed via the **Load IMDs (CSV)** option on the measuring component's context menu. When this option is selected, the **Online IMD CSV Upload** screen opens. From this screen users can select a CSV file containing measurement data to upload from a local desktop.

Import files can contain one or more initial measurements. For interval data, breaks between initial measurements will be based on a gap greater than one interval size (SPI) between intervals. For scalar measurements, each row will create a separate initial measurement.

Refer to the embedded help on this page for details concerning the format of CSV files used for importing measurement data.

When processed, each initial measurement in the import file results in the creating of an initial measurement for the measuring component.

Requesting Measurement Data

The base package provides a mechanism by which standalone measuring components can request data from an external application. Examples of this include requesting data weather data from a weather station or zonal load data from an independent system operator (ISO) when used with Oracle Utilities Market Settlements Management. Measuring components of this type are referred to as “standalone measuring components”.

Standalone Data Request Measuring Components

Requesting measurement data for standalone measuring components is supported by the “Standalone Data Request MC” (D1-StandaloneDataRequestMC) and “Standalone Data Request MC Type (D1-StandaloneDataRequestMCType) business objects.

Standalone data request measuring components use many of the same attributes as device-based measuring components, but also use the following unique parameters:

- **Standalone Identifier:** An identifier for the measuring component. This ID is used when importing data for standalone measuring components via the standard initial measurement loading process (see [About Initial Measurement Data](#) for more information).
- **Processing Timetable Type:** A processing timetable type used when scheduling data requests. If not specified, a fallback processing timetable type can be defined on the measuring component’s type.
- **Service Provider:** The external application to which data requests are sent. If not specified, a fallback external application can be defined on the measuring component’s type.
- **Request Information:** Details about the last data request processed for the measuring component

Measurement Data Requests

Requests for measurement data can be scheduled or made manually by a user.

- Scheduled requests are triggered by the “Standalone MC Data Request - Monitor” batch process.
- Manual requests are triggered by clicking the **Request Data** button in the **Record Actions** section of the **Measuring Component** zone.

This opens the Request dialog where te user enters a start and end date/time for the request.

Each of these invokes the “Calculate Schedule and Create Outbound Communication” algorithm which creates an outbound communication based on the processing method defined for the external application (Service Provider). When the external application sends back the requested measurement data, it can be received via the standard method for importing measurement data.

Configuring External Applications for Measurement Data Requests

To support measurement data requests, the following processing method must be defined for the external applications to which data requests are sent:

Processing Role	Processing Method
Standalone MC Data Request	How to Send MC Related Information Used to send the outbound communication to the external application. Default Communication Out Business Object: D1-StandaloneMCDataRequest (Standalone MC Data Request Communication Out

Processing Role

Processing Method

The **Request Mapping Algorithm** and **Response Mapping Algorithm** options can be used to map the format of data both from the standard format to an external system format and from an external system format to the standard format.

For example, when requesting for zonal load from an ISO the process would be:

- Take the input of an outbound communication that has the measuring component's standalone ID and the date/times and put it into the zonal request format for the ISO
- Take the input of an outbound message that has the response from the ISO with the intervals and convert it into the IMD format

In addition, the following objects must be configured to send data requests.:

- Communication Type for “Standalone MC Data Request Communication Type”
- External System
- Outbound Message Type
- Message Sender

Measuring Component Comparison Periods

About Measuring Component Comparison Periods

Measuring component comparison periods are records of measuring component comparison. These are used by the Interval Proxy Day Estimation VEE rule to compare weather data to identify historical dates that most closely match current and/or future dates.

Measuring component comparison periods are created by the Interval Proxy Day Estimation rule, and are defined the following:

- **Primary Measuring Component:** The measuring component against which the comparison will be run
- **End Date / Start Date:** The date range that is compared to the period for the **Examined Measuring Component** (defined by the **Examined End Date** and **Examined Start Date**)
- **Rank:** The rank of this data point relative to the other comparison period stores for the same Measuring Component, Comparison Type, and End Date. The lower the rank, the better.
- **Examined Measuring Component:** The measuring component that will be compared to the **Primary Measuring Component**.
- **Examined End Date / Examined Start Date:** The date range that is compared to the period for the Primary Measuring Component (defined by the **End Date** and **Start Date**)
- **Lowest Quality Condition :** The lowest quality of condition code that was found for the measurements in the related period.
- **Comparison Metric:** The specific metric used to calculate the Comparison Result from the related Comparison Type)
- **Comparison Result:** The value result of the comparison.

Maintaining Measuring Component Comparison Periods

You use the **Measuring Component Comparison Period** portal to maintain measuring component comparison periods. Refer to [About Measuring Component Comparison Periods](#) for additional functional information.

You can access the portal from **Menu > Device > Measuring Component Comparison Period**. You are brought to a query portal with options for searching. Once your record has been selected you are brought to the maintenance portal to view and maintain the selected record.

The following zones may appear as part of the portal's **Main** tab page:

- **Measuring Component Comparison Period:** This zone displays the basic attributes of the measuring component comparison period.

Device Installations

Service Points

About Service Points

Service points are physical locations (usually a meter socket) at which a company supplies service and are used in Oracle Utilities Meter Data Management to store information describing the type of service supplied and how it is measured. Devices are installed at service points, and the relationship between individual service points and devices can change over time. For example, over time different devices may be installed at a service point, and a device may be installed at different service points.

A service point may only have one device. If multiple devices at a service point are required, define a parent and child service point relationship to create a hierarchy of service points. On each service point, users will be able to specify a parent service point. An example of this feature would be to link each condominium in a building to a parent service point that represents the common areas of the building. Another example would be a deregulated service point that allows multiple devices per service point. In this example, the parent service point would be the market service point ID and the children service points would relate to the individual devices.

Service Point

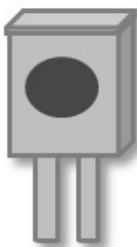

Attributes used to define Service Points can include the following:

- Basic information about the Service Point, including address, time zone, market, parent Service Point (if applicable), status, and main contact

- Specifics related to whether or not the current Service Point supplies service to life support equipment, or if the load supplied to the Service Point is considered sensitive
- Information related to field work performed at the current Service Point, including any applicable warnings or instructions
- The measurement cycle, route, and route sequence for the Service Point

Service Point Access via Access Groups and Divisions

Access to service points (and objects and data related to the service point, see below) can be restricted based on Access Groups and Divisions.

Restriction via Access Groups

Service point data access restriction based on Access Group is enabled by default. Users can only access service points (and related objects and data) with an Access Group associated with the user via Access Role on the **Access Security** **Access Security** tab of the **User Preferences** portal. See [The Big Picture of Row Security](#) in the *Administrative User Guide* for more information about Access Groups and Access Roles. Restriction via Access Groups applies to all service point queries, including use of the **Service Point Search** zone, the **Route Management** and **360 Search** portals, and service point queries on other zones and portals.

Restriction via Division

To enable service point data access restriction based on Division, select "Yes" from the **Restrict Division** drop-down list in the **Control By Division** section of MDM Master Configuration.

When this restriction is in effect, users can only access service points (and related objects and data) with a Division (or Divisions) associated with the user on the **User Miscellaneous Information** zone on the **Miscellaneous** tab of the **User** portal. This applies to all service point queries, including use of the **Service Point Search** zone, the **Route Management** and **360 Search** portals, and service point queries on other zones and portals.

Unbadged Items

Items that do not have any unique identification are referred to as "unbadged." These types of items, unlike "badged" items, do not have a device to represent them. Instead they are associated to service points with the service point category of "multi-item." For these types of service points a list of "unbadged" items can be configured to represent the items that require usage to be calculated. This is an effective dated list that allows for changes over time to the type and count of items over time. The consumption of the list of items is either calculated using the service quantity associated to the item types listed or by using the installation override quantity that can be specified on the service point.

Refer to [Multi Time Zone Support](#) for additional information on the importance of the Service Point time zone.

Maintaining Service Points

You use the **Service Point** portal to view and maintain service points.

Refer to [About Service Points](#) for additional functional information.

You can access the portal by selecting **Menu**, then **Device Installation**, then **Service Point**. You are brought to a query portal with options for searching. Once your record has been selected you are brought to the maintenance portal to view and maintain the selected record.

NOTE: When searching for services points or creating new service points, if the **Restrict Division** setting in the **Control by Division** section in the MDM Master Configuration is set to "Yes", only service point types with a Division (or Divisions) associated with the user on the **User Miscellaneous Information** zone on the **Miscellaneous** tab of the **User** portal will be available. In addition, the **Division** drop-down list will only list divisions associated with the user.

See **Restriction via Division** in [About Service Points](#) for more information.

The following zones may appear as part of the portal's **Main** tab page:

- **Service Point:** defines the basic attributes of the service point
- **Service Point Attachments:** lists attachments related to the current service point
- **Device History:** lists all device configurations that have been installed for the service point, in reverse chronological order
- **Usage Subscriptions:** lists all usage subscriptions linked to the service point, sorted in descending order by Start Date/Time of Usage Subscription/Service Point
- **SP Quantities:** lists service point quantities for the current service point
- **SP Market Participants:** lists all market participants linked to the current service point
- **Child Service Points:** lists the first 50 children service points of the current service point (displayed only if the current service point has child service points)
- **SP/Measurement Cycle Schedule Route List:** lists all the measurement cycle schedule routes linked to the service point.
- **SP Service Issue Monitors:** displays a list of service issue monitors and related service investigative orders related to the current service point, in reverse chronological order.
- **SP Suppression History:** displays a list of suppression activities related to the service point in reverse chronological order.
- **SP Activity History:** shows all activities linked to the service point. The results can be filtered based on activity type category and creation date/time.
- **SP Network Locations:** lists all network locations linked to any facility associated with the service point, ordered by start date/time.
- **SP Business Flags:** displays a list of business flags related to the service point in reverse chronological order.

Service Point Quantities

About Service Point Quantities

Service point quantities are quantities that are stored at the service point level. These quantities are calculated at irregular frequencies (such as annually or quarterly) and thus do not make sense as a measured quantity on a device and measuring component. For example, in some deregulated markets the Peak Load Contribution could be stored here and effective dated over time to represent the changing contribution of a given service point to the market wide coincidence peaks.

Service point quantities are defined by the following:

- **Service Point:** The service point for which the quantities were calculated
- **Service Point Quantity Type:** The Service Point Quantity Type used for the record
- **Start Date / End Date:** The date range for the calculated quantity
- **Service Point Quantities:** Calculated quantities based on **Quantity Identifiers** configured on the Service Point Quantity Type (see [Understanding Service Point Quantity Types](#) for more information)

NOTE: There cannot be more than one Service Point Quantity for the same Service Point, Service Point Quantity Type, for the same time period (defined by the Start Date and End Date parameters).

Maintaining Service Point Quantities

You use the **Service Point Quantity** portal to view and maintain service point quantities.

Refer to [About Service Point Quantities](#) for additional functional information.

You can access the portal from the **Main > Device Installation > Service Point Quantity**. You are brought to a query portal with options for searching. Once your record has been selected you are brought to the maintenance portal to view and maintain the selected record.

The following zones may appear as part of the portal's **Main** tab page:

- **Service Point Quantity:** This zone displays the basic attributes of the service point quantity

Install Events

About Install Events

Whenever a device is installed at a Service Point, an installation event is created. Installation events capture the history of the devices that have been installed at a Service Point. This allows consumption for a Service Point to be calculated over time. In technical terms, installation events (or Install Events) link a specific Device Configuration to a Service Point.

There are specific Install Event business objects for different types of devices, including smart meters, items, manual meters, and communication components.

When creating Install Events for items, only "badged" items (those that are uniquely identified in some way) use item Install Events. "Unbadged" items do not use Install Events. Instead, the number of each type of item is specified in the "Multi-Item Detail" section of the Service Point.

While a device is installed at a Service Point, it may be turned off (and back on again). The installation event that records the original installation date and time also records the dates and times when the device has been turned on and off. When a device is removed, the original installation event is updated with the removal date and time.

Maintaining Install Events

This portal is used to display and maintain an Install Event.

Refer to [About Install Events](#) for additional functional information.

You can access the portal from **Menu > Device Installation > Install Event**. You are brought to a query portal with options for searching. Once your record has been selected you are brought to the maintenance portal to view and maintain the selected record.

The following zones may appear as part of the portal's **Main** tab page:

- **Install Event:** defines the basic attributes of the Install Event, the on/off history for the Install Event, and removal information.

When creating a new record, the following options are available:

Name	Details	Business Object
Communication Component Install Event	This Install Event is intended for use with a Communication Component that is installed on top of a traditional Meter.	D1-CommComponentInstallEvent
Item Installation Event	This Install Event records the installation of an Item (i.e. streetlight).	D1-ItemInstallEvent

Manual Meter Installation Event	This Install Event is used for manually read meters.	D1-ManualMeterInstallEvent
Smart Meter Installation Event	This Install Event is unique to smart meters and has a lifecycle that's maintained by remote meter commands.	D1-SmartMeterInstallEvent

Correcting Cross Installed Meters

Cross installed meters is the term for situations in which meters are deployed at an incorrect customer service point. Consider the following example: Meter A is supposed to be installed at Service Point A and Meter B is supposed to be installed at Service Point B, but Meter B was mistakenly installed at Service Point A, and Meter A was mistakenly installed at Service Point B. This means that both customers will be billed incorrectly (customer at Service Point A will be billed for usage at Service Point B and vice versa) until the system can be updated to reflect the correct meter installations.

The Cross Installed Meters process provides a tool to re-configure the meters through a correction process. When a user initiates the Cross Installed Meters process, the system will update device installation event details (like status, date and time of installation), device configurations, and measuring components with the correct information. Note that this process does NOT include changing the physical location of the meters. It only changes the relationship between the meters and service points in the application.

This process can also be used to issue financial adjustments and/or cancel/rebill any bill segments that are impacted by the change in meters, and create customer contacts related to the changes. See [Adjustments](#) and [Cancel / Rebill Incorrect Bill Segments](#) for more information about adjustments and rebilling.

Cross installed meter processing is initiated, monitored, and maintained using the **Process Flow** portal and functionality.

See [Process Flows](#) in the *Administrative User Guide* for more information regarding the process flow functionality.

See [Configuring Cross Installed Meter Processing](#) in the *Administrative User Guide* for information about configuring administrative data required by the Cross Installed Meter process.

Initiating a Cross Installed Meter Process

Use the following procedure to initiate a cross installed meter process:

1. Select **Menu, Device Installation, Cross Installed Meter Process, Add**. The **Cross Installed Meters** process flow screen opens on the **Swap Meters** panel.
2. Use the **Cross Installed Meter Identification** section to search for and select the first meter (Meter 1).
 - a. Select **Meter 1**.
 - b. Enter the search criteria for the meter. You can search by the service point's **Address, City, or Postal** code, or the device's **Badge Number**.
 - c. Click **Search**.
 - d. Select the appropriate meter. Information about the selected meter (including its service point, device, and device configuration) will appear in the **Meter 1** box.
 - e. To create a field activity to investigate the status of this meter (for instance, to confirm which meter is installed at the service point), click **Investigate** under the **Meter 1** section. This will create a field activity with a Field Task Type of that defined on the Cross Installed Meter Request Type. Note that you cannot proceed with the process flow until field activities created in this way have been completed.
3. Use the **Cross Installed Meter Identification** section to search for and select the second meter (Meter 2).
 - a. Select **Meter 2**.
 - b. Enter the search criteria for the meter. You can search by the service point's **Address, City, or Postal** code, or the device's **Badge Number**.

- c. Click **Search**.
- d. Select the appropriate meter. Information about the selected meter (including its service point, device, and device configuration) will appear in the **Meter 2** box.
- e. To create a field activity to investigate the status of this meter (for instance, to confirm which meter is installed at the service point), click **Investigate** under the **Meter 2** section. This will create a field activity with a Field Task Type of that defined on the Cross Installed Meter Request Type. Note that you cannot proceed with the process flow until field activities created in this way have been completed.

Note: After selecting the second meter, the **Insights** box will display information about the meters based on the "Cross Installed Meters - Inline" (X1-CROSSEDMETER-INLINE) Insight Type.

4. Click **Save** to save your selection before making any changes. You can return to this process at a later time using the **Process Flow Query** portal.
5. Click **Swap Meters** to initiate the process of canceling/deleting the current incorrect install events, and creating new correct install events for each meter.

Note: The **Swap Meters** button is disabled until all field activities created from the process flow are in the Completed state.

This process also retrieves any impacted Accounts, Service Agreements, and frozen Bill Segments associated to the each meter's service point and device, and creates an Off Cycle Bill Generator for each service agreement based on the **Swap Meters Service Script** defined on the Cross Installed Meter Request Type.

If the **Create Customer Contact** drop-down list on the Cross Installed Meter Request Type is "Yes", this process also creates customer contacts based on the **Contact Class** and **Contact Type** defined on the Cross Installed Meter Request Type.

When the process completes the **Insights** box will display a "Swap Meters successfully performed." message, the **Swap Meters** button will be disabled, and the **Next** button will be enabled.

If an error occurs, error information will be displayed above the **Swap Meters** button.

6. Click **Next** to move to the **Correct Bill Segments** panel. Click **Previous** to return to the **Swap Meters** panel.

The **Correct Bill Segments** panel displays a summary of impacted bill segments for each Off Cycle Bill Generator that can be corrected. To the right of each summary is a **View Bill Segments** link, and below each is a **Skip** button.

7. *Optional.* Click **View Bill Segments** to view additional details about the Off Cycle Bill Generator. This displays a table that includes the calculated **Original Amount**, **Rebill Amount**, and **Net Difference** for each bill segment (and transitions the Off Cycle Bill Generator to the "In Review" state). Note: This process can take a few minutes to process, depending on the number of bill segments.

If the **Allow Adjustment** drop-down list on the Cross Installed Meter Request Type is set to "Yes", the panel displays a **Create Adjustment** button.

If the **Allow Rebill** drop-down list on the Cross Installed Meter Request Type is set to "Yes", the panel displays a **Rebill** button.

8. Adjust, rebill, or skip each Off Cycle Bill Generator as appropriate:

- Click **Create Adjustment** to create an adjustment for the total Net Difference, and transition the Off Cycle Bill Generator to the "Adjustment Created" state. Adjustments created in this way are based on the Adjustment Type defined on the Cross Installed Meter Request Type.
- Click **Rebill** to rebill the impacted bills and bill segments and transitions the Off Cycle Bill Generator to the "Rebilled" state.
- Click **Skip** to do nothing and transition the Off Cycle Bill Generator to the "Canceled" state.

When all bill segments for both service points have been either rebilled, adjusted, or skipped (and the Off Cycle Bill Generators have been transitioned to either "Rebilled", "Adjustment Created", or "Canceled"), the **Next** button will be enabled.

9. Click **Next** to move to the **Summary** panel. Click **Previous** to return to the **Correct Bill Segments** panel

The **Summary** panel opens, displaying **Corrected Meter Installation** , **Corrected Bill Segment Information**, and **Customer Contacts** sections.

The **Corrected Meter Installation** section displays the updated meter and service point information for each meter and service point, including new install events.

The **Corrected Bill Segment Information** displays lists of corrected bill segments for each meter and service point.

The **Customer Contacts** section displays the customer contacts created for each meter and service point.

10. Click **Finish** to mark the process flow as “Closed”.

Opening a Cross Installed Meter Process

Use the following procedure to search for and open a previously-created cross installed meter process:

1. Select **Menu, Process Flow**. The **Process Flow Query** portal opens.
2. Select "Cross Installed Meter" from the **Process Flow Type** drop-down list.
3. To search by user, enter a user ID in the **User** field.
4. To search by date range, enter the appropriate start and end dates in the **Update Date/Time Range** fields.
5. To include Completed process flows in your search, check the **Include Completed** checkbox.
6. Click **Search**.

The **Process Flow Query** portal displays a list of process flows that match your search criteria.

The **Resume** column displays a **Resume** button for process flows currently in process. The **Process Flow** column displays an ID link for completed/closed process flows.

7. To open an in-process process flow, click **Resume** for the process you wish to view and/or work with. The selected process flow opens on the **Swap Meters** panel in the **Process Flow** portal.
8. To open a closed process flow, click in the ID link in the **Process Flow**. The selected process flow opens on the **Summary** panel in the **Process Flow** portal.

Initiating Cross Installed Meter Process Flows from Field Activities

There can be situations in which a field crew discovers that a meter is installed at an incorrect customer service point. For instance a crew might be taking a manual meter reading or performing some other field activity when they realize that the error. Field crews can initiate a Cross Installed Meter process flow by providing the correct meter information (the meter's badge number) as part of the completion information sent back to the field activity (via an Inbound Communication).

To create a Cross Installed Meter process flow in this way, the inbound communication must include a "CROSSEDMETER" Field Activity Remark Type (from the Field Activity Remark Type extendable lookup) in the Completion Details/Completion Information/Remark Types section, and the Badge Number of the meter physically installed at the service point in the Response Details/Message Details/Utility Completion Information/Cross Installed Meter section. When the inbound communication is received by the field activity and the field activity is completed, it creates a completion event based on the Create Meter Process Completion Event (X1-CreateCrossedMeterProcess) business object which instantiates a Cross Installed Meter process flow and an associated To Do entry. The Process Flow type and To Do type to create are derived from the Cross Installed Meter action method (See [Configuring Cross Installed Meter Processing](#) in the *Administrative User Guide* for information about configuring the Cross Installed Meter Action Method).

Inbound communications of this type can be created using the Field Activity Inbound Communication (D1-FieldActivityIBComm) Inbound Web Service or manually using the **Communication** portal.

When the new Cross Installed Meter process flow is created, the Service Point ID and Meter ID defined in the field activity are used to populate the "Meter 1" information. Note that the Investigate option is disabled for Meter 1 for process flows created this way. The actual meter badge number in the physical world and the service point where it's installed in the application are used to populate the "Meter 2" information.

See [About Service Order Field Activities](#) for more information about field activities. See [About Communication In](#) for more information about inbound communications. See [Understanding Inbound Web Services](#) in the *Administrative User Guide* for more information about using and invoking inbound web services.

Route Management

About Route Management

Route management involves managing the order of the Service Points within measurement cycles and routes.

When creating Service Points, each Service Point can reference a measurement cycle, route, and its sequence within the route. Over time, as Service Points are added and removed to and from measurement cycles and routes, it may become necessary to change the sequence of Service Points within the measurement cycles and routes used in your implementation.

- A **measurement cycle** defines WHEN the Service Point is visited
- A **route** within a cycle defines a group of Service Points in a cycle that are visited by a meter reader
- A **sequence** within a route defines the physical position of the Service Point within a route
- A **schedule** specifies the dates on which Service Points are visited.

Manually read Service Point reference a measurement cycle, route and sequence within the route. A batch process creates SP/Measurement Cycle Schedule Routes for each Service Point, which link the dates on a measurement cycle schedule to a measurement cycle route defined for the Service Point. These define the specific date on which a meter reader will visit Service Points associated with a specific measurement cycle route, and the sequence in which the Service Points on that route are visited.

Measurement Cycles

Measurement cycles define the schedule for manual meter reading of devices at Service Points in that cycle. Measurement cycles can have one or more associated routes used to collect measurements.

Measurement cycles can also be configured to define when to [create usage transactions](#) for Usage Subscriptions associated to Service Points in the cycle.

Measurement Cycle Schedules

Measurement cycle schedules define the dates on which devices are scheduled to be read for a given measurement cycle and the routes used to collect measurements for the measurement cycle.

Working with Route Management

This Route Management portal is used to change the sequence of Service Points within a measurement cycle and route and to transfer Service Points from one measurement cycle and route to another.

Refer to [About Route Management](#) for additional functional information.

You can access the portal from the **Main > Device Installation > Route Management**. You are brought to a query portal with options for searching. Once you enter your search criteria, a list of related Service Points is presented.

The following actions are available once a Measurement Cycle and Route are selected:

- **Renumber Sequence:** renumbers the sequence of selected Service Points for the route. Use the Renumber Sequence page to renumber the sequence of Service Points in a measurement cycle route.

- **Transfer Measurement Cycle Route:** Use this button to transfer the selected Service Points to another route. Use the Transfer Measurement Cycle Route page to transfer the selected Service Points to another measurement cycle route. You can also renumber the sequence of Service Points in their new route as part of the transfer.

Facilities

About Facilities

Facilities represent the network node level closest to the Service Point. In terms of electric networks, facilities typically represent transformers.

While "Facility" is the generic name for this object, many of the Business Objects created within Oracle Utilities Meter Data Management have a more specific name. One good example is the Transformer (D1-Transformer) Business Object.

Maintaining Facilities

This portal is used to display and maintain a Facility.

Refer to [About Facilities](#) for additional functional information.

You can access the portal from **Menu > Device Installation > Facility**. You are brought to a query portal with options for searching. Once your record has been selected you are brought to the maintenance portal to view and maintain the selected record.

The following zones may appear as part of the portal's **Main** tab page:

- **Facility:** defines the basic attributes of the facility
- **Network Locations Related to Facility:** displays a list of network locations associated with the current facility in reverse chronological order.
- **Service Points Related to Facility:** displays a list of Service Points related to the current facility, in reverse chronological order.

Network Locations

About Network Locations

Network locations define the location of a facility within a larger network.

Network locations hold the network nodes that provide service to a facility. In the case of electric networks, network locations define the feeder and substation associated with a transformer (facility). Because these network nodes can change over time, a facility can have many network locations (this is an effective-dated relationship). For example, for electric Service Points, whenever the substation or feeder that provides power to a given transformer is changed, a new record that references the latest substation and feeder should be created.

Maintaining Network Locations

This portal is used to display and maintain a Network Location.

Refer to [About Network Locations](#) for additional functional information.

You can access the portal from **Menu > Device Installation > Network Location**. You are brought to a query portal with options for searching. Once your record has been selected you are brought to the maintenance portal to view and maintain the selected record.

The following zones may appear as part of the portal's **Main** tab page:

- **Network Location:** defines the basic attributes of the network location
- **Service Points Related to Network Location:** displays a list of Service Points related to the current network location, in reverse chronological order.

Measurements

Initial Measurement Data

About Initial Measurement Data

Initial measurement data (IMD) is the term for measurement data in its initial (or raw) form.

Measurements read from a measuring component are referred to as "initial measurement data" (or initial measurements) and are used to record how much of the quantity (defined by UOM, TOU, and SQI) measured by the measuring component was consumed.

Initial measurement data for scalar measuring components contain a single "reading" or value, while initial measurement data for interval measuring components can contain multiple readings, one for each interval that falls between the start time and stop time of the measurement.

At a simple level, initial measurement data goes through the following process:

1. Initial measurements are loaded into the system.
2. Initial measurement data is validated, edited, and estimated (VEE). Please refer to [About VEE](#) for more details on the VEE process.
3. Initial measurements are converted into final measurements.
4. If using Oracle Utilities Meter Data Management, final measurements are used to calculate usage (bill determinants, etc.). Please refer to [About Usage Calculation](#) for more details on the usage calculation process.

Only initial measurements can be edited directly by end users.

Initial measurement data contains both the original and final versions of the quantities recorded by the measuring component.

- Pre VEE quantities are consumption values derived from the measurements recorded by the head end system or meter reader with the appropriate installation and measuring component multipliers applied.
- Post VEE quantities are the "final" values, after VEE processing.

Pre VEE and Post VEE quantities in an initial measurement often differ based on a number of conditions, including:

- VEE rules have changed the quantities because they are missing or obviously wrong. In this, the Pre VEE values are adjusted based on the specifics of the VEE rules applied to the initial measurement to create the Post VEE values
- Manual changes by a user.

In addition to recorded consumption values, measurements also have condition codes, used to indicate the source and quality of a measurement. For example:

- Regularly recorded measurements might have a condition code of "Regular"
- Missing measurements might have a condition code of "Missing"
- Estimated measurements might have a condition code of "External Estimated" or "System Estimated" based on where the estimation was performed.

Both Pre VEE and Post VEE values have their own condition code, which can also change during VEE processing. For example, a measurement that was missing in the Pre VEE document will likely become "System Estimated" in the Post VEE document once VEE has been executed.

Processing Initial Measurement Data

Initial measurement data (IMD) received from external systems is processed through two major stages:

- **IMD Seeder:** This is the common interface point that receives all IMD information and performs critical validations and conversions. During this process the IMD Seeder identifies the appropriate specific IMD business object for further processing. The choice is made based on the category of IMD being processed (typically initial load) and the type of measuring component the IMD is for. For example, an IMD for an interval measuring component would result in the Initial Load IMD (Interval) business object being selected. If for some reason the IMD Seeder encounters an error an instance of the IMD Seeder will be created to manage the resolution of that error.
- **Specific IMD:** Each specific IMD has the appropriate calculation and validation logic for the type of data that has been received. An IMD containing scalar data will be processed differently than interval data or subtractive interval data. However, all types of data will have a similar set of steps taken:
 - Any external system specific statuses for the measurement data are interpreted into the appropriate internal statuses
 - An initial consumption calculation is performed
 - VEE rules are executed
 - Final measurements are created

IMD Seeder Processing

The IMD Seeder receives IMD data in a common structure, however, the content of the data (identifiers, date/times, etc) can vary depending on the system and the particular device that generated it. To accurately translate the external content to values understood by the system the IMD Seeder leverages the configuration of the service provider (aka head end or external system) and the device.

The service provider specifies the following inputs into IMD Seeder processing:

- **Identifier Types:** Each IMD must identify the device and measuring component the data has been generated from. The system supports a multitude of identifiers for both the device and measuring component. The service provider configuration specifies which identifier types are used for both the device and the measuring component which enables the IMD seeder to search for the correct destination for the measurement data. For example, a service provider might indicate that devices are identified by a serial number and measuring components are identified by a channel identifier.
- **Date/Time Format:** The service provider configuration will identify whether the date/times that were sent included specific time zone designations. This allows the system to accurately handle any time zone conversions that may be necessary.
- **Processing Methods:** A service provider has many processing methods that are used in the evaluation of the IMD.
 - Initial Measurement Creation - Maps a given measuring component type to the initial measurement BO that should be created
 - UOM Translation - Identifies the extendable lookup that should be used to map the service provider specific UOM to the internal UOM
 - TOU Translation - Identifies the extendable lookup that should be used to map the service provider specific TOU to the internal TOU

- **SQI Translation** - Identifies the extendable lookup that should be used to map the service provider specific SQI to the internal SQI
- **Time Zone Translation** - Identifies the extendable lookup to be used in mapping the service provider specific time zone to the interval time zone.

The device specifies the following inputs into IMD Seeder processing:

- **Incoming Data Shift:** This value is either specified directly on the device or can be defaulted via fallback on the device type. It identifies whether the incoming date/time information has is "Shifted" meaning it has been adjusted for Daylight Savings Time (DST) when in effect, or it is "Not Shifted" which means it will never be adjusted for DST. This plays an important role in the date/time processing since all incoming IMD date/times will be stored without an adjustment for DST.

With these inputs the IMD Seeder is able to translate the external identifiers into the appropriate identifiers to tie the IMD data to a specific measuring component in the system.

Once a measuring component is identified it is then used to select the appropriate IMD business object using the "Initial Measurement Creation" processing method of the service provider.

IMD Seeder Critical Validations

For Initial Measurement Data (IMD) to continue on to specific IMD processing it must pass several critical validations:

- The measuring component must be identified.
- The IMD must contain the appropriate date/times for the type of IMD being processed: scalar must have an end date/time and interval must have both a start and end date/time.
- The interval list must match the number of intervals expected based on the IMD start and end date/times. Note: if there are too few intervals the missing intervals can be automatically added to the IMD without generating an error. How this is done depends on whether there are date/times for each individual interval. If there are date/times for each interval the missing intervals are placed where the gaps exist. Otherwise when there are no date/times for the individual intervals the missing intervals are added to the end of the interval list.

If any of the critical validations have failed the IMD processing will be halted and an instance of the IMD Seeder will be created

Note: There is special logic that exists for handling the situation where either the IMD start date/time or the IMD end date/time falls on the duplicate hour that occurs when a time zone transitions out of daylight savings time. Typically there are two 1AMs on that day, one is considered to be during DST and the other is not. To ensure that the appropriate hour is selected the IMD Seeder uses the count of intervals and final measurements that exist prior to the IMD to identify the appropriate hour.

NOTE: Additional detail on the logic to derive the service provider, device, and measuring component identification can be found on the D1-DER-SPRMC Algorithm Type.

IMD Seeder Time Zone Translation and Conversion

To provide the most accurate tracking of measurement data all initial measurement data is stored in a single time zone without an adjustment for Daylight Savings Time (DST). As utilities can have multiple head end systems that each send date/time information in different ways and some utilities operate in multiple time zones the IMD Seeder contains functionality to convert incoming date/times from a source time zone into the time zone of Oracle Utilities Meter Data Management (as indicated by the base time zone)

There are three components to identifying the source time zone of the incoming IMD:

- **Service Provider IMD Import Date/Time Format:** When the IMD date/times are sent in format that identifies the time zone for each date/time the date/times will be delivered to the IMD Seeder already converted.

- **Incoming Data Shift:** This indicates whether the date/times will be adjusted for DST while it is in effect. A value of "Always in Local Time" indicates that the date/times are adjusted for DST. A value of "Always in Standard Time" indicates that the date/times are not adjusted for DST
- **Time Zone:** The time zone of the incoming data is identified using the follow order of precedence:
 1. The time zone as indicated by the IMD data
 2. The service point time zone
 3. The device configuration time zone
 4. The measuring component time zone
 5. The base time zone

Once the time zone and the data shift of the incoming date/times is identified all date/times will be converted from that time zone and shift into the base time zone in standard time.

NOTE: Additional detail on the logic for date/time adjustments and validation of undercount and overcount can be found on the D1-DODTTMADJ Algorithm Type.

Specific Initial Measurement Data Processing

There are several categories of initial measurement data:

Initial Load

When initial measurement data is received from external systems (e.g. Head End systems) it is processed using the initial load IMD type. These IMDs are configured to execute the VEE rules that as associated to the Initial Load VEE role on the measuring component (or measuring component type in the case of a fallback). For adapter specific variations of the Initial Load IMD there is logic to map external measurement statuses to measurement conditions.

Estimation

For various reasons a meter will not report measurement data for a certain period of time. When the system detects that a measuring component is missing final measurements, it can create an initial measurement to execute estimation rules. This type of initial measurement is referred to as an estimated initial measurement.

At a high-level, the estimation process is as follows:

- Missing final measurements are detected by the Periodic Estimation process
- Estimated initial measurements are created for the "missing" time period by the Period Estimation process
- Values and consumption for the estimated initial measurements are calculated by "estimation" VEE rules.

It's important to note that the processes that detect missing measurements do NOT themselves estimate consumption. Rather, these detection processes simply create an initial measurement and let the estimation VEE rules estimate the consumption for the initial measurement.

Estimation IMDs execute the VEE rules associated to the Estimation VEE role on the measuring component (or measuring component type in the case of a fallback).

NOTE: Refer to [Periodic Estimation](#) for additional functional information about how the periodic estimation can fill in missing reads for both interval and scalar measuring components.

Manual Override

Manual override IMDs are used when the creation of an IMD is user initiated as can be done from the various functions available on some of the 360 Degree zones (e.g., Final Values Overlay, Interval - Initial Measurement Overlay, etc.). Unlike other types of IMD manual override allow the user to edit the initial measurement data prior to performing VEE. These IMDs are used for more advanced tasks where a user must specify, either directly or through a measurement function, the values for the initial measurements.

These IMDs are systematically created during the reconciliation process that occurs when IMDs are finalized for measuring components with subtractive consumption calculations. They are used to recalculate the consumption on a measurement subsequent to an IMD when the start reading for that subsequent measurement has been changed.

Manual override IMDs execute the VEE rules associated to the Manual Override VEE role on the measuring component (or measuring component type in the case of a fallback).

System

A system is generated by internal system processes that need to recalculate measurement multipliers. They do not perform VEE but they can be configured to do so.

NOTE: Refer to [About Measurement Reprocessing](#) for additional functional information about how the system IMDs are created.

Data Conversion

This type of IMD has only the processing necessary to propagate converted measurement data into the system. The data provided to these IMDs is expected to be the quality of final measurements. Therefore no VEE rules will be executed.

Scalar Initial Measurement Data Processing

Initial measurement data for subtractive scalar measuring components contain start and stop readings in addition to Pre and Post VEE usage. For example, a set of initial measurements for a subtractive scalar measuring component might look like the following:

Date/Time	Start Reading	Stop Reading	Pre VEE Usage	Pre VEE Condition	Post VEE Usage	Post VEE Condition
01/01/2010 12:00AM	0	1500	1500	Regular	1500	Regular
02/02/2010 4:11PM	1500	2100	0	Missing	600	System Estimate
03/03/2010 5:22 PM	2100	2900	800	Regular	800	Regular
04/01/2010 01:00PM	2900	3500	0	Missing	600	System Estimate

Subtractive measuring components can "rollover" when the reading exceeds the maximum value based on the number of dials on the measuring component . For example, a register with a 4 dials can record values up to 9999 before rolling over to 0000. When this occurs, consumption is calculated based on the following attributes and calculated values.

- **Rollover Threshold** is the percentage of the measuring component's dial capacity at which measurements for measuring components of this type are considered to have rolled over. Dial capacity is the largest value that can be recorded for the measuring component, based on the measuring component's number of dials. For example, a measuring component with 5 dials has a dial capacity of 99999.
- **Number of Dials** is the number of dials used to record values on the register, and is equal to the **Number of Digits Left** field configured on the measuring component.
- **Max Dial Capacity** is the maximum value for the number of dials, rounded up to the next whole multiple of 10 (or 10 raised to the power of the number of dials). For example, for a register with 4 dials, the max dial value is 10000.
- **Max Acceptable Difference** is the maximum acceptable consumption that can be recorded for the register. This is equal to the Max Dial Capacity multiplied by the rollover threshold. For example, the Max Acceptable Difference for a register with 4 dials and a rollover threshold of 90% would be 9000. If the consumption is greater than this value, the initial measurement is transitioned to the Error state.

- **Difference:** The difference between the Stop Reading and Start Reading, obtained by subtracting the Start Reading from the Stop Reading. If the Difference is less than zero (<0), then add the Max Dial Capacity to calculate Rollover.
- **Rollover:** The adjusted consumption for a reading on a register that has rolled over. Only applicable if the Difference (Stop Reading - Start Reading) is less than zero (<0).
- **Consumption:** The calculated consumption for the reading, equal to either the Difference or Rollover. If the Difference is greater than or equal to zero, consumption is equal to the Difference. If the Difference is less than zero (<0), and the Rollover is less than or equal to the Max Acceptable Difference, the consumption is equal to the Rollover.

Example: Consider an initial measurement with the following attributes:

- Number of Dials: 4
- Rollover Threshold: 90 (%)
- Start Reading: 8900
- Stop Reading: 0500

For this reading,

- Max Dial Capacity = 10000
- Max Acceptable Difference = 9000 (10000 * 90)
- Difference = 0500 (Stop Reading) - 8900 (Start Reading) or **-8400**
- Rollover = 10000 (Max Dial Capacity) + -8400 (Difference) or **1600**
- Consumption is equal to **1600** (Rollover).

Each scalar IMD that is processed will perform a rollover validation based on the start reading. For those scalar IMDs that have measurements subsequent to the date being processed there will be an additional rollover validation forwards to ensure that the current IMD does not invalidate a future reading.

If the rollover validation fails when validating either backwards, forwards, or both then the system will attempt to automatically correct the situation by evaluating whether the measurements prior to or subsequent to the IMD can be removed. This analysis is done based on the condition of the measurement and the condition of the IMD. For example. If there is a rollover based on the start measurement and the start measurement is a system estimate but the IMD is regular then the start reading will be bypassed and the system will search backwards until:

- It identifies a measurement with a reading that does not cause a rollover when used as the start reading for the IMD
- It encounters a measurement that causes a rollover but is also regular and therefore cannot be bypassed. At this point the IMD would be placed in an error status.

When a rollover error is identified that cannot be automatically corrected there are a few options available for fixing the situation:

- The "Override Condition" functionality can be used. This is an action button available on the IMD from within the Error status. It allows the user to provide a higher quality condition for the IMD to force the rollover process to bypass the measurement (either prior to or subsequent to the IMD) that was the source of the rollover threshold error. For example, if the start read was a regular measurement and the IMD was also a regular measurement the user could update the IMD to have a condition of "Super" which would allow the regular start reading to be bypassed.
- A Manual Override IMD could be created to adjust the measurements surrounding the IMD to ensure that the rollover error is no longer encountered.

NOTE: When a measurement is bypassed by the rollover automatic correction logic it will be set to Do Not Use when the IMD is finalized.

A scalar IMD can generate a manual override IMD during the finalization process when the need for reconciliation is identified. This happens whenever an IMD is received that occurs prior to an already existing scalar measurement. Since the newly processed IMD will introduce a new start reading for the existing subsequent measurement it is necessary to use

the manual override IMD to recalculate the consumption. For example, imagine a scalar measuring component had the following readings:

Date/Time	Start Reading	Stop Reading	Pre VEE Usage	Pre VEE Condition	Post VEE Usage	Post VEE Condition
01/01/2010 12:00AM	0	1500	1500	Regular	1500	Regular
02/02/2010 4:11PM	1500	2100	0	Regular	600	Regular
04/01/2010 01:00PM	2100	3500	1400	Regular	1400	Regular

When the February reading is finally received it will spawn a reconciliation Manual Override IMD to correct the consumption of the April reading given the new start reading:

Date/Time	Start Reading	Stop Reading	Pre VEE Usage	Pre VEE Condition	Post VEE Usage	Post VEE Condition
01/01/2010 12:00AM	0	1500	1500	Regular	1500	Regular
02/02/2010 4:11PM	1500	2100	600	Regular	600	Regular
03/03/2010 5:22 PM	2100	2900	800	Regular	800	Regular
04/01/2010 01:00PM	2900	3500	600	Regular	600	Regular

NOTE: These reconciliation IMDs are generated during the finalization of the initiating IMD and must finalize themselves. If for some reason the reconciliation IMD does not complete it will prevent the initiating IMD from finalizing as well. Typically the reason for this issue will be a VEE exception that is being raised against the reconciliation IMD. The reason this rule is enforced is to ensure that the quantity of a measurement always aligns to the reading of that same measurement. If this situation arises the data source of the IMD can be used as an input to the VEE rule eligibility to skip certain rules when the IMD is a reconciliation IMD since the reconciliation process add a data source of "Generated by Reconciliation" to each reconciliation IMD.

Interval Initial Measurement Data Processing

Given the consumption calculation for interval channels is done using the consumptive method the Interval IMD variants do not contain much special processing outside of the general pattern described in [Processing Initial Measurement Data](#).

Subtractive Interval Initial Measurement Data Processing

Initial measurement data for subtractive interval measuring components readings and usage for each interval in addition to Pre and Post VEE usage. Furthermore, there is a condition for both the reading and the usage which allows for more accurate recalculation of intervals. The start reading for each interval is considered to be the reading from the prior interval. For the first interval the start reading will be identified from the measurement data for the measurement immediately prior to the IMD. For example, an initial measurement for a subtractive interval measuring component might look like the following when we assume a start reading of 1490:

Date/Time	Pre VEE Reading / Condition	Pre VEE Usage / Condition	Post VEE Reading / Condition	Post VEE Usage / Condition
01/01/2010 01:00AM	1500 / Regular	10 / Regular	1500 / Regular	10 / Regular

01/01/2010 2:00AM	0 / Missing	0 / Missing	1520 / System Estimate	20 / System Estimate
01/01/2010 3:00AM	1525 / Regular	5 / System Estimate	1525 / Regular	5 / System Estimate
01/01/2010 4:00AM	1540 / Regular	15 / Regular	1540 / Regular	15 / Regular

Subtractive interval IMDs can validate for rollovers based on the configuration of the measuring component. See [Scalar Initial Measurement Data Processing](#) for more details on how rollovers are calculated.

How subtractive interval IMDs identify rollover errors is identical to scalar IMDs. However, the resolution of those errors is much different. With scalar any bypassed measurements are handled at the point of finalizing the IMD and the measurements are set to Do Not Use. With subtractive interval any bypassed measurements are added to the IMDs interval list so that they are processed along with the IMD that identified them as causing a rollover.

Subtractive interval IMDs also must initiate the reconciliation of an interval that comes directly after the IMD being processed. Unlike scalar this is not handled through a separate IMD. Rather the next measurement after the IMD being processed is added to the current IMD and the reconciliation of the usage for that measurement is computed as part of the IMD. This allows for any validation errors that are encountered in the recalculation of that measurement to be resolved along with the IMD.

NOTE: There is one scenario that does result in a reconciliation IMD being generated. When the last interval of an IMD has the reading changed during the VEE process it will require that a reconciliation IMD be generated to adjust the usage of the next measurement after the IMD (if applicable).

The subtractive interval IMDs are responsible for ensuring that the reading for each interval is in line with the usage calculated. This maintenance is performed each time the IMD is run through the VEE rules. After which the IMD will examine each interval and identify which intervals require an update to the reading or quantity.

Initial Measurement Data Valid Date Boundaries

Meter Data Management can be configured to define an acceptable date range for initial measurement processing, providing a mechanism to restrict either future measurements or very old measurements from being processed by Meter Data Management.

Defining this date range is done via the following parameters in the **Device Measurement Parameters** section of the MDM Master Configuration:

- **Prevent Future Measurement Records:** Indicates if the system should prevent processing for measurements deemed to be "future" measurements, based on the **Number of Days Before Considered Future** parameter. If a measurement is deemed to be a "future" measurement and this is set to "Yes", the initial measurement is moved to the "Error" state.
- **Number of Days Before Considered Future:** The number of days in the future (based on the IMD From Date Time) before a measurement is considered to be a "future" measurement. If the **IMD From Date Time** for a measurement is more days in the future than this setting, the measurement is considered "future".
- **Prevent Old Measurement Records:** Indicates if the system should prevent processing for measurements deemed to be "old" measurements, based on the **Number of Days Before Considered Old** parameter. If a measurement is deemed to be an "old" measurement and this is set to "Yes", the initial measurement is moved to the "Error" state.
- **Number of Days Before Considered Old:** The number of days in the past (based on the IMD From Date Time) before a measurement is considered to be an "old" measurement. If the **IMD From Date Time** for a measurement is more days in the past than this setting, the measurement is considered "old".

Deferring Initial Measurement Data Processing

Meter Data Management can be configured to defer processing for initial measurements that are in the past, but that are not yet deemed to be "old" (based on the **Number of Days Before Considered Old** parameter on the MDM Master Configuration). This ensure that a meter that "wakes" up and sends a large payload of data, including old measurements, will not adversely impact initial measurement processing during critical processing windows.

Configuring the system for deferring initial measurement processing is done via the following parameters in the **Device Measurement Parameters** section of the MDM Master Configuration:

- **Defer Old Measurement Records:** Indicates if the system should defer processing of measurements whose **IMD From Date Time** falls between the **Number of Days Before Deferring** and the **Number of Days Before Considered Old** parameters. Note that when this parameter is set to "Yes", the **Number of Days Before Deferred** must be supplied.
- **Number of Days Before Deferred:** The number of days in the past (based on the **IMD From Date Time**) before a measurement should be deferred. Initial measurements with dates older than this setting but not as old as the **Number of Days Before Considered Old** will be deferred (the measurement is moved to the Defer state). If provided, this must be a positive number and must be less than **Number of Days Before Considered Old** setting.

Deferring initial measurement data processing requires that the Compare IMD Date/Times to Master Config Boundaries algorithm (D2-CMIMDDTMC) be defined as an Enter algorithm on the VEE Ready state for all initial measurement business objects for which deferring processing is to be enabled. See the **Detailed Description** of this algorithm for more information.

Initial Measurement Data Prioritization

By default, initial measurements are created and/or received into the system in an initial state of "Pending" and are transitioned to subsequent states via the "IMD Monitor - Physical Devices" Monitor process. This Monitor process can be skipped by setting the Execution Method flag on the initial measurement to "Real Time" (DIRT), in which case an Enter algorithm transitions the initial measurement to the next state in its lifecycle immediately. This feature can be used to prioritize processing of certain types of initial measurements.

The Execution Method flag can be set in initial measurements sent from the head end system, or can be inserted during Oracle Utilities Smart Grid Gateway Adapter processing.

Oracle Utilities Smart Grid Gateway Adapters set this flag to "Real Time" on all measurements created as the result of smart meter commands (Remote Connect, Remote Disconnect, or On-Demand Read) or completion events (including Field Activity Completion Events used with Service Order Management).

Maintaining Measuring Component Dates

There are several date/times systematically maintained on measuring components that aid in the efficient processing of initial measurement data as well as informing the periodic estimation process.

During initial measurement data finalization these dates are maintained by a series of algorithms based on the type of measuring component and type of initial measurement.

Important Measuring Component Dates

Each initial measurement is evaluated to determine if the following dates should be updated on the measuring component.

Last Contiguous Read Date/Time

This represents the last point where an uninterrupted series of measurements were received for the measuring component. Periodic estimation uses this field to generate estimates for any periods of missing measurements for the measuring component.

For interval measuring components this date will be updated whenever the current value falls between the initial measurement's From and To Date/Time fields (inclusive) in one of two ways:

1. If there are no measurements subsequent to the initial measurement being processed it will be set to the initial measurement To Date/Time
2. If there are measurements subsequent to the initial measurement and the initial measurement has filled a gap of missing measurements then it will be set to the Last Contiguous Measurement Date/Time that is subsequent to the initial measurement To Date/Time

For scalar measuring components there is an added check to ensure that the initial measurement's To Date/Time is exactly one expected measurement after the current last contiguous read date/time

Adjusted Latest Measurement Date/Time

For scalar meters this date is derived by assigning the last contiguous read date/time to an expected measurement date/time based on the measuring component type configuration for Expected Hours Between Measurements, First Daily Measurement Time, Early Threshold and Late Threshold.

For example, if a measurement is expected every 6 hours and the adjusted last contiguous read date/time on the measuring component is January 1st at 12:00:00AM, then the initial measurement's To Date/Time must align to the expected measurement date/time of January 1st at 06:00:00AM so the latest measurement date/time can be updated.

The expected measurement date/times are calculated using the expected hours between measurements and the first daily measurement time elements from the measuring component type. For example, if the expected hours between measurements was 6 hours and the first daily measurement date/time was 12:00:00AM, then the expected measurement date/times for each day would be:

- 12:00:00AM
- 06:00:00AM
- 12:00:00PM
- 06:00:00PM

To account for scalar reads that are not received for an exact date/time, the Early Threshold and Late Threshold elements of the measuring component type are used to align a given measurement to one of the expected measurement date/times.

Most Recent Read Date/Time

This represents the maximum measurement date/time that exists for the measuring component. This field is leveraged throughout the system to identify when certain logic must be executed. For example, if there are no measurements in the future to what is being processed then no logic dealing with future measurements need be executed.

It will be updated to the initial measurement's To Date/Time whenever the initial measurement's To Date/Time is greater than the current most recent read date/time.

Most Recent Non Estimated Read Date/Time

Represents the latest measurement processed that was not estimated. This is leveraged by the outage storm mode module.

It will be updated to the latest non-estimated measurement date/time in the initial measurement that is more recent than the current most recent non-estimated read date/time.

Identifying Data for Historical Extracts

Another important role for each of the algorithms that maintains measuring component dates is to identify whether the data being processed needs to be re-extracted for one of the existing measurement extract methods:

1. Specialized Measurement Extract
2. Specialized IMD Header Extract
3. DataConnect
4. Configurable Consumption Extract

If the data should be re-extracted a record will be created in the general processing table to be extracted at a later point.

It is important to note that by default these checks are turned off for performance reasons. If you would like to capture historical changes for any of these extracts it will need to be turned on for each individual algorithm.

Date Maintenance Algorithms

The following algorithms are used to maintain measuring component dates.

D1-UPD-DTMC - Update Latest Measurement Date/Time on MC with Consumption Sync

This algorithm applies to initial load and manual initial measurements for interval measuring components.

This algorithm maintains important summary level dates on the Measuring Component (MC) as well as initiating the Consumption Synchronization process.

The following dates are maintained:

- Last Contiguous Read Date/Time
- Most Recent Read Date/Time
- Most Recent Non Estimated Read Date/Time

NOTE: If the first time Periodic Estimation will be executed after initial conversion the Latest Read Date/Time has not been initialized for any measuring components the "No of Hours in Past to Retrieve Last Useable Measurement" option of the Feature Configuration Type "Measurement Data Option" should be configured. This enables logic that will defer the initialization of the Last Read Date/time to the Periodic Estimation process for any measuring component where it is not currently populated but does have existing final measurements. Please refer to [About Periodic Estimation](#) for more information.

If the initial measurement's device configuration is configured for related measuring component consumption synchronization this algorithm can optionally identify whether there are any consumption synchronization eligible measurements on the related measuring component (eligible measurements are defined as those whose condition falls between the bottom and top ranges for consumption sync or the additional condition code for consumption sync). When the initiating initial measurement is not "back dated" or the synchronization period does not extend past the initial measurement's date range the appropriate interval or scalar consumption sync activity will be selected based on the measuring component type of the related measuring component. When the initiating initial measurement is "back dated" and there is a contiguous period of synchronization eligible measurements that extends past the date range of the initial measurement the Gap Consumption Sync Activity will be created.

Lastly this algorithm can be configured to maintain outage related activities for the device. Since the receipt of initial load data for a device indicates it is now powered on and communicating if there are any outstanding outage or estimation suppression activities (initiated via widespread outage) they can be ended as of the from date/time of the initial measurement.

D1-UPD-DTMCF - Update Latest Date/Time on MC from a Future Measurement

This algorithm applies to estimation initial measurements for interval measuring components.

This algorithm maintains important summary level dates on the Measuring Component (MC) as well as initiating the Consumption Synchronization process.

The following dates are maintained:

- Last Contiguous Read Date/Time
- Most Recent Read Date/Time
- Most Recent Non Estimated Read Date/Time

As this algorithm is used on estimation initial measurement data it is not common that it will update the most recent non-estimated read date/time. However, there are circumstances where high quality estimations based on a check channel might be given a measurement quality in the regular range. In our documentation we sometimes refer to these as prorated measurements.

It is also important to note that this algorithm will not initiate consumption sync processing.

D1-UDTSCMCRE - Update Latest Measurement Date/Time on Scalar MC with Consumption Sync

This algorithm applies to initial load and manual initial measurements for scalar measuring components.

This algorithm maintains important summary level dates on the Measuring Component (MC) as well as initiating the Consumption Synchronization process.

The following dates are maintained:

- Last Contiguous Read Date/Time
- Adjusted Last Contiguous Read Date/Time
- Most Recent Read Date/Time
- Most Recent Non Estimated Read Date/Time

NOTE: If the last contiguous read date/time is not currently set for the measuring component then the initial measurement is assumed to be the first initial measurement received for the measuring component the Last Contiguous Read Date/Time will be set to the initial measurement To Date/Time. Furthermore, even if the Last Contiguous Read Date/Time does not align to one of the expected measurement date/times, the Last Contiguous Read Date/Time and Adjusted Latest Contiguous Read Date/Time will be updated.

NOTE: If Auto-Read Scalar Periodic Estimation is being implemented for Auto-Read Scalar Devices that have existing measurement history, then the "No of Hours in Past to Retrieve Last Useable Measurement" option of the "Measurement Data Option" Feature Configuration Type should be configured. Logic will not initialize the latest measurement date/time information for any measuring component that does not have any latest measurement date/time information but does have existing final measurements. In these cases, the setting of the latest measurement date/time is deferred to the Auto-Read Scalar Periodic Estimation process. Please refer to [About Periodic Estimation](#) for more information.

If the initial measurement's device configuration is configured for related measuring component consumption synchronization this algorithm can optionally identify whether there are any consumption synchronization eligible measurements on the related measuring component (eligible measurements are defined as those whose condition falls between the bottom and top ranges for consumption synchronization or the additional condition code for consumption synchronization). When the initiating initial measurement is not "back dated" or the synchronization period does not extend past the initial measurement's date range the appropriate interval or scalar consumption synchronization activity will be selected based on the measuring component type of the related measuring component. When the initiating initial measurement is "back dated" and there is a contiguous period of synchronization eligible measurements that extends past the date range of the initial measurement the Gap Consumption Sync Activity will be created.

Lastly this algorithm can be configured to maintain outage related activities for the device. Since the receipt of initial load data for a device indicates it is now powered on and communicating if there are any outstanding outage or estimation suppression activities (initiated via widespread outage) they can be ended as of the from date/time of the initial measurement.

D1-UPDDTSCMC - Update Latest Date/Time on Scalar Measuring Component

This algorithm applies to estimation initial measurements for scalar measuring components.

This algorithm maintains important summary level dates on the Measuring Component (MC) as well as initiating the Consumption Synchronization process.

The following dates are maintained:

- Last Contiguous Read Date/Time
- Adjusted Last Contiguous Read Date/Time
- Most Recent Read Date/Time
- Most Recent Non Estimated Read Date/Time

NOTE: If the last contiguous read date/time is not currently set for the measuring component then the initial measurement is assumed to be the first initial measurement received for the measuring component the Last Contiguous Read Date/Time will be set to the initial measurement's To Date/Time. Furthermore, even if the Last Contiguous Read Date/Time does not align to one of the expected measurement date/times, the Last Contiguous Read Date/Time and adjusted Latest Contiguous Read Date/Time will be updated.

NOTE: If Auto-Read Scalar Periodic Estimation is being implemented for Auto-Read Scalar Devices that have existing measurement history, then the "No of Hours in Past to Retrieve Last Useable Measurement" option of the "Measurement Data Option" Feature Configuration Type should be configured. Logic will not initialize the latest measurement date/time information for any measuring component that does not have any latest measurement date/time information but does have existing final measurements. In these cases, the setting of the latest measurement date/time is deferred to the Auto-Read Scalar Periodic Estimation process. Please refer to [About Periodic Estimation](#) for more information.

As this algorithm is used on estimation initial measurement data it is not common that it will update the Most Recent Non Estimated Read Date/Time. However, there are circumstances where high quality estimations based on a check channel might be given a measurement quality in the regular range. We sometimes refer to these as prorated measurements.

It is also important to note that this algorithm will not initiate consumption synchronization processing.

CSV Upload

Measurement data for a measuring component can be uploaded via comma separated values (CSV) files. See [Uploading Measurement Data](#) for more information.

Importing Data From External Systems

In addition to importing data from head end systems for meters and other devices, the system can also import data from other types of external systems such as weather systems or from market participants such as an independent system operator (ISO) as part of a settlement market. Data received from these types of systems is stored in standalone measuring components (see [About Measuring Components](#) for more information).

When importing data for standalone measuring components, initial measurement processing uses the **Standalone Identifier** (or **Standalone ID**) to identify the measuring component for which the measurement data belongs.

Each external system from which data is imported should be defined as an [external application](#). If the data being imported uses units of measure or time of use periods that are specific to the external system, translation methods should be defined to map the specific data to standard codes.

Final Measurements

About Final Measurements

Final measurements are measurements that have been validated, and if necessary, edited & estimated, and is ready for use in downstream processing such as bill determinants calculations.

When an initial measurement is considered "final," that is, it has passed all VEE processing and no additional modifications or changes need to be made, it is transformed into a Final Measurement, or simply a Measurement (the terms measurement, final measurement, and final consumption all reference this same "final" measurement data). Only one final measurement can exist for a given date/time for a given measuring component; one final measurement exists per interval, and likewise

one final measurement exists for each scalar reading. In both cases, the final measurement value stored represents the amount consumed between its date/time and the prior final measurement's date/time.

When creating final measurements from initial measurement data:

- Final measurements are created using Post VEE quantities
- Each final measurement's condition is copied from the Post VEE condition
- Initial measurements are normalized into final measurements where each final measurement is for a specific date and time.
- Because a single initial measurement may contain many "readings," a separate final measurement is created for each interval in the initial measurement. For example, if an initial measurement contains 24 hours of 15 minute readings, 96 measurements will be created, each with a specific date and time.
- A Combined Multiplier (created from multipliers defined for the measurement's measuring component type and install event) is stored for each measurement. In addition, other values are stored for measurements of specific types. The Reading Value (which often differs from the measurement value) is stored for scalar and subtractive interval measurements, and the Reading Condition is stored for subtractive interval measurements. These values are used with measurement reprocessing and other recalculation processes in the event that the original initial measurements have been archived or deleted.

The measurement date/time of a measurement represents the end of the period the measurement value covers. How the start of the period is defined varies slightly based on the type of measuring component associated to the measurement:

- **Scalar Measuring Components:** the measurement date/time represents the point at which the reading was taken. The period the measurement covers is defined as the previous measurements date/time through the measurement date/time.
- **Interval Measuring Components:** the measurement date/time represents the end of the interval period. No date/time is stored to represent the beginning of the interval period, rather it is implied by the interval size of the measuring component. For example an interval measuring component with an hourly interval size and a measurement date/time of 01/01/2010 12:00AM represents the measured quantity for the period of 12/31/2009 11:00PM through 01/01/2010 12:00AM.
- For scalar measuring components there exist special circumstances where a final measurement is not eligible for use in processing (e.g. consumption calculation, usage calculation, etc.). To prevent other processes from using these measurements they are marked with a usage flag of "Do Not Use." This is typically the result of the automatic correction of a rollover threshold error when lower quality measurements inaccurate measurements are removed to enable successful calculation of subtractive consumption.

Conditions

Conditions are used to describe the quality of a final measurement and is an important input into many of our processes. During initial measurement data processing these conditions help VEE rules identify the initial measurements that require more advanced validation or estimation. During usage calculations measurement conditions help to inform the billing system whether the billing determinants produced are based on actual data read from a meter or if it has been estimated (or in many cases a combination of the two).

Conditions follow a numeric sequencing that begins at 000000 and goes up to 999999. As the condition code rises numerically so does its perceived quality. Many areas the system take this into account:

- VEE rules use conditions to identify which initial measurement values need to be estimated or adjusted
- Rollover error automatic corrections allow higher quality data to bypass lower quality data in order to achieve a consumption calculation that does not produce an error.
- Usage calculation rules can provide information about the quality of billing determinants based on the underlying measurement data that feeds into those service quantities.

Throughout the system functionality uses condition code ranges to make decisions. In general the ranges are considered to be:

Condition Range Start	Condition Range End	Description of Range
000000	199999	No measurement
200000	299999	Missing Measurement
300000	499999	Estimated measurement
500000	999999	Regular measurement

The ranges of "No Measurement" and "Missing Measurement" at first glance sound synonymous but there is an important distinction. With conditions that fall within the "No Measurement" range the expectation is that no measurement should exist. Whereas, the "Missing Measurement" range implies that a measurement was expected but never received.

Note: in some circumstances, like rollover threshold errors, the regular range is further divided to include a "Superior" range of 9000000 - 999999 which can be used to select the appropriate reading to be used to resolve the error.

During initial measurement processing the Final Measurement Replacement VEE rule can be used to increase the perceived quality of a condition code. For example, the "No Read - Outage" condition which falls in the "No Measurement" range can be considered higher quality than "Estimated Measurements" for the purposes of measurement replacement.

Refer to [About IMD Validations](#) for more information on the Final Measurement Replacement VEE rule.

Derived Values

Final measurements can record up to 10 derived values in addition to the "as measured" value. The derivation formula for each value on a final measurement is controlled by the measuring component type.

Derived values are not reliant on consumption values, but can also come from factors, historical data, or another source. For example, a set of measurements can be adjusted or converted into other units of measure. In the below example the first derived value is the result of the application of a loss adjustment factor and the second derived value is the result of applying a pre set formula against the loss adjusted value to compute BTU.

Date/Time	As Measured UOM: CCF SQI: N/A	Loss Adjusted UOM: CCF SQI: N/A	Thermal Units UOM: BTU SQI: N/A
01/01/2010 3:00PM	10	10.1	10.11
01/01/2010 4:00PM	15	15.15	15.165
01/01/2010 5:00PM	10	10.1	10.11

Refer to [Understanding Measuring Component Types](#) in the Administration Guide for additional information about configuring derivation algorithms.

Reader Remarks

Initial measurements for manually-read scalar meters can create reader remarks. Reader remarks are a specific type of device event used to capture and/or record specific events or circumstances encountered when a meter reader is manually reading scalar meters.

Reader remark types are submitted with scalar initial measurements when received from a head end system or meter read collection system. Reader remarks are NOT uploaded along with other device events. Reader remarks are always associated with a scalar initial measurement.

Reader remarks can be passed onto to other subscribing systems such as a customer information system (such as Oracle Utilities Customer Care and Billing), an outage system (such as Oracle Utilities Network Management System), or some other application.

Like other device events, reader remarks can create service issue monitors.

NOTE: Refer to [About Service Issue Monitors](#) for more information on Service Issue Monitors.

Creating Reader Remarks Manually

Use this procedure to create a new reader remark for an existing initial measurement.

Reader remarks must always be associated with an initial measurement.

Reader remarks are most often imported into the application with an initial measurement. However, users can also create reader remarks using the following procedure.

1. Search for and select the initial measurement that the new reader remark is to be associated with.
2. Click the **Add** link on the **Reader Remarks of Initial Measurement** zone on the **Initial Measurement** portal.
3. Select the reader remark type for the reader remark from the **Reader Remark Type** drop-down list.
4. *Optional.* If you need to create more than one reader remark for the initial measurement, click the plus sign, and select the reader remark type for the reader remark from the Reader Remark Type drop-down list. Repeat as needed.

Note that only a single reader remark of any given type can be associated with a single initial measurement.

5. Click **OK**. The new reader remark is displayed in the **Reader Remarks of Initial Measurement** zone on the **Initial Measurement** portal.

Periodic Estimation

About Periodic Estimation

Periodic estimation is a process that scans eligible devices and their measuring components for missing measurements that have not been received within a required amount of time. Once missing measurements are identified it then generates estimation initial measurements to fill in those missing measurements. It is important to note that the periodic estimation itself does not actually perform any estimations. It relies on the estimation initial measurement to generate the estimate through the estimation VEE rules that are executed.

The periodic estimation process is as follows:

1. Determine if measuring component is eligible for estimation.
2. Scan the eligible period for missing measurements.
3. Confirm missing measurements do not fall within a period where the device was not installed or was disconnected.
 - For scalar measuring components, initial measurements are NOT created for disconnected periods.
 - For interval measuring components, initial measurements will be created or disconnected periods, but the intervals will be marked as 'No Read - Disconnected' (Measurement Condition code 102000) and will be ignored for estimation by VEE processing.
4. Confirm there are no in progress initial measurements that cover the period of the missing measurements.
5. Either generate an initial measurement or a To Do for each measurement gap that is found.

This process relies on an important date that is maintained on each measuring component:

- **Latest Contiguous Measurement Date/Time:** this represents the last time the measuring component had a complete history of measurements without any gaps. By nature it implies that there is a gap immediately after it.

This date allows the periodic estimation process to efficiently identify those measuring components that are missing measurements and need to be estimated.

NOTE: It is possible to disable periodic estimation for a given device by updating the periodic estimation eligibility on the service point it is associated to. This is useful if there are one-off service points that should either never be eligible for estimation or should temporarily have estimation turned off.

Periodic Estimation Feature Configuration

The estimation begin date for interval and scalar periodic estimation can be influenced by a feature configuration option under the feature type Measurement Data Options (D1MD).

When a **No of Hours in Past to Retrieve Last Useable Measurement** option is defined it will have two impacts on periodic estimation, both of which are only applicable when the measuring component's type does not have a value configured for the *Maximum Days to Estimate*.

1. When periodic estimation is run for a measuring component that does not yet have a **Last Contiguous Measurement Date Time** then this option will be used to compute the beginning of the search range to find a useable measurement. That date is then used to begin estimation from.
2. When running for a measuring component where the **Last Contiguous Measurement Date Time** is already set then this option will be used to compute the oldest date that estimation can begin from.

For both scenarios the begin date time calculation will be performed by subtracting the value configured from the current Process Date Time. For example, if this option were set to 744 hours (31 days) and the process date time were 02/01 12:00:00AM then the begin date time would be calculated as 01/01 12:00:00AM.

When implemented this option will also instruct the Update Latest Date/Time on Scalar Measuring Component algorithm type (D1-UPDDTSCMC), which is responsible for maintaining the latest measurement date time information for scalar measuring components, to skip initializing the latest measurement date/time information when an initial measurement is received for a measuring component where there is existing measurement data history and this feature configuration option is configured. For those scenarios the initialization of the latest measurement date/time information should be deferred to the Auto-Read Scalar Period Estimation process. Note: this only applies for situations when the latest measurement date/time information has not been set previously and the initial measurement is not the first measurement received for the measuring component.

NOTE: This does not apply to the analogous logic for an interval initial measurement.

Interval Periodic Estimation

When missing measurements have been identified by the interval periodic estimation functionality an estimation initial measurement will be created for each contiguous set of missing measurements in the estimation period.

There are two methodologies available for estimating interval measuring components:

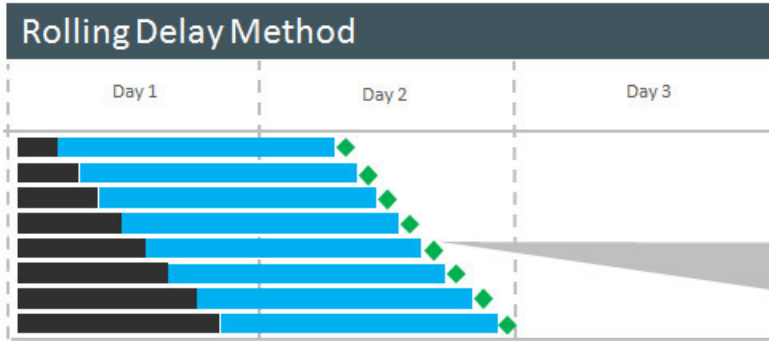
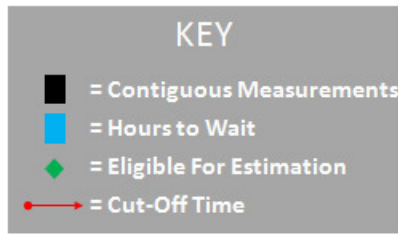

Each measuring component becomes eligible for estimation at a different time because the eligibility is calculated based on the Latest Contiguous Measurement Date/time which is unique per measuring component.

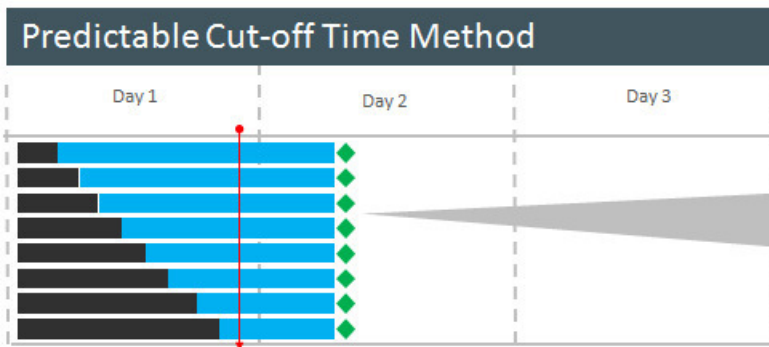

Each measuring component becomes eligible for estimation at exactly the same time because the eligibility is calculated based on the cut-off date time which is common for all measuring components for a given measuring component type.

- **Rolling Delay:** In this method the execution time of the periodic estimation process is an important factor in which measuring components will estimate how far each measuring component estimate. This method supports a minimum number of hours that will be estimated (as defined by the "Hours to Estimate" on the measuring component type).
- **Predictable Cut-off Time:** In this method all measuring components for a measuring component type will estimate until a specified point in time (as defined by the "Cut-off Time" on the measuring component type). With this method the cut-off time determines how far estimations are made rather than the execution time of the periodic estimation process. There is no minimum estimation size for this method it will always estimate up until the cut-off date/time even if that is only a single interval.

The cut-off time takes into consideration daylight savings time (DST) when the device is configured as sending data in legal time (meaning the Incoming Data Shift has been set to Always in Local). In these circumstances the cut-off time will be considered to be adjusted for DST. This is important because measurement data is stored in standard. For example:

Cut-off Time: 12:00AM	Measurement Time in Standard
01/15/2010 12:00AM (DST not in effect)	01/15/2010 12:00AM
04/15/2010 12:00AM (DST in effect)	04/14/2010 11:00PM

Furthermore, the cut-off time defined on the measuring component type does not have a time zone associated to it and as such it is considered to be defined in the time zone of the particular measuring component being processed. For example, a cut-off time of 12:00AM would be considered to be 12:00AM UTC -08:00 and 12:00AM UTC -05:00 based on the time zones of the respective measuring components. This allows a single measuring component to apply to many time zones and behave uniformly.

Algorithm Type – Create Interval IMD and To Do Based Upon Install History (D1-CIITBIH)

Algorithms based on this algorithm type determine if a measuring component is missing final measurements during the estimation horizon for any period where the associated device configuration was installed. If final measurements are missing it will either create an estimate initial measurement, create a To Do Entry, or both.

There are a few scenarios that will result in this algorithm being used:

1. If the measuring component's service point has an **Estimation Eligibility** of Not Eligible
2. If the measuring component's service point has open Estimation Suppression activities that overlap the System Date/Time and the MDM Master Configuration field **Fill Missing Data with Zero** is not set to "Yes"
3. If the measuring component's **Latest Contiguous Measurement Date Time** is greater than the process date time less the measuring component type's **Number of Hours to Wait**

The estimation horizon begin date is determined by first determining the initial horizon start date time:

- If the Measuring Component Type's **Maximum Days to Estimate** is configured it will be the more recent of the following two dates:
 - The process date time less the **Maximum Days to Estimate**
 - The Measuring Component's **Latest Contiguous Measurement Date Time**
- Otherwise, if the Measurement Data Option feature configuration type is configured with a value set for the **No of Hours in Past to Retrieve Last Useable Measurement** option then the start will be calculated as follows:
 - If the **Latest Contiguous Measurement Date Time** is populated then take the more recent of:
 - The process date time less the **No of Hours in Past to Retrieve Last Useable Measurement**
 - The Measuring Component's **Latest Contiguous Measurement Date Time**
 - Otherwise, if the **Latest Contiguous Measurement Date Time** is not populated then:
 - Search for a measurement between the following two dates:
 - Start: the process date time less the **No of Hours in Past to Retrieve Last Useable Measurement**
 - End: the process date time
 - If a measurement is found that date is used. Otherwise the process date time less the **No of Hours in Past to Retrieve Last useable Measurement** is used.
- Otherwise, the Measuring Component's **Latest Contiguous Measurement Date Time** is used.
- Otherwise, if the device is installed it will be set to the **Installation Date Time** of the Installation Event (IE).

The estimation horizon end date will be calculated based on the measuring component type's **Periodic Estimation Execution Method**.

Rolling Delay:

The more recent of the following dates will be used:

- The **Latest Measurement Date Time** plus the Measuring Component Type (MC Type) - **Number of Hours to Estimate** defined.
- The **Process Date Time** less the MC Type - **Number of Hours to Wait**
- Estimations are limited by either a device configuration change or removal. Therefore, the date determined above will be limited to the earlier of the device configuration **Effective End Date Time** or the **Removal Date Time** on Install Event.

Predictable Cut-off:

In predictable cut-off the intent is to only estimate up to the last cut-off time that has passed based on the **Number of Hours to Wait** from the measuring component type and no further.

First the process date time will be adjusted based on the **Number of Hours to Wait** configured on the measuring component type. For example, if the process date/time is 01/15/2010 06:00PM and the **Number of Hours to Wait** is 48 then the adjusted process date/time is: 01/13/2010 06:00PM.

Next, the last cut-off time to have passed will be identified and that will become the estimation end date time. In our above example this would be 01/13/2010 12:00AM.

Once the estimation horizon begin and end date times have been identified they may be further split into smaller periods based upon the Measuring Component's device configuration installation history.

For Example:

- Estimation horizon is April 10th at 12AM through April 20th at 12AM
- The Measuring Component's device configuration was installed at one service point on April 1st at 12AM and removed on April 15th at 12AM
- The Measuring Component's device configuration was then installed at a new service point on April 18th at 12AM
- Given the above information the estimation horizon would be broken up into the following two periods:
 - April 10th 12AM through April 15th 12AM (this is for the first installation)
 - April 18th 12AM through April 20th 12AM (this is for the second installation)

Each of the estimation horizon periods determined based upon the installation history will be further examined to determine contiguous periods where final measurements are missing.

For Example:

- Processing April 10th through April 15th
- One final measurement exists for April 12th for 8AM through 9AM
- Yields the following sub-periods:
 - April 10th 12AM through April 12th 8AM
 - April 12th 9AM through April 15th 12AM
- -For every missing period found,
 - Find Initial Measurements that are in a non Final state and the initial measurement's period has an overlap with the missing period.
 - For each initial measurement found,
 - If the initial measurement's period falls exactly within the boundaries of the missing period, skip the creation of an estimate initial measurement for the missing period.
 - If the initial measurement's end date/time is before the start of the missing period, the initial measurement's end date/time is now the start of the missing period. Proceed to create an estimate initial measurement for the adjusted missing period.
 - If the initial measurement's start date/time is after the start of the missing period, the initial measurement's start date/time is now the end of the missing period. Proceed to create an estimate initial measurement for the adjusted missing period.

Each time Periodic Estimation is executed the **Latest Contiguous Measurement** will be validated and potentially updated. For example, if it is before the install event's **Installation Date Time**, it will be updated to be the install event's **Installation Date Time**.

NOTE: If the **Latest Contiguous Measurement Date Time** falls within the installation window of a prior installation it will not be adjusted to the current install event's **Installation Date Time**.

Scalar Periodic Estimation

Scalar periodic estimation is only available for automatically read scalar measuring components since it requires that scalar measuring components be read on at least a daily basis to be eligible.

The scalar estimation process relies heavily on details from the measuring component type to identify when a measurement is missing. This is because scalar measurements are not required to fall on specific boundaries like interval data. For example, a scalar measuring component read on a daily basis around midnight could have measurements at 12:00AM, 11:55PM, 12:01PM or even at various other points during the day if a field reading or on demand read is performed.

Auto-read scalar measuring component types are configured to provide information that will:

- Identify at what point or points during the day the measuring component will be read. This is a combination of the Hours Between Measurements and the First Daily Measurement Time on the measuring component type.
- Identify the allowable tolerance for measurements that do not fall on the specific expected measurement date/times (e.g. 11:55PM and 12:05AM are OK but 9AM is not). This is defined by the Early and Late Measurement Threshold on the measuring component type.

This allows the scalar periodic estimation process to identify the points during the day that measurements are expected and if no measurement are found it will generate an estimation initial measurement.

Unlike interval periodic estimation each missing measurement will be created as a separate estimation initial measurement.

The Early Measurement Threshold and Late Measurement Threshold fields support situations where a head end system is not able to report their readings at a consistent time each day. For example a head end system might send reads as follows:

- 3/1 11:55PM
- 3/3 12:01AM
- 3/4 12:00AM
- 3/5 12:02AM
- 3/6 11:59 PM

These fields create a window prior to and after an expected reading where anything received within that window would satisfy the expected reading. For example:

- For a measuring component with an Early Measurement Threshold of 00:10:00 (10 minutes), a reading for 3/1 11:55PM would satisfy the early threshold for the 3/2 12:00AM expected reading.
- For a measuring component with an Late Measurement Threshold of 00:10:00 (10 minutes), a reading for 3/3 12:01AM would satisfy the late threshold for the 3/3 12:00AM expected reading.

To determine if a measuring component is eligible for estimation the process will evaluate if the Last Contiguous Measurement Date/Time far enough in the past. Specifically the number of hours elapsed since the Last Contiguous Measurement Date/Time must be greater than or equal to the Hours Before Estimation from the measuring component type.

NOTE: The first daily measurement time takes into consideration daylight savings time (DST) when the device is configured as sending data in legal time (meaning the Incoming Data Shift has been set to Always in Local). In these circumstances the first daily measurement time will be considered to be adjusted for DST. This is important because measurement data is stored in standard. For example:

First Daily Measurement Time: 12:00AM	Measurement Time in Standard
01/15/2010 12:00AM (DST not in effect)	01/15/2010 12:00AM
04/15/2010 12:00AM (DST in effect)	04/14/2010 11:00PM

Furthermore, the first daily measurement time defined on the measuring component type does not have a time zone associated to it and as such it is considered to be defined in the time zone of the particular measuring component being processed. For example, a first daily measurement time of 12:00AM would be considered to be 12:00AM UTC -08:00 and 12:00AM UTC -05:00 based on the time zones of the respective measuring components. This allows a single measuring component to apply to many time zones and behave uniformly.

Algorithm Type – Auto-Read Scalar Periodic Estimation (D1-ARSPE)

Algorithm based on this algorithm type determine if a measuring component is missing final measurements during the estimation horizon for any period where the associated device configuration was installed. If final measurements are missing it will either create an estimate initial measurement, create a To Do Entry, or both.

There are a few scenarios that will result in this algorithm being used:

1. If the measuring component's service point has an **Estimation Eligibility of Not Eligible**
2. If the measuring component's service point has open Estimation Suppression activities that overlap the System Date/Time and the MDM Master Configuration field **Fill Missing Data with Zero** is not set to "Yes"
3. If the measuring component's **Latest Contiguous Measurement Date Time** is greater than the process date time less the measuring component type's **Number of Hours to Wait**

The estimation horizon begin date is determined by first determining the initial horizon start date time:

- If the Measuring Component Type's **Maximum Days to Estimate** is configured it will be the more recent of the following two dates:
 - The process date time less the **Maximum Days to Estimate**
 - The Measuring Component's **Latest Contiguous Measurement Date Time**
- Otherwise, if the Measurement Data Option feature configuration type is configured with a value set for the **No of Hours in Past to Retrieve Last Useable Measurement** option then the start will be calculated as follows:
 - If the **Latest Contiguous Measurement Date Time** is populated then take the more recent of:
 - The process date time less the **No of Hours in Past to Retrieve Last Useable Measurement**
 - The Measuring Component's **Latest Contiguous Measurement Date Time**
 - Otherwise, if the **Latest Contiguous Measurement Date Time** is not populated then:
 - Search for a measurement between the following two dates:
 - Start: the process date time less the **No of Hours in Past to Retrieve Last useable Measurement**
 - End: the process date time
 - If a measurement is found that date is used. Otherwise the process date time less the **No of Hours in Past to Retrieve Last Useable Measurement** is used.
- Otherwise, the Measuring Component's **Latest Contiguous Measurement Date Time** is used.
- Otherwise, if the device is installed it will be set to the **Installation Date Time** of the Installation Event (IE).

The estimation horizon end date will be whichever of the following dates that is furthest in the past:

- Process Date/Time - **Hours Before Estimation** + **Number of Hours to Estimate**
- The device configuration's effective end date/time
- The Off date/time of the device configuration's installation event.

Second, the algorithm identifies any expected measurement date/time without a final measurement or an in progress initial measurement. For each missing measurement an Estimate initial measurement will be created. Estimations will only be made for periods where the device is installed at a service point. If the **Evaluate Installation Event Off Period** parameter has been set to 'N' or left blank then the device must also be turned on.

To determine if there are any missing final measurements during the estimation horizon the algorithm uses the concept of expected measurement date/times as [explained above](#). If there are any expected measurements not covered by a final measurements as dictated by the early and late thresholds then an initial measurement will be generated.

Measurement Reprocessing

About Measurement Reprocessing

One major problem utilities face today is when devices are installed with an incorrect consumption multiplier. When this occurs, the billing consumption and the bills are incorrect retroactively.

The Measurement Reprocessing module automatically corrects historical consumption when a change is detected for either a Measuring Component multiplier (the **Register Multiplier** for register measuring components or **Channel Multiplier** for interval and auto-read register measuring components) or an Install Event **Installation Constant** or **Installation Date/Time**. The system monitors for these changes and automatically reprocesses historical measurements if one of the values changes. When a Measuring Component has been triggered for Measurement Reprocessing, a new message will be recorded on the **Log** tab for the Measuring Component. The message will look similar to this example: "Measuring Component Multiplier updated from 1.000000 to 2.000000. Measurements will be examined for reprocessing". Also, a link to the activity created to perform the reprocessing will be shown in the Related Object column.

Two different Activities are leveraged to perform this reprocessing:

- **Measurement Reprocess Activity - Interval:** this activity reprocesses interval data by dividing existing measurements by the Combined Multiplier stored on each measurement record and creates new System IMDs.
- **Measurement Reprocess Activity - Scalar:** this activity reprocesses scalar data by creating new System IMDs from the Reading value stored on each measurement.

The new System IMDs that are generated will skip both VEE and Consumption Sync but will apply the new multiplier and installation constant. Once the activity is finished, a list of the spawned IMDs will be displayed on the Activity screen.

This process works in tandem with the Adjustment Notification process to trigger billing adjustment notifications to the CIS. If usage transactions have already been fulfilled once measurements are reprocessed, then each affected period will be sent to CIS to indicate that an adjustment is required.

If desired, an approval step can be set as required on the related Activity Type. If set, a To Do will be generated for review. The review steps for this To Do are covered in the [Reviewing Measurements for Reprocessing](#) section.

The diagram below helps to provide an overview of Measurement Reprocessing:

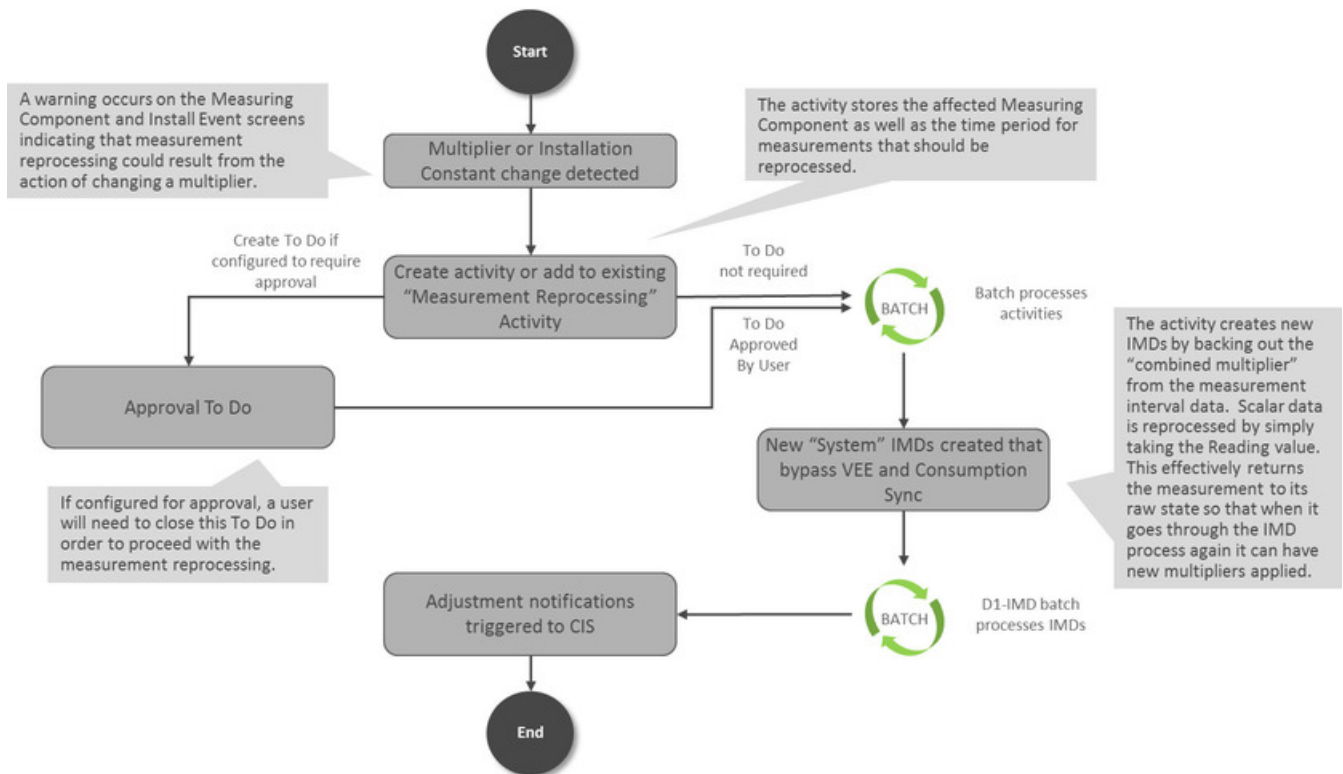

For information on configuration, reference the related section for [Configuring Measurement Reprocessing](#) in the *Administrative User Guide*.

Reviewing Measurements for Reprocessing

When the Measurement Reprocessing Activity Types are configured as "Yes" in the "Approval Required?" field, then a To Do will be generated for user review. The To Do Type for this is set on the Activity Type as well (the configuration for this is covered in detail in the section for [Configuring Measurement Reprocessing](#) in the *Administrative User Guide*).

This To Do provides an approval step for a user to examine the Measurement Reprocessing Activity and perform the following:

1. Determine if the multiplier or date change appears legitimate and accurate. Information on the type of change that occurred can be found on the **Log** tab for the Activity. If the change should be rejected, this can be performed using the **Discard** button.
2. Ensure that the period being examined for reprocessing (shown as the Activity Start Date and End Date) covers the period expected. If not accurate, the dates can be changed using the **Edit** button.

If all information on the Activity is correct, then press the **Approve** button to allow reprocessing to continue. Once the activity is finished, a list of the spawned IMDs will be displayed on the Activity screen.

Refer to [About Measurement Reprocessing](#) for additional functional information.

Consumption Sync

Introduction to Consumption Sync

Traditional interval and smart meters are often configured with two channels of consumption data, one interval and the other scalar. Utilities configure their meters this way for several reasons, including:

- Two channels provide for a redundant reading in case of a failure.
- Two channels provide for an independent check reading to ensure the meter is working properly.
- Customers often need both types of data for their business processes.

When capturing and storing usage for smart meters with related measuring components, one potential challenge is keeping measurements from related scalar and interval channels synchronized. Measurements for interval and scalar channels for the same device may fall out of alignment for many different reasons, such as:

1. Some meters use different technologies for recording interval and register readings, so the physical readings can be different
2. Readings can vary because of different measurement times
3. Estimation processes can vary by channel and produce different results
4. There can be a mix of actual and estimated measurements

Having two sources of consumption data can cause many problems for utilities. Unfortunately, utilities often need both the scalar and interval data to satisfy their business requirements. For example, scalar register readings may be used for billing, while the interval data is used on a customer self-service portal.

Keeping measurement data aligned between two related measuring components is achieved in several ways:

- During the initial load of initial measurement data VEE rules estimate for missing measurements using measurement data from related measuring components when available. Please refer to [About IMD Estimations](#) for more information.
- When measurement data is missing for one or both of the related measuring components the periodic estimation process will generate estimation initial measurement data that will estimate one measuring component then estimate the second measuring component such that the second measuring component's data can be synchronized with the first. Please refer to [About Periodic Estimation](#) for more information.
- When new, more accurate, measurement data is received for only one of the measuring components the consumption synchronization process will be initiated to align the previously estimated data with the newly received data. Note: this process is what this section will be concentrating on.

Consumption synchronization is a process by which measurement data for related measuring component is kept synchronized by re-estimating existing measurements when measurement data for related measuring components is received.

For example, consider the following scenario:

- A meter has both scalar and interval channels, and the scalar register channel is considered the "primary" or more reliable channel. The total consumption for each channel should match the consumption for the other channel.
- For a particular day, the daily reading for the "secondary" (interval) channel is received before reads from the scalar register have been received. This reading contains two missing intervals, which are estimated during VEE.
- After the interval reading has been finalized, a scalar register reading for the same day is received. The total of this reading is slightly different than the total of the interval reading due to the estimation of the missing intervals.
- The consumption synchronization process can trigger a re-estimation of the two estimated intervals to adjust the total of the interval reading to match that of the scalar register reading.

Other examples of situations that can be resolved using the consumption synchronization process include the following:

- Register Readings whose start/stop times do not align with interval boundaries

- A broken meter for which estimated readings are created for several days
- Requirements that readings from both channels match exactly even if neither contains estimated measurements

Primary Versus Secondary Measuring Components

When measuring components are related, one is considered the "primary" measuring component, and the other is considered the "secondary" measuring component. How the consumption synchronization process works for a given meter is based largely on which measuring component is considered primary and which is considered secondary.

The following are important principles regarding the primary/secondary measuring components:

1. The primary measuring component has the more reliable data.
2. The secondary measuring component should validate that its consumption aligns with the primary measuring component.
3. If the secondary measuring component needs to be estimated, it should estimate using the available data from the primary measuring component.
4. When possible, initial measurements for the primary measuring component should be processed prior to those for the secondary measuring component (Note: the D1-IMD batch process will process initial measurements in this order). In some scenarios when the secondary measuring component is read more frequently than the primary measuring component, it can be advantageous to violate this principle in favor of being able to execute smaller more frequent loads of measurement data.
5. Periodic estimation should be performed on the primary measuring component first, and then the secondary measuring component.

Understanding Consumption Synchronization Processing

This section provides an overview of the process that supports keeping consumption for related measuring components synchronized.

Note that the process outlined below has been simplified for illustrative purposes, and does not reference every step performed in this process.

1. An initial measurement is received (via initial load or manual) for a measuring component whose device configuration is consumption synchronization enabled.
2. The consumption synchronization process evaluates the related "consumption reference measuring component" to identify any measurements for the time period of the initial measurement are consumption sync eligible (typically estimated).

If eligible measurements are found a consumption synchronization activity is created. Note: the activity will not immediately process it will remain in an initial status until a background process is executed.

3. When the consumption sync background process is executed the activity initiates the re-estimation process by creating estimation initial measurements for each measurement that must be synchronized:
 - For scalar measuring components, this initial measurement contains no measurement value.
 - For interval measuring components, this initial measurement can contain a combination of "Regular" measurements (based on existing final measurements) and measurements that require estimation (based on and corresponding to the measurements with condition codes that fell between the range defined for "consumption synchronization" in step 2).
4. Each estimation initial measurement that was created will execute the estimation VEE group rules to recalculate the synchronization eligible measurements.

VEE

Introduction to VEE

About VEE

As measurements are received into Oracle Utilities Meter Data Management there is a need to ensure the data is accurate, fill in any missing data with estimations, and flag any failures for review by users. The VEE (Validation, Estimation, and Editing) process is the primary method for ensuring that these objectives are met.

VEE acts as a multi-layered filtration system for IMDs. Raw data is received from the Head End as Initial Measurement Data and only clean, validated data is received on the other end in the Measurement table. The IMD has both a Pre-VEE and Post-VEE section that details any data changes made as part of VEE.

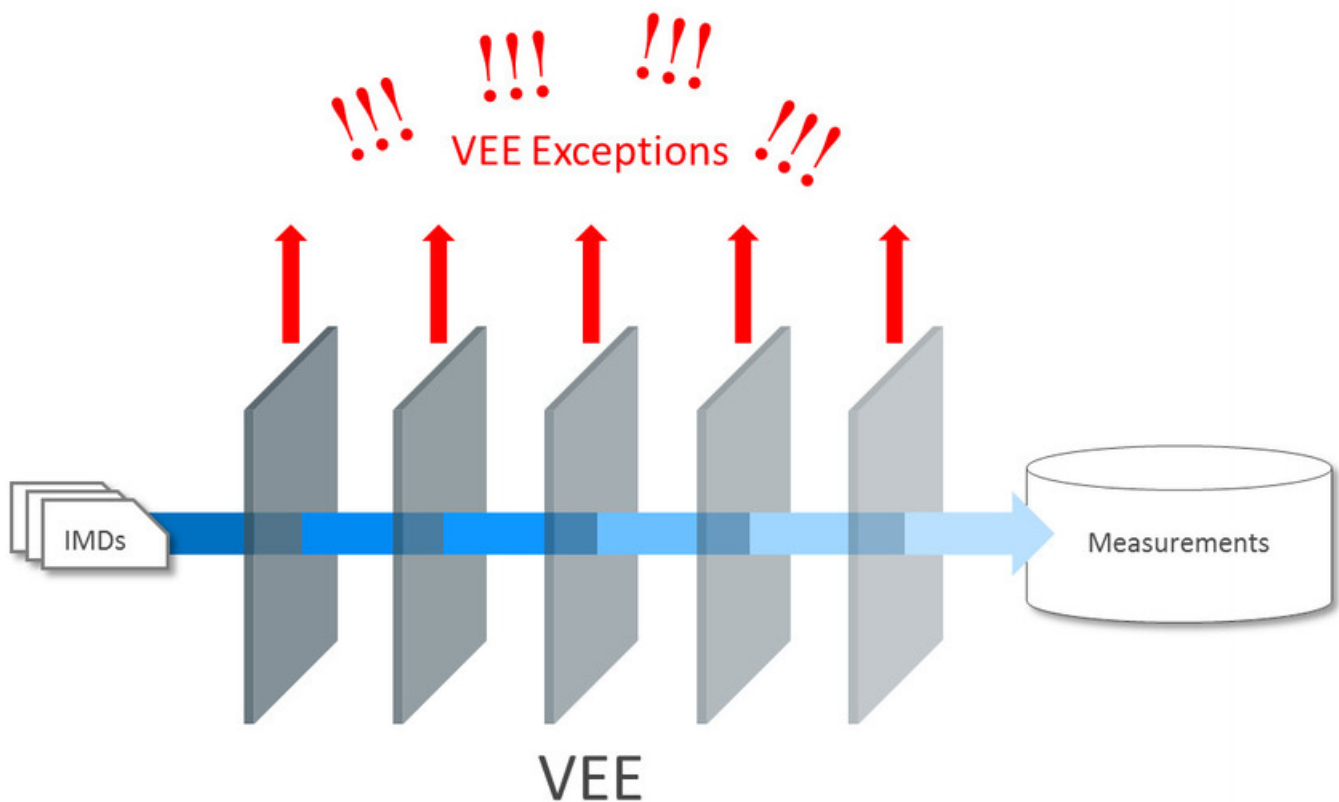

Initial measurement data can come from different sources, such as a head-end system or estimation processes, or it can be manually created by a user (to override or estimate consumption). Measurement data from these different sources might use different VEE Rules. For example:

- Initial measurements sent a head-end system might use strict VEE Rules
- Initial measurements created by a user (to override or estimate consumption) may use less strict rules
- Initial measurements created by the system to estimate consumption have very few (if any) VEE Rules

To assist with this need, you can define different VEE Groups for different sources of IMDs. The base package roles are:

- **Initial Load:** Used for initial measurement data received from a head-end system or import process
- **Manual Override:** Used for initial measurement data manually created by a user or created by the reconciliation process for scalar or subtractive interval measuring component types
- **Estimation:** Used for initial measurement data estimated by the system
- **Projection:** Used for "what if" services that are projecting future energy use for a measuring component

Refer to [About Initial Measurement Data](#) for additional functional information about the reconciliation process.

A measuring component's Measuring Component Type can define "fallback" VEE groups for each of these roles. In addition, an individual measuring component can specify a VEE group for each role. If the measuring component doesn't have a VEE group specified for a role, the "fallback" VEE group defined for the measuring component type is used.

The VEE process has a number of different objects that are detailed below that allow for configurability and flexibility in how the process executes.

VEE Groups

VEE groups are collections of VEE Rules that are applied to initial measurement data. During the VEE process, the system executes the VEE Rules defined in each VEE group. The rules within a VEE group are defined in a specific sequence, allowing control over the order in which the rules are executed.

VEE groups can be associated to a specific measuring component, or to a measuring component type (or both). VEE groups associated with a measuring component type are applied to all measuring components of that type, while those associated to a specific measuring component are applied only to that measuring component. VEE groups associated to a measuring component override those assigned to a measuring component type.

For information on configuration, reference the related section for [Configuring VEE Groups](#) in the Administration Guide.

VEE Rules

The specific validation and estimation processing performed on initial measurement data is defined in individual VEE Rules, each performing a specific set of targeted logic. The base product contains many VEE Rules you can use in your implementation, but you can also create your own custom VEE Rules.

Some VEE Rules generate VEE Exceptions if the initial measurement data fails the conditions specified for the rule. Other rules override measurements, changing measurement values as dictated by the rule's parameters. Some rules can both create exceptions and override the measurement as part of a single process. By convention, VEE Rules change the Post-VEE quantities of initial measurement data, but VEE Rules can change anything on an initial measurement.

For a list of validation VEE Rules, reference the [About IMD Validations](#) section. For a list of estimation VEE Rules, reference the [About IMD Estimations](#) section. For a list of general VEE Rules that handle decision-making within the VEE process, reference the [Decision-making VEE Rules](#) section.

For information on configuration, reference the related section for [Configuring VEE Rules](#) in the Administration Guide.

VEE Exceptions

Each VEE Rule defines an exception type and severity that specify how exceptions are tracked by the system. When an initial measurement fails a validation, an exception of the type specified for the failed VEE Rule is created. A single initial measurement can have multiple exceptions, one (or more) for each rule the measurement fails. This allows users to see all of the problems detected during the VEE process.

There are three levels of severity for VEE Exceptions:

- **Info:** Used to highlight something interesting, but not sufficient to cause the initial measurement to be put into the Exception state. Exceptions of this category can be used to report on the frequency of interesting, but not fatal issues.
- **Issue:** Used to report a problem that will prevent the initial measurement from being finalized. Multiple "issue exceptions" can be created during VEE processing. If at least one issue exists after all rules have been applied, the initial measurement is transitioned to the Exception state.

- **Terminate:** Used to report a severe issue that will cause the VEE process to stop and the initial measurement to be transitioned immediately to the Exception state. Only one terminate exception can be issued (as the first one causes VEE to stop on an initial measurement).

Note that exceptions are not deleted when an initial measurement is adjusted or corrected. After any issues are corrected or the initial measurement is overridden (or manually completed), the exceptions persist in a closed state for reporting purposes.

For information on configuration, reference the related section for [Configuring Exception Types](#) in the Administration Guide.

VEE Rule Eligibility Criteria

Each VEE Rule may optionally have eligibility criteria that controls if the rule is applied. This feature can greatly reduce the number of VEE groups you need to create, because it allows a single VEE group to have conditional VEE Rules based on eligibility criteria (rather than requiring a distinct VEE group for every combination of VEE Rules). Below are a few examples of ways you can use eligibility criteria:

- You might create a rule that compares interval consumption against related scalar consumption (such as might be the case with a device with both interval and scalar measuring components). This rule might use eligibility criteria that specifies that the rule is only applied if the initial measurement's measuring component has a corresponding scalar register measuring component.
- You might want to have a common VEE group but only have certain rules execute to execute based on Unit of Measure. An eligibility criteria can be setup so that a VEE Rule only executed for kWh whereas is skipped for kVARh.
- Another example might be a rule that compares the current consumption against standard consumption for measuring components of a certain type for the first six months after installation. You might create eligibility criteria that specifies that the rule is only applied if the measuring component's Device Configuration has been installed at a Service Point for less than six months.

For information on configuration, reference the related section for [Configuring VEE Rules](#) in the Administration Guide.

Decision-Making VEE Rules

In addition to the VEE Rule Eligibility Criteria, there are VEE Rules delivered as part of the base product that help with decision-making when executing VEE (listed below). For more information on how each rule executes and can be configured, follow the link provided on the rule.

VEE Rule Name	Purpose
Exception Handler	This rule allows for termination of the VEE process based on a configurable set of exceptions being present for the IMD. This rule also allows a unique To Do Type to be generated based on a group of exceptions.
Execute VEE Group	This rule performs a call to execute a separate VEE Group which includes execution of all VEE Rules within that group.
Successful Termination	This rule allows VEE to be successfully terminated based on a list of exceptions.
VEE Group Matrix (Factor)	This rule provides a way to choose different instances of a VEE Rule using a Factor. This factor leverages characteristics that are defined on Service Point, Device, or Measuring Component.

Validations

About IMD Validations

Validation of the Initial Measurement Data on the way in to Oracle Utilities Meter Data Management occurs by leveraging the diverse library of VEE Rules. Below is a list of the validation VEE Rules that are provided as part of base product. For more information on how each rule executes and can be configured, follow the link provided on the rule.

VEE Rule Name	Applicable Data Type(s)	Purpose
Consecutive Interval Check	Interval	This validation rule flags any combination of consecutive intervals within Initial Measurement Data based on the values of the data or the condition codes of the data.
Duplicate IMD Check	Interval or Scalar	This rule allows for a duplicate IMD to be flagged.
Dynamic Comparison Validation	Interval or Scalar	This powerful, flexible validation rule compares measurements to historical statistics for the related Service Point. The system will maintain statistics such as the following: sum, min, max, average, median, zero value count, outage count, and standard deviation. Then you define formulas (no programming required) for the comparison of current measurements to these statistics.
Ensure IMD Exists for Sibling MCs	Interval or Scalar	This rule validates that an IMD exists for all of the other measuring components associated to the same Device Configuration as the current measuring component, for the same period of time.
Final Measurement Replacement	Interval or Scalar	This validation rule allows you to define a variety of configuration options to decide if new data should replace existing measurements. The options include value change thresholds, percentage change thresholds, as well as condition code ranking.
High/Low Check	Interval or Scalar	This validation rule compares the total consumption of the current IMD to historical values. The comparison is normalized based on average daily usage (ADU). If the current IMD is too high or too low compared to historical data then an exception is thrown.
Inactive Measurement Check	Interval or Scalar	This validation rule flags any Initial Measurement Data received on a device that is either disconnected, uninstalled, and/or not connected to a Usage Subscription.
Interval Size Validation	Interval	This rule validates that the interval size (in seconds) supplied with the Initial Measurement is equal to the interval size defined on measuring component's type.
Interval Spike Check	Interval	This rule checks for spikes within an IMD and generates an exception if one is found.
Multiplier Check	Interval or Scalar	This rule validates that the register multiplier supplied with the IMD is equal to the multiplier stored on the measuring component. If not, an exception is created using the register multiplier exception type and severity configured on the rule.
Negative Consumption Check	Interval or Scalar	This rule flags any IMD where the total consumption is negative.
Prolonged Estimation Check	Interval or Scalar	This validation rule creates an alert when a device has been estimated for an extended period of time.
Raise Missing Quantity Exception	Interval	This rule flags any missing interval data.

Sum Check	Interval or Scalar	This rule is used to compare the difference between interval data to scalar data for a period of time, or between a set of TOU scalar reads to a "Sum" scalar reading.
Unit of Measure Check	Interval or Scalar	This rule checks the unit of measure (UOM) passed in with the Initial Measurement against the primary unit of measure configured on the measuring component's type.
Zero Consumption Check	Interval or Scalar	This rule checks if the total consumption for the IMD is zero. There is also a check for whether an outage occurred during the same time as the zero consumption to provide ways to avoid exceptions in that case.

Refer to [About VEE](#) for additional functional information.

Reviewing and Resolving VEE Exceptions

All To Dos generated by a VEE Exception will link back to the Initial Measurement Data that originally failed to create the VEE Exception.

Users have a number of options for dealing with initial measurements with exceptions.

- After correcting the cause of the issues that triggered the exceptions, a user can reinitiate the VEE process for the IMD using the **Perform VEE** button.
- A user can **Discard** the initial measurement.
- A user can use the **Force Complete** button on the IMD in the scenario that they want to approve the exception and the measurement information in the IMD. *Note:* No VEE processing is performed on initial measurement data that is force completed. Regardless of the action taken by the user, the system will complete any open To Do Entries that created when the initial measurement entered the Exception state.

Refer to [About VEE](#) for additional functional information.

Usage Transaction Validations

There are also validations available during the execution of usage calculation. For more information on these reference the [Reviewing and Resolving Usage Transactions](#) section.

Estimations

About IMD Estimations

Below is a list of the estimation VEE Rules provided as part of base product that are responsible for filling the missing data within an IMD. For more information on how each rule executes and can be configured, follow the link provided on the rule.

VEE Rule Name	Applicable Data Type(s)	Purpose
Interval Adjustment From Scalar	Interval	This rule performs adjustments to interval values based on the values from the associated scalar data on the same device.
Interval Averaging Estimation	Interval	This rule finds historical interval data from the same measuring component based on a variety of configuration options to use for estimating any missing data within an IMD.

Interval Create Estimation IMD for Gap	Interval	This estimation rule creates a new Estimation IMD to fill gaps between the interval data received from the Head End. Note: <i>this estimation rule acts differently from the other rules as it creates a new IMD rather than filling in missing values in an estimation IMD created from periodic estimations.</i>
Interval Interpolation Estimation	Interval	This rule attempts to interpolate gaps within an IMD using prior and subsequent intervals as starting points for linear interpolation.
Interval Profile Estimation	Interval	This rule estimates any missing interval data for the IMD based on a referenced Profile Factor.
Interval Proxy Day Estimation	Interval	This rule checks for days with similar temperature and uses the measurement data from those days as the basis of interval estimation for the in-flight initial measurement.
Scalar Calculation From Interval	Scalar	This rule performs adjustments to scalar values based on the values from the associated interval data on the same device.
Scalar Estimation	Scalar	This rule finds historical scalar data from the same measuring component based on a variety of configuration options to use for estimating any missing data within an IMD.
Scalar Profile Estimation	Scalar	This rule will estimate any missing scalar data for the IMD based on a referenced Profile Factor.
Scalar Proration	Scalar	This rule prorates the value of a scalar reading that has two valid scalar readings on either side as boundaries. It will also take into account any related interval data within the same period to exclude from the calculation.
Subtractive Interval Adjustment Rule	Subtractive Interval	This rule performs adjustments to qualifying interval consumption values for subtractive interval measuring components based on an adjustment target calculated using a start and stop reading for the period that encapsulates the intervals to adjust.

Refer to [About VEE](#) for additional functional information.

Usage Transaction Estimations

There are also estimations available at the time of usage calculation. For more information on these reference the [Reviewing and Resolving Usage Transactions](#) section.

Editing

About IMD Editing

At times, the values received in as Initial Measurement Data need to be edited by a user. This is covered in the [Editing Initial Measurements](#) section.

If measurement data is found to be incorrect, a new IMD must be generated to correct the data. This is covered in the [Generating new Initial Measurements](#) section.

Refer to [About VEE](#) for additional functional information.

Editing Initial Measurements

Initial measurements can be manually edited via functions available in the Interval Initial Measurement Lens or Scalar Initial Measurement zones in the Initial Measurement portal. Manual edits can include changes to the measurement values or condition codes.

By default, manual edits made by users of these zones are not logged on the Log tab.

Refer to [Configuring Measurement Logging](#) for additional information on how initial measurement changes can be logged.

Generating New Initial Measurements

The main location for viewing measurements and generating new IMDs for any discrepancies is through the [360 Degree View Measuring Component portal](#). On the portal many of the zones provide ways to [apply measurement functions](#) that will generate a new IMD.

Usage

Introduction to Usage Calculation

About Usage Calculation

Oracle Utilities Meter Data Management can calculate and publish usage calculated from measurement data to service providers on an ongoing basis. In addition, external systems can request usage whenever needed. Usage calculations derive a usage transaction's usage quantities using the measurements linked to a usage subscription's service points.

Before bill determinants can be calculated, you must first create a [Usage Subscription](#). The usage subscription defines the external system to which the data should be sent as well as the usage calculation group that will be used for calculation. The usage calculation rules defined for the usage calculation group are responsible for performing the specific calculations, validations, or estimations for bill determinants.

Usage Service Quantities (bill determinants) are derived from the Measurements of the measuring components installed at the Usage Subscription's Service Points during the calculation period. A Service Point is linked to measuring components through an Install Event linked to the measuring components' Device Configuration.

The results of all calculations performed by Usage Subscriptions are stored as a [Usage Transaction](#).

At any instance in time:

- A Usage Subscriptions may be linked to multiple Service Points
- A Service Point may be linked to a single Device Configuration
- A Device Configuration may have multiple measuring components

The calculation period for bill determinant calculations can span many days and over this period:

- The Service Points linked to the Usage Subscription can change (Service Points can be added and removed)
- The Device Configurations installed at the Service Point can change (due to device reconfigurations and meter exchanges)

This means that values for each Usage Subscription can be calculated using multiple Service Points and measuring components.

The Usage Calculation process has a number of different objects that are detailed below that allow for configurability and flexibility in how the process executes.

Usage Calculation Groups

Usage Calculation Groups are collections of usage calculation rules that are used to either calculate bill determinants or validate bill determinants. During the Usage Transaction process, the system executes the usage calculation rules defined in the usage calculation group referenced on the usage subscription. The rules within a usage calculation group are defined in a specific sequence, allowing control over the order in which the rules are executed.

For information on configuration, reference the related section for [Configuring Usage Calculation Groups](#) in the Administrative User Guide.

Usage Calculation Rules

The specific calculation, validation, or estimation processing performed on a Usage Transaction is defined in individual usage calculation rules, each performing a specific set of targeted logic. The base product contains many usage calculation rules you can use in your implementation, but you can also create your own custom usage calculation rules.

For a list of validation usage calculation rules, reference the [About Usage Validations](#) section. For a list of estimation usage calculation rules, reference the [About Usage Estimations](#) section. For a list of all other usage calculation rules that handle calculation of bill determinants, reference the [Inventory of Other Usage Calculation Rules](#) section.

For information on configuration, reference the related section for [Configuring Usage Calculation Rules](#) in the Administration Guide.

Usage Transaction Exceptions

Each usage calculation rule defines an exception type and severity that specify how exceptions are tracked by the system. When a Usage Transaction fails some part of a usage calculation rule, an exception of the type specified for the failed usage calculation rule is created. A single Usage Transaction can have multiple exceptions, one (or more) for each rule that failed. This allows users to see all of the problems detected during the Usage Calculation process.

There are three levels of severity for Usage Transaction Exceptions:

- **Information:** Used to highlight minor issues, but not sufficient to cause the Usage Transaction to be put into a failure state. Exceptions of this category can be used to report on the frequency of interesting, but not fatal issues
- **Issues:** Used to report a problem that will prevent the usage transaction from being sent. Multiple "issue exceptions" can be created during usage transaction processing. If at least one issue exists after all rules have been applied, the usage transaction is transitioned to a failure state requiring review and approval.
- **Terminate:** Used to report a severe issue that will cause the Usage Calculation process to stop and the Usage Transaction to be transitioned immediately to a failure state requiring review and approval. Only one terminate exception can be issued (as the first one causes calculation processing to stop on for a Usage Transaction). This should be used for cases where manual override / approval isn't accurate. For example, a "Curve Not Continuous" error that says the interval data doesn't cover the full usage period should always be set to Terminate as an Exception Severity.

Note that exceptions are not deleted when a Usage Transaction is adjusted or corrected. After any issues are corrected or the Usage Transaction is overridden (or manually completed), the exceptions persist in a closed state for reporting purposes.

In addition to exceptions, usage processing can also trigger the creation of To Do Entries related to failed validations. If Issue or terminate exceptions exist for an initial measurement, a To Do Entry is created when the usage transaction is transitioned to the Exception state. The To Do Type and default To Do Role of this To Do Entry are defined on the Enter system event for the Exception state of the business object used to define the usage transaction.

To Do Entries created in this way can be routed to different roles depending on the exception's message category and number (using the To Do Type's Message Overrides tab).

For information on configuration, reference the related section for [Configuring Usage Transaction Exception Types](#) in the Administration Guide.

Usage Calculation Rule Eligibility Criteria

Usage calculation rule eligibility criteria are user-definable conditions that could cause a given usage calculation rule to be applied or skipped. This can involve the evaluation of some attribute of the usage subscription or service point, or something else entirely. A usage calculation rule can have multiple eligibility criteria for determining if the rule should be applied or skipped, based on a user-defined sequence.

For information on configuration, reference the related section for [Configuring Usage Calculation Rules](#) in the Administration Guide.

Usage Subscriptions

About Usage Subscriptions

A Usage Subscription is an ongoing request to send one or more Service Points' usage to one or more external systems. The usage subscription defines which usage calculation group should be used to calculate service quantities (often referred to as bill determinants).

Usage subscriptions must reference a:

- **Service Provider.** The service provider is used as the identity of the subscribing system. In other words, you must set up a service provider for any system that subscribes to bill determinants.
- **Contact:** Contacts are individuals or business entities with which a company has contact. A contact exists for every individual or business related to a usage subscription. A single usage subscription can have many contacts, and a single contact may be referenced on many different usage subscriptions. Contacts have a 1-to-1 correlation with a "person" in a customer information system (CIS) and the CIS is considered the system of record for contact information.

An Aside: No Account Object Exists

Oracle Utilities Meter Data Management is not considered the system of record for accounts or Usage Subscriptions. The customer information system (or some other system) is considered the system of record for this type of information. In order to minimize the amount of data that must be synchronized between systems, account and service agreement oriented attributes used by the meter data products are held on Usage Subscriptions. For example, if an account's ID and its customer class are relevant to usage calculations, each Usage Subscription must reference both elements. This is an important distinction to keep in mind when creating custom Usage Subscriptions for your implementation.

Refer to [About Usage Calculation](#) for a broader functional view of the overall process.

Maintaining Usage Subscriptions

This portal is used to display and maintain a Usage Subscription.

Refer to [About Usage Subscriptions](#) or [About Usage Calculation](#) for additional functional information.

You can access the portal from **Menu > Usage > Usage Subscription**. You are brought to a query portal with options for searching. Once your record has been selected you are brought to the maintenance portal to view and maintain the selected record.

The following zones may appear as part of the portal's **Main** tab page:

- **Usage Subscription:** Defines basic information about the usage subscription, including factor overrides, usage calculation groups, and service points.

- **Usage Subscription Market Participants:** Lists market participants associated with the usage subscription (via Usage Subscription Market Participants)
- **Sub Usage Subscriptions:** Lists the first fifty "sub" usage subscriptions for the master usage subscription displayed in the Usage Subscription zone. This zone is only displayed for "master" usage subscriptions.

Usage Subscription Market Participants

About Usage Subscription Market Participants

Usage subscription market participants connects a Market, Market Participant and Usage Subscription together over a specified date range. Usage subscription market participants can be created either via the **Usage Subscription Market Participant** portal, or by adding a market participant to a usage subscription via the **Usage Subscription** portal.

Usage subscription market participants are defined by the following:

- **Usage Subscription:** The usage subscription for which this usage subscription market participant was created.
- **Market Relationship Type:** The market relationship (Distributor, Supplier, etc.) of the market participant and its role within a market.
- **Start Date/Time:** The start date/time for when the record is applicable.
- **End Date/Time:** The end date/time for when the record is applicable.
- **Market Participant:** The market participant associated with the **Usage Subscription**, including an optional ID used by the market participant to uniquely identify the account (usage subscription).

Maintaining Usage Subscription Market Participants

You use the **Usage Subscription Market Participant** portal is used to display and maintain usage subscription market participants.

Refer to [About Usage Subscription Market Participants](#) for additional functional information.

You can access the portal from the **Main > Usage > Usage Subscription Market Participant**. You are brought to a query portal with options for searching. Once your record has been selected you are brought to the maintenance portal to view and maintain the selected record.

The following zones may appear as part of the portal's **Main** tab page:

- **Usage Subscription Market Participant:** This zone displays the basic attributes of the usage subscription market participant
- **Sub Usage Subscriptions:** lists sub usage subscriptions for the usage subscription market participant's usage subscription

Usage Transactions

About Usage Transactions

Usage Transactions are records of bill determinant calculations for a Usage Subscription. All of the Service Quantities calculated are stored as part of the Usage Transaction.

Most requests for usage result in the creation of a usage transaction, but it is possible for an external application to invoke the usage calculation engine real-time. In other words, usage can be retrieved for a usage subscription real-time without creating a usage transaction. This technique is only recommended for online requests, not as part of batch processes.

Usage Calculation Group Determination

The first step in calculating the usage is to determine the usage calculation group holding the rules set used in calculating or validating the bill determinants. There are two ways of configuring the usage calculation group to use in the processing. It may be specified on the usage subscription during its creation with an effective and expiration date. If there are no usage calculation groups in effect for the usage transaction, the fallback usage calculation group specified in the usage subscription type will be used. The other way is to specify an algorithm – Determine Usage Calculation Group Override, on the usage subscription type. This option provides flexibility in cases where special or custom logic will be required to identify the usage calculation group. Base product delivered an algorithm that identifies the usage calculation group based on the rate and installed device. Additional details can be found in the Detailed Description of the D2-DRVUSGGRP Algorithm Type.

Calculation Period

Usage transaction requests must specify the date range for the usage transaction. This date range is referred to as the calculation period for the usage transaction. The dates that define the calculation period are specified by a subscribing system when it requests a usage transaction.

Multiple Device Configurations and the Calculation Period

In situations where a meter exchange has taken place at a service point, more than one device configuration can be in effect during the usage transactions cutoff period (the time period between the **End Date/Time From** and **End Date/Time To** values).

To account for this, the **Meter Exchange Option** on the [Usage Subscription Type](#) can be used to specify how the usage calculation should handle multiple device configurations in effect during the cutoff period. If the flag is set to 'Defer Calculation', new device configurations are excluded in the current usage transaction. If the flag is blank or set to 'Calculate Usage', new device configurations are included in the current usage transaction.

Date Breaks

As noted above, date breaks are used to break up a usage period into sub-periods based on the dates on which rate changes took place for the service point. For example, suppose a subscribing system requests usage for the month of January. The customer for this request has an interval meter, and the customer's usage is calculated by applying a TOU map to their interval consumption. The subscribing system detects that the customer's rate changed in the middle of January (on January 16) and wants the TOU consumption calculated in two "chunks" (before and after the rate change). Because the customer has an interval meter, the exact consumption amounts before and after the rate change can be precisely calculated (as opposed to calculating each period's amount by dividing the total usage by the number of days in each period).

One approach to this situation would be for the subscribing system to request two usage transactions (where each has the desired date range). Another approach is for the subscribing system to request a single usage transaction with date breaks that define the date ranges before and after the rate change. To continue the above example, a usage transaction could be created with a date break on January 16.

If a usage transaction has date break(s), the usage calculation engine segregates the usage into multiple usage periods based on the date breaks. If there are no date breaks in the usage transaction, a single usage period is created for the entire calculation period.

As of the v2.0.0 release, the only way a usage transaction can have date breaks is if the subscribing system supplies these when it requests usage (only the subscribing system knows if and when its prices and pricing rules change during the billing period). If an implementation has additional criteria that causes date breaks, these criteria can be easily added to the usage transaction's business rules.

Service Quantities

Every usage period created for a usage transaction contains one or more service quantities. Service quantities are calculated by the usage calculation group's rules specified for the usage subscription from which the usage transaction is created. For example, a usage transaction might have service quantities calculated by a single rule that applies a TOU map to the kWh channel on the device configuration installed at the service point.

Each service quantity lists details about that quantity, including a UOM (or TOU or SQI as appropriate) and a quantity. In addition, each service quantity also references the source (measuring component) of the quantities (for audit purposes).

Service Quantity Rounding

The manner in which service quantities are rounded can be defined using the **SQ Rounding Details** parameters. These parameters allow configuration of the method by which quantities are rounded (Up, Down, or Nearest) and the number of decimal positions retained after rounding.

Quality Assessment for Bill Print Options

Usage transaction service quantities can also contain information about the quality of the measurements used in their calculations and other information that can be sent to an external customer information or bill print system. This information is included in both the usage transaction and its related outbound message.

Quality Assessment

The [Daily Scalar Usage Calculation Rule](#), [Get Interval Data](#), [Get Scalar Details](#), and [Get Time of Use Mapped Usage](#) usage calculation rules include a "Perform Measurement Quality Assessment" option that indicates (yes or no) if the measurement conditions of the measurements used when calculating usage should be evaluated and included in the resulting usage transaction and outbound message. When enabled (set to "Yes"), the usage calculation rule algorithm evaluates the condition codes of the measurements used in the calculation to determine if they fall within a "Regular" range of conditions (this range is defined by the "Bottom Regular Condition Range" and "Top Regular Condition Range" algorithm parameters). The result of this assessment is displayed in the "Data Quality Assessment" column in the Usage Periods section which indicates if the service quantity is based on "regular" or "non-regular" data. (If the "Perform Measurement Quality Assessment" option is disabled, the "Data Quality Assessment" column displays "No Assessment Done"). In addition, the "Source Measurement Quality List" column contains XML that contains a list of measurements aggregated by condition/quality.

Maximum/Minimum Dates and Times

The [Get Interval Data](#), [Get Time of Use Mapped Usage](#), and [Vector and Service Quantity Math](#) usage calculation rules can be configured to identify the date/time of the maximum or minimum measurement value used when calculating the service quantity. For these functions, if "Max" or "Min" is selected as the "Calculation Function" (or the "Comax" and "Comin" functions for the "Vector and Service Quantity Math" rule), the date/time of the maximum/minimum value will be included in the resulting usage transaction and outbound message. The "SQ Highlight Date/Time List" column contains XML that contains a list of maximum/minimum date/times, based on condition/quality.

Usage Transaction Export Configuration

Usage transactions can also include additional information about its related meters and service points, as well as an indication if the service quantity is based on estimated usage. The "Usage Transaction Export Configuration" master configuration is used to control the export of this data. It holds the device and service point business objects used to supply meter and service point information included in the usage transaction and outbound message.

The "Usage Transaction Export Configuration" master configuration also defines the threshold percentage above which a service quantity being exported via the usage transaction outbound message is marked as an estimate. For example, if the "Estimation Threshold Percentage" is set to 35%, any service quantity being exported that was calculated from measurements containing more than 35% estimated usage is marked "estimated".

Service Quantities for Scalar Usage

Usage transactions and service quantities for scalar usage differ in some ways from those created from interval usage. For example, suppose a subscribing system requests usage for the month of January for a customer with a scalar meter that has been exchanged mid-month. In this case, the customer's usage is calculated by finding the scalar readings in the requested period (including all meter exchanges), and the subscribing system requires a record of all scalar readings AND a total of their consumption

Scalar rules cannot use date breaks because the system doesn't store interval values so it cannot accurately compute the amount in each period. In this case, scalar usage calculation rules retrieve scalar readings for the service points linked to the usage subscription, and then creates a single usage period for the usage transaction's entire calculation period. The individual scalar readings are captured as "scalar details" in the usage transaction.

To continue the example above, there would be 2 entries in the Scalar Details, one for each meter, and a single usage period that contains the total consumption for the entire calculation period. The tables below illustrate what this might look like.

Usage Estimation

When calculating usage for monthly read scalar meter, the end read may not be available by the end of the bill cycle window. If the request indicated that estimated measurement is allowed, the Get Scalar Details usage calculation rule creates an estimated end read that will be used to calculate the scalar usage.

Calculating Usage for Items

Usage transactions can also calculate usage for items installed at service points. Usage for items is calculated through use of [Get Item Counts and Consumption](#) usage calculation rule. This rules calculate usage based on the number of items installed at each service point and the average daily service quantity defined for each item's type. The specifics of how usage is calculated for items is based on the service point category (defined on the service point type) at which the items are installed (item or multi-item).

Hypothetical Calculations - Rate Comparisons

When Oracle Utilities Meter Data Management is integrated with Oracle Utilities Customer Self Service, customers can perform rate comparison calculations to see the impact to their usage and billing charges based on a set of user-defined usage adjustments. Rate comparison usage transactions are flagged "Hypothetical Calculation" in the **Calculation Mode** field.

Profile Accumulation Usage Calculation Rules and Usage Adjustment Profile Factors

Rate comparison usage transactions can be created through the use of [Profile Accumulation](#) usage calculation rule. This rule combine a service point's measurements with "usage adjustment" measurements derived from measurement data for profile measuring components defined as characteristic values for one or more profile factors.

Usage adjustment profile factors are associated to usage adjustment types defined in the Usage Adjustment Type extendable lookup and rates defined in the CC&B Rate Schedule extendable lookup (this association is defined in the Self-Service Master Configuration). When the usage transaction is created, the rate determines the usage calculation group to execute and usage adjustment profile factors to include in the calculation based on the CC&B Rate Schedule extendable lookup.

Note: The [Profile Accumulation](#) usage calculation rule should be configured with eligibility criteria such that they are only executed when the Calculation Mode for the usage transaction is set to "Hypothetical Calculation" (D2HC).

Including Summary Service Quantities and Interval Data Snapshots with Usage Transactions

Usage transactions can be configured to include summary service quantities and an interval data "snapshot" along with service quantities and other information sent to external systems. This used when sending usage to a billing system that performs interval-based pricing calculations.

Only usage transactions created (in whole or in part) by either the [Get Interval Data](#) or [Vector and Service Quantity Math](#) usage calculation rules can include interval data snapshot information. These rules use the **Extract Interval Data** flag to indicate ("Yes" or "No") if a "snapshot" of the interval data resulting from the usage calculation rule should be sent to external systems when usage from the usage transaction is sent to external systems.

In the base package, the Usage Transaction Outbound Message (D2-UsageTranOutboundMsg) business object is used to create outbound messages containing usage transactions. This business object includes the "Build Summary SQs" (D2-BLDSUMSQ) Pre-Processing algorithm which calculates and creates the interval data snapshot and other summary service quantities.

How Summary Service Quantities and the Interval Data Snapshot is Calculated

As noted above, the "Build Summary SQs" (D2-BLDSUMSQ) algorithm builds the Summary Usage Periods List based on the usage transaction's details. For every usage period within the usage transaction:

An entry is inserted into the summary service quantity list for every distinct UOM/TOU/ SQI combination in the usage period service quantity list.

An entry is inserted into the service point service quantity list for every distinct service point ID/UOM/TOU/SQI combination in the usage period service quantity list.

Interval data for multiple service quantities are combined into a single interval data curve per UOM/TOU/SQI combination. Intervals are summarized and scaled based on a common SPI

The "Build Summary SQs" (D2-BLDSUMSQ) algorithm uses the "Target Interval Size" parameter to define the interval size of the combined curve when one or more curves are combined with different interval sizes. For example, when combining interval data with 15 minutes intervals (SPI 900) and data with 60 minute intervals (SPI 3600), a Target Interval Size of 60 minutes (SPI of 3600) would result in combined data with an interval size of 3600 (the 15 minute intervals would be scaled up to 60 minute intervals before being combined with the 60 minute interval data).

Refer to [About Usage Calculation](#) for a broader functional view of the overall process. For information on how to configure the request and response process for Usage Transactions, reference the [Integrating Usage Transactions](#) section of the Admin Guide.

About Usage Validations

For the sake of keeping the volume of To Dos to a manageable level it may make sense to shift certain validations to the usage transaction process rather than the IMD load process. The validation should be done on a usage transaction when the result is only crucial for the systems receiving usage transactions rather than more real time needs such as online presentation to a customer. Below is a list of the usage calculation rules used for validating usage transactions that are provided as part of base product. To get more information on how each rule executes and can be configured, follow the link provided on the rule.

Usage Calculation Rule Name	Applicable Data Type(s)	Purpose
Usage High/Low Rule	Interval or Scalar	This validation rule compares the Service Quantities of the Usage Transaction to historical values. If the current value is too high or too low compared to historical data then an exception is thrown.
Validate Against Tolerance	Interval or Scalar	This usage calculation rule is used to validate the calculated usage against a tolerance value. The tolerance value may either come from the specified value or tolerance factor defined in the usage calculation rule.
Business Flag Hold	Interval or Scalar	This usage calculation rule can stop a usage transaction from proceeding when there have been business flags for the applicable service points. The hold can either be indefinite or set to expire a configurable amount of time prior to the calculation window ending.

Refer to [About Usage Transactions](#) or [About Usage Calculation](#) for additional functional information.

Reviewing and Resolving Usage Transactions

This portal is used to review and/or resolve a Usage Transaction.

Refer to [About Usage Transactions](#) or [About Usage Calculation](#) for additional functional information.

You can access the portal from the **Main > Usage > Usage Transaction**. You are brought to a query portal with options for searching. Once your record has been selected you are brought to the maintenance portal to view and maintain the selected record.

The following zones may appear as part of the portal's **Main** tab page:

- **Usage Transaction:** Defines basic information about the usage transaction, including usage period date ranges, date breaks within the usage period, scalar usage details, and usage quantity details.
- **Service Quantity Overlay:** Displays interval data for each service quantity for the usage transaction's usage period
- **Time of Use By Day:** Displays TOU-mapped interval data by day for the usage transaction's usage period

A number of important actions are available for a Usage Transaction depending on its status:

Action	Allowed Statuses	Details
Approve	Approval In Progress Issue Detected (only when the exceptions are marked to require approval)	Allows a user to bypass any exception or failure message for the Usage Transaction and attempt to send it to the requesting system.
Re-Calculate	Approval In Progress Issue Detected	Reruns the entire process of calculation along with any validations (all usage calculation rules) for the Usage Transaction.
Subsequent Correction	Sent	Allows a user to indicate that the usage transaction was corrected after being sent. Sets the status of the usage transaction to Subsequent Correction.
Resend	Send Error	Allows a user to re-send a usage transaction (via its related outbound message) to an external system. Used when an error occurs when sending usage transactions.

Triggering Adjustment Notifications

If any new Measurements are received from a device after that period has been calculated in a Usage Transaction then a discrepancy exists between Oracle Utilities Meter Data Management and the external system (often a customer information system or CIS). As a result, Oracle Utilities Meter Data Management provides a method to notify external systems of these adjustments to Usage Transactions. A **Usage Transaction Correction Processor** activity is created for each usage transaction that may have been impacted by an initial measurement. The **Usage Transaction Correction Monitor** batch (D1-UTCRN) is used to process these activities.

On the [External Application](#) for CIS, a processing method of "Usage Trans Subsequent Correction Notification" must be configured to specify the message that should be sent to notify CIS when an adjustment occurs for a Usage Transaction in Oracle Utilities Meter Data Management.

The IMD process handles the logic to look for existing Usage Transactions to determine if an adjustment will be required. The Usage Transaction will be moved to a "Subsequent Correction" status once this adjustment occurs.

Inventory of Other Usage Calculation Rules

Beyond validations and estimations usage calculation rules, the Usage Transaction process involves many other important rules that prepare and calculate Service Quantities. A list of these rules is provided below. For additional detail, follow the provided link that will take you to the Configuration Guide.

Pre-Calculation Usage Calculation Rules

Below is a list of the pre-calculation usage calculation rules provides as part of base product. For more information on how each rule executes and can be configured, follow the link provided on the rule.

Usage Calculation Rule Name	Applicable Data Type(s)	Purpose
Alignment and Delay Calculation Rule	Interval or Scalar (Frequently Read)	This rule can be used to handle two main needs: 1) aligns all measuring components for a Usage Subscription to the same date (whether on the same device or separate devices) 2) delays the usage transaction until the end of the retry window based on the quality of available data and other configured parameters
Check Existence of Installed Device	Interval or Scalar	This rule checks for the existence of a device installed on the Usage Subscription's Service Point for the usage period. In the case of multi-items this rule also checks that they are effective for the usage period.

Calculation Usage Calculation Rules

The following is a list of the calculation usage calculation rules provided as part of the base product. For more information on how each rule executes and can be configured, follow the link provided on the rule.

Usage Calculation Rule Name	Applicable Data Type(s)	Purpose
Apply Math (Interval Data)	Interval	This rule is used to perform calculations on interval data and stores the results in the usage transaction's service quantities. A variety of options are available on this rule that include defining the calculation type, variables to use, as well as the equation to use (math functions and expressions). This rule provides aggregated usage for all selected interval measuring components (filter by TOU, SQI & UOM) associated to a usage subscription. This rule can also multiply total usage by a factor using a custom formula.
Daily Scalar Usage Calculation Rule	Scalar	This rule is used to calculate usage of daily scalar measuring components installed in

the Service Points associated with a Usage Subscription for the specified usage period. It creates bill determinants by taking the difference between the beginning and ending reading for the bill period.

This rule can also be used to provide register readings by measuring component.

For consumption values, only the beginning and ending readings are exported

This rule supports date breaks (the normal Get Scalar Data rule does not).

[Get Interval Data](#)

Interval

This rule is used to get interval quantities from interval measuring components installed in the Service Points linked to the Usage Subscription for the specified 'Interval' usage period.

This rule retrieves the interval data for measuring components associated to a usage subscription by TOU, SQI and UOM.

This rule converts the interval data to another interval length or unit of measure.

[Get Item Counts and Consumption](#)

Scalar

This rule finds item-based and multi-item-based Service Points linked to the Usage Subscription for the current usage transaction, summarizes the item counts by item type and Service Point, and calculates item-based consumption.

[Get Scalar Details](#)

Scalar

This rule is used to get usage from scalar measuring components installed in the Service Points linked to the Usage Subscription for the specified 'Scalar' usage period.

This rule creates bill determinants by summing all scalar readings for the bill period. This rule can also be used to provide register readings by measuring component. All readings are exported by this rule.

Note: This rule is used for traditional monthly read meters.

[Get Subtractive Interval Details](#)

Subtractive Interval

This rule is used to get interval quantities from subtractive interval measuring components installed on the service points linked to the usage subscription for the specified 'interval' usage period.

It also identifies the start and stop readings for each usage period using subtractive interval readings.

[Get TOU Mapped Usage](#)

Interval

This rule is used to get time of use quantities from interval measuring components for devices installed at the Service Points linked

		to the Usage Subscription for the specified 'Interval' usage period.
Interval Tier Calculation	Interval	<p>This rule calculates the difference between a source and reference vector.</p> <p>This rule loops through each tier that is configured and calculates the imbalance amount associated to that tier level.</p> <p>This rule breaks down that difference into one to many positive or negative tiers, and create a service quantity for each tier calculated.</p>
Profile Accumulation	Interval or Scalar	This rule is used to manipulate a customer's interval data by adding other vectors to it. Those other vectors are derived from a list of profile factors and corresponding characteristic values stored in a list on the usage transaction.
Round and Adjust Usage	Interval or Scalar	This rule copies identified source and target Service Quantities and inserts these as Service Quantities that are rounded and adjusted.
Vector and Service Quantity Math	Interval	<p>This rule is designed to facilitate configuration of complex vector calculations. It is based on a series of underlying services with vectors configured as input to the calculations.</p> <p>Typical uses:</p> <ul style="list-style-type: none"> Perform math using interval data, e.g., take the difference between two curves, find max values, find coincident peaks, multiply a curve by a value, apply TOU maps, etc. Define complex formulas using various interval curves, profile factor values or calculated service quantities (bill determinant values). Support math functions: sin, cos, square root, etc. Store derived curves in memory that can be used in subsequent calculations <p>Please note, this rule is not as efficient as other rules.</p>

Decision-Making Usage Calculation Rules

There are usage calculation rules delivered as part of the base product that help with decision-making when executing running the usage calculation process. For more information on how each rule executes and can be configured, follow the link provided on the rule.

Usage Calculation Rule Name	Purpose
-----------------------------	---------

Execute Usage Calculation Group

This rule performs a call to execute a separate usage calculation group which includes execution of all usage calculation rules within that group.

Exception Handler

This rule evaluates the exception list that was accumulated during the execution of the calculation rules against exception criteria configured on this rule.

Usage Requests

Usage request records are created when bill determinants are requested during billing. The consumption information is then used to create a bill segment for the associated service agreement.

Refer to [The Big Picture of Usage Requests](#) for more details

Use **Menu > Usage > Usage Request** to open this page. When you select a usage request record, the maintenance portal opens and displays the associated information for the usage request record. You can also navigate to the maintenance portal from the [Bill Segment - Usage](#) page.

Refer the embedded help on this portal's zones for more information.

Usage Calculation Requests

About Usage Calculation Requests

Usage calculation request are calculations executed at a customer level where there may be more than one calculation per usage subscription. For example, a customer may have a usage subscription for producing billing determinants but there may be additional calculations that will be executed on a much less frequent basis (annually, quarterly, etc). More specifically, usage calculation requests are used to calculate service point quantities (see [About Service Point Quantities](#) for more information).

Usage calculation requests are defined by the following:

- **Usage Calculation Type:** The usage calculation type for the request. Usage calculation types define the service point quantity type and UOM/TOU/SQI for quantities calculated for requests of that type.
- **Start Date/Time:** The start of the date range for the request.
- **End Date/Time:** The end of the date range for the request.

Maintaining Usage Calculation Requests

You use the **Request** portal to view and maintain usage calculation requests.

Refer to [About Usage Calculation Requests](#) for additional functional information.

You can access the portal from the **Main > Usage > Usage Calculation Request**. You are brought to a query portal with options for searching. Once your record has been selected you are brought to the maintenance portal to view and maintain the selected record.

This portal includes the following zones:

- **Request:** defines the basic attributes of the usage calculation request

- **Request Log:** lists log activities for the usage calculation request

Usage Subscription Quantities

About Usage Subscription Quantities

Usage subscription quantities are quantities that are stored at the usage subscription level. These quantities are calculated at irregular frequencies (such as annually or quarterly) and thus do not make sense as a measured quantity on a device and measuring component. For example, in some deregulated markets the Peak Load Contribution could be stored here and effective dated over time to represent the changing contribution of a given usage subscription to the market wide coincidence peaks.

Usage subscription quantities are defined by the following:

- **Usage Subscription:** The usage subscription for which the quantities were calculated
- **Usage Subscription Quantity Type:** The Usage Subscription Quantity Type used for the record
- **Start Date / End Date:** The date range for the calculated quantity
- **Usage Subscription Quantities:** Calculated quantities based on **Quantity Identifiers** configured on the Usage Subscription Quantity Type (see [Understanding Usage Subscription Quantity Types](#) for more information)

NOTE: There cannot be more than one Usage Subscription Quantity for the same Usage Subscription and Usage Subscription Quantity Type, for the same time period (defined by the Start Date and End Date parameters).

Maintaining Usage Subscription Quantities

You use the **Usage Subscription Quantity** portal to view and maintain usage subscription quantities.

Refer to [About Usage Subscription Quantities](#) for additional functional information.

You can access the portal by selecting **Main**, then **Usage**, then **Usage Subscription Quantity**. You are brought to a query portal with options for searching. Once your record has been selected you are brought to the maintenance portal to view and maintain the selected record.

The following zones may appear as part of the portal's **Main** tab page:

- **Usage Subscription Quantity:** This zone displays the basic attributes of the usage subscription quantity

Time of Use Maps

About Time-of-use Processing

A type of rate used at many utilities is known as a "time of use" rate. For these rates, the price is based on when the usage occurs. For example, prices are typically higher during peak consumption periods (commonly referred to as "On Peak" periods) to encourage lower use during these times. The time range when a given price is applicable is known as a time-of-use (TOU) period.

Time of use periods can (and often do) change during the year. For example, in the summer, TOU periods might be defined as follows:

Time Of Use Period	Time Periods
--------------------	--------------

On Peak	8:00 AM - 9:00 PM Monday - Friday
Off Peak	12:00 AM - 8:00 AM Monday - Friday
	9:00 PM - 12:00 AM Monday - Friday
	12:00 AM - 12:00 AM Saturday, Sunday, and Holidays

While winter TOU periods might be defined as follows:

Time Of Use Period	Time Periods
On Peak	11:00 AM - 5:00 PM Monday - Friday
Off Peak	12:00 AM - 11:00 AM Monday - Friday
	5:00 PM - 12:00 AM Monday - Friday
	12:00 AM - 12:00 AM Saturday, Sunday, and Holidays

This is an example of a "simple" mass-market time-of-use schedule. Commercial and industrial schedules can be much more complex.

Generally speaking, there are two different types of meters that can be installed at service points that participate in TOU rates:

Scalar meters with dedicated registers for each TOU period. For this type of meter, the scalar measurements are the TOU consumption and no special derivation is necessary. The assumption is that the TOU schedule is programmed into the device and no TOU Map is required within Oracle Utilities Meter Data Management.

Interval meters that measure how much is consumed each interval. For this type of meter, the interval measurements are used to derive the consumption in each TOU period based on the TOU Map defined in Oracle Utilities Meter Data Management.

For information on configuration, reference the related section for [TOU Mapping](#) in the Administration Guide.

About TOU Maps

Interval consumption is mapped into time-of-use periods using a TOU map. TOU maps define the TOU periods for each interval. TOU map data is structured in a format very similar to final measurement data, with specified intervals of time each designated to a TOU period (instead of a measurement value). For example, the table below lists a set of TOU map data and corresponding final measurements for a period of 4 hours on January 1, 2010.

TOU Map	Measuring Component		
Date/Time	TOU Code	Date/Time	Consumption
1-Jan-10 3:00pm	ONPEAK	1-Jan-10 3:00pm	14.678
1-Jan-10 4:00pm	ONPEAK	1-Jan-10 4:00pm	29.12
1-Jan-10 5:00pm	ONPEAK	1-Jan-10 5:00pm	12.12
1-Jan-10 6:00pm	OFFPEAK	1-Jan-10 6:00pm	17.16

Any type of final measurement can be mapped to a TOU period, including derived quantities. While the principal requirement for TOU Maps is to aggregate interval consumption into TOU periods for a Usage Transaction, the system has many zones in the user interface that display interval consumption using TOU periods.

Maintaining TOU Maps

This portal is used to display and maintain a TOU Map.

Refer to [About TOU Maps](#) for additional functional information.

You can access the portal from **Menu > Usage > TOU Map**. You are brought to a query portal with options for searching. Once your record has been selected you are brought to the maintenance portal to view and maintain the selected record.

The following zones may appear as part of the portal's **Main** tab page:

- **TOU Map:** Defines basic information about the TOU map, including dynamic options
- **TOU Map Data List:** Lists TOU map data created from the TOU map

The **Time Of Use Map Data Generation Monitor** batch (D1-TOUTR) is used to generate TOU Map data automatically based on the [TOU Configuration](#). TOU Map data can also be generated manually through the TOU Map Portal in the UI.

Dynamic Options

About Dynamic Options

Dynamic Options specify terms that override how usage is normally calculated, such as a critical peak period that affects the TOU mapping of interval consumption.

There are circumstances and conditions during which the rules for creating TOU map data might need to be calculated differently than according to the utility's standard rules. Examples of this might include critical peak periods, curtailment requests or other demand response events. During these types of events, the TOU rules defined for a TOU map may be overridden. This is done through the use of dynamic options and dynamic option events.

Dynamic options allow flexibility for ad-hoc and special events that might impact how usage calculations are performed. For example, if a utility requests that its customers curtail their usage for a specific time period, a dynamic option and corresponding dynamic option event could be used to represent the curtailment request. During the time period of the curtailment request, usage might be calculated differently (with a different set of TOU periods, for example), which in turn might impact how the customer's bill is calculated.

Dynamic Options and TOU Maps

To apply a dynamic option (and one or more of its related dynamic option events), you reference the dynamic option on a TOU map, along with a corresponding "dynamic" TOU map to be used during the dynamic option event.

For example, with Critical Peak Periods you might add a new TOU period (called "Critical Peak"), and create a new TOU map that is the same as your standard TOU map, but that also includes your Critical Peak TOU period. For example, in the summer your new set of TOU periods might be defined as follows:

Time Of Use Period	Time Periods
Critical Peak	10:00 AM - 2:00 PM Monday - Friday
On Peak	8:00 AM - 10:00 AM Monday - Friday 2:00 PM - 9:00 PM Monday - Friday
Off Peak	12:00 AM - 8:00 AM Monday - Friday 9:00 PM - 12:00 AM Monday - Friday 12:00 AM - 12:00 AM Saturday, Sunday, and Holidays

If a dynamic option event occurs during a usage transaction period, the standard TOU map is overridden with the "dynamic" TOU map. In our example, a usage transaction period that includes August would use the dynamic TOU map when generating TOU map data for the time between 10:00 AM and 2:00 PM on August 2, but would use its standard TOU map for the rest of the month.

About Dynamic Option Events

Dynamic Option Events are specific periods of time during which a dynamic option is applicable.

There are circumstances and conditions during which the rules for creating [TOU map data](#) might need to be calculated differently than according to the utility's standard rules. Examples of this might include critical peak periods, curtailment requests or other demand response events. During these types of events, the TOU rules defined for a TOU map may be overridden. This is done through the use of dynamic options and dynamic option events.

A dynamic option may have many dynamic option events over time.

Maintaining Dynamic Options

This portal is used to display and maintain a Dynamic Option.

Refer to [About Dynamic Options](#) for additional functional information.

You can access the portal from the **Menu > Usage > Dynamic Option**. You are brought to a query portal with options for searching. Once your record has been selected you are brought to the maintenance portal to view and maintain the selected record.

The following zones may appear as part of the portal's **Main** tab page:

- **Dynamic Option:** defines the basic information about a Dynamic Option.
- **Dynamic Option Event List:** provides a list of the Dynamic Option Events that have been created for this Dynamic Option.

Maintaining Dynamic Option Events

This portal is used to display and maintain a Dynamic Option Event.

Refer to [About Dynamic Option Events](#) for additional functional information.

You can access the portal from **Menu > Usage > Dynamic Option Event**. You are brought to a query portal with options for searching. Once your record has been selected you are brought to the maintenance portal to view and maintain the selected record.

The following zone may appear as part of the portal's **Main** tab page:

- **Dynamic Option Event:** defines the basic information about a Dynamic Option Event.

Consumption Extract Requests

About Consumption Extract Requests

Consumption Extract Requests are created every time measurement or interval data is extracted for Oracle Utilities DataConnect or via Configurable Consumption Extracts. The consumption extract request can be created manually, typically to initiate an initial load type of extract, or created automatically, typically for an incremental type of extract, based on a configuration on the consumption extract type.

The Consumption Extract Request is responsible for submitting and monitoring the actual batch jobs that perform the data extract. In addition, it can be used to store any additional filters to further trim down data that will be extracted.

Refer to the [Oracle Utilities DataConnect](#) integration section in the *Administrative User Guide* for more details on how consumption extract requests are used with DataConnect.

Refer to [Configurable Consumption Extracts](#) in the *Administrative User Guide* for more information about how they are used with configurable consumption extracts.

Maintaining Consumption Extract Requests

This portal is used to display and maintain a Consumption Extract Requests.

Refer to [About Consumption Extract Requests](#) for additional functional information.

You can access the portal from **Menu > Usage > Consumption Extract Requests**. You are brought to a query portal with options for searching. Once your record has been selected you are brought to the maintenance portal to view and maintain the selected record.

The following zones may appear as part of the portal's **Main** tab page:

- **Request:** displays the main attributes of a Consumption Extract Request.
- **Request Log:** displays all log information related to the Consumption Extract Request.

Contacts

About Contacts

Contacts are individuals or business entities with which a company has contact. Service Points can have associated contacts which define the individual or business entity that uses the service (electricity, gas, water, etc.) delivered at the Service Point. A contact is optional for Service Points, but Usage Subscriptions must reference contacts.

Note: The base-package name search on the 360 Degree Search looks for Usage Subscription-related contacts. Use the Service Point Query portal to find a Service Point using a Service Point-related contact.

Maintaining Contacts

This portal is used to display and maintain a Contact.

Refer to [About Contacts](#) for additional functional information.

You can access the portal from **Menu > Usage > Contact**. You are brought to a query portal with options for searching. Once your record has been selected you are brought to the maintenance portal to view and maintain the selected record.

The following zones may appear as part of the portal's **Main** tab page:

- **Contact:** defines the basic attributes of the contact

360 Degree and Unified Search

Using 360 Degree Search

The 360 Degree Search feature allows users to search for devices, measuring components, service points, and/or usage subscriptions using a variety of search criteria.

From the search results list, you can navigate to the 360 Degree View portal to view data on one of the following tabs:

- Measuring Component
- Device

- Service point
- Usage Subscription
- Contact

When accessed, the 360 Degree View opens on the tab corresponding to the type of object (device, measuring component, etc.) you select. For example, if you click the Measuring Component description, the Measuring Component tab opens.

Refer to [360 Degree Views](#) for more details about 360 Degree View.

The following options are available for 360 Degree Search:

- **Search by Name:** Allows search by name/address OR contact identifier OR usage subscription identifier. To search by address, click Go To Search by Address. To search by device, click Device.
- **Search by Address:** Allows search by address/name OR service point identifier. To search by name, click Go To Search by Name. To search by device, click Device.
- Note: "Search by Address" search results contain service points with one or more active usage subscriptions only.
- **Search by Device:** Allows search by device identifier OR measuring component identifier. To search by name, click Go To Search by Name. To search by address, click Address.

Using Unified Search

The Unified Search feature allows you use the toolbar search field to search for business entities as well as search for menu items. See [Unified Search](#) in the [User Interface Standard Features](#) section for more information about the general use of the unified search field.

In Oracle Utilities Meter Data Management and Oracle Utilities Meter Solution Cloud Service, the Unified Search field allows searching by a service point's address (Address), a usage subscription's contact (Name), or a meter's badge number (Badge Number) or serial number (Serial Number).

You can use the following filters to indicate your specific search criteria:

Filter	Filter Rule
Address	One or more numeric characters followed by space and an alphanumeric character
Name	Minimum of 5 characters excluding whitespaces
Badge Number	Minimum of 5 characters excluding whitespaces
Serial Number	Minimum of 5 characters excluding whitespaces

For example, to search for a service point located at 1401 Flower Street, you could enter "1401 Flower".

To search explicitly using a specific filter, precede the filter value with one of the following predefined hints:

Filter	Hint	Example
Address	ad:	ad:1401 Flower
Name	n:	n:Smith, J
Badge Number	bn:	bn:12345
Serial Number	sn:	sn:6789

Examples:

- To search for a service point located at 1401 Flower Street, you could enter "ad:1401 Flower" (hint) or "1401 Flower" (no hint)
- To search for a person named John Smith, you could enter "n:Smith, J" (hint) or "Smith,J" (no hint)
- To search for a meter whose badge number is 12345, you could enter "bn:12345" (hint) or "12345" (no hint)
- To search for a meter whose serial number is 6789, you could enter "sn:6789" (hint) or "6789" (no hint)

Clicking the **Advanced Search** link opens the **360 Search by Device** portal and the **Search by Device** zone.

For more information about configuring the Unified Search for your implementation, refer to [Understanding Unified Search](#) in the *Administrative User Guide*.

Search Results

Each result in the search result list may include any of the following:

- Contact Info (highlighted when using the Name filter) or “No Contact Information”
- Service Point Info (highlighted when using the Address filter) or “No Service Point Information”
- Measuring Component Info (highlighted when using the Badge Number or Serial Number filter)
- Filter Name and Search Criteria (always displayed)

To select an item from the search results, click the result.

360 Degree Views

360 View Measuring Component

Using 360 Degree View Measuring Component

This portal is used to view a broad set of information related to a Measuring Component.

You can access the portal from the **Main > 360 Search > [options]**. You are provided with the option of searching by Name, Address, or Device. Once a Measuring Component has been selected you are brought to the 360 Degree View Measuring Component portal.

The following zones may appear as part of the portal's **Measuring Component** tab page:

- **Measuring Component Overview:** Displays the Service Point, device, Device Configuration, Install Event, and Usage Subscription for the selected device.
- **Device Configuration Overview:** Displays an overview of the measuring component's parent device's configurations over time, including the measuring components associated with each configuration, and Service Points (along with the relevant Install Events) at which the device's configurations have been installed over time, if any exist.
- To create a new reading for a scalar measuring component associated to a Device Configuration, click the **New Reading** link in the zone title bar.
- **Interval - Initial Measurement Overlay:** Overlays initial interval measurements (either pre-VEE or post-VEE) against the final measurements for a given period in graphic and tabular formats.
- **Final Values Overlay:** Graphs final measurements for a measuring component, and provides the ability to overlay the graphed data with final measurements from other measuring components. The zone also permits overlaying data from the same measuring component for different time periods, as well as data from measuring components that measuring different quantities, such as temperature.
- **Interval - Audit View:** Allows users to view an interval measurement curve for a given period overlaid with the count of audit records for each individual measurement. It also allows users to magnify a portion of the curve and see how the measurements looked at different points in time.
- **Time of Use By Day:** Displays daily TOU-mapped usage data for an interval measuring component based on a user-defined time period and TOU map.

- **Time of Use Overlay:** Displays an overlay of the TOU periods on a final interval measurement along with totalized TOU consumption based on a user-defined time period and TOU map.
- **Scalar - Initial Measurement Overlay:** Overlays initial scalar measurements (either pre-VEE or post-VEE) against the final measurements for a given period in graphic and tabular formats.
- **Scalar - Audit View:** Allows users to view a scalar measurement for a given period overlaid with the count of audit records for each individual measurement. It also allows users to magnify a portion of the measurement and see how the measurements looked at different points in time.
- **Measurements:** Displays measurement details for the current measuring component in a tabular format. (split into two zones for v2.2)
- **Usage Subscriptions Directly Linked to MC:** Displays Usage Subscriptions that are directly linked to current measuring component.

Functions are available in many of these zones that allow you to interact with the measurement data and/or create new data. For more information of these functions refer to the [Applying Measurement Functions](#) section.

Applying Measurement Functions

Many of the Interval measurement zones on the Measuring Component tab of the 360 Degree View provide access to the following functions:

- **Create Scratchpad:** Creates a scratchpad measuring component along with new initial measurement data by copying all or some of the final measurements from the measuring component displayed in the zone.
- **Create / Override:** Creates new initial measurement data for a selected measuring component for all or part of a selected time period. This function can either copy existing final measurements or create new measurement data for the initial measurement it creates.
- **Export to Excel:** Exports measurement data to a comma-separated values spreadsheet.
- **New Reading:** Creates a new interval initial measurement reading for the measuring component.
- **Rederive Values:** Rederives the measurement's values displayed in the zone.
- **Save As:** Creates new initial measurement data for a measuring component other than that being displayed by copying all or some of the final measurements shown in the zone.

Many of the Scalar measurement zones on the Measuring Component tab of the 360 Degree View provide access to the following functions:

- **Convert to Interval:** Converts scalar consumption into interval consumption. The converted consumption is held in a new scratchpad measuring component.
- **Create / Override:** Creates new initial measurement data for a selected measuring component for all or part of a selected time period. This function can either copy existing final measurements or create new measurement data into the initial measurement it creates
- **Export to Excel:** Exports measurement data to a comma-separated values spreadsheet.
- **New Reading:** Creates a new scalar initial measurement reading for the measuring component.
- **Rederive Scalar Values:** Rederives the measurement's values displayed in the zone.

360 Degree View Device

Using 360 Degree View Device

This portal is used to view a broad set of information related to a Device.

You can access the portal from the **Main > 360 Search > [options]**. You are provided with the option of searching by Name, Address, or Device. Once a Device has been selected you are brought to the 360 Degree View Device portal.

The following zones may appear as part of the portal's **Device** tab page:

- **Device Overview:** Displays the device, Service Point, Install Event, and Usage Subscription for the selected device.
- **Device Configuration Overview:** Displays an overview of the device's configurations over time, including the measuring components associated with each configuration, and Service Points (along with the relevant Install Events) at which the device's configurations have been installed.
- **Scalar Readings:** Displays a list of scalar readings for scalar measuring components associated with the current device and Device Configuration.
- To create a new reading for scalar measuring components associated with the Device Configuration, click **NewReading**.
- To edit an existing reading, click the edit icon for the reading you wish to edit. Editing a reading creates new initial measurements that are validated. If these edits do not pass validations, including VEE Rules, the changes are not saved.

360 Degree View Service Point

Using 360 Degree View Service Point

This portal is used to view a broad set of information related to a Service Point.

You can access the portal from the **Main > 360 Search > [options]**. You are provided with the option of searching by Name, Address, or Device. Once a Service Point has been selected you are brought to the 360 Degree View Service Point portal.

The following zones may appear as part of the portal's **Service Point** tab page:

- **Service Point Overview:** Displays the Service Point, device, Device Configuration, Install Event, and Usage Subscription for the selected Service Point.
- **Measuring Component Types:** Lists the measuring component types configured for the Service Point. To display consumption history for a measuring component, click the **Broadcast** icon next to the Measuring Component Type. Doing so will display either the Interval Consumption History or the Scalar Consumption History.
- **Interval Consumption History:** Displays a graph of interval consumption for a broadcast interval measuring component type.
- **Scalar Consumption History:** Displays a graph of scalar consumption for a broadcast scalar measuring component type.
- **Timeline:** Displays a timeline of events for the Service Point, including usage transactions, activities, and VEE exceptions. Each event is depicted as a button containing the date on which the event occurred. To search for a specific month and year in the Timeline zone, select the month and year from the drop-down lists and click the **Search** icon. To navigate forward and back along the timeline, use the left and right arrows.
- **Service Issue Monitors Related to SP:** displays a list of service issue monitors and related service investigative orders related to the current Service Point, in reverse chronological order.

360 Degree View Usage Subscription

Using 360 Degree View Usage Subscription

This portal is used to view a broad set of information related to a Usage Subscription.

You can access the portal from the **Main > 360 Search > [options]**. You are provided with the option of searching by Name, Address, or Device. Once a Usage Subscription has been selected you are brought to the 360 Degree View Usage Subscription portal.

The following zones may appear as part of the portal's **Usage Subscription** tab page:

- **Usage Subscription Overview:** Displays the Usage Subscription, main customer, Service Point, and direct channels for the selected Usage Subscription.
- **Usage Transaction History:** Lists usage transaction records for the Usage Subscription, including the start date/time, end date/time, description, and duration (in days) for each.
- **Timeline:** Displays a timeline of events for the Usage Subscription, including usage transactions, activities, and VEE exceptions. Each event is depicted as a button containing the date on which the event occurred. To search for a specific month and year in the Timeline zone, select the month and year from the drop-down lists and click the **Search** icon. To navigate forward and back along the timeline, use the left and right arrows.

360 Degree View Contact

Using 360 Degree View Contact

This portal is used to view a broad set of information related to a Contact.

You can access the portal from the **Main > 360 Search > [options]**. You are provided with the option of searching by Name, Address, or Device. Once a Contact has been selected you are brought to the 360 Degree View Contact portal.

The following zones may appear as part of the portal's **Contact** tab page:

- **Contact Overview:** Displays contact information (name, phone number, email address, etc.) for the selected contact.
- **Contact's Service Points:** Lists the Service Points related to the contact, including the relationship type (main contact, main customer, etc.) for each.
- **Contact's Usage Subscriptions:** Lists the Usage Subscriptions related to the contact, including the relationship type (main contact, main customer, etc.) for each.

Service Orders

In this section, we describe how to manage the fieldwork that takes place at your premise's service points.

About Service Order Activities

Service order activities represent specific service order requests either received from an external system or created from within Oracle Utilities Smart Grid Gateway.

Service order activities are created when specific types of requests for service are received in the system. These activities orchestrate the steps necessary to fulfill the request, based on the current state of the service point related to the request. For example, the system creates an "enable service" activity when a request is made to enable service at a particular service point. This activity examines the current state of the service point, and creates one or more additional activities if appropriate. For example:

- If there is no meter currently installed at the service point, the service order activity would create an "install meter" service order field activity and send it to a field work system.
- If there is a meter installed, but the meter is not currently registered with the head end system, the service order activity might create a "commission meter" smart meter command.
- If the meter is active and commissioned, but not currently connected, the service order activity might create a "remote connect" smart meter command.
- Etc.

Service order requests are typically received from the customer information system such as Oracle Utilities Customer Care and Billing, but can also be created from within Oracle Utilities Meter Data Management or Oracle Utilities Smart Grid Gateway.

The base package provides the following types of service order orchestration activities:

- **Enable Service:** Used to enable service at a service point.
- **Disable Service:** Used to disable service at a service point.
- **Cut for Non-Payment:** Used to cut off service at a service point due to non-payment of past due amounts.
- **Reconnect Service for Payment:** Used to restore service at a service point after receipt of past due payment.
- **Exchange Meter:** Used to orchestrate the exchange of meters at service point, such as in the event that a customer upgrades their meter.
- **Back to Back Service:** Used to orchestrate a change of service when the customer at a service point changes (such as when owners/tenants change).

Service order orchestration activities are defined by the following:

- **Activity Type:** The service order's activity type.
- **Service Date/Time:** The date and time the service order request was received.
- **Service Point:** The service point associated with the service order request.
- **Service Agreements:** A list of one or more service agreements related to the service order request (not used with all service order orchestration activities).
- **Request Information:** Details of the service order request, including requester and external system information.
- **Collection Data Details:** Details regarding past due balances (used with Cut for Non-Payment activities only).
- **Contact Details (or Customer Information):** Contact details for the customer associated with the service order request.

Note: Some service order activities use additional data.

In the event that an active service order activity needs to be updated and/or cancelled, the system also supports the following maintenance service order activities:

- **Cancel Orchestration:** Used to cancel a currently active service order activity.
- **Update Orchestration:** Used to update a currently active service order activity.

Service order maintenance activities are defined by the following:

Activity Type: The service order's activity type.

Orchestration Activity: The original orchestration activity related to the maintenance activity.

Related Activity: A specific activity (such as a service order field activity or smart meter command) related to the maintenance activity.

Cancel Reason: The reason for cancelling the original activity (for cancel activities only).

Comments/Instructions: Specific comments and/or instructions applicable to the maintenance activity (for update activities only).

Start Date/Time: The date and time the maintenance activity was initiated (for update activities only).

Request Information: Details of the service order request, including requester and external system information.

Activity Hierarchy: A tree that displays the activity and related activities (including service order field activities and smart meter commands), inbound and outbound communications, and completion events.

How Are Service Order Activities Created?

Service order activities are typically created due to a field activity request as follows:

- Starting or stopping service indirectly causes field activity requests to be created. These field activity requests initiate the service orders to orchestrate the actions necessary to connect or disconnect service. Refer to [Starting Service and Field Activities](#) for more information about how field activity requests are created to start and stop service.

NOTE: If you use the Order transaction to start service, field activity requests will also be created in the same manner described under the Starting Service and Field Activity Requests discussion

- The activation of a severance event with fieldwork causes field activity requests to be generated to disconnect or reconnect service. For more information about severance events and field activity requests, refer to [The Big Picture Of Severance Events](#).

Service order activities can also be created due to a request received from an external system or created directly within Oracle Utilities Smart Grid Gateway.

About Service Order Field Activities

Service order field activities are specific types of tasks performed by field personnel. Examples include installing meters, repairing/replacing meters, etc.

Service order field activities are created when completing specific types of requests for service requires field work. Once created, service order field activities are sent to a field work system, where they are scheduled and assigned to a field work crew. When the task is completed by the crew, the field work system sends a response to the system and the service order field activity is updated as appropriate.

When communicating with field work systems, service order field activities create outbound communications to send the required information to the field work system. When the field work system sends its response, the system creates an inbound communication. See [About Communications](#) for more information about communications. Service order field activities that have created outbound communications can also be manually completed or canceled if necessary.

Service order field activities are created when a service order orchestration activity examines the current state of the service point, and determines that field work is required to complete the service request. For example, if an "enable service" activity determines that there is no meter currently installed at the service point, the service order activity would create an "install meter" service order field activity and send it to a field work system.

Service order field activities are defined by the following:

- **Activity Type:** The service order field activity type.
- **Status:** The current status of the service order field activity.
- **Service Date/Time:** The date and time the service order field activity was created.
- **Service Point:** The service point associated with the service order field activity.
- **Field Task Type:** The field task type for the service order field activity. The list of available field task types can be filtered based on the **Valid Field Task Types** defined for the service point's service point type via the **Restrict Field Task Type by Service Point Type** option on the Service Order Management Master Configuration.
- **Recipient:** The service provider to which the service order field activity is sent for scheduling and assignment.
- **Device:** The device related to the service order field activity (if applicable).
- **Request Information:** Details of the service order request, including requester and external system information.
- **Contact Details (or Customer Information):** Contact details for the customer associated with the service order request.
- **Address Information:** The address of the service point associated with the service order field activity.

What Happens After A Field Activity Is Completed?

When a service order activity completes, if there is a related field activity request this will also be completed. Completing a field activity request that is linked to a pending start service agreement, will also automatically activate the service agreement. Similar, completing a field activity request linked to pending stop service agreements will stop the associated service agreement.

After a field activity that is linked to a severance event is completed, the severance event becomes complete. This, in turn, triggers the activation of the next event.

FASTPATH:

For more information about field activities linked to pending starts, refer to [Starting Service and Field Activities](#).

For more information about field activities linked to pending stops, refer to [Stopping Service and Field Activities](#).

For more information about severance events and field activities, refer to [The Big Picture of Severance Events](#).

About Appointments

The Appointment Booking portal is used to request and track appointments related to service order field activities that have been scheduled in an external field work scheduling system.

When service order field activities send outbound communications to the field work system, appointments are created in field work system so that the work can be assigned to a crew. Requests for appointments are most often requested automatically when the service order field activity is created, but if needed, users can request appointments manually.

Users work with the Appointment Query portal to search for activities and related appointments.

Users work with the Appointment Booking to request and track appointments for service order field activities. This portal includes the following zones:

- **Service Point Activities:** Displays a list of activities and related appointments for the current service point in date descending order. This zone also includes a filter area which allows the user to define the inclusion or exclusion of activities according to certain criteria
- **Activity Summary:** Displays details of a selected activity in the Service Point Activities zone (indicated by a star).
- **Appointment Booking Results:** Displays a list of available appointment slots as returned by the scheduler. This zone allows the user to book an appointment by selecting a slot and subsequently updating the orchestration or field activity.

Field Activity Maintenance

A field activity request is a request to perform actions at a service point. Examples of field activity requests include start service, stop service, and start/stop.

The topics in this section describe the pages on which field activity request-related information is maintained.

Lifecycle of a Field Activity

The following diagram illustrates the lifecycle of a field activity.

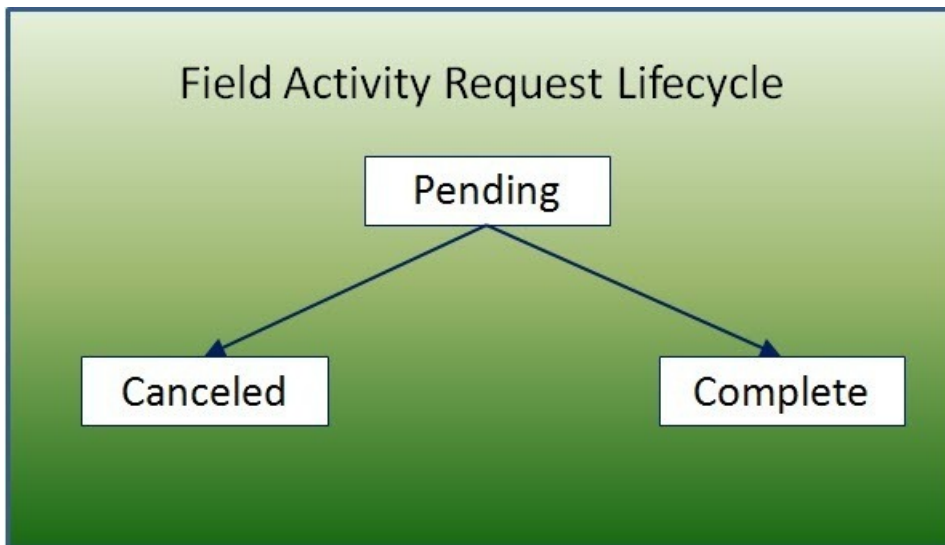

Pending: A field activity starts its life in the Pending state.

Complete: After the related actions have been performed, the system is updated to reflect what happened and the field activity request becomes complete. No changes may be made to a Complete field activity request.

Canceled: A Pending field activity request may be Canceled..

Field Activity - Main Information

The Main page contains core field activity information.

Description of Page

The following fields are displayed on every page.

Field Activity is a concatenation of summary information regarding this field activity request.

Field Activity ID is the system-generated unique identifier for the field activity request.

The remaining fields are specific to the Main page.

Indicate the **Service Point ID** where the activity takes place. Information about the service point is displayed adjacent.

Use **Activity Type** to define the type of field activity request. Only those activity types defined as valid for the service point's SP type's field activity profile may be selected. The activity type's description is displayed adjacent.

Displayed just below the **Activity Type** is a system-generated message regarding how the field activity request was created. This message includes the date and time the field activity request was created and the process that created it. If a user manually creates a field activity request the user's ID is concatenated into the message.

Use **Schedule Date / Time** to define when the field activity is scheduled to be done.

Enter **Reschedule Reason** when changing the field activity's schedule date/time.

NOTE:

Reschedule Reason only appears if the **Fieldwork Options** feature configuration exists with the **Reschedule Reason Required** option set to Y.

Field Activity Status defines the state of the field activity. The following values may exist:

- **Pending** A field activity is originally created in the Pending state.
- **Completed** When an activity's fieldwork is done the system is updated with the results and the activity becomes Completed.
- **Canceled** If an activity cannot be done, it should be Canceled.

To change the status of the field activity request, use the **FA Actions**, described below.

If you cancel a field activity, you must supply a **Cancel Reason Code**.

Field Activity Priority this field is not used when using Service Order Management.

Use **Comments** to describe anything unusual about the activity.

If you have plugged in an FA Additional Information algorithm on the [Installation](#) record, **Additional Info** displays the results of the algorithm, if any.

The **FA Actions** buttons allow you to change the status of the field activity request.

- Click **Complete** to change the status of the field activity to complete. This button is only enabled if the status is pending.
- Click **Cancel** to change the status of the field activity to canceled. This button is only enabled if the status is pending.

NOTE: **Pend** and **Held** are not applicable for service order related field activity requests.

At the bottom of this page is a [tree](#) that shows the account(s) and service agreement(s) that are currently linked to the field activity request's service point. You can use this tree to both view high-level information about these objects and to transfer to the respective page in which an object is maintained. Note that only field activities created by start/stop or severance create the link between the service point and service agreement.

Field Activity - Steps

The Steps page is not applicable for service order related field activity requests.

Field Activity - Characteristics/Remarks

Use this page to link additional information to the field activity requests.

Description of Page

Summary information about the **Service Point** where the activity will occur is displayed, as well as the service point's system-generated **Service Point ID**.

The **Characteristics** collection contains information that describes miscellaneous information about the field activity request.

To modify a characteristic, simply move to a field and change its value. To add a new characteristic, click the plus button to insert a row, then fill in the information for each field. The following fields display:

- **Characteristic Type** Indicates the type of characteristic.
- **Characteristic Value** Indicates the value of the characteristic.

NOTE:

Default Note. A field activity's characteristics default from the [field activity type](#).

Typically fieldwork related remarks are processed by service order field activities and if applicable a service task. In addition remarks can be added to the **Remarks** grid.

The **Field Activity Remark Status** is only relevant if a **Field Activity Remark** code has algorithms associated with it. The execution of the algorithm is performed by the field activity remark activation a background process (**FACT**).

- When you add a remark that has an algorithm, the status is Pending . It remains in this state until the FACT process next runs.
- When the FACT process next runs, if the system is successful in executing the algorithm, the status of the field activity remark may become Complete. If the system is not successful in executing the algorithm, the status becomes Error.

Field Activity - Field Activity Portal

The Field Activity Portal page displays additional information associated with a field activity request.

Depending on your implementations requirements, you may define additional zones to appear on this Portal.

The contents of this section describe the zones that are available on this portal page.

General Information

Field Activity ID, **Field Activity Info** are displayed.

Service Order Management Information

This zone displays the related service order activities in Service Order Management.

- Clicking a service order activity's information navigates to the Service Order Management Activity Maintenance Portal.
- If the field activity requires appointment, formatted information, indicating that appointment must be booked, appears on top of the field activity tree. Clicking "Book Appointment Now", navigates to Service Order Management application's Appointment Booking Portal.

Field Activity Attachments

This zone provides the ability to add, edit, delete, upload, and view attachments related to field activity request.

- Clicking attachment information navigates to Attachment Maintenance Portal.

Field Activity - Log

Use this page to view and add log records for a field activity request.

Description of Page

The **Log** grid displays log entries that audit the progress of a field activity. You cannot modify or delete log entries that have been created by the system.

You can manually add a log entry of type User.

The Log grid displays the following information:

- **Date/Time** Displays the date and time when the log entry was created.
- **Log Type** Indicates the entry event for which the log entry was created. The log type for log entries created online is User.

NOTE:

The values for the log type are customizable using the Lookup table. This field name is FA_LOG_TYP_FLG.

Details Contains user-specified or system-generated information about the log entry.

User Displays the user who caused the log entry to be created.

Sequence Displays the sequence that makes up part of the unique identifier of this log record (together with the Field Activity ID).

Outage Calls

NOTE:

The information in this section applies to the integration with the Oracle Utilities Network Management System (NMS).

You can use the Outage Call page to view trouble calls and outage information, and to send outage call reports to NMS for a specific service point. You can also use this page to schedule job site appointments. Open this page using **Menu > Communication > Outage Call > Search**.

Description of Page

The Outage Call Search zone is a standard [multi-query portal](#) used to search for and list existing Outage Call records. In the search results list, click the Outage Call link to view and maintain the information about the outage call.

Outage Call Zone

The outage call zone contains display-only information about the record.

Outage Information

NOTE:

The information in this section applies to the integration with Oracle Utilities Network Management System (NMS).

The Outage Information portals provide a real-time interface with NMS to search for the following network management items:

- Job History

- Call History
- Planned Outages.

Open this page using **Menu > Communication > Outage Information.**

Job History

You can use the Job History portal to retrieve current and historical outage and non-outage jobs from NMS by a customer service point or account ID, or proximity to a street intersection or street segment, or other identifiers such as a 911 incident identifier, caller name, or call phone number.

Description of Page

The Job History zone can be used to search for an existing Job History record. If the search results list contains records for a single service point, the service information for that service point and the job history results will be displayed. If the list contains multiple service point's records, a list of service points are displayed and the service information and job history results will be displayed for one of these service points.

Please see the zone's help text for information about this zone's fields.

Call History

You can use the Call History portal to retrieve trouble call history from NMS by a customer service point, or account id, or proximity to a street intersection or street segment, or other identifiers such as a 911 incident identifier, caller name or call phone number.

Description of Page

The Call History zone can be used to search for an existing Call History record. If the search results list contains records for a single service point, the service information for that service point and the call history results will be displayed. If the list contains multiple service point's records, a list of service points are displayed and the service information and call history results will be displayed for one of these service points.

Please see the zone's help text for information about this zone's fields.

Planned Outages

You can use the Planned Outages portal to retrieve planned outage information from NMS.

Description of Page

The Planned Outages zone can be used to search for current, future and past planned outage status and details from NMS for a particular service point. Planned outage information will only be available once a planned outage has been scheduled and the list of impacted customers for that planned outage has been generated.

Please see the zone's help text for information about this zone's fields.

Service Calls

NOTE:

The information in this section applies to the integration with an asset management system, such as Oracle Utilities Work and Asset Management (WAM).

The following sections describe the Service Call Process and Service Call Communication.

The Service Call Process and Service Call Communication

Service Call Process

The service call process contains five steps or panels:

Service Call Search. This panel is used input the contact details of the service call.

At least one filter should be populated before search can be performed.

The result is a combination of the following:

- Service calls in the asset system retrieved via a real-time call.
- Local non-final service calls that were not sent to the asset system yet.

By default, the maximum number of search results is **20**. This can be overridden by setting the override search limit in the service call communication type.

The service call information includes the service call number, issue description, required by date and call back indicator. Service call number is the service call's reference number in the asset management system.

NOTE: The details of a service call can be viewed using the **View Service Call Details** icon. This pops up a window with the details of the service call. Details of service calls in the asset management system are retrieved via real-time call and includes communication logs and related documents. For authorized users, hyperlink to the service call in the asset management system is available. Refer to [Setting Up the System To Enable Asset Management System Integration](#) for more details.

When a service call is selected, either **Add Comment** or **Cancel** action should be selected to continue.

Continuing without selecting a service call means a new service call.

Location. This panel is used to input or display the location of a new or existing service call, respectively. For an existing service call, the location details are displayed for information purposes.

When the process is initiated with a premise in context, the premise is displayed and can be used to populate the location elements and limit the service points that can be selected. If the current premise is used, the location elements are populated and disabled. The geographic type defined in the service call communication type is used to populate the latitude and longitude elements based on the premise's geographic data.

When service point is set, the location elements are populated with the corresponding elements of the service point's premise and are disabled. Clearing the service point will re-enable the location detail elements with their values retained. The geographic type defined in the service call communication type is used to populate the latitude and longitude elements based on the premise's geographic data.

Country and address should be populated to continue.

Contact. This panel is used input the contact details of the service call.

Communication type is defaulted to the default communication type defined in the service call communication type.

When the process is initiated with a person in context, the person is displayed and can be used to populate the name and phone numbers. If the current person is used, the name and phone number elements are populated and disabled:

- First and last names are derived from the person's primary name. Note that installation option's name separator configuration applies.

- Primary phone is set to the person's primary phone contact
- Mobile and home phones are set to the person's phone contact where the contact type is the mobile and home phone contact types defined in the service call communication type, respectively.

Contact details are not required to continue. **For Add Comment or Cancel** actions, either First Name or Last Name or one of the phone numbers must be provided.

Details. This panel is used to capture the issue details of the service call.

For a new service call, enter the details of the issue. Questions linked to the selected service code are presented. Set the resolved switch if based on the answers to the questions, the issue is resolved. Doing so will prevent a message from being sent to the asset system.

Description is required to continue. Service Code may also be required if configured as such in the service call communication type.

For **Add Comment** or **Cancel** action, details of the original service call are displayed for informational purposes.

Review and Submit. This panel provides an opportunity to review the information before submission.

When the service call process is finished, the service call information is copied to a new service call communication record and the service call communication ID is displayed on the Review and Submit panel. If there are questions linked to the service code, the questions and answers are copied to a new response record. The response is linked to the service call communication. The service call process is completed and service call communication takes over.

Service Call Communication

Service call communications are used to and process service call information gathered from interactions with the customer, the public or other external entity. These interactions can be reporting a new issue/request, adding comments to an existing issue/request or cancelation (issue is resolved or request no longer needed). The following service call information can be gathered:

- **Issue/Request Details.** This includes description, service category, service code, call back requirement, require by date, etc.
- **Location.** This is the location of the service call. This can be either a known service point or a freeform address
- **Contact.** This is the contact information the interaction is with. This can be a known customer or freeform contact information. This is information is optional to allow anonymous interactions.

A service call communication record is created for each interaction.

- Determine if a service call information needs to be sent to the asset management system. If the service call process is canceled or if the issue was resolved during communication, the asset management system is not notified.
- Ensure that service call information is sent out to the asset management system in the correct sequence. New service call communication is sent out first, followed by additional comments and finally, cancelation.
- Send a service call communication outbound message to the asset management system. This is an asynchronous interface between Oracle Utilities Customer Care and Billing and the asset management system. Because this asynchronous, there should be no processing after the message is sent out in the same transaction. This is to avoid the case where the transaction is rolled back due to some error, but the message is already sent to the external system. Refer to [Setting Up the System To Enable Asset Management System Integration](#) for more details.
- Once the outbound message is sent, the service call communication will transition and stay in the Sent state until an acknowledgement is received from the asset management system. If a positive acknowledgment is received, the service call communication is completed. If a negative acknowledgment is received, the service call communication is transitioned to the Error state. A service call communication in Error state can be manually canceled or re-sent.

Service Call Communication Acknowledgement

The inbound web service *CI-UpdateServiceCallCommunication* is used to process a service call communication acknowledgement message. The message contains communication ID, service call ID, service call number and error information. This service stores this information into the service call communication. If the message indicates an error, the service call communication is transitioned to the Error state. Otherwise, the service call communication is completed.

Maintaining Service Call Communications

A service call communications is used to process service call information gathered from interactions with the customer, the public or other external entity. These interactions can be reporting a new issue/request, adding comments to an existing issue/request or cancelation (issue is resolved or request no longer needed). Refer to [Service Calls](#) for background information on service calls.

To view and maintain service call communications, open Menu > Field Order > Service Call Communication > Search . You are brought to a query portal with options for searching for service call communications.

Once a service call communication record has been selected, you are brought to the maintenance portal to view and maintain the selected record.

The following zones are displayed:

- **Service Call Communication** zone shows the details of the service call .
- **Questions** zone shows the related questions and answers to the service call communication. This information is stored in the *Response* object.

Refer to the zones' embedded help for more information.

Billing

In this section, we describe how to manage your customer's bills.

The Big Picture of Billing

A bill is used to communicate changes in an account's financial obligations to the customer. Over time, a customer receives many bills. The topics in this section provide background information about a variety of billing topics.

WARNING:

Some organizations are responsible for presenting 3 rd party charges on their bills. Others are responsible for sending their charges to a 3 rd party for presentation on their bills. If this describes your organization, refer [The Big Picture of SA Relationships](#) for a description of how this functionality is implemented.

An Illustration Of A Simple Bill

The following diagram illustrates a simple bill:

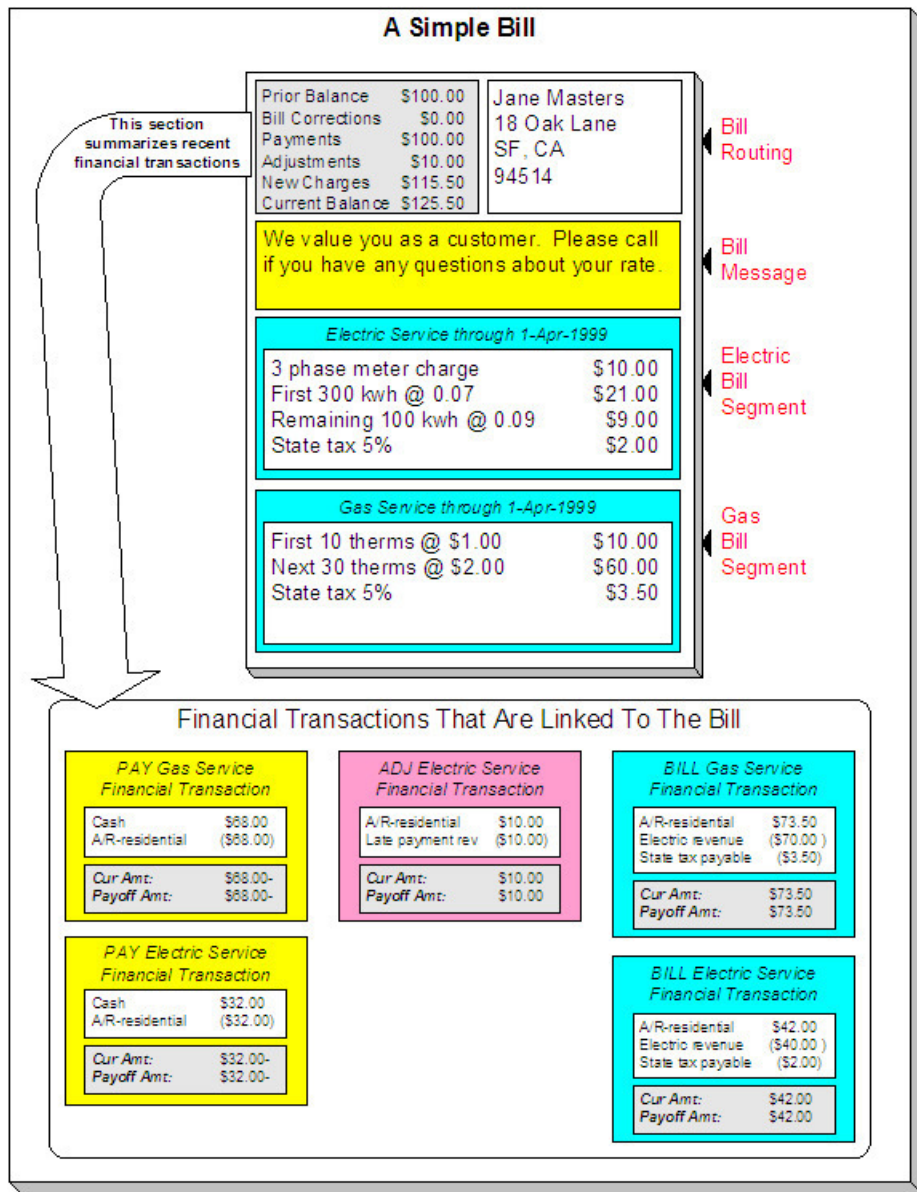

The following concepts are illustrated above:

A bill is produced for an account A bill is produced for an account. Over time, an account receives many bills.

A bill summarizes financial transactions A bill contains information about the various financial transactions that have taken place since the last bill was produced (i.e., payments, adjustments, and bill corrections). The above illustration shows a bill with financial transactions for new charges, a payment, and an adjustment.

A bill is routed to persons A copy of the bill is sent to every person linked to the account who requires a copy of the bill.

A bill contains messages A bill may contain messages.

A bill typically contains bill segments A bill typically contains one bill segment for every active service agreement linked to its account.

A bill segment contains calculation details A bill segment contains information showing how the segment was calculated and how it should be printed on the customer's bill.

An Overview of the Bill Creation Process

When the system is asked to produce a bill for an account, it attempts to create one or more bill segments for every non-cancelled / non-closed service agreement linked to the account. Whether or not a service agreement contributes bill segment(s) to a bill is a complicated subject as the system supports a wide variety of bill segment creation methods. For example, a service agreement that charges for metered service is produced as follows:

- The system first requests for the amount or usage consumed (or billing determinants) from Oracle Utilities Meter Data Management; for example, the number of lamps, the number of gallons of water, or the peak kW. For more information, refer to [How the System Requests How Much Was Consumed](#).
- Next, the system applies the service agreement's rate to the amount consumed in order to calculate how much the customer owes. A bill segment and a financial transaction are generated to reflect the results of this calculation. The details of the calculations are captured in the bill calculation lines. For more information, refer to [How Rates Affect The Information On Bill Segments](#) for the details. Refer to [Effective Dates and Price Proration](#) for information about how the system prorates changes to rates and prices during a bill period.

NOTE:

There are many bill segment creation algorithms. The above points explain how a bill segment is produced for a bill determinants required service agreement. It's important to be aware that the system has other bill segment creation algorithms. For example, if the service agreement charges for a deposit, the system neither amalgamates consumption nor does it apply a rate. You may be wondering how the system knows which method to use. It uses the bill segment type on the service agreement's SA type. Refer to [Designing and Defining Bill Segment Types](#) for a description of the various bill segment creation algorithms that are supported in the system.

If errors are detected during the bill segment creation process, the bill segment is saved with its error. The system then proceeds to the account's next service agreement. This way, a user can see all problematic bill segments so they can be corrected en masse. Refer to [Bill Errors](#) for information about how to deal with bill errors.

NOTE:

Interdependent service agreements. Your organization may have some service agreements whose charges must be calculated in a specific order. For example, you might have a service agreement whose bill segments are calculated using charges from a different bill segment. If this describes your organization, be aware that the system creates the bill segments in the order of the [billing processing sequence](#) on each service agreement's SA type.

When every segment on a bill is error free, the bill is ready to be completed. When a bill is completed, the system:

- Creates a bill routing for each person linked to the account who requires a copy of the bill. The routing information controls the format of the printed bill and how the bill is sent to the person. Refer to [The Source Of Bill Routing Information](#) for the details.
- Links all bill messages to the bill. A bill message can come from a variety of sources. Refer to [The Source Of Bill Messages](#) for the details.
- If the Freeze At Bill Completion [installation option](#) has been turned on:
 - All freezable bill segments will be frozen.
 - All freezable adjustments whose adjustment type indicates Freeze At Bill Completion will be frozen.
- Sweeps recent financial transactions that have been created since the last bill was completed. Refer to [Financial Transactions Created Between Bills](#) for information about how payments, adjustments and bill corrections appear on a bill.

- There are several other functions that happen at completion time. Refer to the description of the Complete button under [Bill Lifecycle](#) for the details.

And that's it; the bill can now be sent to the customer.

The remaining topics in this section provide more information about the creation and completion of bills.

NOTE:

Batch and real-time bill creation. Anything the batch bill process does for whole sets of accounts, you can do to a specific account on-line / real time. Refer to [How To Create A Bill For All Service Agreements Linked To An Account](#) for information about how to create a bill on-line / real time. Refer to [Batch Billing](#) for more information about the batch bill creation process.

Bill Errors

The topics in this section describe errors that are detected when the system creates a bill.

Bill Segment Errors

If you consider the huge number of variables involved in the creation of a bill segment, it probably won't surprise you to learn that occasionally, some bill segments are in error.

Errors tend to be caused by missing or inconsistent data. Some examples of classic errors:

- **Missing master data.** For example, if a bill is supposed to be routed to the account's mailing address and the account doesn't have such an address, an error is generated.
- **Missing rate data.** For example, if a rate contains a customer specific charge and there is no value defined on the customer's service agreement, an error is generated.

The system saves bill segments that are in error just as it saves bill segments that are error-free. This is done because bill segments are nothing more than a snapshot of the data that was used to calculate the charges. By saving the snapshot, you can see the information the system used when it detected the error and therefore more effectively fix the cause of the error. The standard way to fix an error is to:

- Look at the bill segment to determine the cause of the error.
- Correct the cause of the error.
- Regenerate the bill segment. Regeneration simply deletes the offending segment and recreates a new segment using the corrected information.

For every bill segment in error, a record is written to the [Bill Segment Exception](#) table.

FASTPATH:

Refer to [How To Correct A Bill Segment That's In Error](#) for instructions describing how to correct a bill segment.

It's obvious but worth stressing that a bill may contain some segments that are perfect and others that are in error. Once all segments that are in error are corrected, the bill can be completed (and sent to the customer).

If the bill segment in error was created as part of the batch bill process, the system attempts to fix the offending segment(s) each night during the account's bill window by regenerating it. Therefore, if the cause of the error is fixed during the day, the system will automatically regenerate the bill segment when batch billing next runs; you don't have to manually correct each bill. And once a bill is error-free, it will be completed and sent to the customer.

FASTPATH:

Refer to [Batch Billing](#) for more information.

Bill Completion Errors

In addition to errors on bill segments, there may also be errors detected when the system attempts to complete a bill. For example, if the system cannot find a mailing address, the bill will be in error (as opposed to one of its bill segments).

Errors tend to be caused by missing or inconsistent data. Some examples of classic errors:

- **Missing mailing address.** For example, if the system cannot find an address to which the bill can be routed, it generates an error.
- **Bill segments are in error.** If a bill contains bill segments that are in error, it cannot be completed and an error is generated.

The system saves bills that are in error just as it saves bills that are error-free. This is done because bills are nothing more than a snapshot of the data that was used to calculate the charges. By saving the snapshot, you can see the information the system used when it detected the error and therefore more effectively fix the cause of the error. The standard way to fix an error is to:

- Look at the bill to determine the cause of the error.
- Correct the cause of the error.
- Recomplete the bill.

For every bill in error, a record is written to the [Bill Exception](#) table.

FASTPATH:

Refer to [How To Correct A Bill That's In Error](#) for more information.

If the bill completion error was created as part of the batch bill process, the system attempts to recomplete the bill each night during the account's bill window. Therefore, if the cause of the error is fixed during the day, the system will automatically complete the bill when batch billing next runs; you don't have to manually complete each bill.

FASTPATH:

Refer to [Batch Billing](#) for more information.

Cancel / Rebill Incorrect Bill Segments

Sometimes the error on a bill segment is not detected by the system. Such errors occur when the data used to calculate the bill is valid, but wrong. For example, the dial reading on the meter read is incorrect due to slipped fingers, or the sales tax percent was entered incorrectly on a bill factor.

There is no way the system can detect such problems and therefore the system freezes the bill segment and routes the bill to the customer. To correct such a bill segment, you must cancel the offending segment and create a new segment (after correcting the cause of the problem). We refer to this process as cancel / rebill.

FASTPATH:

Refer to [How To Cancel / Rebill A Bill Segment](#) for more information about how to cancel / rebill a frozen bill segment.

You must use the cancel / rebill process to correct problems on frozen bill segments. This is because a frozen bill segment can be thought of as having been posted to your general ledger (even if the GL interface hasn't run). And once a financial

transaction is posted to the general ledger, it can only be removed via a reversal. Contrast this to bill segments that are in error - they can be deleted because they were never posted to the general ledger.

FASTPATH:

Refer to [Bill Segment Lifecycle](#) for more information about the differences between bill segments that are frozen and those that are in error.

NOTE:

Bill segments are canceled / rebilled. It's important to stress that bill segments are canceled and rebilled (as opposed to bills). If every bill segment on a bill is incorrect, you must cancel / rebill each individual bill segment.

Using the cancel or cancel/rebill functionality will cause the cancel and rebill details to be swept on to the customer's next bill. If your organization requires cancellation details to be presented to the customer separately from the new bill, then you will need to use Credit Notes. Refer to [Credit Notes - Presenting Cancellation Details on a Separate Bill](#) for more information. If your organization requires cancellation and rebill details to be presented to the customer separately from the new bill, then you will need to use Correction Notes. Refer to [Correction Notes - Presenting Correction Details on a Separate Bill](#) for more information.

Credit Notes - Presenting Cancellation Details on a Separate Bill

The system's [Cancel / Rebill](#) functionality will include cancellation and rebilling details on the customer's next bill. Some organizations are required to present cancellation details to the customer separately and not to commingle them with a new bill. This separate statement containing only the cancellation information is referred to as a Credit Note.

Credit Notes may be created for an individual bill segment or for all the bill segments linked to a bill. To create a credit note, a Credit Note button is available on the [Bill Segment](#) page and on the [Bill](#) page.

FASTPATH:

Refer to [How To Create A Credit Note](#) for more information about how to create credit notes for a bill or bill segment.

The topics in this section provide describe the impact of this functionality.

Credit Notes Are Only Possible if the Installation Option Is Turned On

The Credit Notes button on the bill segment and bill pages will only be available if you have selected the Credit Note Bill Correction option on the [Installation](#) record.

Credit / Correction Notes and Auto Pay

If a credit or correction note is being created for a customer who is enrolled in Auto Pay, note the following functionality:

When creating a credit or correction note for a bill (and all its bill segments):

- The system will cancel an automatic payment behind-the-scenes if a credit or correction note is issued BEFORE the automatic payment is interfaced to the financial institution. When you recomplete the bill, the system will create a new automatic payment that reflects the new amount due (and the canceled automatic payment will net out the original automatic payment). This is standard auto pay logic. Refer to [How Are Automatic Payments Cancelled?](#) for more information.

- If the customer has automatic payments that have already been interfaced to the financial institution, the creation of the credit or correction note will have no affect on any automatic payment. A warning will be issued in this case.

When creating a credit or correction note for a bill segment:

- Because automatic payments are for an entire bill, creating a credit or correction note at the bill segment level will not affect any automatic payments. A warning is issued in this case.

FASTPATH:

For more information about correction notes, see [Correction Notes - Presenting Correction Details on a Separate Bill](#).

Adjustments On Credit Notes

Above, we described how a credit note is a separate document that contains the cancellation details of the various bill segments that appeared on a given bill. Some implementations also want the adjustments that appeared on the original bill to be cancelled when a credit note is produced. Then, when the next bill is produced for the customer, they want these same adjustments reproduced. The following points describe how to implement this functionality:

- Plug in a Bill Completion algorithm on the applicable [Customer Classes](#). A base-package algorithm (C1-CN-RADJ) will reverse a bill's adjustments when a credit note is completed.
- Plug in a Post Bill Completion algorithm on the applicable [Customer Classes](#). A base-package algorithm (C1-CN-ADNB) will recreate the adjustments on the original bill after the credit note is completed. These adjustments will be swept onto the next bill produced for the account.

You can restrict the above functionality to specific adjustment types (for whatever reason). You do this by putting a given char type / char value on the adjustment types that should be reversed and recreated when a credit note is created. You define this char type / char value combination as parameters of the two algorithms described above.

NOTE:

When the original bill contains adjustment cancellations. The above discussion explained how adjustments can be canceled on a credit note and then recreated on the next bill. These same algorithms also do the opposite, i.e., if the original bill contains an adjustment cancellation, the credit note will contain the recreated adjustment, and the next bill will contain its cancellation. Without this, the credit note would not be the reversal of the bill (and this is how some organizations operate).

Credit Note Routing Suppression

Some implementations do not send credit notes to their customers. To implement this functionality, plug in a Bill Completion algorithm on the applicable [Customer Classes](#). A base-package algorithm (C1-CN-BRT) will cause the routing information to be suppressed when a credit note is completed.

Correction Notes - Presenting Correction Details on a Separate Bill

The system's [Cancel / Rebill](#) functionality will include cancellation and rebilling details on the customer's next bill. Some organizations are required to present cancellation and rebilling details to the customer separately and not to commingle them with a new bill. This separate statement containing the cancellation and rebill information is referred to as a Correction Note.

Correction notes may be created for an individual bill segment or for all the bill segments linked to a bill. To create a correction note, a **Correction Note** button is available on the [Bill Segment](#) and [Bill](#) pages.

FASTPATH:

Refer to [How To Create A Correction Note](#) for more information about how to create correction notes for a bill or bill segment.

The topics in this section describe correction notes.

Correction Notes Are Only Possible if the Installation Option Is Turned On

The **Correction Note** button on the bill segment and bill pages will only be available if you have selected the Correction Note Bill Correction option on the [Installation](#) record.

FASTPATH:

If your implementation uses Correction Notes, it is recommended to also use the Freeze At Bill Completion installation option. For more information, see [Installation Options - Billing](#).

Correction Notes Versus Credit Notes

Correction notes are a mixture of Credit Note and [Cancel / Rebill](#) functionality. However, unlike credit notes, correction notes are like regular bills and are subject to payment.

When you issue a correction note for a bill, the system cancels and rebills the bill segments for that bill. The new bill (the correction note) contains both the cancelled bill segments and the rebilled bill segments.

Similar to credit notes, the new bill (or correction note) is stamped with the ID of the original bill. After you review the bill segments, you can complete the correction note. During completion, the rebilled bill segments and the cancelled financial transactions (of the original bill's bill segments) are swept onto the correction note.

Correction Notes and Auto Pay

FASTPATH:

Refer to [Credit / Correction Notes and Auto Pay](#) for a description of how the system handles correction notes for customers using auto pay.

How the System Requests How Much Was Consumed

There are two types of service agreements:

- Those that charge for some commodity; such as, electricity, water, garbage, and street lighting.
- Those that charge for something intangible; such as, deposit, charitable contribution, and payment arrangement.

For service agreements that charge for something intangible, there is no notion of requesting or determining how much was consumed and therefore the topics in this section are not relevant. For service agreements that charge for a commodity, the first step in the creation of a bill segment is requesting the amount or usage consumed (or bill determinants) from Oracle Utilities Meter Data Management; for example,

- If the service agreement bills for electricity, the system must know how much electricity was consumed.
- If the service agreement bills for lamp service, the system must know how many lamps the customer uses.

After the system requests and receives the amount or usage consumed (or bill determinants) during the bill period from Oracle Utilities Meter Data Management, it saves the consumption or usage details on the bill segment in the following snapshots:

- The **item snapshot** contains information about the items that existed at the service points received from Oracle Utilities Meter Data Management
- The **calculation/audit read details** contains information about the meter read details received from Oracle Utilities Meter Data Management
- The **calculation/audit usage details** contains information about the usage details received from Oracle Utilities Meter Data Management.
- The **service quantity snapshot** contains the billable service quantities received from Oracle Utilities Meter Data Management

NOTE: This logic is in a plug-in. The logic described below resides in algorithms that are plugged-in on the bill segment type referenced on a service agreement's SA type. If you need different logic, you should develop the appropriate algorithm and plug it in on your bill segment types.

FASTPATH:

Refer to [The Big Picture of Usage Requests](#) for more information about how Oracle Utilities Customer Care and Billing requests and receives consumption / usage information from Oracle Utilities Meter Data Management.

Refer to [Usage](#) for more information about how Oracle Utilities Meter Data Management calculates usage.

Item Snapshot

Items (such as, lamps, hydrants, and traffic lights) are not read so there are no meter reads to access.

- There are two sources of items:
 - Item-based service points have a single, **badged** item that may be installed at any instant in time. These types of service points are used, for example, when your organization keeps track of the installation history of specific lamps. If an item is installed at an item-based service point during the bill period, it will be included in the item snapshot.
 - All types of service points (metered, item-based, and non-badged) may contain one or more **unbadged** items. Multiple items exist at a service point, for example, when your organization chooses to record multiple lamps on a single service point rather than creating a separate service point for each lamp (this might be useful for a parking lot at a shopping mall). Each item referenced in the service point's collection of unbadged items is included in the snapshot.

FASTPATH:

Refer to [Understanding Service Point Types](#) for more information about service points with multiple items.

Service Quantity Snapshot

For service agreements where the meter reads are maintained in Oracle Utilities Meter Data Management and bill determinants are requested via a usage request, the service quantity (SQ) snapshot is the total amount consumed (or peak amount) for each unit of measure referenced on the bill segment's usage request.

NOTE:

Pre-Processing Calculation Rules. If the service agreement's rate has pre-processing calculation rules, they may alter the amount of measured consumption or add additional units of measure to the SQ snapshot. Refer to [All Calculation Rule-Based Rates Share a Common Structure](#) for more information about pre-processing calculation groups.

Lamps and estimated consumption. If any of the items linked to the service agreement's service points indicate the system should estimate consumption (e.g., lamps), additional entries will be added to the SQ snapshot for each such item. Refer to [Device Types](#) for more information.

Meter read details used for [interim calculations](#) are ignored when producing the service quantity snapshot.

Calculation / Audit Read Details

We use the term "calculation / audit read" to describe a meter read that appears on a bill segment. The following points provide examples of when calculation / audit reads may be required:

- Some retail companies upload meter read details when they upload [pass through charges](#). They do this in order to print the read details that were used to calculate the pass-through charges. It should be stressed that these reads are not used to derive billable consumption (because the charges have already been calculated). These reads are only uploaded for printing purposes and therefore "real" meter reads are not created. We categorize these reads as "calculation / audit reads". Refer to [Billable Charge Upload - Read Details](#) for more information about uploading meter reads with pass-through charges.
- When usage requests are sent during billing to Oracle Utilities Meter data Management, meter reads details may be returned to Oracle Utilities Customer Care and Billing as part of the usage request response. These reads are used for printing purposes. These reads are captured as "calculation / audit reads". Refer to [Usage Requests](#) for more information.
- You may have situations where a meter has been temporarily removed from a service point but the business practice dictates that usage for the service point should be calculated during billing.

Calculation / audit reads are stored in a bill segment's read details (the name of the table is CI_BSEG_READ). The following points describe the main features of calculation / audit reads:

- Calculation / audit reads may or may not reference a service point.
- Calculation / audit reads do not reference the prime key of a real read.
- Calculation / audit reads have a usage flag with a value of Calculation .
- Calculation / audit reads do not require a UOM code. If a UOM is not supplied, an SQI must be supplied.

If you encounter other scenarios during your implementation that necessitate calculation / audit reads, you can develop bill segment type and calculation rule algorithms to add additional calculation / audit reads to a bill segment's read details.

Calculation / audit read details are shown in a separate section on [Bill Segment - SQ Details](#).

Calculation / Audit Usage Details

We use the term "calculation / audit usage" to describe service quantities retrieved from the bill segment's usage request. An example of when calculation / audit usage may be required:

- When usage requests are sent during billing to Oracle Utilities Meter Data Management, usage details may be returned to Oracle Utilities Customer Care and Billing as part of the usage request response. Oracle Utilities Meter Data Management might return both usage details and meter reads to print on the bill.

Usage service quantities are also stored in a bill segment's read details (the name of the table is CI_BSEG_READ). The following points describe the main features of calculation / audit usage:

- Calculation / audit usage may or may not reference a service point.

- Calculation / audit usage does not reference the prime key of a real read.
- Calculation / audit usage has a usage flag with a value of Service Quantity.
- Calculation / audit usage does not require a UOM code. If a UOM is not supplied, an SQI must be supplied.

If you encounter other scenarios during your implementation that necessitate calculation / audit usage, you can develop bill segment type and calculation rule algorithms to add additional calculation / audit usage to a bill segment's read details.

Calculation / audit usage details are shown in a separate section on [Bill Segment - SQ Details](#).

How To Override The Commodity Amount In A Bill Segment

As described earlier, the calculation of the amount consumed is one of the first steps that takes place when a bill segment is created. 99.9% of the time, the system does a perfect job in this effort. However, there are rare circumstances when, due to missing or incorrect data, the quantity calculated by the system is not what you want to charge the customer for (consider what the consumption should be if the meter is broken?).

To help you deal with these rare situations, a "back door" exists that allows a bill segment's billable quantities to be overridden. This truly is a "back door" because the proper way to fix the amount of a commodity is to correct the cause of the error and then cancel / rebill the bill segment.

How Rates Affect the Information on Bill Segments

After consumption has been compiled, the system applies the service agreement's rate to the consumption to determine how much to charge the customer. We refer to this process as the "rate application."

The rate application is a very sophisticated process and can affect every aspect of a bill segment. See [Rate Schedule Execution](#) for an overview of how the system processes a rate.

Rates not only control which charges appear on the bill, but also the verbiage. In addition, there are variables that can be used in the configuration to customize the message that the customer receives. See [How to Use Description on Bill](#) for more information

NOTE:

Not all service agreements use a rate! There are a small number of service agreements that don't use a rate to calculate the charges that appear on their bill segments. For example, a service agreement used to levy a customer's payment arrangement amount doesn't need a rate because the amount to charge is defined on the service agreement. Whether or not a service agreement needs a rate is defined by the service agreement's SA type. Whether or not the system calls the service agreement's rate to calculate charges is controlled by the bill calculation algorithm plugged-in on the bill segment type that's referenced on the service agreement's SA type. Refer to [Designing and Defining Bill Segment Types](#) for a description of the various bill segment creation algorithms that are supported in the system.

Proration. A rate contains a variety of effective-dated information (meaning that the prices are effective-dated, and the structure of the rate is effective-dated) If this effective-dated information changes during a bill period, the system may need to prorate the charges; for example, if the sales tax percentage changes mid-period, the system can prorate the tax change. Refer to segments. Refer to [Effective Dates and Price Proration](#) for more information.

There are many plug-in spots available on a calculation rule. These plug-ins can manipulate virtually every aspect of the bill segment. This means if you require functionality that isn't support by the base package calculation rule, you can build additional calculation rule plug-ins to do whatever you need. See [Base Package Calculation Rule Descriptions](#) for more information

FASTPATH:

Refer to [Rates](#) for more information about how rates are constructed.

Bill Frequency - Bill Cycle vs Bill Segment Duration

An account's bill cycle defines when the system attempts to create bill segments for the account's service agreements. The word "attempt" is stressed because a service agreement may not have a bill segment on every bill created for its account.

Some examples will help make the point:

- An account may be on a monthly bill cycle (meaning we attempt to create a bill every month for the account) but contain only biannual service agreements. However, this is not sensible. Why? Because the system would attempt to create a bill every month for the account's service agreements, but only twice during the year would it succeed (because the service agreements have a biannual duration).
- An account may be on a biweekly bill cycle (meaning we attempt to create a bill every 2 weeks for the account) and contain a mixture of biweekly, monthly, and quarterly service agreements. In this scenario, every two weeks the system would create a bill that contains at least one bill segment (for the biweekly service agreement). However, 12 times a year, the bill will contain an additional bill segment for the monthly service agreement. And 4 times a year, the bill will contain one more bill segment (for a total of 3) for the quarterly service agreement.

In sum, the account's bill cycle controls when the system attempts to create a bill for the account's service agreements. Whether a service agreement contributes a bill segment to the bill is a complicated subject. The topics in this section describe how the system knows it's time to create a bill segment for a service agreement.

IMPORTANT:

An account's bill cycle should attempt to create bill segments at least as often as the shortest service agreement duration. For example, if an account has both monthly and quarterly service agreements, the account should be placed on a monthly bill cycle. Refer to [How Does An Account Get Its Bill Cycle?](#) for more information.

Ways To Control The Start Date Of A Bill Segment

Bill segments produced for a service agreement have two time periods:

- The bill segment period. The bill segment period defines the entire period of time covered by a bill segment's charges.
- The consumption period. The consumption period defines the period of time used to calculate the number of days for daily charges.

The consumption period almost always starts one day after the bill segment period. The consumption period always ends on the bill segment's end date. For example, a bill segment period that spans 5-Jan-2002 through 6-Feb-2002 will almost always have a corresponding consumption period of 6-Jan-2002 through 6-Feb-2002. The reason that the start dates don't match is because a bill segment's start date equals the end date of the prior bill segment (i.e., the start date was already counted in the previous bill segment's consumption period and we don't want to count it twice).

The only time when the previous paragraph isn't true is the first bill segment that's produced for a new service agreement. This is because different companies count the first day of a new service agreement differently than others. Refer to [Initial Consumption Period Considerations](#) for examples and an explanation of how you can control the start date of the consumption period.

Ways To Control The End Date Of A Bill Segment

The following points describe the different methods that can be used to define the end date on a service agreement's bill segments:

- **Meter Read Date.** For service agreements with metered consumption (excluding real time meters), the end date is the date of the meter read used on the last day of the bill segment.
- **Bill Period Schedule.** Non-metered service agreements may have the end date of their bill segments defined on the user-maintained bill period calendar. This option is used when bill segments must fall on strict calendar boundaries (e.g., quarterly bills that end on the last day of the quarter).
- **Anniversary.** In addition to the Bill Period Calendar method, non-metered service agreements may have their bill segment end date based on the first day of service. For example, if service started on the 16 th of some month, the ongoing bill segments will start on roughly the 16 th of each month. This option is frequently used to bill for garbage or cable service.
- **ASAP.** For non-meter service agreements that use neither the Bill Period Calendar nor Anniversary methods, the system assumes the end date of a bill segment is the current date. This option is frequently used for service agreements that deal with items (e.g., street lamps, phone booths).
- **Billable Charge.** For non-metered service agreements that exist to levy billable charges, the start AND end dates are defined on the billable charge information that is entered by a user or interfaced from an external system.

The topics in this section discuss each of the above methods.

Using The Meter Read Date Method

A metered service agreement's SA type does not contain a specific indication that the service agreement is used to charge for metered service. Rather, if the system finds metered service points linked to the service agreement, it knows to use a meter read date as the end date of the bill segment.

Using The Bill Period Schedule Method

The bill period schedule method causes the bill segment end date to be calculated using a bill period schedule. The bill period's schedule defines when bill segments are produced and their respective end dates. This method is used when the bill segment needs to fall on strict calendar boundaries (e.g., quarterly bills that end on the last day of the quarter).

The service agreement's SA type indicates if the service agreement uses this method, and if so, the specific bill period whose schedule defines the end dates.

NOTE:

Future and Past End Dates. It's important to be aware that a bill period schedule can be used to generate end dates that are in the future or in the past.

FASTPATH:

For more information about bill periods, refer to [Designing Bill Periods](#).

Using The Anniversary Method

The anniversary date method causes the bill segment end date to be calculated based on the first day of service. For example, if a service agreement started on the 16 th of some month, the ongoing bill segments will start on roughly the 16 th of each month. This method is frequently used to bill for garbage or cable service. When using this method, you also define the applicable billing frequency (i.e., monthly, bi-monthly, quarterly, etc.).

The following table contains the bill periods for a service agreement's starting on 23-Feb-99 that uses a monthly frequency.

Start Date	End Date	Billing Days
23-Feb-99	25-Mar-99	30
25-Mar-99	25-Apr-99	31
25-Apr-99	25-May-99	30
25-May-99	25-Jun-99	31
25-Jun-99	25-Jul-99	30
25-Jul-99	25-Aug-99	31
25-Aug-99	24-Sep-99	30
24-Sep-99	24-Oct-99	30
24-Oct-99	24-Nov-99	31
24-Nov-99	24-Dec-99	30
24-Dec-99	24-Jan-00	31
24-Jan-00	23-Feb-00	30
23-Feb-00	25-Mar-00	31

NOTE:

Future and Past End Dates. It's important to be aware that anniversary billing can generate end dates that are in the future or in the past. The future-option generates the next anniversary date after the current date. The past-option generates the anniversary date that immediately precedes the current date.

The service agreement's SA type indicates if the service agreement uses this method, and if so, the billing frequency.

FASTPATH:

For more information about the SA Type attributes that control this method, refer to [Setting Up SA Types](#).

Using Billable Charges

Bill segments for billable charge service agreements have both their start and end dates defined on the respective billable charge.

FASTPATH:

For more information about billing billable charges, refer to [How To Create A One-Time Invoice](#). For more information about creating a billable charge, refer to [Maintaining Billable Charges](#). For more information about interfacing a billable charge from an external system, refer to [Uploading Billable Charges](#).

The service agreement's SA type indicates if the service agreement uses this method, and if so, the billing frequency.

FASTPATH:

For more information about the SA Type attributes that control this method, refer to [Setting Up SA Types](#).

Preventing Short Bill Segments

Every SA type contains an attribute defining the minimum number of days on a bill segment. Whenever the system attempts to create a bill segment other than the final bill segment, it checks if the number of days is at least as great as the minimum. If not, the bill segment will not be created as part of this bill run. Rather, the system waits until the number of days in the bill segment is at least as large as the minimum. This is true for all methods of bill duration calculation.

Prorating Charges When a Rate is Applied

It is possible for some of the prices that appear on a bill segment to change during the course of the bill period.

FASTPATH:

Refer to [Effective Dates & Price Proration](#) for more information about how charges are prorated during rate application.

Batch Billing

99.9% of all bills are created by the batch billing background process BILLING and require no human intervention before they can be finalized and sent to a customer. The other 0.1% are created by users on-line / real time. This section discusses several important concepts associated with batch billing. If your implementation requires processing of data by CIS Division the BILLING background process provides an optional parameter that allows a CIS Division to be specified as an input parameter.

This process has an optional input parameter for CIS Division. It can be used if you implementation requires processing of data by CIS Division. You will need to create a copy of this process's batch control for each CIS Division.

Window Billing And The Bill Cycle Schedule

FASTPATH:

Refer to [The Cyclical Billing Process & Window Billing](#) for more information about how an account's bill cycle dictates when a customer is billed.

Confirming A Batch Of Bills Before Completing Them

If you're implementing new rates or if something unusual is being introduced that affects billing, you may want to turn off the bill cycle schedule's Freeze and Complete switch. If this switch is off, the system creates bills, it just doesn't freeze and complete them. You can then review the entire batch of bills to make sure they're clean.

- If you find the bills are wrong, correct the source of the error and rerun the bill cycle. The system will remove all incomplete bills and then reproduce them using the corrected information in the system.
- If you find the bills are correct, turn the Freeze and Complete switch on and rerun the cycle. The system will remove all incomplete bills and then reproduce them. Assuming nothing changed, the bill amounts will be the same.

FASTPATH:

Refer to [Setting Up Bill Cycle Schedules](#) for more information.

Canceling A Batch Of Bills After They're Complete

If you need to cancel an entire batch of bills because they were created using faulty data (e.g., the wrong tax rate was defined in the rate), you can. A background process (MASSCNCL) exists for this purpose.

This background process will cancel all the frozen bill segments for the latest run of a given bill cycle's schedule. Optionally, you can cancel bills for a given bill date within the bill cycle's schedule. The cancel reason used on the bill segment is the one marked as the bill cancel reason for mass cancel. Refer to [Setting Up Bill \(Segment\) Cancellation Reasons](#) for more information.

When the cycle is billed again, new bill segments will be created, and the original bill segments and the cancellations will automatically be hidden from the customers.

Reopening A Batch Of Bills After They're Complete

If you need to reopen an entire batch of bills because they were completed prematurely (e.g., payments did not get posted before billing ran, so recent payments were not reflected in the account balances), you can. A background process (MASSROBL) exists for this purpose.

This background process will reopen all the bills for a given bill date for the latest run of a given bill cycle's schedule.

Fixing Errors Detected In Batch Billing

If an "error" bill segment is created by the batch billing process, the system attempts to fix the offending segment each night by regenerating it using the information that exists at that time. Therefore, if the cause of the error is fixed during the day, the system will automatically regenerate the bill segment when batch billing next runs; you don't have to manually correct each bill. And, once a bill is error-free, it will be completed and sent to the customer.

IMPORTANT:

Automatic regeneration only works during the account's bill window. If an "error" bill segment is not successfully regenerated on the last night of the account's bill cycle, it will remain in error until the next time the account's cycle runs (unless a user corrects it real time). At that time, the system will generate another bill error indicating the prior bill segment is in error (and then there'll be two bill segments in error).

Completing Pending Bills

If you need to complete pending bills created by the batch billing process, you can. A background process (C1-BLCMP), exists for this purpose.

This background process will complete all pending bills on a given bill date for a given bill cycle's schedule. This process does not delete and regenerate freezable bill segments linked to pending bills.

FASTPATH:

Refer to [Bill Errors](#) for more information.

Billing Financial Transaction Considerations

The topics in this section provide information about the financial impact of a bill segment.

Billing - Current Balance versus Payoff Balance

A bill segment's financial transaction affects a service agreement's payoff balance and/or current balance. In this section, we describe these two balances.

WARNING:

If you do not understand the difference between payoff balance and current balance, refer to [Current Amount versus Payoff Amount](#).

When Current Balance Equals Payoff Balance

For most service agreements, payoff balance and current balance are always the same (or in colloquial speech - the amount the customer thinks they owe equals what they really owe). Let's run through a typical example. The values in the payoff balance and current balance columns reflect the amount due after the financial transaction has been applied (i.e., the running balance):

Date	Financial Transaction	Payoff Balance	Current Balance
1-Jan-99	Bill: \$125	125	125
15-Jan-99	Payment: \$150	-25	-25
2-Feb-99	Bill: \$175	150	150
14-Feb-99	Payment: \$150	0	0
3-Mar-99	Bill: \$200	200	200
15-Mar-99	Payment: \$150	50	50
2-Apr-99	Bill: \$225	275	275

As you can see, payoff balance and current balance are always in sync.

When Current Balance Differs From Payoff Balance

For some service agreements, payoff balance and current balance differ (or in colloquial speech - the amount the customer thinks they owe differs from what they would owe if they wanted to pay off their account).

Let's run through an example of a customer on a budget to illustrate a classic service agreement where these two balances are not the same. The values in the payoff balance and current balance columns reflect the amount due after the financial transaction has been applied:

Date	Financial Transaction	Payoff Balance	Current Balance
1-Jan-99	Bill: \$125, Budget \$150	125	150
15-Jan-99	Payment: \$150	-25	0

2-Feb-99	Bill: \$175, Budget \$150	150	150
14-Feb-99	Payment: \$150	0	0
3-Mar-99	Bill: \$200, Budget \$150	200	150
15-Mar-99	Payment: \$150	50	0

The following table describes the various types of service agreements where these balances may differ.

Type Of Service Agreement	What Payoff Balance Holds	What Current Balance Holds
Deposit	Payoff balance holds the amount of deposit you are holding on behalf of the customer's debt. This amount is showed as a credit (with a negative sign) because you truly owe the customer this money.	Current balance holds the amount the customer owes for a deposit.
Charitable contribution	N/A - charitable contribution service agreements never have a payoff balance.	Current balance holds the amount the customer owes for a charitable contribution.
Payment arrangements	Payoff balance holds the total amount of delinquent debt that remains unpaid. When a payment arrangement is started, you transfer the payoff balance from the utility service agreement to the payment arrangement service agreement. Each billing period, the customer pays down this balance.	Current balance holds the amount the customer owes in respect of the billed payment arrangement amounts.
Service agreements on a budget plan	Payoff balance holds the actual amount owed (actual bills minus payments).	Current balance holds the amount the customer owes in respect of the billed budget amount.

Bill Segment Type Controls Which Balance(s) Are Affected

Every bill segment references a bill segment type (the bill segment type comes from its service agreement's SA type). The bill segment type controls how payoff balance and current balance are affected by the bill segment amount. It also controls the algorithm used by the system to calculate the bill segment's bill lines.

FASTPATH:

Refer to [Designing and Defining Bill Segment Types](#) for more information about how bill segment type affects how a bill segment is produced and how its financial transaction is generated.

The Source Of GL Accounts On A Bill Segment's Financial Transaction

A bill segment's financial transaction also contains the double-sided accounting entry that defines how the bill segment affects the general ledger.

FASTPATH:

Refer to [The Source Of GL Accounts On Financial Transactions](#) for a description of where the system extracts the distribution codes used to construct the GL accounts.

Determining the Statistical Quantity

The statistical quantity for each general entry line in the financial transaction is populated by adding together the statistical quantity for all bill calculation lines for the same distribution code. The bill calculation line indicates a statistical quantity if its corresponding calculation rule has marked the GL statistical quantity setting.

The statistical quantity for a bill calculation line is the prorated billable quantity for that line.

- If the corresponding calculation rule for the bill calculation line is not marked **measures peak**, then the statistical quantity corresponds to the billable quantity for the bill line. This is because billable quantities for SQs that do not represent a peak quantity are prorated when applying the rate.
- If the corresponding calculation rule for the bill calculation line is marked **measures peak**, then the statistical quantity may not correspond to the billable quantity for the bill calculation line. SQs that measure peak are not prorated when applying the rate. However, when determining the statistical amount to send to the general ledger, the quantity is prorated in the same manner as quantities that do not measure peak amounts.

NOTE:

Bill Calc Line Statistical Quantity. The statistical quantity for each bill calculation line is calculated when generating the bill segment and used to populate the statistical quantity for the FT GL entry. The calculated value is not saved in the bill calc line record.

The Source Of Bill Routing Information

When a bill is completed, the system creates a [bill routing](#) for each person linked to the account who receives a copy of the bill. The bill routing record contains the information that controls how, where and to whom a bill is sent.

The following points describe how this works:

- Each person who receives a copy of an account's bill is listed on the [account's person information](#).
- A [bill routing](#) is created for each such person when the bill is completed.
- The information that appears on the bill routing record is controlled by the **bill route type** specified on the respective account / person information.
- If the bill route type's routing method is email or fax and the system has been configured to use notification preferences for bill routing, a bill routing is created for each active contact preference whose notification type is associated with the **bill route type** specified on the respective account/person information ; otherwise, bill routings are created as follows:
 - If the bill route type indicates the person's bills are routed via fax, the "address line 1" address constituent is populated with the person's fax number. The system knows which of a person's person contacts is a fax number is by the contact routing or which of a person's phone numbers is a fax number by the phone type.. If person contacts are used, the primary fax is selected. If phone is used and the person has multiple fax numbers, one is selected at random.
 - If the bill route type indicates the person's bills are routed via email, the "address line 1" address constituent is populated with the person's [Email address](#). The system knows which of a person's person contacts is an email or knows where to find the person email. If person contacts are used, the primary email is selected.
- If the bill route type indicates the person's bills are routed via the postal service, the address constituents are populated with the address specified on the [account / person's bill address source](#). Note, if the person has a [seasonal address](#) effective on the business date, the seasonal address will be used regardless of the value of **bill address source**.

FASTPATH:

Refer to [Printing Bills](#) and [How To Reprint A Bill \(For The Original Recipients or For Someone New\)](#) for more information. Refer to [Account - Person Information](#) for information regarding how to control who receives a copy of a bill, where the bill is sent, and how the bill is formatted.

Bill Messages

The topics in this section describe how messages are linked to a bill and bill segment.

The Source Of Bill Messages

When a bill is completed, the system sweeps bill messages from the following sources onto the bill.

NOTE:

Bill or Bill Segment Messages. Bill messages will be linked either to the bill or to one its bill segments depending on the source of the bill message code. In other words, messages associated with a service agreement (directly or indirectly) will be linked to the bill segment; messages associated with an account (directly or indirectly) will be linked to the bill.

- All permanent and temporary bill messages linked to an account are linked to the bill when it is completed. Refer to [Account - Bill Messages](#) for more information. Note well that all temporary bill messages are removed from the account when they are swept onto a bill (a temporary message is swept onto the next bill produced for the account).
- The system checks if the bill's account's customer class has bill messages. If so, it links all such messages that are effective on the bill date to the bill when it is completed. Refer to [Setting Up Customer Class Bill Messages](#).
- All permanent and temporary bill messages linked to service agreements that contributed bill segments to the bill are linked to their respective bill segment when the bill is completed. Refer to [Service Agreement - Miscellaneous](#) for more information. Note well that all temporary bill messages are removed from the service agreement when they are swept onto a bill segment (a temporary message is swept onto the next bill segment produced for the service agreement).
- The system checks if each bill segment's rate has bill messages. If so, it links all such messages that are effective on the bill segment's start date to the bill segment when the bill is completed. Refer to [Defining Calculation Rules](#) for more information.
- The system checks if the service provider associated with each sub bill segment has bill messages. If so, it links all such messages that are effective on the bill segment's start date to the bill segment when the bill is completed. Refer to [Setting Up Service Providers](#).

In addition, a user may manually add an [ad hoc message to a bill](#).

And finally, you can develop your own background processes and algorithms that add bill messages to accounts, service agreements, bills and/or bill segments. Refer to [Substituting Field Values Into A Bill Message](#) for examples.

Substituting Field Values Into A Message

Many bill messages contain static text (i.e., the message is the same on every bill). However, the system supports messages whose contents are dynamic. For example, consider the bill message Thank you for your charitable contributions in 2000 for \$123.12, please keep this bill for tax purposes. This message contains two substitution values (the year and the amount) as is therefore considered dynamic.

Dynamic messages can be implemented as follows:

- Create a bill message code whose Message on Bill contains substitution values. For example, the bill message code to produce the message illustrated above would contain the following Message on Bill - Thank you for your charitable contributions in %1 for %2, please keep this bill for tax purposes.
- Use either of the following methods to link the message code and its substitution parameters to the bill:
 - Create a background process or algorithm to insert a permanent or temporary bill message on the appropriate accounts. Then, when an account's bill is next completed, the system will sweep the message (and its substitution parameters onto the bill).
In addition to inserting the appropriate bill message code, your background process / algorithm must also insert the appropriate substitution values. The name of the table in which account messages are inserted is **CI_ACCT_MSG**. The name of the table in which a message's substitution values are inserted is **CI_ACCT_MSG_PRM** (you will insert one row for each substitution field).

Please see the background process (REACH) for an example of a background process that performs this type of function. Please see the algorithm identified by DEP PIF MSG for an example of an algorithm that performs this type of function.
 - Rather than adding the dynamic message to account (and then letting the bill completion logic transfer the account message to the bill), you could construct a bill completion algorithm that adds the message code and substitution values on the bill (during bill completion). The name of the table in which bill messages are inserted is **CI_BILL_MSGS**. The name of the table in which a message's substitution values are substituted is **CI_BILL_MSG_PRM** (you will insert one row for each substitution field).

A Bill May Affect More Than Just Customer Balances

The topics in this section provide information about obscure things that may happen when a bill is created, frozen, or canceled.

Auto Cancel / Rebill If A Service Agreement Is Stopped Retroactively

If the system detects a bill segment with a bill date after the stop date of the service agreement (because the service agreement was retroactively stopped), the system automatically cancels the bill segment and creates a new one with an end date equal to the service agreement's stop date.

Cancel Historical, Estimated Bill Segments When a Real Read Is Found

A special plug-in spot exists on bill segment type that can be used to automatically cancel historical, estimated bill segments when a “real” read is used on the current bill. This plug-in spot is invoked only when an excessive read (the prior read is more than the current read) situation is detected.

If you wish that the spot be invoked all the time and not only when an excessive read situation is encountered, you must setup the *Always Call Auto Cancel* option type of the *Financial Transaction Options Feature Configuration*. You will normally do this if you want the type of readings to be the basis of the auto cancellation. For example, you want to cancel estimated bills and rebill distributing usage more accurately across a tiered rate.

These algorithm would typically be specified on bill segment types that calculate bills using meter reads.

NOTE:

This plug-in spot is typically used on bill segment types that calculate bills using meter reads. It is typically not used when usage is requested from Oracle Utilities Meter Data Management.

This algorithm is called by the system when creating bills in batch. It does not get called when a user creates a bill online.

Deposits May Be Refunded

FASTPATH:

Refer to [Refunding Deposits](#) for how deposits may be refunded when a deposit service agreement is "final billed".

FT Freeze Repercussions

FASTPATH:

Refer to [Obscure Things That Can Happen](#) for more information about things that can happen when an FT is frozen (and FT's get frozen during billing).

Budget Billing

The topics in this section provide background information about a variety of budget billing issues.

FASTPATH:

We strongly recommend familiarizing yourself with the topics described in [Designing and Defining Budget Plans](#) to fully appreciate how budgets fit into the system's financial architecture.

Account versus Service Agreement

Customers who pay on a budget plan tend to believe that there is one budget amount applied to their account's bill each month. This is not true. Rather, each service agreement has an individual budget amount (stored in the recurring charge array). The sum of an account's service agreements' budget amount is the account's budget amount.

Why does each service agreement have a unique budget amount? Because all financial accounting in the system is performed at the service agreement level, not for an entire account.

While a unique budget amount is defined for each service agreement, a user can use a simple page to view and change the budget amount for all eligible service agreements linked to an account.

It's important to be aware that some service agreements linked to an account may not be eligible for budget plans. For example, assume you have a customer with a deposit service agreement and one or more utility service agreements. This customer will be billed for their deposit regardless of the utility service agreements' budget amounts. You define whether a service agreement may participate in a budget plan on the service agreement's SA type.

How To Set Up A Customer To Participate In A Budget Plan

If a customer wants to participate in a budget billing plan, simply transfer to [Account - Budget](#) and generate a new budget for the customer.

The Financial Impact Of Budget Plans

The only difference between a customer who participates in budget billing and one who doesn't is that budget billing customer have bill segments where payoff amount differs from current amount. Why? Because the payoff amount is the actual amount of the bill. The current amount is the amount the customer is expected to pay (i.e., their budget amount).

Let's run through an example of a customer on a budget to illustrate a service agreement where these two balances are not the same. The values in the payoff balance and current balance columns reflect the amount due after the financial transaction has been applied:

Date	Financial Transaction	Payoff Balance	Current Balance
1-Jan-99	Bill: \$125, Budget \$150	125	150
15-Jan-99	Payment: \$150	-25	0
2-Feb-99	Bill: \$175, Budget \$150	150	150
14-Feb-99	Payment: \$150	0	0
3-Mar-99	Bill: \$200, Budget \$150	200	150
15-Mar-99	Payment: \$150	50	0

FASTPATH:

For more information about current and payoff amounts, refer to [Current Balance versus Payoff Balance](#).

Budget Billing Background Processes

The topics in this section describe the background processes that automate management of customer who participate in budget billing plans.

NOTE:

Budget Processing. The budget background processes only calculate budget amounts for pending start, active and pending stop SAs whose start and end date (if any) includes the budget date. Additionally, the budget date is used to select the rate schedule that is in effect for an SA if estimating consumption is necessary.

Budget True Up

The Budget True Up background process (BUDTRUP) examines all accounts who participate in budget billing plans. If enough time has passed since the customer's budget was last trued up, the system will calculate the account's recommended budget amount. If the recommended amount differs from their existing budget amount by more than a given tolerance percentage, the customer's budget amount (actually, the recurring charge amount on the account's service agreements) will be changed.

FASTPATH:

The amount of time between true ups and the true up method used to true up is defined on the account's budget plan. The tolerance percentages are defined as parameters of the true-up algorithm that is plugged in on the account's budget plan. Refer to [Designing and Defining Budget Plans](#) for all the details.

Budget Monitor

The Budget Monitor background process (BUDMON) examines all accounts that participate in budget billing plans. If the account's existing budget amount is out-of-sync with predefined tolerance percentages as defined by the algorithm plugged into the monitor budget plug-in spot, the system will perform the action indicated by the monitor algorithm. The base product supports highlighting the account on the [Budget Review](#) page or updating the account's budget.

FASTPATH:

The tolerance percentages are defined as parameters of the budget monitor algorithm that is plugged in on the account's budget plan. Refer to [Designing and Defining Budget Plans](#) for all the details.

Canceling A Budget

The following points describe when a budget is cancelled:

- A user can cancel a budget at any time by using the Cancel Budget action on the [Account - Budget](#) page.
- The system may cancel a budget during a collection process (if the collection process contains a Cancel Budget collection event). Refer to [Types Of Collection Events](#) for more information.
- When a service agreement is [stopped](#), the system automatically cancels the budget.

When a customer's budget is cancelled, the following events transpire:

- Any recurring charge entry whose effective date is after the cancel date is deleted. This is possible if you are entering a back-dated stop date for the service agreement. For example, perhaps you run the [Budget True Up](#) process, which adds a new budget amount to the service agreement (effective today). Then imagine that the customer calls you and informs you that they moved out last week. If you stop the customer's service as of last week, the recurring charge effective today is deleted when the stop is finalized.
- A new recurring charge amount of zero is created for each of the customer's service agreement.
- Each service agreement's current balance is synchronized with its payoff balance (using the sync adjustment code defined on the service agreement's SA type).

Net Energy Metering

The topics in this section provide background information on net energy metering.

What Is Net Energy Metering?

Customers in a distributed generation energy market may have renewable energy devices such as solar panels or wind turbines connected to their meters. The energy generated at this service point, as well as any energy used, could possibly be measured by a single meter, with the energy generated being netted against the energy used. This is called net energy metering (NEM). The meter records a positive number when customers use more energy than they generate, and a negative number when they generate more than they consume. These customers may owe a minimum charge each month. Their actual energy charges and generation credits are accrued until the account is adjusted at the end of a specified period, called the true up period. When the account is trued up, the consumption charges and generation credits for the period are combined to determine if the customer owes money to the utility.

Net Energy Metering Service Agreements

As mentioned in the previous section, net energy metering (NEM) customers typically owe a minimum charge each month while their actual energy charges and generation credits are accrued until true up time. This is accomplished by setting up a master service agreement (SA) to hold the monthly minimum charge and a sub service agreement to hold the customer's actual energy charges and generation credits.

For more information about service agreement relationships, refer to [Defining SA Relationship Options](#).

Net Energy Metering True Up

To facilitate the true up process, each true up period will be represented by a sub service agreement. Each sub service agreement will be monitored by a true up monitor (TUM), a service task which is responsible for: performing the true up process at the end of the true up period; reversing true up transactions when cancel/rebills affect a period that has been trued up; synchronizing itself with any changes on its master service agreement or service agreement relationship (e.g., if the service agreement relationship is deleted, the true up monitor will cancel itself); and creating the service agreement relationship and sub service agreement for the next true up period.

A service agreement creation algorithm on the master service agreement type is responsible for creating the initial sub service agreement and service agreement relationship. Subsequent sub service agreements are created in the true up monitor lifecycle. A service agreement creation algorithm on the sub service agreement type is responsible for creating the true up monitor. A link to the true up monitor service task is available from the characteristics page of the sub service agreement. It is important to note that the true up monitor is not a user-maintained object. End-users will not normally need to access the true up monitor. All that is visible on the true up monitor is its type, status, related sub service agreement and account. As always, relevant financial history will be accessible from the sub service agreement.

The Lifecycle of a True Up Monitor

The following diagram shows the lifecycle of the True Up Monitor business object:

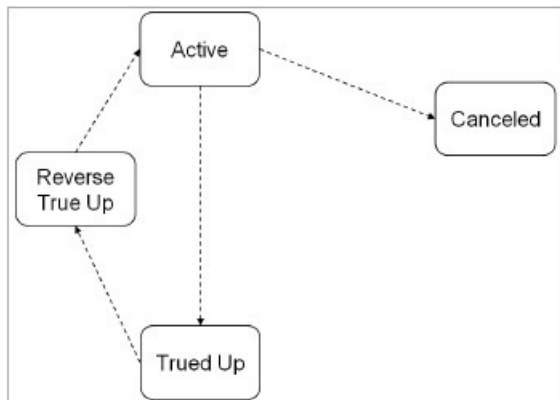

Active State: The true up monitor starts out in the Active state. Here the true up monitor is evaluated for true up processing or possible cancellation. The system will perform a true up if either the true up period has come to an end, or the service agreement is final billed.

The amount of time between true ups is defined on the true up task type. See [Setting Up the System for Net Energy Metering](#) for a description of how true up task types are configured.

Canceled State: The true up monitor is transitioned to the Canceled state if its service agreement is canceled or deleted. Because the service agreement associated with a true up monitor is a sub service agreement, it is possible that the stop date on the sub service agreement is backdated to a point prior to the start of its associated service agreement relationship. In this case, the true up monitor is also canceled.

Trued Up State: If it is time for true up, the true up monitor is transitioned to the Trued Up state. True up processing involves summing the sub service agreement's bill segments to see if the customer owes any debt (i.e., the energy they generated was not enough to cover the energy they consumed). If the sum is positive, the amount is transferred to the master service agreement for the customer to pay off. If the sum is negative, the sub service agreement balance is brought to zero (the utility keeps the credit). If your implementation wants to issue refunds to customers who generate more energy than they consume, you will need to design your own algorithm for the true up process.

The adjustment types used to transfer or zero out the sub service agreement balance are defined on the true up monitor type. See [Setting Up the System for Net Energy Metering](#) for a description of how true up monitor types are configured.

Reverse True Up State: Once the financial true up is done, a new service agreement relationship and sub service agreement are created for the subsequent true up period. If cancel/rebills occur after the true up process has been performed, the true up monitor is transitioned to the Reverse True Up state. Any adjustments that were previously created are canceled as part of this processing. Thereafter the true up monitor is transitioned back to the Active state, where it waits until bill completion attempts another true up.

Setting Up the System for Net Energy Metering

This section summarizes the various tasks required for setting up your system for net energy metering.

Adjustment Types

The following adjustment types are used at true up time:

- **Current Balance True Up.** This is the adjustment type used in syncing the payoff and current amounts on the sub service agreement associated with the true up period. This adjustment type should reference an FT algorithm of **Payoff Amount = 0 / Current Amount = Adj Amount (no GL)**.
- **Transfer To Master.** This is the adjustment type used to transfer the customer's balance from sub service agreement to master service agreement if a positive payoff balance exists on the sub service agreement after true up.
- **Write Down.** This is the adjustment type used to bring the payoff balance of the sub service agreement to zero if a negative payoff balance exists after true up.

Adjustment Type Profile

Create an adjustment type profile that references the adjustment types used in net energy metering billing.

True Up Task Type

To enable billing for net energy metering, your implementation must configure a **True Up Task Type**. This service task type captures the various configuration options that are used by the true up monitor's algorithms:

- **Minimum Days In True Up Period** defines the minimum number of days covered by the bill segments within a true up period before true up processing can occur
- The task type captures the adjustment types used at true up time
- **Reversal Adjustment Cancel Reason** is used on true up adjustments that are canceled as a result of cancel/rebill activity occurring after a true up

Algorithms

Add the following algorithms:

- The sub service agreement and service agreement relationship are initially created by an **SA Creation** algorithm on the master service agreement type. The base package provides algorithm type C1-SAT-SARL for this purpose. An algorithm should be configured with the service agreement relationship type to use.

- Creation of the true up monitor is handled by an **SA Creation** algorithm on the sub service agreement type. The base provides algorithm type C1-SAT-TUM for this purpose. The true up monitor service task type is defined as an algorithm parameter.
- Whenever a net energy metering sub service agreement is canceled, its associated true up monitor should also be canceled. The base provides algorithm C1-CNC-TUM to be plugged in as an **SA Cancel** algorithm on the sub service agreement type to accomplish this.
- The true up monitor is transitioned out of the Active or Reverse True Up state by the billing process. To that end, a **Bill Completion** algorithm needs to be configured on the master service agreement type. This algorithm is responsible for transitioning any true up monitor that is in an Active or Reverse True Up state that is related to the master service agreement. The base provides the algorithm C1-TRN-TUM for this purpose.
- When cancel/rebills occur, financial transactions related to the true up need to be reversed. To accomplish this, an **FT Freeze** algorithm must be plugged in on the sub service agreement type. The base provides algorithm C1-RV-TRUP for this purpose.

For more information on setting up service agreement Relationships, refer to [Defining SA Relationship Options](#). For more information on service agreement type algorithms, refer to [SA Type - Algorithms](#).

Your implementation must also decide if the sub service agreement's bill segment financial transactions should impact the general ledger or not. This is controlled by the **Financial Algorithm** on the bill segment type defined for the sub service agreement type. The base provides algorithms C1-C0-GL and C1-C0-NOGL for this purpose. For more information on configuring Bill Segment Types, refer to [Designing and Defining Bill Segment Types](#).

Net Energy Metering Billing Examples

This section contains billing examples for net energy metering. The examples assume the following:

- The customer is billed quarterly using the following tariff:
 - Customer charge of \$3/day (billed on master service agreement)
 - \$0.10 per kWh (billed on sub service agreement and trued up after 12 month period)
- The GL Accounting distribution codes used in the following tables, such as A/R-NEM and NEM-Liability, are for example only. Your implementation will specify its own distribution codes.
- A True Up Task Type that references the base product NEM business objects with the following configuration:
 - **Minimum Days In True Up Period:** 365
 - **Sync Current Adjustment Type:** NEM SYNC
This is the adjustment type used to synchronize (make equal) the sub service agreement's current amount with the payoff amount at true up time.
 - **Transfer Adjustment Type:** NEM XFER
This is the adjustment type used to transfer debt from the sub service agreement to the master service agreement at true up time.
 - **Write Down Adjustment Type:** NEM WDOWN
This is the adjustment type used to write down any remaining amount on the sub service agreement after we attempt to transfer debt to the master service agreement at true up time.

Example 1: Customer Consumes More Than They Generate

The following table outlines the customer's master service agreement financial transactions in 2010. Adjustments created in the true up period are in bold. In this example the customer's net energy results in an outstanding balance of \$330 which is transferred from the sub service agreement to the master service agreement, leaving the sub service agreement for that true up period with a zero balance.

Event	GL Accounting	Effect On Payoff Amount	Effect On Current Amount	Payoff Balance	Current Balance
Bill Segment (1/1–3/31) (90 days * \$3/day = \$270)	A/R-NEM 270 NEM-Liability <270>	270	270	270	270
Payment	Cash 270 NEM-A/R <270>	-270	-270	0	0
Bill Segment (4/1–6/30) (91 days * \$3/day = \$273)	A/R-NEM 273 NEM-Liability <273>	273	273	273	273
Bill Segment (7/1–9/30) (92 days * \$3/day = \$276)	A/R-NEM 276 NEM-Liability <276>	276	276	549	549
Payment	Cash 549 A/R-NEM <549>	-549	-549	0	0
Bill Segment (10/1–12/31) (92 days * \$3/day = \$276)	A/R-NEM 276 NEM-Liability <276>	276	276	276	276
NEM XFER true up adjustment (transfer from sub service agreement)	A/R-NEM 330 XFER <330>	330	330	606	606

The following table outlines the customer's sub service agreement financial transactions (FTs). Note that bill segment financial transactions affect the customer's pay off balance only. Adjustments created in the true up period are in bold below and reflect the following:

- First, the current balance to the payoff balance is set using the sync adjustment type (NEM SYNC) on the service task type.
- Second, any debt from the sub is transferred to the master service agreement using sync adjustment type on the service task type (NEM XFER).

Event	GL Accounting	Effect On Payoff Amount	Effect On Current Amount	Payoff Balance	Current Balance
Bill Segment (1/1–3/31) (1200kWh * \$0.10 = \$120)	A/R-NEM 120 NEM-Liability <120>	120	0	120	0
Bill Segment (4/1–6/30) (500kWh * \$0.10 = \$50)	A/R-NEM 50 NEM-Liability <50>	50	0	170	0
Bill Segment (7/1–9/30) (600kWh * \$0.10 = \$60)	A/R-NEM 60 NEM-Liability <60>	60	0	230	0
Bill Segment (10/1–12/31) (1000kWh * \$0.10 = \$100)	A/R-NEM 100 NEM-Liability <100>	100	0	330	0

Event	GL Accounting	Effect On Payoff Amount	Effect On Current Amount	Payoff Balance	Current Balance
NEM SYNC adjustment (sync current to payoff)	n/a	0	330	330	330
NEM XFER adjustment (transfer to master service agreement)	XFER 330 A/R-NEM <330>	-330	-330	0	0

Example 2: Customer Generates More Than They Consume

The following table outlines the customer's master service agreement financial transactions (bill and payment segments are exactly the same as in example 1 above). In this example the customer's net energy results in a credit balance on the NEM sub service agreement which is written off, leaving the sub service agreement for that true up period with a zero balance (credits are not transferred to the master service agreement).

Event	GL Accounting	Effect On Payoff Amount	Effect On Current Amount	Payoff Balance	Current Balance
Bill Segment (1/1–3/31) (90 days * \$3/day = \$270)	A/R-NEM 270 NEM-Liability <270>	270	270	270	270
Payment	Cash 270 A/R-NEM <270>	-270	-270	0	0
Bill Segment (4/1–6/30) (91 days * \$3/day = \$273)	A/R-NEM 273 NEM-Liability <273>	273	273	273	273
Bill Segment (7/1–9/30) (92 days * \$3/day = \$276)	A/R-NEM 276 NEM-Liability <276>	276	276	549	549
Payment	Cash 549 A/R-NEM <549>	-549	-549	0	0
Bill Segment (10/1–12/31) (92 days * \$3/day = \$276)	A/R-NEM 276 NEM-Liability <276>	276	276	276	276

The following table outlines the customer's sub service agreement financial transactions (FTs). Note that bill segment financial transactions affect the customer's pay off balance only. Adjustments created in the true up period are in bold below and reflect the following:

- First, the current balance is set to the payoff balance using the sync adjustment type (NEM SYNC) on the service task type.
- Because a credit remains on the sub service agreement, this amount will be written off using the write down adjustment type on the service task type (NEM WDWN).

Event	GL Accounting	Effect On Payoff Amount	Effect On Current Amount	Payoff Balance	Current Balance
Bill Segment (1/1–3/31) (80kWh * \$0.10 = \$8)	A/R-NEM 8 NEM-Liability <8>	8	0	8	0
Bill Segment (4/1–6/30)	A/R-NEM <12> NEM-Liability 12	-12	0	-4	0

Event	GL Accounting	Effect On Payoff Amount	Effect On Current Amount	Payoff Balance	Current Balance
(-120kWh * \$0.10 = \$-12)					
Bill Segment (7/1–9/30)	A/R-NEM <8> NEM-Liability 8	-8	0	-12	0
(-80kWh * \$0.10 = \$-8)					
Bill Segment (10/1–12/31)	A/R-NEM 10 NEM-Liability <10>	10	0	-2	0
(100kWh * \$0.10 = \$10)					
NEM SYNC true up adjustment (sync current to payoff)	n/a	0	-2	-2	-2
NEM WDOWN true up adjustment (write down credit)	NEM A/R 2 E - W/O <2>	2	2	0	0

For more information about current and payoff amounts, refer to [Billing - Current Balance versus Payoff Balance](#).

Using Billable Charges for Pass Through / Convergent Billing

The term "pass through" billing is used to describe the practice of receiving charges calculated by third parties and presenting them on the customer's bill along with your own charges. "Pass through" billing is implemented in the system using [Billable Charges](#).

The following points provide information to help you decide the most appropriate way to implement "pass through" billing given your specific requirements:

- Customers with pass through charges will need a separate service agreement to hold the pass through charges. We refer to this type of service agreement as a "billable charge" service agreement.

NOTE:

A service agreement's SA type controls whether a service agreement can have billable charges linked to it. Specifically, the SA type must have a "special role" of Billable Charge.

- A billable charge service agreement holds the billable charges until the customer is next billed. At that time, a separate bill segment will be created for each unbilled billable charge linked to the billable charge service agreement.
- While it is not required, we recommend creating a separate billable charge service agreement for each type of pass through charge. For example, if you can receive "pass through" charges from the local water company and the local cable company, we'd recommend having two billable charge service agreements for each customer.
- As described under [We Bill For Them](#), you can setup the system to automatically create billable charge service agreements when you start regular service for your customers. If you take this approach, you can also have the system create the payable transaction to pay the 3rd party. Refer to [Pay At Bill Time vs. Pay At Pay Time](#) for more information.
- You can interface billable charges using the [Billable Charge Interface](#). The interfaced charges can consist of any of the following:
 - Pre-calculated bill lines that will be presented "as is" to the customer.
 - Service quantities that are used by the system to calculate the charges on behalf of the third party. For example, the 3rd party may pass through the number of kilowatt-hours and you calculate the bill lines for them. Refer to [Uploading Consumption Rather Than Bill Lines](#) for more information.

- Meter read details that you want printed on the bill. Note, the base package bill segment creation algorithm (BSBS-BC) simply sweeps billable charge read details onto the related [bill segment's read detail](#). This algorithm does NOT use these reads to derive service quantities. This is intentional as most implementations that import reads also import service quantities and therefore deriving service quantities is unnecessary (and also error prone). If your implementation needs to derive service quantities from these reads, you can develop your own bill segment creation algorithm to do just this.
- All of the above. You might interface both bill lines and service quantities if the third party calculated the charges but did not calculate the taxes. The dollar amount for which taxes will be calculated would be defined using a service quantity. Refer to [Calculating Taxes On Uploaded Charges](#) for more information.

NOTE:

You cannot interface interval data via the billable charge interface. Rather, you would need to interface the interval data to Oracle Utilities Meter Data Management and then let the system calculate the charges for you.

- The bill lines on a billable charge can fit into any of the following categories:
- Memo-only (i.e., don't affect the general ledger). A bill line that is memo-only contain information that is purely informational. For example, the 3rd party might pass the start and end meter reads that they used to calculate the charges. You can use memo-only bill lines to show this information on the customer's bill. If a bill line is not memo-only (i.e., it affect the general ledger), a distribution code must also be specified to define how the lines affects the general ledger.
- Show on the customer bill. It is possible to create bill lines that affect the general ledger, but are not shown on the customer's bill. This is an unusual practice, but it happens.
- Summary / detail. Each bill line has an indication of whether it is a summary or detail line. This only impacts bill presentation.

NOTE:

The above indicators can be defaulted onto a billable charge line by using [Billable Charge Line Types](#) when you interface the lines into the system.

- Characteristics (i.e., user-defined fields) can be associated with billable charge lines. You might populate this information if you are interfaced information that may be useful during bill presentation or for reporting purposes.
- If service quantities are specified on a billable charge, they are saved on the bill segment created when the billable charge is billed. This means that they system can support creation of a graph of historical usage on the bill, as well as other queries on customer usage. In addition, it might be possible to event estimate consumption based on these service quantities (but such a plug-in is not supplied with the base package).

NOTE:

The system does not support passing in items (e.g., street lamps). This could be a problem if you need to perform ratable calculations for the 3rd party based on, say, the number of street lights. However, if you require ratable, street light pass through billing, you can calculate a service quantity for each type of street light and save this information on the billable charge. The associated rate would then have a price per service quantity rather than a price per item type.

The system does not support sending in raw meter reads with billable charges. This consumption needs to be passed in as a service quantity. However, you can pass in meter read details to be printed on the bill segment.

- Cancel / rebill for billable charges is quite different than for normal bill segments. A billable charge bill segment can be cancelled, and this will reverse the financial effects of the billable charge. But without new information from the source, there is no way to rebill the customer. Therefore, if the original charges were incorrect, the source system would send both a reversal of the charges and a newly revised set of information. These could be passed as two separate billable charges or they could combined on a single billable charge.
- In terms of the customer information setup, while a service agreement that holds billable charges does not need a service point, there are advantages to having this information in the system. For one thing, if jurisdictional taxes are being calculated by the system, the definition of the jurisdiction(s) is held on the service point or premise. Also, the link to the

service point defines the service address, facilitates customer lookup, causes information to appear in Control Central's trees, etc.

- For most other functionality, the billable charge service agreement supports the same functionality as normal service agreements. This includes budget billing, payment distribution, credit & collection tracking and events, current & payoff balances, movement of old debt onto payment arrangements, etc.

FASTPATH:

For more information about billing billable charges, refer to [How To Create A One-Time Invoice](#). For more information about creating a billable charge, refer to [Maintaining Billable Charges](#). For more information about creating sub service agreements to hold billable charges, refer to [We Bill For Them](#). For more information about interfacing a billable charge from an external system, refer to [Uploading Billable Charges](#).

Printing Bills

The contents of this section describe the technical implementation of both an online and batch bill production.

Bill Routings Are Created For Each Recipient Of A Bill

Refer to [The Source Of Bill Routing Information](#) for a description of how the system constructs the information used to route a bill to one or more recipients.

Bill Route Types Control The Information Merged Onto Bills

Every bill routing record references a [Bill Route Type](#).

The bill route type controls the following for interacting with a document composition application:

NOTE: CIS Division can override the extract algorithm and/or the background process found on the bill route type. The system processes first check the bill's account's CIS Division for an override specific for the bill route type.

- It contains an algorithm that is responsible for extracting the information merged onto your bills. Algorithms of this type are called under the following scenarios:
 - The [background process](#) that interacts with your bill print software calls these algorithms.
 - If your bill print software has the ability to construct a real-time image of a bill, you can plug-in an Online Bill Display algorithm on the [Installation Record](#). This type of algorithm will call the bill extract algorithm for an appropriate bill route type to extract the information that is merged onto the bill. Refer to [Technical Implementation Of Online Bill Display](#) for the details.
- It contains the ID of the background process responsible for interacting with your bill print software in batch.

The bill route type controls the following for interacting with a reporting engine, such as BI Publisher:

- It contains an algorithm that is responsible for returning the appropriate report code and other information in order to extract the information to be merged onto your bills. Typically, the reporting engine itself is responsible for extracting and formatting the data. Algorithms of this type are called under the following scenarios:
 - The [background process](#) that interacts with your reporting engine calls these algorithms.
 - If your reporting engine has the ability to construct a real-time image of a bill, you can plug-in an Online Bill Display algorithm on the Installation Record. This type of algorithm will call the bill extract algorithm for an appropriate bill

route type to return the appropriate report code. Refer to [Technical Implementation Of Online Bill Display](#) for the details.

- It contains the ID of the background process responsible for interacting with your reporting engine in batch.

Technical Implementation Of Online Bill Display

Users can view an image of any bill that is sent to a customer on [Bill - Main](#) if you plug-in an Online Bill Display construction algorithm on the [Installation Record](#)

NOTE: Some display algorithms rely on the bill extract algorithm on each [Bill Route Type](#)

The system can make a call to an external system to retrieve a bill image. Many bill print vendors support this functionality. The system provides an Installation – Online Bill Display algorithm type (C1GENBILLURL) that can generate a dynamic URL.

- The algorithm of this algorithm type supports dynamic variables such as the bill ID and static variable such a vendor or implementation supplied security key.
- The algorithm constructs a URL including generating HASH or security keys.
- The system displays the retrieved image in a separate browser session
- Refer to the algorithm type description for information about this algorithm type.

The system can interact with either document composition applications, or a reporting engine (such as BI Publisher).

The system provides an Installation – Online Bill Display algorithm type (C1-BL-DISP) that interacts with Documaker to render an online image of your bill. The following points describe what takes place when clicking **Display Bill**.

- The algorithm based on this algorithm type calls the bill extract algorithm for an appropriate bill route type (as determined by the algorithm).
- The bill extract algorithm will construct the information that appears on the bill (refer to algorithm type C1-BLEX-XML for further details).
- The constructed information is passed to document composition software that will reconstruct the bill's image in a PDF format.
- The system displays the PDF in a separate browser session. Note that the client must have Adobe Acrobat Reader installed to view PDF files.

NOTE:

Refer to [The Bill Extract Records](#) for examples of the record layouts passed to the document composition software.

The system also provides an Installation – Online Bill Display algorithm type (C1-ONLN-CR) that interacts with [BI Publisher](#) to render an online image of your bill. The following points describe what takes place when clicking **Display Bill**:

- The algorithm based on this algorithm type calls the bill extract algorithm for an appropriate bill route type (as determined by the algorithm).
- The bill extract algorithm returns the appropriate report code to the Online Bill Display algorithm, which in turn returns the report code to the bill page (refer to algorithm type C1-BLEX-BIP for further details). This algorithm is not actually extracting data because when you use BI Publisher reports, the report itself is responsible for extracting and formatting the data.
- A user exit on the bill page invokes BI Publisher and displays the bill in a separate browser session.

NOTE:

Refer to [Bill Print in BI Publisher](#) for examples of the data extracted for the report.

Technical Implementation Of Printing Bills In Batch

The batch process that extracts bill related information reads all bill routing records in a given run number that are marked with its batch control ID

The base package example of this process ([POSTROUT](#)) simply calls the bill extract algorithm on the routing record's route type. The algorithm formats the information to be passed to the bill print software or reporting engine. Refer to [Bill Route Types Control The Information On Bills](#) for more information.

NOTE:

If your software doesn't support online bill display. The algorithm that formats bill extract records that's plugged in [onbill route type](#) serves two purposes: 1) it interacts with the online bill display algorithm plugged into the installation record to support online images of a bill, and 2) it interacts with the background process to support printing your bills in batch. If your bill print software does not support the rendering of bill images real time, there is no need to create an extract algorithm. Rather, you should simply develop your own download process that works with your bill print software to print bills in batch (and then specify this batch process on your bill route type).

Reproducing The Bill Print Flat File

You can reproduce the flat file at any time. Simply request the download process and specify the run number associated with the historic run.

How To Reprint A Specific Bill

Refer to [How To Reprint A Bill \(For The Original Recipients or For Someone New\)](#) for instructions describing how to reprint a specific bill.

Who Gets A Copy Of A Bill?

A copy of a bill is sent to every individual / business specified in the [bill's routing details](#).

There are two ways in which a bill routing detail can be created:

- When a bill is completed, the system creates a routing detail for every person linked to the account that wants to receive a copy of the bill (as specified on [Account - Person Information](#)). Refer to [The Source Of Bill Routing Information](#) for more information.
- After a bill is completed, you may insert a bill routing record. Refer to [How To Reprint A Bill \(For The Original Recipients or For Someone New\)](#) for more information.

Final Bills and Bill Print

If a bill is produced for an account where all of the accounts SAs are stopped, closed or cancelled; the bill is flagged as being the final bill on the flat file produced by the postal routing process (refer to [Bill Record - 0100](#) for the details of this switch).

If a bill is considered to be a final bill and the amount owing for the entire account is less than the final bill threshold amount on the installation record, the bill will be skipped (i.e., it won't appear on the flat file produced by the postal routing process). Note, this logic also suppresses bills from being produced when a payment is received AFTER the final bill and the account's balance falls beneath the installation record's final bill threshold amount. Refer to [Installation Options - Billing](#) for more information.

The Bill Extract Records

Numerous different types of records are interfaced to the document composition application. However, they all share a common structure for bills:

- The first 4 bytes are called the **Printer Key**. This field is a record type used by the document composition application bill template.
- The next 244 bytes are called the **Sort Key**. This field is used to ensure the various records used to construct a printed bill appear in the correct order in the interface file.
- The next 12 bytes are called the **Mailing Key**. This field is used to control the order in which the formatted bills are printed.
- The next 3 bytes are a filler that is available for future use.
- The remaining bytes contain the **BillInformation** that appears on the printed bill. The type of information differs for each type of record.

The topics in this section describe each component.

Printer Keys (Record Types)

The following table defines each printer key (i.e., record type) on the bill print flat file.

Record Type	Description	Notes
0010	Global extract information	Required. 1 per flat file.
0100	Bill record	Required. 1 per bill.
0150	Account Balance Record	Required. 1 per Special Role.
0300	Current charge record	1 per current charge.
0600	Payment record	1 per payment.
0900	Premise record	1 per premise.
1100	Service agreement record	1 per SA linked to the premise.
1300	Bill segment record	1 per bill segment linked to the SA.
1500	Bill calculation header	1 per bill calculation header linked to the bill segment.
1700	Bill calc line	1 per bill calculation line linked to the bill calculation header
1900	End of record type 1500	1 for each bill calculation header

2100	Read detail	1 for each meter read detail linked to the bill segment
2400	Service quantity detail	1 for each service quantity detail linked to the bill segment
2700	Item detail	1 for each item detail linked to the bill segment
2840	Bill segment messages	1 for each message detail linked to the bill segment
2900	End of record type 1300	1 for each bill segment
3100	Consumption history (for graph)	1 for each historical consumption period that appears on the graph
3400	Adjustment detail	1 for each adjustment
3420	Adjustment Calc Line	1 or more per adjustment
3600	End of record type 1100	1 for each service agreement
3700	End of record type 0900	1 for each premise
3900	Bill message detail	1 for each message
9999	End of record type 0100	1 for each bill

Sort Key

The following table defines the structure of the sort key that appears on each bill print record. Please note that different components are filled in for each printer key.

Field Name	Format	Source/Value/Description
Bill Print Intercept	A8	This is the user ID, if any, who reviews the bill (as specified on the account record)
Bill ID	A12	
Sequence Number	N2	The sequence number of the account / person information associated with this bill routing information.
Copy Number	N2	The number of copies desired by the account / person associated with this bill routing information.
Bill record group	A2	10 Bill 20 Payment 30 Current charge 40 Message 50 Non-Premise 55 Non-Premise end 60 Premise 70 Bill end
Filler	A2	

Premise State	A6	Only applicable for Premise based records.
Premise City	A90	Only applicable for Premise based records.
Premise Address 1	A64	Only applicable for Premise based records.
Premise Id	A10	Only applicable for Premise based records.
Premise record group	A2	10 Premise record 20 SA level record 30 Premise end record
SA Print Priority	A2	
SA Id	A10	
SA Group	A2	For Premise based records: 10 SA 20 Histogram 30 Current charge 40 Adjustment 50 SA end record For Non-Premise based records: 10 SA 20 Current Charge 30 Adjustment 40 SA end record
Bill Segment End Date	A10	If the record is related to an adjustment, this is the adjustment creation date. If the record is for histogram detail, this contains the histogram detail number.
Bill Segment Id	A12	If the record is related to an adjustment, this is the adjustment ID.
Bill Segment Group	A2	10 Bill segment 20 Bill segment calculation group 30 Bill segment read detail 40 Bill segment SQ detail 50 Bill segment item detail 55 Bill segment message 60 Bill segment end
Bill Calc Header Sequence	N2	For records related to read detail, SQ detail, item detail or bill message detail, this field contains the related sequence number for that record.
Bill Calc Header Group	A2	10 Bill calculation header 20 Bill calculation line 30 Bill calculation end
Line Seq	N3	Defines order of rows for similar record types

Mailing Key

The following table defines the structure of the mailing key that appears on each bill print record.

Field Name	Format	Source/Value/Description
Postal code	A12	This is the postal code on the bill routing record.

Bill Information

The topics in this section describe the information that appears on each on each bill print record.

- [Global Extract Information Record \(0010\)](#)
- [Bill Record \(0100\)](#)
- [Account Balance Record \(0150\)](#)
- [Current Charge Record \(0300\)](#)
- [Payment Record \(0600\)](#)
- [Premise Record \(0900\)](#)
- [Service Agreement Record \(1100\)](#)
- [Bill Segment Record \(1300\)](#)
- [Bill Calc Header Record \(1500\)](#)
- [Bill Calc line Record \(1700\)](#)
- [End Bill Calc Header Record \(1900\)](#)
- [Bill Segment Read Record \(2100\)](#)
- [Bill Segment SQ Record \(2400\)](#)
- [Bill Segment Item Record \(2700\)](#)
- [Bill Segment Message Record \(2840\)](#)
- [End Bill Segment Record \(2900\)](#)
- [Histogram Record \(3100\)](#)
- [Adjustment Record \(3400\)](#)
- [Adjustment Calc Lines Record \(3420\)](#)
- [End Service Agreement Record \(3600\)](#)
- [End Premise Record \(3700\)](#)
- [Message Record \(3900\)](#)

- [End Bill Record \(9999\)](#)
- [Address Sub-Record](#)

Global Extract Information Record (0010)

This is a "header" record that contains information about the extract run as a whole.

NOTE:

Please be aware that if you do not sort your extract file by **CIS Sort Key** after it is produced, this record will physically be the last record on the extract file.

Field Name	Format	Source/Value/Description
BATCH_CD	A8	Batch Control Code of the extract process.
BATCH_NBR	N10	Batch Number of the extract process
BATCH_RERUN_NBR	N10	Batch Rerun number of the extract process.
BILL_CNT	N10	Count of bills on this extract. Multiple copies of a bill are counted multiple as well.
EXTRACT_DTTM	A26	System time of extraction. Also updated in bill routing table.
BILL_ID_START	A12	This is only used when a bill is produced as a result of an online request (from Bill - Main). It contains the Bill Id to extract.
BILL_ID_END	A12	This is only used when a bill is produced as a result of an online request (from Bill - Main). It contains the Bill Id to extract.
THREAD_NBR	N10	This field is only used if bills are extracted in batch. It contains the thread number in which the bill was extracted.
THREAD_CNT	N10	This field is only used if bills are extracted in batch. It contains the total number of threads that were extracted.

[Top of Page](#)

Bill Record (0100)

Field Name	Format	Source/Value/Description
BILL_ID	A12	CI_BILL
ACCT_ID	A10	CI_BILL
BILL_DT	D (A10)	CI_BILL
DUE_DT	D (A10)	CI_BILL
COPY_NBR	N2	
NBR_BILL_COPIES	N2	CI_BILL_RTG
BILL_PRT_INTERCEPT	A8	CI_BILL_RTG
BILL_FORMAT_FLG	A2	CI_BILL_RTG
REPRINT_SW	A1	CI_BILL_RTG
CASH_ONLY_SW	A1	

CUR_BAL	S13.2	CI_BILL_SA
CUR_CHG_AMT	S13.2	CI_FT
CUR_CORR_AMT	S13.2	CI_FT
CUR_ADJ_AMT	S13.2	CI_FT
CUR_PAY_AMT	S13.2	CI_FT
CUR_PREV_BAL	S13.2	CI_FT
TOT_BAL	S13.2	CI_BILL_SA
TOT_CHG_AMT	S13.2	CI_FT
TOT_CORR_AMT	S13.2	CI_FT
TOT_ADJ_AMT	S13.2	CI_FT
TOT_PAY_AMT	S13.2	CI_FT
TOT_PREV_BAL	S13.2	Computed during extract.
CURRENCY_CD	A3	CI_BILL_SA
DELINQUENT_AMT	S13.2	Computed during extract.
CUST_PO_ID	A20	CI_BILL_RTG
ACCT_ENTITY_NAME	A254	CI_PER_NAME. Account Entity Name. Might include prefix/suffix from Account/Person if available.
ENTITY_NAME	A254	CI_BILL_RTG. Mailing Entity Name.
ADDRESS_SBR	A1241	CI_BILL_RTG. Refer to its components in a later section.
FINAL_BILL_SW	A1	Computed during extract. Contains a value of Y if this bill is considered to be a "final" bill.
SCHED_EXTRACT_DT	D (A10)	CI_APAY_CLR_STG. This is the date that the automatic payment will be downloaded.
ENTITY_NAME1	A254	CI_BILL_RTG. Mailing Entity Name1.
ENTITY_NAME2	A254	CI_BILL_RTG. Mailing Entity Name2.
ENTITY_NAME3	A254	CI_BILL_RTG. Mailing Entity Name3.
ACCT-CUR-SYMBOL	A4	Currency symbol for the account's currency code.

[Top of Page](#)

Account Balance Record (0150)

Field Name	Format	Source/Value/Description
SPECIAL-ROLE-CD	A2	SA Type Special Role flag
SPECIAL-ROLE –DESCR	A30	Special Role description
CUR-AMT	S13.2	Derived from CI_FT (Include ALL non-canceled/non-closed SAs for the account/debt class, even those that do not have current charges)
TOT- AMT	S13.2	Derived from CI_FT (Include ALL non-canceled/non-closed SAs for the account/debt

class, even those that do not have current charges)

[Top of Page](#)

Current Charge Record (0300)

Field Name	Format	Source/Value/Description
DEBT-CLASS-CD	A4	Debt Class of SA Type
DEBT-CLASS-DESCR	A30	Debt Class Description
CUR-CHARGE-AMT	S13.2	Derived from CI_FT (Only the current charge bill segments.)
TOT-CHARGE-AMT	S13.2	Derived from CI_FT (Only the current charge bill segments.)

[Top of Page](#)

Payment Record (0600)

Field Name	Format	Source/Value/Description
FT TYPE	A2	Pay or Pay Cancel ('PS' or 'PX')
PAY-DT	D (A10)	Derived from CI_FT
CAN_RSN_CD	A4	Derived from CI_PAY, Only for cancellation
CAN-RSN-DESCR	A30	Derived from CI_PAY_CAN_RSN
CUR-PAY-AMT	S13.2	Derived from CI_FT.
TOT-PAY-AMT	S13.2	Derived from CI_FT.

[Top of Page](#)

Premise Record (0900)

Field Name	Format	Source/Value/Description
NON_PREM_SW	A1	Y/N switch to indicate (Y) special (non-premise) premise record. This is for non-premise service agreements such as charity or payment arrangement.
PREM_ID	A10	From CI_SA or CI_BSEG
ADDRESS_SBR	A1241	Service Address (Address of Char Premise) from CI_PREM. Refer to its components in a later section.

[Top of Page](#)

Service Agreement Record (1100)

Field Name	Format	Source/Value/Description
SA_ID	A10	CI_SA
OLD_ACCT_ID	A36	CI_SA
CUST_READ_FLG	A2	CI_SA

SIC_CD	A4	CI_SA
SIC_DESCR	A30	CI_SIC
BUSINESS_UNIT	A10	CI_SA
SA_TYPE_CD	A8	CI_SA
SA_TYPE_DESCR	A30	CI_SA_TYPE
SA_TYPE_DFLT_DESCR	A80	CI_SA_TYPE
SVC_TYPE_CD	A30	CI_SA_TYPE
SVC_TYPE_DESCR	A30	CI_SVC_TYPE
REV_CL_CD	A8	CI_SA_TYPE
CHAR_PREM_ID	A10	CI_SA
SA_REL_ID	A10	CI_SA_REL
SA_REL_TYPE_CD	A8	CI_SA_REL
SA_REL_TYPE_DESCR	A30	CI_SA_REL_TYPE
SPR_CD	A12	CI_SA_REL
SPR_DESCR	A50	CI_SPR
SPR_ENTITY_NAME	A254	CI_PER_NAME (this is the service provider's person's name)

[Top of Page](#)

Bill Segment Record (1300)

Field Name	Format	Source/Value/Description
START_DT	D (A10)	CI_BSEG
END_DT	D (A10)	CI_BSEG
CLOSING_BSEG_SW	A1	CI_BSEG
EST_SW	A1	CI_BSEG
BILL_CYC_CD	A4	CI_BSEG
SQ_OVERRIDE_SW	A1	CI_BSEG
ITEM_OVERRIDE_SW	A1	CI_BSEG
BSEG_STAT_FLG	A2	CI_BSEG
CAN_RSN_CD	A4	CI_BSEG
CAN_RSN_DESCR	A30	CI_BILL_CAN_RSN
CUR_AMT	S13.2	CI_FT
TOT_AMT	S13.2	CI_FT

[Top of Page](#)

Bill Calc Header Record (1500)

Field Name	Format	Source/Value/Description
START_DT	D (A10)	CI_BSEG_CALC
END_DT	D (A10)	CI_BSEG_CALC

SETID	A10	CI_BSEG_CALC
RS_CD	A8	CI_BSEG_CALC
CALC_AMT	S13.2	CI_BSEG_CALC
DESCR_ON_BILL	A254	CI_BSEG_CALC

[Top of Page](#)

Bill Calc line Record (1700)

Field Name	Format	Source/Value/Description
APP_IN_SUMM_SW	A1	CI_BSEG_CALC_LN
CALC_AMT	S13.2	CI_BSEG_CALC_LN
EXEMPT_AMT	S13.2	CI_BSEG_CALC_LN
UOM_CD	A30	CI_BSEG_CALC_LN
TOU_CD	A30	CI_BSEG_CALC_LN
SQI_CD	A30	CI_BSEG_CALC_LN
BILL_SQ	S12.6	CI_BSEG_CALC_LN
DESCR_ON_BILL	A254	CI_BSEG_CALC_LN

[Top of Page](#)

End Bill Calc Header Record (1900)

Field Name	Format	Source/Value/Description
Dummy field		

[Top of Page](#)

Bill Segment Read Record (2100)

Field Name	Format	Source/Value/Description
SP_ID	A10	CI_BSEG_READ
BADGE_NBR	A16	CI_MTR
UOM_CD	A30	CI_BSEG_READ
TOU_CD	A30	CI_BSEG_READ
RDG_DEC_POS	N1	CI_REG. Decimal positions of the reads.
START_REG_READING	S9.6	CI_BSEG_READ
START_READ_DTTM	T (A26)	CI_BSEG_READ
START_ESTIMATE_SW	A1	CI_REG_READ
END_REG_READING	S9.6	CI_BSEG_READ
END_READ_DTTM	T (A26)	CI_BSEG_READ
END_ESTIMATE_SW	A1	CI_REG_READ
MSR_QTY	S12.6	CI_BSEG_READ
USAGE_FLG	A2	CI_BSEG_READ
USE_PCT	N3	CI_BSEG_READ

HOW_TO_USE_FLG	A2	CI_BSEG_READ
CONSUM_SUB_FLG	A2	CI_REG
MSR_PEAK_QTY_SW	A1	CI_BSEG_READ
REGISTER_CONST	S6.6	CI_BSEG_READ
QTY_DEC_POS	N1	CI_UOM. Decimal positions of the final quantity.
FINAL_UOM	A4	CI_BSEG_READ
FINAL_TOU	A8	CI_BSEG_READ
FINAL_REG_QTY	S12.6	CI_BSEG_READ
SQI_CD	A30	CI_BSEG_READ
FINAL_SQI_CD	A8	CI_BSEG_READ

[Top of Page](#)

Bill Segment SQ Record (2400)

Field Name	Format	Source/Value/Description
UOM_CD	A30	CI_BSEG_SQ
TOU_CD	A30	CI_BSEG_SQ
SQI_CD	A30	CI_BSEG_SQ
SQ_DEC_POS	N1	CI_BSEG_SQ
BILL_SQ	S12.6	CI_BSEG_SQ

[Top of Page](#)

Bill Segment Item Record (2700)

Field Name	Format	Source/Value/Description
START_DT	D (A10)	CI_BSEG_ITEM
END_DT	D (A10)	CI_BSEG_ITEM
ITEM_CNT	S9.2	CI_BSEG_ITEM
ITEM_DESCR	A60	CI_ITEM_TYPE

[Top of Page](#)

Bill Segment Message Record (2840)

Field Name	Format	Source/Value/Description
BILL_MSG_CD	A4	CI_BSEG_MSG
MSG_ON_BILL	A254	CI_BILL_MSG_L

[Top of Page](#)

End Bill Segment Record (2900)

Field Name	Format	Source/Value/Description
------------	--------	--------------------------

Dummy field

[Top of Page](#)

Histogram Record (3100)

Field Name	Format	Source/Value/Description
UOM_CD	A30	CI_SA_TYPE
TOU_CD	A30	
SQI_CD	A30	
SQ_DEC_POS	N1	CI_UOM. Decimal positions of SQ.
SQ_CNT	N2	Count of SQ (maximum of 13.)
MAX_BILL_SQ	S12.6	Maximum Bill SQ from list. This is derived from CI_BSEG_READ.
SQ_DT (1:13)	D (A10)	Date (for label of the SQ). This is derived from CI_BSEG.
BILL_SQ (1:13)	S12.6 (1:13)	13 occurrences of QTY, one for each period ending on the SQ_DT. This is derived from CI_BSEG_READ.

[Top of Page](#)

Adjustment Record (3400)

Field Name	Format	Source/Value/Description
ADJ_DT	D (A10)	CI_FT
FT_TYPE_FLG	A2	CI_FT
CUR_AMT	S13.2	CI_FT
TOT_AMT	S13.2	CI_FT
ADJ_TYPE_CD	A8	CI_ADJ
ADJ_TYPE_DESCR	A30	CI_ADJ_TYPE
DESCR_ON_BILL	A254	CI_ADJ_TYPE
CAN_RSN_CD	A4	CI_ADJ
CAN_RSN_DESCR	A30	CI_ADJ_CAN_RSN

[Top of Page](#)

Adjustment Calc Lines Record (3420)

Field Name	Format	Source/Value/Description
APP_IN_SUMM_SW	A1	Appears in Summary Y/N switch derived from CI_ADJ_CALC_LN
RS_CD	A8	Rate Schedule derived from CI_ADJ_CALC_LN
CALC_AMT	S13.2	Calculated Amount derived from CI_ADJ_CALC_LN

EXEMPT_AMT	S13.2	Exempt Amount derived from CI_ADJ_CALC_LN
UOM_CD	A30	Unit of Measure derived from CI_ADJ_CALC_LN
TOU_CD	A30	Time of Use derived from CI_ADJ_CALC_LN
SQI_CD	A30	SQI derived from CI_ADJ_CALC_LN
BILL_SQ	S12.6	Billable Service Quantity derived from CI_ADJ_CALC_LN
DESCR_ON_BILL	A254	Description on Bill derived from CI_ADJ_CALC_LN
APP_IN_SUMM_SW	A1	Appears in Summary Y/N switch derived from CI_ADJ_CALC_LN

[Top of Page](#)

End Service Agreement Record (3600)

Field Name	Format	Source/Value/Description
Dummy field		

[Top of Page](#)

End Premise Record (3700)

Field Name	Format	Source/Value/Description
Dummy field		

[Top of Page](#)

Message Record (3900)

Field Name	Format	Source/Value/Description
BILL_MSG_CD	A4	CI_BILL_MSGS
MSG_PRIORITY_FLG	A2	CI_BILL_MSG
INSERT_CD	A8	CI_BILL_MSG
MSG_ON_BILL	A254	CI_BILL_MSG

[Top of Page](#)

End Bill Record (9999)

Field Name	Format	Source/Value/Description
Dummy field		

[Top of Page](#)

Address Sub-Record

The address sub-record that appears in both the bill record (0100) and the premise record (0900) is composed of the following:

Field Name	Format	Description
COUNTRY	A3	
ADDRESS1	A254	Refer to The Source Of Bill Routing Information for a description of conditions when this field will contain a fax number or an Email address rather than the first line of a postal address (this only occurs for a bill record (0100)).
ADDRESS2	A254	
ADDRESS3	A254	
ADDRESS4	A254	
CITY	A90	
NUM1	A6	
NUM2	A4	
HOUSE_TYPE	A2	
COUNTY	A90	
STATE	A6	
POSTAL	A12	
GEO_CODE	A11	
IN_CITY_LIMIT	A1	

XML Bill Extracts

The system includes a sample bill extract algorithm that produces an XML document to interface to a document composition application. This is an alternative to the fixed flat file format described above. For additional details, see the algorithm type **Create XML bill extract records (C1-BLEX-XML)**.

Algorithms of this type construct the XML file records that contain the information that appears on a printed bill. Each record in the extract is constructed using an extendable data area and may be extended by an implementation using the Post Processing Script parameter. The following steps should be followed to include additional elements in the extract:

- Create a data area that includes the additional elements for the record you wish to extend. This data area must reference the base product data area used in the extract. For example, to extend the bill record, create a data area that references data area C1-BillPrintBillRecord as its extended data area. See the C1-BLEX-XML algorithm type for a complete list of the data areas available.
- Create a service script to retrieve the additional elements. This service script must be defined as the Post Processing Script on your algorithm and its schema must include the main bill extract data area (C1-BillPrintRecord).

For an example of how to extend the XML bill extract to include additional elements, see the CI_BillPrintXMLExtract export bundle included in the demo data.

Sequential Bill Numbers

Every bill is uniquely identified by its bill ID. Bill ID is a random, system-assigned number. In some locales, bills have an additional identifier known as a "sequential bill number". Sequential bill numbers are system-assigned, sequential numbers.

For example, the first bill produced by the system is assigned a sequential bill number of 1, the next bill is assigned a value of 2, etc. An additional requirement is that no gaps may exist between the sequential bill numbers.

The topics in this section describe how sequential bill numbers are implemented in the system.

Sequential Numbers Are Only Assigned If The Installation Option Is Turned On

Sequential bill numbers will only be assigned if you have selected Sequential Bill Numbers as the Alternative Bill ID Option on the [Installation](#) record.

Pending Bills Do Not Have A Sequential Bill Number

Bills are assigned a sequential bill number after they are completed. This means that pending bills will not have a sequential bill number. This is intentional as pending bills can be deleted and if a deleted bill had a sequential bill number, gaps would result. Refer to [Bill Lifecycle](#) for more information about a bill's state transition lifecycle.

When / How Is The Sequential Bill Number Assigned

WARNING:

This section is a technical explanation of how sequential bill numbers are assigned. It contains background information for those who wish to understand the rationale of the design.

The batch billing background process BILLING takes advantage of parallel processing to allow multiple bills to be produced concurrently. In addition, we allow groups of bills to be committed in "chunks" (based on the commit frequency assigned to the billing background process). These two facts make it impossible to allocate sequential bill numbers during batch billing (because back outs could result in gaps and parallel processing could result in duplicates). This is why sequential bill numbers are allocated as follows:

- A sequential bill number is allocated when a bill is completed online (by clicking the **Complete** button on [Bill - Main](#)).
- If you submit the batch billing process with the following [parameters](#), sequential bill numbers will be allocated when bills are completed:
 - **Batch thread number** must equal 1.
 - **Batch thread count** must equal 1.
 - **Override maximum records between commits** must equal 1.The above parameters mean that bills are not being produced in parallel and they are not being committed in "chunks". This allows the system to allocate sequential bill numbers when the bills are completed.
- If you do not run batch billing single-threaded, you must schedule the Assign Sequential Bill Numbers background process (ASSGNSBN) to run immediately after batch billing. This single-threaded process assigns sequential bill numbers to completed bills.
- The following measures are in place as a fail-safe:
 - If the bill print download background process (POSTROUT) encounters a bill without a sequential bill number, it will abort with an appropriate error message.

- Users are not allowed to delete a completed bill with a sequential bill number. Note, deletion of completed bills is typically prohibited due to the presence of frozen bill segments. However, it's possible to create a bill without frozen bill segments and additional logic exist to inhibit the deletion of such bills if they have sequential bill numbers.

Additional Functionality for Sequential Bill Numbering

The following points describe additional features that are enabled when the [Installation](#) record indicates sequential bill numbers are used:

- The bill's number appears in "bill info". "Bill info" is the concatenated string of information that summarizes a bill on many pages in the system.
- The Bill Search page includes an additional search option to search by bill number.
- The match type algorithm (DSO BILL-ID) that allows payments to be matched to a given bill id will try to match the payment to a bill with a matching sequential bill number.

Document Numbers

Every bill is uniquely identified by its bill ID. Bill ID is a random, system-assigned number. In some locales utilities may be required to assign and print an additional document number. For example, in Argentina a utility must obtain authorization from the national tax agency before they are allowed to print bills at a local office. Once authorized, the utility is assigned a printing authorization code valid for a period. The printing authorization code and expiration, as well as an official document number are printed on the bill at the location where the bill is issued.

The topics in this section describe how document numbers are implemented in the system.

Document Numbers Are Only Assigned If the Installation Option Is Turned On

Document numbers will only be assigned if you have selected Document Numbers as the Alternative Bill ID Option on the [Installation](#) record. In addition, the Document Number (C1-DOC-NBR) and Document Number Details (C1-DOCNBR-DT) algorithms must be enabled on the [Installation](#) record. These algorithms contain the logic used by the system to assign a document number to a bill.

The logic used to assign a document number can be quite complex. For example, the document number may depend on the issuing center, the bill's document type (credit memo, invoice or debit memo), the account's VAT category and the CIS division. Depending on your implementations complexity, you may choose one of the following possible configurations for document numbers:

- Populate the Document Number, Document Number Details and Document Sequence Number algorithms on the Installation record. The system will behave as follows:
 - During online bill completion, a document type is derived and captured on the bill along with other required bill characteristics and a document number is assigned
 - During batch billing, a document type is derived and captured on the bill along with other required bill characteristics. Assigning a document number is deferred to the Assign Bill Document Numbers background process. The idea here is that all complex logic is executed during the multi-threaded batch billing process leaving the minimal amount of work for the single-threaded batch process that assigns the document number.
- Populate the Document Number and Document Number Details algorithms on the Installation record. Here, the system assigns a document number during online bill completion, but skips the assignment of document type and number

during batch billing. The Assign Bill Document Numbers background process is responsible for deriving the bill's characteristics (document type, document classification, etc.) and assigning a document number.

Pending Bills Do Not Have a Document Number

Similar to sequential bill numbers, bills are assigned a document number after they are completed. This means that pending bills will not have a document number. Refer to [Bill Lifecycle](#) for more information about a bill's state transition lifecycle.

When/How Is the Document Number Assigned

WARNING:

This section is a technical explanation of how document numbers are assigned. It contains background information for those who wish to understand the rationale of the design.

- An installation algorithm assigns a document number to a bill.

Similar to sequential bill numbers, document numbers are allocated as follows:

- A document number is allocated when a bill is completed online (by clicking the **Complete** button on [Bill - Main](#)).
- The Assign Bill Document Numbers background process (C1-BNBAS) should be scheduled to run immediately after batch billing. This single-threaded process assigns document numbers to completed bills.
- The logic used to assign a document number resides in the installation options Document Number (C1-DOC-NBR) algorithm.
- The following measures are in place as a fail-safe:
- If the billing download process (POSTROUT) encounters a bill without a document number, it will abort with an appropriate error message.
- Users are not allowed to delete a completed bill with a document number. Note, deletion of completed bills is typically prohibited due to the presence of frozen bill segments. However, it's possible to create a bill without frozen bill segments and additional logic exist to inhibit the deletion of such bills if they have sequential bill numbers.

Additional Functionality Exists When Document Numbers Are Used

The following points describe additional features that are enabled when the [Installation](#) record indicates that document numbers are used:

- The Bill Search page includes an additional search option to search by Document Number and Document Type.
- The bill's document number and type appear in "bill info". "Bill info" is the concatenated string of information that summarizes a bill on many pages in the system.
- The match type algorithm (C1-PDOV-PYBN) that allows payments to be matched to a given bill id will try to match the payment to a bill with a matching document number and type.

Digital Signatures

In some locales, billing software is required to generate and store digital signatures for each bill. Digital signatures are used to secure bills that are stored in the database, and the digital key for the bill will be known only to the vendor.

CCB supports digital signatures with the following features:

- An Encryption feature configuration must be configured with an algorithm info option for the key alias and signing algorithm
- The installation algorithm, C1-BILLSIG, generates the digital signature for a bill and captures this on the bill itself. The algorithm also stores an alias of the private/public key pair on the Bill as a characteristic. See the installation algorithm, C1-BILLSIG, for a description of how the signature is generated.
- Bills are assigned a digital signature when they are completed.
 - The Assign Bill Document Numbers background process (C1-BNBAS) is responsible for generating digital signatures for a batch of bills. This batch job should be scheduled to run immediately after batch billing. See the description of the batch control and parameter settings for generating digital signatures.
 - A digital signature is also generated when a bill is completed online (by clicking the **Complete** button)

NOTE: The digital signatures features are only appropriate for customers who use document number in generating bill signatures.

For an example of the objects and instructions used for implementing this feature, see the `CI_BillIDocNumber & DigitalSignature` export bundle included in the demo data.

For details about setting up the required keystore for this feature, see the [Installation Guide](#).

Writing Off Bills

If your organization practices [open-item accounting](#) and your credit and collections rules revolve around [collecting on unpaid bills](#), you can set up the system to automatically write-off bills.

If you've enabled this functionality, [Bill - Main](#) will contain a button that a user can click to manually write off a bill. A corresponding button exists that a user can click to reverse a written-off bill.

FASTPATH:

Refer to [Writing Off Bills](#) for a description of how to set up the system to allow both automated and manual bill write off.

Idiosyncratic Manual Bill Cancellation

If a bill's account is associated with a Customer Class that has a Cancel Bill algorithm, the system invokes this algorithm before the bill is displayed to determine if the bill is "cancellable". If the algorithm indicates the bill is cancellable, a button appears on [Bill - Main](#). When clicked, the Cancel Bill algorithm is invoked again to cancel the bill. This functionality is meant to support unique cancellation needs required by some implementations; the sample base-package algorithm is empty.

Maintaining Bills

A bill is used to communicate changes in a customer's financial obligations to the customer. The topics in this section describe how to maintain bills.

NOTE:

The system creates most bills behind-the-scenes. Most bills are created by the system when it processes the bill cycle schedule. You should only have to access the bill pages to correct a bill or to add a bill real-time. For information about how the system creates bills, refer to [The Big Picture of Billing](#).

It's important to be aware that there are very few fields that are directly modifiable by a user. To modify most fields on a bill, you have to change source information (e.g., service agreement, rate, meter read) and then regenerate the bill. For example, if you want to change a bill's amount, you must cancel or add bill segments; you cannot change the bill's amount by modifying the bill amount field. Refer to [How To](#) for step-by-step instructions that explain how to perform common bill maintenance functions.

Bill Lifecycle

The following diagram shows the possible lifecycle of a bill.

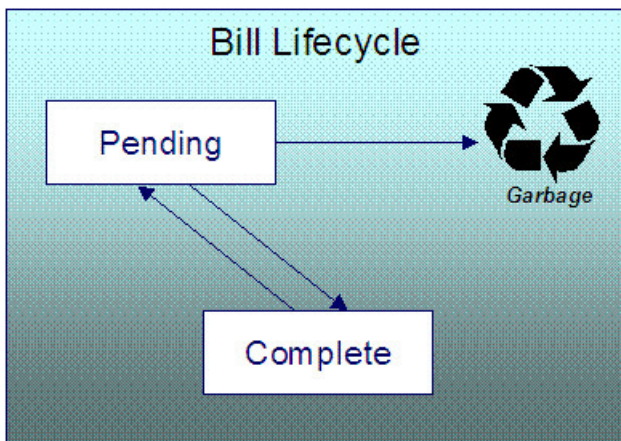

WARNING:

This explanation only makes sense in the context of the page used to maintain bills. Refer to [Bill - Main Information](#) for the details.

A bill is initially saved in the Pending state. You may create one or more bill segments for the account's service agreements at this point. Refer to [How To](#) for information about generating bill segments for the bill.

A bill becomes Complete when it is ready to be sent to the customer. Completing a bill triggers many things to occur. Refer to the section below for information about what happens when a bill is completed.

When you complete a bill, several things may happen:

- Pre-completion algorithms associated with the account's service agreements' [SA types](#) are executed. The system executes these algorithms first in the order of the [billing processing sequence](#) on each service agreement's SA type then in the order of the algorithm's sequence. These are not executed for the completion of [credit notes](#).
- Pre-completion algorithms associated with the account's [customer class](#) are executed.
- The bill's due date is calculated. This is equal to the bill date plus the number of days defined on the account's customer class. If the resultant date is not a workday, the due date is set to the next workday. Note, this due date can be overridden if an override algorithm exists on the account's customer class.
- The bill's routing information is set up using [Account - Person Information](#).
- If the Freeze At Bill Completion [installation option](#) has been turned on, freezable bill segments and adjustments linked to the account are frozen. Note, only freezable adjustments whose [adjustment type](#) indicates Freeze At Bill Completion

will be frozen at this time. Refer to [Preventing SA Balances And The GL From Being Impacted Until Bill Completion](#) for more information.

- If a final bill segment of a deposit service agreement is detected, the deposit is refunded to the customer using the refund method algorithm plugged-in on the deposit SA's deposit class. Refer to [Deposit Refund](#) for more information. This step is skipped during the completion of [credit notes](#), or if the bill is linked to an [off cycle bill generator](#).
- Bill completion algorithms associated with the account's service agreements' [SA types](#) are executed. The system executes these algorithms first in the order of the [billing processing sequence](#) on each service agreement's SA type then in the order of the algorithm's sequence.
- Bill completion algorithms associated with the account's [customer class](#) are executed.
- Bill messages are amalgamated from various sources and linked to the bill. Refer to [The Source Of Bill Messages](#) for more information.
- Other financial transactions that have been frozen since the last bill and are marked to show on bill are linked to the new bill
- For open-item customers adjustments and corrections are linked
- For [correction notes](#) or [credit notes](#), the bill cancellation financial transactions are linked
- For off cycle bill generator bills:
 - Adjustments linked to the off cycle bill generator are linked to the bill
 - If the off cycle bill generator is linked to a service agreement, then all non-payment financial transactions associated with the SA are linked to the bill
 - For all other situations, payments, adjustments and corrections are linked assuming the adjustments are not linked to an off cycle bill generator
- All financial transactions that don't already have a user-defined aging date will be dated with the current date. In other words, they start aging from the date the bill is completed.
- If the account pays automatically and the installation's Autopay Creation Option is to Create At Bill Completion, an automatic payment is created. Refer to APAY-CREATE for more information about the auto pay creation algorithm. This step is skipped during the completion of [credit notes](#).
- If the account's customer class indicates the account is an open-item customer, a match event is created. The bill's FTs and the automatic payment's FTs are linked to it. Refer to [Payments and Match Events](#) for more information about match events. This step is skipped during the completion of [credit notes](#).
- If the account pays automatically and the installation's Autopay Creation Option is to Create On Extract Date, the bill is stamped with the date when the automatic payment is to be created. Refer to APAYCRET, the background process that creates the automatic payment, and APAYDSFR, the background process that distributes and freezes the automatic payment, for more information. This step is skipped during the completion of [credit notes](#).
- The bill's late payment date is calculated. This is equal to the due date plus the grace days defined on the account's customer class. If the resultant date is not a workday, the LPC date is set to the next workday. This step is skipped during the completion of [credit notes](#).
- The account is marked for review by the account debt monitor on its due date plus a grace period defined on its customer class. This step is skipped during the completion of [credit notes](#).
- If the account's customer class indicates the account is an open-item customer, the system will create a match event if the new charges are offset by other financial transactions. Refer to [Payments and Match Events](#) for more information about match events. This step is skipped during the completion of [credit notes](#).
- The bill's status becomes Complete.
- Post bill completion algorithms associated with the account's [customer class](#) are executed.

If the system cannot complete the bill (for whatever reason), the bill remains Pending and an error message is shown on the main bill page. After correcting the cause of the problem, attempt to complete the bill again.

A complete bill may be changed back to pending using the [Reopen](#) button on [Bill - Main Information](#). You would reopen a bill when

- Add more bill segments to a completed bill. Refer to the [How To](#) section for information about linking bill segments for a bill.
- Fine-tune the payments, adjustments, and corrections that were linked to a completed bill. Refer to the [How To](#) section for detailed instructions.

When you're happy with the bill, you can complete it again.

NOTE:

Cannot reopen historical bills. You may only reopen an account's most recent bill (except if this bill is linked to an off cycle bill generator) because recompleting the bill causes the ending-balance to change, and we don't want this to happen to historical bills.

Automatic payments. If an automatic payment was created when the bill was completed and it has already been interfaced to the financial institution, you cannot reopen the bill. If the automatic payment exists, but it has not yet been interfaced, the system will automatically cancel the payment when you reopen the bill.

Certain bill completion algorithms prevent reopening. If a bill contains a service agreement whose SA type has a "transfer accounts receivable to service provider" algorithm, the system will not allow the bill to be reopened. Refer to [If You Deal With TBFU Service Providers You Can't Reopen Bills](#) for more information about this bill completion algorithm.

You may [delete](#) a Pending bill from the database. You may not delete a pending bill if: a) there are frozen bill segments linked to the bill, or b) if financial transactions were linked to the bill (and this can only happen if the bill had been previously completed).

In addition to removing the bill, the system will also remove unfrozen bill segments linked to the bill.

Bill - Main Information

Open [Menu](#) > [Financial](#) > [Bill](#) > [Search](#) to maintain core bill information.

The following discussion describes the fields on this page. Refer to [How To](#) for a description of how to perform common bill maintenance functions.

Description of Page

Bill Info contains a concatenation of important information about the bill (e.g., the bill date, its status, due date, ending balance, etc.). If [sequential bill numbering](#) has been enabled, the bill's number also appears. If document numbering has been enabled, the assigned document number and document type will also appear. If this bill is a [correction note](#) or [credit note](#), a message will appear indicating this along with the ID of the original bill. If the batch billing background process generates the bill, the bill information includes the bill cycle and window start date. Bills generated manually, i.e., off-schedule, do not have this information.

Bill ID is the system-assigned unique identifier of the bill.

Account ID identifies the customer who is responsible for the bill. The name of the main customer on the account appears adjacent.

If this bill is a [credit note](#) or [correction note](#), a message appears adjacent to the account information indicating that this bill is a credit note or correction note for another bill; this hyperlink will drill you to the original bill. If a credit note or correction note has been issued for one or more of this bill's bill segments, a message appears indicating such. **Bill Status** is the bill's status. Refer to [Bill Lifecycle](#) for the potential values and how to handle a bill when it exists in a given state. Adjacent to the bill status is the **Display Bill** button, which will display an online image of the bill when clicked. Refer to [How To Display A Bill On-line](#) for more information.

If the bill is associated with an off cycle bill generator, a message appears adjacent to the bill status indicating this and the hyperlink will take the user to the related off cycle bill generator.

NOTE:

You can only use the **Display Bill** button if your system has been configured to display an on-line image; otherwise, a message indicating that the service is not available will appear. This option can only be configured by your technical staff. The system comes with configurations to display bill images using a document composition application such as *BI Publisher* or to retrieve a bill image from an external source such as a bill print vendor. This feature can also work with other applications.

Due Date is the date on which the bill is due. A bill's due date is calculated as follows:

- Add the due days specified on the account's customer class to the bill date.
 - The resulting date is the due date unless it's not a workday. In this case, the due date is set to the next workday (workdays are defined in the installation options tables).
 - If the account's customer class has an override due date calculation algorithm, the due date may be overridden. Refer to [Setting Up Customer Classes](#) for more information.
-

NOTE:

Late payment charges. Late payment charges are calculated on the due date plus the grace period. Refer to [Defining Late Payment Charge Options](#) for more information.

Bill Date is the business date that was used when the bill was completed. For example, if batch billing starts on 11:55 pm on 1-Jan-2000 and a bill is produced at 1:00 am on 2-Jan-2000, this bill's bill date would be 1-Jan-2000.

Create Date/Time is the date and time on which the bill was originally created.

Completion Date/Time is the date and time on which the bill was completed.

If the customer [pays automatically](#) and the automatic payment has not yet been created, a brief message appears highlighting the date and amount of the future automatic payment. In addition, a button appears called **Stop Autopay**, that, when clicked, causes the associated automatic payment to stop. You might click this button if the customer indicates that they will send in a payment. After you click the **Stop Autopay** button, a message appears highlighting the stoppage. Refer to [How And When Are Automatic Payments Created](#) for more information about how to setup the system to defer the creation of automatic payments until the future automatic payment extract date.

In the **Message** area, a brief error message appears if there's a problem with the bill. The message area is suppressed if there are no problems with the bill.

Click the magnifying button to view the long explanation. The long explanation will provide information about the cause of the error (and how to fix it).

The **Late Payment Charge Details** section contains information about how the system determines when and whether to levy late payment charges:

- **Eligible for Late Payment Charge** can be checked if a charge should be levied for late payment. This field is defaulted based on the customer's customer class. If you want to excuse a bill from late payment charge processing uncheck this box.
 - **Late Payment Charge Date** is the date on which the system will levy a late payment charge if payment is not received. This date is calculated when the bill is completed. It is equal to the bill's due date plus the account's customer class's grace days. If this date does not fall on a workday, the date is set to the next available workday when the bill is completed. If you want to manually delay the onset of late payment charge processing, extend this date into the future.
-

FASTPATH:

Late payment charges. Late payment charges are calculated on the due date plus the grace period. Refer to [How Late Payment Charges Get Calculated](#) for more information.

Bill Summary summarizes the financial impact of the bill. The information that appears differs depending on whether the account is a [balance-forward](#) or [open-item account](#). If the account is a balance-forward customer, the following information appears:

- **Previous Period's Balance** is the balance from the account's last bill.
- **Total Payments** is the total amount of frozen or canceled payment segment financial transactions linked to this bill. Frozen payment segments appear as negative numbers (decreasing the amount owed by the customer), while canceled payment segments appear as positive numbers (increasing the amount owed). You can drill down on this balance to view the financial transactions that contribute to this total. Refer to [How To Remove Unwanted Payments From A Completed Bill](#) for a description of how to perform common maintenance functions.
- **Total Adjustments** is the total amount of frozen or canceled adjustment financial transactions linked to this bill. You can drill down on the balance to view the financial transactions that contribute to this total. Refer to [How To Remove Unwanted Adjustments From A Completed Bill](#) for a description of how to perform common maintenance functions.
- **Total Bill Corrections** is the total amount of canceled and / or rebilled bill segment financial transactions linked to this bill. You can drill down on the balance to view the financial transactions that contribute to this total.
- **Total Current Billing Charges** is the total amount of frozen bill segment financial transactions linked to this bill. You can drill down on the balance to view the financial transactions that contribute to this total.
- **Ending Balance For This Period** is the sum of the five amounts above. It is the amount owed by the customer as of the end of the bill period.

If the account is an [open-item customer](#), the following information appears under **Bill Summary**:

- **New Charges** is the total amount of frozen bill segment financial transactions linked to this bill. You can drill down on this value to view the financial transactions that contribute to this total.
- **Adjustments** is the total amount of frozen or canceled adjustment financial transactions linked to this bill. You can drill down on this value to view the financial transactions that contribute to this total. Refer to [How To Remove Unwanted Adjustments From A Completed Bill](#) for a description of how to perform common maintenance functions.
- **Corrections** is the total amount of canceled and / or rebilled bill segment financial transactions linked to this bill. You can drill down on this value to view the financial transactions that contribute to this total.
- **Total** is the sum of the above amounts. You can drill down on this value to view the financial transactions that contribute to this total.

If the account is an [open-item customer](#), the following information appears under **Match Summary** (note, this section is not displayed for balance-forward accounts):

- **X Balanced Item(s)** contains the count and total amount of financial transactions linked to this bill that are linked to balanced match events.
- **X Unbalanced Item(s)** contains the count and total amount of financial transactions linked to this bill that are linked to unbalanced match events.
- **X Disputed Item(s)** contains the count and total amount of financial transactions linked to this bill that are linked to disputed match events.
- **X Unmatched Item(s)** contains the count and total amount of financial transactions linked to this bill that are not linked to any match event.

Total Changes After Completion only appears if bill segments that appeared on the original bill have been subsequently [canceled](#) or [rebilled](#). The amount displayed is the net effect of all cancels and rebills. Note, you can use the **Remarks** column in the bill segments grid (to the right) to see which bill segments have been cancelled / rebilled.

If 25 or fewer bill segments are linked to this bill, the grid in the lower right portion of the page contains one row for every bill segment linked to the bill.

The following points describe each column in the grid:

- The **Bill Segment** column contains a concatenation of each bill segment's division, SA type, status and bill period. The division and SA type come from the bill segment's service agreement.
- The **Current Amount** column contains the bill segment's effect on the service agreement's current balance.
- The **Status** column shows the bill segment's status. Refer to [Bill Segment Lifecycle](#) for the possible values.
- The **Remarks** highlight special situations. The following remarks may appear:
 - Rebill after completion appears if the bill segment is a rebill that was created after the bill was sent to the customer. The financial impact of this bill segment appears as a "bill correction" on the next bill produced for the customer.
 - Rebill prior completion appears if the bill segment is a rebill that was created before the bill was sent to the customer.
 - Canceled after completion appears if the bill segment was canceled after the bill was sent to the customer. The financial impact of this bill segment appears as a "bill correction" on the next bill produced for the customer.
 - Canceled prior completion appears if the bill segment was canceled before the bill was sent to the customer.
 - If the bill segment's status is Error or Incomplete, this column contains an estimated value of this bill segment. The estimated value is calculated by computing an average daily amount from the service agreement's frozen bill segments in the last 365 days. This average is then applied to the number of days in this bill segment's bill period. If the bill segment doesn't have a bill period (rare, but possible), the historical average is not displayed.
 - If the bill segment's status is Error, this column also contains the error message.
 - Rebilled due to correction appears if a correction note was generated for the bill segment. This remark appears only if you have the Correction Note Billing Option specified in the [Installation](#) record.
 - Rebilled due to correction. Canceled after completion appears for a correction note that spawns another correction note. This remark appears only if you have the Correction Note Billing Option specified in the [Installation](#) record.

If more than 25 bill segments are linked to this bill, the grid in the lower right portion of the page contains a summary of the various bill segments linked to the bill.

The following points describe each column in the grid:

- The **Status** column shows the bill segment's status. Refer to [Bill Segment Lifecycle](#) for the possible values. Click on the hyperlink to transfer to the Bill Segments tab where the associated bill segments can be viewed.
- The **Total Bill Segments** column contains the number of bill segments linked to the bill with this **Status**. If the status is Error or Incomplete, this column contains an estimated value of these bill segments. The estimated value is calculated by computing an average daily amount from frozen bill segments in the last 365 days for each service agreement. This average is then applied to the number of days in each bill segment's bill period. Please note, an historical average cannot be computed if an Error or Incomplete bill segment does not have a bill period (rare, but possible).
- The **Total Amount** column contains the sum of the current amount of these bill segments.

At the bottom of the scroll is shown the **Total Generated Charge**. This represents the total amount of the bill segments. This amount may differ from the Total Current Billing Charges when:

- The bill is not Complete. A bill segment's financial effect is not shown on the bill until the bill is completed.
- A bill segment has been canceled / rebilled since the bill was completed.

The topics that follow describe each of the actions that appear in the **Bill SegmentAction** and **Bill Action** areas. Refer to [How To](#) for a description of typical business processes that use these buttons.

Generate

The **Generate** button causes a bill segment to be created for each service agreement linked to the account. The system generates bill segments in the order of the [billing processing sequence](#) on each service agreement's SA type.

This button is enabled when you are in add mode (*i.e.*, you are not displaying an existing bill) and you have selected an **Account ID**.

When clicked, the **Generate** window opens.

You must specify the following parameters in the **Generate** window to generate the bill segments:

- **Cutoff Date** is the last possible day of each bill segments bill period. The current date defaults when the window opens. Refer to [Ways To Control The End Date Of A Bill Segment](#) for more information.
- **Accounting Date** defines the financial period to which the new bill segments' financial transactions are booked. The current date defaults when the window opens.
- Check **Allow Estimates** indicates if Oracle Utilities Meter Data Management should estimate consumption if it cannot find a meter read.
- If the service agreements use meter reads, use the **Billing Option** to control how the system retrieves meter reads that appear on the bill. Choose Use Cut off Date if the meter reads must exist on the **Cutoff Date** (defined above). Choose Use Schedule if you want the service agreement's service point(s) measurement cycle schedule to control the meter reads that are used.

After specifying the parameters, click **Calculate** to create a new bill and new bill segments for the account. You see a summary of the bill segments in the lower right portion of the page.

Freeze

Clicking **Freeze** causes all freezable bill segments to become frozen. Refer to [Bill Segment Lifecycle](#) for more information about freezing.

This button is enabled if:

- the Freeze At Will **Bill Segment Freeze Option** on the [installation option](#) has been selected AND
- freezable bill segments exist AND
- there are no error, incomplete or pending cancel bill segments.

NOTE:

Freezing a day or more after generation. If, during freezing, bill segments in closed accounting periods are detected, a pop-up appears in which you can specify a new accounting date; this date is updated onto the offending bill segments. This only happens if the accounting period closes before you freeze the bill segments (the accounting date is stamped on a bill segment when it's generated).

If, after freezing, you're ready to send the bill to the customer click [Complete](#) to finalize the bill.

NOTE:

If problems are detected after freezing. A bill segment may not be changed after it is frozen. All subsequent changes must occur by canceling the frozen bill segment and creating a new bill segment. Refer to [How To Cancel A Bill Segment](#) and [How To Cancel / Rebill A Bill Segment](#) for more information.

Cancel Frozen

Clicking **Cancel Frozen** causes all frozen bill segments to become canceled. Refer to [Bill Segment Lifecycle](#) for more information about cancellation. This button is disabled if the bill is written off.

NOTE:

Pending cancels are not affected. Clicking **Cancel Frozen** does not affect bill segments that are pending cancel. To make a pending cancel bill segment canceled, transfer to [Bill Segment - Main](#) and click **Cancel**.

If you need to cancel a specific bill segment, either transfer to the next tab and cancel the bill segment in question or follow the instructions under [How To Cancel A Bill Segment](#).

This button is enabled if frozen bill segments are linked to the bill.

When clicked, the **Cancel Frozen Bill Segments** window opens.

In the **Cancel Frozen Bill Segments** window, you must specify the following parameters to cancel the frozen bill segments:

- **Cancel Reason** defines why you are performing the cancellation.
- **Accounting Date** defines the financial period to which the canceled bill segments' financial transactions are booked. The current date defaults when the window opens.

After specifying the parameters, click **Calculate** to cancel the frozen bill segments.

NOTE:

There is no Undo. Unlike cancellations performed on [Bill Segment - Main](#), there is no Undo action. This transaction moves the pending cancel bill segments to the cancel state immediately; whereas the bill segment transaction lets you examine the cancellation before you commit it. If you cancelled bill segments by mistake, you must generate and freeze new bill segments.

If the bill is pending, the cancellation causes the bill segments to be suppressed on the version of the bill sent to the customer (but they remain in the database for audit and financial reporting purposes).

If the bill is complete and you do not [Reopen](#) the bill, the financial impact of the canceled bill segments appears on the next bill created for the account (under Bill Corrections).

If the bill is complete you may be able to [Reopen](#) the bill and then [Complete](#) it. By doing this, you can suppress a frozen bill segment on a previously completed bill. This means that if you catch a problem after completion you don't necessarily have to show the problem to the customer. Rather, cancel the problem, reopen and then recomplete the bill (when you recomplete the bill the system marks the bill segment to be suppressed on the version sent to the customer because its cancellation appears on the same bill as the original charges).

Freeze / Complete

The **Freeze / Complete** button performs a variety of functions:

- all freezable bill segments (including rebills) become frozen
- all pending cancel bill segments become canceled
- all freezable adjustments whose [adjustment type](#) indicates Freeze At Bill Completion become frozen
- the bill is finalized and marked for transmission to the customer

Refer to [Bill Lifecycle](#) for information about what happens during bill completion. Refer to [Bill Segment Lifecycle](#) for more information about freezing.

This button is enabled if:

- the Freeze At Bill Completion Bill Segment Freeze Option on the [installation option](#) has been selected AND
- the bill is pending AND
- there are no bill segments or there are bill segments and all are freezable, pending cancel, frozen or canceled AND
- there are no error or incomplete bill segments.

When clicked, the **Complete** window opens.

If the **User May Override Bill Date** option has been enabled on the [Installation Record](#), you may override the **Bill Date** prior to completion. Otherwise, the **Bill Date** is the current date and cannot be changed. The current date defaults when the window opens.

NOTE:

Freezing a day or more after generation. If, during freezing, bill segments in closed accounting periods are detected, a pop-up appears in which you can specify a new accounting date; this date is updated onto the offending bill segments. This will only happen if the accounting period closes before you freeze the bill segments (the accounting date is stamped on a bill segment when it's initially generated).

After specifying the parameter, click **Calculate** to freeze and complete the bill.

Complete

The **Complete** button causes a bill to be finalized and marked for transmission to the customer. Refer to [Bill Lifecycle](#) for information about what happens during bill completion.

This button is enabled if:

- the Freeze At Will Bill Segment Freeze Option on the [installation option](#) has been selected AND
- the bill is pending AND
- there are no bill segments or there are bill segments and all are frozen or canceled.

When clicked, the **Complete** window opens.

If the **User May Override Bill Date** option has been enabled on the [Installation Record](#), you may override the **Bill Date** prior to completion. Otherwise, the **Bill Date** is the current date and cannot be changed. The current date defaults when the window opens. If completing a correction note, the user is prompted to enter a **Correction Note Date instead of a bill date** in the **Complete** window.

After specifying the above parameters, click **Calculate** to complete the bill.

Delete

The **Delete** button deletes a bill and its bill segments.

This button is enabled if:

- the bill is pending AND
- all bill segments are incomplete, freezable or in error.

Reopen

The **Reopen** button causes a bill to be reopened. Refer to [Bill Lifecycle](#) for information about why you would reopen a bill.

This button is enabled if:

- the bill is complete AND
- the bill is not written off AND
- this is the most recent bill produced for the account AND

- the bill is not linked to an off cycle bill generator AND
- reopening hasn't been prohibited for the bill. Refer to [Bill Lifecycle](#) for information about conditions that can prevent a bill from reopening.

After reopening a bill, it returns to the pending state and you can make changes to the account's financial transactions (e.g., add payments, adjustments, and bill segments). After which, you click [Complete](#) or [Freeze / Complete](#) to finalize the bill. Only one of these buttons is shown - the specific one depends on how your organization has set the **Bill Segment Freeze Option** on the [installation record](#).

Credit Note

The **Credit Note** button is used to cancel ALL bill segments and create a new bill that contains the cancellation details. We refer to this "negative bill" as a credit note. Refer to [Credit Notes - Presenting Cancellation Details on a Separate Bill](#) for more information.

This button is enabled if:

- the **Use Credit Notes** option on the [Installation](#) record is turned on AND
- the bill is not written off AND
- The bill has frozen bill segments.

To create credit notes for all frozen bill segments, click the **Credit Note** button without selecting any bill segments. A system message asks for confirmation that credit notes will be created for all frozen bill segments.

To create credit notes for specific frozen bill segments, select just those bill segments.

When clicked, the **Credit Note** window opens.

You must specify the following parameters in the **Credit Note** window to cancel the frozen bill segments:

- **Cancel Reason** defines why you are performing the cancellation.
- **Accounting Date** defines the financial period to which the canceled bill segments' financial transactions are booked. The current date defaults when the window opens.
- **Credit Note Date** defines the date of the credit note on which the cancellation details appear. The current date defaults when the window opens.

After specifying the parameters, click **Calculate** to cancel the frozen bill segments and create a credit note.

It should be noted that if this operation is successful, the new "negative bill" is complete. It is ready for transmission to the customer and for interface to the general ledger.

NOTE:

If you want to issue a credit note for a specific bill segment. Rather than cancel all bill segments on a bill, you can create a credit note for a specific bill segment on a bill. To do this, drill down on the bill segment in question and then click the Credit Note button on the [bill segment page](#). You can also issue a credit note for selected bill segments on the next tab by selecting the desired bill segments and clicking the **Credit Note** button.

Correction Note

The **Correction Note** button is used to cancel and rebill ALL bill segments and create a new bill that contains the cancellation and rebill details. We refer to the resultant bill as a correction note. Refer to [Correction Notes - Presenting Correction Notes on a Separate Bill](#) for more information.

This button is enabled if:

- the **Correction Note** Billing Option is specified on the [Installation](#) record AND
- the bill is complete AND
- there is at least one frozen bill segment on the bill or all of the bill's bill segments are frozen or cancelled AND
- there are no bill segment financial transactions that have been transferred out of the system.

When clicked, the **Correction Note** window opens.

You must specify the following parameters in the **Correction Note** window to correct the bill segment:

- **Cancel Reason** defines why you are performing the correction.
- **Cutoff Date** is the last possible day of each bill period for a bill segment. The current date defaults when the window opens. Refer to [Ways To Control The End Date Of A Bill Segment](#) for more information.
- **Accounting Date** defines the financial period that the financial transactions are booked for a bill segment. The current date defaults when the window opens.
- Check **Allow Estimates** to indicate if Oracle Utilities Meter Data Management should estimate consumption if it cannot find a meter read.
- Use the **Billing Option** to define how the system looks for meter reads:
 - Select Use Schedule if the system should select reads based on the SA's SP measurement cycle schedule.
 - Select Use Cut off Date if the system should only select reads from the end date of the existing bill segment.
- If you prefer to have the system use the consumption details used on the original bill segments, check **Use Old Read/Item/SQ**. If this switch is on, neither **Allow Estimates** nor **Billing Option** is relevant.

NOTE: The **Use Old Read/Item/SQ** switch is not available if the bill's SA references an SA type with a special role flag of Bill Determinants Required.

- After specifying the parameters, click **Calculate** to correct the bill segments and create a correction note. The Bill Page opens and displays the Correction Note.

Once you complete a correction note, it cannot be reopened.

After you create a correction note, the **Undo Correction Note** button is activated.

The button is enabled if:

- the **Correction Note** Billing Option is specified on the [Installation](#) record AND
- the bill is a correction note AND
- the bill is not linked to an off cycle bill generator AND
- all of the bill segments for the correction note are freezable.

NOTE:

If you want to issue a correction note for a specific bill segment. You can create a correction note for a specific bill segment on a bill. To do this, drill down on the bill segment in question and then click the **Correction Note** button on the [bill segment page](#). You can also issue a correction note for selected bill segments by selecting the desired bill segments and clicking the **Correction Note** button.

Write Off

Refer to [Writing Off Bills](#) for a description of when the **Write Off** button appears and what happens if the button is clicked.

Reverse Write Off

Refer to [Writing Off Bills](#) for a description of when the **ReverseWrite Off** button appears and what happens if the button is clicked.

Cancel Bill

Refer to [Idiosyncratic Manual Bill Cancellation](#) for a description of when the **Cancel Bill** button appears and what happens if the button is clicked. Note that if the bill is linked to an off cycle bill generator, this button is not enabled.

Bill - Bill Segments

You can use this page to view all or selected bill segments linked to a bill. In addition, you can also perform certain maintenance functions on this page (see the details below).

Open **Menu > Financial > Bill > Search** and navigate to the **Bill Segments** page to view this information.

NOTE:

If the bill has more than 25 bill segments and you don't use the go to buttons in the bill segment grid on the Main tab to drill over to this information, the search criteria are intentionally left blank in order to avoid retrieving all bill segments (with the resultant slow response times). You must therefore use the **SA Filter** and the **Status Filter** to define the type of bill segments that should be retrieved. See the Description of page below for more information about this page's search criteria.

The Description of page section below describes the fields on this page. Refer to [How To](#) for a description of how to perform common maintenance functions.

Description of page

Bill Info contains a concatenation of important information about the bill (e.g., the bill date, its status, due date, ending balance, etc.).

Bill ID is the system-assigned unique identifier of the bill.

NOTE:

If the bill has more than 25 bill segments and you don't use the hyperlinks in the bill segment grid on the Main tab to drill over to this page, the **Filters** are intentionally left blank in order to avoid retrieving all bill segments (with the resultant slow response times). You must therefore use the **SA Filter** and the **Status Filter** to define the type of bill segments that should be retrieved.

The area beneath **BillInfo** provides you with options that control which bill segments appear in the grid. The following points describe the various options:

- Use the **SA Filter** to define the types of service agreements whose bill segments appear in the grid. The following options are available:
- Address. Use this option to restrict bill segments to those whose service agreements are linked to service points associated with a given **Address**, **City** and/or **Postal** code. Note, you can specify any combination of these fields.
- All. Use this option if you do not wish to restrict bill segments based on service agreement attributes.

- **Geographic Type.** Use this option to restrict bill segments to those whose service agreements are linked to service points associated with a given **Geo Type** and **Value**.
- **SA Type.** Use this option to restrict bill segments to those whose service agreements are linked to a given **CIS Division** and **SA Type**.
- Use **Status Filter** to restrict the bill segments based on their status. The following options are available:
 - All. This option shows all bill segments regardless of status.
 - Refer to [Bill Segment Lifecycle](#) for the various status values.

Don't forget to click the search button after changing the filters.

The **Select All / Clear All** buttons are used to select bill segments if you plan on issuing any of the mass update actions at the bottom of the page. These buttons are enabled if either of the following conditions is true:

- All bill segments that appear in the grid are in the Error, Freezable and/or Incomplete states.
- All bill segments that appear in the grid are in the Frozen state

Refer to the description of the "mass update" actions below for more information.

NOTE:

20 bill segments at a time. Clicking **Select All** selects the first 20 bill segments in the grid. If more than 20 bill segments exist, you must select them in batches.

The grid that follows contains the bill segments that match your search criteria. The following information appears in the grid:

- **Select box.** See the mass update description immediately above for conditions under which this checkbox can be used to select bill segments for mass update actions.
- The **Bill Segment** column contains a concatenation of the bill segment's division, SA type, status and bill period. The division and SA type come from the bill segment's service agreement. Click the hyperlink to transfer to [Bill Segment - Main Information](#). On this page you can perform maintenance functions (e.g., cancel/rebill, delete, cancel, etc., depending on the segment's status) on the bill segment in question.
- The **Current Amount** column contains the bill segment's effect on the service agreement's current balance.
- The **Status** shows the bill segment's status. Refer to [Bill Segment Lifecycle](#) for the possible values.
- The **Remarks** column highlights special circumstances associated with the bill segment.
- **Rebill after completion** appears if the bill segment is a rebill that was created after the bill was sent to the customer. The financial impact of this bill segment appears as a "bill correction" on the next bill produced for the customer.
- **Rebill prior completion** appears if the bill segment is a rebill that was created before the bill was sent to the customer.
- **Canceled after completion** appears if the bill segment was canceled after the bill was sent to the customer. The financial impact of this bill segment appears as a "bill correction" on the next bill produced for the customer.
- **Canceled prior completion** appears if the bill segment was canceled before the bill was sent to the customer.
- If the bill segment's status is Error or Incomplete, this column contains an estimated value of this bill segment. The estimated value is calculated by computing an average daily amount from the service agreement's frozen bill segments in the last 365 days. This average is then applied to the number of days in this bill segment's bill period. If the bill segment doesn't have a bill period (rare, but possible), the historical average is not displayed.
- If the bill segment's status is Error, this column also contains the error message.
- **Rebilled due to correction note** appears if the correction note was generated for the bill segment. This remark is generated only if you have Correction Note specified in the [Installation](#) record.
- **Rebilled due to correction. Canceled after completion** appears for a correction note that spawns another correction note. This remark is generated only if you have Correction Note specified in the [Installation](#) record.

- The **Service Quantity** and **UOM** (unit of measure) columns contain the amount of consumption that was billed. The UOM is defined on the service agreement's [SA type](#).
- The **Bill Segment ID** is the system-assigned unique identifier of the bill segment.

This transaction has sophisticated logic that can be used to perform "mass updates" to the bill segments that appear in the grid (using the buttons at the bottom of the page). The following points describe these mass update actions:

Generate (Bill - Bill Segments)

The **Generate** button is used to delete and recreate one or more bill segments. This button is enabled if you select at least one row from the bill segments grid that's in the Error, Freezable and/or Incomplete state.

Note that you can only select a bill segment for regeneration if ALL bill segments in the grid are in the Error, Freezable and/or Incomplete states. Note, you can use the **Status Filter** to restrict the type of bill segments in the grid.

When clicked, the **Generate** window opens.

You must specify the following parameters in the **Generate** window to regenerate a new bill:

- **Accounting Date** defines the financial period to which the new bill segments' financial transactions will be booked. The current date defaults when the window opens.
- Check **Allow Estimates** to indicate if Oracle Utilities Meter Data Management should estimate consumption if it can't find a meter read.
- If the service agreements use meter reads, use the **Billing Option** to control how the system retrieves meter reads that appear on the bill. Choose Use Cut off Date if the meter reads must exist on the **Cutoff Date** (defined above). Choose Use Schedule if you want the service agreement's service point(s) measurement cycle schedule to control the meter reads that are used.

After specifying the parameters, click **Calculate** to regenerate the selected bill segments. A summary of what the system does is presented next.

Freeze (Bill - Bill Segments)

The **Freeze** button is used to freeze one or more bill segments. This button is enabled if you select at least one row from the bill segments grid that's in the Freezable state AND the [installation option](#) indicates users are allowed to "freeze at will".

Note that you can only select a bill segment for freezing if ALL bill segments in the grid are in the Freezable state. Note, you can use the **Status Filter** to restrict the type of bill segments in the grid.

When clicked, the **Freeze** window opens.

Accounting Date is used to define the financial period to which the frozen bill segments' financial transactions are booked. The current date defaults when the window opens.

After specifying the above parameters, click **Freeze** to freeze the selected bill segments. A summary of what the system does is presented next.

Delete (Bill - Bill Segments)

The **Delete** button is used to delete one or more bill segments. This button is enabled if you select at least one row from the bill segments grid that's in the Error, Freezable and/or Incomplete state.

Note that you can only select a bill segment for deletion if ALL bill segments in the grid are in the Error, Freezable and/or Incomplete states. Note, you can use the **Status Filter** to restrict the type of bill segments in the grid.

If the system is successful in deleting the selected bill segment(s), a confirmation window summarizes what the system just did (i.e., it shows the number of bill segments that were deleted).

Cancel/Rebill/Freeze (Bill - Bill Segments)

If problems are detected with a frozen bill segment, it should be canceled and a new bill segment should be created. We refer to this process as cancel / rebill. Refer to [Cancel / Rebill Incorrect Bill Segments](#) for more information.

Before you cancel / rebill, you'll probably need to fix the cause of the problem. The following table describes common problems and how to fix them.

Problem	How To Fix It
The wrong rate was used	Go to Service Agreement - Rate Info and correct the rate.
The wrong meter was connected to the service point	
A contract rider was applied incorrectly	Go to Service Agreement - Rate Info and correct the contract rider information.
The wrong tax exemption amount was calculated	Go to Service Agreement - Rate Info and correct the tax exemption information.

NOTE:

Multi-Cancel/Rebill Saves Time. If the cause of the problem impacts many bill segments related to a service agreement, you should use the [Multi Cancel Rebill](#) transaction as it allows you to cancel / rebill an unlimited number of bill segments at once. Also note that for service agreements that require bill determinants from Oracle Utilities Meter Data Management, this transaction may only be used to cancel / rebill a single bill segment at a time.

Credit Notes. Using the cancel/rebill functionality causes the cancel and rebill details to be swept on to the customer's next bill unless you [Reopen](#) the bill. If your organization requires cancellation details to be presented to the customer separately from the new bill, you should not use the **Rebill** functionality. Rather, you should issue a [Credit Note](#) and then generate a new bill containing the revised charges.

The **Cancel/Rebill/Freeze** button is used to cancel, rebill and freeze one or more bill segments. This button is enabled if you select at least one row from the bill segments grid that's in the Frozen state AND the bill is not written off.

Note that you can only select a bill segment for cancel/rebill/freeze if ALL bill segments in the grid are in the Frozen state. Note, you can use the **Status Filter** to restrict the type of bill segments in the grid.

When clicked, the **Cancel/Rebill/Freeze** window opens.

- **Cancel Reason** defines why the bill segment(s) are being canceled.
- **Accounting Date** defines the financial period to which the canceled and new bill segments' financial transactions are booked. The current date defaults when the window opens.
- Check **Allow Estimates** to indicate if Oracle Utilities Meter Data Management should estimate consumption if it cannot find a meter read.
- Use the **Billing Option** to define how the system looks for meter reads:
 - Select **Use Schedule** if the system should select reads based on the SA's SP measurement cycle schedule.
 - Select **Use Cut off Date** if the system should only select reads from the end date of the existing bill segment.
 - If you prefer to have the system use the consumption details used on the original bill segments, check **Use Old Read/Item/SQ**. If this switch is on, neither **Allow Estimates** nor **Billing Option** is relevant.

NOTE: The **Use Old Read/Item/SQ** switch is not available if the bill's SA references an SA type with a special role flag of Bill Determinants Required.

WARNING:

If the cause of the rebill is an incorrect rate and the new rate requires service quantities that were not calculated when the bill was originally calculated, do not turn on **Use Old Read/Item/SQ**. Why? Because you want the system to derive new service quantities during the rebill process.

After specifying the parameters, click **Calculate** to cancel, rebill and freeze the selected bill segments.

NOTE:

Errors. Bill segment errors may occur when you cancel / rebill the bill segments. For example, if you change the SA's rate to a rate that requires a unit-of-measure that doesn't exist on the SA's meter, a bill segment error is generated. If this occurs, you must go to [Bill Segment - Main](#) for the pending cancel bill segment and use the **Undo** action to remove the offending bill segment (and restore the original segment to the Frozen state). Alternatively, you can drill down on the Error bill segment and use the **Regenerate** action after correcting the cause of the problem.

There is no Undo. Unlike cancel / rebills performed on [Bill Segment - Main](#), there is no Undo action. This is because this transaction freezes the newly created bill segments after it cancel/rebills; whereas the bill segment transaction lets you examine the new bill segment before you freeze it. If you made a mistake, simply correct the cause of the mistake and then cancel / rebill again. The erroneous financial transactions are automatically suppressed on the next bill produced for the customer.

A confirmation window summarizes what the system just did (i.e., it shows the number of bill segments that were deleted / generated).

Cancel (Bill - Bill Segments)

The **Cancel** button is used to cancel one or more bill segments. This button is enabled if you select at least one row from the bill segments grid that's in the Frozen state AND the bill is not written off.

Note that you can only select a bill segment for cancellation if ALL bill segments in the grid are in the Frozen state. Note, you can use the **Status Filter** to restrict the type of bill segments in the grid.

When clicked, the **Cancel** window opens.

- **Cancel Reason** defines why the bill segment(s) are being canceled.
- **Accounting Date** is used to define the financial period to which the canceled bill segments' financial transactions are booked. The current date defaults when the window opens.

After specifying the above parameters, click **Calculate** to cancel the selected bill segments.

NOTE:

There is no Undo. Unlike cancellations performed on [Bill Segment - Main](#), there is no Undo action. This transaction moves the pending cancel bill segments to the cancel state immediately; whereas the bill segment transaction lets you examine the cancellation before you commit it. If you cancelled bill segments by mistake, you must generate and freeze new bill segments.

Credit Note (Bill - Bill Segments)

The **Credit Note** button is used to cancel selected bill segments and create a new bill that contains the cancellation details. We refer to this "negative bill" as a credit note. Refer to [Credit Notes - Presenting Cancellation Details on a Separate Bill](#) for more information.

This button is enabled if:

- the **Use Credit Notes** option on the [Installation](#) record is turned on AND
- if you select at least one row from the bill segments grid that's in the Frozen state AND
- the bill is not written off.

Note that you can only select a bill segment for this action if ALL bill segments in the grid are in the Frozen state. Note, you can use the **Status Filter** to restrict the type of bill segments in the grid.

When clicked, the **Credit Note** window opens.

You must specify the following parameters in the **Credit Note** window to cancel the frozen bill segments:

- **Cancel Reason** defines why you are performing the cancellation.
- **Accounting Date** defines the financial period to which the canceled bill segments' financial transactions are booked. The current date defaults when the window opens.
- **Credit Note Date** defines the date of the credit note on which the cancellation details appear. The current date defaults when the window opens.

After specifying the parameters, click **Calculate** to cancel the frozen bill segments and create a credit note.

It should be noted that if this operation is successful, the new "negative bill" is complete. Refer to [Bill Lifecycle](#) for information about the steps that take place during completion. It is ready for transmission to the customer and for interface to the general ledger.

NOTE:

If you want to issue a credit note for an entire bill. Rather than cancel a specific bill segment, functionality exists that allows you to create a credit note for ALL bill segments on a bill. To use this feature, display the bill in question and then click the Credit Note button on the [bill page](#).

Correction Note (Bill - Bill Segments)

The **Correction Note** button is used to cancel and rebill bill segments and create a new bill that contains the cancellation and rebill details. We refer to the resultant bill as a correction note. Refer to [Correction Notes - Presenting Correction Notes on a Separate Bill](#) for more information. This button is enabled if:

- the **Correction Note** option is specified on the [Installation](#) record AND
- the bill is complete AND
- the bill segment is frozen AND
- there are no bill segment financial transactions that have been transferred out of the system.

When clicked, the **Correction Note** window opens.

You must specify the following parameters in the **Correction Note** window to correct the bill segment:

- **Cancel Reason** defines why you are performing the correction.
- **Cutoff Date** is the last possible day of each bill segments bill period. The current date defaults when the window opens. Refer to [Ways To Control The End Date Of A Bill Segment](#) for more information.
- **Accounting Date** defines the financial period to which the corrected bill segments' financial transactions are booked. The current date defaults when the window opens.

- Check **Allow Estimates** to indicate if Oracle Utilities Meter Data Management should estimate consumption if it cannot find a meter read.
- Use the **Billing Option** to define how the system looks for meter reads:
 - Select Use Schedule if the system should select reads based on the SA's SP measurement cycle schedule.
 - Select Use Cut off Date if the system should only select reads from the end date of the existing bill segment.
- If you prefer to have the system use the consumption details used on the original bill segments, check **Use Old Read/Item/SQ**. If this switch is on, neither **Allow Estimates** nor **Billing Option** is relevant.

NOTE: The **Use Old Read/Item/SQ** switch is not available if the bill's SA references an SA type with a special role flag of Bill Determinants Required.

- After specifying the parameters, click **Calculate** to correct the bill segments and create a correction note. The Bill Page opens and displays the Correction Note.

NOTE:

If you want to issue a correction note for an entire bill. You can create a correction note for ALL bill segments on a bill. To use this feature, display the bill in question on the [Bill page](#) and click the **Correction Note** button.

Bill - Bill Routings

This page is used to view the recipients of a bill. Refer to [Printing Bills](#) for a discussion of how this information is used to produce bill images.

This page is also used to request a new copy of a bill. Refer to [How To Reprint A Bill \(For The Original Recipients or For Someone New\)](#) for a description of how to do this.

NOTE:

No routing information until completion. A bill has no routing details until it is completed. At completion time, the system creates a routing detail for every person linked to the account that receives a copy of its bills. Refer to [The Source Of Bill Routing Information](#) for more information about how this information is constructed.

Use **Menu > Financial > Bill > Search** and navigate to the **Bill Routings** page.

Description of Page

Bill Info contains a concatenation of important information about the bill (e.g., the bill date, its status, due date, ending balance). If [sequential bill numbering](#) has been enabled, the bill's number also appears.

Bill ID is the system-assigned unique identifier of the bill.

The **Bill Routing Information** scroll contains an entry for each recipient of the bill. This information is disabled after the bill has been routed to the recipient. The remainder of this discussion describes the fields that can be defined for each recipient of the bill.

Person ID identifies the person who was originally associated with the routing record. You may change the **Person ID** to any person in the system as this information is only used to default the recipient's name and address information, below.

The **Bill Routing Parameters** area contains information explaining how and when the bill is routed to the recipient. This information is gray when the bill routing information has been extracted or if a bill is reopened:

- **Bill Route Type** is the method used to transmit the bill to the customer. If the **Person ID** is linked to the account, the bill route type defaults from the person's [Account - Person Information](#).
- **Sequence** is the system-assigned identifier assigned to this bill routing.

- **Batch Control** is the identifier of the batch of bills in which the recipient's copy was downloaded. The batch process is defined on the **Bill Route Type** or CIS Division.
- **Extract Date/Time** is the date and time the bill was downloaded. This information only appears after the download has commenced.
- **Format** indicates if the customer should receive a Detailed or a Summary bill. If the **Person ID** is linked to the account, this information defaults from [Account - Person Information](#).
- **Reprint** is checked if a user created this routing. This switch is populated by the system and is always protected.
- Turn on **Do Not Extract** if the bill should not be routed to the individual for whatever reason.
- **Copies** indicates the number of copies of the bill the person receives. If the **Person ID** is linked to the account, this information defaults from [Account - Person Information](#).
- **PO ID** is the purchase order Id the customer wants printed on their copy of the bill. If the **Person ID** is linked to the account, this information defaults from [Account - Person Information](#).
- **Intercept** is the User ID of the individual who wants to review the bill before it is sent to the customer. This field is automatically populated when the account has a Bill Print Intercept specified (intercept information is defined on [Account - Main Information](#)). For a one-time intercept, a user can enter their ID in this field before the bill, or reprint, has been extracted.

NOTE: Adding a User ID to the Intercept field will not automatically populate the Bill Print Intercept field on the Account's Main page; nor, will it affect future bill routings.

The **Mailing Address Information** area contains the recipient's name and address.

- If the recipient has an [override mailing name](#), **Name1**, **Name2** and **Name3** contain the person's override mailing name. Otherwise, **Name1** contains the recipient's primary name (this name might also include a prefix or suffix if the related [Account - Person](#) relationship has these fields defined).
- The remaining fields are the recipient's address. Refer to [The Source Of Bill Routing Information](#) for information about how the system constructs the recipient's address. Note:
- If the recipient's address is a mailing address (as opposed to fax or email), the **Country** associated with the address controls the fields that appear in the address. Refer to [Defining Countries](#) for more information on the address constituents.
- If a user manually adds a routing record, the mailing address information defaults from the information on the current routing record.
- If a user specifies a **Person ID** that is linked to the bill's account, the **Bill Route Type** defined on the [Account - Person](#) record is defaulted.
- If a user specifies a **Person ID** that is not linked to the bill's account, the **Bill Route Type** on the [installation record](#) is defaulted. Note, if the bill route indicates the bill is routed via the postal service, the system will only be able to default the person's address if the person has an override mailing address on their [correspondence information](#).
- If the user changes the **Bill Route Type** after the initial default, the system populates the address information as described under [The Source Of Bill Routing Information](#).
- The Validate button on the bill page will only be available if you have set the Allow Address Validation option type to Y on the General System Configuration feature configuration. Once clicked, the Address Validation Script on the General System Configuration feature configuration will be invoked to validate the entered address. Refer to [Implementing Address Validation](#) for more information.

Bill - Bill Messages

The Messages page is a grid containing one row for every message that appears on the bill. Open **Menu > Financial > Bill > Search** and navigate to the **Bill Messages** page to view this information.

NOTE:

No messages until completion. A bill has no messages until it is completed (unless you insert them manually). At completion time, the system assembles messages from the various message sources. Refer to [The Source Of Bill Messages](#) for information about these sources.

The bill segment(s) may also have messages. Be aware that only account-oriented messages are linked to a bill. There may also be service agreement-oriented messages linked to the bill's bill segments. Refer to [Bill - Bill Messages](#) for information about the page on which service agreement-oriented messages are displayed. Refer to [The Source Of Bill Messages](#) for information about the various message sources and whether each is linked to a bill or a bill segment.

Bill messages may contain dynamic information. Refer to [Substituting Field Values Into A Bill Message](#) for more information.

The **Description of Page** section below describes the fields on this page. Refer to [How To Add Ad Hoc Messages To A Bill](#) for a description of how to perform common maintenance functions.

Description of Page

Bill Info contains a concatenation of important information about the bill (e.g., the bill date, its status, due date, ending balance). If [sequential bill numbering](#) has been enabled, the bill's number also appears.

Bill ID is the system-assigned unique identifier of the bill.

The following columns are displayed in the grid:

- **Bill Message** is the code that identifies the bill message.
- **Message On Bill** is the message associated with the code.
- **Priority** is the bill messages priority (on the printed bill).
- **Insert Code** defines if the bill message causes an insert in the envelope.

Bill - Characteristics

The Characteristics page is a grid containing one row for each characteristic linked to the bill. Bill characteristics are purely informational.

NOTE:

You can only choose characteristic types defined as permissible on a bill record. Refer to [Setting Up Characteristic Types and Their Values](#) for more information.

Open **Menu > Financial > Bill > Search** and navigate to the **Characteristics** page to view this information.

Description of Page

The following fields display on the grid:

- **Characteristic Type** must be a type of characteristic defined as permissible on a bill record.
- **Sequence** Controls the order in which characteristics of the same type are displayed.
- **Characteristic Value** indicates the value of the characteristic if the characteristic type is pre-defined or foreign key reference.

How To

The topics in this section describe how to perform common bill maintenance functions.

How To Create A Bill For All Service Agreements Linked To An Account

99.9% of all bills are created by the batch bill process and require no human intervention before they are finalized and sent to a customer. The other 0.1% are created by users on-line / real time. This section explains how to create the 0.1%.

The following points describe how to use this page to create a new bill:

- Navigate to the [Bill - Main Information](#) page:
- If you have already selected the customer (say on Control Central), select **Go To Bill > Add** option on the account context menu. [context menu](#). This will transfer you to this page with the respective account populated.
- If you haven't selected the account, use Menu to navigate to this page (**Menu > Financial > Bill > Add**) and then select the **Account ID** using the adjacent [search button](#).
- Click the [Generate](#) button to create a new bill.
- You will see a summary of the bill segments in the lower right portion of the page. If there are errors, refer to [How To Correct A Bill Segment That's In Error](#). If there are no errors, the **Bill Segment Freeze Option** on the [installation option](#) controls the next step:
- If this option is set to Freeze At Bill Completion, click the [Freeze / Complete](#) button.
- If this option is set to Freeze At Will, click the [Freeze](#) button and, if everything looks clean, click the [Complete](#) button.

How To Create A Bill For A Specific Service Agreement

Most bills contain a bill segment for every service agreement linked to the account. If you want to produce a bill that contains bill segments for a subset of service agreements (e.g., you want to create a one-time invoice for an account's billable charge service agreement), follow these steps:

- Navigate to the [Bill - Main Information](#) page:
- If you have already selected the customer (say on Control Central), select **Go To Bill > Add** option on the account context menu. [context menu](#). This will transfer you to this page with the respective account populated.
- If you haven't selected the account, use Menu to navigate to **Menu > Financial > Bill > Add**, and then select the **Account ID** using the adjacent [search button](#).
- Click the [save](#) button to create a bill without bill segments for the account.
- Select **Go To Bill Segment +** option on the Bill's [context menu](#) to transfer to [Bill Segment - Main](#).
- Select the **SA ID** of the service agreement for which you want to create a bill segment.
- Click the [Generate](#) button to generate a bill segment.
 - If an error exists, refer to [How To Correct A Bill Segment That's In Error](#).
 - If there are no errors, the **Bill Segment Freeze Option** on the [installation option](#) controls the next step:
 - If this option is set to Freeze At Bill Completion, return to [Bill - Main](#) (using the bill context menu) and click the [Freeze / Complete](#) button.

- If this option is set to Freeze At Will, click the [Freeze](#) button and, if everything looks clean, return to [Bill - Main](#) and click the [Complete](#) button.

How To Create a Bill with no Bill Segments

You may wish to generate a bill that contains no bill segments. For example, perhaps your customer is billed quarterly but pays monthly. During the months where no charges are calculated, you may choose to send a "bill" that does not show new charges, but includes the payments received. To produce a bill with no bill segments, follow these steps:

- Navigate to the [Bill - Main Information](#) page:
- If you have already selected the customer (say on Control Central), select **Go To Bill > Add** option on the account context menu. [context menu](#). This will transfer you to this page with the respective account populated.
- If you haven't selected the account, use Menu to navigate to this page (**Menu > Financial > Bill > Add**) and then select the **Account ID** using the adjacent [search button](#).
- Click the [save](#) button to create a bill without bill segments for the account.
- At this point either the **Complete** or **Freeze / Complete** button (based on the value of Bill Segment Freeze Option on [installation options](#)) becomes enabled. Click the applicable button for your installation to complete the bill. At this point, all the steps described for completing a bill in Bill Lifecycle are performed, including sweeping onto the bill any payments received since the last bill was generated.

How To Create A One-Time Invoice

The following points describe the steps necessary to create and bill a one-time invoice:

- If the customer to be invoiced doesn't already have an appropriate billable charge service agreement, create one. The easiest way to do this is from [Start/Stop Service](#).
- Use [Maintaining Billable Charges](#) to add a billable charge for the service agreement. The billable charge contains the invoice lines and amounts. The system will produce the bill for this charge when the account's bill cycle next executes. If you can't wait until that time, proceed to the next step.
- If you created a new billable charge service agreement in step 1, you must activate it before billing can bill it. To do this, transfer to [Service Agreement - Main Information](#) and click the activate button.
- Refer to [How To Create A Bill For A Specific Service Agreement](#) for instructions describing how to create a bill with a bill segment for the billable charge service agreement.

How To Correct A Bill Segment That's In Error

A bill segment will exist in the Error state if a problem was encountered during the generation of a bill segment. To fix an error bill segment you must correct the cause of the error and then regenerate the bill segment. Refer to [Bill Segment Errors](#) for background information.

NOTE:

Error segments created during batch billing. If the error bill segment was created as part of the batch bill process, the system attempts to fix the offending segment(s) each night during the account's bill window by regenerating it. Therefore, if the cause of the error is fixed during the day, the system will automatically regenerate the bill segment

when batch billing next runs; you don't have to manually correct each bill. And once a bill is error-free, it will be completed and sent to the customer. Refer to [Batch Billing](#) for more information.

Correcting the cause of a bill segment error can be difficult or trivial; we hope that the error messages (along with their long descriptions) provide a good description of how to resolve the issue.

After you have corrected the cause of the error, you should regenerate the bill segment. There are two ways to do this:

- You can use the [Generate](#) action on [Bill - Bill Segment](#) to regenerate one or more bill segments. We recommend using this method if the cause of the error affected many bill segments because you can regenerate many bill segments at a time on this page. Also, be aware that this transaction shows the estimated value of error bill segments so you can gauge whether to invest a lot of time in correcting the problem. For example, if the bill segment's estimated value is \$10,000, it's probably worth correcting the problem before sending the bill out. However, if the bill segment's value is small, you may decide to simply delete the error bill segment and send the bill without it (the system will attempt to create a bill for the deleted period the next time the account is billed).
- You can use the [Generate](#) action on [Bill Segment - Main](#) to regenerate an individual bill segment. We'd recommend using this method if the problem is bill segment-specific and you need to examine the information that is snapshot on the bill segment to resolve the error (e.g., you need to look at calculation/audit read details and service quantities).

NOTE:

Drilling Into Bill Segment Errors. When you use the bill segments in error To Do list to work through errors, you will be transferred to [Bill Segment - Main](#) with the bill segment displayed.

After all errors have been resolved on a bill, return to [Bill - Main](#). The **Bill Segment Freeze Option** on the [installation option](#) controls the next step:

- If this option is set to Freeze At Bill Completion, click the [Freeze / Complete](#) button.
- If this option is set to Freeze At Will, click the [Freeze](#) button and, if everything looks clean, click the [Complete](#) button.

How To Correct A Bill That's In Error

Besides errors on bill segments, there may also be errors detected when the system attempts to complete a bill. For example, if the system cannot find a mailing address, the bill will be in error (as opposed to one of its bill segments). Refer to [Bill Errors](#) for background information.

To correct such an error:

- Navigate to [Bill - Main](#).
- Look at the bill's error message. Push the view button to view the long explanation that will provide suggestions as to the cause of the error (and how to fix it). Transfer to the appropriate page to fix the problem.
- After fixing the cause of the error, return to [Bill - Main](#). The **Bill Segment Freeze Option** on the [installation option](#) controls the next step:
- If this option is set to Freeze At Bill Completion, click the [Freeze / Complete](#) button.
- If this option is set to Freeze At Will, click the [Freeze](#) button and, if everything looks clean, click the [Complete](#) button.

How To Cancel A Bill Segment

If a bill segment was frozen and it should never have been created in the first place, the bill segment must be canceled. There are several ways to do this:

- You can use the [Cancel Frozen](#) action on [Bill - Main](#) to cancel all frozen bill segments linked to the bill. We recommend using this method if you need to cancel everything on a bill.
- You can use the [Cancel](#) action on [Bill - Bill Segments](#) to cancel selected bill segments. We recommend using this method if you need to cancel multiple bill segments.
- You can use the [Cancel](#) action on [Bill Segment - Main](#) to cancel an individual bill segment. We'd recommend using this method if you need to examine the information on the bill segment before canceling it.

If the related bill is pending, the cancellation will cause the bill segment to be suppressed on the version of the bill sent to the customer (but it remains in the database for audit and financial reporting purposes).

If the related bill is complete and you do not [Reopen](#) the bill, the financial impact of the canceled bill segment(s) will appear on the next bill created for the account (under Bill Corrections).

If the related bill is complete you may be able to [Reopen](#) the bill and then [Complete](#) it. By doing this, you can suppress a frozen bill segment on a previously completed bill. This means that if you catch a problem after completion you don't necessarily have to show the problem to the customer. Rather, cancel the problem, reopen and then recomplete the bill (when you recomplete the bill the system will mark the bill segment to be suppressed on the version sent to the customer because its cancellation appears on the same bill as the original charges).

How To Cancel / Rebill A Bill Segment

If a bill segment was frozen but it contains incorrect information, it should be canceled and a new bill segment should be created. We refer to this process as cancel / rebill. Refer to [Cancel / Rebill Incorrect Bill Segments](#) for more information.

Before you cancel / rebill, you must correct the cause of the problem. The following table describes common problems and where to go to fix them.

Problem	How To Fix It
The wrong rate was used	Go to Service Agreement - Rate Info and correct the rate.
The wrong meter was connected to the service point	
A contract rider was applied incorrectly	Go to Service Agreement - Rate Info and correct the contract rider information.
The wrong tax exemption amount was calculated	Go to Service Agreement - Rate Info and correct the tax exemption information.

After correcting the cause of the problem, you're ready to cancel and rebill the offending bill segment(s). There are several ways to do this:

- You can use the [Cancel / Rebill / Freeze](#) action on [Bill - Bill Segments](#) to cancel, rebill and freeze selected bill segments. We recommend using this method if you need to cancel / rebill multiple bill segments due to a pervasive problem.
- You can use the [Rebill](#) action on [Bill Segment - Main](#) to cancel and rebill an individual bill segment. We'd recommend using this method if you need to examine the information on the bill segment before and after canceling it. If you use this method, you must also use the [Freeze](#) action to freeze the newly created bill segment.
- If the cause of the problem impacts many bill segments related to a service agreement, you should use the [Multi Cancel Rebill](#) transaction as it allows you to cancel / rebill an unlimited number of bill segments at once. Also note that for service agreements that require bill determinants from Oracle Utilities Meter Data Management, this transaction may only be used to cancel / rebill a single bill segment at a time.

If the related bill is pending, the cancellation will cause the erroneous bill segment to be suppressed on the version of the bill sent to the customer (but it remains in the database for audit and financial reporting purposes).

If the related bill is complete and you do not [Reopen](#) the bill, the financial impact of the canceled bill segment(s) and their rebill bill segment(s) will appear on the next bill created for the account (under Bill Corrections).

If the related bill is complete you may be able to [Reopen](#) the bill and then [Complete](#) it. By doing this, you can suppress an erroneous frozen bill segment on a previously completed bill. This means that if you catch a problem after completion you don't necessarily have to show the problem to the customer. Rather, cancel / rebill the problem, reopen and then recomplete the bill (when you recomplete the bill the system will mark the bill segment to be suppressed on the version sent to the customer because its cancellation appears on the same bill as the original charges).

How To Create A Credit Note

A credit note is used to cancel bills segments and present the results of this cancellation on a separate bill. This separate bill is referred to as a credit note. Refer to [Credit Notes - Presenting Cancellation Details on a Separate Bill](#) for more information.

NOTE:

Installation option must be turned on. If your organization creates credit notes, be sure to select the Credit Note Billing Option on the [Installation Options](#). If you don't select this option, the credit note buttons will not be enabled.

Before creating a credit note, you must first determine whether a single bill segment must be canceled or whether all bill segments for a bill must be canceled:

- If you need to issue a credit note for the entire bill, navigate to the [Bill](#) page and click the [Credit Note](#) button.
- If you need to issue a credit note for a specific bill segment, navigate to the [Bill Segment](#) page and click the [Credit Note](#) button.

NOTE:

Open-item customers. If any of the bill segments are associated with an open-item customer class AND the original bill segment is an open item, the match event will be created and balanced with the original FT and the cancellation FT, assuming you have the appropriate FT freeze algorithm plugged-in on the customer class.

Issuing a credit note for a specific bill segment. You may also issue a credit note for an individual bill segment. When you create a credit note for an individual bill segment, that bill segment is canceled and a new credit note bill is created for that single bill segment's cancellation information.

How To Create A Correction Note

The **Correction Note** button is used to cancel and rebill bill segments and present the cancellation and rebill details on a separate bill. Refer to [Correction Notes - Presenting Correction Notes on a Separate Bill](#) for more information.

NOTE:

Installation option must be turned on. If your organization creates correction notes, be sure to select the Correction Note Billing Option on the [Installation Options](#). If you don't select this option, the correction note buttons will not be enabled.

Before creating a correction note, you must first determine whether the note should impact a single bill segment or whether all bill segments for a bill must be corrected:

- If you need to issue a correction note for the entire bill, navigate to the [Bill](#) page and click the [Correction Note](#) button.
- If you need to issue a correction note for a specific bill segment, navigate to the [Bill Segment](#) page and click the [Correction Note](#) button.

NOTE:

Open-item customers. If any of the bill segments are associated with an open-item customer class AND the original bill segment is an open item, the match event will be created and balanced with the original FT and the cancellation FT, assuming you have the appropriate FT freeze algorithm plugged in on the customer class.

Issuing a correction note for a specific bill segment. You can also issue a correction note for an individual bill segment. When you create a correction note for an individual bill segment, that bill segment is canceled and a new correction note bill is created for that single bill segment's cancellation information.

How To Create An Off Cycle Bill Generator

An off cycle bill generator is used to create an off cycle bill for an account. You control the financial transactions that are linked to the bill. To create a bill using the base off cycle bill generator business object, follow these steps:

- With an account in context, select **Account Context Menu > Go To Off Cycle Bill Generator** +. (*See context menu for more information about Context Menus.*) This will transfer you to this portal with the respective account populated.
- Select the adjustments, billable charges and/or service agreements that you wish to include in the bill.
- Enter the required bill information to be used when creating the bill; this includes the Cutoff Date, Accounting Date, Allow Estimates switch, Billing Option and Bill Date.
- Click the [save](#) button.
- Click the Complete button to transition the off cycle bill generator to the complete state and create the bill. Any errors encountered while attempting to create the bill will be captured in the off cycle bill generator's log.
- Refer to [Off Cycle Bill Generator](#) for more information.

How To Override The Items Billed On A Specific Bill Segment

The [How the System Requests How Much Was Consumed](#) used by the customer is one of the first steps that happens when a bill segment is created. 99.9% of the time, the system does a perfect job in this effort. However, there are rare circumstances when, due to missing or incorrect data, the quantity calculated by the system is not correct.

To help you deal with these rare situations, a "back door" exists that allows a bill segment's billable quantities to be overridden. This truly is a "back door" because the proper way to fix the amount of a commodity is to correct the cause of the error and then cancel / rebill the bill segment.

This section describes how to override the total number of items billed on a bill segment. You would do this in the rare situation when you cannot get the [item snapshot](#) to reflect the amount of consumption you need to bill.

- Display the error or freezable bill segment on [Bill Segment - Main](#).

IMPORTANT:

You can only override consumption on a bill segment that is in Error or Freezable. This means you must generate a bill segment before you can override the item details.

- Transfer to the [Bill Segment - Item Details](#) tab.
- Insert one row in the item grid (click the + button) for each item you need to add. You may also change item amounts that were populated by the system when it initially generated the bill.
- Save the bill segment.
- [Generate](#) the bill segment.
- If the bill segment still looks wrong, repeat the above points until the bill segment is correct.

- The **Bill Segment Freeze Option** on the [installation option](#) controls the next step:
- If this option is set to Freeze At Bill Completion, return to [Bill - Main](#) (using the bill context menu) and click the [Freeze / Complete](#) button.
- If this option is set to Freeze At Will, click the [Freeze](#) button and, if everything looks clean, return to [Bill - Main](#) and click the [Complete](#) button.

How To Remove Unwanted Adjustments (or Payments) From A Completed Bill

If the system (or a user) has created adjustments that have been swept onto a recently completed bill but you don't want them to appear on the bill (e.g., the system generated a late payment charge but you want to forgive it) perform the following steps:

- Cancel the adjustment ([Adjustment - Main Information](#)).
- Navigate to the [Bill - Main](#) page.
- Click the [Reopen](#) button to reopen the previously completed bill.
- Click the [Complete](#) button to recomplete the bill. When the bill is recompleted, the system will see that an adjustment that was swept onto the bill when it was originally completed has been canceled and it will mark the adjustment for suppression on the printed bill.

You can remove unwanted payments using an analogous approach - Cancel the payment, Reopen the bill, Complete the bill.

NOTE:

Cannot reopen historical bills. You may only reopen an account's most recent bill because recompleting the bill causes the ending-balance to change, and we don't want this to happen to historical bills.

How To Add An Adjustment (or Payment) To A Completed Bill

If you want to add an adjustment to a completed bill perform the following steps:

- Add and freeze the adjustment ([Adjustment - Main Information](#)).
- Navigate to the [Bill - Main](#) page.
- Click the [Reopen](#) button to reopen the previously completed bill.
- Click the [Complete](#) button to recomplete the bill. When the bill is recompleted, the system will sweep the recently created financial transactions onto itself.

You can add a payment to a bill using an analogous approach - Add the payment, Reopen the bill, Complete the bill.

NOTE:

Cannot reopen historical bills. You may only reopen an account's most recent bill because recompleting the bill causes the ending-balance to change, and we don't want this to happen to historical bills.

How To Reprint A Bill (For The Original Recipients or For Someone New)

A copy of a bill is sent to every individual / business specified in the [bill's routing details](#). The system creates the routing details when a bill is completed. Refer to [The Source Of Bill Routing Information](#) for more information about how this information is compiled during bill completion.

If you want to reprint a bill OR if you want to send a bill to someone other than the original recipient(s):

- Navigate to the [Bill - Main](#) page.
- Transfer to the [Bill - Bill Routings](#) tab.
- Insert a new row (click the + button). Note well, you can only insert information on a bill that is Complete.
- Specify the name and address to which the bill should be sent. If you want to send the bill to someone other than the original recipient, simply specify the individual's name and address. If the recipient is a person in the system, you can select their person ID and let the system default this information for you.
- Save the bill.

NOTE:

If a bill is Complete but the print process hasn't yet executed, you don't have to insert a new routing row. Rather, you can simply change the name and address on the original routing details.

How To Add Ad Hoc Messages To A Bill

If you want to add a message to a completed bill:

- Navigate to the [Bill - Main](#) page.
- Transfer to the [Bill - Bill Messages](#) tab.
- Insert a new row (click the + button). Note, you can only insert a message on the most recent bill that is Complete.
- Specify the desired message code.
- Save the bill.
- Reprint the bill as per [How To Reprint A Bill \(For The Original Recipients or For Someone New\)](#).

FASTPATH:

Refer to [The Source Of Bill Messages](#) for more information about the messages the system automatically links to a bill when the bill is completed.

How To Remove A Completed Bill

You can't physically remove a completed bill from the system. However, you can remove all financial transactions from the bill (and therefore end up with a zero value bill). You can also suppress the bill from being printed. To do this, perform the following steps:

- If the bill has bill segments, cancel each bill segment. Refer to [How To Cancel A Bill Segment](#) for instructions describing how to do this.
- If the bill has payment amounts or adjustment amounts that were entered incorrectly, navigate to the payment and/or adjustment pages and cancel the payments / adjustments.
- Navigate to the [Bill - Main](#) page.
- Click the [Reopen](#) button to reopen the previously completed bill.
- Transfer to the [Bill - Bill Routings](#) tab. Turn on the Do Not Print switch for every routing entry.

- Click the [Complete](#) button to recomplete the bill. When the bill is recompleted, the system will sweep the canceled segments onto it and the net effect should be zero current charges.

NOTE:

Cannot reopen historical bills. You may only reopen an account's most recent bill because reCompleting the bill causes the ending balance to change, and we don't want this to happen to historical bills.

If the bill has payment amounts or adjustment amounts that are valid, but you don't want them to appear on this bill, navigate to the **Menu > Financial > Bill > Search** and navigate to the **Financial Details** page. Drill over to each respective financial transaction by clicking the drill down button. Clicking this button transfers you to [Financial Transaction - Main](#). On this page, clear out the value of the Bill ID. Clearing out the Bill ID unlinks the financial transaction from the bill. When the system next completes a bill for the account, it will find the unbilled financial transaction and link it to the bill.

How To Display A Bill On-line

There are multiple ways to display a bill. Each requires the use of the Installation Option — Online Bill Display plug-in spot.

- One method is to make a call to retrieve a bill image from an external source. Many bill print vendors support this method and support REST or web service calls to request the bill image, often in the PDF format. The system is delivered with an algorithm that can construct a URL to retrieve a bill image.
- Another method uses software to render the bill in a format suitable for displaying. You must configure the system to invoke this software; otherwise, you will get a message indicating that the service is not available. This option can only be configured by your technical staff. The system can be configured to work with different bill production software, and is delivered with an algorithm that can display a bill on-line using BI Publisher or a document composition application. With a document composition application, the bills are presented in PDF format.

To view a bill on-line, click the **Display Bill** button. For any method that present the bill as a PDF, you must have Adobe® Acrobat® Reader installed.

Financial Transactions On A Bill

Open **Menu > Financial Query > Financial Transactions On A Bill** to view this information.

NOTE:

You can also open this page using the go to buttons that prefix the financial transaction summaries on [Bill - Main](#).

Description of page

Bill Id is the system-assigned unique identifier of the bill.

Account ID is the bill's account.

The area beneath **AccountID** provides you with options that control which financial transactions appear in the grid. The following points describe the various options:

- Use the **SA Filter** to define the types of service agreements whose financial transactions appear in the grid. The following options are available:
 - Address. Use this option to restrict financial transactions to those whose service agreements are linked to service points associated with a given **Address, City** and/or **Postal** code.
 - All. Use this option if you do not wish to restrict financial transactions based on service agreement attributes.

- **Geographic Type.** Use this option to restrict financial transactions to those whose service agreements are linked to service points associated with a given **Geo Type** and **Value**.
- **SA ID.** Use this option to restrict financial transactions to those of a specific service agreement.
- **SA Type.** Use this option to restrict financial transactions to those whose service agreements are linked to a given **CIS Division** and **SA Type**.
- Use **FT Type Filter** to restrict the type of financial transactions that appear in the grid. The following options are available:
 - **Adjustments.** This option shows all financial transactions associated with adjustments.
 - **All.** This option shows all financial transactions.
 - **Corrections.** This option shows all financial transactions associated with corrections (i.e., cancel / rebills that have occurred after the bill was completed).
 - **Current Charges.** This option shows all financial transactions associated with bill segments (that aren't Corrections).
 - **Payments.** This option shows all financial transactions associated with payments.
- Use **Match Event Status Filter** to restrict the financial transactions based on the status of their [match event](#). This filter only appears if the bill's account is an [open-item](#) customer. The following options are available:
 - **All.** This option shows all financial transactions.
 - **Balanced.** This option shows all financial transactions whose match event is balanced.
 - **Disputed.** This option shows all financial transactions whose match event is disputed.
 - **Unbalanced.** This option shows all financial transactions whose match event is unbalanced.
 - **Unmatched.** This option shows all financial transactions that are not linked to a match event.

WARNING:

Don't forget to click the search button after changing the filters or after selecting a new Bill ID.

The grid that follows contains the financial transactions that match your search criteria. The following information is displayed:

- **Match Event Status** shows the status of the financial transaction's [match event](#). This column only appears if the bill's account is an [open-item](#) customer.
- **FT Type** displays the type of financial transaction except for adjustments. For adjustments, the adjustment type's description is shown. Click on the hyperlink to transfer to [Financial Transaction - Main](#). On this page, you can change certain aspects of the FT in question. Refer to [How To Remove Unwanted Adjustments \(or Payments\) From A Completed Bill](#) for a description of how to perform common maintenance functions.
- **Accounting Date** is the date the system uses to determine the financial transaction's accounting period in your general ledger.
- **Current Amount** contains the financial transaction's effect on the service agreement's current balance.
- **Payoff Amount** contains the financial transaction's effect on the service agreement's payoff balance. The **Payoff Amount** will be dim if it equals the **Current Amount**.
- **Show on Bill** indicates if information about the financial transaction appears on the customer's bill.
- **SA Information** contains a summary of the respective service agreement.
- **Financial Transaction ID** is the system-assigned unique identifier of the financial transaction.

At the bottom of the page is a summary of the financial transactions that match the search criteria.

Maintaining Bill Segments

A bill typically contains one bill segment for every active service agreement linked to its account. A bill segment contains information showing how the segment was calculated and how it should be printed on the customer's bill.

The actions taken to create a bill segment are dependent on the service agreement's SA type. For example, a service agreement that charges for metered service is produced as follows:

- The system requests for the amount or usage consumed (or billing determinants) from Oracle Utilities Meter Data Management (e.g., the number of lamps, the number of gallons of water, the peak kW, etc.). Refer to [How the System Requests How Much Was Consumed](#) for the details.
- The service agreement's rate is applied to the amount consumed to calculate how much the customer owes for the service. A bill segment and a financial transaction are generated to reflect the results of this calculation. Refer to [How Rates Affect The Information On Bill Segments](#) for the details. Refer to [Effective Dates & Price Proration](#) for information about how the system prorates changes to rates and prices during a bill period.

NOTE:

SA type controls everything. The above points explain how a bill segment is produced for a **bill determinants required** service agreement. It's important to be aware that the system has other bill segment creation algorithms. For example, if the service agreement charges for a deposit, the system neither amalgamates consumption nor does it apply a rate. You may be wondering how the system knows which method to use? It uses the bill segment type on the service agreement's SA type. Refer to [Designing and Defining Bill Segment Types](#) for a description of the various bill segment creation algorithms that are supported in the system.

It's important to be aware that there are very few fields that are directly modifiable by a user. To modify most fields on a bill segment, you have to change source information (e.g., service agreement, rate, meter read) and then regenerate the bill segment. For example, if you want to change the rate used to calculate a bill segment, you must change the rate history on the respective service agreement and then cancel / rebill the bill segment. Refer to [How To](#) for step-by-step instructions that explain how to perform common bill segment maintenance functions.

Bill Segment Lifecycle

The following diagram shows the possible lifecycle of a bill segment.

WARNING:

This diagram only makes sense in the context of the page used to maintain bill segments. Refer to [Bill Segment - Main Information](#) for the details.

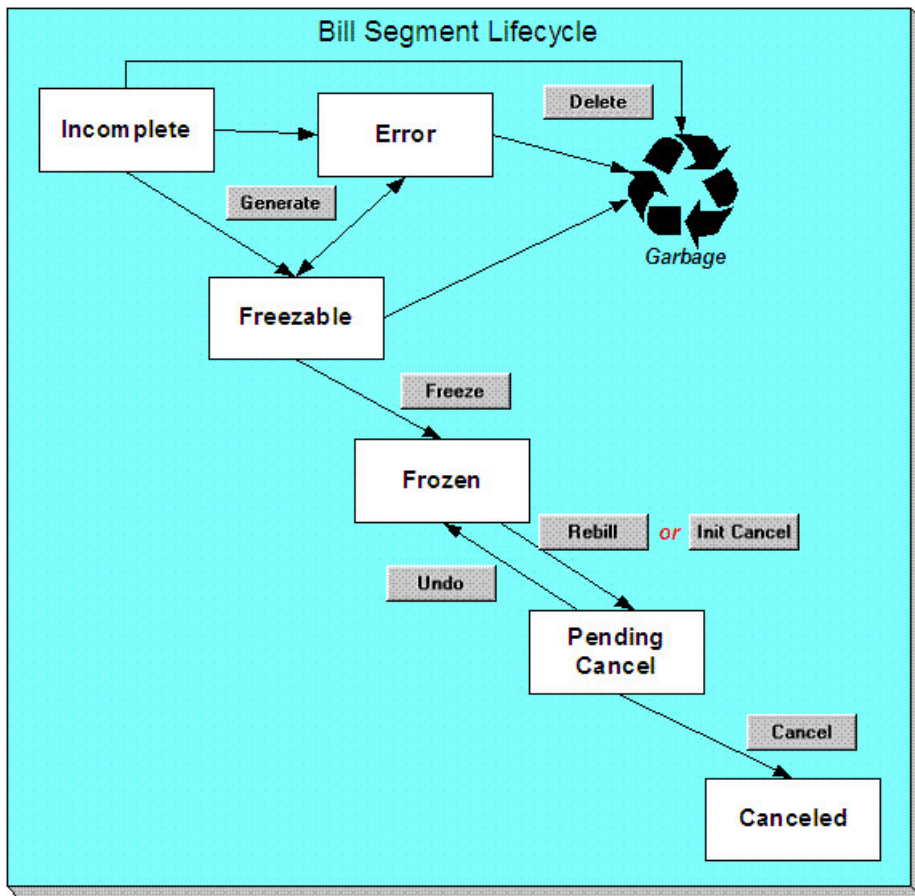

Bill segments are initially created in the Incomplete state. Bill segments in this state don't have bill lines or a financial transaction; they are simply a stub awaiting generation.

Click **Generate** to generate the bill segment's bill lines and its financial transaction.

- If the system cannot generate the bill segment (for any number of reasons), the bill segment is moved to the Error state. You may regenerate the bill segment after correcting the source of the error (by clicking **Generate**). You may also delete such a bill segment.
- If the system successfully generates a bill segment, the bill segment becomes Freezable. If the bill segment is incorrect, correct the cause of the problem (e.g., fix the meter read, change the service agreement's rate) and regenerate the bill segment (by clicking **Generate**).

Click the delete button to physically remove an Incomplete, Error or Freezable bill segment from the database. Note, batch billing will delete unfrozen bill segments when it attempts to create bill segments for an account that has unfrozen bill segments. Also note, if you've plugged-in the appropriate pre-completion algorithm, the system will delete bill segments in error on the last night of the bill cycle. Refer to DEL-BSEG for more information.

Click **Freeze** to freeze a bill segment and its financial transaction. After doing this, the bill segment's state becomes Frozen and the bill segment may now appear on a customer's bill. Also note, when a bill segment is frozen, its financial details will be interfaced to the general ledger the next time the [GL interface](#) executes.

You may not change a bill segment once it is frozen. However, you have two options if you want to change a frozen bill segment's financial impact:

- If you need to remove the financial effects of a bill segment, click **Init Cancel**. Clicking this button causes a new financial transaction to be generated and linked to the bill segment. This financial transaction reverses the financial effects of the original bill segment. The bill segment becomes Pending Cancel after the system successfully generates this financial transaction. At this point, you have two options:

- Click **Cancel** to freeze the cancellation. Clicking this button causes the bill segment to move to the Canceled state. Once canceled, the bill segment cannot be uncanceled or changed.
- Click **Undo** to return the pending cancellation to the Frozen state.
- Click **Rebill** if you need to recalculate the bill segment because something has changed since it was originally created (e.g., the service agreement's rate was changed, a new read was entered). Clicking this button causes the following events to take place:
 - The original bill segment is moved to the Pending Cancel state.
 - A new bill segment is created in the Freezable (or Error) state.

At this point, you have two options.

- Click **Freeze** to make the new bill segment Frozen and make the original bill segment Canceled.

NOTE:

Multi-Cancel/Rebill Saves Time. If you need to rebill many bill segments related to a service agreement (e.g., because many bill segments were created using the wrong rate), you should use the [Multi Cancel Rebill](#) transaction as it allows you to cancel / rebill an unlimited number of bill segments at once. Also note that for service agreements that require bill determinants from Oracle Utilities Meter Data Management, this transaction may only be used to cancel / rebill a single bill segment at a time.

Using the cancel and cancel/rebill functionality will cause the cancel and rebill details to be swept on to the customer's next bill. If your organization requires cancellation details to be presented to the customer separately from the new bill, then you will need to use Credit Notes. Refer to [Credit Notes - Presenting Cancellation Details on a Separate Bill](#) for more information.

-
- Click **Undo** to delete the new bill segment and return the original bill segment to the Frozen state.

Bill Segment - Main Information

FASTPATH:

The **Description of Page** section below describes the fields on this page. Refer to [How To](#) for a description of how to perform common bill maintenance functions.

The Main page contains core bill segment information. Open **Menu > Financial > Bill Segment > Search** to view this information.

NOTE:

Most bill segments are created by a background process. Refer to [A High Level Overview Of The Bill Creation Process](#) for information describing how the system creates a bill segment.

Description of Page

Bill Seg Info is a concatenation of the bill segment's division, SA type, status, bill period and amount. **Bill Segment ID** is the system-assigned unique identifier of the bill segment.

Account ID references the bill segment's account.

Current Amount is the bill segment's effect on the service agreement's current balance. **Payoff Amount** is only shown if it differs from current amount. Refer to [Billing - Current Balance versus Payoff Balance](#) for more information.

Bill ID is the system-assigned unique identifier of the bill on which the bill segment appears. A concatenation of its bill date, status, due date and amount is displayed.

SAID contains information about the bill segment's service agreement. A concatenation of the service agreement's division, SA type, start option (if any), status and start date is displayed.

If the [quotation](#) module is not **turned off**, you can generate [simulated bill segments](#) when you create a quote. You can view simulated bill segments by drilling down on the desired bill segment from [Quote - Quote Details](#). When a simulated bill segment is displayed on this page, the **Billing Scenario ID** that controlled the bill segment's billing period (and consumption) is displayed. Refer to [Creating Quotes And Quote Details](#) for more information.

Period is the start and end dates of the bill segment.

Usage Period is the period used by Oracle Utilities Meter Data Management to determine the correct interval data to process for the bill segment. This field appears when the bill segment is for an SA that has Bill Determinants Required for the special role flag.

Bill Cycle displays the bill cycle and window start date of the bill segment's bill. This information is only populated on bills when they are generated on-schedule by the batch billing background process. Bills generated manually, i.e. off-schedule, do not have this information.

Status is the bill segment's status. Refer to [Bill Segment Lifecycle](#) for the potential values and how to handle a bill segment when it exists in a given state.

If the **Closing** switch is on, this is the final bill segment for the service agreement (i.e., the service agreement has been stopped and this is the final bill segment).

NOTE:

The closing switch is not set for sub SA bill segments nor billable charge SA bill segments.

If the **Estimate** switch is on, consumption on this bill segment has been estimated by the system.

If the **SQ Override** switch is on, a user has overridden the service quantities (i.e., the amount of consumption for which the customer is charged is not consistent with the customer's meter reads). This switch is also set if a user has overridden the [calculation/audit read details](#).

If the **Item Override** switch is on, a user has overridden the type and/or number of items (i.e., the type/number of items for which the customer is charged is not consistent with the customer's service point information). Refer to [How To Override The Items Billed On A Specific Bill Segment](#) for more information.

If this bill segment was created for a [sub service agreement](#) where we calculate the charges (i.e., not for a "pass through" billing situation):

- **SA Rel ID** shows the unique identifier of the record that defines the relationship between the sub service agreement and the master service agreement (this record shows the service provider associated with the bill segment). Click the go to button to transfer to this record.
- **Master Bseg ID** shows the unique identifier of the master bill segment whose bill triggered the creation of this sub service agreement. This bill segment's consumption was used to calculate the charges on this bill segment.

Premise is the address of the main premise associated with the service agreement (as defined on the service agreement's characteristic premise). It's important to note that the service agreement may cover service at multiple premises, but only one may be defined as the main premise.

Create Dt/Tm is the date and time on which the bill segment was created or regenerated.

In the **Message** area, a brief error message appears if there's a problem with the bill segment. The message area is suppressed if there are no problems with the bill.

Push the magnifying glass button to view the long explanation. The long explanation will provide information about the cause of the error (and how to fix it).

If the bill segment is a rebill of a canceled bill segment, a reference to the original bill segment is displayed. Click the adjacent go to button to transfer to the bill segment that was canceled.

If the bill segment was canceled and rebilled by another segment, a reference to the new bill segment is displayed. Click the adjacent go to button to transfer to the new bill segment that superseded the canceled segment.

The topics that follow describe each of the actions on that appear in the **Bill SegmentActions** area. Refer to [How To](#) for a description of typical business processes that use these buttons.

NOTE:

Mass update actions. This page allows you to work on individual bill segments. If you want to update many bill segments linked to a bill at once, try using the mass update actions available on [Bill -Bill Segments](#).

Generate (Bill Segment)

Click the **Generate** button to create a new a bill segment.

This button is enabled when either of the following conditions is true:

- You are in add mode (i.e., you are not displaying an existing bill segment) and you have selected an **Account ID**, **Bill ID** and **SA ID**.
- You are displaying a bill segment that is Incomplete, Error, or Freezable. Refer to [Bill Segment Lifecycle](#) for more information about these status values.

When clicked, the **Generate** window opens.

You must specify the following parameters to generate a new bill segment:

- **Cut-off Date** is the last possible day of the bill segment's bill period. The current date defaults when the window opens. Refer to [Ways To Control The End Date Of A Bill Segment](#) for more information.
- **Accounting Date** is used to define the financial period to which the new bill segment's financial transaction will be booked. The current date defaults when the window opens.
- Turn on **Allow Estimates** to indicate if Oracle Utilities Meter Data Management should estimate consumption if it cannot find a meter read.
- If the service agreement uses meter reads, use the **Billing Option** to control how the system retrieves meter reads that appear on the bill. Choose Use Cut off Date if the meter reads must exist on the **Cutoff Date** (defined above). Choose Use Schedule if you want the service agreement's service point(s) measurement cycle schedule to control the meter reads that are used.

After specifying the above parameters, click the **Calculate** button to create a new bill segment for the bill.

If an error exists, refer to [How To Correct A Bill Segment That's In Error](#).

If there are no errors, the **Bill Segment Freeze Option** on the [installation option](#) controls the next step:

- If this option is set to Freeze At Bill Completion, return to [Bill - Main](#) (using the bill context menu) and click the [Freeze / Complete](#) button.
- If this option is set to Freeze At Will, click the [Freeze](#) button and, if everything looks clean, return to [Bill - Main](#) and click the [Complete](#) button.

Delete (Bill Segment)

The **Delete** button deletes a bill segment.

This button is enabled if you are displaying a bill segment that is Incomplete, Error, or Freezable. Refer to [Bill Segment Lifecycle](#) for more information about these status values.

Freeze (Bill Segment)

Clicking the **Freeze** button causes a freezable bill segment to become frozen. Refer to [Bill Segment Lifecycle](#) for more information about freezing.

This button is enabled if:

- the Freeze At Will **Bill Segment Freeze Option** on the [installation option](#) has been selected AND
- the bill segment is freezable.

NOTE:

Freezing a day or more after generation. If the bill segment is linked to a closed accounting period, a pop-up appears in which you can specify a new accounting date. This will only happen if the accounting period closes before you freeze the bill segment (the accounting date is stamped on a bill segment when it's initially generated).

If problems are detected after freezing. A bill segment may not be changed after it is frozen. All subsequent changes must occur by canceling the frozen bill segment and creating a new bill segment. Refer to [How To Cancel A Bill Segment](#) and [How To Cancel / Rebill A Bill Segment](#) for more information.

Rebill (Bill Segment)

If problems are detected with a frozen bill segment, it should be canceled and a new bill segment should be created. We refer to this process as cancel / rebill. Refer to [Cancel / Rebill Incorrect Bill Segments](#) for more information.

Before you cancel / rebill, you'll probably need to fix the cause of the problem. The following table describes common problems and where to go to fix them.

Problem	How To Fix It
The wrong rate was used	Go to Service Agreement - Rate Info and correct the rate.
The wrong meter was connected to the service point	
A contract rider was applied incorrectly	Go to Service Agreement - Rate Info and correct the contract rider information.
The wrong tax exemption amount was calculated	Go to Service Agreement - Rate Info and correct the tax exemption information.

NOTE:

Multi-Cancel/Rebill Saves Time. If the cause of the problem impacts many bill segments related to a service agreement, you should use the [Multi Cancel Rebill](#) transaction as it allows you to cancel / rebill an unlimited number of bill segments at once. Also note that for service agreements that require bill determinants from Oracle Utilities Meter Data Management, this transaction may only be used to cancel / rebill a single bill segment at a time.

Credit Notes. Using the cancel/rebill functionality will cause the cancel and rebill details to be swept on to the customer's next bill unless you [Reopen](#) the bill. If your organization requires cancellation details to be presented to the customer separately from the new bill, you should not use the **Rebill** functionality. Rather, you should issue a [Credit Note](#) and then generate a new bill containing the revised charges.

The **Rebill** button causes an existing bill segment to be canceled, and a new bill segment to be created.

This button is enabled when you display a Frozen bill segment AND the bill segment's bill is not written off AND the bill segment's bill is not linked to an off cycle bill generator. Refer to [Bill Segment Lifecycle](#) for more information about these status values.

When clicked, the **Rebill** window opens.

You must specify the following parameters to cancel and rebill a new bill segment:

- **Cancel Reason** defines why the bill segment is being canceled.
- **Cutoff Date** is the last day of the new bill segment. The cutoff date on the bill segment defaults when the window opens.
- **Accounting Date** is used to define the financial period to which the canceled and new bill segments' financial transactions will be booked. The current date defaults when the window opens.
- Turn on **Allow Estimate** to indicate if Oracle Utilities Meter Data Management should estimate consumption if it cannot find a meter read.
- Use the **Billing Option** to define how the system looks for meter reads. Select Use Schedule if the system should select reads based on the SA's SP's measurement cycle schedule. Select Use Cut off Date if the system should only select reads from the end date of the existing bill segment.
- Turn on **Use Old Read/Item/SQ for Regen** if you want the system to use the consumption details on the original bill segment when it calculates the new bill segment.

NOTE: The **Use Old Read/Item/SQ** switch is not available if the bill's SA references an SA type with a special role flag of Bill Determinants Required.

Click the **Calculate** button to cancel the original bill segment and create a new bill segment.

At this point, there are now two bill segments - the original bill segment is in the state of Pending Cancel, the new bill segment is in the Freezable (or Error) state. If you want to back out, click the go to button to return to the original bill segment and then click **Undo** (this will delete the new bill segment and return the original bill segment to the Frozen state). If the new bill segment looks correct, click **Freeze** to move the original bill segment to the Canceled state and the new bill segment to the Frozen state.

Init Cancel (Bill Segment)

The **Init Cancel** button causes the first step of the bill segment cancellation process to be executed. You'd click this button if a frozen bill segment should never have been created (i.e., you want to remove the financial impact of a bill segment from a customer's balance).

This button is enabled when you display a Frozen bill segment AND the bill segment's bill is not written off. Refer to [Bill Segment Lifecycle](#) for more information about these status values.

When clicked, the **Cancel** window opens.

You must specify the following parameters to cancel and rebill a new bill segment:

- **Cancel Reason** defines why the bill segment is being canceled.
- **Accounting Date** is used to define the financial period to which the canceled bill segment's financial transactions will be booked. The current date defaults when the window opens.

Click the **Calculate** button to cancel the original bill segment.

At this point, the bill segment is in the state of Pending Cancel. If you want to back out, click **Undo**; the bill segment will be returned to the Frozen state. Click **Cancel** to move the bill segment to the Canceled state.

NOTE:

Credit Notes. Using the cancel functionality will cause the cancel details to be swept on to the customer's next bill unless you **Reopen** the bill. If your organization requires cancellation details to be presented to the customer separately

from the new bill, you should not use the cancel functionality. Rather, you should issue a [Credit Note](#) and then generate a new bill containing the revised charges.

Undo (Bill Segment)

The **Undo** button returns a Pending Cancel bill segment to the Frozen state. If a Pending Cancel bill segment was created during a Cancel / Rebill, the newly created Freezable bill segment is also deleted.

This button is enabled when you display a Pending Cancel bill segment. Refer to [Bill Segment Lifecycle](#) for more information about this status.

Cancel (Bill Segment)

Clicking the **Cancel** button causes a Pending Cancel bill segment to become Canceled. Refer to [Bill Segment Lifecycle](#) for more information about cancellation.

This button is enabled if a Pending Cancel bill segment is displayed AND the bill segment's bill is not written off.

When clicked, the **Cancel** window opens.

You must specify the following parameters to cancel the frozen bill segments:

- **Cancel Reason** defines why you are performing the cancellation.
- **Accounting Date** defines the financial period to which the canceled bill segments' financial transactions will be booked. The current date defaults when the window opens.

After specifying the above parameters, click the **Calculate** button to cancel the frozen bill segments.

If the related bill is pending, the cancellation will cause the bill segment to be suppressed on the version of the bill sent to the customer (but it remains in the database for audit and financial reporting purposes).

If the related bill is complete and you do not [Reopen](#) the bill, the financial impact of the canceled bill segment will appear on the next bill created for the account (under Bill Corrections).

If the related bill is complete you may be able to [Reopen](#) the bill and then [Complete](#) it. By doing this, you can suppress a frozen bill segment on a previously completed bill. This means that if you catch a problem after completion you don't necessarily have to show the problem to the customer. Rather, cancel the problem, reopen and then recomplete the bill (when you recomplete the bill the system will mark the bill segment to be suppressed on the version sent to the customer because its cancellation appears on the same bill as the original charges).

Credit Note (Bill Segment)

The **Credit Note** button is used to cancel a bill segment and create a new bill that contains the cancellation details. We refer to this "negative bill" as a credit note. Refer to [Credit Notes - Presenting Cancellation Details on a Separate Bill](#) for more information.

NOTE:

If you want to issue a credit note for an entire bill. Rather than cancel a specific bill segment, functionality exists that allows you to create a credit note for ALL bill segments on a bill. To use this feature, display the bill in question and then click the **Credit Note** button on the [bill page](#).

This button is enabled if:

- the **Use Credit Notes** option on the [Installation](#) record is turned on AND
- the bill segment is frozen AND
- the bill segment's bill is not written off.

When clicked, the **Credit Note** window opens.

You must specify the following parameters to cancel the frozen bill segment:

- **Cancel Reason** defines why you are performing the cancellation.
- **Accounting Date** defines the financial period to which the canceled bill segment's financial transaction will be booked. The current date defaults when the window opens.
- **Credit Note Date** defines the date of the credit note on which the cancellation details will appear. The current date defaults when the window opens.

After specifying the above parameters, click the **Calculate** button to cancel the frozen bill segment and create a credit note.

It should be noted that if this operation is successful, the new "negative bill" will be complete (meaning that it will be ready for transmission to the customer and for interface to the general ledger).

Bill Segment - Read Details

The Read Details page is not populated when meter reads are managed in Oracle Utilities Meter Data Management.

Bill Segment - Item Details

FASTPATH:

The **Description of Page** section below describes the fields on this page. Refer to [How To Override The Items Billed On A Specific Bill Segment](#) for a description of how to override this information.

The Item Details page contains information about the items located at the service agreement's service points. Open **Menu > Financial > Bill Segment > Search** and navigate to the **Item Details** page to view this information.

NOTE:

Refer to [How the System Requests How Much Was Consumed](#) for how the system assembles this information.

Description of Page

Bill Seg Info is a concatenation of the bill segment's division, SA type, status, bill period and amount. **Bill Segment ID** is the system-assigned unique identifier of the bill segment.

The item details grid is a snapshot of the items that existed at the service agreement's service points at the time the bill segment was created. One row exists for every type of item linked to every service point linked to the service agreement.

This information may be modified on a bill segment in the Error or Freezable state. Insert one row in the item grid (click the + button) for each item you need to add. You may also change item amounts that were populated by the system when it initially generated the bill by simply overwriting the information.

WARNING:

The proper way to fix the number and type of items on a bill segment is to correct the service point / item information and then regenerate the bill segment. Overriding the item details on a bill segment is a last resort that should only be used when you cannot fix the service point / item information (for whatever reason).

The following information is displayed in the grid:

- **Seq No** is the system-assigned unique identifier of the item detail row.
 - **Item Type** is the type of item.
 - **Item ID** is the unique identifier of the item (this is only displayed if a badged item is linked to the service point; non-badged items don't have unique identities).
 - **Start Date** is the first day in the bill segment's bill period that the item was linked to the service point.
 - **End Date** is the last day in the bill segment's bill period that the item was linked to the service point.
 - **Item Count** is the number of items of this type that were linked to the service agreement's service points.
 - If the item's item type indicates the system must estimate consumption (e.g., lamps), **UOM** is the unit of measure of the estimated consumption. **Daily Service Quantity** is the item's estimated amount of daily consumption.
-

FASTPATH:

Refer to [Defining Device Options](#) for more information about item types and defining the estimated consumption amount for items.

Bill Segment - SQ Details

FASTPATH:

The **Description of Page** section below describes the fields on this page.

The SQ Details page contains information about the [How the System Requests How Much Was Consumed](#) that will be priced by the service agreement's rate. In addition to showing SQ details, this page shows any [Calculation / Audit Read Details](#) and [Calculation / Audit Usage Details](#) that are linked to the bill segment. Open **Menu** > **Financial** > **Bill Segment** > **Search** and navigate to the **SQ Details** page to view this information.

Description of Page

Bill Seg Info is a concatenation of the bill segment's division, SA type, status, bill period and amount. **Bill Segment ID** is the system-assigned unique identifier of the bill segment.

The **Service Quantity** details grid is a snapshot of the service quantities amassed from:

- The bill segment's usage request.
- Those items for which the system estimates consumption. Refer to [Defining Device Options](#) for more information.
- **Billable charges** that supply service quantities.

One row exists for every unique combination of unit of measure (UOM), time-of-use (TOU) code, and service quantity identifier (SQI) associated with the service agreement.

This information may be overridden on a bill segment in the Error or Freezable state. Insert one row in the service quantity grid (click the + button) for each UOM/TOU/SQI you need to add. You may also change amounts that were populated by the system when it initially generated the bill by simply overwriting the information.

WARNING:

The proper way to fix the SQ details on a bill segment is to correct the cause of the error (e.g., correct the meter reading). Overriding the SQ details on a bill segment is a last resort that should only be used when you can't fix the cause of the problem. Refer to [How To Cancel / Rebill A Bill Segment](#) for ways to fix common problems.

The following information is displayed in the grid:

- **Unit of Measure** is the unit of measure of the service quantity.
- **Time of Use** is the time-of-use of the service quantity.
- **SQI** is the service quantity identifier of the service quantity.
- **Initial Service Quantity** is the initial quantity amassed by the system before application of the rate's pre-processing calculation group(s), if any exists.
- **Billable Service Quantity** is the service quantity that will be priced by the service agreement's rate. This amount differs from the initial service quantity when the rate's pre-processing calculation rule(s) manipulate consumption.

The **Calculation/Audit Read Details** section contains [Calculation / Audit Read Details](#). This section only appears if any of the following conditions are true:

- The service agreement has a special role of Billable Charge or Bill Determinants Required.
- The bill segment has one or more reads with a usage flag of Calculation/Audit .

The following information may be defined for each calculation / audit read:

- **Final Unit of Measure** is the final unit of measure of the calculation / audit read.
- **Final Time of Use** is the final time-of-use code of the calculation / audit read.
- **Final SQI** is the final service quantity identifier of the calculation / audit read.
- **Start Date/Time** is the date and time of the calculation / audit read.
- **End Date/Time** is the date and time of the calculation / audit read.
- **Quantity** is the quantity of the calculation / audit read. This would typically contain the amount that was billed during the **Start Date/Time** through the **End Date/Time** for the **Final Unit of Measure**, **Final Time of Use** and **Final SQI**.
- **Unit of Measure** is the initial unit of measure of the calculation / audit read (if any).
- **Time of Use** is the initial time-of-use code of the calculation / audit read.
- **SQI** is the initial service quantity identifier of the calculation / audit read.
- **Start Quantity** is the "start" quantity (if any). This value would typically only be displayed if the calculation / audit read is subtractive (i.e., you must subtract the end quantity from the start quantity to determine billable consumption).
- **End Quantity** is the "end" quantity (if any). This value would typically only be displayed if the calculation / audit read is subtractive (i.e., you must subtract the end quantity from the start quantity to determine billable consumption).
- **Measured Quantity** is the resulting measured quantity (if any). This value would typically only be displayed if the calculation / audit read is subtractive (i.e., you must subtract the end quantity from the start quantity to determine billable consumption). It should contain the difference between the **Start Quantity** and the **End Quantity**.
- **Constant** is the constant of the measuring device that was multiplied by the **Measured Quantity** to derive the calculation / audit read's **Quantity**.
- **How To Use** is a code that indicates if the "calculation / audit" read was is considered to be additive, subtractive, peak or check.
- **Use Percent** is the percentage of the total consumption that was billed.
- **Meas Peak Qty** indicates if the unit of measure is one that measures peak consumption.
- **Multiplier** is the ratio of the **Quantity** and the **Measured Quantity**. This value only appears if a non-zero value exists in both of these fields.

- **Seq No** is the sequence number (if any).
- **Service Point** is the unique identifier of the service point at which the readings were calculated (if applicable).

This information may be overridden on a bill segment in the Error or Freezable state. Insert one row in the calculation / audit details grid (click the + button) for each entry you need to add. You may also information populated by the system when it initially generated the bill by simply overwriting the information.

WARNING:

The proper way to fix the calculation/audit details on a bill segment is to correct the cause of the error. Overriding the calculation/audit details on a bill segment is a last resort that should only be used when you can't fix the cause of the problem.

FASTPATH:

Refer to [Calculation / Audit Read Details](#) for more information about this section.

The **Calculation/Audit Usage Details** grid contains usage service quantities for the bill segment. This section appears when the service agreement has a special role of Bill Determinants Required. The following information is displayed in the grid:

- **Final Unit of Measure** is the final unit of measure of the calculation / audit usage.
- **Final Time of Use** is the final time-of-use code of the calculation / audit usage.
- **Final Service Quantity ID** is the final service quantity identifier of the calculation / audit usage.
- **Start Date/Time** is the date and time of the calculation / audit usage.
- **End Date/Time** is the date and time of the calculation / audit usage.
- **Quantity** is the quantity of the calculation / audit usage. This would typically contain the amount that was billed during the **Start Date/Time** through the **End Date/Time** for the **Final Unit of Measure**, **FinalTime of Use** and **FinalSQL**.
- **Sequence** is the sequence number.
- **Service Point ID** is the unique identifier of the service point at which the usage was calculated.

FASTPATH:

Refer to [Calculation / Audit Usage Details](#) for more information about this section.

Bill Segment - Calc Lines

FASTPATH:

The **Description of Page** section below describes the fields on this page. Refer to [How To Cancel / Rebill A Bill Segment](#) for instructions describing how to regenerate this information if the bill segment is incorrect.

The Calc Lines page contains information about the bill calculation lines produced when the system generates the bill segment. These lines are the source of the details printed on the customer's bill. Open **Menu > Financial > Bill Segment > Search** and navigate to the **Calc Lines** page to view this information.

FASTPATH:

Most service agreements use a rate to calculate the information that appears on this page. Refer to [How Rates Affect The Information On Bill Segments](#) for more information.

Description of Page

Bill Seg Info is a concatenation of the bill segment's division, SA type, status, bill period and amount. **Bill Segment ID** is the system-assigned unique identifier of the bill segment.

The Bill Segment Header (**Bill Seg Hdr**) scroll contains one entry for every version of the rate that was used to calculate the bill segment's lines. Because most bill segments use a single rate version calculation group, you typically only see one entry in the scroll.

The following information is displayed above the bill calculation line grid.

- **Sequence** will be 1 unless multiple versions of the rate were in effect during the bill period. If there was more than one effective rate version calculation group, there will be a separate set of calc lines for each version applied. The lines that apply to the first part of the bill period would have a Sequence of 1, the lines for the next part of the bill period would have a Sequence of 2 and so on.
- **Start Date - End Date** is the portion of the bill segment period that the calculation details apply. .
- **Amount** is the sum of the bill calculation lines in the grid.
- **Desc on Bill** is summary information about the calculation details that will be printed on the customer's bill.
- **Rate Version** is the ID of the rate version calculation group and its effective date. This information only appears if a rate was used to calculate the charges.

The calculation lines grid is a snapshot of how the system calculated the bill segment amount. One row exists for every calculation involved in this process. This information is for audit purposes only and may not be modified. The following information is displayed in the grid:

- A drill down button appears in the **Calc Line Char** column if the bill calculation line has characteristics. The **Calc Line Char** column only appears if at least one of the calculation lines has a characteristic.
- **Sequence** is the system-assigned unique identifier of the calculation detail row.
- **Description on Bill** is the information about the bill line that appears on the customer's bill.
- **Calculated Amount** is the calculated amount associated with the bill line.
- The **Print** switch controls whether information about this line will print on the customer's bill.
- The **Appears in Summary** switch defines if this line's amount also appears on a summary line. This switch plays a part at bill print time - those lines that appear in a summary print in the left dollar column, those that don't appear in a summary print in the right dollar column.

The system automatically populates this switch as follows:

- Bill segments created by applying a rate have this switch turned on if the corresponding calculation rule is summarized on a summary calculation rule
- Bill segments created from billable charges use the value of this switch as defined on the billable charge. Refer to [Maintaining Billable Charges](#) for more information.
- **Unit of Measure (UOM)** is the unit of measure of the service quantity priced on the calculation line.
- **Time of Use (TOU)** is the time-of-use code of the service quantity priced on the calculation line.
- **SQI** is the service quantity identifier of the service quantity priced on the calculation line.
- **Billable Service Quantity** is the service quantity priced on the calculation line. This quantity will be different from the measured consumption is there are pre-processing calculation group in effect.
- **Base Amount** is used by calculation lines (e.g. taxes) that are cross-referenced to other calculation lines and whose value(s), therefore, depend on the amounts calculated by those other lines. The Base Amount shows the total amount derived from the cross-referenced line(s) that the current line then used to calculate its billed amount.
- **Calculation Rule** is the rule that calculated the line. This is only populated if the new rate engine calculated the charges.
- **Measures Peak Qty** is checked if the UOM priced on the calculation line is used to measure a peak quantity.

- **Exempt Amount** is the amount of the calculated charge that the customer doesn't have to pay because they are tax exempt.
- **Distribution Code** is the distribution code associated with the calculation line. This distribution code is used to build the general ledger details on the bill segment's financial transaction.
- **Description** describes the characteristic value that was used when the line's amount was calculated. This information is only displayed if the line was calculated using a bill factor (because only bill factors use characteristic values). Refer to [An Illustration Of A Bill Factor And Its Characteristics](#) for more information.

Bill Segment - Financial Details

FASTPATH:

The **Description of Page** section below describes the fields on this page. Refer to [How To Cancel / Rebill A Bill Segment](#) for instructions describing how to regenerate this information if it is incorrect.

The Financial Details page contains information about the financial effects of the bill segment. Open **Menu > Financial > Bill Segment > Search** and navigate to the **Financial Details** page to view this information.

NOTE:

Refer to [The Source Of GL Accounts On A Bill Segment's Financial Transaction](#) for how the system compiles this information.

Description of Page

Bill Seg Info is a concatenation of the bill segment's division, SA type, status, bill period and amount. **Bill Segment ID** is the system-assigned unique identifier of the bill segment.

The **Bill Segment FT** scroll contains one entry for every financial transaction (FT) associated with the bill segment. All bill segments have an FT that shows the impact of the bill segment on the general ledger. A bill segment may have an additional FT (for a maximum of two) if it is cancelled. The second FT shows the impact of the cancellation on the general ledger.

The following financial transaction information is displayed above the general ledger distribution grid.

- **FT Type** displays the type of financial transaction (FT).
- **Show on bill** indicates if information about the FT appears on the customer's bill.
- **FT ID** is the system-assigned unique identifier of the FT. Click the go to button to transfer to the [Financial Transaction - Main](#) page. On this page you can change certain aspects of the FT in question. Refer to [How To Remove Unwanted Adjustments \(or Payments\) From A Completed Bill](#) for a description of how to perform common maintenance functions.
- The posted by information that appears adjacent to the FT ID shows the date on which the FT was frozen and the user ID of the user who performed the operation.
- The "Linked to bill on" message appears when the financial transaction is linked to a bill. A FT is linked to a bill the next time a bill is completed for the account. Therefore, if a user cancels a bill segment, the FT associated with the cancellation will not be linked to a bill until the next bill is completed (although the financial effect of the cancellation takes place immediately). Click the adjacent go to button to transfer to the bill on which the FT appears.
- **Current Amount** contains the FT's effect on the service agreement's current balance.
- **Payoff Amount** contains the FT's effect on the service agreement's payoff balance. This field is only visible when the payoff amount differs from the current amount.
- **Accounting Date** is the date the system uses to determine the FT's accounting period in your general ledger.
- **Arrears Date** is the date the FT starts aging.

The journal details grid is a snapshot of the distribution codes used to generate the GL accounts that are affected by the FT. This information is for audit purposes only and may not be modified. The following information is displayed in the grid:

- **Seq** is the system-assigned unique identifier of the distribution line.
- **Distribution Code** is the distribution code used to generate the GL account affected by the distribution line. Drill over to the FT if you need to see the actual GL account.
- **Amount** is the amount debited / credited (credits are shown as negative values).
- **Statistics** and **Statistics Amount** are only specified when a statistical quantity is associated with the distribution line. For example, if the line is associated with a charge for the total number of kilowatt-hours consumed, the statistics code will be the kWh and the statistics amount will be the number of kilowatt-hours associated with the charge.
- **Description** describes the characteristic value that was used when the line's amount was calculated. This information is only displayed if the distribution line was derived from bill calculation lines that were calculated using a bill factor (because only bill factor's use characteristic values). Refer to [An Illustration Of A Bill Factor And Its Characteristics](#) for more information.
- If you have configured your installation options to indicate that **fund accounting** is practiced, the description of the **Fund** associated with this distribution code is displayed.

Bill Segment - Bill Segment Messages

The Messages page is a grid containing one row for every message that appears on the bill segment. Open **Menu > Financial > Bill Segment > Search** and navigate to the **Bill Segment Messages** page to view this information.

NOTE:

No messages until completion. A bill segment has no messages until it is completed (unless you insert them manually). At completion time, the system assembles messages from the various message sources. Refer to [The Source Of Bill Messages](#) for information about these sources.

The bill may also have messages. Be aware that only service agreement-oriented messages are linked to a bill segment. There may also be account-oriented messages linked to the bill. Refer to [Bill - Bill Messages](#) for information about the page on which account-oriented messages are displayed. Refer to [The Source Of Bill Messages](#) for information about the various message sources and whether each is linked to a bill or a bill segment.

Description of Page

Bill Seg Info is a concatenation of the bill segment's division, SA type, status, bill period and amount. **Bill Segment ID** is the system-assigned unique identifier of the bill segment.

The following columns are displayed in the grid:

- **Msg Code** is the code that identifies the bill message.
- **Message On Bill** is the message associated with the code.
- **Priority** is the bill messages priority (on the printed bill).
- **Insert Code** defines if the bill message causes an insert in the envelope.

Bill Segment - Sub Bill Segments

The Sub Bill Segments page contains the sub bill segments that are associated with the master SA's bill segment. Open this page using **Menu > Financial > Bill Segment > Search** and navigate to the **Sub Bill Segment** page.

NOTE:

Sub bill segments are only linked to the master SA's bill segment when the master SA has an SA relationship with a We Bill For Them - Rate Ready or an It's Us service provider. Refer to [The Rate Ready Calculation Method](#) for the details.

Description of Page

Bill Seg Info is a concatenation of the bill segment's division, SA type, status, bill period and amount. **Bill Segment ID** is the system-assigned unique identifier of the bill segment.

The following information is displayed in the grid.

- Click the adjacent **Go To** button to transfer to the bill segment.
- The **Bill Segment** column contains a concatenation of the bill segment's business unit, SA type, status, bill period and amount. The business unit and SA type come from the bill segment's service agreement.
- The **Current Amount** column contains the bill segment's effect on the sub service agreement's current balance.
- The **Status** column contains the bill segment's current status.

Bill Segment - Bill Segment Portal

Select **Menu > Financial > Bill Segment > Search** and navigate to the **Bill Segment Portal** page to view additional information associated with a Bill Segment.

Depending on your implementations requirements, you may define additional zones to appear on this Portal

The contents of this section describe the zones that are available on this portal page.

General Information

Bill Segment ID, **Bill Seg Info** are displayed.

Bill Segment - Usage

This Usage portal is available when the bill segment has associated usage requests. It displays all usage requests related to the bill segment. Select **Menu > Financial > Bill Segment > Search** and navigate to the **Usage** page to view bill segment's usages.

General Information

Bill Segment ID and Bill Segment Info are displayed.

Bill Segment Usage

The following information is displayed in the Bill Segment Usage zone:

- The **Create Date/Time** of the usage request.
- The **Usage** column contains a concatenation of the bill segment's division, SA type, status, and period of the usage request. The usage information links to the Usage Portal for the usage request.
- The **Usage ID** for the usage request.

Financial - Bill Segment Calculation Line Characteristics

This page displays the characteristics that are linked to a specific bill segment calculation line. The information on this page is for audit purposes only and cannot be changed.

Open this page by clicking the **Go To Calc Line Characteristic** button on the calculation lines grid of the [Bill Segment - Calc Lines](#) page.

Description of Page

Account is the account to which the bill segment is linked. The name of the main person on the account appears next to the account ID.

The **SA** is the service agreement to which the bill segment applies. Basic information about the service agreement appears adjacent.

Premise shows the service agreement's characteristic premise (i.e., the primary premise associated with the service agreement).

The **Bill Seg ID** and **Bill Seg Header** displays the identification of the bill segment and header associated with the calculation line characteristic.

Calc Line displays the calculation line number with which the characteristics are associated.

The **Description on Bill** displays the description of the calculation line that appears on the customer's bill.

The characteristics grid displays the **Characteristic Types** and the **Characteristic Values** associated with the calculation line.

FASTPATH:

For more information about characteristics, refer to [Setting Up Characteristic Types and Their Values](#).

Off Cycle Bill Generator

The Off Cycle Bill Generator portal may be used to create an off cycle bill for an account where you control which financial transactions are linked to the resultant bill. For example, you can create a bill for a specific adjustment or billable charge. Navigate using **Menu > Financial > Off Cycle Gill Generator > Add**.

Off Cycle Bill Generator Query

Use the [query portal](#) to search for an existing off cycle bill generator. Once an off cycle bill generator is selected, you are navigated to the maintenance portal to view and maintain the selected record.

Off Cycle Bill Generator Portal

This portal appears when an off cycle bill generator has been selected from the Off Cycle Bill Generator Query portal. The topics in this section describe the base-package zones that appear on this portal.

Off Cycle Bill Generator Actions

This is a standard [actions zone](#).

If the off cycle bill generator is in a state that has valid next states, buttons to transition to each appropriate next state are displayed.

FASTPATH:

Refer to [How To Create An Off Cycle Bill Generator](#) for more information about how to create an off cycle bill on-line / real time.

Off Cycle Bill Generator Zone

The Off Cycle Bill Generator zone contains display-only information about the off cycle bill generator.

Please see the zone's help text for information about this zone's fields.

Financial Transactions On Bill

The Financial Transactions On Bill zone shows financial transactions linked to the off cycle bill generator's bill. Information displayed on this zone is similar to that displayed on the [Financial Transactions On A Bill](#) transaction.

Off Cycle Bill Generator Log

An off cycle bill generator log contains an entry for every recorded event during the lifecycle of the off cycle bill generator. There are two general types of log entries:

- **Automatic entries.** The system automatically creates an entry in the log when an off cycle bill generator is created or there is a status change or when a related entity is created. This also includes any implementation-specific log entries. Users cannot modify or delete these log entries.
- **Manual entries.** Users can add manual entries to record significant events at their discretion.

Multi Cancel/Rebill

The Multi-Cancel/Rebill transaction is used to cancel / rebill (and freeze) one or more bill segments linked to a service agreement.

NOTE:

You would typically use this transaction when something has been wrong for an extended period of time. For example, if the customer was assigned the wrong rate when they first started service, you would correct the customer's rate using [Service Agreement - Rate Info](#) and then use this transaction to cancel / rebill the customer's historical bill segments.

The following topics describe how to use this transaction.

Multi Cancel/Rebill - Main

The main page is used to select the bill segments to be cancel/rebilled and to initiate the cancel/rebill request. Open **Menu > Financial > Multi-Cancel/Rebill** to use this function.

Description of Page

This page contains all non-cancelled bill segments associated with a given **SA ID**. The service agreement's **SA Info**, **Account ID** (and name), characteristic **Premise** (and address), **Current Balance** and **Payoff Balance** are displayed at the top of page.

When the page first opens, the grid is populated with ALL non-cancelled bill segments displayed in reverse chronology order. All frozen bill segments are pre-selected for cancel/rebill processing. The following information appears in the grid:

- **Selected Switch.** If this switch is turned on, the bill segment will be cancel / rebilled when the **Cancel/Rebill/Freeze** button is clicked. You can use the mouse to toggle the value of this switch on a specific bill segment. Alternatively, you can click the **Select All** button or **Clear All** button to toggle the switch for all frozen bill segments. The checkbox is disabled if the bill segment's bill is written off. Note: the total number of selected bill segments is shown above the grid for confirmation purposes.
- **Start Date.** This is the first day of the bill segment.
- **End Date.** This is the last day of the bill segment.
- **Create Date/Time.** This is the day/time the bill segment was created.
- **Amount.** This is the payoff amount of the bill segment.
- **Original Amount.** This column only contains a value if the bill segment is a rebill of another bill segment. In this situation, one of the following values will be displayed:
 - If the amount of the new bill segment differs from the amount of the original bill segment, the amount of the original bill segment will be displayed.
 - If the amount of the new bill segment equals the amount of the original bill segment, the word No change will be displayed.
- **Bill Segment Information.** This is the standard bill segment summary information.

NOTE:

Sorting By Values In The Grid. Just like all grids in the system, you can click on a column heading to resort the grid by the value of the respective column. This might be useful to sort the bill segments in **Amount** order.

After selecting the bill segments to be cancel/rebilled, click the **Cancel/Rebill/Freeze** button. When this button is clicked, an additional informational page displays. Specify the following information and then click **Calculate** to cancel the selected bill segment and create new bill segments:

- **Cancel Reason** defines why the bill segment(s) are being canceled.
- **Accounting Date** is used to define the financial period to which the canceled and new bill segments' financial transactions will be booked.
- Turn on **Allow Estimates** to indicate if Oracle Utilities Meter Data Management should estimate consumption if it cannot find a meter read.
- Use the **Billing Option** to define how the system looks for meter reads:
 - Select Use Schedule if the system should select reads based on the SA's SP's measurement cycle schedule.
 - Select Use Cut off Date if the system should only select reads from the end date of the existing bill segment.
- Select Use Schedule if the system should select reads based on the SA's SP's measurement cycle schedule.
- Select Use Cut off Date if the system should only select reads from the end date of the existing bill segment.
- If you'd prefer to have the system use the consumption details snapshot on the original bill segments, turn on **Use Old Read/Item/SQ**. If this switch is on then neither **Allow Estimates** nor **Billing Option** is relevant.

NOTE: The **Use Old Read/Item/SQ** switch is not available if the bill's SA references an SA type with a special role flag of Bill Determinants Required.

WARNING:

If the cause of the rebill is an incorrect rate and the new rate requires service quantities that were not calculated when the bill was originally calculated, do not turn on **Use Old Read/Item/SQ**. Why? Because you want the system to derive new service quantities during the rebill process.

NOTE:

Default note. The Accounting Date is defaulted to the current date and the **Use Old Read/Item/SQ** switch is turned on.

After specifying the above information, the system cancel / rebills each segment in chronological order (i.e., earlier segments will be cancel / rebilled before later segments). The new amount of each bill segment is shown in the **Original Amount** column. You can navigate to the [Graph](#) page to graphically view the financial ramifications of the cancel/rebills.

NOTE:

Errors. It's possible that bill segment errors will occur when you cancel / rebill the bill segments. For example, if you change the SA's rate to a rate that requires a unit-of-measure that doesn't exist on the SA's meter, a bill segment error will be generated. If this occurs, you must go to [Bill Segment - Main](#) for the pending cancel bill segment and use the **Undo** action to remove the offending bill segment (and restore the original segment to the Frozen state). Alternatively, you can drill down on the Error bill segment and use the **Regenerate** action after correcting the cause of the problem.

There is no Undo. Unlike cancel / rebills performed on [Bill Segment - Main](#), there is no Undo action. This is because the multi-cancel/rebill transaction freezes the newly created bill segments after it cancel/rebills; whereas the bill segment transaction lets you examine the new bill segment before you freeze it. If you made a mistake, simply correct the cause of the mistake and then cancel / rebill again. The erroneous financial transactions will be automatically suppressed on the next bill produced for the customer.

Multi Cancel/Rebill - Graph

This page contains a graph that shows the rebilled and original payoff amounts for a service agreement's non-cancelled bill segments. Open **Menu > Financial > Multi Cancel/Rebill** and navigate to the **Graph** page to view this information.

Description of Page

This page contains a graph that shows the payoff amounts for a service agreement's non-cancelled bill segments (represented by the blue bars in the graph). If a bill segment is a rebill of another bill segment, the payoff amount of the original bill segment is displayed on a red-colored bar adjacent to the respective blue bar.

NOTE:

Click a bar. You can click on a bar to drill down to a bill segment.

SA Billing History

Open **Menu > Financial Query > SA Billing History** to view a history of all bill segments produced for a service agreement.

Description of Page

The **Account ID** is displayed with the account's name adjacent.

The **SA Information** shows a summary of information about the service agreement. The **SA ID** is the unique identifier of this SA.

One row is displayed for every bill segment ever produced for the selected service agreement.

The following information is displayed for each bill segment:

- The **Start Date** and **End Date** of the bill segment.
- The number of **Days** in the bill segment consumption period.
- The **Status** of the bill segment
- The **Current** and **Payoff Amounts** of the bill segment.
- The **UOM** (Unit of Measure) of the service quantity designated as the "graph UOM" for the SA's SA type.
- The total amount of the service **Billable Service Quantity** that was billed.
- The **Avg Daily Qty** is the **Billable Service Quantity** divided by the numbers of days of service.

If you need to see more detailed information about the bill segment, click the go to button to transfer to the bill segment page.

Bill Exception

If errors are detected during the billing process, it may cause a record to be written to the bill exception table with a message indicating the nature of the severe error.

To view the messages associated with the exception records, schedule the [TD-BIERR](#) background process. This process generates a To Do entry for every record in the bill exception table.

FASTPATH:

Refer to [How to Correct a Bill That's In Error](#) for instructions describing how to correct a bill.

Bill Segment Exception

If errors are detected during the billing process, it may cause a record to be written to the bill segment exception table with a message indicating the nature of the severe error.

To view the messages associated with the exception records, schedule the [TD-BSERR](#) background process. This process generates a To Do entry for every record in the bill segment exception table.

FASTPATH:

Refer to [How To Correct A Bill Segment That's In Error](#) for instructions describing how to correct a bill segment.

Maintaining Billable Charges

You create a billable charge whenever a customer should be charged for a service that occurs outside the normal course of business. For example, you would create a billable charge to charge a contractor for the repair of a ruptured gas line.

NOTE:

Billable charges can be uploaded from an external system. Refer to [Uploading Billable Charges](#) and [Using Billable Charges For Pass Through Billing](#) for more information.

A billable charge must refer to a service agreement. This service agreement behaves just like any other service agreement:

- **Bill segments are created for the service agreement.** Whenever billing is performed for an account with billable charge service agreements, the system creates a bill segment for each billable charge. This means that if a service agreement has many unbilled billable charges, it will have many bill segments.
- **Payments are distributed to the service agreement.** Payments made by an account are distributed to its billable charge service agreements just like any other service agreement.
- **Overdue debt is monitored.** The credit and collections process monitors billable charge service agreements for overdue debt and responds accordingly when overdue debt is detected.
- This service agreement must reference an SA Type that has a Special Role of Billable Charge. If such a service agreement does not already exist for the account, one must be created before you can levy a billable charge. See "For more information" at the end of this section for links to other sections that will help you with this process.

Billable charge templates exist to minimize the effort required to create a billable charge for a customer. A billable charge template contains the standard bill lines, amounts and distribution codes used to charge for a one-off charge.

A user may override the information on the template when the billable charge is created. For example, you can create a billable charge template to levy charges when a contractor ruptures a gas main. This template would contain the bill lines, amounts and distribution codes associated with a ruptured pipe repair. Then, when a contractor ruptures a line, a user can create a billable charge using the template and override the amount to reflect the actual repair amount (if it differs from the norm).

NOTE:

Templates aren't required. A billable charge can be created without a template for a truly unexpected charge. If you don't use a template, you'll have to enter the bill information manually.

FASTPATH:

Refer to [Setting Up Billable Charge Templates](#) for more information.

NOTE:

Adding taxes and other calculation lines to a billable charge. Refer to [Billable Charge - SQ Details](#) for information about how to have the system calculate tax lines and append them to the billable charge.

Billable Charge - Main

Open **Menu > Financial > Billable Charge > Search** to maintain a billable charge.

Description of Page

The **Billable Charge ID** is system generated. The **Account ID** of the account responsible for the charge is displayed at the top.

Use **SA ID** to define the ID of the billable charge service agreement that will hold the billable charge's debt. The **Account ID** for the service agreement is displayed for information purposes.

Use **Start Date** and **End Date** to define the charge's bill period.

NOTE:

Installment billable charges. You can create many future dated billable charges to implement unusual installment plans. For example, if you want to bill a customer \$250 today, \$150 next month, and \$1000 three months from now; you

could create three billable charges with a date that reflects the earliest bill date. When a bill is produced for the account, the system will create a bill segment for every billable charge whose start date is on or before the current date.

If you want to create the billable charges from an existing template, enter the ID of the **Billable Charge Template** from which the billable charge information defaults. If your **SA Type** indicates a billable charge template, that value will be defaulted. The billable charge template is stored with the billable charge, to reference what was used to create it.

NOTE: Actual billable charge lines can differ from what was originally defaulted from the billable charge template if user overrides were done after defaulting. Refer to [Maintaining Billable Charges](#) for more details.

Use **Description on Bill** to define the verbiage that should print on the customer's bill above the line item details.

Billable Charge Status defines the state of the billable charges. Possible values are Billable and Cancelled. Click the **Cancel** button to cancel a billable charge.

Bill Segment ID is the ID of the bill segment on which the billable charge's charge details appear. This information is only populated AFTER the billable charge has been swept onto a bill.

The **Total Bill Amount** displays the sum of all billable charge lines except those that are **Memo Only**. The **Total Line Amount** displays the sum of all billable charge lines except those that **Appear In Summary**.

The information in the scroll defines the line item details associated with the billable charge. Click the drill down button to navigate to the line characteristics. The following fields are required for each line:

Sequence Sequence controls the order in which the line items appear on the bill segment.

Description on Bill Specify the verbiage to print on the bill for the line item.

Charge Amount Specify the amount to charge for the line item.

Show on Bill Turn this switch on if the line item should appear on the customer's printed bill. It would be very unusual for this switch to be off.

Appears in Summary Turn this switch on when the amount associated with this line also appears in a summary line. This switch plays a part at bill print time - those lines that appear in a summary print in the left dollar column, those that don't appear in a summary print in the right dollar column. Also note, those lines that appear in a summary line are not included in the total amount associated with the billable charge.

Memo Only, No GL Turn this switch on if the billable charge line does not contribute to the total amount due (e.g., this switch would be on for "information only" lines).

Distribution Code Specify the distribution code that identifies the GL account associated with this line item. The description of the code appears adjacent.

FASTPATH:

For more information about billing billable charges, refer to [How To Create A One-Time Invoice](#). For more information about billable charge templates, refer to [Setting Up Billable Charge Templates](#).

Billable Charge - Line Characteristics

Characteristics may be associated with billable charge lines. Typically, this is done to categorize billable charge lines for reporting purposes.

Open **Menu > Financial > Billable Charge > Search** and navigate to the **Line Characteristics** page to maintain characteristics that are associated with billable charge.

Description of Page

The **Billable Charge Line** scroll defines the billable charge line to which you wish to assign characteristic values. The following fields display:

Characteristic Type The type of characteristic.

Characteristics Value The value of the characteristic.

NOTE:

You can only choose characteristic types defined as permissible on a billable charge line. Refer to [Setting Up Characteristic Types & Their Values](#) for more information.

Billable Charge - SQ Details

Optionally, you may specify service quantities associated with a billable charge. These are most commonly used when you want the system to calculate charges *in addition to the billable charge lines* (e.g., adding tax to the billable charge lines).

NOTE:

The SA must specify a rate. If you want the system to calculate additional charges based on the service quantities defined on this page, the related billable charge service agreement must reference a rate. This rate must have calculation rules that calculate charges based on the service quantities specified on this page. When the service agreement is next billed, the system will sweep on the billable charges and then call the rate and pass it the service quantities defined on this page. The rate will calculate the additional charges and these will be appended to the bill segment.

Open **Menu** > **Financial** > **Billable Charge** > **Search** and navigate to the **SQ Details** page to maintain a billable charges service quantities.

Description of Page

The following fields display:

Sequence Specify the sequence number of the SQ.

UOM Select the unit of measure of this SQ. One or more of **UOM**, **TOU**, or **SQ Identifier** must be selected.

TOU Select the time of use period.

SQ Identifier Select the SQ identifier.

Service Quantity Specify the number of units of this service quantity.

Billable Charge - Read Details

Optionally, you may specify meter read details associated with a billable charge. These are most commonly used when you need to print the read details that were used to calculate the bill lines that appear on the main tab.

NOTE:

Using these reads to derive billable consumption. The base package bill segment creation algorithm (BSBC-BC) simply sweeps billable charge read details onto the related bill segment as [calculation / audit reads](#). This algorithm does NOT use these reads to derive billable consumption. This is intentional as most implementations that import reads also import billable consumption and therefore deriving billable consumption is unnecessary (and also error prone). If your implementation needs to derive billable consumption from these reads, you can develop your own bill segment creation algorithm to do just this.

Open **Menu** > **Financial** > **Billable Charge** > **Search** and navigate to the **Read Details** page to maintain a billable charges service quantities.

Description of Page

The grid is a snapshot of the meter reads whose consumption was billed using the bill lines shown on the main tab. One row exists for every read that should be swept onto the related bill segment as a [calculation / audit read](#) when the system creates a bill segment for this billable charge. The following information is displayed in the grid:

- **Final Unit of Measure** is the unit of measure of the resultant billing quantity.
- **Final Time of Use** is the time-of-use code of the resultant billing quantity.
- **Final Service Quantity Identifier** is the service quantity identifier of the resultant billing quantity.
- **Register Quantity** is the resultant billing quantity.
- **How To Use (SP)** is the SA/SP's how to use code.
- **Service Point ID** is the unique identifier of the service point at which the meter was located.
- **Meter Configuration ID** is the unique identifier of the meter's configuration.
- **Sequence** is the sequence number of the register on the meter.
- **Unit of Measure** is the register's unit of measure.
- **Time of Use** is the register's time-of-use code.
- **SQI** is reserved for future use.
- **Start Register Reading** is the start register reading.
- **End Register Reading** is the end register reading.
- **Measured Quantity** is the resulting measured quantity.
- **Register Constant** is the constant on the register that is multiplied by the measured quantity to derive the register's billable consumption.
- **How To Use** is the register's how to use code.
- **Use Percent** is the SA/SP's usage percentage. A value of 100% is defaulted.
- **Measures Peak Qty** indicates if the unit of measure is one that measures peak consumption.
- **Start Read Date/Time** is the date and time of the start meter read. If the register is consumptive, (as opposed to subtractive) nothing will be displayed.
- **End Read Date/Time** is the date and time of the end meter read.
- **Start Reg Read ID** is the unique identifier of the start register read. If the register is consumptive, (as opposed to subtractive) nothing will be displayed.
- **Read Type** is the read type of the start meter read.
- **End Reg Read ID** is the unique identifier of the end register read.
- **Read Type** is the read type of the end meter read.
- **Multiplier** is the composite multiplier that converts the measured quantity to the registered quantity.

NOTE:

The multiplier is calculated by dividing the Register Quantity by the Measured Quantity (if the Measured Quantity is 0, then the result is 0). This is not stored on the database. There is a chance that the value is not precise due to round-off.

Uploading Billable Charges

This section describes how the system uploads billable charges from an external source. This mechanism is used when you need to ["pass through" charges](#) that have been calculated by a third party but appear on your bill.

Billable Charge Upload Background Processes

The following diagram illustrates the processes involved in the uploading of billable charges into the system.

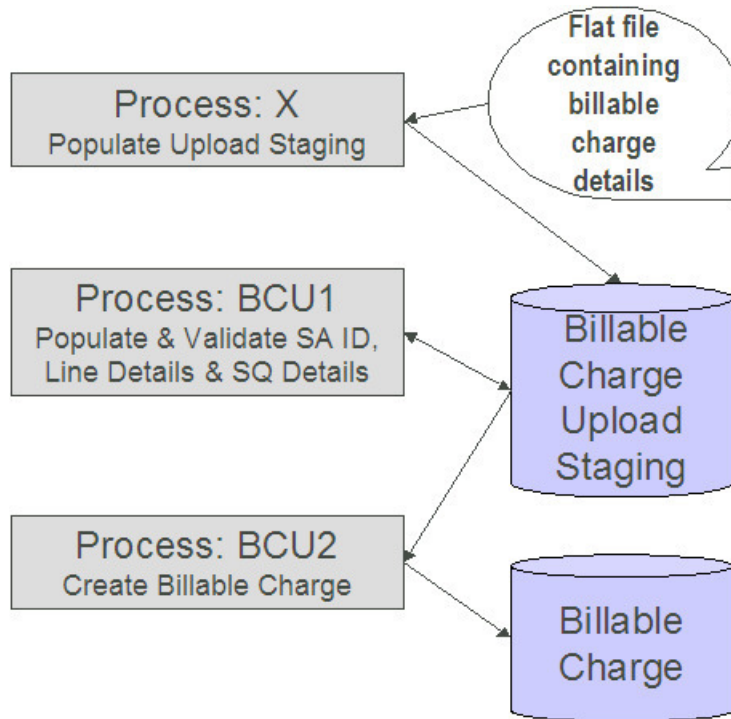

The topics in this section describe how these processes work.

Process X - Populate BC Upload Staging

Process X refers to the mechanism used by your organization to populate the various staging tables (shown in the yellow section of the following ERD).

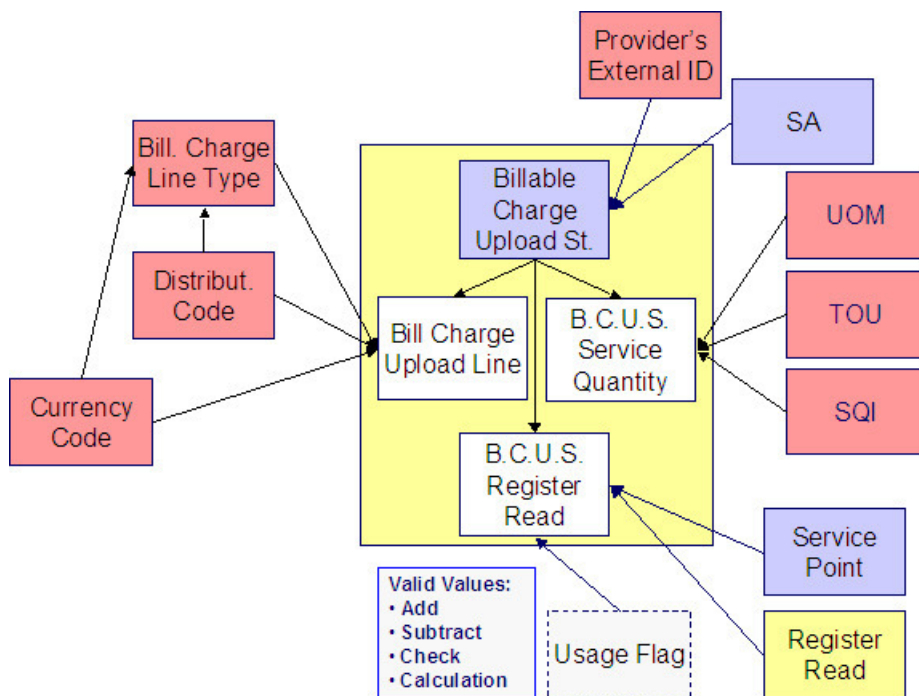

The topics in this section describe each of these tables.

Billable Charge Upload Staging Layout

You must create an upload staging record for each billable charge. The name of this table is **CL_BCHG_UP**. The following table describes each column on this table.

Column Name	Length	Req'd	Data Type	Comments
BCHG_UP_ID	30	Y	Char	This is the unique identifier of the record. This value does NOT have to be a random number, but it does need to be unique. If your process that inserts records on this table is capable of calling a routine, call ProgramCIPZKEYG and it will supply a 12 digit random number for you.
BCHG_UP_STAT_FLG	2	Y	Char	This must be set to P for Pending.
NT_XID_CD	30	N	Char	This is the external system id of the sender of the billable charge. See the description of the SA_EXT_REFT_ID field for how this field is used

				to determine the billable charge's SA_ID.
SA_EXT_REF_ID	36	N	Varchar2	This field along with NT_XID_CD are used to uniquely identify the service agreement against which the billable charge will be stored. These two fields are used to identify a SA relationship record; the SA relationship record, in turn, has a sub SA and it is this SA that the billable charge will be linked to. Note well: these fields are only necessary if you do not know the billable charge SA ID. Refer to Maintaining SA Relationships for more information.
BCHG_EXT_REF_ID	50	N	Varchar2	This is the identifier of the billable charge in the sender's system.
CRE_DTTM	26	N	Date/Time	The date and time the upload staging row was inserted (this can be used for audit purposes).
START_DT	10	Y	Date	The start date of the period encompassed by the billable charge.
END_DT	10	Y	Date	The end date of the billable charge period.
DESCR_ON_BILL	254	Y	Varchar2	This is the description that should prefix the charges on the printed bill.
SA_ID	10	See note	Char	This must correspond with a SA ID of a billable charge service agreement. You may leave this column blank if NT_XID_CD and SA_EXT_REF_ID are populated.
BILLABLE_CHG_ID	12	N	Char	Leave this column blank. It will be assigned by the system when it creates a billable charge record.

Billable Charge Line Upload Staging Layout

You must create a billable charge line upload record for each line to be uploaded. The name of this table is **CI_BCHG_LINE_UP**. The following table describes each column on this table.

NOTE:

Defaulting from BCHG_UP_XTYPE. Please pay special attention to the **Comments** column below as many fields, if left blank, will default from each record's BCHG_UP_XTYPE.

Column Name	Length	Req'd	Data Type	Comments
BCHG_UP_ID	30	Y	Char	This is the foreign key to the billable charge upload staging record.
LINE_SEQ	3	Y	N	This is the unique line number of the billable charge line. This value must be unique within the billable charge.
DESCR_ON_BILL	254	Y	Varchar2	This is the description that will be printed on the bill for the line.
CHARGE_AMT	13.2	N	N	This is the amount associated with the billable charge line.
BCHG_LINE_XID	20	N	Varchar2	This is the unique identifier of the billable charge line in the sender's system.
BCHG_UP_XTYPE	30	N	Char	This is the type of billable charge line. This is a foreign key reference to the billable charge line type control table. This control table is used to populate the remaining fields (if they are blank). If this field is blank, the remaining fields must be specified as they cannot be defaulted from the billable charge line type control table. Refer to Billable Charge Line Type for more information.
CURRENCY_CD	3	See note	Char	This is a foreign key reference to the currency code of the billable charge line. This field must be

				specified if CHARGE_ AMT is non-zero.
SHOW_ON_BILL_SW	1	See note	Char	This should be Y if the line should appear on the customer's printed bill. This should be N if the line should not appear on the customer's printed bill. If left blank, this value will be populated from the line's BCHG_UP_XTYPE.
APP_IN_SUMM_SW	1	See note	Char	This should be Y if the line appears in a summary line. This should be N if the line does not appear in a summary line. This switch plays a part at bill print time - those lines that appear in a summary print in the left dollar column, those that don't appear in a summary print in the right dollar column. If left blank, this value will be populated from the line's BCHG_UP_XTYPE.
MEMO_SW	1	See note	Char	This should be Y if the line does NOT affect the general ledger. This should be N if the line affects the general ledger. If left blank, this value will be populated from the line's BCHG_UP_XTYPE.
DST_ID	10	See note	Char	If the line affects the general ledger, the set ID (the previous field) and the distribution code of the GL account must be specified. If left blank, this value will be populated from the line's BCHG_UP_XTYPE.

Billable Charge Line Characteristic Upload Staging Layout

If you want to upload characteristics on your billable charge lines, you must create a billable charge line characteristic upload record for each characteristic on each line. The name of this table is **CI_B_LN_UP_CHAR**. The following table describes each column on this table.

Column Name	Length	Req'd	Data Type	Comments
BCHG_UP_ID	30	Y	Char	This is the foreign key to the billable charge upload staging record.
LINE_SEQ	3	Y	N	This is the foreign key to the billable charge line upload staging record
CHAR_TYPE_CD	8	Y	Char	This is the unique identifier of the billable charge line characteristics. This value must be unique within the billable charge line characteristics.
ADHOC_CHAR_VAL	30	N	Varchar2	An ad hoc characteristic value must be supplied if the ad hoc switch on characteristic type is Y. Otherwise, it is not allowed.
CHAR_VAL	16	N	Char	A characteristic value must be supplied if the ad hoc switch on characteristic type is N. Otherwise, it is not allowed.
CHAR_VAL_FK1	50	N	Varchar2	A characteristic value foreign key must be supplied if the ad hoc switch on characteristic type is Y. Otherwise, it is not allowed.
CHAR_VAL_FK2	50	N	Varchar2	A characteristic value foreign key must be supplied if the ad hoc switch on characteristic type is Y. Otherwise, it is not allowed.
CHAR_VAL_FK3	50	N	Varchar2	A characteristic value foreign key must be supplied if the ad hoc switch on characteristic type is Y. Otherwise, it is not allowed.
CHAR_VAL_FK4	50	N	Varchar2	A characteristic value foreign key must be supplied if the ad hoc switch on characteristic type is Y. Otherwise, it is not allowed.

CHAR_VAL_FK5	50	N	Varchar2	A characteristic value foreign key must be supplied if the ad hoc switch on characteristic type is Y. Otherwise, it is not allowed.
--------------	----	---	----------	---

Billable Charge Service Quantity Upload Staging Layout

You must create a billable charge service quantity upload record for each service quantity to be uploaded. The name of this table is **CI_BCHG_UP_SQ**. The following table describes each column on this table. Refer to ["pass through" charges](#) for more information about how this type of information is used.

Column Name	Length	Req'd	Data Type	Comments
BCHG_UP_ID	30	Y	Char	This is the foreign key to the billable charge upload staging record.
SEQ_NUM	3	Y	N	Sequence of the service quantity within the Billable Charge Upload
UOM_CD	30	N	Varchar	The unit of measure of the Billable Charge Upload SQ row. If specified, it must reference a valid value on CI_UOM. Note, at least one of the following fields should be specified: SQI_CD, TOU_CD, UOM_CD.
TOU_CD	30	N	Char	The time of use of the Billable Charge Upload SQ row. If specified, it must reference a valid value on CI_TOU. Note, at least one of the following fields should be specified: SQI_CD, TOU_CD, UOM_CD.
SQI_CD	30	N	Varchar	The service quantity identifier of the Billable Charge Upload SQ row. If specified, it must reference a valid value on CI_SQI. Note, at least one of the following fields should be specified: SQI_CD, TOU_CD, UOM_CD.

SVC_QTY	12.6	N	N	Quantity of the service used for the UOM / TOU / SQI combination
---------	------	---	---	--

Billable Charge Read Details Upload Staging Layout

You must create a billable charge read details upload record for each read detail to be uploaded. The name of this table is **CI_BCHG_UP_READ**. The following table describes each column on this table. Refer to "[pass through charges](#)" for more information about how this type of information is used.

Column Name	Length	Req'd	Data Type	Comments
BCHG_UP_ID	30	Y	Char	This is the foreign key to the billable charge upload staging record.
SP_ID	10	Y	Char	Note, if USAGE_FLG is calculation, you can set this field to 0 if you do not know the SP ID. The only thing that's important is that the combination of BCHG_UP_ID, SP_ID and SEQNO are unique.
SEQNO	5	Y	Number	This should be a value greater than zero. See SP_ID comment for more information. This is typically the sequence number of the register on the meter.
END_READ_DTTM	26	Y	DateTime	This is the date and time of the end read
END_REG_READ_ID	12	N	Char	This field must reference an existing register read ID if USAGE_FLG is anything other than a calculation.
END_REG_READING	9.6	Y	Number	This is the reading of the end read.
FINAL_REG_QTY	12.6	Y	Number	This is the final amount of the reading (this is the amount of billable consumption the read detail contributed to the entire billed consumption).
FINAL_SQI	8	N	Char	The service quantity identifier of the FINAL_REG_QTY. If specified, it must reference a valid

value on CI_SQI. Note, at least one of the following fields should be specified: FINAL_SQI, FINAL_UOM_CD.

FINAL_TOU_CD	8	N	Char	The time-of-use code of the FINAL_REG_QTY. If specified, it must reference a valid value on CI_TOU.
FINAL_UOM_CD	4	N	Char	The unit of measure of the FINAL_REG_QTY. If specified, it must reference a valid value on CI_UOM. Note, at least one of the following fields should be specified: FINAL_SQI, FINAL_UOM_CD.
HOW_TO_USE_FLG	2	Y	Char	See the field description in the data dictionary for the valid values (CI_BCHG_UP_READ).
MSR_PEAK_QTY_SW	1	Y	Char	Y or N
MSR_QTY	12.6	Y	Number	This is the difference between END_REG_READING and START_REG_READING for subtractive registers .
REG_CONST	6.6	Y	Number	This is the register's constant (the value used to adjust the measured quantity due to something associated with the physical meter). Set this to a value of 1 if it is not known.
SQI_CD	30	N	Varchar	The service quantity identifier of END_REG_READING and START_REG_READING . If specified, it must reference a valid value on CI_SQI. Note, at least one of the following fields should be specified: SQI_CD, TOU_CD, UOM_CD.
START_READ_DTTM	26	Y	DateTime	This is the date and time of the start reading.
START_REG_READ_ID	12	Y	Char	This field must reference an existing register read

				ID if USAGE_FLG is anything other than a calculation.
START_REG_READING	9.6	Y	Number	This is the reading of the start read.
TOU_CD	30	N	Char	The time-of-use code of END_REG_READING and START_REG_READING . If specified, it must reference a valid value on CI_TOU .
UOM_CD	30	Y	Char	The unit of measure of END_REG_READING and START_REG_READING .
USAGE_FLG	2	Y	Char	See the field description in the data dictionary for the valid values (CI_BCHG_UP_READ).
USE_PCT	3	Y	Number	This is the percentage of the consumption that was billed (this will typically be 100).

BCU1 - Validate & Populate Billable Charge Upload Staging

This process has several functions:

- It populates the SA ID on all BC upload staging records where SA ID is left blank. This means that you don't have to know the SA ID in order to interface a billable charge into the system. The program populates SA ID with the service agreement related to the SA relationship with the most recent effective date for a given combination of service provider's external system ID and customer's ID in the sender's system. The system can only do this if the following points are true:
- You use the system's SA relationship functionality to define that you provide bill ready billing services for a service provider. On the customer's SA relationship record you must define the customer's ID in the service provider's system. Refer to [Maintaining SA Relationships](#) for more information.
- You identify the service provider's external system ID on the billable charge upload staging record.
- You identify the customer's ID in the sender's system.

NOTE:

You can still interface billable charges if you don't use the system's SA relationship functionality. How? You simply need to derive the SA ID associated with the uploaded billable charge.

- It populates various fields (e.g., the GL distribution code, memo only switch) on the billable charge upload line records from the billable charge line type specified on each respective record.

Any validation / population errors detected during this process are written to the [BC Upload Exception](#) table. You can fix errors using BC Upload Staging page (don't forget to change the record's status back to Pending).

BCU2 - Create Billable Charge

This process creates a billable charge and billable charge lines (shown in the yellow section of the following ERD) for all BC upload records in the Pending state.

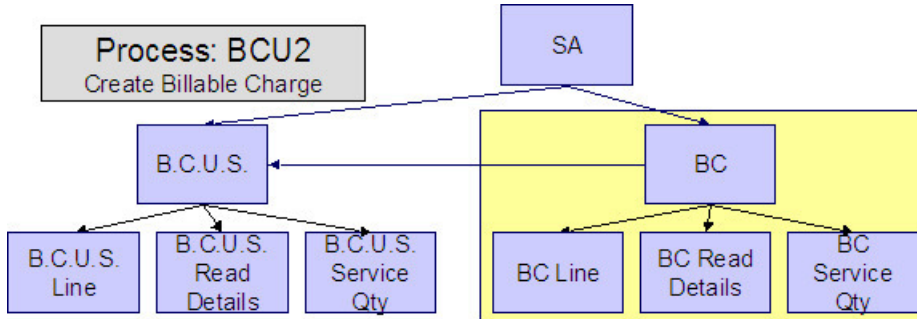

If the billable charge's SA is Closed, it will Reactivate it so that the billable charges will be swept onto the next bill produced for the account.

NOTE:

This process will override the values of the various switches referenced on billable charge upload staging line if the respective service agreement's SA type has an override value for the line's billable charge line type. Refer to [SA Type - Billable Charge Overrides](#) for more information.

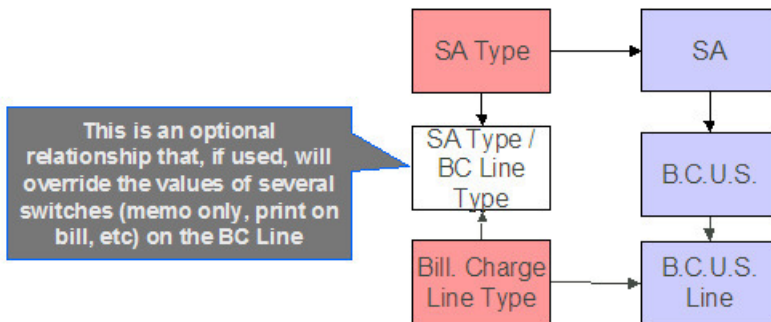

Any errors detected during this process are written to the [Billable Charge Upload Exception](#) table. You can fix errors using BC Upload Staging page (don't forget to change the record's status back to Pending).

BCUP-PRG - Purge Billable Charge Upload Objects

Completed billable charge upload staging objects should be periodically purged from the system by executing the [BCUP-PRG](#) background process. This background process allows you to purge all Completed billable charge upload staging objects older than a given number of days.

We want to stress that there is no system constraint as to the number of Completed billable charge upload objects that may exist. You can retain these objects for as long as you desire. However we recommend that you periodically purge Completed billable charge upload objects as they exist only to satisfy auditing and reporting needs.

Billable Charge Upload Staging

The Billable charge Upload Staging page has three purposes:

- You can view historical billable charge upload records.
- You can correct billable charge upload records that are in error.
- You can add new billable charge upload records. These will be uploaded by the billable charge upload process (although it's probably easier to just add the billable charges using the [Maintaining Billable Charges](#) page).

The topics in the section describe how to maintain this information.

Billable Charge Upload - Main

Open this page using **Menu > Financial > Billable Charge Upload Staging > Search**.

Description of Page

FASTPATH:

Refer to [Billable Charge Upload Staging](#) for more information about these fields.

NOTE:

Correcting Errors. If a Billable Charge Upload record's status is Error , you should correct the problem and then change its status back to Pending. The next time the billable charge upload process runs, it will revalidate the record and, if valid, it will create a billable charge record.

Billable Charge Upload - Lines

Open this page using **Menu > Financial > Billable Charge Upload Staging > Search** and navigate to the **Lines** page.

Description of Page

FASTPATH:

Refer to [Billable Charge Line Upload Staging](#) for more information about these fields.

Billable Charge Upload - SQ Details

Open this page using **Menu > Financial > Billable Charge Upload Staging > Search** and navigate to the **SQ Details** page.

Description of Page

FASTPATH:

Refer to [Billable Charge Service Quantity Upload Staging](#) for more information about these fields.

Billable Charge Upload - Read Details

Optionally, you may specify meter read details associated with a billable charge. These are most commonly used when you need to print the read details that were used to calculate the bill lines that appear on the main tab.

NOTE:

Using these reads to derive billable consumption. The base package bill segment creation algorithm (BSBS-BC) simply sweeps billable charge read details onto the related [bill segment's read detail](#). This algorithm does NOT use these reads to derive billable consumption. This is intentional as most implementations that import reads also import billable consumption and therefore deriving billable consumption is unnecessary (and also error prone). If your implementation needs to derive billable consumption from these reads, you can develop your own bill segment creation algorithm to do just this.

Open **Menu > Financial > Billable Charge Upload Staging > Search** and navigate to the **Read Details** page to view this information.

Description of Page

FASTPATH:

Refer to [Billable Charge Read Details Upload Staging](#) for more information about these fields.

Billable Charge Upload Exception

If errors are detected during the billable charge upload process, a record is written to the billable charge upload exception table with a message indicating the nature of the severe error.

To view the messages associated with the exception records, schedule the [TD-BCUPL](#) background process. This process generates a To Do entry for every record in the billable charge upload exception table.

You can fix this error using the [Billable Charge Upload Staging](#) page and change the status of the record from Error to Pending. When the billable charge upload process next runs, it attempts to upload this record again.

Budget Review

This portal shows account budgets that require manual review, as identified by the [Budget Monitor](#) process.

You can access this portal from **Menu > Financial Query > Budget Review**.

Refer to the embedded help text for more information.

Payments

In this section, we describe how to manage your customer's payments.

The Big Picture of Payments

A payment reduces how much an account owes. The topics in this section provide background information about a variety of payment topics.

A Payment Event Has Payments And Tenders

The explanation in [The Financial Big Picture](#) provides an accurate, but incomplete view of payments. The missing pieces concern *payment events* and *tenders*. The following diagram illustrates the difference between a payment event, its payment(s) and its tender(s).

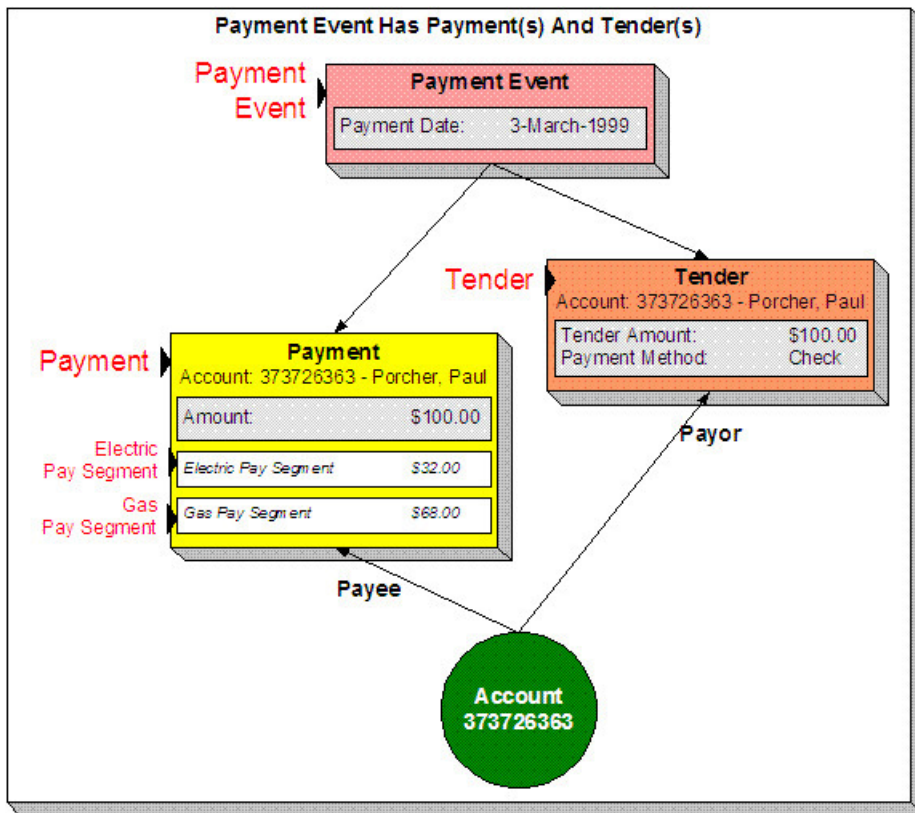

The following concepts are illustrated above:

A payment event defines the event A payment event is required whenever any form of payment is received. The payment event defines the payment date (and that's all).

A payment event has tender(s) A tender exists for every form of tender remitted as part of the payment event. A payment event must have at least one tender otherwise nothing was remitted. A payment event may have many tenders when multiple payment methods are associated with an event (e.g., paying with cash, a check, and a credit card).

A payment is allocated to account(s) The total amount of tenders under a payment event is distributed to one or more accounts.

A payment is distributed to SAs The system allocates an account's payment amount amongst its service agreements. The system creates a payment segment for each service agreement that receives a portion of the payment.

Payor and payee are frequently the same The account remitting the tender (the payor) is frequently the same as the account to which the funds are allocated (the payee). The next illustration provides an example when this is not the case.

Multiple Tenders Used To Pay For Multiple Accounts

The following diagram illustrates a payment event with multiple tenders where the payor of the tender is not the same as the account(s) receiving the payment.

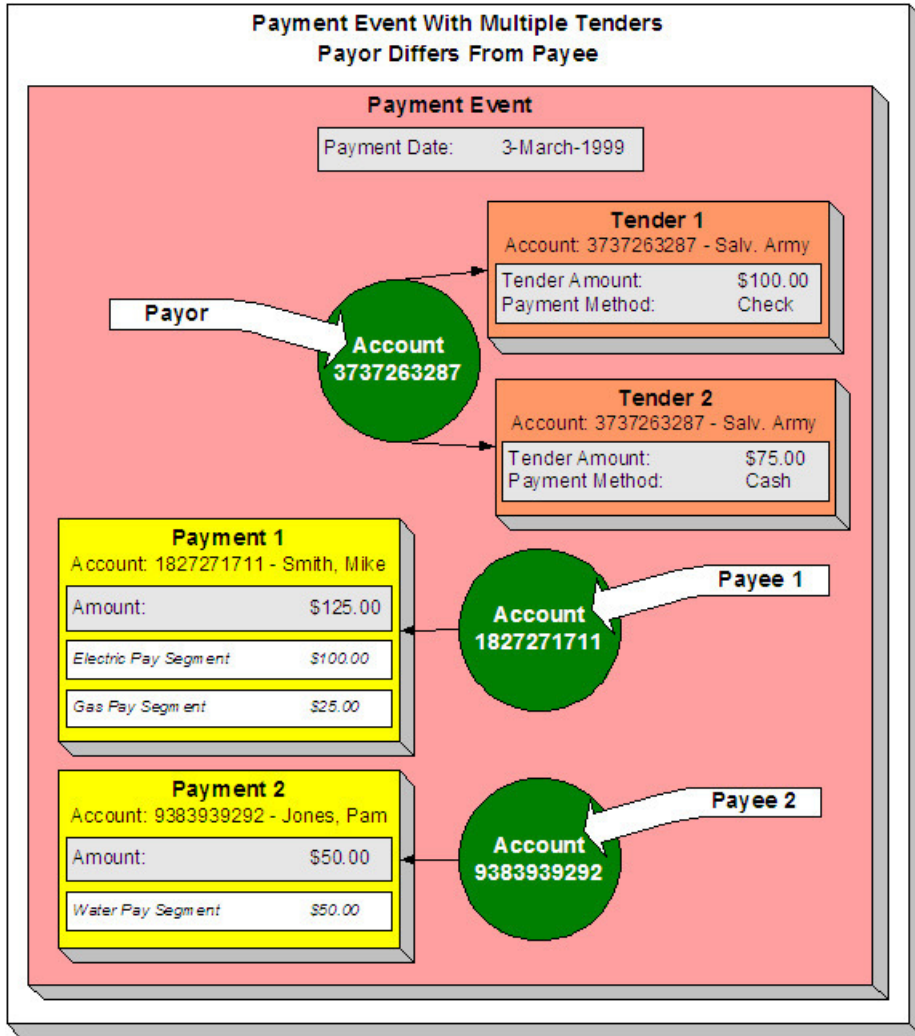

A payment event may have many tenders A single payment event may have many tenders. While the above example shows both tenders being paid by the same account, each tender may reference a different account.

Many accounts may be paid under 1 event The total amount of tenders under a payment event are distributed to one or more accounts.

Payor may differ from payee The account(s) remitting the tender may differ from the account(s) whose debt is relieved.

An Overview Of The Payment Event Creation & Allocation Process

When a payment event occurs, the system stores a tender for each form of remittance (e.g., cash, check, charge). It then allocates the sum of the tenders to one or more accounts.

By default, the system allocates the sum of the tenders to the account that remits the tenders. You may override this default and specify any number of accounts and their respective payment allocation amount. This is useful, for example, when a social service agency pays for many accounts. If applicable, you may also configure the system to use your own payment event distribution rule(s).

FASTPATH:

Refer to [Distributing A Payment Event](#) for more information.

The system distributes a payment amongst an account's service agreements based on the age of each service agreement's debt AND distribution priority. The system creates a payment segment for each service agreement that receives part of the payment.

FASTPATH:

Refer to [Distributing A Payment Amongst An Account's Service Agreements](#) for more information.

You may manually redistribute the payment amount amongst the account's service agreements before you commit the distribution. When the distribution is acceptable, you freeze the payment. Freezing a payment causes the system to create a financial transaction for each related payment segment. It is the financial transaction(s) that causes the service agreements' payoff and current balances to be reduced. The financial transaction also contains the journal details that debit "cash" and credit some other GL account.

And that's it. The remaining topics in this section provide more information about the creation and allocation of payment events.

NOTE:

Batch and real-time payment event creation / allocation. There is only one payment event creation / allocation routine and therefore anything the batch payment process does for whole batches of payments, you can do to a payment on-line.

Distributing A Payment Event

WARNING:

This section deals with the concept distributing a payment amount into payment(s). It does not discuss the distribution of a single payment into segments. **For more information** about payment distribution, refer to [Distributing A Payment Amongst An Account's Service Agreements](#).

The base-package, by default, creates a single payment for a payment event. Some business practices require potentially many payments to be created when payment events are added.

A few examples of when multiple payments may be necessary are:

- A payment amount needs to be distributed towards different distribution types:
 - \$50 in interest
 - \$60 in collection charges
 - \$70 in taxes
- Each of the above distributions is realized as a separate payment identified by its own match type (i.e., there'll be one match type called Interest, another called Collection Charges, etc.).

In this example, the debt of a single service agreement may be relieved by each of these payments.

- In a similar way, you may want to create a separate payment for an overpayment to differentiate it from regular payments (using yet another match type).
- In the case of a social service agency that pays for many accounts, a single payment event may be distributed amongst multiple accounts.

The method by which a payment amount is distributed to create payment(s) is contained in Create Payment [algorithms](#) plugged in on a distribution rule.

There is yet another aspect to having control over how payment events are created. The default method of creating payment events assumes knowledge of account IDs (of the payor and the payee) when making a payment. In cases where payments are made by and towards business entities other than accounts, knowledge of their corresponding account IDs may not be available at payment time. Consider the following examples:

- A payment is made to pay a person's bill, providing the person's identification at payment time.
- A payment is made towards a specific service agreement using a "contract number" defined as SA characteristic.

The method by which the tender account is determined by means of an alternate identifier is contained in Determine Tender Account [algorithm](#) plugged in on a distribution rule.

FASTPATH:

Refer to [Making Payments Using Distribution Rules](#) for information on how to configure your system to use this distribution method.

Distributing A Payment Amongst An Account's Service Agreements

WARNING:

This section deals with the concept of distributing a payment amongst an account's service agreements. It does not discuss how the sum of a payment event's tenders is balanced out by payment allocations. **For more information** about payment event balance, refer to [Unbalanced Payment Events](#).

A payment must be distributed to one or more service agreements for its financial impact to be realized. When a payment satisfies an account's entire debt, you don't have to worry about how the system distributes the payment. The concept of payment distribution is only relevant when a partial or excess payment is distributed.

The first important point to understand is that the method of distributing a payment amongst an account's service agreements is contained in an algorithm that's plugged in on to [Customer Class](#). This means that you can have different distribution algorithms for different customer classes.

NOTE:

Manual overrides. Most of the time, you'll let the payment distribution algorithm distribute the payment amongst an account's service agreements. However, you may manually distribute a payment when a customer directs a payment to specific service agreement(s).

The following explanation describes one of the base package payment distribution algorithms (refer to Payment Distribution - Pay Priority and Debt Age (PYDIST-PPRTY) for information about this algorithm). This algorithm distributes a payment based on:

- The age of each service agreement's debt.
- The payment distribution priority of each service agreement's SA type.

The following diagram helps illustrate how the distribution algorithm works.

**Distributing A Payment Amongst An Account's Service Agreements
Is Controlled By The Age Of The Debt And The SA's Distribution Priority**

		Priority 10 (Highest)		Priority 90 (Lowest)		
		SA #1	SA #2	SA #3		
Excess Credits		16				
New Debits*		13	14	15		
Non-Delinquent		10	11	12		
A r r e a r s	35-day Arrears	5	6	9	35-day Arrears	
	66-day Arrears	3	4	8	52-day Arrears	
	93-day Arrears	1	2	7	93-day Arrears	

*--Includes all charges not yet invoiced to the customer.

The above example shows three columns, one for each service agreement linked to a hypothetical account. Notice that two of the service agreements have the same distribution priority, the third has a lower priority. The numbers in the cells indicate the order in which the system distributes a partial payment.

NOTE:

Debt terminology. Before we can discuss the distribution algorithm, you must understand the terminology we use to categorize debt. **Delinquent** debt is associated with financial transactions that appear on overdue bills. **Non-delinquent** debt is associated with financial transactions that appear on current bills. **New debits** debt is associated with financial transactions that do not yet appear on a completed bill (e.g., a late payment charge that hasn't been billed yet).

The following points describe the algorithm used to distribute the partial payment:

- The system pays off delinquent debt of the highest priority service agreements first. In the above example, where multiple service agreements have the same distribution priority, the system does NOT payoff one service agreement before it starts on the next (which one would it pick?). Rather, it distributes the payment amongst the service agreements based on the age of the respective debt on each service agreement. In the above example, this is represented by steps 1 through 6 (notice how the distribution jumps between SA1 and SA2).
- After all delinquent debt has been relieved from the highest priority service agreement(s), the system pays off the next priority until all delinquent debt is relieved. In the above example, this is represented by steps 7 through 9.
- The system next pays off non-delinquent debt using each service agreement's respective distribution priority. Note well, the payment distribution algorithm doesn't associate an age with non-delinquent debt and therefore the distribution is

based purely on the service agreements' respective distribution priority. In the above example, this is represented by steps 10 through 12.

- After all non-delinquent debt is relieved, the system next pays off "new debit" debt based on the service agreements' respective distribution priority. In the above example, this is represented by steps 13 through 15.
- Refer to [Overpayment](#) for a description of what happens if money still exists after the above distribution is complete.

NOTE:

Payment segments and financial transactions. A payment segment exists for each service agreement that receives a portion of a payment. Linked to each payment segment is a financial transaction. It is the financial transaction that causes the service agreement's debt to be relieved and the general ledger to be impacted.

FASTPATH:

Refer to [Payment Exception](#) for more information about how the system handles errors detected during the payment distribution process.

NOTE:

Overriding the distribution algorithm for uploaded payments. The standard distribution algorithm is used for payments that are [Interfaced From An External System](#) unless you specify a MATCH_VALUE and MATCH_FLG on the [Payment Staging](#) row associated with the uploaded payment. These fields are used in conjunction to indicate that the distribution of the payment should be restricted in some way (i.e., the standard payment distribution algorithm should not be used). MATCH_FLG indicates how the payment should be distributed (e.g., only distribute to a specific service agreement), MATCH_VALUE contains the ID of the restriction (e.g., the SA ID).

Open item customers. For an [open-item customer](#), you MUST override the standard distribution algorithm because the payment is distributed as per the open items that it is relieving. Refer to [Payments And Match Events](#) for more information.

Overpayment

Overpayment refers to the situation where money is left over after a payment has been distributed to all eligible service agreements, and all debt is relieved. Refer to [Overpayment Segmentation](#) for a description on how to configure the system to handle your overpayment requirements.

Canceling A Tender Versus Canceling A Payment

A payment event has tender(s) and payment(s). You can cancel a tender when it's not valid, e.g., when a check bounces. You can cancel a payment when the account should not have received the payment (e.g., a misdistribution or a canceled tender).

When you cancel a tender, the system automatically cancels ALL frozen payments. We do this because if the tender is canceled, there are no funds to distribute to accounts (unless there are other non-canceled tenders under the event). However, when you cancel a payment, the system does NOT cancel the tender(s) because we assume that, if the tenders were incorrect, you would have canceled them rather than the payment.

NSF Cancellations

When a tender is canceled, a cancellation reason must be supplied. If the cancellation reason indicates a NSF (non sufficient funds) charge should be levied, the system invokes the NSF charge algorithm specified on the tender's account's [customer class](#). Algorithms of this type will typically create an adjustment or billable charge to levy the NSF charge. Refer to NSFC-DFLT for an example of such an algorithm.

NOTE:

The payor gets the NSF adjustments. It's possible for the payor of a tender to differ from the payee (e.g., when a social service agency pays for other customers' debt). When you cancel a tender you must specify a cancellation reason. If the cancellation reason indicates an NSF charge should be levied, the sample algorithm provided with the system levies the NSF charge on the PAYOR's account. Because adjustments must be linked to a service agreement, the algorithm picks the payor's service agreement with the highest payment distribution priority and levies the adjustment specified in the service agreement's SA type's NSF adjustment type.

Besides calling this algorithm, a NSF cancellation may affect the tendering [account's credit rating and cash-only score](#). The cancellation reason indicates the extent to which the account's ratings are affected.

And finally, whenever a tender is canceled due to non-sufficient funds, the account is scheduled for review by the [Account Debt Monitor](#).

Transferring A Payment

If the account on an event's tender and payment are wrong, you can use the [Transfer](#) button on the Payment Event page to transfer the payment to another account.

If the account on the payment is wrong - but the tender is correct, you can use the [Transfer](#) button on the Payment page to transfer the payment only to another account.

Unbalanced Payment Events

The system, by default, distributes the sum of a payment event's tenders to the account that remits the tender with a single payment. After distribution the sum of the tenders equals the sum of the payments when the event is first created. We refer to such an event as being balanced.

However, it is possible for an event's tender amount to not equal the sum of the payment allocations (i.e., the event becomes unbalanced). How? Well, there are several ways this can happen:

- While the system DEFAULTS the payment amount to be the tender amount, you can override the payment amount and therefore make a previously balanced event unbalanced.
- While the system DEFAULTS the payment account to be the tender account, you can add additional accounts / amounts and therefore make a previously balanced event unbalanced.
- When you cancel a tender (e.g., because a check bounces), the system cancels ALL payments linked to the tenders payment event. If the payment event has multiple tenders, this will cause the event to become unbalanced. To correct this situation, you must add payment allocations to equal the amount of uncanceled tenders.
- If you cancel a payment and forget to add another payment for the same amount, the event becomes unbalanced. To correct this situation, you must add another payment (or cancel the tender).
- You may delete a tender from an event while its tender control is open. If you delete a tender and don't do anything about the related payments, the event becomes unbalanced.
- You may add a tender to an event at any time. If you don't allocate the tender amount to an account, the event becomes unbalanced.

FASTPATH:

Refer to [Payment Event Exception](#) for more information about how the system reminds you about unbalanced payment events.

How And When Payments Appear On Bills

FASTPATH:

Refer to [Financial Transactions Created Between Bills](#) for more information.

Tender Management and Workstation Cashiering

When you add a tender, you must identify its **Tender Source**. For example,

- A specific cash drawer ID is the source of tenders remitted to a cashier.
- The notional lockbox ID is the source of tenders interfaced from a lockbox.
- The remittance processor is the source of tenders interfaced from a remittance processor.

NOTE:

Default note. When a user adds a tender control the system attempts to default a tender source based on the currency of the deposit control and the tender source(s) defined on the user's record. If your organization accepts alternate currency payments, then a tender source must exist for each currency code accepted at a location.

FASTPATH:

For more information, refer to [Setting Up Tender Sources](#).

A tender source's tenders must be balanced against an expected total before they can be deposited at a bank. This periodic balancing requires all tenders to exist in respect of a **Tender Control**. Over time, a tender source may have many tender controls (one per balancing event).

An example of a cashier's cash drawer will help clarify the tender control concept:

- When a cashier starts in the morning, they start with a fresh cash drawer (i.e., one without tenders). Whenever a drawer starts afresh, a new Tender Control must be created because you balance the contents of a drawer.
- A cash drawer typically contains funds to make change. These funds are the tender control's **Opening Balance**.

NOTE:

Default note. A tender control's starting balance defaults from its tender source.

- During the day, customers remit tenders to the cashier. Every tender put into the drawer is associated with the drawer's tender control created at the start of the day.
- A tender control's balance increases during the day as tenders are recorded. A cashier can view the balance at any time.
- The cashier can turn in funds to the head cashier during the day. Each turn in event can be recorded in the system. Note well, if the amount of funds in a tender control exceeds the maximum balance defined on the tender control's tender source, a warning is issued to the cashier to remind them to turn in funds.

- At some point, the contents of the drawer must be balanced against the total tenders linked to the tender control. When balancing starts, no additional tenders may be put into the tender control. If the cashier receives additional tenders after balancing starts, a new tender control must be created (and the above process starts afresh).
- During the balancing process, some modifications may be made to the tenders associated with the tender control, but no additional tenders may be added. When the tender control is balanced, neither it nor its tenders may be modified.

FASTPATH:

For more information, refer to [Managing Your Cash Drawers](#).

While the above explanation is true, it isn't complete. In addition to the requirement that a tender must reference a tender control, the tender control must refer to a **Deposit Control**. Deposit controls give you administrative control over all of the tender controls whose contents will be deposited en masse. The following concepts will help explain the power of deposit controls:

- As explained above, when a cash drawer is started afresh, a new tender control must be created. The tender control "holds" all new tenders received by the cashier.
- Similarly, when a tender control is created, it must reference a deposit control. During the day, a deposit control's tender controls are constantly changing. You can view the total impact of a deposit control's tender controls at any time.
- At some point, you will want to deposit the tenders received during the day. To do this, you must indicate how much will be deposited at the bank. This deposit amount must equal the sum of the tender controls linked to the cash drawer. When this deposit balancing starts, no additional tender controls may be associated with the deposit control.
- When the deposit total equals the sum of the tender controls, the deposit control becomes balanced and no changes may be made to it, its tender controls, or its tender controls' tenders.

FASTPATH:

For more information, refer to [Managing Your Cash Drawers](#).

NOTE:

Background processes use the same concepts. Tenders that are interfaced from external sources (e.g., lockboxes and remittance processors) make use of the concepts describe above. For example, tenders interfaced from a remittance processor are linked to a tender control and this tender control is linked to a deposit control. The main difference is that the background processes require no human intervention; the system automatically creates tender and deposit controls and sets their states to balanced when the interface concludes successfully.

The ACH activation process also creates tender and deposit controls. Refer to [Activating Automatic Payments](#) for more information.

The topics in this section elaborate on the tender management concepts described above.

Managing Your Cash Drawers

WARNING:

This section assumes you are familiar with the concepts described in [The Lifecycle Of A Deposit Control](#) and [The Lifecycle Of A Tender Control](#).

There are many ways to handle the daily management of tenders received via cash drawers. It really depends on how your organization works. To help you understand the potential of the system, we'll continue the example started above.

Assume that the cash drawers in your western office are balanced and deposited independently from those in your eastern office. We'll assume that both offices follows the same daily routine:

- Load fresh drawers first thing in the morning. Each drawer contains a starting balance of \$150.00. Note: the drawer's tender control's starting balance defaults from its tender source.
- At 10 am, the cashier turns in funds to the chief cashier and continues to receive additional tenders.
- At 12 noon, each drawer is pulled and balanced by a supervisor.
- By 12:30 pm, the tender controls are balanced.
- At 4 pm, the cashiering stations are closed. Each drawer is pulled and balanced by a supervisor.
- By 4:30 pm, the tender controls are balanced.
- At 5 pm, the deposit control is balanced and funds are ready to be deposited at the bank.

Given this, the following diagram illustrates the deposit controls and tender controls used by each office on a given day.

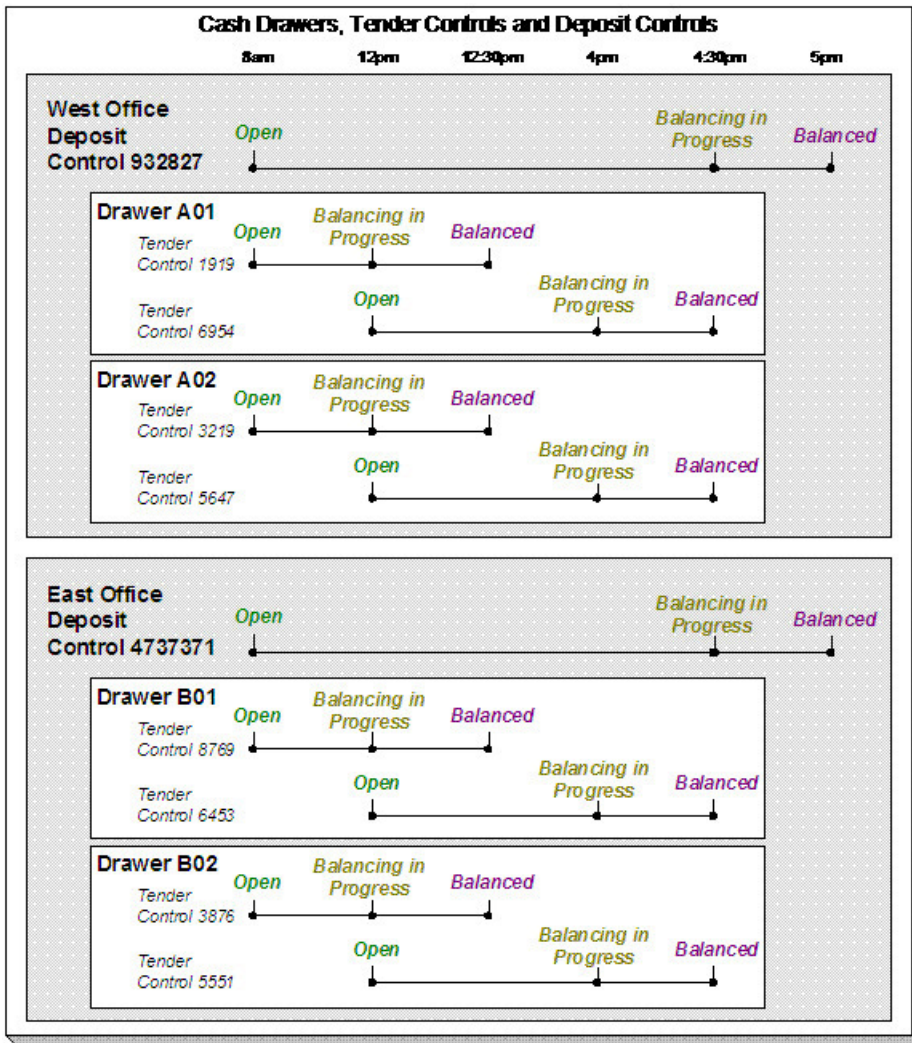

The following concepts are illustrated above:

- An Open deposit control must exist before you can create a tender control. And an Open tender control must exist before you can create a tender. From a business process standpoint, this means:
 - A supervisor would create a deposit control at the start of the day (8 am in the above illustration).
 - Each cashier would create a tender control when they start a drawer and reference the deposit control created by the supervisor.

- During the day, the cashier can turn-in moneys to the chief cashier. These turn-in events are recorded in the system as they play a part in the ultimate balancing of the drawer. Refer to [Turn Ins](#) for more information.
- At some point, the contents of a drawer can be pulled and balanced. If additional tenders can be received in a drawer, a new tender control must be created for the drawer. Refer to [Balancing By Tender Type](#) for more information.
- At the end of the day, the supervisor checks to make certain that all tender controls linked to the deposit control are Balanced. After this has been done, the supervisor indicates the deposit amount on the deposit control and changes it to Balanced. Notice that in the above illustration each deposit control references four tender controls.

NOTE:

Alternate currency payments. If your organization accepts payments in alternate currencies, that is, a currency other than the account's currency; a supervisor would create a deposit control for each such currency. Likewise, the cashier would create a tender control for each such currency.

FASTPATH:

Refer to [Alternate Currency Payments](#) for more information.

- Typically, a cash drawer has one tender control Open at any point in time (meaning that the tenders being received are being linked to a specific tender control). However, this is not a hard rule. If you want, you may have multiple tender controls Open at any point for a specific cash drawer (for example, if multiple cashiers can work the same drawer during the day but take their drawer with them).
- Typically, a specific cashier puts tenders into a specific tender control. However, this is not a hard rule. On a tender control, you can define if it's limited to a specific operator OR if any operator can link tenders to it.
- When you're ready to balance a drawer, you change the tender control to Balancing in Progress. This prevents new tenders from being added to the tender control. If the cashier can continue to receive tenders, they must create another tender control. In the above example, all drawers are balanced at 12 noon by a supervisor while the cashier continues to take payments.
- When the tender control is balanced, you change its state to Balanced. This prevents any changes to the tender control or its tenders.
- All tender controls exist in respect of a deposit control (in fact, the deposit control must be created before the tender control). This way, a supervisor can check the state of the related drawers throughout the day. Notice that the state transition of a deposit control is identical to that of the tender control (refer to [The Lifecycle Of A Deposit Control](#) and [The Lifecycle Of A Tender Control](#)). There is only a temporal difference. Notice that the deposit control stays open throughout the day while any number of tender controls are being opened and balanced.

NOTE:

Multiple deposits in a day. While the above example illustrates a single deposit per office per day, it is quite possible to have multiple deposit controls on any given day.

Turns ins. The above example did not illustrate the fact that a cashier can turn-in moneys during the day without having to balance the drawer. Refer to [Turn Ins](#) for more information.

Turn Ins

A cashier may optionally turn-in funds received into a cash drawer to a head cashier. The turn-in process requires two steps:

- Each time a cashier turns-in funds, they add a turn-in event on the [Tender Control - Turn Ins](#) page. Note that a separate turn-in event is required for each type of tender that's turned in. This is because the balancing of a tender control is performed for each tender type and therefore the system must know how much of each tender type has been removed from the drawer.

NOTE:

Turn in warning. If the amount of cash-like funds in a tender control exceeds the maximum balance defined on the tender control's tender source, a warning is issued to the cashier to remind them to turn in funds.

- The head cashier (the person responsible for the deposit control associated with the various tender controls) approves the turn in using the [Deposit Control - Turn Ins](#) page.
-

NOTE:

All turn-ins must be approved for balancing to complete. A tender control cannot be balanced until the head cashier has approved all turn-in events.

Balancing By Tender Type

It should be noted that when it's time to balance a tender control, the cashier must enter the amount of each tender type that is in the drawer in order to balance it. For example, assume the following takes place:

- A drawer is opened with a starting balance of \$150.50 (tender type is Cash).
- During the day, the cashier receives \$5,000 in Cash, and \$1,000 in Checks.
- During the day, the cashier turns in \$750 of the Checks and \$4,000 of Cash.

At the end of the day, the following operator would have to enter the balances shown in the Ending Balance column.

Tender Type	Starting Balance	Tenders Received	Turn Ins	Ending Balance
Cash	\$150.50	\$5,000	\$4,000	\$1150.50
Check	-	\$1,000	\$750	\$250

NOTE:

Time saver. The system assists in the balancing effort by amalgamating the amount of tenders by tender type when the tender control's status is changed from Open to Balancing In Progress. The cashier just needs to enter the Ending Balance. The system can then compare the cashier's Ending Balance against the Expected Ending Balance. When these values are equal for all tender types, the tender control's status can become Balanced.

Cash Back

When a [payment is added](#), the user defines the following:

- The amount of debt to be relieved (i.e., the payment amount)
- The amount remitted (i.e., the tender amount)
- The form of the remittance (i.e., the [tender type](#))

The payment amount typically equals the tender amount unless cash will be returned to the customer. For example, if a customer remits \$100, but only wants to pay off \$25 of debt, the tender amount will be \$100 and the payment amount will be \$25. The system will only allow a user to remit more than the payment amount if the tender type indicates "cash back" is allowed. For example, you may not allow cash to be returned if a check is remitted, but you may allow it to be returned if cash is remitted.

If cash back is allowed for the tender type, the system displays the amount of cash to be returned on the [Payment Event](#). In addition, because the system enforces [balancing the cash drawer by tender type](#), the system adjusts the payment event's tendered information as follows:

- When there is cash back, the payment event will have two tenders - one will be for the amount and type entered by the user, the other will be a negative amount with a tender type of cash (note, this tender type is retrieved from the Starting Balance Tender Type on the [installation record](#)). For example, if a customer remits \$100 in traveler's checks, but only wants to pay off \$25 of debt, there will be two tenders: one for the \$100 travelers check and the other for the -\$25 of cash.

NOTE:

Alternate currency payments. If your organization accepts payments in alternate currencies, that is, a currency other than the account's currency; the cash back tender is always created in the account's currency.

NOTE:

Multiple tenders and payment cancellation. If multiple tenders were created because of "cash back" processing, both tenders must be cancelled if the payment event needs to be cancelled.

When modifying an unfrozen payment on the [Payment Event](#), if the payment becomes unbalanced, a button is displayed allowing the user to **Recalculate Cash Back**. If the user clicks this button, the system reassesses the cash back tender as follows:

- If there is now cash back, a new tender is created for the credit amount
- If the cash back amount has changed, the tender for the cash back is adjusted to the new amount
- If there is no longer cash back due, the tender for the cash back is removed.

Managing Payments Interfaced From External Sources

Just like a payment recorded on-line via a cash drawer, a payment interfaced from an external source (e.g., lock box or remittance processor) must reference a tender control and the tender controls, in turn, must reference a deposit control. The only real differences between these two types of payments are highlighted below:

- Whilst an operator must create and balance the tender and deposit controls for real-time payments, the system creates the tender and deposit controls associated with interfaced payments.
- It's impossible for an invalid account to be referenced on a payment recorded real-time. However, it is quite possible for an interfaced payment to reference an unknown account. If an invalid account is referenced on an interfaced payment (using no distribution rules), the system links it to the suspense service agreement referenced on the tender source control table.

FASTPATH:

Refer to [Interfacing Payments From External Sources](#) for more information.

Payment Financial Transaction Considerations

A payment segment exists for each service agreement that receives a portion of a payment. Linked to every frozen payment segment is a financial transaction. This financial transaction affects a service agreement's payoff balance and/or current balance. It also contains the journal details that debit cash and credit some other account.

The topics in this section provide information about the financial impact of a payment segment.

FASTPATH:

Refer to [The Financial Big Picture](#) for more information about a payment's place in the financial big picture.

Payment - Current Balance versus Payoff Balance

WARNING:

If you do not understand the difference between payoff balance and current balance, refer to [Current Amount versus Payoff Amount](#).

A payment segment financial transaction almost always affects payoff balance and current balance by the same amount (think of it like this - when a customer pays, the amount they think they owe goes down by the amount they really owe). The only exception is a payment segment for a charitable contribution. These payment segments only affect current balance because the customer was never billed for the contribution in the first place.

FASTPATH:

Refer to [Setting Up Payment Segment Types](#) for more information about how payment segment type affects how a payment segment is produced and how its financial transaction is generated.

The Source Of GL Accounts On A Payment Financial Transaction

A payment segment's financial transaction also contains the double-sided accounting entry that defines how the payment segment affects the general ledger.

FASTPATH:

Refer to [The Source Of GL Accounts On Financial Transactions](#) for a description of where the system extracts the distribution codes used to construct the GL accounts.

A Payment May Affect More Than Just Customer Balances

The topics in this section provide information about obscure things that may happen when a payment is distributed and frozen.

Open Item Accounting and Match Events

FASTPATH:

Refer to [Payments and Match Events](#) for more information about how payments can create match events for open-item accounts.

FT Freeze Repercussions

FASTPATH:

Refer to [Obscure Things That Can Happen](#) for more information about things that can happen when an FT is frozen (and FT's get frozen when a payment is frozen).

Automatic Payments

This section discusses how to set up and manage customers who pay their bills automatically (via direct debit or credit card debits)

How To Set Up A Customer To Pay Automatically

If a customer wants to pay automatically, transfer to [Account - Auto Pay](#) and define the source of the funds and the customer's account or credit card number.

What Are Automatic Payments?

An automatic payment is just like any other payment (refer to [A Payment Event Has Payments And Tenders](#) for more information about payments in general). However, automatic payments have one special trait - they cause funds to be transferred into your company's bank account. Refer to [Downloading Automatic Payments and Interfacing Them To The GL](#) for how this transference happens.

How And When Are Automatic Payments Created?

Automatic payments can be created in several ways:

- The system creates automatic payments for bills linked to accounts with an active auto pay option (note, the system uses the [account's autopay option](#) that's effective on the bill's due date). When the system does this is dependent on the value of the **Autopay Creation Option** on the [installation record](#):
 - If you've set this option to Create At Bill Completion, the automatic payment is created when the account's bill is completed. The payment is distributed and frozen at the same time. This means that the account's balance is almost always zero (or in credit if they have a deposit). You will see the automatic payments in the payment list immediately after the bill is completed (rather than waiting until the automatic payment's extraction date).
 - If you've set this option to Create On Extract Date, the automatic payment is NOT created when the bill is completed. Rather,
- At bill completion time, the bill is stamped with the automatic payment's extract date and amount. The date is the automatic payment source's extraction date (refer to [Automatic Payment Dates](#) for more information on how this date is calculated).
- The automatic payment background process ([APAYCRET](#)) creates the automatic payment on the extract date stamped on the bill. If the supplied Auto Pay Creation algorithm (APAY-CREATE) is used and is configured to override the automatic payment amount based on the account's current balance, the algorithm can either adjust the auto pay amount (if the balance is less than the original auto pay amount) or skip automatic payment creation (if the balance is zero or a credit). Refer to the algorithm type description for more details.
- The automatic payment is NOT distributed and frozen when the automatic payment is initially created. A separate background process ([APAYDSFR](#)) distributes and freezes the automatic payment on the automatic payment GL

distribution date (refer to [Automatic Payment Dates](#) for more information on how this date is calculated). This means that the customer's balance increases when the bill is completed and is only reduced when the automatic payment is marked for interface to the general ledger.

Note that it is possible for automatic payments to be distributed and frozen after being extracted and interfaced to a financial institution. Please refer to [Downloading Automatic Payments and Interfacing Them To The GL](#) and [The Nightly Processes](#).

An algorithm plugged in on the [Installation Record](#) calculates the payment amount whether the automatic payment is created at bill completion time or on the extract date. Please refer to APAM-DFLT for more information about how the algorithm that is supplied with the base package calculates this amount.

NOTE:

With balance forward accounting, automatic payments are not just for new charges. The base package algorithm includes prior balances when it creates a customer's first automatic payment. For example, if a customer has an existing balance of \$100 and then signs up for automatic payment, their next bill will cause an automatic payment of \$100 plus any new charges to be created (assuming the \$100 remains unpaid at the time the next bill is completed). Refer to [Open Item Versus Balance Forward Accounting](#) for information about balance forward accounting.

-
- If a customer with a pay plan indicates that the payment method is via "autopay", a background process ([PPAPAY](#)) creates an automatic payment on the scheduled payment dates. Please note, if the **Autopay Creation Option** on the [installation record](#) is set to Create On Extract Date, the automatic payment is NOT distributed and frozen when the automatic payment is initially created. Rather, a separate background process ([APAYDSFR](#)) distributes and freezes the automatic payment on the automatic payment GL distribution date (refer to [Automatic Payment Dates](#) for more information on how this date is calculated). Refer to [The Big Picture Of Pay Plans](#) for more information about pay plans.
 - If a customer with an account that is set up for automatic payment has a Non-Billed Budget that is not excluded from automatic payment, a background process ([NBBAPAY](#)) creates an automatic payment on the scheduled payment dates. Please note, if the **Autopay Creation Option** on the [installation record](#) is set to Create On Extract Date, the automatic payment is NOT distributed and frozen when the automatic payment is initially created. Rather, a separate background process ([APAYDSFR](#)) distributes and freezes the automatic payment on the automatic payment GL distribution date (refer to [Automatic Payment Dates](#) for more information on how this date is calculated). Refer to [What is a Non-Billed Budget](#) for more information about Non-Billed Budgets.
 - A user can create an automatic payment by simply adding a payment tender with a tender type that indicates it is for automatic payment purposes. This would be a rather unusual thing to do, but you might do this if you want to immediately debit a customer's bank account after a large adjustment is added to the system (e.g., if they suddenly owe you a lot of money and you don't want to wait until the next bill to collect it). Automatic payments created by this method must be distributed and frozen before they can be extracted.
 - When a checking or savings account is used for the first-time on a self-service automatic payment enrollment, self-service one time payment or self-service payment option management, a payment event, payment tender and auto pay staging records are created for prenotification purposes. Refer to [Web Debit Account Validation](#) for more details.

NOTE:

An algorithm is used to create automatic payments. The logic used to create automatic payments is plugged in on the [Installation Record](#). This algorithm is **not** called when a user manually creates an automatic payment (by adding a payment tender with a tender type that indicates that it is for automatic payment purposes) and when the automatic payment is for prenotification purposes.

When an automatic payment is first created, it gets marked with a distribution date. The distribution date is the date on which the automatic payment's FT's GL details can be interfaced to the general ledger (via the standard GL interface). The distribution date is determined as follows:

- Every automatic payment references an auto-pay source.
- Every auto-pay source references an auto-pay route type.

- Every auto-pay route type contains an algorithm that is responsible for calculating the GL Distribution (Posting) date. On the GL distribution date, the automatic payment will be interfaced to the general ledger.

Automatic Payment Dates

As described in the previous section, an algorithm (that's plugged in on [Auto Pay Route Types](#)) controls the date on which the automatic payment is interfaced to your general ledger. We refer to this date as the GL distribution date.

This algorithm also populates the following dates:

- The payment date that is stored on the payment.
- The date on which the automatic payment is interfaced to the financial institution.

The algorithm that is supplied with the base package provides many parameters that allow you to dictate how these dates are calculated. Please refer to APAY-DTCALC for the details.

How To Implement Maximum Withdrawal Limits

In some locales, customers can define a "maximum withdrawal amount" to limit the amount of money that is automatically debited from their bank account. For example, a low-income customer may want to prevent direct debits of more than \$50 from being applied to their checking account.

You define a customer's maximum withdrawal amount when you setup their automatic payment information on [Account - Auto Pay](#).

The following points describe how the system implements maximum withdrawal limits:

- When a bill is completed for a customer who pays automatically the system calls the automatic payment creation algorithm that's plugged in on the [Installation Record](#). The base-package autopay creation algorithm (APAY-CREATE) checks if the amount of the automatic payment exceeds the customer's maximum withdrawal amount. If so, the autopay creation algorithm calls the automatic payment over limit algorithm that's plugged in on the account's [customer class](#). Algorithms of this type have the ability to reduce the amount of the autopay or to prevent the autopay from being created. Refer to APOL-RA for an example plug-in.
- When a user manually creates an automatic payment (by adding a tender with a tender type that indicates that it is for automatic payment purposes), the system issues a warning message when the tender amount exceeds the account's maximum withdrawal amount.

NOTE:

Pay plans and Non-Billed Budgets. Automatic payments that are created as a result of pay plans and Non-Billed Budgets are not subject to maximum withdrawal limits. This is because both of these options required customer approval and therefore the customer should be able to plan accordingly. Refer to [How And When Are Automatic Payments Created](#) for more information.

How Are Automatic Payments Cancelled?

There are two ways to cancel an automatic payment:

- The system will cancel an automatic payment behind-the-scenes if the related bill (if any) is reopened BEFORE the automatic payment is interfaced to the financial institution. When you recomplete the bill, the system will create a new automatic payment that reflects the new amount due (and the canceled automatic payment will net out the original automatic payment).

- An operator can cancel an automatic payment (refer to [How To Cancel A Tender](#)) at any time. You would do this if the automatic payment was rejected by the financial institution.

FASTPATH:

Refer to [Credit / Correction Notes and Auto Pay](#) for information about how a credit note may cancel an automatic payment.

Match Events Are Created For Open-Item Customers When An Automatic Payment Is Created

The system creates a match event when a bill is completed for open-item customers that pay automatically (i.e., direct debit customers). The match event groups together the bill's new charges against the automatic payment's payment segments.

If the bill is subsequently re-opened, the match event will be cancelled when the automatic payment is cancelled.

FASTPATH:

Refer to [Open Item Accounting](#) for more information.

Pay Plans and Automatic Payments

If a customer wants to pay their pay plan scheduled payments automatically, the account must be set up for automatic payment (as described under [How To Set Up A Customer To Pay Automatically](#)). In addition, the payment method defined on the pay plan must indicate automatic payment is being used.

When this is done, a background process (PPAPAY) creates automatic payments on the scheduled payment date by calling the automatic payment creation algorithm plugged in on the installation record.

Non-Billed Budgets and Automatic Payment

If a customer wants to pay their Non-Billed Budget scheduled payments automatically, the account must be set up for automatic payment (as described under [How To Set Up A Customer To Pay Automatically](#)). In addition, the Non-Billed Budget must indicate that automatic payment is being used.

When this is done, a background process (NBBAPAY) creates automatic payments on the scheduled payment date by calling the automatic payment creation algorithm plugged in on the installation record.

Downloading Automatic Payments and Interfacing Them To The GL

The following diagram illustrates the background processes that interface automatic payment out of the system:

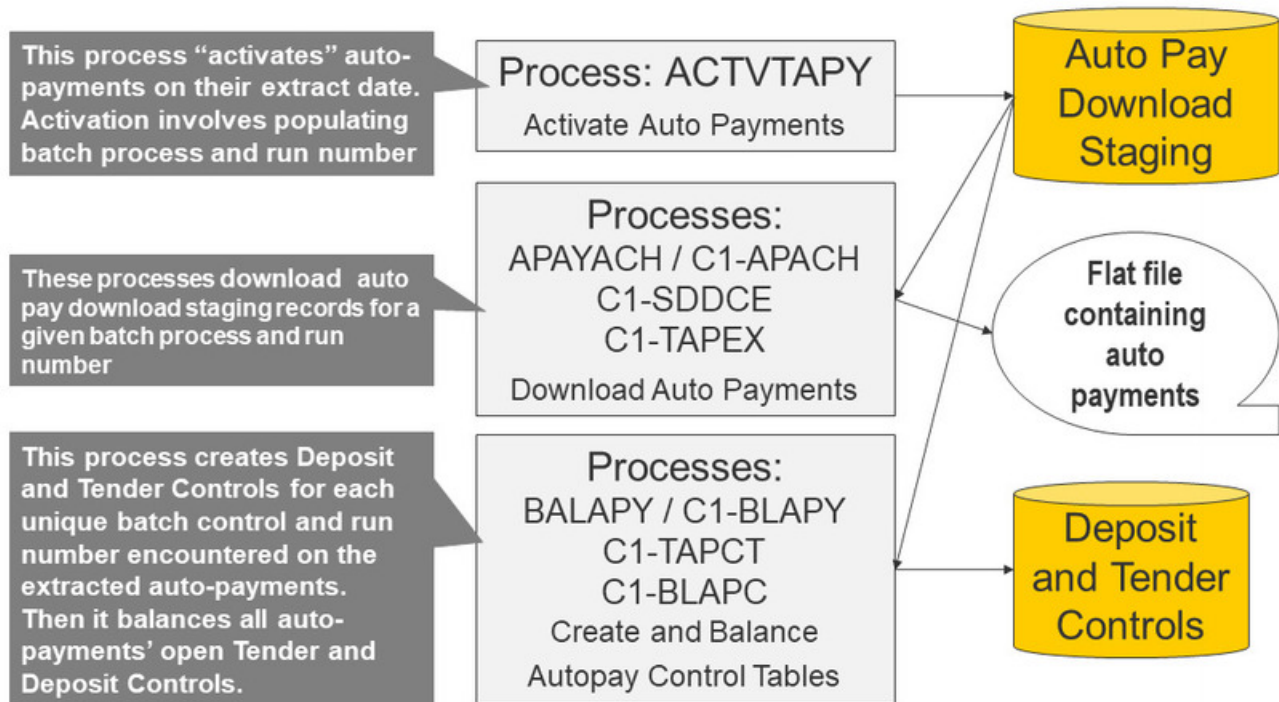

These processes are described in the following topics.

ACTVTAPY - Activating Automatic Payments

When an automatic payment is first created, it gets marked with an extract date. The extract date is the date the automatic payment will be downloaded to the respective financial institution. The extract date is determined as follows:

- Every automatic payment references an auto-pay source.
- Every auto-pay source references an auto-pay route type.
- Every auto-pay route type contains an algorithm that calculates this date.

On the extract date, the automatic payment is "activated". The automatic payment is activated is marked for download the next time its download process runs. An automatic payment's download process is defined on its auto-pay source's route type.

APAYACH - Download Automatic Payments To The ACH (Automated Clearing House)

This process reads all auto pay download staging records marked with a given batch control ID and run number, and creates the flat file that's passed to the ACH. Refer to [ACH Record Layouts](#) for the details of the record layouts.

The following outlines the differences between APAYACH and C1-APACH:

- APAYACH uses the Business Process Date as the draft date. C1-APACH populates the Effective Entry Date field on the Company Batch Header Record with a date (the actual draft date) as to when the payment should be withdrawn from the customer's account.

- APAYACH produces a file that has one File Header Record, a Company Batch Header Record per payment source (if multiple payment sources exist), and multiple detail lines. C1-APACH produces a file with multiple occurrences of the Company Batch Header Record differing on the Effective Entry Date field and the payment source (if multiple payment sources exist).

NOTE:

This process may be rerun. You can reproduce the flat file at any time. Simply request this job and specify the run number associated with the historic run.

If you require a different flat file format, you must create additional versions of this program. Refer to [Setting Up Automatic Payment Extracts](#) for instructions describing how to add another process.

C1-APACH - Download Automatic Payments To The ACH (Automated Clearing House)

This process is an alternative to using APAYACH. Similar to APAYACH, this process reads all auto pay download staging records marked with a given batch control ID and run number, and creates the flat file that's passed to the ACH. Refer to [ACH Record Layouts](#) for the details of the record layouts.

The following outlines the differences between APAYACH and C1-APACH:

- C1-APACH populates the Effective Entry Date field on the Company Batch Header Record with a date (the actual draft date) as to when the payment should be withdrawn from the customer's account. APAYACH uses the Business Process Date as the draft date.
- C1-APACH produces a file with multiple occurrences of the Company Batch Header Record differing on the Effective Entry Date field and payment source (if multiples payment sources exist). APAYACH produces a file that has one File Header Record, a Company Batch Header Record per payment source (if multiple payment sources exist), and multiple detail lines.

NOTE:

This process may be rerun. You can reproduce the flat file at any time. Request this job and specify the run number associated with the historic run.

If you require a different flat file format, you must create additional versions of this program. Refer to [Setting Up Automatic Payment Extracts](#) for instructions describing how to add another process.

C1-SDDCE - SEPA Direct Debit Payment Extract

This process reads all auto pay download staging records marked with a given batch control ID and run number to create an XML extract file that's passed to the financial institution. Refer to [SEPA Direct Debit Record Layouts](#) for the details of the record layouts.

NOTE:

This process may be rerun. You can reproduce the XML extract at any time. Simply request this job and specify the run number associated with the historic run.

C1-TAPEX - Third Party Auto Pay Extract

This process reads all auto pay download staging records marked with a given batch control ID and run number to create an extract file that is sent to the third party payment processing system.

This is a plugin-driven batch process that supports any of three file layouts (comma-separated values (CSV), fixed position and XML) specified in an input batch parameter.

The C1-TAPEX batch control is delivered with two algorithms plugged in:

- A Select Records algorithm is responsible for selecting the auto pay staging records to download.
- A Process Record algorithm is responsible for formatting and writing each extract record into the output flat file.

Your implementation can plug in your own Select Records and Process Record algorithms if your business rules for this extract differ.

This batch process is meant to be run after the Activate auto-pay (ACTVTAPY) runs and before Third Party Auto Pay Tender Controls (C1-TAPCT) runs.

Refer to [Third Party Auto Pay Record Layouts](#) for the details of the record layouts.

NOTE:

This process may be rerun. You can reproduce the XML extract at any time. Simply request this job and specify the run number associated with the historic run.

BALAPY - Creating Automatic Payment Tender Controls

This process creates a new tender control (with an associated deposit control) for each unique batch control ID and run number encountered in the extracted automatic payments (where its payment tender is not yet linked to a tender control). The payment tender of each of these automatic payments is then linked to the corresponding tender control. This process also balances the open tender control records afterwards.

NOTE: A separate batch process ([C1-BLAPC](#)) must be scheduled after BALAPY to balance open tender and deposit control records.

C1-BLAPY - Create Autopay Tender Controls

This process creates a new tender control (with an associated deposit control) for each unique batch control ID and run number encountered in the extracted automatic payments (where its payment tender is not yet linked to a tender control).

This is a plugin driven version of BALAPY. The difference is that it excludes payments that were processed by a third party payment processing system. These are handled by other tender controls processes - C1-TAPCT (for third party auto pays) and C1-TOPCT (for third party one time payments)

The C1-BLAPY batch control is delivered with two algorithms plugged in:

- A Select Records algorithm is responsible for determining the auto pay staging records to process.
- A Process Record algorithm is responsible for linking the auto pay record's payment tender to the tender control.

Your implementation can plug in your own Select Records and Process Record algorithms if your business rules for this extract differ.

NOTE: A separate batch process ([C1-BLAPC](#)) must be scheduled after C1-BLAPY to balance open tender and deposit control records.

C1-BLAPC - Balance Autopay Control Tables

This batch process is responsible for balancing tender and deposit control tables in the autopay extract process. This batch process is executed after [BALAPY](#) completes.

ACH Record Layouts

The topics in this section describe the layout of the records created by [APAYACH - Download Automatic Payments To The ACH \(automated clearing house\)](#) and [C1-APACH - Download Automatic Payments To The ACH \(automated clearing house\)](#).

NOTE:

APAYACH and C1-APACH share most of the same fields. The exceptions are documented in the following tables.

File Header Record

The ACH extract flat file must have one record of this type and it must be the first logical record on file.

Field Name	Format	Source/Value/Description
RECORD-TYPE	A1	"1"
PRIORITY-CD	A2	"01"
RESERVED-01	A1	Spaces
IMMEDIATE-DESTINATION	A9	The auto pay route type's tender source's bank account's DFI ID. Note. Tender source may be overridden on CIS Division
COMPANY-ID	A10	Auto Pay Route Type / Company Id Note. May be overridden on CIS Division
FILE-CRE-DT	A6	YYMMDD. Current date
FILE-CRE-TM	A4	HHMM. Current time
FILE-ID-MODIFIER	A1	"A"
RECORD-SIZE-CONST	N3	"094" The "FILLER" at the end of all but the Entry Detail Record serves to bring the total length of each record up to this constant.
BLOCKING-FACTOR	N2	"10"
FORMAT-CD	A1	"1"
DEST-FIN-INST-NAME	A23	The auto pay route type's tender source's bank description. Note. Tender source may be overridden on CIS Division
COMPANY-NAME (ORIG-FIN-INST-NAME)	A23	Auto Pay Route Type / Company Name Note. May be overridden on CIS Division
REFERENCE-CD	A8	Spaces

Company Batch Header Record

The ACH extract flat file can contain multiple company batch headers - one header per payment source as distinguished by STD-ENTRY-CLASS. This record must be the second logical record on file.

Field Name	Format	Source/Value/Description
RECORD-TYPE	A1	"5"
SERVICE-CLASS-CD	A3	"200"
COMPANY-NAME	A16	Auto Pay Route Type / Company Name Note. May be overridden on CIS Division
COMPANY-DISCRETIONARY	A20	Spaces
COMPANY-ID	A10	Auto Pay Route Type / Company Id Note. May be overridden on CIS Division
STD-ENTRY-CLASS	A3	"PPD", unless the payment is a one-time payment. For one-time payments, the STD-ENTRY-CLASS can be populated using a One Time Payment Source characteristic on the associated tender. Base logic for self-service one-time payment processing adds a One Time Payment Source characteristic with a value of 'WEB' to the tender. Your implementation may define other characteristic values for any of your additional payment sources/triggers. Refer to the help for the One Time Payment Sources section of the Self-Service Integration Master Configuration for more details.
CO-ENTRY-DESCR	A10	For standard Auto Pay Route Type: Company Entity Description Note. May be overridden on CIS Division
COMPANY-DESCR-DT	A6	Business process date
EFF-ENTRY-DT	A6	For APAYACH, the EFF-ENTRY-DT is the business process date. For C1-APACH, the EFF-ENTRY-DT is calculated from the ACH staging / Scheduled Extract Date + Number of Days batch parameter if specified greater than 0. A company batch is created for each value.
RESERVED-01	A3	Spaces
ORIGINATOR-STAT-CD	A1	"1"
ORIGIN-DFI-ID	A8	The auto pay route type's tender source's bank account's DFI ID. Note. Tender source may be overridden on CIS Division

Entry Detail Record

The ACH extract flat file must have one record of this type for every direct debit record.

Field Name	Format	Source/Value/Description
RECORD-TYPE	A1	"6"
TRANSACTION-CD	A2	Pay Tender's Tender Type / External Type Flag
TRANSIT-RTG-NBR	A9	Auto pay source / External Source Id
DFI-ACCT-NBR	A17	Auto pay staging / External Account Id
AMOUNT	N8.2	Pay Tender / Tender Amount
INDIVIDUAL-ID	A15	Pay Tender / Payor Account Id
INDIVIDUAL-NAME	A22	Auto pay staging / Entity Name
DISCRETIONARY-DATA	A2	Spaces
ADDENDA-REC-IND	A1	"0"
DFI-ID	A8	The auto pay route type's tender source's bank account's DFI ID. Note. Tender source may be overridden on CIS Division
ENTRY-DETAIL-CNT	N7	Ascending counter starting at 1 and incremented by 1 for each entry detail record

NOTE:

External Account ID. The EXT_ACCT_ID field supports up to 50 characters. If the value entered in the field is longer than that supported by the record layout (17 characters), the value will be truncated.

Company Batch Control Record

The ACH extract flat file must have one record of this type and it must follow the Entry Detail records.

Field Name	Format	Source/Value/Description
RECORD-TYPE	A1	"8"
SERVICE-CLASS-CD	A3	"200"
ENTRY-ADDENDA-CNT	N6	The total number of entry detail records in this batch.
ENTRY-HASH	N10	The product of the first 8 digits of the external source id of the autopay source, multiplied by the number of entry detail records in the batch.

TOTAL-DR-DOLLAR-AMT	N10.2	Total tender amounts of the entry detail records.
TOTAL-CR-DOLLAR-AMT	N10.2	Zero.
COMPANY-ID	A10	Auto Pay Route Type / Company Id Note. May be overridden on CIS Division
RESERVED-01	A19	Spaces
RESERVED-02	A6	Spaces
ORIGIN-DFI-ID	A8	The auto pay route type's tender source's bank account's DFI ID. Note. Tender source may be overridden on CIS Division
BATCH-NBR	N7	The batch number of this batch within the file.

File Control Record

The ACH extract flat file must have one record of this type and it must be the last logical record on file.

Field Name	Format	Source/Value/Description
RECORD-TYPE	A1	"g"
BATCH-CNT	N6	The number of batches in this file.
BLOCK-CNT	N6	Calculation of the total number of records in the file / 10.0 + 0.9
ENTRY-ADDENDA-CNT	N8	The total number of entry detail records in this file.
ENTRY-HASH	N10	The sum of the entry hash values on all the batch control records in this file.
TOTAL-DR-DOLLAR-AMT	N10.2	Sum of the total debit entry dollar amounts of all the batches in this file.
TOTAL-CR-DOLLAR-AMT	N10.2	Sum of the total credit entry dollar amounts of all the batches in this file.
RESERVED-01	A39	Spaces

SEPA Direct Debit Record Layouts

Group Header

A SEPA XML file must include a group header. The XML path for the group header is **CstmrDrctDbtInittn/GrpHdr** and the elements under the group header are as follows:

Description	Element Name	Source/Value
Message Identification	MsgId	Retrieved from the direct debit task type

Creation Date/Time	CreDtTm	Batch business date in the format YYYY-MM-DDThh:mm:ss
Number of Transactions	NbOfTx	Calculated at extract time
Initiating Party Name	InitgPty/Nm	Retrieved from the direct debit task type

Payment Information

Payment Information contains elements related to the credit side of the transaction, such as creditor and payment type. The XML path for payment information is **CstmrDrctDbtInitt/PmtInf** and the elements are as follows:

Description	Element Name	Source/Value
Payment Information Identification	PmtInfId	Constructed at extract time by concatenating the following: Batch Code, Batch Run Number, Batch Business Date and a Sequence Number assigned to each Payment
Payment Method	PmtTpInf/PmtMtd	Defaulted to DD (Direct Debit)
Service Level Code	SvcLvl/Cd	Retrieved from the direct debit task type; defaulted to 'SEPA'
Local Instrument Code	PmtTpInf/LclInstrm/Cd	Retrieved from the direct debit task type; defaulted to 'CORE'
Sequence Type	PmtTpInf/SeqTp	Direct debit mandate task's Payment Type
Requested Collection Date	ReqdColltnDt	Payment event's pay date
Creditor Name	Cdtr/Nm	Direct debit mandate task's Creditor Name
Creditor Account Identification IBAN	CdtrAcct/Id/IBAN	CI_BANK_ACCOUNT.ACCOUNT_NBR
Creditor Agent Financial Institution Identification BIC	CdtrAgt/FinInstnId/BIC	CI_BANK_ACCOUNT.DFI_ID_NUM
Creditor Account Number	CdtrSchmeld/Id/PrvtId/Othr/Id	Direct debit task type's Creditor Identification
Creditor Party	CdtrSchmeld/Id/PrvtId/Othr/SchmeNm/Prtry	Defaulted to 'SEPA'

Direct Debit Transaction Information

Direct Debit Transaction Information contains elements related to the debit side of the transaction, such as debtor and remittance information rules. The XML path for direct debit transaction information is **CstmrDrctDbtInitt/PmtInf/DrctDbtTxInf** and the elements are as follows:

Description	Element Name	Source/Value
Payment End to End Identification	PmtId/EndToEndId	CI_PAY_TNDR.PAY_TENDER_ID
Payment Instructed Amount	InstdAmt	CI_PAY_TNDR.TENDER_AMT
Mandate Related Information – Mandate Identification	DrctDbtTx/MndtRltdInf/MndtId	Direct debit mandate task's External Mandate Reference
Mandate Related Information – Date of Signature	MndtRltdInf/DtOfSgntr	Direct debit mandate task's Effective Date
Mandate Related Information – Electronic Signature	MndtRltdInf/ElectrcSgntr	Direct debit mandate task's Signature

Debtor Agent Financial Institution Identification BIC	DbtrAgt/FinInstnId/BIC	CI_APAY_SRC.EXT_SOURCE_ID
Debtor Name	Dbtr/Nm	CI_APAY_CLR_STG.ENTITY_NAME
Debtor Account Identification IBAN	DbtrAcct/Id/IBAN	CI_APAY_CLR_STG.EXT_ACCT_ID

Third Party Auto Pay Record Layouts

The Third Party Auto Pay Extract file is a comma-separated (CSV) format file that contains one or more automatic payment detail records and a footer record.

Automatic Payment Detail Record

There must be at least one record of this type in the file.

Field Name	Format	Source/Value/Description
Account ID	A10	Account Auto Pay Option / Account ID
Auto Pay Amount	N13.2	Pay Tender linked to the Auto Pay Clearing Staging / Tender Amount
Due Date	A10	Due Date of the Bill ID that is linked to the Auto Pay Clearing Staging
Maximum Withdrawal Amount	N13.2	Account Auto Pay Option of the related Account ID / Maximum Withdrawal amount field
Auto Pay Staging ID	A12	Auto Pay Clearing Staging / Auto Pay Staging ID

Summary/Footer Record

There must be one record of this type at the end of the file.

Field Name	Format	Source/Value/Description
Total Number of Records	N13.2	Total number of auto pay detail records in the file
Total Amount	N13.2	Sum of auto pay amounts in the file

Payment Information

The Third Party Auto Pay Extract file must have one record of this type for every direct debit record. The **C1-TAPEX-PR** Process Record algorithm uses the **C1-ThirdPartyAutoPayExtractRec** data area, which contains the following:

Description	Element Name	Source/Value
Payor Account ID	payorAccountId	Payor account ID on the auto pay tender
Auto Pay Amount	autopayAmount	Tender amount on the auto pay tender
Due Date	billDueDate	Due date of the Bill ID linked to the auto pay
Maximum Withdrawal Amount	autopayMaxWithdrawalAmount	From the account's auto pay option

Footer Information

The Third Party Auto Pay Extract file must have one and only one record of this type. The **C1-TAPEX-PR** Process Record algorithm uses the **C1-ThirdPartyBatchRunVariables** data area, which contains the following:

Description	Element Name	Source/Value
Record Count	recordCount	Total number of payments in the file
Total Amount	totalAmount	Total amount of payments in the file

Third Party Payment Processing

A third party payment processing system is a service provider that can handle all aspects of electronic payments for a utility. When this service provider is integrated with *Oracle Utilities Customer To Meter*, every payment made through channels such as web self-service or integrated voice response (IVR) is accepted and processed within the service provider's fully hosted payment acceptance environment. Payment data (credit card number, bank account number, etc) is stored and processed outside of the utility's network.

The following sections describe the functions that are supported when this product is integrated with a third party payment processing system.

One Time Payments

A one time payment is a one-off, non-recurring payment option where the third party payment processing is authorized to collect a payment from a utility customer's credit card or bank account.

One time payments can be immediate or scheduled:

- Immediate one-time payments are processed on the same date that the payment is created/captured in the third party payment processing system.
- Scheduled one-time payments are processed at a future date that the customer designates.

The base product provides an inbound web service **C1-ThirdPartyOneTimePayNotification** that receives one time payment information from the third party payment processor, and, based on the required action, creates/updates the payment in the system. This web service supports the following functions:

- Creating an immediate or scheduled one time payment.
- Updating a scheduled one time payment
- Processing a scheduled one time payment
- Canceling a processed one time payment

The following sections describe these actions.

Creating One Time Payments

When the third party payment processing system processes a new one time payment, it will call the **C1-ThirdPartyOneTimePayNotification** inbound web service with an Add action. The payment details include the payment date/time, payment amount and basic details about the payment method (*i.e.*, bank account or credit card).

NOTE: Because bank account numbers and credit card numbers are captured outside of the system, the full account numbers are not sent. In most cases, only a partial value is sent, e.g. last four digits.

The inbound web service processes the payment as follows:

- If the Payment Date is the current date, it is processed as an immediate payment.
 - The system creates a Third Party One Time Payment Task, which in turn creates a frozen payment.
 - The payment date/time sent in by the third party payment processor is stored as a characteristic on the payment tender using the Processing Date/Time Characteristic Type in the Third Party One Time Payment Processing Integration master configuration. This is to capture the actual date/time when the payment was processed. This information is used in tender control processing.

NOTE: The payment date/time is validated for XSD format. Any subsequent manual updates to this date/time will need to be in the correct XSD format. An adhoc characteristic validation algorithm type C1-VALDATE exists for this purpose.

- A reference to the Third Party One Time Payment Task's Service Task ID is stored as a characteristic on the payment tender using the Processing Reference Characteristic Type in the Third Party One Time Payment Processing Integration master configuration. This helps identify that the payment event/tender was created from third party payment processing.
- The Payment Event ID is sent back to the third party payment processing system so that it has a way to identify the payment should there be a need to cancel the payment in the future.
- If the Payment Date is a future date, it is processed as a scheduled payment.
 - The system creates a pending Third Party One Time Payment Task. No further action is taken until the third party payment processing system sends another notification that the scheduled payment has been processed.
 - The Service Task ID is sent back to the third party payment processing system so that it has a way to identify the service task on subsequent requests to either update or process the pending one time payment.

NOTE: To prevent the creation of duplicate payments when the web service times out and the third party payment processing retries the web service call:

- The system checks if a frozen payment was already created from a previous web service call.
 - The account is locked during payment event creation.
-

For more information about the lifecycle of the Third Party One Time Payment Notification service task, refer to the **C1-ThirdPartyOneTimePayTask** business object in the system.

For more information about master configuration settings, refer to the **Third Party Payment Processing Integration** master configuration in the system.

Updating Scheduled One Time Payments

If the third party payment processing system receives a request from the customer to update an existing one time payment, it will call the **C1-ThirdPartyOneTimePayNotification** inbound web service with an **Update** action, passing in the pending one time payment's Service Task ID and the updated payment details.

NOTE: Because bank account numbers and credit card numbers are captured outside of the system, the full account numbers are not sent. In most cases, only a partial value is sent, e.g. last four digits..

The inbound web service updates the existing Third Party One Time Payment Task with the new payment details sent in. The Third Party One Time Payment Task remains in the Pending state.

For more information about the lifecycle of the Third Party One Time Payment Notification service task, refer to the **C1-ThirdPartyOneTimePayTask** business object in the system.

Processing Scheduled One Time Payments

When it is time to process a scheduled one time payment, the third party payment processing will process the payment as it does an immediate one time payment. However, in this case, it will call the **C1-ThirdPartyOneTimePayNotification** inbound web service with a **Process** action, passing in the pending one time payment's Service Task ID and the payment details.

NOTE: Because bank account numbers and credit card numbers are captured outside of the system, the full account numbers are not sent. In most cases, only a partial value is sent, e.g. last four digits.

The inbound web service processes the one time payment as follows:

- The system transitions the existing Third Party One Time Payment Task so that it proceeds to create a frozen payment event.
- The payment date/time sent in by the third party payment processor is stored as a characteristic on the payment tender using the Processing Date/Time Characteristic Type in the Third Party One Time Payment Processing Integration master configuration. This is to capture the actual date/time when the payment was processed. This information is used in tender control processing.
- A reference to the Third Party One Time Payment Task's Service Task ID is stored as a characteristic on the payment tender using the Processing Reference Characteristic Type in the Third Party One Time Payment Processing Integration master configuration. This helps identify that the payment event/tender was created from third party payment processing.
- The Payment Event ID is sent back to the third party payment processing system so that it has a way to identify the payment should there be a need to cancel the payment in the future.

NOTE: To prevent the creation of duplicate payments when the web service times out and the third party payment processing retries the web service call:

- The system checks if a frozen payment was already created from a previous web service call.
 - The account is locked during payment event creation.
-

For more information about the lifecycle of the Third Party One Time Payment Notification service task, refer to the **C1-ThirdPartyOneTimePayTask** business object in the system.

For more information about master configuration settings, refer to the **Third Party Payment Processing Integration** master configuration in the system.

Canceling One Time Payments

Scheduled or processed one time payments could get canceled for specific reasons. For instance, a processed payment could get canceled if a customer disputed a credit card charge or if the bank account has insufficient funds. When there is a need to cancel an existing scheduled or processed one time payment, the third party payment processor will cancel the one time payment in their system and call the **C1-ThirdPartyOneTimePayNotification** inbound web service with a **Cancel** action, passing in either a pending one time payment's Service Task ID (if canceling a scheduled payment) or a processed one time payment's Payment Event ID (if canceling a processed payment).

The inbound web service processes the one time payment cancellation as follows:

- For a scheduled on time payment, the existing Third Party One Time Payment Task is simply transitioned to the Discarded state.
- For a processed payment, the cancellation is processed as follows:

- Since the original Third Party One Time Payment Task is already in the Completed state, a new Third Party One Time Payment Task is created to process the cancellation. Logic on the Process Payment state will cancel the existing Payment Tender using the Payment Event ID that is passed in from the web service.
- The Tender Cancel Reason is taken from the **Third Party Payment Processing Integration** master configuration.
- A reference to the cancellation Service Task ID is stored as a characteristic on the payment tender using the Cancellation Reference Characteristic Type that is defined in master configuration.
- If master configuration is also set up with a Payment Auto-Cancel To Do Type, a To Do Entry is created.

For more information about the lifecycle of the Third Party One Time Payment Notification service task, refer to the **C1-ThirdPartyOneTimePayTask** business object in the system.

For more information about master configuration settings, refer to the **Third Party Payment Processing Integration** master configuration in the system.

Account Verification

A third party payment processing system can perform account verification prior to processing one time payments and automatic payment enrollments. This is to verify that the account exists, as well as to get specific information about the account such as the account balance, due date, past due amount, and existing auto pay information.

The base product provides an inbound web service **C1-ThirdPartyVerifyAccount** that receives an Account ID from the third party payment processor and creates a Third Party Account Verification Task that is responsible for verifying the account. Base-supplied logic on this service task checks that the account exists and returns the account's balance, due date, past due amount (if any) and existing auto pay information (if any). Refer to the **C1-ThirdPartyAcctVerifTask** business object for more details.

Automatic Payment Setup

When the system is integrated with a third party payment processing system, customers who opt for automatic bill payment enrol through the third party payment processing system, where payment information that includes credit card or bank account number are captured and stored.

The third party payment processing system sends a notification when it processes new or updated account auto pay information.

The base product provides an inbound web service **C1-ThirdPartyAutoPaySetup** that receives auto pay setup information and creates a Third Party Auto Pay Setup Task, which is responsible for creating or updating the account's auto pay information. Base-supplied logic on this service task adds an account auto pay option, updates an existing account auto pay option's details or cancels an existing account auto pay option by setting its end date to the designated date. Refer to the **C1-ThirdPartyAutoPayTask** business object for more details.

Interfacing Automatic Payments To A Third Party

For customers who are enrolled to automatically pay bills through a third party payment processing system, existing auto pay processing that occurs during bill completion applies. Refer to [How And When Are Automatic Payments Created?](#) for more details.

The difference with automatic payment processing via third party payment processing system is that the auto pay staging records are not sent directly to the financial institution. Since the routing is different, a third party payment processing system is associated with a distinct Auto Pay Source and Auto Pay Route Type. Refer to [Define Auto Pay Sources and Auto Pay Route Types](#) for more details on this configuration.

Third party automatic payment transactions are extracted using the Third Party Auto Pay Extract (C1-TAPEX) batch process. Refer to [Downloading Automatic Payments and Interfacing Them To The GL](#) for details on how this batch process fits into the auto pay batch process flows.

Highlighting Scheduled Payments

The Scheduled Payments Log zone in Control Central - Account Information displays the following:

- Pending third party one time payments
- Pending self-service one time payments
- Pending bill-related automatic payment records
- One time payments in error that have not been resolved, i.e. not succeeded by a Pending or Completed one time payment

Refer to the zone help for more information.

Automatic Payment Confirmations And Cancellations

A third party payment processing system can notify the system about whether or not the auto pay transactions sent to it for processing were processed successfully.

The base product provides two batch processes, one each for auto pay confirmation and auto pay cancellation. Refer to the following sections for more details.

C1-TAPDF - Third Party Auto Pay Confirmations

This batch process receives a comma-delimited (CSV) file containing information about auto pay transactions that were successfully processed at the third party payment processing system. Each record contains the following:

- Account ID
- Auto Pay Clearing ID (i.e. PK of the auto pay staging record)
- Payment Date/Time

A Process Record algorithm **C1-TAPDF-PR** is plugged in on this batch control. For each record in the file, it distributes and freezes the payment associated with the auto pay staging record. It also updates the payment event date if it differs from the payment date sent with the confirmation. The payment date/time on the confirmation is stored as a characteristic on the auto pay tender.

C1-TAPCN - Third Party Auto Pay Cancellations

This batch process receives a comma-delimited (CSV) file containing information about auto pay transactions that were not processed successfully at the third party payment processing system. Each record contains the following:

- Account ID
- Auto Pay Clearing ID (i.e. PK of the auto pay staging record)

A Process Record algorithm **C1-TAPCN-PR** is plugged in on this batch control. For each record in the file, it cancels the tender associated with the auto pay staging record, using the Tender Cancel Reason that is defined in the Third Party Payment Processing Integration master configuration.

Third Party Payment Tender Controls Processing

A third party payment processing system handles two types of payments: one time payments and recurring automatic bill payments.

The third party payment processing system sets the daily cutoff time for payment processing. For instance, a third party payment processor could set the default daily processing cutoff time to 8pm Eastern Time. But each implementation can override this processing cutoff time. The third party's processing cutoff time is defined in the Third Party Payment Processing Integration master configuration.

For recurring bill auto pays, the system will create the payment event, payment (non-frozen), tender and auto pay staging record. The Tender Control ID is not assigned until a batch process runs and creates the tender and deposit controls for the extracted auto pay transactions.

For one time payments, the assumption is that tender and deposit control processing will be handled in the same way as the recurring auto pays. The one time payment's tender will not be linked to a tender control at one time payment tender creation time. Instead, the tender control will be created in batch, similar to how recurring auto pay tender controls are created.

The base product provides two batch processes for Third Party Auto Pay Tender Controls (C1-TAPCT) and Third Party One Time Payment Tender Controls (C1-TOPCT). For a third party one time payment, a pre-processing batch process C1-TOPPP takes the place of the usual auto pay extract process. This is because third party one time payment auto pays are used purely for tender controls processing and are not sent out to the third party payment processing.

The following sections describe these batch processes.

C1-TAPCT - Third Party Auto Pay Tender Controls

This process creates a tender control (with an associated deposit control) for each batch control and run number encountered for third party automatic payments that are not yet linked to a tender control.

This is a plugin-driven batch process. The C1-TAPCT batch control is delivered with two algorithms plugged in:

- A Select Records algorithm is responsible for selecting the auto pay staging records to process.
- A Process Record algorithm is responsible for linking each auto pay staging record's payment tender to the corresponding tender control.

Your implementation can plug in your own Select Records and Process Record algorithms if your business rules for this extract differ.

This batch process is meant to be run after the Third Party Auto Pay Extract (C1-TAPEX) runs and before Balance Autopay Control Tables (C1-BLAPC) runs.

C1-TOPPP - Third Party One Time Payment Controls Pre-Processing

This process reads all auto pay download staging records marked with a given batch control ID and run number, to verify that the associated one time payment was processed within the current processing cutoff time. Any one time payments that were processed after the cutoff will be updated with the next batch run number.

This is a plugin-driven batch process.

The C1-TOPPP batch control is delivered with two algorithms plugged in:

- A Select Records algorithm is responsible for selecting the auto pay staging records to retrieve, based on the input batch code and batch run number..
- A Process Record algorithm is responsible for verifying that each auto pay staging record selected was processed within the current cutoff time.

Your implementation can plug in your own Select Records and Process Record algorithms if your business rules for this extract differ.

This batch process is meant to be run after the Activate auto-pay (ACTVTAPY) runs and before Third Party One Time Payment Tender Controls (C1-TOPCT) runs. This batch control should be specified on your configured auto pay route type for third party one time payments.

C1-TOPCT - Third Party One Time Payment Tender Controls

This process creates a tender control (with an associated deposit control) for each batch control and run number encountered for third party one time payments that are not yet linked to a tender control.

This is a plugin-driven batch process. The C1-TOPCT batch control is delivered with two algorithms plugged in:

- A Select Records algorithm is responsible for selecting the auto pay staging records to process.
- A Process Record algorithm is responsible for linking each auto pay staging record's payment tender to the corresponding tender control.

Your implementation can plug in your own Select Records and Process Record algorithms if your business rules differ.

This batch process is meant to be run after the Third Party Auto Pay Extract (C1-TOPPP) runs and before Balance Autopay Control Tables (C1-BLAPC) runs.

Issuing A Payment Advice Instead Of Creating An Automatic Payment

If the system is configured to send the customer a payment advice (instead of initiating an electronic funds transfer) when a bill is completed, the automatic payment records - i.e. payment event, payment, tender and auto pay clearinghouse staging - are not created. Refer to [Payment Advices](#) for more information.

How To Set Up A Customer To Receive Payment Advices

Use [Account - Auto Pay](#) to capture the customer's bank details and indicate an auto pay method of Payment Advice.

Payment Advice Option Is For Bill-Related Automatic Payments Only

Payment advices can be printed for auto pays that result from completed bills.

An auto pay for a pay plan scheduled payment will not be created if the account's effective auto pay option is set to Payment Advice. The Pay Plan Auto Pay (PPAPAY) batch process will log an error in this case.

An auto pay for a Non-Billed Budget scheduled payment will not be created if the account's effective auto pay option is set to Payment Advice. The Non-Billed Budget Pay Plan Auto Pay (NBBAPAY) batch process will log an error in this case.

Manually created automatic payments (i.e. auto pays created via payment event UI) are always processed as direct debit.

Maintaining Payment Events

A payment event is used to record when moneys are remitted and how the moneys are allocated amongst accounts. The topics in this section describe how to maintain payment events.

NOTE:

The system creates most payment events behind-the-scenes. Most payment events are created by the system when it uploads payments and when it creates automatic payments. You should only have to access the payment event transaction if you need to correct a payment event or add a payment event real-time. For information about how the system creates payment events, refer to [The Big Picture of Payments](#).

Payment Lifecycles

The topics in this section describe the lifecycle of the various payment objects.

Payment Event Lifecycle

The following diagram shows the possible lifecycle of a payment event.

WARNING:

This diagram only makes sense in the context of the page used to maintain payment events. Refer to [Payment Event - Main Information](#) for the details.

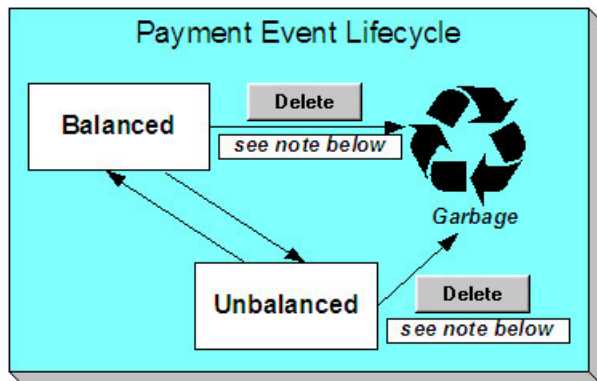

The system, by default, distributes the sum of a payment event's tenders to the account that remits the tenders. After distribution the sum of the tenders equals the sum of the payments (remember, the term *payment* is used to refer to an allocation of some/all of a payment event's tenders to an account's debt) when the event is first created. We refer to such an event as being Balanced.

It is possible via any of the methods described in [Unbalanced Payment Events](#) to make a balanced payment event Unbalanced.

Click **Delete** to physically remove a balanced or unbalanced payment event from the database. You may not delete a payment event if: a) there are frozen or canceled payments linked to the event, or b) if there are canceled tenders linked to the event, or c) if a tender linked to the event is part of a balanced tender control. When the payment event is deleted, the system also deletes its tenders, payments, and payment segments.

Tender Lifecycle

The following diagram shows the possible lifecycle of a payment event.

WARNING:

This diagram only makes sense in the context of the page used to maintain tenders. Refer to [Payment Event - Tenders](#) for the details.

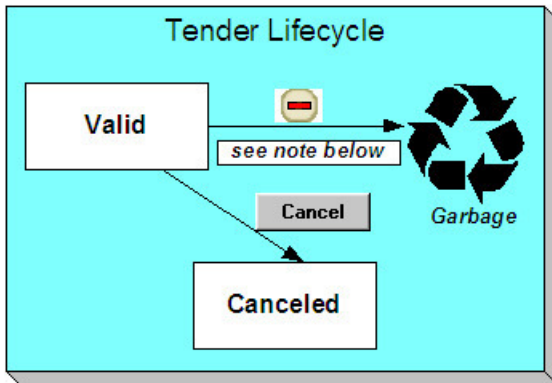

A tender is initially saved in the Valid state. It is possible via any of the methods described in [Unbalanced Payment Events](#) to make a balanced payment event Unbalanced.

If a tender is invalid, click **Cancel** to cancel the tender AND ALL PAYMENTS LINKED TO THE EVENT.

Click the delete button to physically remove a tender from the database. You may not delete a tender if it is part of a balanced tender control.

Payment Lifecycle

The following diagram shows the possible lifecycle of a payment.

WARNING:

This diagram only makes sense in the context of the page used to maintain a payment. Refer to [Payment - Main](#) for the details.

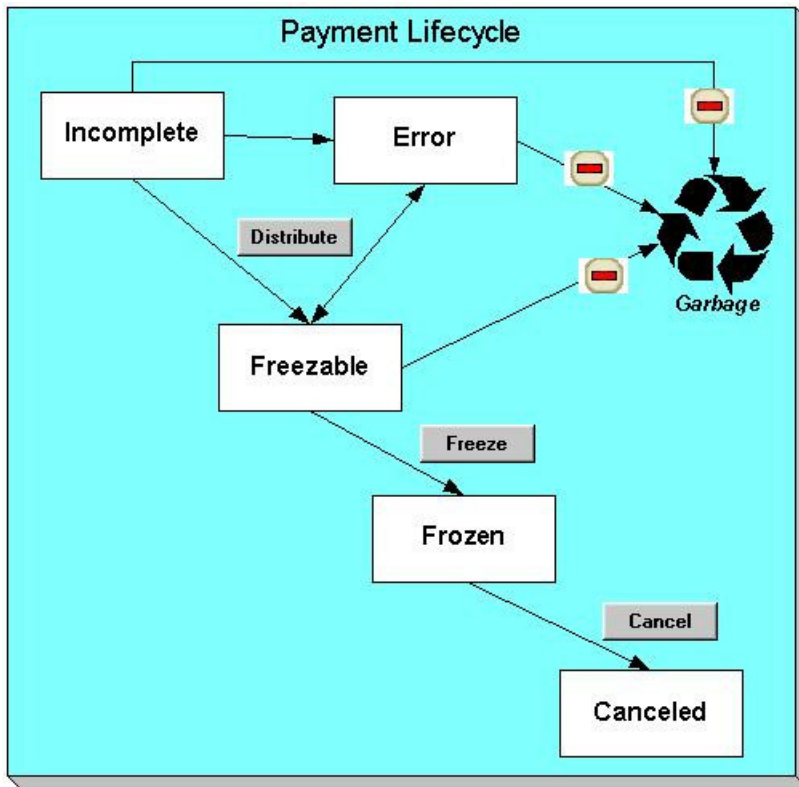

Payments are initially created in the Incomplete state. Payments in this state don't have payment segments or financial transactions; they are simply a stub awaiting distribution.

Click **Distribute** to distribute a payment amongst an account's service agreements.

- If the system cannot distribute the payment (for whatever reason), the payment is moved to the Error state. You may delete such a payment.
- If the system successfully distributes a payment, the payment becomes Freezable.

Click the - button to physically remove an Incomplete, Error or Freezable payment from the database.

Click **Freeze** to freeze a payment and its financial transaction. Freezing the payment causes the following to occur:

- The system executes any payment freeze algorithms linked to the account's [customer class](#) and to the service agreement's [SA type](#).
- The payment's state becomes Frozen and the payment may now appear on a customer's bill.

You may not change a payment once it is frozen. However, you may reverse the payment's financial effect by clicking **Cancel**. Clicking this button will cause the following to occur:

- A new financial transaction is generated and linked to the payment. This financial transaction reverses the financial effects of the original payment.
- The system executes any payment cancellation algorithms linked to the account's [customer class](#).
- If the payment has a related adjustment, this adjustment is also cancelled. Refer to [Loan Overpayments](#) for an example of payments with adjustments.
- The payment becomes Canceled.

Payment Event - Add Dialog

The Payment Event transaction features an unusual dialog that simplifies the addition of new payment events. This page appears if you open the **Menu > Financial > Payment Event > Add** from either the Account context menu or from Menu (it also appears if you click the clear button when on the Payment Event page).

NOTE:

If you have opted to always use the payment event distribution rules method as your [default method](#), the [Payment Event Quick Add \(Single Payment Event\)](#) page appears instead.

There is an Add One-Time Payment dialog that behaves similarly to Payment Event - Add, but adds a number of capabilities related to automatic payment methods. Refer to [Add One-Time Payment](#) for more details. To use the Add One-Time Payment popup instead of the Payment Event - Add popup, refer to [One-Time Payment Options](#) for details on enablement.

Description of Page

The **Payor Account ID** is the account that remitted the payment. We assume this account is both the tendering account and the account whose debt is being relieved by the payment. If this assumption is not correct, choose a **Distribute Action** of Do Not Distribute and then change the tendering or paying account when the Payment Event page appears (after you click **OK**).

NOTE:

Default note. If you have navigated to this page from account context menu, the Payor Account ID and Payment Amount are defaulted to this account.

The **Payment Amount** is the amount of the customer's debt to be relieved by the payment. Note, this amount is defaulted using an algorithm plugged in on the [Installation Record](#). Please refer to the Automatic Payment Amount Calculation algorithm, (C1-APAM-DFLT) for more information on the calculation.

The payment tenders grid allows you to enter multiple tender types and amounts. Click + to add a new tender. For each tender specify the following fields:

- The **Amount Tendered** is the amount of moneys remitted for the tender type.
 - **Tender Type** describes what was remitted (e.g., cash, check, ...). **Tender Type** defaults from the Quick Add Tender Type that is defined on the [installation record](#).
 - If a check was tendered, use **Check Number** to specify the identity of the check.
-

NOTE:

Cash back causes an additional tender to be created. If cash should be returned to the customer (because the customer overpaid and the tender type's cash back allowed switch is true and the tender type is not "like cash"), a negative tender for the cash back amount is created for the payment event. Refer to [Cash Back](#) for a description of how the system can recommend Cash Back amount if the customer tendered more than they are paying.

Match Type and **Match Value** are used if either of the following conditions is true:

- This **Payor Account** belongs to an [open item](#) customer class. In this situation, specify a **Match Type** to define how the payment should be matched to the customer's open-items and use **Match Value** to define the open-items covered by the payment. For example, if this payment is in respect of a bill, specify a match type of "bill ID" and a match value of the bill ID being paid.
-

NOTE:

Shortcut. If you enter a **Match Type** of "bill ID" and leave the **Match Value** blank, the system assumes the customer wants to pay the latest bill.

- The customer wants to restrict the distribution of the payment to a specific service agreement. In this situation, specify a **Match Type** of "service agreement ID" and a **Match Value** of the respective service agreement ID.

The **Payment Date** defaults to the current date.

If the **Payor Account ID's** [customer class](#) is designated as non-CIS (i.e., the person making the payment isn't a customer), the following information appears in the above window:

- **Non CIS Name** is the name of the person remitting the payment.
- **Reference Number** is the reference number of the item being paid (e.g., the property tax reference number).
- **Non CIS Comments** are used to describe anything unusual about the non-CIS payment.

Use **Distribute Action** to describe what you'd like to have happen when you click the **OK** button:

- Choose Distribute and Freeze if OK if this is a simple payment that should require no manual intervention. By "simple payment" we mean:
 - The account is both the tendering account and the account whose debt is being relieved by the payment
 - The payment date is the current date
 - The payment should be [distributed](#) amongst the account's service agreements using standard distribution logic
- If this option is selected, the system distributes the **Payment Amount** amongst the account's service agreements. If the distribution is successful, the system automatically freezes the payment. If the distribution is not successful, the payment will be in the Error or Incomplete state. When the Payment Event page appears, you can view the error and then correct it. After the cause of the error is corrected, you must distribute and freeze the payment manually (this can be done on several pages including [Payment Event - Main](#) and [Payment - Main](#)).
- Choose Manual Distribution if you need to manually distribute the payment amongst the account's service agreements. If this option is selected, the system creates a payment event, a tender and a payment and then transfers you to the [Payment - Manual Distribution](#) page where you can define the amount to be allocated to each of the account's service agreements. After you've distributed the payment, don't forget to freeze it.
- Choose Do Not Distribute if you want to process the payment event manually (e.g., if you need to define multiple accounts whose debt is relieved by the payment). If this option is selected, the [Payment Event - Main](#) page opens with the information you entered defaulted accordingly. You can make any changes you want and then distribute and freeze the payment. Refer to [How To Add A New Payment Event](#) for more information.

NOTE:

Cash-only warning. If the account has exceeded your [cash-only threshold](#) and the **Tender Type** isn't marked as "like cash", a warning appears advising of such. Note, a customer's cash-only points are maintained on [Account - Credit Rating](#).

Add One-Time Payment

The Add One-Time Payment user interface allows for quick add of one-time payment events using any of the following:

- Stored payment methods from self-service one-time payments and wallet maintenance
- A currently effective account auto pay option for recurring bill automatic payments
- New checking or savings payment methods - subject to web debit account validation, if the bank account is being used for the first time
- Cash

- Non-cash, non-auto pay tender types - e.g., check

NOTE: The Add One-Time Payment user interface is an alternative for the [Payment Event - Add Dialog](#). Refer to [One Time Payment Options](#) for information on how to enable it.

When enabled, the Add One-Time Payment dialog can be launched from any of the following:

- **Take A Payment** action from the Customer dashboard zone.
- Main Menu: **Menu > Financial > Payment Event > Add**
- Account context menu: **Payment Event > Add**

In addition, the Add One-Time Payment script can also be called from other places (zones, maps, etc) in the system where your implementation allows the capture of a one-time payment.

NOTE:

If you have opted to always use the payment event distribution rules method as your [default method](#), the [Payment Event Quick Add \(Single Payment Event\)](#) page appears instead.

The **Payment Date** defaults to the current date.

The **Payor Account ID** is the account that is tendering the payment. This is defaulted from the Account in context, if any.

NOTE:

Cash-only warning. If the account has exceeded your [cash-only threshold](#) a message appears advising of such. A customer's cash-only points are maintained on the [Account - Credit Rating](#) page.

The **Payment Amount** is the amount of the customer's debt to be relieved by the payment. Note, this amount is defaulted using an algorithm plugged in on the [Installation Record](#). Please refer to the Automatic Payment Amount Calculation algorithm, (C1-APAM-DFLT) for more information on the calculation.

The **Tenders - Existing Payment Options** grid is shown if the Payor Account has existing self-service payment methods and/or a currently effective recurring bill auto pay enrollment. Select a **Payment Option** and specify the **Tender Amount**.

The **Tenders - New Auto Pay Options and Other Tender Types** grid is used for new automatic payment methods, cash tender type(s) and other non-cash/non-auto pay tender types (e.g. check). Select a **Tender Type** and specify the applicable information. A new checking/savings payment method can be saved, to make it available for future one-time payments, including self-service payments. Specify the **Tender Amount**.

NOTE:

Cash back causes an additional tender to be created. If cash should be returned to the customer (because the customer overpaid and the tender type's cash back allowed switch is true and the tender type is not "like cash"), a negative tender for the cash back amount is created for the payment event. Refer to [Cash Back](#) for a description of how the system can recommend Cash Back amount if the customer tendered more than they are paying.

Credit card tender types are not supported. To ensure compliance with credit card processing rules, it is highly recommended that credit card payments be processed through a third-party payment processing system. If your implementation needs to support credit card tender types in this dialog, you can create a custom BPA script to override the base-owned BPA script. Refer to [One Time Payment Options](#) for details.

Match Type and **Match Value** are shown used if either of the following conditions is true:

- The **Payor Account** belongs to an [open item](#) customer class. In this situation, specify a **Match Type** to define how the payment should be matched to the customer's open-items and use **Match Value** to define the open-items covered by the payment. For example, if this payment is in respect of a bill, specify a match type of "bill ID" and a match value of the bill ID being paid.

NOTE:

Shortcut. If you enter a **Match Type** of "bill ID" and leave the **Match Value** blank, the system assumes the customer wants to pay the latest bill.

- The customer wants to restrict the distribution of the payment to a specific service agreement. In this situation, specify a **Match Type** of "service agreement ID" and a **Match Value** of the respective service agreement ID.

If the **Payor Account ID's** [customer class](#) is designated as non-CIS (i.e., the person making the payment isn't a customer), the following information appears in the above window:

- **Non CIS Name** is the name of the person remitting the payment.
- **Reference Number** is the reference number of the item being paid (e.g., the property tax reference number).
- **Non CIS Comments** are used to describe anything unusual about the non-CIS payment.

Use **Distribute Action** to describe what you'd like to have happen when you click the **OK** button:

- Choose **Distribute and Freeze if OK** if this is a simple payment that should require no manual intervention. "Simple payment" means:
 - The account is both the tendering account and the account whose debt is being relieved by the payment
 - The payment date is the current date
 - The payment should be [distributed](#) amongst the account's service agreements using standard distribution logic

If this option is selected, the system distributes the **Payment Amount** amongst the account's service agreements. If the distribution is successful, the system automatically freezes the payment. If the distribution is not successful or is on hold due to web debit account validation, the payment will be in the Error or Incomplete state, respectively. When the Payment Event page appears, you can view the error and then correct it. After the cause of the error is corrected, you must distribute and freeze the payment manually (this can be done on several pages including [Payment Event - Main](#) and [Payment - Main](#)). If any new auto pay methods are checking/savings bank accounts that have never been used on prior recurring auto pays and/or prior self-service one-time payments, the bank accounts will be subject to web debit account validation if the system is configured to do so. The One-Time Payment service task is created to manage bank account validation. The service task is linked to the payment event, which remains in Incomplete status until the validation is complete. The service task will either complete or delete the payment event, depending on the validation results. Refer to [Web Debit Account Validation](#) for more details.

- Choose **Manual Distribution** if you need to manually distribute the payment amongst the account's service agreements or if you want to process the payment event manually (e.g. if you need to define multiple payee accounts). If this option is selected, the system creates a payment event, a tender and a payment and then transfers you to the [Payment - Manual Distribution](#) page where you can define the amount to be allocated to each of the account's service agreements. After you've distributed the payment, don't forget to freeze it. If allocating the payment to multiple payee accounts, navigate to the [Payment Event - Main](#) page and make any changes before distributing and freezing the payment.

Payment Event - Main Information

The Main page contains core payment event information. Open this page using **Menu > Financial > Payment Event > Search**.

FASTPATH:

The **Description of Page** section below describes the fields on this page. Refer to [How To](#) for a description of how to perform common payment event maintenance functions.

Description of Page

NOTE:

Cash-only customers. When you attempt to add a new payment event, the system warns you if the account remitting the tender is a cash-only customer and the tender's [tender type](#) is not cash. An account is considered cash-only if their current cash-only points exceed the cash-only threshold maintained on the Installation record or account's CIS Division. A customer's cash-only points are maintained on [Account - Credit Rating](#).

Pay Event Info contains a concatenation of the payment date, amount, and the name of the main customer on the account that remits the tender. If multiple tenders exist, the customer's name is not displayed. If the payment event is associated with a single distribution detail, the rule name and the description of the rule value are displayed as well. If multiple distribution details exist, Multiple Distribution Details Exist is displayed instead. If document numbering has been enabled, the assigned document number will appear. If the payment was made in an alternate currency, the message Alternate Currency Used is displayed. **Pay Event Info** is only displayed after the payment event has been added to the database.

Refer to [Alternate Currency Payments](#) and [Document Numbers](#) for more information. **Payment Event ID** is the system-assigned unique identifier of the payment event.

The area under **Pay Event Info** provides warnings about the payment event. Possible warnings are Unfrozen Payments and The Payment Event is Unbalanced. A warning is also issued to the cashier to remind them to turn in funds - see [Turn Ins](#).

If multiple distribution details are linked to the payment event, the distribution rule, value, and amount for each distribution detail displays.

Payment Date is the business date associated with the payment event.

WARNING:

If you change the payment date and this event's tender(s) are automatic payments, the extract date (i.e., the date the automatic payment is sent to the financial institution) will be changed to equal the payment date. Refer to [Automatic Payments](#) for more information.

Payment(s) contains the total number and value of payments linked to the event.

Tender(s) contains the total number and value of tenders linked to the event.

Amount Tendered contains the amount that was tendered by the customer.

The system displays a **Cash Back Amount** if the customer tenders more than they are paying (refer to [Cash Back](#) for details).

If the payment event becomes unbalanced, a **Recalculate Cash Back** button appears. If this button is clicked, the system creates, deletes or recalculates the cash back tender. Refer to [Cash Back](#) for details.

While most payment events contain a single payment, the system allows many payments to exist under a payment event (when the payment event's tender(s) are distributed amongst multiple accounts). If a payment event has a large number of payments, you can use the **Account Filter** to limit the payments that appear in the **Payments** grid. The following options are available:

- **Account.** Use this option if you only want to see the payment linked to an **Account ID**.
- **All.** Use this option to view all payments linked to the payment event.
- **Person Name.** Use this option to restrict payments linked to accounts whose main customer has a primary name that matches **Person Name**.

The **Payments** grid contains the payment(s) linked to the payment event. The following points describe the attributes in this scroll; refer to [How To](#) for instructions describing how to perform common maintenance activities.

- **Account ID** references the payment's account. The name of the account's main customer is displayed adjacent.
- **Payment Amount** is the amount of the account's debt relieved by the payment. The adjacent context menu allows you to drill down to the details of the [payment](#) (this is where you can see the payment's payment segments and where you can override the distribution of the payment).

- **Payment Status** is the payment's status. If the payment's status is Error, the error message is displayed adjacent. Refer to [Payment Lifecycle](#) for the potential values and how to handle a payment when it exists in a given state.
- **Match Type** and **Match Value** should only be used if either of the following conditions is true:
 - This **Account ID** belongs to an [open item](#) customer class. In this situation, specify a **Match Type** to define how the payment should be matched to the customer's open-items and use **Match Value** to define the open-items covered by the payment. For example, if this payment is in respect of a bill, specify a match type of "bill id" and a match value of the bill id being paid.
 - The customer wants to restrict the distribution of the payment to a specific service agreement. In this situation, specify a **Match Type** of "service agreement ID" and a **Match Value** of the respective service agreement ID.
- The remaining columns are only used if the payment is linked to an **Account ID** that belongs to a customer class that is used for non-CIS payments. Refer to [Setting Up Customer Classes](#) for more information. If such an account exists, the following fields must be defined.
 - **Non CIS Name** is the name of the person remitting the payment.
 - **Reference Number** is the reference number of the item being paid (e.g., the property tax reference number).
 - **Non CIS Comments** are used to describe anything unusual about the non-CIS payment.
- Note, you can also define a comment for a non-CIS payment. To define a comment, use the context menu adjacent to **Payment Amount** to drill to [Payment - Main](#).
- **Payment ID** is the unique, system-assigned identifier of the payment. This value only appears after the payment has been added to the database.

Refer to [Payment Actions](#) and [Payment Event Actions](#) for information about the action buttons on this page. Refer to [How To](#) for a description of typical business processes that use these buttons.

Payment Event - Tenders

The Tenders page contains a scroll showing one row for every tender associated with the payment event. Open this page using **Menu > Financial > Payment Event > Search** and navigate to the **Tenders** page.

FASTPATH:

The **Description of Page** section below describes the fields on this page. Refer to [How To](#) for instructions describing how to perform common maintenance functions.

Description of Page

Pay Event Info contains a concatenation of the payment date, amount, and the name of the main customer on the account that remits the tender. If multiple tenders exist, the customer's name is not displayed. If the payment event is associated with a single distribution detail, the rule name and the description of the rule value are displayed as well. If multiple distribution details exist, Multiple Distribution Details Exist is displayed instead. If document numbering has been enabled, the assigned document number will appear. If the payment was made in an alternate currency, the message Alternate Currency Used is displayed. **Pay Event Info** is only displayed after the payment event has been added to the database.

Payment Event ID is the system-assigned unique identifier of the payment event.

Payment Date is the business date associated with the payment event.

Payment(s) contains the total number and value of payments linked to the event.

Tender(s) contains the total number and value of tenders linked to the event.

Amount Tendered contains the amount that was tendered by the customer.

The system displays a **Cash Back Amount** if the customer tenders more than they are paying (refer to [Cash Back](#) for details).

If the payment event becomes unbalanced, a **Recalculate Cash Back** button appears. If this button is clicked, the system creates, deletes or recalculates the cash back tender. Refer to [Cash Back](#) for details.

The **Tenders** scroll controls the display of the tenders linked to the payment event. The following simply describes the fields in this scroll; refer to [How To](#) for instructions describing how to perform common tender maintenance activities.

- **Payor Account ID** references the tendering account. The name of the account's main customer is displayed adjacent. If the account has exceeded your cash-only threshold, the warning Cash-Only appears.

WARNING:

If you change the Payor Account ID and the tender has an associated automatic payment request, the automatic payment request will be removed. A new automatic payment request will be created for the new Payor Account ID. Refer to [Automatic Payments](#) for more information.

-
- **Tender Amount** is the amount of the tender. The amount is disabled if the payment was made in an alternate currency.
 - If a check was used, the **Check Number** contains the identity of the check.
 - **Pay Tender ID** is the system-assigned unique identifier of the tender. This value appears after the tender has been added to the database.
 - **Tender Type** describes what was remitted (e.g., cash, check). If the **Tender Type** is associated with an automatic payment, the page displays a section that includes information about how and when the automatic payment was interfaced to the payment source.

NOTE:

Authorizing Tenders. The **Tender Type** dropdown list does not include tender types that require authorization (i.e. credit card payments).

FASTPATH:

For information about tender types requiring authorization, refer to [Credit Card Payments](#).

-
- If the payment tender was remitted in an alternate currency, i.e. a currency other than the payor account's currency, **Alternate Currency** and **Exchange Rate** will display the formatted alternate amount ((includes the alternate amount and currency) and the exchange rate that was in effect on the payment date.

FASTPATH:

For information about accepting payments in alternate currencies, refer to [Alternate Currency Payments](#).

-
- **Tender Status** is the tender's status. Refer to [Tender Lifecycle](#) for the potential values and how to handle a tender when it exists in a given state.
 - If the **Tender Type** is associated with an [automatic payment](#), the system attempts to default automatic payment information from the [account's auto-pay](#) option if the tender type is the same as the tender type on the account's auto-pay source and if the auto pay option is effective on the payment date. If the system is unable to default information, you must specify the source of the funds and the customer's account number / credit card number at the financial institution. You can override automatic payment information as long as the automatic payment has not been sent to the financial institution or cancelled. The **Auto Pay Section** contains the following fields:
 - **Auto Pay Source** is the financial institution / credit card company that receives the automatic payment request.
 - **Scheduled Extract Date** is the date the automatic payment request was sent / is scheduled to be sent to the financial institution. This information is display-only.
 - **External Account ID** is the customer's account number at the financial institution.

NOTE: The system supports encryption for External Account ID. If your implementation has configured the system to encrypt External Account ID, the data will be displayed with a masked value; such as, *****.Refer to [Encrypting Sensitive Data](#) for more information.

- **Expires On** is only needed if the Tender Type indicates that an expiration date is necessary (e.g., for a credit card payment).
- **Name** is the customer's name in the financial institution's system.
- **Bill ID** is the ID of the bill whose completion caused the creation of the automatic payment. This information only appears if the automatic payment was created as a result of a bill. This information is display-only.
- If the payment was uploaded, the following fields MAY contain information (if they were populated in the interface file):
- **MICR ID** is the value of the magnetic ink character recognition (MICR) line on the payment.

NOTE: The system supports encryption for MICR ID. If your implementation has configured the system to encrypt MICR ID, the data will be displayed with a masked value; such as, *****.Refer to [Encrypting Sensitive Data](#) for more information.

- **Customer ID** is the customer's account ID that appeared on the interfaced payment.
- **Ext. Reference ID** is the unique identifier of the payment upload interface record.
- **Name** is the customer's name on the interfaced payment record.
- In the **Tender Control** area, the **Tender Control ID** is the identity of the remittance processor batch or cash drawer bundle in which the tender was remitted. Refer to [Tender Management and Workstation Cashiering](#) for more information about tender controls.
- Displayed adjacent to **Tender Control** is the date, tender source, and status of the tender control.

Every new tender must reference an open tender control. The system will attempt to default an appropriate tender control as follows:

- If the user has at least one open, user-specific Tender Control, the system will default one, at random.
- If the user has no open, user-specific Tender Controls; the system will default an open, "all users" tender control if it can find one whose tender source indicates it's used for online cashiering. If multiple exist, one will be selected at random.
- Turn off **Included in Tender Ctl Balance** if the tender should not be included in the tender amount in the tender control's tender balance. You would turn this switch off if you canceled a tender because it was mistakenly applied to the wrong account (or the amount was wrong). This switch is only enabled if:
 - The tender control isn't balanced.
 - The tender is canceled.
- **Deposit Control** contains a concatenation of the tender control's deposit control's creation date, tender source type, and status. Refer to [Tender Management and Workstation Cashiering](#) for more information about deposit controls.
- The **Tender Action** area contains a button that you use to cancel a tender. Refer to [Tender Actions](#) for information about this button. Refer to [How To Cancel A Tender](#) for more information.

The **Characteristics** collection on the Tenders page contains information that describes miscellaneous information about the tender. The following fields display:

Characteristic Type Indicate the type of characteristic.

Sequence Controls the order in which characteristics of the same type are displayed.

Characteristic Value Indicate the value of the characteristic.

Payment Event - Characteristics

To update payment event characteristics, open **Menu > Financial > Payment Event > Search** and navigate to the **Characteristics** page.

Description of Page

The **Characteristics** collection contains information that describes miscellaneous information about the payment event.

The following fields display:

Characteristic Type Indicate the type of characteristic.

Sequence Controls the order in which characteristics of the same type are displayed.

Characteristic Value Indicate the value of the characteristic.

Exception

The topics in this section describe exceptions that are detected when the system allocates a payment.

Payment Event Exception

It is possible for a payment event's tenders to not equal its payments. Such events are classified as unbalanced. For each unbalanced payment event, a record is written to the Payment Event Exception table (CI_PAY_EVT_EXCP). A To Do background process creates To Do entries for records in this table.

Unbalanced payment events cause a record to be written to the payment event exception table with a message indicating the nature of the error.

To view the messages associated with the exception records, schedule the [TD-UNBAL](#) background process. This process generates a To Do entry for every record in the payment event exception table.

FASTPATH:

Refer to [Unbalanced Payment Events](#) for instructions describing how to correct an unbalanced payment event.

Payment Exception

When the system is unable to distribute a payment, a record to be written to the payment exception table with a message indicating the nature of the error. A common example of a payment exception is **no service agreement to hold a credit**. This can occur when an account overpays their debt and the account doesn't have a single service agreement that is allowed to hold a credit, a payment error is generated.

The system saves payments that are in error just as it saves payments that are error-free. This is done because payments are nothing more than a snapshot of the data that was used to distribute the payment. By saving the snapshot, you can see the information the system used when it detected the error and therefore more effectively correct it.

Every payment in error is written to the Payment Exception table (CI_PAY_EXCP). A To Do background process creates To Do entries for records in this table.

To view the messages associated with the exception records, schedule the [TD-PYERR](#) background process. This process generates a To Do entry for every record in the payment exception table.

After correcting the cause of the error, drill into the [Payment](#) and attempt to redistribute it.

Resolving Exceptions Automatically

Some payment errors occur because master data was not fully set up prior to receiving a payment for the account. For these cases, the system will periodically check to see whether the master data problem has been resolved by attempting to distribute and freeze the payment in error.

A background process, Resolve Payments in Error - [PY-RPE](#), exists for this purpose. This background process works as follows:

- It looks for payments in error where the error was caused by the lack of active service agreements linked to the payment's account. Note, this may occur when a customer is verbally asked to pay a connection fee or deposit prior to starting service, and for some reason, the appropriate service agreement has not been set up yet, or is still pending.
- For each such payment, it attempts to re-distribute the payment. If service agreements have been created in the meantime, this payment will distribute and freeze successfully.

Payment Event Action Codes

The topics that follow describe each of the actions that appear on the payment event pages.

Payment Actions

The topics that follow describe payment-oriented actions. Refer to [How To](#) for a description of several business processes that use these buttons.

Distribute (Payments)

Clicking the **Distribute** button distributes all Incomplete, Error, or Freezable payments linked to the event. Refer to [Distribute \(A Payment\)](#) for information of how a single payment is distributed.

This button is enabled if at least one payment is Incomplete, Error, or Freezable.

Redistribute (Payments)

Clicking the **Redistribute** button redistributes all Incomplete, Error, or Freezable payments linked to the event. Refer to [Redistribute \(A Payment\)](#) for information of how a single payment is redistributed.

This button is enabled if at least one payment is Incomplete, Error, or Freezable.

Print

The Print button is enabled under the following conditions:

- The payment event must have at least one payment that is Frozen and no payments that are Incomplete, Error or Freezable.

- A processing script is configured in the Point Of Sale (POS) Printer Integration master configuration.
 - For the Payment Event page, a **POS Printing - Payment Event** BPA script should be configured.
 - For the Payment Event Quick Add page, a **POS Printing - Payment Event Quick Add** BPA script should be configured.
 - For the Payment Quick Add page, a **POS Printing - Payment Quick Add** BPA script should be configured.

Refer to [How To Print Receipts And Endorsements](#) for more information.

Freeze (Payments)

Clicking the **Freeze** button causes all Freezable payments linked to the event to become frozen. Refer to [Freeze \(A Payment\)](#) for information of how a single payment is frozen.

This button is enabled if at least one payment is Freezable.

NOTE:

If problems are detected after freezing. A payment may not be changed after it is frozen. All subsequent changes must occur by canceling the frozen payment and creating a new one. You can cancel and redistribute a payment on the next tab. Refer to [Canceling A Tender Versus Canceling a Payment](#) for more information.

Payment Event Actions

The topics that follow describe payment event-oriented actions. Refer to [How To](#) for a description of typical business processes that use these buttons.

Transfer

If the payment event was created using distribution rule(s), any transfer of its payments should also be done using the distribution rules method. Hence, a different dialog opens when you click **Transfer** based on whether the payment event is associated with at least one distribution detail or not.

Transfer (No Distribution Details Exist)

The **Transfer** button is enabled if:

- There is a single non-cancelled tender linked to the event AND
- There is a single frozen payment linked to the event AND
- The account on the tender is the same as the account on the payment.

When clicked, the **Payment Event Transfer** dialog opens.

You must specify the following parameters in the **Payment Event Transfer** dialog to transfer a payment:

- **Account ID** is the account to which the payment event should be transferred.
- **Cancel Reason** defines why you are performing the transfer.
- **Match Type** and **Match Value** are defaulted based on their values for the payment event that you are transferring. If necessary, modify the values appropriately for the account to which you are transferring the payment event. Match Type and Match Value are used for an account that belongs to an [open item](#) customer class or to restrict the distribution of the payment to a specific service agreement. Refer to [Payment Event - Main](#) for more information.

- Turn on **Freeze Payment** if the transferred payment should be frozen automatically. You may want to leave this turned off if you want to examine the payment distribution before freezing the payment.
- **Non CIS Name, Reference Number, and Non CIS Comments** appear if the **Account ID** belongs to a customer class that is used for non-CIS payments. Refer to [Setting Up Customer Classes](#) for more information.

Clicking **OK** causes the following to take place:

- The account on the tender is changed to reflect the transfer to account.
- The original payment and its segments are cancelled.
- A new payment is added for the transfer to account. The payment characteristics associated with the original payment are copied to the new payment.
- The new payment is distributed.
- If so designated, the new payment is frozen.

Transfer (Distribution Details Exist)

The **Transfer** button is enabled if:

- There is a single payor AND
- All existing payees before the transfer are the same as the payor AND
- There is at least a single non-cancelled tender linked to the event

When clicked, the **Payment Event Transfer** dialog opens.

You must specify the following parameters in this dialog to transfer payment(s):

- **Distribution Rule** is the account to which the payment event should be transferred.
- **Rule Value** is the value associated with the payment and expected by the distribution rule.
- **Amount** is the payment amount.
- **Cancel Reason** defines why you are performing the transfer.

Clicking **OK** causes the following to take place:

- The payment(s) associated with the original account are canceled.
- The new set of distribution details are processed, creating new payment(s) for the transfer to account. The payment characteristics associated with the original payment are copied to the new payment.
- If all new payments are for the same payee account (and the payee is different than the current payor) the account on the tender is changed to reflect the transfer to account.
- Original distribution details (only those with a non-zero amount) are deleted and replaced by the new set of details on the payment event.

NOTE:

Distribution rule entries can have a zero amount. Refer to [Rule Value Can Capture Additional Information](#) for more information about how to use distribution details to capture additional payment related information.

Determine Tender Account. This dialog does not call the Determine Tender Account algorithm defined on [distribution rule](#) as this action does not rebuild the payment tender collection.

FASTPATH:

Refer to [Rule Value Can Capture Additional Information](#) for more information about how to use distribution details to capture additional payment related information.

Delete A Payment Event

The **Delete** button deletes a payment event and its tenders and payments.

This button is enabled if there are no frozen or canceled payments and no canceled tenders.

Tender Actions

The topics that follow describe tender-oriented actions. Refer to [How To](#) for a description of several business processes that use these buttons.

Cancel A Tender

Clicking **Cancel** causes the following to take place:

- All payments associated with the tender's payment event are canceled.
- The tender becomes canceled.
- If the cancellation reason indicates the cancellation is due to non-sufficient funds, other actions may occur. Refer to [NSF Cancellations](#) for more information.

The **Cancel** button is enabled if the tender is not canceled

When clicked, the **Tender Cancel** window opens.

You must specify the following parameters to cancel a tender:

- Select a **Cancel Reason** to describe why the tender is being canceled.
- The system also needs to know which **Bank Account To Charge** the cancellation against. The system will default the **Bank** and **Bank Account Key** from the original bank information used when the tender was deposited. You can override them here.

When you click the **OK** button, the system cancels the tender and ALL payments linked to the event.

NOTE:

When non-canceled tenders are still linked to the event. If there are multiple tenders linked to the payment event, you must either add new payment(s) that equal the sum of the event's non-canceled tenders or cancel the remaining tenders.

Cancellation after cash back. If a customer tenders a check for \$100, but only owes \$80, the system will recommend returning \$20 in cash to the customer (assuming the tender type for checks allows overpayment). If the tender type for checks is not "like cash", a second tender is created for -\$20 (the first tender is for \$100). If the check subsequently bounces, both tenders must be cancelled.

Payment Event Quick Add

The Payment Event Quick Add page is used to quickly add, distribute and freeze one or more payment events using [distribution rules](#). Open this page using **Menu > Financial > Payment Event Quick Add > Search**.

Description of Page

Specify the **Tender Control ID** in which the tenders will be recorded. Every new tender must reference an open tender control. The system will attempt to default an appropriate tender control as follows:

- If the user has at least one open, user-specific Tender Control whose type is online cashiering or ad hoc, the system will default one, at random.
- If the user has no open, user-specific Tender Controls; the system will default an open, "all users" tender control if it can find one whose tender source has a tender source type of online cashiering or ad hoc. If multiple exist, one will be selected at random.

Specify the **Payment Date**. The current date defaults.

Use **Number of Payment Events** to indicate whether you intend to add a single payment event or multiple payment events.

Choose the multiple payment events option if you intend to add "simple" payment events. By "simple" we mean:

- A single account is both the payor account and the account whose debt is being relieved by the payment.
- The payment tender is not an auto-pay tender.

For all other cases choose the single payment event dialogue as it is designed to handle more complex payment event configurations such as when:

- The payor account is different than the payee account.
- Multiple payors cover payments for one or more payees.
- The payment tender is an auto-pay tender.

Once you have made your selection the page is adjusted to support the corresponding dialog.

NOTE:

Cash-Only customers. When you attempt to add a new payment event, the system warns you if the account remitting the tender is a cash-only customer. An account is considered cash-only if their current cash-only points exceed the cash-only threshold maintained on the Installation record or the account's CIS Division. A customer's cash-only points are maintained on [Account - Credit Rating](#).

Multiple Payment Events Dialog

This section describes the default dialog setup when navigating from **Menu > Financial > Payment Event Quick Add**

Description of Page

Using the multiple payment events option, each row in the payment detail grid typically represents a unique distribution detail. However, more than one row in the grid can belong to a single payment event. All distribution details for identical tender account will be grouped under a single pay event.

The following columns appear in the **Payments** grid:

- Select a **Distribution Rule** by which the payment detail is to be processed. If you have set up a [default distribution rule](#), it is defaulted in the first row.
- Specify the **Rule Value** associated with the payment and expected by the distribution rule.
- Use **Payment Amount** to define the amount of the payment.
- Use **Tender Type** to define the form or remittance (e.g., cash, check, etc.). Note that the **Tender Type** defaults from the [installation record](#).

NOTE:

Authorizing Tenders. The **Tender Type** dropdown list does not include tender types that require authorization (i.e. credit card payments).

FASTPATH:

For information about tender types requiring authorization, refer to [Credit Card Payments](#).

NOTE:

Automatic Payments. The multiple payment events dialog does not support automatic payments. Switch to the single payment event dialog to enter automatic payments.

- Use **Check Number** if a check is remitted.
- **MICR ID** is the value of the magnetic ink character recognition (MICR) line on the payment.

NOTE: The system supports encryption for MICR ID. If your implementation has configured the system to encrypt MICR ID, the data will be displayed with a masked value; such as, *****. Refer to [Encrypting Sensitive Data](#) for more information.

- You may use **Customer ID** to record additional customer information.
- You may use **External Reference ID** to record external information associated with the payment tender.
- You may use **Name** to record additional payment tender information.
- **MICR ID** is the MICR ID associated with the tender.
- **Payor Account ID** is the tender account as determined by the Determine Tender Account algorithm defined on the [distribution rule](#). This information is only populated after the distribution detail has been processed.

After specifying the various payment distribution details in the grid, click **Create**. The system attempts to create payment event(s) as follows:

- As mentioned earlier, all distribution details for identical tender accounts are grouped under a single pay event. The first step in identifying common tenders is to determine the tender account. To do that the system calls the Determine Tender Account algorithm defined on the [distribution rule](#).
- A payment event is created for each unique tender account.
- All rows having all attributes of the tender identical except for the amount are grouped together where each group represents a single tender.
- A single payment tender is created for each unique tender and linked to the payment event.
- The total payment amount for each distinct group of distribution details (for the payment event) having the same rule and value is summarized. For each distinct group, the system calls the Create Payment algorithm defined on the [distribution rule](#) providing it with the rule value and total payment amount. It is the responsibility of this algorithm to create the payments for this payment event.
- Add the distinct payment event distribution detail and its total amount beneath the payment event.
- If your implementation is configured for printing at a cashier station, the [Print](#) dialog appears. Refer to [How To Print Receipts and Endorsements](#) for more details.

The **Payment Event ID** column appears in the grid after the distribution details have been processed. It shows the payment event ID created for the distribution detail record and a short description as to the status of the payment(s) created for the payment event. You can use this field to navigate to the payment event.

After you've added a group of payment events, you should press the [clear](#) button (or Alt-C), to ready the page for the next group of payment event details.

Single Payment Event Dialog

If you have opted to always use the payment event distribution rules method as your [default method](#), this section describes the default dialog setup when you navigate to the **Payment Event** page in **Add** mode.

Adding a single payment event at a time, allows for more complex payment event information to be captured.

Enter one row in the **Tenders** grid for every unique tender associated with the payment event.

- **Payor Account ID** references the tendering account. The name of the account's main customer is displayed adjacent. If the account has exceeded your cash-only threshold, the warning Cash-Only appears.

WARNING:

If you change the Payor Account ID and the tender has an associated automatic payment request, the automatic payment request will be removed. A new automatic payment request will be created for the new Payor Account ID. Refer to [Automatic Payments](#) for more information.

- **Tender Amount** is the amount of the tender.
- Use **Tender Type** to define the form or remittance (e.g., cash, check, etc.). Note, the **Tender Type** defaults from the [installation record](#).
- Use **Check Number** if a check is remitted.
- **MICR ID** is the value of the magnetic ink character recognition (MICR) line on the payment.

NOTE: The system supports encryption for MICR ID. If your implementation has configured the system to encrypt MICR ID, the data will be displayed with a masked value; such as, *****. Refer to [Encrypting Sensitive Data](#) for more information.

- You may use **Customer ID** to record additional customer information.
- You may use **External Reference ID** to record external information associated with the payment tender.
- You may use **Name** to record additional payment tender information.
- If the **Tender Type** is associated with an automatic payment, the page displays a section that includes information about how and when the automatic payment was interfaced to the payment source.
- If the **Tender Type** is associated with an [automatic payment](#), the system attempts to default automatic payment information from the [account's auto-pay](#) option if the tender type is the same as the tender type on the account's auto-pay source and if the auto pay option is effective on the payment date. If the system is unable to default information, you must specify the source of the funds and the customer's account number / credit card number at the financial institution.
 - **Auto Pay Source** is the financial institution / credit card company that receives the automatic payment request.
 - **External Account ID** is the customer's account number at the financial institution.
 - **Expires On** is only needed if the **Tender Type** indicates that an expiration date is necessary (e.g., for a credit card payment).
 - **Name** is the customer's name in the financial institution's system.

The following columns appear in the **Payments** grid:

- Select a **Distribution Rule** by which the payment detail is to be processed. If you have set up a [default distribution rule](#), it is defaulted in the first row.
- Specify the **Rule Value** associated with the payment and expected by the distribution rule.
- Use **Payment Amount** to define the amount of the payment.

After specifying the various payment distribution details in the grid, click **Create**.

NOTE:

Go To Payment Event. If you wish to be transferred to the payment event page once processing is complete, remember to check the Go To Payment Event check box before you click **Create**. This field does not appear when this page is used as the default Payment Event - Add Dialog and you are automatically transferred to the payment event page once the payment event is created.

After distribution details have been processed, a short description of the payment event that has been created is displayed to the right of the **Go To Payment Event** field. The description provides information as to the status of the payment(s) created for the payment event. You can use this field to navigate to the payment event.

The system attempts to create the payment event as follows:

- Validate that the sum of the tenders is not less than the sum of the payments.
 - Create the payment event with a separate payment tender for each row in the Tenders grid.
 - Summarize the total payment amount for each distinct group of distribution details having the same rule and value. For each distinct group, call the Create Payment algorithm defined on the [distribution rule](#) providing it with the rule value and total payment amount. It is the responsibility of this algorithm to create the payments for the payment event.
 - Add the distinct payment event distribution detail summary beneath the payment event.
 - If your implementation is configured for printing at a cashier station, the [Print](#) dialog appears. Refer to [How To Print Receipts and Endorsements](#) for more details.
-

NOTE:

Determine Tender Account. Having an explicit collection of tenders eliminate the need to determine the tender account. Therefore this dialog does not call the Determine Tender Account algorithm.

Payment Quick Add

The Payment Quick Add page is used to quickly add, distribute and freeze payment events for up to fifteen accounts. Open this page using **Menu > Financial > Payment Quick Add**.

Description of Page

Specify the **Tender Control ID** in which the tenders will be recorded. Every new tender must reference an open tender control. The system will attempt to default an appropriate tender control as follows:

- If the user has at least one open, user-specific Tender Control whose type is online cashiering or ad hoc, the system will default one, at random.
- If the user has no open, user-specific Tender Controls; the system will default an open, "all users" tender control if it can find one whose tender source has a tender source type of online cashiering or ad hoc. If multiple exist, one will be selected at random.

Specify the **Payment Date**. The current date defaults.

Enter one row in the grid for every payment event to be added. The following information is entered for each payment event:

- Use **Account ID** to define the customer who tendered the payment. It's important to note that this transaction assumes that the tendering account is the same as the account whose balance is relieved by the payment. Refer to [How To Allocate The Tender Amount To Multiple Accounts](#) if you need to distribute the payment to an account (or accounts) other than the tendering account.
-

NOTE:

Cash-Only customers. You cannot use this transaction to add a payment for a "cash-only" account if the tender type is not "like cash". An account is considered cash-only if its cash-only points exceed the cash-only threshold maintained on the Installation record. A customer's cash-only points are maintained on [Account - Credit Rating](#). You must use the [Payment Event transaction](#) to add such a payment (note, if you use the Account context menu to transfer to the Payment Event page in add mode, you won't have to retype the Account ID when you add the payment event).

- Use **Payment Amount** to define the amount of the payment.
 - Use **Tender Type** to define the form or remittance (e.g., cash, check, etc.). Note, the **Tender Type** defaults from the [installation record](#).
-

NOTE:

Authorizing Tenders. The **Tender Type** dropdown list does not include tender types that require authorization (i.e. credit card payments).

FASTPATH:

For information about tender types requiring authorization, refer to [Credit Card Payments](#).

- Use **Check Number** if a check is remitted.
 - **Match Type** and **Match Value** are only used if either of the following conditions is true:
 - This **Account ID** belongs to an [open item](#) customer class. In this situation, specify a **Match Type** to define how the payment should be matched to the customer's open-items and use **Match Value** to define the open-items covered by the payment. For example, if this payment is in respect of a bill, specify a match type of "bill id" and a match value of the bill id being paid.
-

NOTE:

Shortcut. If you enter a **Match Type** of "bill id" and leave the **Match Value** blank, we assume the customer wants to pay the latest bill.

- The customer wants to restrict the distribution of the payment to a specific service agreement. In this situation, specify a **Match Type** of "service agreement ID" and a **Match Value** of the respective service agreement ID.

After specifying the various accounts and amounts in the grid, click the **Distribute and Freeze** button. When you click this button, the system attempts to create a payment event for each row in the grid. Four potential outcomes are possible for each row:

- If the data you entered for a payment event isn't complete (e.g., you don't specify a valid account or amount):
 - No payment event is created.
 - A **Message** describing the problem is displayed.
 - All fields on the row remain modifiable.
 - You should correct each such line and then press the **Distribute and Freeze** button.
 - If the data you entered is complete, but the system issues a warning (e.g., the account is considered "cash-only" and a tender type other than cash is remitted, or if the account already has a payment for this amount on this date):
 - No payment event is created.
 - A **Message** containing the warning is displayed.
 - All fields on the row remain modifiable.
 - You must clear the line and add a payment using the [Payment Event transaction](#) (note, if you use the Account context menu to transfer to the Payment Event page in add mode, you won't have to retype the Account ID when you add the payment event).
-

- If the data you entered is complete, but the system is not successful in distributing the payment:
 - The system creates a payment event, a payment and a tender.
 - A **Message** describing the problem is displayed.
 - The payment's **Status** is displayed
 - All fields on the row are disabled.
- You must press the adjacent go to button to drill to the payment event where the error can be corrected.
- If the data you entered is complete and the system is successful in distributing the payment:
 - The system creates a payment event, a payment, and a tender.
 - The system distributes the payment amongst the account's service agreements and then freezes the payment.
 - The payment's **Status** is displayed.
 - All fields on the row are disabled.
 - If your implementation is configured for printing at a cashier station, the [Print](#) dialog appears. Refer to [How To Print Receipts and Endorsements](#) for more details.
- You can press the adjacent go to button to view a payment event.

NOTE:

Separate Commits. This page is unusual in that each payment event is committed to the database independently. For example, if you enter seven payment events and one is invalid, six payment events will be added to the database when you press **Distribute and Freeze**. When the page is redisplayed, the rows containing the valid payments are protected and an indication of their validity is displayed. The row containing the invalid payment remains unprotected. You can correct the erroneous payment and then press the **Distribute and Freeze** button again.

After you've added a group of payments, you should press the [clear button](#) (or Alt-C), to ready the page for the next group of payment events.

Maintaining Payments

Payments and payment segments are automatically created by the system when [payment events](#) are created. You should only need to access this transaction as follows:

- To view a payment's payment segments (i.e., to view how a payment was distributed amongst its account's service agreements).
- To override the distribution of a payment amongst its account's service agreements. Refer to [Distributing A Payment Amongst An Account's Service Agreements](#) for information describing how payments are typically distributed.

The topics in this section describe how to maintain a payment.

Payment - Main

This page contains basic information about a payment. Open this page using **Menu > Financial > Payment > Search**.

WARNING:

Most payments are maintained using the [Payment Event](#) page. The transaction described below is typically only used to view a payment's payment segments and to manually distribute a payment amongst an account's service agreements.

FASTPATH:

The **Description of Page** section below describes the fields on this page. Refer to [How To](#) for instructions on how to perform common maintenance functions.

Description of Page

Payment Info contains a concatenation of the payment date, amount, status, and the name of the main customer on the account.

Payment ID is the system-assigned unique identifier of the payment.

Payment Event ID is the system-assigned unique identifier of the payment event. The adjacent info contains a concatenation of the payment date, amount, and the name of the main customer on the account that remits the event's tender. If multiple tenders exist, the customer's name is not displayed. A warning may also be displayed. The possible warnings are Unfrozen Payments and The Payment Event is unbalanced.

Payment(s) contains the total number and value of payments linked to the payment event.

Tender(s) contains the total number and value of tenders linked to the payment event.

Account ID is the account whose debt is reduced by the payment. The name of the account's main customer is displayed adjacent. This field is gray after the payment is frozen.

Payment Amount is the amount of the payment. This field is gray after the payment is frozen. If the account has exceeded your [cash-only threshold](#), a warning (in red) appears adjacent to **Payment Amount**. Note, a customer's cash-only points are maintained on [Account - Credit Rating](#).

Payment Status is the payment's status. Refer to [Payment Lifecycle](#) for the potential values and how to handle a payment when it exists in a given state. If the payment is in Error, the error message is displayed adjacent. If the payment is canceled, the **Cancel Reason** is displayed adjacent.

Match Type and **Match Value** will only be used if either of the following conditions is true:

- This **Account ID** belongs to an [open item](#) customer class. In this situation, specify a **Match Type** to define how the payment should be matched to the customer's open-items and use **Match Value** to define the open-items covered by the payment. For example, if this payment is in respect of a bill, specify a match type of "bill id" and a match value of the bill id being paid.
- The customer wants to restrict the distribution of the payment to a specific service agreement. In this situation, specify a **Match Type** of "service agreement ID" and a **Match Value** of the respective service agreement ID.

Match Type and **Match Value** are gray after the payment is frozen.

If the payment is linked to an **Account ID** that belongs to a [customer class](#) that is used for non-CIS payments, the following fields appear (note, these fields are gray after the payment is frozen):

- **Name** is the name of the person remitting the payment.
- **Reference Number** is the reference number of the item being paid (e.g., the property tax reference number).
- **Comments** are used to describe anything unusual about the non-CIS payment.

The contents of the **Payment Segments** section depends on the number of payment segments linked to the payment. If more than 25 payment segments exist, a message appears that allows you to navigate to [Payment - Payment Segments](#) where you can view the payment segments (this page has special functionality that allows you to defined which payment segments should be displayed). If 25 or fewer payment segments exist, the grid contains information about each payment segment:

- **Premise** is the address of the service agreement's main premise.
- **SA Information** contains basic information about the service agreement.
- **Distributed Amt** is the amount of the service agreement's debt relieved by the payment.

The following information appears at the bottom of the page:

- **Payment Amount** is the amount of the payment.

- **Distributed Amount** is the sum of the payment segments linked to the payment.
- The **Difference** between the **Payment Amount** and the **Distributed Amount** appears if it is non-zero.
- **Billed Amount** is the amount of the bill preceding the payment date.
- **Delinquent Amount** is the amount of the customer's debt that was due on / before the prior bill's due date.
- **Current Balance** is the account's current balance.

Refer to [Payment Action Codes](#) for information about the action buttons on this page.

Payment - Pay Segments

You can use this page to view all or selected payment segments linked to a payment.

Open **Menu > Financial > Payment > Search** and navigate to the **Payment Segments** page to view this information.

WARNING:

Most payments are maintained using the [Payment Event](#) page. The transaction described below is typically only used to view a payment's payment segments.

NOTE:

If the payment has more than 25 payment segments, the search criteria are intentionally left blank in order to avoid retrieving all payment segments (with the resultant slow response times). You must therefore use the **SA Filter** to define the type of payment segments that should be retrieved. See the Description of page below for more information about this page's search criteria.

Description of page

Payment Info contains a concatenation of important information about the payment.

Payment ID is the system-assigned unique identifier of the payment.

Payment Event ID is the system-assigned unique identifier of the payment event. The adjacent info contains a concatenation of the payment date, amount, and the name of the main customer on the account that remits the event's tender. If multiple tenders exist, the customer's name is not displayed. A warning may also be displayed. The possible warnings are Unfrozen Payments and The Payment Event is unbalanced.

Payment(s) contains the total number and value of payments linked to the payment event.

Tender(s) contains the total number and value of tenders linked to the payment event.

NOTE:

If the payment has more than 25 payment segments, the search criteria are intentionally left blank in order to avoid retrieving all payment segments (with the resultant slow response times). You must therefore use the **SA Filter** to define the type of payment segments that should be retrieved.

Use the **SA Filter** to define the types of service agreements whose payment segments appear in the grid. The following options are available:

- **Address.** Use this option to restrict payment segments to those whose service agreements are linked to service points associated with a given **Address, City** and/or **Postal** code. Note, you can specify any combination of these fields.
- **All.** Use this option if you do not wish to restrict payment segments based on service agreement attributes.
- **Geographic Type.** Use this option to restrict payment segments to those whose service agreements are linked to service points associated with a given **Geographic Type** and **Geographic Value**.

- **SA Type.** Use this option to restrict payment segments to those whose service agreements are linked to a given **CIS Division** and **SA Type**.

Don't forget to click the search button after changing the **SA Filter**.

The grid that follows contains the payment segments that match your search criteria. The following information appears in the grid:

- The **Premise** column contains the characteristic premise associated with the payment segment's service agreement. Refer to [Maintaining Premises](#) for more information about this premise.
- Click the go to button to transfer to view the financial transaction related to the payment segment. This is only available after the payment has been frozen.
- **SA Information** contains summary information about the service agreement.
- **Distributed Amt** is the amount of the service agreement's debt relieved by the distribution.
- **Adjustment ID** is displayed if there is an adjustment associated with the payment. Refer to [Loan Overpayments](#) for an example of when an adjustment is associated with a payment.

The following information appears at the bottom of the page:

- **Payment Amount** is the amount of the payment.
- **Distributed Amount** is the sum of the payment segments linked to the payment.
- The **Difference** between the **Payment Amount** and the **Distributed Amount** appears if it is non-zero.
- **Billed Amount** is the amount of the bill preceding the payment date.
- **Delinquent Amount** is the amount of the customer's debt that was due on / before the prior bill's due date.
- **Current Balance** is the account's current balance.

Payment - Manual Distribution

You can use this page to view service agreements linked to the payment's account and to manually distribute a payment amongst specific service agreements.

Open this page using **Menu > Financial > Payment > Search** and navigate to the **Manual Distribution** page.

WARNING:

Most payments are maintained using the [Payment Event](#) page. The transaction described below is typically only used to view a payment's payment segments and to manually distribute a payment amongst an account's service agreements.

NOTE:

If the payment's account has more than 25 service agreements, the search criteria are intentionally left blank in order to avoid retrieving all service agreements (with the resultant slow response times). You must therefore use the **SA Filter** to define the type of service agreements that should be retrieved. See the Description of page below for more information about this page's search criteria.

Description of page

Payment Info contains a concatenation of important information about the payment.

Payment ID is the system-assigned unique identifier of the payment.

NOTE:

If the payment's account has more than 25 service agreements, the search criteria are intentionally left blank in order to avoid retrieving all service agreements (with the resultant slow response times). You must therefore use the **SA Filter** to define the type of service agreements that should be retrieved.

Use the **SA Filter** to define the types of service agreements that appear in the grid. The following options are available:

- **Address.** Use this option to restrict service agreements to those linked to service points associated with a given **Address, City** and/or **Postal** code. Note, you can specify any combination of these fields.
- **All.** Use this option if you want to view all service agreements.
- **Geographic Type.** Use this option to restrict service agreements to those linked to service points associated with a given **Geographic Type** and **Geographic Value**.
- **SA Type.** Use this option to restrict service agreements to those linked to a given **CIS Division** and **SA Type**.

Don't forget to click the search button after changing the **SA Filter**.

The grid that follows contains the service agreements that match your search criteria. The following information appears in the grid:

- **Premise** contains the characteristic premise associated with the service agreement.
 - **SA Information** contains summary information about the service agreement.
 - **Distributed Amt** is the amount of the service agreement's debt relieved by the payment. This field is gray after the payment is frozen.
 - **Billed Amt** is the amount that was billed for the service agreement on the bill preceding the payment date.
 - **Delinquent Amt** is the amount of debt associated with financial transactions that appear on overdue bills.
 - **Current Balance** is the amount currently owing for this service agreement.
-

NOTE:

If the account being paid is an **open item** account, then an alternate grid is displayed. The alternate grid is designed to break down payable balances by individual bill and service agreement. Both unpaid bill balances and new charges are displayed. After distribution, a separate match event will be created for each bill paid or partially paid.

that an implementation can override the type of grid displayed for open item accounts by setting up a Financial Transaction Options [Feature Configuration](#) with an Always Use Manual Payment Distribution By SA option set to Y. With this in place, the system will always display the manual distribution by service agreement grid.

The open item manual distribution grid contains the following columns:

- **Bill Date**
 - Shows bill date if the row contains an account's unpaid bill.
 - Shows '**New Charges**' if the row contains an account's unbilled new charges.
 - Shows '**Payment Segment**' for the following conditions:
 - Row is a pay segment of a cancelled payment.
 - Row is a pay segment of an overpayment to the highest priority SA or an excess credit SA.
 - Row is a pay segment of a balance forward payment distribution.
 - **Premise Information** contains the characteristic premise associated with the service agreement.
 - **SA Information** contains summary information about the service agreement.
 - **Distributed Amount**
 - You can enter an amount to distribute if the payment is non-frozen and non-cancelled, otherwise, this field is protected.
-

- **Billed Amount**
 - The amount that was billed for the service agreement on the row's bill. If the row does not represent a bill amount then this will be zero.
- **Unpaid Amount**
 - This is determined by the "determine open-item bill amount" algorithm as defined on the installation option.
 - This column will contain zero if:
 - The row is linked to an open non-disputed match event with other bills' FTs on it. In this case, it is not possible to determine the bill amount.
 - The row is linked to an open disputed match event.

For either grid, the following information appears at the bottom of the page:

- **Payment Amount** is the amount of the payment.
- **Distributed Amount** is the sum of the payment segments linked to the payment.
- The **Difference** between the **Payment Amount** and the **Distributed Amount** appears if it is non-zero.
- **Billed Amount** is the amount of the bill preceding the payment date.
- **Delinquent Amount** is the amount of the customer's debt that was due on / before the prior bill's due date.
- **Current Balance** is the account's current balance.

Payment - Characteristics

To update payment characteristics, open **Menu > Financial > Payment > Search** and navigate to the **Characteristics** page.

Description of Page

The **Characteristics** collection contains information that describes miscellaneous information about the payment. The following fields display:

Characteristic Type Indicate the type of characteristic.

Sequence Controls the order in which characteristics of the same type are displayed.

Characteristic Value Indicate the value of the characteristic.

Payment Action Codes

The topics in this section describe each of the actions that appear on the payment pages.

Distribute (A Payment)

Clicking the **Distribute** button causes a payment to be distributed amongst the account's service agreements. Refer to [Distributing A Payment Amongst An Account's Service Agreements](#) for a description of how this is achieved.

This button is enabled if a payment is Incomplete, Error, or Freezable. Refer to [Payment Lifecycle](#) for more information about these status values.

If the payment is distributed appropriately, click the [Freeze](#) button to freeze the payment and its payment segments.

Redistribute (A Payment)

Clicking the **Redistribute** button causes a payment to be redistributed amongst the account's service agreements. Refer to [Distributing A Payment Amongst An Account's Service Agreements](#) for a description of how this is achieved.

This button is enabled if a payment is Incomplete, Error, or Freezable. Refer to [Payment Lifecycle](#) for more information about these status values.

If the payment is distributed appropriately, click the [Freeze](#) button to freeze the payment and its payment segments.

NOTE:

This button is only available on the [Payment - Main](#) and [Payment - Manual Distribution](#) pages.

Confirm (A Payment)

Clicking the **Confirm** button confirms that manually entered amounts associated to certain SAs will relieve their balances. This is the same process that is triggered by clicking **Save**.

This button is enabled if a value is manually entered in a Distributed Amount field.

Freeze (A Payment)

Clicking the **Freeze** button causes a payment and its payment segments to become frozen. Refer to [Payment Lifecycle](#) for more information about freezing.

This button is enabled if the payment is Freezable.

NOTE:

If problems are detected after freezing. A payment may not be changed after it is frozen. All subsequent changes must occur by canceling the frozen payment and creating a new one.

Cancel (A Payment)

Clicking the **Cancel** button causes the payment and its payment segments to be canceled. Canceling a payment (as opposed to canceling a tender) is typically only done if the original distribution was frozen and it's incorrect.

This button is enabled if the payment is Frozen. Refer to [Payment Lifecycle](#) for more information about these status values.

Transfer (A Payment)

The **Transfer** button is enabled if the payment is Frozen. Refer to [Payment Lifecycle](#) for more information about these status values.

If the payment being transferred was created using payment event distribution rule(s), the payment transfer should also be done using the distribution rules method. Hence, a different dialog opens when you click **Transfer** based on whether the payment's payment event is associated with at least one distribution detail or not.

Transfer Payment (No Distribution Details Exist)

Payment transfer causes the payment and its payment segments to be canceled and a new payment to be created. Transferring a payment is typically only done if the original distribution was targeted at the wrong account but all tender information for the pay event is correct. Unlike the [payment event transfer](#), transferring a single payment does not affect the pay event's tender information.

You must specify the following parameters in the **Payment Transfer** window to transfer a payment:

- **Account ID** is the account to which the payment should be transferred.
- **Cancel Reason** defines why you are performing the transfer.
- **Match Type** and **Match Value** are defaulted based on their values for the payment event that you are transferring. If necessary, modify the values appropriately for the account to which you are transferring the payment event. Match Type and Match Value are used for an account that belongs to an [open item](#) customer class or to restrict the distribution of the payment to a specific service agreement. Refer to [Payment Event - Main](#) for more information.
- Turn on **Freeze Payment** if the transferred payment should be frozen automatically. You may want to leave this turned off if you want to examine the payment distribution before freezing the payment.
- **Non CIS Name**, **Reference Number**, and **Non CIS Comments** appear if the **Account ID** belongs to a customer class that is used for non-CIS payments. Refer to [Setting Up Customer Classes](#) for more information.

Clicking **OK** causes the following to take place:

- The original payment and its segments are cancelled.
- A new payment is added for the transfer to account. The payment characteristics associated with the original payment are copied to the new payment.
- The payment is distributed amongst the new account's service agreements.
- If so designated, the new payment is frozen.

Transfer Payment (Distribution Details Exist)

Payment transfer causes the payment to be canceled and new payment(s) to be created using new payment event distribution rule(s). Transferring a payment is typically done when a payment event has multiple payments and one or more payments have been assigned to the wrong SA. Each of the incorrectly directed payments can be transferred to the correct SA(s) using the **Transfer via Distribution Rules** dialog.

Total Amount is the total payment amount to transfer from.

You must specify the following parameters in order to transfer a payment:

- **Distribution Rule** is the service agreement to which the payment should be transferred.
- **Rule Value** is the value associated with the payment and expected by the distribution rule.
- **Amount** is the payment amount.
- **Cancel Reason** defines why you are performing the transfer.

Clicking **OK** causes the following to take place:

- The payment associated with the original account is canceled.
- The new set of distribution details is processed, creating new payment(s) for the transfer-to service agreement(s). The payment characteristics associated with the original payment are copied to the new payment.
- The new set of distribution details is added to the payment event. The original distribution details are kept.

NOTE:

Distribution rule entries can have a zero amount. Refer to [Rule Value Can Capture Additional Information](#) for more information about how to use distribution details to capture additional payment related information.

Determine Tender Account. This dialog does not call the Determine Tender Account algorithm defined on [distribution rule](#) as this action does not rebuild the payment tender collection.

Delete (A Payment)

The **Delete** button deletes a payment. This button is enabled if the payment is Incomplete, Error, or Freezable.

Payment Portal

The base package is shipped with a configured payment portal that can be used for payment processing. The portal supports the following functionality that is not supported in the base [Payment Event - Add Dialog](#):

- Processing of payments that require authorization (i.e. credit card payments)
 - Creating non CIS payments based on payment templates
 - Processing payment tenders in alternate currencies
-

FASTPATH:

Refer to [The Big Picture of Portals and Zones](#) in the *Oracle Utilities Application Framework Administration Guide* for a description of portal and zone functionality.

Credit Card Payments

The payment portal provides the functionality needed for posting and authorizing customers' credit card charges in real-time. If the credit card authorization is successful, the payment will be added automatically (assuming you selected the appropriate payment freeze action via the portal).

FASTPATH:

Refer to [How To](#) for instructions describing how to add a payment that requires authorization.

Non CIS Payments

The payment portal allows you to add non-CIS payments using a payment template. Payment Templates can be configured for common types of payment allocations to pre-populate the payment distribution, allowing non-CIS payments to be directly allocated against the appropriate distribution codes.

FASTPATH:

Refer to [How To](#) for instructions describing how to add a non-CIS payment using a payment template.

Alternate Currency Payments

The payment portal allows you to process a payment tender remitted in an alternate currency. The system enables conversion of the tendered amount into the account's currency.

FASTPATH:

Refer to [How To](#) for instructions describing how to process a payment in an alternate currency.

How To

The topics in this section describe how to perform common payment maintenance functions.

How To Add A New Payment Event

There are several ways to add a new event:

- You can use [Payment Quick Add](#) to quickly add one or more payment events. You'd use this approach to add simple payments where no manual intervention is required. By "simple payment" we mean:
 - The account is both the tendering account and the account whose debt is being relieved by the payment
 - The payment date is the current date
 - The payment should be [distributed](#) amongst the account's service agreements using standard distribution logic
- If applicable to your business practice, you can use [Payment Event Quick Add](#) to quickly add one or more payment events using [distribution rules](#).
- You can use [Payment Event Maintenance](#) to add a payment event. You would use this approach if multiple forms of payment are remitted (e.g., cash and a check) or if there are multiple payors and/or payees linked to the payment event.

NOTE:

By default the system opens the [Payment Event - Add Dialog](#) when you navigate to this page in add mode. If you have opted to always use the payment event distribution rules method as your [default method](#), the [Payment Event Quick Add \(Single Payment Event\)](#) page appears instead. Refer to these pages for more information.

How To Cash A Check

If you allow customers to cash checks, you'll have a payment event with two tenders:

- The first tender contains information about the check.
- The second tender contains information about the cash refund (the tender amount is a negative amount equal to the amount of the check).

The interesting aspect of this payment event is that it has no payments because the sum of the tenders is zero.

We start this explanation in the middle of [How To Add A New Payment Event](#).

In the **Payment Event Add** dialog, be sure to select Do Not Distribute before clicking **OK**.

- On the **Main** page, click - to remove the payment (cashing a check is a payment event with no payments).
- Transfer to the **Payment Event, Tenders** page.
- **Insert** a row in the tender scroll (click the + button) for the cash refund tender. In this row enter a tender type of "cash" and a tender amount of negative the check amount.
- Save the event (note there is nothing to distribute or freeze).

How To Allocate The Tender Amount To Multiple Accounts

When you add a payment event, the system automatically creates a single payment for the account that remitted the funds. If someone is remitting funds for someone other than themselves, you must change/add payments. This section describes how to do this.

NOTE:

This section assumes you chose to add the payment event using the [Payment Event - Add Dialog](#). Refer to [How To Add A New Payment Event](#) for the complete list of options.

In the [Payment Event - Add Dialog](#), be sure to select Do Not Distribute before clicking **OK**.

On the payment event Main page, do the following:

- If the remitting account shouldn't have received any part of the payment, **Remove** it from the payments grid by clicking the - button. Alternatively, you can just change the account id to reflect the recipient.
- If multiple accounts receive the remitted funds, **Insert** one row in the payments grid (click the + button) for each additional account.
- When the payment event is balanced, **Save** it. Then **Distribute** and **Freeze** the payment(s). Refer to [Payment Event Actions](#) for more information on these action buttons.

How To Print Receipts And Endorsements

The system can be configured to allow you to endorse checks and print receipts using special cashiering station printers. This section describes the print options available.

NOTE:

These options are only available if they have been installed in your system. Installing these options are a delivery and installation issue and are not within the domain of this document. Refer to the Receipt Printing section of the Optional Products Installation Guide for information on how to enable these print options.

The print functions are available from the [Payment Event](#), [Payment Quick Add](#) and [Payment Event Quick Add](#) transactions. Refer to those sections for more information.

The print dialog functions are described below.

Description of Page

Use the **Endorse** button to endorse checks using the cashier station printer. This is only enabled if at least one tender type is not like cash and does not generate an automatic payment. If there are multiple checks, use the scroll buttons to select them. Feed the appropriate check in the printer and an endorsement message is printed on the back.

Use the **Receipt** button to print a receipt using the cashier station printer. Choose a **Short** or **Long** option. Use the **Duplicate** button to print a duplicate receipt. This prints the receipt with a "Duplicate" label.

Use the **Stub** button to print special information in bill stub format (e.g. account, name, amount). Feed a slip of paper into the printer and the special stub information will be printed.

NOTE:

The various text strings that are printed on the receipt and the endorsement are defined on the Payment Receipt Message and Endorse Message messages on the Point Of Sale (POS) Printer Integration master configuration. Refer to the master configuration's embedded help for more details.

The Stub function is available only on the Payment Event page.

Refer to the Optional Products Installation Guide for details on the print BPA script samples provided in base and for sample printouts using these scripts.

How To Cancel A Tender

If a tender is no longer valid (e.g., a check bounces), the tender must be canceled. The following steps explain how to do this.

WARNING:

These steps only make sense in the context of the page used to maintain tenders. Refer to [Payment Event - Tenders](#) for the details.

You navigate through the pages as follows:

1. Open the payment event - tenders page for the tender in question. Proceed to step 2.
2. Click **Cancel**. Proceed to step 3.
3. Before the system cancels the tender, you must specify the cancel reason. The tender cancel window opens.

In the tender cancel window, select a **Cancel Reason** to describe why the tender is being canceled. The system also needs to know which **Bank Account To Charge** the cancellation against. The system will default the **Bank** and **Bank Account Key** from the original bank information used when the tender was deposited. You can override them here.

When you click the **OK** button, the system cancels the tender and ALL payments linked to the event.

If the cancellation reason you supply is indicated as being "non-sufficient funds", the system will generate an adjustment to levy a NSF charge. Refer to [SA Type - Main Information](#) for more information.

NOTE:

When non-canceled tenders are still linked to the event. If there are multiple tenders linked to the payment event, you must either add new payment(s) that equal the sum of the event's non-canceled tenders or cancel the remaining tenders.

Cancellation after cash back. If a customer tenders a check for \$100, but only owes \$80, the system will recommend returning \$20 in cash to the customer (assuming the tender type for checks allows overpayment). If the tender type for checks is not "like cash", a second tender is created for -\$20 (the first tender is for \$100). If the check subsequently bounces, both tenders must be cancelled.

How To Transfer A Payment From One Account To Another

If you need to transfer a payment amount from one account to another, you can use the **Transfer** button either on the payment event page or the payment page.

FASTPATH:

Refer to [Transferring A Payment](#) for a description of when to use each option.

How To Distribute A Payment To A Specific Service Agreement

When you click **Distribute**, the system uses the payment distribution algorithm defined on the account's customer class to allocate the payment amongst the account's service agreements. In this section, we describe how to override this distribution (e.g., when you need to allocate a payment to specific service agreement(s)).

We start this explanation in the middle of [How To Add A New Payment Event](#).

In the **Payment Event Add** dialog, be sure to select Do Not Distribute before clicking **OK**.

- **Save** the payment event (this also saves the payment and tender information).
- Use the **Payment Amount** context menu to transfer to the **Manual Distribution** page.
- Fill in the desired **Distributed Amt** for each service agreement and save the payment.
- Click **Freeze** to freeze the payment when the amount distributed is equal to the payment amount.

How To Get An Unbalanced Tender Control In Balance (Fixing Over/Under)

In order to balance a tender control that is out-of-balance, you must create a tender for an account associated with your company.

NOTE:

The over / under account. Your organization must set up a company-use account with a service agreement whose SA type references the over/under distribution code. This account should be linked to the person ID associated with company usage.

- If you have more money in the drawer than you have tenders, then you're "over". In this situation, you need to record a payment for the "over" amount and the tender type configured for cash drawer over/under amounts. This will cause cash to be debited by the over amount, and the expense account associated with the account's service agreement to be credited.
 - If you have less money in the drawer than you have tenders, then you're "under". In this situation, you need to record a negative payment for the "under" amount and the tender type configured for cash drawer over/under amounts. This will cause cash to be credited by the over amount, and the expense account associated with the account's service agreement to be debited.
-

IMPORTANT:

A separate tender type is used for recording cash drawer over/under amounts. Once the over/under amount has been determined, you must enter a new tender using your over/under tender type for the company-use account. Check out the following table for an example:

Tender Type	Starting Balance	Tenders Received	Turn Ins	Actual Ending Balance (Entered by Cashier)	Expected Ending Balance	Over/Under Amount
Cash	\$150.50	\$5,000	\$4,000	\$1151	\$1150.50	Over \$0.50
Check	-	\$1,000	\$750	\$249	\$250	Under \$1

Over/Under	-	\$-0.50	-	-	\$-0.50	Over \$0.50
------------	---	---------	---	---	---------	-------------

In this example, you'd have to create a new tender for the company-use account for the amount that will be distributed to the company-use account's service agreement (debit over/under expense, credit cash):

- Tender type: Over/Under, Tender amount: -\$0.50

NOTE:

You must reopen the tender control. Before you can add an over/under tender to a tender control, you must re open the tender control (tenders may only be added to open tender controls).

How To Add A Non-CIS Payment Using A Template

The payment portal allows you to add non-CIS payments using a payment template. Payment Templates can be configured for common types of payment allocations to pre-populate the payment distribution and allowing non-CIS payments to be directly allocated against distribution codes. The following steps explain how to do this.

You navigate through the pages as follows:

- Open **Menu > Financial > Payment Portal**.
- The **Add Non CIS Payment Zone** shows a list of all active payment templates. Use the **Add** button to add a non-CIS payment for a specific payment template.
- Enter the payment and tender details (**Payment Amount**, **Payment Date** defaults to the current date, **Tender Source** is used to find an open tender control when adding the tender).

NOTE:

Authorizing Tenders. If the **Tender Type** selected requires authorization (i.e. credit card payments), additional authorization details are required (e.g. credit card type, credit card number, etc.). Only one tender that requires authorization can exist for a single payment event.

FASTPATH:

For information about tender types requiring authorization, refer to [How To Authorize A Credit Card Tender](#).

- Enter the non-CIS information for the customer remitting the payment (**Customer Name**, **Agreement Number** and **Comments** to describe anything unusual about the non CIS payment).

NOTE:

Payor Account ID. The Non CIS Account Id specified on the payment template is used as the tendering account. If the account has exceeded your [cash-only threshold](#) and the **Tender Type** isn't marked as "like cash", a warning appears advising of such.

Including a CIS payment. If a portion of the tender is for a CIS payment, ensure that the **Add CIS Payment** checkbox is selected. The system will process the non-CIS payment, and then navigate the user to the Payment Event page where the CIS payment can be included.

- The distribution details are defaulted from the payment template but may be overridden. You can add additional distribution lines. Enter the payment amount and Reference Number for each applicable distribution line.
- When you click the **OK** button, the system creates the payment event and tender(s). A single payment is created for each non-zero amount entry in the distribution details list. The payment template is captured as a characteristic on the tender. The corresponding distribution code, GL account and reference number are captured as characteristics on each payment.

When the financial transactions are created for these payments, the distribution code (and GL account) is retrieved from the payment characteristic collection.

How To Authorize A Credit Card Tender

You can use the Payment Portal to add a payment event for a tender that requires authorization. The following steps explain how to do this.

If your organization is using the base tender authorization functionality, you can navigate through the pages as follows:

- Open **Menu > Financial > Payment Portal**.
- The **Add CIS Payment** zone only expands if there's an account in context. To expand this zone, either search for an account using Control Central or use the Tender Search available on the **Payment Portal**.
- Use the **Add Payment** button to add a payment for the account displayed in the zone.
- The information displayed is the same as that on the [Payment Event - Add Dialog](#), except for the following:
 - Use **Distribute Action** to describe what you'd like to have happen when you click the **OK** button. The dropdown contains the following values - Distribute and Freeze if OK, Manual Distribution and Manual Distribution - Multiple Payments

NOTE:

The **Distribute and Freeze if OK** and **Manual Distribution** options are also present on the **Distribute Action** on the payment event add dialog screen. The third option, **Manual Distribution - Multiple Payments**, is special for credit card authorization processing. This option is similar to the **Manual Distribution** option except that the user is navigated to the **Payment Event** maintenance page after authorization has taken place.

-
- If the **Tender Type** selected requires authorization (e.g., credit card payments), additional authorization details are required (e.g. credit card type, credit card number, etc.). This information is displayed in the **Credit Card Information** section.

NOTE:

Authorizing Tenders. Only one tender that requires authorization can exist for a single payment event.

-
- The **Authorization Override** checkbox is only displayed if the tender type selected requires authorization. Use the **Authorization Override** checkbox to indicate whether or not tender authorization should take place. If **Authorization Override** is checked, an authorization code must be entered and the system bypasses the authorization web service call.
 - Click **OK to save the payment and navigate to the appropriate page**.
 - Assuming the credit card is accepted, the authorization code returned by the credit card authorization provider is captured as a tender characteristic.
 - If the credit card is declined, the tender will not be added.

How To Reverse A Credit Card Tender

The steps required to reverse a credit card tender are the same as the steps for [How To Cancel A Tender](#).

The reversal code from the credit card authorization service is stored as a tender characteristic.

FASTPATH:

For more information on authorizing credit card payments, refer to the following business objects: Tender Type - Credit Card with Authorization, CyberSource - Credit Card Authorization and CyberSource - Credit Card Reversal.

How To Process An Alternate Currency Payment

You can use the Payment Portal to add a payment event for a tender(s) in an alternate currency, i.e. a currency that differs from the account's currency. The following steps explain how to do this.

- **Open Menu > Financial > Payment Portal.**
- The **Add CIS Payment Zone** only expands if there's an account in context. To expand this zone, either search for an account using Control Central or use the Tender Search available on the **Payment Portal**.
- Use the **Add Payment** button to add a payment for the account displayed in the zone.
- The information displayed is the same as that on the [Payment Event - Add Dialog](#), except for the following:
 - If your organization accepts payment tenders in alternate currencies, the **Currency Converter** button appears in the tender list
- Use the **Currency Converter** button to enter the **Tendered Amount** and **Tendered Currency** in the alternate currency and click **OK**. The system will convert the alternate currency amount to the account's currency.
- Click **OK** to save the payment and navigate to the appropriate page.
- When you click the **OK** button, the system creates the payment event and tender(s). Each tender is linked to an appropriate tender control based on the currency of the tender.

FASTPATH:

Refer to [Alternate Currency Payments](#) for more information.

Financial Transactions On A Payment

Open **Menu > Financial Query > Financial Transactions On A Payment** to view the financial transactions on a payment.

NOTE:

You can also open this page using the go to buttons that prefix the financial transaction summaries on [Payment - Main](#).

Description of page

Payment Id is the system-assigned unique identifier of the payment.

Account ID is the payment's account.

The area beneath **AccountID** provides you with options that control which financial transactions appear in the grid. The following points describe the various options:

- Use the **SA Filter** to define the types of service agreements whose financial transactions appear in the grid. The following options are available:
 - **Address.** Use this option to restrict financial transactions to those whose service agreements are linked to service points associated with a given **Address, City** and/or **Postal** code.
 - **All.** Use this option if you do not wish to restrict financial transactions based on service agreement attributes.

- **Geographic Type.** Use this option to restrict financial transactions to those whose service agreements are linked to service points associated with a given **Geo Type** and **Value**.
- **SA ID.** Use this option to restrict financial transactions to those of a specific service agreement.
- **SA Type.** Use this option to restrict financial transactions to those whose service agreements are linked to a given **CIS Division** and **SA Type**.
- Use **Match Event Status Filter** to restrict the financial transactions based on the status of their [match event](#). This filter only appears if the payment's account is an [open-item](#) customer. The following options are available:
 - **All.** This option shows all financial transactions.
 - **Balanced.** This option shows all financial transactions whose match event is balanced.
 - **Disputed.** This option shows all financial transactions whose match event is disputed.
 - **Unbalanced.** This option shows all financial transactions whose match event is unbalanced.
 - **Unmatched.** This option shows all financial transactions that are not linked to a match event.

WARNING:

Don't forget to click the search button after changing the filters or after selecting a new Payment Id.

The grid that follows contains the financial transactions that match your search criteria. The following information is displayed:

- **Match Event Status** shows the status of the financial transaction's [match event](#). This column only appears if the account is an [open-item](#) customer.
- **FT Type** displays the type of financial transaction. Click on the hyperlink to transfer to [Financial Transaction - Main](#). On this page, you can change certain aspects of the FT in question.
- **Accounting Date** is the date the system uses to determine the financial transaction's accounting period in your general ledger.
- **Current Amount** contains the financial transaction's effect on the service agreement's current balance.
- **Payoff Amount** contains the financial transaction's effect on the service agreement's payoff balance. The **Payoff Amount** will be dim if it equals the **Current Amount**.
- **Show on Bill** indicates if information about the financial transaction appears on the customer's bill.
- **SA Information** contains a summary of the respective service agreement.
- **Financial Transaction ID** is the system-assigned unique identifier of the financial transaction.

At the bottom of the page is a summary of the financial transactions that match the search criteria.

Payment History

The payment history page shows all payments that have been distributed to an account's service agreements. Open this page using **Menu > Financial Query > Account Payment History**.

Description of Page

One row is displayed for every payment that has been distributed to an account's service agreements. The payment date, amount, payment status and the tender source associated with the tender's tender control are displayed for each payment.

NOTE:

Tender Source typically contains the description of the cash drawer in which the payment was made or the remittance processor that processed the payment. **Tender source** will be blank for automatic payments until they are interfaced to

the financial institution. Refer to [Downloading Automatic Payments](#) for more information about interfacing automatic payments.

If you need to see more detailed information about the payment, click the Go To button to transfer to the payment event page.

Payment Tender History

The **Payment Tender History** page shows a list of all tenders linked to an open tender control for the current user. Open this page using **Menu > Financial Query > Payment Tender History**.

Description of Page

One row is displayed for every tender that is linked to an open tender control to which the current user has access. The freeze date/time, payment date, pay tender ID, payor account, tender amount, tender type and tender status are displayed for each tender.

Payment / Tender Search

This page allows you to look for payments and/or tenders using a combination of search criteria. Open this page using **Menu > Financial Query > Payment / Tender Search**.

Description of Page

The top half of the page is where you enter the criteria used to search for payments and tenders.

NOTE:

Multiple search criteria may be specified. You can search for payments and tenders using a combination of search criteria. For example, if you enter both a **Payment Account** name of Brandon and a **Payment Amount** between 150 and 170; only those payments for customers named Brandon whose amount is between 150 and 170 will be displayed.

WARNING:

Try to be as specific as possible when entering search criteria. Why? Because entering open-ended search criteria may have a severe impact on response times. For example, if you know the payments you're looking for have a payment date sometime in January 2003 and the customer's name is Brazil,John, then enter both of these criteria. If you also know the payment amount is between 150 and 170, enter these values too.

The following table describes each of the different search methods.

Search Method	Description
Search for	Use this field to define if you're searching for Payments, Tenders or both Payments and Tenders. The value entered in this field controls which of the remaining search methods are enabled.
Distribution Rule	Use this field if you're searching for a tender or a payment and know the distribution rule and value used to created it. Note. This section appears only if you have configured your system to allow the payment event distribution rules method to be used.

Payment Account

Use this field if you're searching for a payment and know the account ID or the name of any person linked to the account whose debt is relieved by the payment.

- If you know the payment's account ID, first choose Account in the adjacent dropdown and then enter the account's ID. You must enter all of the account ID.

- If you know the name of any person linked to the account, first choose Person Name in the adjacent dropdown and then enter the person's name. You can enter all or part of the person's name (the more you enter, the faster the search will be). The name search is not case sensitive.

A search method of Person Name defaults.

If you leave the person name or ID blank, the system ignores this search method.

These fields are protected if you've selected a **Search for** of Tender.

Payment Amount

Use this field if you're searching for a payment and know its amount.

- If you know the exact amount, first choose Equal To in the adjacent dropdown and then enter the amount.

- If you know the payment amount is between a given range of values, first choose Between and then enter the range of values.

A search method of Between defaults.

If you leave the amount(s) blank, the system ignores this search method.

These fields are protected if you've selected a **Search for** of Tender.

Payor Account

Use this field if you're searching for a tender and know the account ID or the name of any person linked to the tendering account.

- If you know the tender's account ID, first choose Account in the adjacent dropdown and then enter the account's ID. You must enter all of the account ID.

- If you know the name of any person linked to the tendering account, first choose Person Name in the adjacent dropdown and then enter the person's name. You can enter all or part of the person's name (the more you enter, the faster the search will be). The name search is not case sensitive.

A search method of Person Name defaults.

If you leave the person name or ID blank, the system ignores this search method.

These fields are protected if you've selected a **Search for** of Payment.

Tender Amount

Use this field if you're searching for a tender and know its amount.

- If you know the exact amount, first choose Equal To in the adjacent dropdown and then enter the amount.

- If you know the tender amount is between a given range of values, first choose Between and then enter the range of values.

A search method of Between defaults.

If you leave the amount(s) blank, the system ignores this search method.

	These fields are protected if you've selected a Search for of Payment.
Tender Source	<p>If you're searching for a tender and you know the source of the tender (e.g., the lockbox, cashier, etc.), enter the tender source code.</p> <p>A search method of Equal To defaults.</p> <p>If you leave the tender source blank, the system ignores this search method.</p> <p>These fields are protected if you've selected a Search for of Payment.</p>
MICR ID	<p>Use this field if you're searching for a tender and know its MICR (magnetic ink character recognition) ID.</p> <ul style="list-style-type: none"> - If you know the entire MICR ID, first choose Equal To in the adjacent dropdown and then and enter the entire MICR ID. - If you know the first X characters of the MICR ID, first choose Like in the adjacent dropdown and then and enter the entire MICR ID. <p>A search method of Like defaults.</p> <p>If you leave the MICR ID blank, the system ignores this search method.</p> <p>These fields are protected if you've selected a Search for of Payment.</p>
Payment Date	<p>Use this field if you're searching for a tender or a payment and know its date.</p> <ul style="list-style-type: none"> - If you know the exact date, first choose Equal To in the adjacent dropdown and then enter the date. - If you know the date is between a given range of values, first choose Between and then enter the date range. <p>A search method of Between defaults.</p> <p>If you leave the date(s) blank, the system ignores this search method.</p>

The system shows the total number of payments / tenders that satisfy your search results immediately below the grid.

The first group of payments / tenders is displayed in the grid at the bottom of the page. Different columns appear in the grid depending on the value of **Search for**.

- If you use a **Search for** of Payment, only payment-oriented columns appear in the grid.
- If you use a **Search for** of Tender, only tender-oriented columns appear in the grid.
- If you use a **Search for** of Payment and Tender, both payment-oriented and tender-oriented columns appear in the grid.

WARNING:

If you use the Payment and Tender search method, and the resultant tenders / payments are linked to payment events that have multiple payments or tenders, multiple rows may be displayed for the payment event's tenders and payments. For example, if a tender with multiple payments is selected, a separate row will be displayed for every payment that matches your payment search criteria. If you don't specify any payment search criteria, a row will be displayed for every payment linked to the tender.

Payment Date This contains the date of the payment event associated with the payment / tender. This column appears regardless of the value of **Search for**.

Payment Account Info This contains a concatenation of important information about the account whose debt was relieved by the payment. This column does not appear if you use a **Search for** of Tender .

Payment Amount This contains the amount of the payment. This column does not appear if you use a **Search for** of Tender.

Payment Status This contains the status of the payment. Refer to [Payment Lifecycle](#) for more information. This column does not appear if you use a **Search for** of Tender.

Payment ID This contains the unique identifier of the payment. This column does not appear if you use a **Search for** of Tender.

Payor Account Info This contains a concatenation of important information about the account who tendered the payment. This column does not appear if you use a **Search for** of Payment .

Tender Amount This contains the amount of the tender. This column does not appear if you use a **Search for** of Payment.

Tender Source This contains the source of the tender of the tender. This column does not appear if you use a **Search for** of Payment.

MICR ID This contains the MICR (magnetic ink character recognition) ID of the tender. This column does not appear if you use a **Search for** of Payment .

NOTE: The system supports encryption for MICR ID. If your implementation has configured the system to encrypt MICR ID, the data will be displayed with a masked value; such as, *****. Refer to [Encrypting Sensitive Data](#) for more information.

Tender Status This contains the status of the tender. Refer to [Tender Lifecycle](#) for more information. This column does not appear if you use a **Search for** of Payment.

Pay Tender ID This contains the unique identifier of the tender. This column does not appear if you use a **Search for** of Payment.

Pay Event ID This contains the unique identifier of the payment event.

Maintaining Deposit Controls

Deposit controls exist to give you administrative control over your cash drawers (and all other tender sources) and the subsequent deposit of funds at banks.

FASTPATH:

Refer to [Tender Management and Workstation Cashiering](#) for background information.

NOTE:

The system creates most deposit controls behind-the-scenes. Most deposit controls are created by the system when it processes tenders from your remittance processor and lock boxes. You should only have to access the deposit control pages if you record payments in cash drawers. For information about how the system creates deposit controls, refer to [Managing Payments Interfaced From External Sources](#). Also note that the automatic payment activation process also creates tender and deposit controls. Refer to [Activating Automatic Payments](#) for more information.

The Lifecycle Of A Deposit Control

The following diagram shows the possible lifecycle of a deposit control.

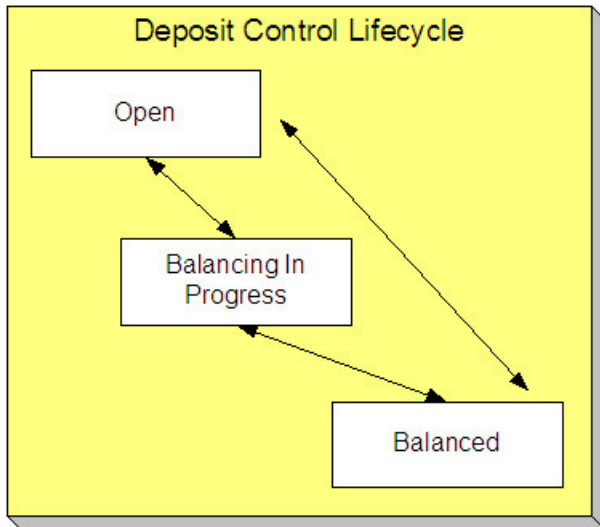

Open A deposit control is initially created in the Open state. While in this state, you may add new deposits to it, change the deposit amount on its deposits, and transfer tender controls into and out of it.

Balancing In Progress You change a deposit control's status to Balancing In Progress when you're ready to balance its contents. While in this state, you can change the deposit amount on its deposits and transfer tender controls out of it. If you need to add new deposits to it or transfer tender controls into it you must return it to the Open state.

Balanced You change a deposit control's status to Balanced when the sum of its tender controls is consistent with the total of its deposits. While in this state, you cannot modify its deposits or its tender controls. If you need to make modifications, you must return it to the Open or Balancing In Progress state.

NOTE:

Background processes and state transition. When payments are interfaced from external sources, the system automatically creates a deposit control and links a tender control to it. When all payments have been successfully loaded, the system changes the state of the respective deposit control to Balanced.

Deposit Control - Main

The Main page contains core deposit control information. Open this page using **Menu > Financial > Deposit Control > Search**.

Description of Page

Deposit Control contains a concatenation of the deposit control's creation date, tender source type, and status.

Deposit Control ID is the system-assigned, unique identifier of the deposit control.

User is the person who created the deposit control.

Create Date/Time is the date and time the deposit control was created.

Tender Source Type is the type of tender control that has been linked to the deposit control. Valid values are: Ad hoc, Auto Pay, Online Cashiering and Lockbox. The system uses this information to prevent tender controls from different sources from being included under the same deposit control. In other words, you can't mix automatic payment, cashiering and lockbox tenders under the same deposit control.

Currency Code is the currency in which the deposit control's tenders are denominated.

NOTE:

Default note. The currency code defaults from the installation record.

The summary information that follows contains a summary of the starting balance and the tenders that are linked to the tender control.

- **Starting Balance** is the sum of the starting balances from all tender controls linked to the deposit control.
- **Total TendersAmount** is the sum of tenders from all tender controls linked to the deposit control.
- **Total Tender Controls** is the number and amount of tender controls linked to the deposit control.
- **Total Tender Deposits** is the number and amount of tender deposits linked to the deposit control.
- **Expected Ending Balance** is the **Total Tender Control** minus **Total Tender Deposits**.
- **Ending Balance** is the actual amount of money in the tender control minus the deposit tender amount. This amount must equal the **Expected Ending Balance** before the tender control can be marked as **Balanced**.
- **Outstanding Over/Under** is **Ending Balance** minus **Expected Ending Balance**.

Deposit Control Status shows the status of the deposit control. Valid values are Open, Balanced, and Balancing In Progress.

FASTPATH:

For more information, refer to [The Lifecycle Of A Deposit Control](#).

The **Balanced User ID** and **Balanced Date/Time** are populated when the status is changed to **Balanced**.

Use **Comments** to describing anything unusual about the deposit control.

Deposit Control - Tender Control

The Tender Control page contains a row for every tender control linked to the deposit control. Open this page using **Menu > Financial > Deposit Control > Search** and navigate to the **Tender Control** page.

Description of Page

Deposit Control contains a concatenation of the deposit control's creation date, tender source type, and status.

Deposit Control ID is the system-assigned, unique identifier of the deposit control.

The grid that follows contains a row for every tender control linked to the deposit control. No information about the tender controls may be modified on this page. To view or modify tender control information, click the Go To button.

Deposit Control - Tender Deposit

The Tender Deposit page contains a row for every tender deposit linked to the deposit control. Open this page using **Menu > Financial > Deposit Control > Search** and navigate to the **Tender Deposit** page.

Description of Page

Deposit Control contains a concatenation of the deposit control's creation date, tender source type, and status.

Deposit Control ID is the system-assigned, unique identifier of the deposit control.

The **Tender Deposit** scroll that follows contains one row for every financial institution into which the tenders will be deposited. To insert a new row, click the + button and fill in the following fields:

- **Tender Deposit ID** is maintained by the system. When a deposit is being created, there is no ID number displayed. Once a deposit is entered and saved, the system generates an ID and displays it here.

- **Deposit Amount** contains the amount to be deposited at the bank. **Currency Code** is the currency in which the deposit is denominated.
- **Reference ID** contains the ID of the deposit (if any).
- Use **Bank** and **Bank Account** to define where the tenders will be deposited.

Deposit Control - Turn Ins

The Turn Ins page contains a row for every turn-in event linked to the deposit control. Open this page using **Menu > Financial > Deposit Control > Search** and navigate to the **Turn Ins** page.

FASTPATH:

Refer to [Turn Ins](#) for background information.

Description of Page

Deposit Control contains a concatenation of the deposit control's creation date, tender source type, and status.

Deposit Control ID is the system-assigned, unique identifier of the deposit control.

The turn-ins grid contains one row for every turn-in event associated with the deposit control. A turn-in event is created when moneys originally deposited in respect of a tender control are turned in to the tender control's deposit control. Turn-in events are created and maintained on the [Tender Control - Turn Ins](#) page. Refer to [Turn Ins](#) for background information. The following information is displayed in the grid:

- **Turn In Status** defines if it is a new turn in Awaiting approval or has been Approved by the operator who is responsible for the Deposit Control. Once the turn-in is Approved, this field becomes display-only.
- **Tender Type** is the type of tender that has been turned in. This is a display-only field.
- **Turn In Amount** is the amount of the **Tender Type** that has been turned in. This is a display-only field.
- **Receipt Number** is the ID of the receipt given to the person who turn-in the funds. This is a display-only field.
- **Create Date/Time** contains when the turn-in event was created. This is a display-only field.

Deposit Control - Characteristics

To update deposit control characteristics, open **Menu > Financial > Deposit Control > Search** and navigate to the **Characteristics** page.

Description of Page

Deposit Control contains a concatenation of the deposit control's creation date, tender source type, and status.

Deposit Control ID is the system-assigned, unique identifier of the deposit control.

The **Characteristics** collection contains information that describes miscellaneous information about the deposit control.

The following fields display:

Characteristic Type Indicate the type of characteristic.

Sequence Controls the order in which characteristics of the same type are displayed.

Characteristic Value Indicate the value of the characteristic.

Maintaining Tender Controls

Tender controls exist to give you administrative control over your cash drawers (and all other tender sources).

FASTPATH:

Refer to [Managing Your Cash Drawers](#) for more information.

NOTE:

The system creates most tender controls behind-the-scenes. Most tender controls are created by the system when it processes tenders from the remittance processors and lock boxes. You should only have to access the tender control pages if you record payments in cash drawers. For information about how the system creates tender controls, refer to [Managing Payments Interfaced From External Sources](#). Also note that the automatic payment activation process also creates tender and deposit controls. Refer to [Activating Automatic Payments](#) for more information.

The Lifecycle Of A Tender Control

The following diagram shows the possible lifecycle of a tender control.

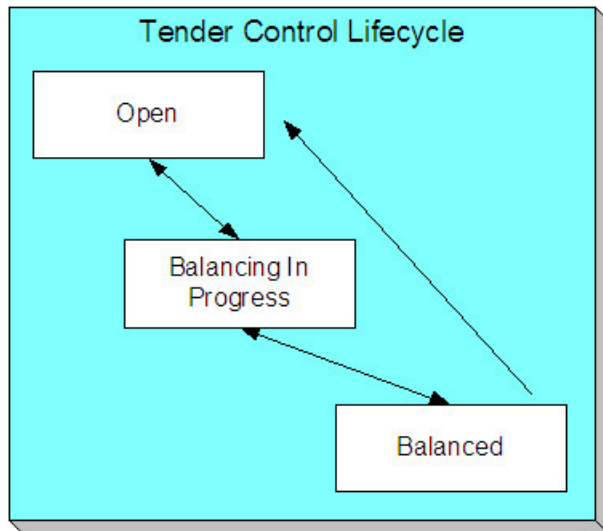

Open A tender control is initially created in the Open state. While in this state, you may add new tenders to it, change the tender amount on its tenders, and transfer tenders into and out of it.

Balancing In Progress You change a tender control's status to Balancing In Progress when you're ready to balance its contents. While in this state, you can change the tender amount on its tenders and transfer tenders out of it. If you need to add new tenders to it or transfer tenders into it, you must return it to the Open state.

Balanced You change a tender control's status to Balanced when the sum of its tenders is consistent with the ending balance in the drawer. While in this state, you cannot modify it or its tenders. If you need to make modifications, you must return it to the Open or Balancing In Progress state.

If the tender control is part of a Balanced deposit control, you may not change its status.

NOTE:

Background processes and state transition. When payments are interfaced from external sources, the system automatically creates a tender control and links tenders to it (one for each payment interfaced). When all payments have been successfully loaded, the system changes the state of the respective tender control to Balanced.

Tender Control - Main

The Main page contains core tender control information. This page is used to balance the tender control.

Open this page using **Menu > Financial > Tender Control > Search.**

NOTE:

Searching For Tender Controls. When you use the **Creation Date** to search for tender controls, the system returns tender controls that are created on or before the date you specify. If the number of records returned exceeds the search limit (i.e. 300 records), only the records that do not exceed search limit are displayed. Therefore, you may need to specify an earlier creation date to find the record you are looking for. If you do not specify a creation date and search based on other criteria, the system uses the most recent date.

FASTPATH:

Refer to [Managing Your Cash Drawers, Turn Ins](#) and [Balancing By Tender Type](#) for more information.

Description of Page

Tender Control contains a concatenation of the tender control's creation date, tender source, and status.

Tender Control ID is the system-assigned, unique identifier of the tender control.

Tender Source is the source of the tenders (e.g., cash drawer 22, lockbox 1 at Bank of America).

Deposit Control ID is the system-assigned, unique identifier of the deposit control that the tender control is part of. The deposit control's **Currency Code** is displayed below.

FASTPATH:

For more information about deposit controls and tender controls, refer to [Managing Your Cash Drawers](#).

Turn on **All Users** if any user may insert tenders into this tender control. Turn this switch off and specify the appropriate **User ID** if only a single user may insert tenders into this tender control.

Create Date/Time is the date and time the tender control was created.

The **Starting Balance** of the tender control is defaulted from the tender source. This may be overridden while the **Tender Control Status** is Open or Balancing in Progress.

The **Tender Control Status** shows the status of the tender control. The **Balanced User ID** and **Balanced Date/Time** are populated when the status is changed to Balanced.

FASTPATH:

For more information, refer to [The Lifecycle Of A Tender Control](#).

The **Balance** button is enabled when the **Tender Control Status** is Balancing in Progress. When this button is clicked, the system checks the following:

- All Turn-Ins have been Approved.
 - The sum of all **Ending Balances** equals the sum of all **Expected Ending Balances**.
-

If the above conditions are true, the status of the tender control is changed to Balanced and all modifiable fields become protected.

The tenders grid contains a summary of the tenders linked to the tender control. One row is displayed for each tender type. Each row contains the number of tenders of this type and their total amount. In order to Balance the tender control, you must enter an appropriate **Ending Balance** for each **Tender Type**. Refer to [Balancing By Tender Type](#) for more information. The following information appears in the grid:

- **Tender Type** represents the type of tender (e.g., cash, credit card). This is a display-only field.
- **Nbr of Tenders** contains the total number of tenders of this type in the tender control. This is a display-only field and is calculated by the system by accumulating the tenders linked to the tender control.
- **Total Tenders** contains the total amount of tenders of this type in the tender control. This is a display-only field and is calculated by the system by accumulating the tenders linked to the tender control. Navigate to the **Tenders** page to see the individual tenders.
- **Turn In Amount** contains the total amount of turn-ins of this type. This is a display-only field and is calculated by the system by accumulating the turn-ins linked to the tender control. Navigate to the **Turn Ins** pages to see the individual turn ins.
- **Starting Balance** contains the starting balance of this type of turn in. This field is only populated on the row defined as the Starting Balance tender type on the Installation Record. This is a display-only field and is equal to the tender control's **Starting Balance**.
- **Expected Ending Bal** is the **Starting Balance** plus **Total Tenders** minus **Turn In Amount** for this type of tender.
- **Ending Bal** is the actual amount of money of this tender type. The cashier must enter this field in order to balance the tender control. This field is protected unless the **Status** of the tender control is Balancing In Progress. This amount must equal the Expected Ending Balance before the tender control can be marked as Balanced. Refer to [How To Get An Unbalanced Tender Control In Balance \(Fixing Over/Under\)](#) for more information.
- **Outstanding Over/Under** is the difference between **Expected Ending Bal** and **Ending Bal**. This is a display-only field.

The summary information beneath the tender type grid contains a summary of the tenders that are linked to the tender control.

- **Total TenderAmount** is the total amount of all tenders linked to the tender control.
- **Ending Balance** is the actual amount of money in the tender control (as defined in the above grid).
- **Expected Ending Balance** is the expected amount of money in the tender control (as defined in the above grid).
- **Outstanding Over/Under** is Ending Balance minus Expected Ending Balance. If this amount is zero, the field is not displayed.

If the tender controls were created for a background process, such as the automatic payment extract, the following information is displayed:

- **Batch Code** is the batch code for which the tender control was created. This field only appears if it contains a value.
- **Batch Number** is the batch number for which the tender control was created. This field only appears if it contains a value.

Use **Comments** to describe anything unusual about the tender control (e.g., to explain why a large over/under amount was created).

Tender Control - Tenders

The Tenders page contains a row for every tender linked to the tender control. Open this page using **Menu > Financial > Tender Control > Search** and navigate to the **Tenders** page.

Description of Page

Tender Control contains a concatenation of the tender control's creation date, tender source, and status.

Tender Control ID is the system-assigned, unique identifier of the tender control.

This grid at the top of the page contains a row for every tender linked to the tender control. When first displayed, the grid is ordered by the Create Date/Time column. No information about the tenders may be modified. To view or modify tender information, click the Go To button.

The grid at the bottom of the page contains a summary by tender type of all tenders linked to the tender control.

Tender Control - Turn Ins

Every time you turn in funds to the deposit control that is associated with your tender control, you create a turn-in event using this page. Open this page using **Menu > Financial > Tender Control > Search** and navigate to the **Turn Ins** page.

FASTPATH:

Refer to [Managing Your Cash Drawers](#) and [Turn Ins](#) for more information.

Description of Page

Tender Control contains a concatenation of the tender control's creation date, tender source, and status.

Tender Control ID is the system-assigned, unique identifier of the tender control.

The turn-ins grid contains one row for every turn-in event associated with the tender control. A turn-in event is created when moneys are physically transferred to the deposit control associated with the tender control. Turn-in events are approved on the [Deposit Control - Turn Ins](#) page. The following information is displayed in the grid:

- **Turn In Status** defines if the turn-in is Awaiting Approval or has been Approved by the operator who is responsible for the Deposit Control. When a turn-in is first created, its status is Awaiting Approval and the following fields should be defined. Once the turn-in is Approved by the user responsible for the deposit control associated with the tender control, all of the following fields become display-only and the turn-in event cannot be deleted.
- **Tender Type** is the type of tender that has been turned in. This field may only be modified when the **Turn In Status** is Awaiting Approval.
- **Turn In Amount** is the amount of the **Tender Type** that has been turned in. This field may only be modified when the **Turn In Status** is Awaiting Approval.
- **Receipt Number** is the ID of the receipt given to the person who turn-in the funds. This field may only be modified when the **Turn In Status** is Awaiting Approval.
- **Create Date/Time** contains when the turn-in event was created. This is a display-only field.

Tender Control - Exceptions

This page contains an entry for every exception (i.e., error) associated with the tender control's payments and payment events. Open this page using **Menu > Financial > Tender Control > Search** and navigate to the **Exceptions** page.

FASTPATH:

Refer to [Exceptions](#) for more information.

Description of Page

This page contains an entry for every exception (i.e., error) associated with the tender control's payments and payment events.

Tender Control - Characteristics

To update tender control characteristics, open **Menu > Financial > Tender Control > Search** and navigate to the **Characteristics** page.

NOTE:

If your tender control is balanced, you cannot update tender control characteristics.

Description of Page

The **Characteristics** collection contains information that describes miscellaneous information about the tender control.

The following fields display:

Characteristic Type Indicate the type of characteristic.

Sequence Controls the order in which characteristics of the same type are displayed.

Characteristic Value Indicate the value of the characteristic.

Interfacing Payments From External Sources

Most payments are NOT added by an operator using the Payment Event page. Rather, they are interfaced from an external source (e.g., a lock box or a remittance processor).

The base-package provides two interfaces to upload payments, each based on a different method of creating payment events.

FASTPATH:

Refer to [Distributing A Payment Event](#) for more information about how payment event distribution is handled in the system.

The topics in this section describe how these payment interfaces work.

Interfacing Payments

The topics in this section describe how the payment interface using the system default method of creating payment events works.

Populating The Payment Upload Staging Records

The following diagram illustrates the processes involved in the uploading of payment into the system.

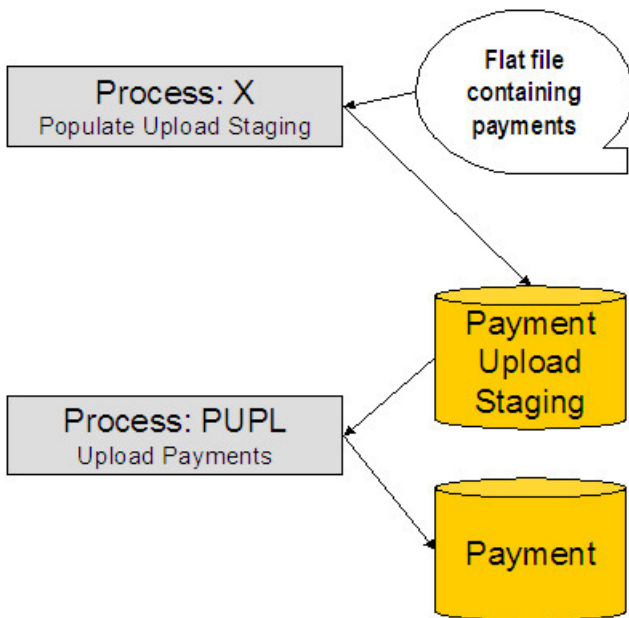

The topics in this section describe each background process referenced above.

Process X - Populate Payment Upload Staging

Process X refers to the mechanism used by your organization to populate the various staging tables (shown in the orange section of the following ERD).

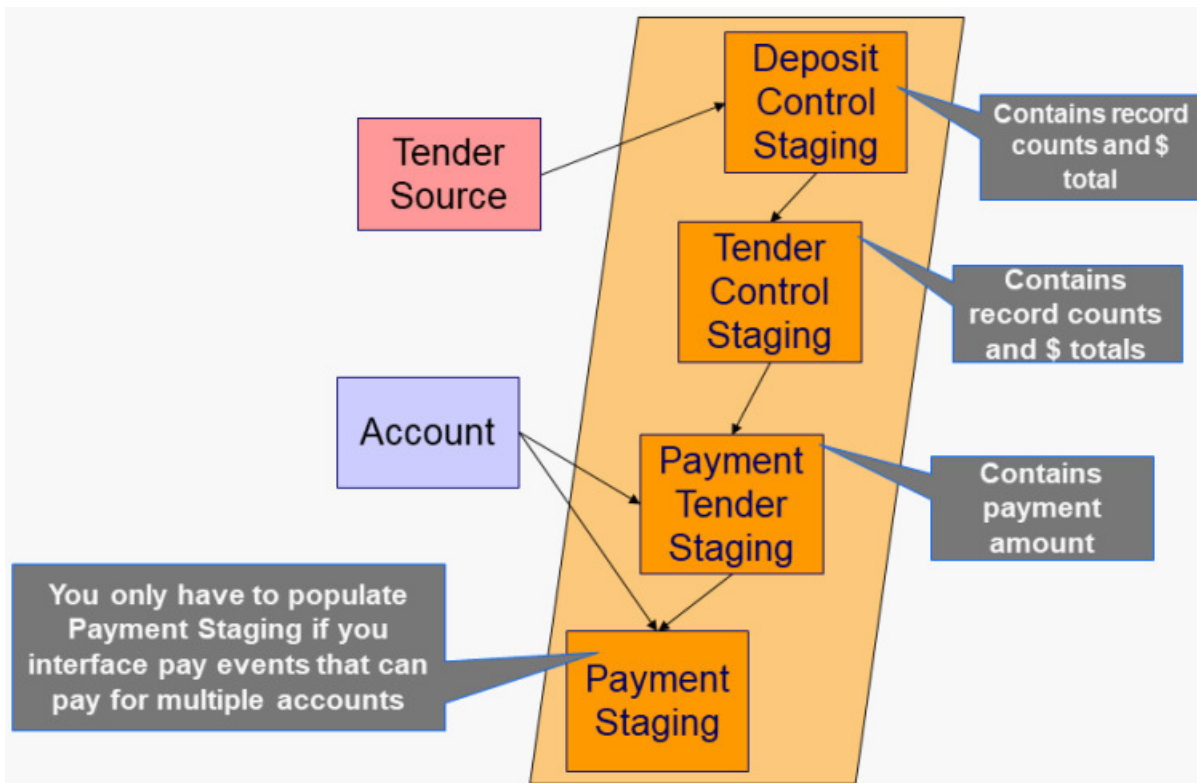

The following topics in this section describe each of these tables:

- [Deposit Control Staging](#)
- [Tender Control Staging](#)
- [Payment Tender Staging](#)
- [Payment Staging](#)

Deposit Control Staging

You must create a deposit control staging record for each batch of payments to be uploaded into the system. The name of this table is CI_DEP_CTL_ST. The following table describes each column on this table.

Column Name	Length	Req'd	Data Type	Comments
EXT_SOURCE_ID	30	Y	A/N	This must correspond with an external source ID on one of the defined tender sources. Refer to Setting Up Tender Sources for more information.
EXT_TRANSMIT_ID	50	Y	A/N	This is the unique identifier of the transmission from the external source. This must be a unique value for each transmission from the source.
DEP_CTL_STG_ST_FLG	2	Y	A/N	This must be set to 20 (20 is the lookup value that corresponds with the Pending state)
DEP_CTL_ID	10	N	N	Leave this column blank. It will be assigned by the system when it creates a deposit control record.
TRANSMIT_DTTM	15	Y	DateTime	Date and time that the file was transmitted.
CURRENCY_CD	3	Y	A/N	This must be a valid currency code (this would be USD for United States dollars).
TOT_TNDR_CTL_AMT	13.2	Y	N	This column must equal the sum of the payment amounts on the tender control staging records associated with this deposit control staging.
TOT_TNDR_CTL_CNT	10	Y	N	This column must equal the number of tender control staging records associated with this deposit control staging.
LAST_UPDATE_INST	10	N	N	This field is populated during the upload. It is

the process scheduler
instance ID of the process
performing the upload.

You must create one or more [Tender Control Staging](#) for this deposit control staging record.

[Top of Page](#)

Tender Control Staging

You must create at least one tender control staging record for each batch of payments to be uploaded into the system. The name of this table is CI_TNDR_CTL_ST. The following table describes each column on this table.

Column Name	Length	Req'd	Data Type	Comments
EXT_SOURCE_ID	30	Y	A/N	This must correspond with the external source ID on the parent deposit control staging record.
EXT_TRANSMIT_ID	50	Y	A/N	This must correspond with the external transmission ID on the parent deposit control staging record.
EXT_BATCH_ID	30	Y	A/N	This is the unique identifier of the batch of payments in respect of the external transmission ID.
TNDR_CTL_STG_ST_FLG	2	Y	A/N	This must be set to 20 (20 is the translate value that corresponds with the Pending state)
TNDR_CTL_ID	10	N	N	Leave this column blank. It will be assigned by the system when it creates a tender control record.
TOT_TNDR_AMT	13.2	Y	N	This column must equal the sum of the payment amounts on the payment tender staging records associated with this tender control staging.
TOT_TNDR_CNT	10	Y	N	This column must equal the number of payment tender staging records associated with this tender control staging.

You must create one or more [Payment Tender Staging](#) records for this tender control staging record.

[Top of Page](#)

Payment Tender Staging

You must create at least one payment tender staging record for each payment associated with the tender control staging record. The name of this table is CI_PAY_TNDR_ST. The following table describes each column on this table.

Column Name	Length	Req'd	Data Type	Comments
EXT_SOURCE_ID	30	Y	A/N	This must correspond with the external source ID on the parent deposit control staging record.
EXT_TRANSMIT_ID	50	Y	A/N	This must correspond with the external transmission ID on the parent tender control staging record.
EXT_BATCH_ID	30	Y	A/N	This must correspond with the external batch ID on the parent tender control staging record.
EXT_REFERENCE_ID	30	Y	A/N	This is the unique identifier of the payment in respect of the external batch ID.
PAY_TND_STG_ST_FLG	2	Y	A/N	This must be set to 10 (10 is the translate value that corresponds with the Pending state)
PAY_TENDER_ID	12	N	N	Leave this column blank. It will be assigned by the system when it creates a tender record.
TENDER_AMT	13.2	Y	N	The amount tendered (i.e., the payment amount).
ACCOUNTING_DT	10	Y	Date	This is the date that should be used for accounting purposes. This should correspond with an open accounting period.
TENDER_TYPE_CD	4	Y	A/N	This must correspond with the prime key of one of your tender types. Refer to Setting Up Tender Types for more information.
CUST_ID	15	Y	A/N	This is the account ID or old account number of the customer tendering the payment. If the system cannot find an account ID or old account number that matches this value, the account ID of the

tender source's suspense SA will be used on the corresponding tender and payment.

MICR_ID	30	N	A/N	This is the MICR ID associated with the payment.
NAME1	40	N	A/N	This is the customer name on the payment.
CHECK_NBR	10	N	A/N	This is the check number on the payment.

[Top of Page](#)

Payment Staging

You need only populate rows on this table if any of the following conditions apply:

- If you need to distribute a payment tender to an account other than that defined with the CUST_ID on the payment tender staging record, you must create a payment staging record. You may distribute a tender to multiple accounts by creating multiple payment staging records. Note, if you want to distribute the payment tender to the same account, you do NOT need a payment staging record.
- If you want to restrict a payment to a specific service agreement, you must insert a row on this table to indicate the specific the service agreement in question. You do this by populating MATCH_TYPE_CD with a value that indicates that you are paying for a specific service agreement and MATCH_VALUE with the unique ID of the service agreement.
- If you practice [open-item accounting](#), you must insert a row on this table for each to indicate the open-item to which the payment should be matched. Note, because open-item customer typically match payments to bills, you would populate MATCH_TYPE_CD with a value to indicate that you are matching by bill ID and MATCH_VALUE with the unique ID of the bill.

The name of this table is CI_PAY_ST. The following table describes each column on this table.

Column Name	Length	Req'd	Data Type	Comments
EXT_SOURCE_ID	30	Y	A/N	This must correspond with the external source ID on the parent payment tender staging record.
EXT_TRANSMIT_ID	50	Y	A/N	This must correspond with the external transmission ID on the parent payment tender staging record.
EXT_BATCH_ID	30	Y	A/N	This must correspond with the external batch ID on the parent payment tender staging record.
EXT_REFERENCE_ID	30	Y	A/N	This must correspond with the external reference ID on the parent payment tender staging record.
CUST_ID	15	Y	A/N	This is the account ID or old account number of the customer to which

the payment should be distributed. If the system cannot find an account ID or old account number that matches this value, the account ID of the payor is used on the corresponding payment. If the payor's account ID is invalid, the tender source's suspense SA is used.

PAY_AMT	13.2	Y	N	The amount tendered (i.e., the payment amount).
MATCH_TYPE_CD	8	N	A/N	See the description of the MATCH_VALUE field below. Refer to Payments And Match Events for more information about the significance of this field.
MATCH_VALUE	30	N	A/N	MATCH_VALUE and MATCH_TYPE_CD are used in conjunction to indicate that the distribution of the payment should be restricted in some way (i.e., the standard payment distribution algorithm should not be used). MATCH_TYPE_CD indicates how the payment should be distributed (e.g., only distribute to a specific service agreement), MATCH_VALUE contains the ID of the restriction (e.g., the SA ID). If MATCH_TYPE_CD is specified, it must reference a valid Match Type .

Process PUPL - Upload Payments

The background process (PUPL) loads the contents of the various payment staging records into the various payment event tables. The tables that are populated by this process are shown in the left orange section of the following ERD (the right orange section are the staging tables populated by the process described above)

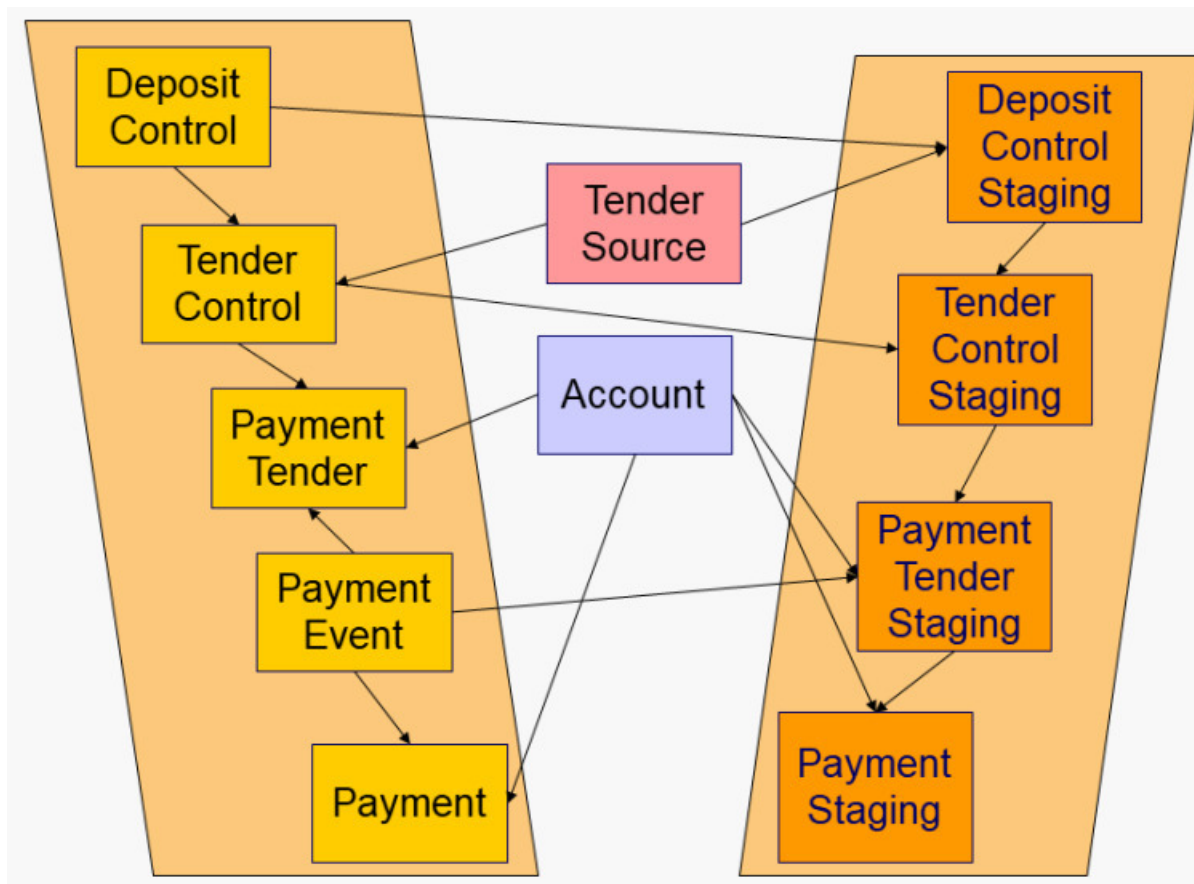

The topics in this section describe how these tables are populated.

[Phase 1 - Create Deposit Control](#)

[Phase 2 - Create Tender Control](#)

[Phase 3 - Create Payment Events, Tenders, Payments, and Payment Segments](#)

Phase 1 - Create Deposit Control

The following points describe, at a high level, the first phase of the payment upload process:

- PUPL checks that the record counts and money totals of tender control stagings add up to the expected amount on deposit control staging. If not,
 - PUPL sets the status of the deposit control staging to be Error . None of the tender controls within the deposit control will be processed until everything adds up. You can fix these on the [Deposit Control Staging](#) page.
 - When PUPL runs next, it will recheck the totals on deposit control stagings that are in Error or Pending
- If the record and dollar amounts are clean,
 - PUPL creates the corresponding deposit control
 - PUPL sets the status of the deposit control staging to be In Progress

[Top of Page](#)

Phase 2 - Create Tender Control

The following points describe, at a high level, the second phase of the payment upload process:

- PUPPL checks that record counts and money totals of payment tender staging(s) adds up to expected amount on tender control staging. If not,
 - PUPPL sets the status of the tender control staging to be Error . None of the tender controls within the deposit control will be processed until everything adds up for ALL tender controls. You can fix these on the [Tender Control Staging](#) page.

NOTE:

that the Deposit Control Staging record is **not** updated - its status is unchanged. Neither is the Pay Tender Staging record updated - its status also remains unchanged. Only the Tender Control Staging record is updated to be in Error .

- When PUPPL runs next, it will recheck the totals of tender control stagings that are in Error or Pending.
- If the record and dollar amounts are clean,
 - PUPPL creates the corresponding tender control.
 - PUPPL sets the status of the tender control staging to be In Progress .

[Top of Page](#)

Phase 3 - Create Payment Events, Tenders, Payments, and Payment Segments

At this point, all deposit control stagings and tender control stagings are in the state of In Progress. Next, PUPPL starts the upload of payment tender staging and payment staging. The following points describe, at a high level, this phase of the payment upload process:

- If the payment tender staging record has a future accounting date, the processing for the record is skipped. This prevents uploaded payments from being created and subsequently frozen until their accounting date is reached. (Some external sources may provide advance notification of payments to be made in the future.) A skipped staging record remains in the Pending state until its accounting date is reached.
- PUPPL checks money totals of payment advices (if any) adds up to expected amount on payment tender staging.
 - If not, PUPPL sets the payment tender staging's status to Error .
 - Any errors are written to the [Payment Upload Exception](#) table. You can fix these errors on the [Payment Upload Staging](#) page and change the record's status back to Pending.
 - When PUPPL runs next, it will recheck the totals of the payment tender staging
- If payment tender staging record is clean:
 - PUPPL creates a corresponding payment event, tender, and payment.
 - If the account on payment tender staging is wrong, the account on the corresponding tender will be the tender source's suspense SA's account. Refer to [Setting Up Tender Sources](#) for more information. Refer to [How To Transfer A Payment From One Account To Another](#) for how to transfer to payment to the correct account.
 - If the account on payment advice is wrong, the account on the corresponding payment will be the account on the payment tender.
 - PUPPL distributes the payment(s) amongst the account's service agreements, and payment segments are created. Note, the payment could be in error if there are no SAs for the account (as well as other reasons). Payments in error are written to the payment exception (CI_PAY_EXCP).
 - PUPPL changes the payment tender staging's status to Complete.
- If all payment tender stagings are Complete:
 - PUPPL changes the tender control staging's status to Complete.
 - PUPPL changes the deposit control staging's status to Complete .

- If there are payment tender staging that are not Complete
 - The status of the tender control staging will still be In progress .
 - The status of the deposit control staging will still be In progress .
- PUPL will attempt to upload the offending payment tender staging records when it next runs.

NOTE: Balancing Control Tables. The balancing of the deposit and tender control tables during payment upload can either be done by PUPL, or after PUPL successfully completes. The latter might be useful for high volume payment uploads that could result in deadlocks on these control tables. If your implementation wishes to execute control table balancing after PUPL completes, ensure that the necessary batch parameter is set to exclude balancing when PUPL runs and also that the separate balancing batch process (C1-PUBAL) is scheduled after PUPL.

PYUP-PRG - Purge Payment Upload Objects

Completed payment upload staging objects should be periodically purged from the system by executing the [PYUP-PRG](#) background process. This background process allows you to purge all Completed payment upload staging objects older than a given number of days.

We want to stress that there is no system constraint as to the number of Completed payment upload objects that may exist. You can retain these objects for as long as you desire. However we recommend that you periodically purge Completed payment upload objects as they exist only to satisfy auditing and reporting needs.

Maintaining Deposit Control Staging

The Deposit Control Staging page has three purposes:

- You can view historical deposit and tender control staging records associated with uploaded payments.
- You can correct deposit and tender control records that are in error.
- You can add deposit and tender control records to be uploaded by the payment upload background process.

The topics in this section describe this page.

Deposit Control Staging - Main

This page shows the details of a deposit control staging record.

FASTPATH:

Refer to [Populating The Payment Upload Staging Records](#) for more information about this record.

Open this page using **Menu > Financial > Deposit Control Staging > Search.**

Description of Page

External Source ID corresponds with an external source ID on one of the your tender sources. This should be the unique ID of the source of the interfaced payments. Refer to [Setting Up Tender Sources](#) for more information.

External Transmit ID is the unique identifier of the transmission of payments from the external source. This must be a unique value for each transmission from the source.

Status shows the state of the deposit control staging records. Potential values are: Incomplete , Pending, In Progress, Partial Load, Complete, Error.

Deposit Control ID is the system-assigned, unique identifier of the related deposit control. This value is populated after the system creates a deposit control for the upload staging record.

Transmission Date/ Time are when the information was interfaced into the system.

Total Tender Controls must equal the number of tender control staging records associated with this deposit control staging.

Total Tender Control Amount must equal the sum of the payment amounts on the tender control staging records associated with this deposit control staging. The **Currency Code** related to the amount is adjacent.

Deposit Control Staging - Tender Control Staging

This page shows the details of a tender control staging record.

FASTPATH:

Refer to [Populating The Payment Upload Staging Records](#) for more information about this record.

Open this page using **Menu > Financial > Deposit Control Staging > Search** and navigate to the **Tender Control Staging** page.

Description of Page

External Source ID is the external source ID on the parent deposit control staging record.

External Transmit ID is the external transmission ID on the parent deposit control staging record.

The grid that follows contains a row for every tender control staging record linked to the deposit control staging record. The following information is displayed.

External Batch ID This is the unique identifier of the batch of payments in respect of the external transmission ID.

Status This is the state of the tender control staging records. Potential values are: Pending, In Progress, Complete, Error.

Tender Control ID This is the system-assigned, unique identifier of the related tender control. This value is populated after the system creates a tender control for the upload staging record.

Total Tenders Amount This is the sum of the payment amounts on the payment staging records associated with this tender control staging.

Total Number Of Tenders This is the number payment tender staging records associated with this tender control staging.

Payment Upload Staging

The Payment Upload Staging page has three purposes:

- You can view historical payment tender and payment staging records associated with uploaded payments.
- You can correct payment tender records that are in error.
- You can add new payment tender and payment staging records to be uploaded by the payment upload process.

The topics in this section describe this page.

Payment Upload Staging - Tender Detail

This page shows the details of a payment tender staging record.

FASTPATH:

Refer to [Populating The Payment Upload Staging Records](#) for more information about this record.

Open this page using **Menu > Financial > Payment Upload Staging > Search** to open the **Tender Detail** page.

Description of Page

External Source ID this is the external source ID on the parent tender control staging record.

External Transmission ID is the external transmission ID on the parent tender control staging record.

External Batch ID is the external batch ID on the parent tender control staging record.

Ext. Reference ID is the external source's unique identifier of the payment tender.

Customer ID is the account ID or old account number of the customer tendering the payment. If the system cannot find an account ID or old account number that matches this value, the account ID of the tender source's suspense SA will be used on the corresponding tender and payment.

The **Tender Amount** is the amount tendered (i.e., the payment amount).

Tender Type defines the type of tender. Refer to [Setting Up Tender Types](#) for more information.

NOTE:

Authorizing Tenders. The **Tender Type** dropdown list does not include tender types that require authorization (i.e. credit card payments).

FASTPATH:

For information about tender types requiring authorization, refer to [Credit Card Payments](#).

MICR ID is the MICR ID associated with the tender.

Check Number is the check number on the payment.

Name is the customer's name (as it appeared on the uploaded tender).

Accounting Date is the date that should be used for accounting purposes.

Pay Tender Staging Status shows the state of the tender control staging records. Potential values are: Pending, Complete, Error.

Payment Event ID is the system-assigned, unique identifier of the related payment event. This value is populated after the system creates a payment event for the upload staging record.

Payment Upload Staging - Payment Advice

If a tender was distributed to customers other than that defined on the Tender Detail page, the customers that the tender was distributed to are defined on this page. This page will not contain information if the tender is distributed to the tender detail's customer.

FASTPATH:

Refer to [Populating The Payment Upload Staging Records](#) for more information about this record.

Open this page using **Menu > Financial > Payment Upload Staging > Search** and navigate to the **Payment Advice** page.

Description of Page

External Source ID this is the external source ID on the parent tender control staging record.

External Transmission ID is the external transmission ID on the parent tender control staging record.

External Batch ID is the external batch ID on the parent tender control staging record.

External Reference ID is the external reference ID of the payment tender.

The grid that follows is only populated if the tender is distributed to customer(s) other than the tendering customer. The following information is displayed.

Customer ID This is the account ID or the old account number of the customer to which the payment should be distributed.

Customer Info If the **Customer ID** is an account ID that exists in the system, the name of the primary person and the customer class of the account are displayed here.

Payment Amount This is the amount of the tender to be distributed to the customer.

Match Type and **Match Value** These fields are only used if the distribution of the payment should be restricted in some way (i.e., the standard payment distribution algorithm should not be used). **Match Type** indicates how the payment should be distributed (e.g., only distribute to a specific service agreement), **Match Value** indicates the ID of the restriction (e.g., the service agreement ID). Valid values of **Match Type** are Service Agreement.

Payment Upload Staging- Characteristics

Select **Menu > Financial > Payment Upload Staging > Search** and navigate to the **Characteristics** page.

Description of Page

External Source ID this is the external source ID on the parent tender control staging record.

External Transmission ID is the external transmission ID on the parent tender control staging record.

External Batch ID is the external batch ID on the parent tender control staging record.

Ext. Reference ID is the external source's unique identifier of the payment tender.

Use the characteristics grid to capture additional information about the payment tender staging record.

- Use **Payment Characteristics Entity** to define where each characteristic will be populated on upload. Valid values are: **Payment, Payment Event** or **Payment Tender**
- Select a **Characteristic Type** for each payment characteristic entity. You can only choose Characteristic Types defined as permissible for the applicable entity. Refer to [Setting Up Characteristic Types & Their Values](#) for more information.
- Enter a valid **Characteristic Value** for the selected characteristic type. You may enter more than one characteristic row for the same characteristic type, each associated with a unique Sequence number. If not specified, the system defaults it to the next **sequence** number for the characteristic type.

Payment Upload Exception

If errors are detected during the payment upload process, a record is written to the payment upload exception table with a message indicating the nature of the severe error.

To view the messages associated with the exception records, schedule the **TD-PYUPL** background process. This process generates a To Do entry for every record in the payment upload exception table.

You can fix this error using the [Payment Upload Staging](#) page and change the status of the record from Error to Pending. When the payment upload process next runs, it attempts to upload this record again.

Interfacing Payments Using Distribution Rules

The topics in this section describe how the payment interface using distribution rules works.

Populating The Payment Event Upload Staging Records

The following diagram illustrates the processes involved in the uploading of payment event distribution details into the system.

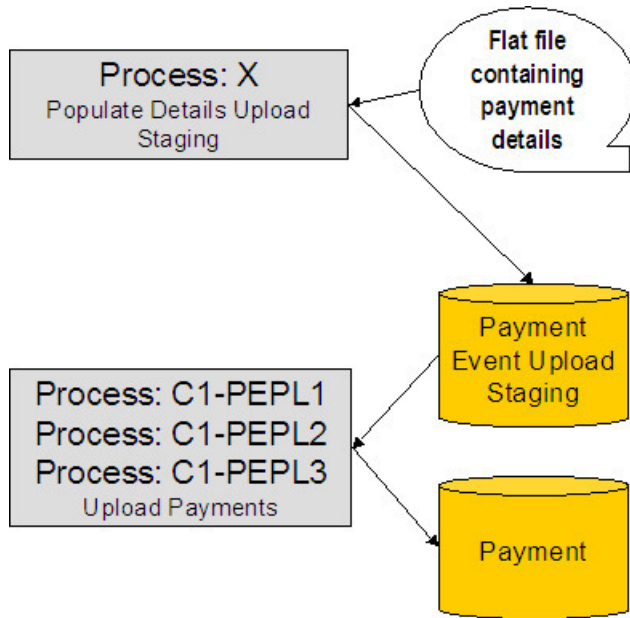

The topics in this section describe each background process referenced above.

Process X - Populate Payment Event Upload Staging

Process X refers to the mechanism used by your organization to populate the payment event upload staging table.

payment Event Upload Staging Table

You must create a payment event upload staging record for each payment distribution detail to be uploaded into the system. The name of this table is CI_PEVT_DTL_ST. The following table describes each column on this table.

Column Name	Length	Req'd	Data Type	Comments
EXT_SOURCE_ID	30	Y	A/N	This must correspond with an external source ID on one of the defined tender sources. Refer to Setting Up Tender Sources for more information.
EXT_TRANSMIT_ID	50	Y	A/N	This is the unique identifier of the

transmission from the external source. This must be a unique value for each transmission from the source.

PEVT_DTL_SEQ	12	Y	N	Unique identifier of the detail record within the transmission. The C1-PEPL1 process uses this field to organize the parallel threads.
PEVT_STG_ST_FLG	4	Y	A/N	This must be set to 10 (10 is the lookup value that corresponds with the Incomplete state)
DST_RULE_CD	12	Y	A/N	This must be a valid distribution rule . The distribution rule contains the set of algorithms designed to process the staging detail.
DST_RULE_VALUE	254	Y	A/N	This must be a valid value for the characteristic type defined on the distribution rule.
CURRENCY_CD	3	Y	A/N	This must be a valid currency code (this would be USD for United States dollars).
TENDER_AMT	13.2	Y	N	The amount tendered (i.e., the payment amount).
ACCOUNTING_DT	10	Y	Date	This is the payment date that should be used for accounting purposes. This should correspond with an open accounting period.
TENDER_TYPE_CD	4	Y	A/N	This must be a valid tender type. Refer to Setting Up Tender Types for more information.
CHECK_NBR	10	N	A/N	This is the check number on the payment.
MICR_ID	30	N	A/N	This is the MICR ID associated with the payment tender.
CUST_ID	15	N	A/N	This field may be used to record customer information.

NAME1	30	N	A/N	This field may be used to capture additional payment tender information.
EXT_REFERENCE_ID	30	N	A/N	This field may be used to capture external information associated with the payment tender.
MATCH_TYPE_CD	8	N	A/N	See the description of the MATCH_VALUE field below. Refer to Payments And Match Events for more information about the significance of this field.
MATCH_VALUE	30	N	A/N	MATCH_VALUE and MATCH_TYPE_CD are used in conjunction to indicate that the distribution of the payment should be restricted in some way (i.e., the standard payment distribution algorithm should not be used). MATCH_TYPE_CD indicates how the payment should be distributed (e.g., only distribute to a specific service agreement), MATCH_VALUE contains the ID of the restriction (e.g., the SA ID). If MATCH_TYPE_CD is specified, it must reference a valid Match Type .
TNDR_CTL_ID	10	N	A/N	Leave this column blank. It will be assigned by the system when it creates a tender control record.
ACCT_ID	10	N	A/N	This is the tender account. If left blank, the C1-PEPL1 process will populate this field by calling the Determine Tender Account algorithm defined on the distribution rule .

				Note that this Account ID is not necessarily unique as multiple staging details can reference the same tender account.
PAY_EVENT_ID	12	N	A/N	Leave this column blank. It will be assigned by the system when it creates a payment event record.
PEVT_PROCESS_ID	10	N	A/N	If left blank, the C1-PEPL1 process will set this field equal to the Tender Account ID. This field is used for grouping staging records and for organizing parallel threads (in the C1-PEPL2 process). Therefore, it is strongly encouraged that it bears a relationship to the tender account ID.
APAY_SRC_CD	12	N	A/N	This must be a valid auto-pay source code.
EXT_ACCT_ID	50	N	A/N	This is the customer's account number at the financial institution
EXPIRE_DT	10	N	Date	This field is only needed if the Tender Type indicates that an expiration date is necessary (e.g., for a credit card payment)
ENTITY_NAME	64	N	A/N	This is the customer's name in the financial institution's system

Data Setup Examples of Payment Distribution Details

Typically, each staging record will represent a single payment event - with a corresponding payment tender and payment. However, it is possible to specify complex relationships within a set of staging records. For example, it will be straightforward to define a set of staging records that represent a single tender but multiple payments (to model the single payment tender of a welfare agency which covers payments for multiple accounts). Similarly, it is equally possible to define a set of staging records that represent a single payment but multiple tenders (although not a common requirement).

Each staging record can represent:

- Zero or one new payment events. Typically, each detail staging record will represent a single payment event. However, it is possible to define multiple records for a single payment event. All details for a single payment event are identified by a common value on the staging record: **Pay Event Process ID**.

NOTE:

Pay Event Process ID. This field is used for grouping staging records **and** for organizing parallel threads (in the C1-PEPL2 process). Therefore, it is **strongly encouraged** that it bears a relationship to the tender account ID.

- A partial or one new payment tenders. Typically, each detail staging record will represent a single payment tender. However, it is possible to define multiple staging records for a single pay tender. All details for a single tender are identified by a common payment event ID as well as common tender information (tender type, tender account ID, check number, external reference, etc.).
- A partial or many new payments. Typically, each detail staging record will represent a set of one or many new payments. However, it is possible to define multiple staging records for a single payment. All details for a single payment are identified by a common payment event ID as well as common distribution rule and characteristic value information.

The sections below provide examples of a few of these complex payment event configurations. Note that these examples assume the same distribution rule is referenced in all staging records.

- [Staging Entry Example 1: One Payment Event, Two Tenders, Two Payments](#)
- [Staging Entry Example 2: One Payment Event, One Tender, Two Payments](#)
- [Staging Entry Example 3: One Payment Event, Two Tenders, One Payment](#)

Staging Entry Example 1: One Payment Event, Two Tenders, Two Payments

Seq.	Pay Event Process ID	Tender Account ID	Tender Ref.	Date	Rule Value	Amount	Tender Type	Check No
1	1234567890	1234567890	112A	1/1/2006	113-54-8978	30.00	Check	101
2	1234567890	1234567890	112B	1/1/2006	575-40-3030	40.00	Check	102

[Top of Page](#)

Staging Entry Example 2: One Payment Event, One Tender, Two Payments

Seq.	Pay Event Process ID	Tender Account ID	Tender Ref.	Date	Rule Value	Amount	Tender Type	Check No
1	1234567890	1234567890	112A	1/1/2006	113-54-8978	30.00	Check	101
2	1234567890	1234567890	112A	1/1/2006	575-40-3030	40.00	Check	101

[Top of Page](#)

Staging Entry Example 3: One Payment Event, Two Tenders, One Payment

Seq.	Pay Event Process ID	Tender Account ID	Tender Ref.	Date	Rule Value	Amount	Tender Type	Check No
1	1234567890	1234567890	112A	1/1/2006	575-40-3030	30.00	Check	101
2	1234567890	7878787870	888Q	1/1/2006	575-40-3030	40.00	Check	9872

The Lifecycle of a Payment Event Upload Staging Record

The following diagram shows the possible lifecycle of a payment event upload staging record.

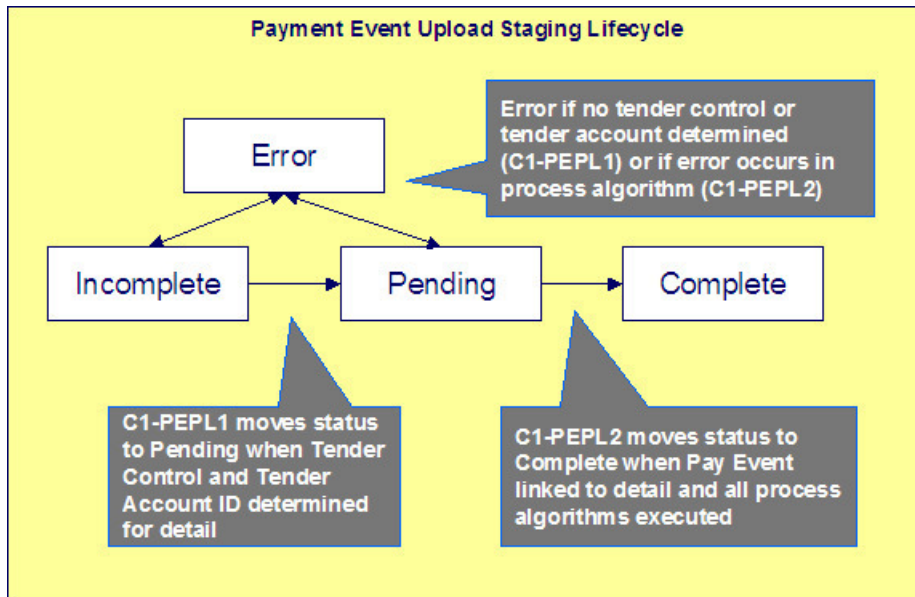

- **Incomplete.** A payment event staging record is initially created in incomplete state. The C1-PEPL1 process sets it to pending once it links it to a tender control and determines its tender account.
- **Pending.** The C1-PEPL2 process sets a pending record to complete once all processing logic is executed and a payment event is linked to it.
- **Complete.** When processing of the staging record is complete the record is in the complete state. This is a final state.
- **Error.** A payment event staging record may be set to Error from Incomplete or Pending states by the C1-PEPL1 and C1-PEPL2 processes respectively.

FASTPATH:

Refer to [To Do Entries Instead of Exceptions](#) for more information on how To Do entries are used to capture processing errors.

To Do Entries Instead of Exception Records

Instead of creating an exception record for staging records in the Error state the C1-PEPL1 and C1-PEPL2 background processes create To Do entries and link them to the offending staging records.

Each process determines the [To Do type](#) to use for reporting errors by looking for the To Do Type defined with this process as its creation process.

Process C1-PEPL1 - Upload Payments (Step 1)

The batch process C1-PEPL1 refers to the first of three background processes that load the contents of the payment event upload staging records into the various payment tables.

The responsibility of this process is to transition the status of the staging records from Incomplete to Pending. The status of a staging record must remain Incomplete until:

- It is linked to a tender control. This process creates a new deposit control record. It creates a new tender control record if the staging record is not currently linked to one. It then updates the payment event upload staging records with the corresponding **Tender Control ID**.

- The **Tender Account ID** field is populated. The Determine Tender Account algorithm defined on the [distribution rule](#) is called and the returned account ID is posted on the staging record.
- The **Pay Event Process ID** field is populated. If left blank this field is set equal to the **Tender Account ID**.

The following diagram and the sections below describe at a high level the processing phases of the C1-PEPL1 background process.

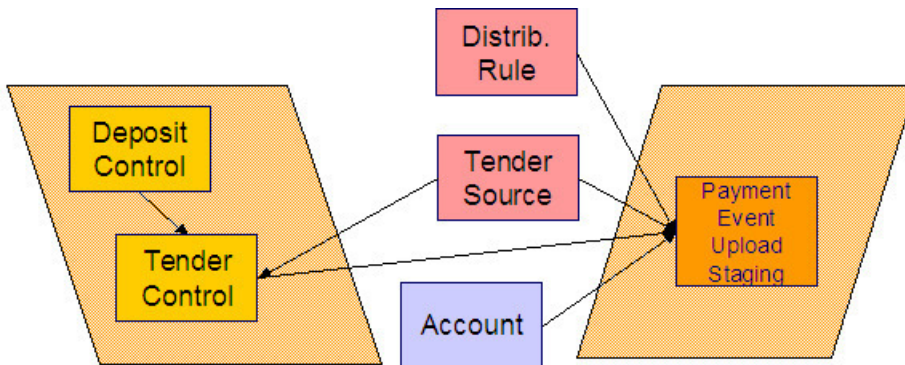

- [Phase 1 - Create Tender Control](#)
- [Phase 2 - Determine Tender Account](#)

Phase 1 - Create Tender Control

NOTE:

This step cannot be bounded by thread range but must execute across the entire population of staging details. Therefore this step in the process is designed so that all parallel threads attempt to execute it at the same time but only one thread succeeds to avoid creating duplicate tender controls.

This step creates all tender controls required by the upload records as follows:

- For each distinct tender source transmissions represented within the incomplete set of upload staging details a deposit control and a tender control are created in an open state. (If the upload record is already linked to a tender control, then that tender control is used and a new one is not created.)
 - If an error occurs at this stage
 - A designated staging record for the transmission group (one is picked at random) is set to Error and a To Do entry is created and linked to it to capture the error message that applies for the whole transmission group. Other records in the group remain incomplete .
 - The process stops.
-

NOTE:

Group Error. This technique allows for an easier recovery from a setup error that may affect a large volume of records in a single transmission. Capturing the error only on a single designated record requires only this record to be set back to Incomplete once the setup issue is corrected. It is important to note that the transmission group is not processed if at least one of the records in the group is in Error status.

- Once a transmission group of records is fully processed, a To Do cleanup processing takes place to complete To Do entries previously raised for its designated staging record.
-

FASTPATH:

Refer to [To Do Entries Instead of Exceptions](#) for more information on how To Do entries are used to capture processing errors.

Phase 2 - Determine Tender Account

After all tender controls have been created the second step attempts to transition all incomplete records to the pending state. Each incomplete staging record is processed as follows:

- If not yet associated with a tender control ID, the process looks for an Open tender control that matches the batch code, batch number and external source ID and links it to the staging record. An error is raised if a matching tender control is not found.
- Execute the Determine Tender Account algorithm defined on the distribution rule and populate the record with the returned account ID. Note that the algorithm is called even when the tender account is populated to provide for a potential override of the initial value when necessary. An error is raised if a tender account may not be determined.
- If not already populated, the **Pay Event Process ID** is set equal to the Tender Account ID. The C1-PEPL2 process uses this field to organize the parallel threads and to group multiple staging details into a single payment event.
- The staging record is moved to pending state.
- If any errors occur set the record to Error and create a To Do entry for the error message.
- If no error occurred, a To Do cleanup processing takes place to complete To Do entries previously raised for the staging record.

FASTPATH:

Refer to [To Do Entries Instead of Exceptions](#) for more information on how To Do entries are used to capture processing errors.

NOTE:

This step is designed to support execution in parallel threads based upon the sequence number portion of the staging table prime key.

Process C1-PEPL2 - Upload Payments (Step 2)

The batch process C1-PEPL2 refers to the second of three background processes that load the contents of the payment event upload staging records into the various payment tables.

The responsibility of the C1-PEPL2 process is to create payment events, payment tenders and payments and transition the corresponding staging records from Pending to Complete.

The following diagram and the section below describe at a high level the processing phases of the C1-PEPL2 background process.

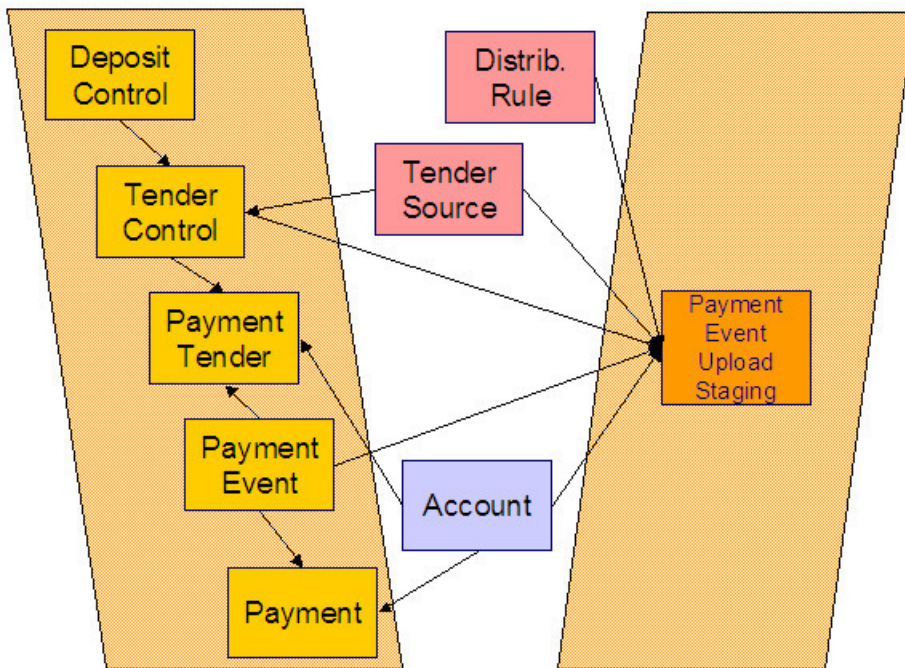

Each distinct group of pending staging records associated with the same external source ID, external transmit ID, accounting date, and pay event process ID is processed as follows:

- A payment event is created for the group and stamped on each of its records.
- A payment tender is created for each distinct set of staging records having the same tender account, tender type and other tender information fields, except for the tender amount.
- The Create Payment algorithm is then called for each distinct group of staging records having the same tender account, [distribution rule](#) and rule value providing it with the total amount for the group.
- The staging record is moved to the complete state.
- If any error occurs a designated staging record for the payment event group (one is picked at random) is set to Error and a To Do entry is created and linked to it to capture the error message that applies for the whole group. Other records in the group remain incomplete .

NOTE:

Group Error. This technique allows for an easier recovery from an error that affects all staging records for a single payment event. Capturing the error only on a single designated record requires only this record to be set back to pending once the issue is corrected. It is important to note that the whole set of records is not processes if at least one of the records in the group is in Error status.

- If no error occurred, a To Do cleanup processing takes place to complete To Do entries previously raised for the designated staging record.
-

FASTPATH:

Refer to [To Do Entries Instead of Exceptions](#) for more information on how To Do entries are used to capture processing errors.

NOTE:

This process is designed to support execution in parallel threads based upon the payment event process ID field.

Process C1-PEPL3 - Upload Payments (Step 3)

The batch process C1-PEPL3 refers to the last of three background processes that load the contents of the payment event upload staging records into the various payment tables.

The responsibility of the C1-PEPL3 process is to update the status of the related deposit and tender controls from open to balanced.

Each distinct tender control for which all associated staging records are in complete status is processed as follows:

- The tender deposit is created.
- The tender control is set to balanced.
- The deposit control is set to balanced.

NOTE:

This process is designed to support execution in parallel threads based upon the Tender Control ID field.

Payment Event Upload Staging

The Payment Event Upload Staging page has three purposes:

- You can view historical payment event upload staging records associated with uploaded payments.
- You can correct payment event upload staging records that are in error.
- You can add new payment event upload staging records to be uploaded by the payment event upload processes.

The topics in this section describe this page.

Payment Event Upload Staging - Main

This page shows the details of a payment event upload staging record.

FASTPATH:

Refer to [Populating The Payment Event Upload Staging Records](#) for more information about this record.

Open this page using **Menu > Financial > Payment Event Upload Staging > Search.**

Description of Page

External Source ID corresponds with an external source ID on one of the your tender sources. This should be the unique ID of the source of the interfaced payments. Refer to [Setting Up Tender Sources](#) for more information.

External Transmission ID is the unique identifier of the transmission of payments from the external source. This must be a unique value for each transmission from the source.

Sequence is the identifier of the record within the transmission. The C1-PEPL1 process uses this field to organize the parallel threads.

Accounting Date is the payment date that should be used for accounting purposes.

Distribution Rule is the rule by which the payment detail is to be processed. A [default distribution rule](#) is displayed if you have set one.

Rule Value is a value associated with the payment and expected by the distribution rule.

Match Type and **Match Value** are only used if the distribution of the payment should be restricted in some way (i.e., the standard payment distribution algorithm should not be used). **Match Type** indicates how the payment should be distributed (e.g., only distribute to a specific service agreement), **Match Value** indicates the ID of the restriction (e.g., the service agreement ID).

Payor Account ID is the tender account. If not populated the C1-PEPL1 process populates this field by calling the Determine Tender Account algorithm defined on the [distribution rule](#).

Tender Amount is the amount tendered (i.e., the payment amount).

Currency Code is the currency of the tendered amount. This should be the same as currency defined on the tender source.

Tender Type defines the form or remittance (e.g., cash, check, etc.). Note that the **Tender Type** defaults from the [installation record](#).

NOTE:

Authorizing Tenders. The **Tender Type** dropdown list does not include tender types that require authorization (i.e. credit card payments).

FASTPATH:

For information about tender types requiring authorization, refer to [Credit Card Payments](#).

Check Number is the check number on the payment.

MICR ID is the value of the magnetic ink character recognition (MICR) line on the payment.

External Reference ID may be used to record external information associated with the payment tender.

Customer ID may be used to record additional customer information.

Name may be used to record additional payment tender information.

Tender Control ID is the tender control associated with the payment. This field is should typically be left for the C1-PEPL1 process to populate.

If the **Tender Type** is associated with an [automatic payment](#), the **Auto Pay** section displays. The system attempts to default automatic payment information from the [account's auto-pay](#) option if the tender type is the same as the tender type on the account's auto-pay source and if the auto pay option is effective on the payment date. If the system is unable to default information, you must specify the source of the funds and the customer's account number / credit card number at the financial institution.

- **Auto Pay Source** is the financial institution / credit card company that receives the automatic payment request.
- **External Account ID** is the customer's account number at the financial institution.
- **Expires On** is only needed if the **Tender Type** indicates that an expiration date is necessary (e.g., for a credit card payment).
- **Name** is the customer's name in the financial institution's system.

Pay Event Process ID is used to group multiple staging records into a single payment event. If not populated, the C1-PEPL1 process sets this field equal to the **Payor Account ID**.

Pay Event Staging Status shows the state of the staging record. Refer to [The Lifecycle of a Payment Event Upload Staging](#) for a state transition overview.

Payment Event ID is the system-assigned, unique identifier of the related payment event. The C1-PEPL2 process populates this field when it creates a payment event for the upload staging record. You can use this field to navigate to the payment event page.

If a staging record is in Error state then the error message associated with the [corresponding To Do entry](#) is displayed.

Adjustments

In this section, we describe when and how to adjust a service agreement's balance.

The Big Picture Of Adjustments

The topics in this section provide background information about a variety of adjustment issues.

FASTPATH:

We strongly recommend familiarizing yourself with the topics described in [The Financial Big Picture](#) to fully appreciate the place of an adjustment in the system's financial architecture. In particular, refer to [Setting Up Adjustment Types](#) and [Setting Up Adjustment Type Profiles](#).

Adjustments - Current Balance versus Payoff Balance

Adjusting how much a customer owes involves changing a service agreement's payoff balance and/or current balance by creating an adjustment. In this section we describe these two balances.

WARNING:

If you do not understand the difference between payoff balance and current balance, refer to [Current Amount versus Payoff Amount](#).

When Current Balance Equals Payoff Balance

For most service agreements, payoff balance and current balance are always the same (or in colloquial speech - the amount the customer thinks they owe equals what they really owe). In this situation, an adjustment is easy: both payoff balance and current balance are adjusted by the same value.

Let's run through a typical example. The values in the payoff balance and current balance columns reflect the amount due after the financial transaction has been applied (i.e., the running balance):

Date	Financial Transaction	Payoff Balance	Current Balance
1-Jan-99	Bill: \$125	125	125
15-Jan-99	Payment: \$150	-25	-25
2-Feb-99	Bill: \$175	150	150
14-Feb-99	Payment: \$150	0	0
3-Mar-99	Bill: \$200	200	200
15-Mar-99	Payment: \$150	50	50
2-Apr-99	Bill: \$225	275	275
27-Apr-99	Adj: Late Payment Charge \$10	285	285

As you can see, payoff balance and current balance are always in sync.

When Current Balance Differs From Payoff Balance

For some service agreements, payoff balance and current balance differ (or in colloquial speech - the amount the customer thinks they owe differs from what they would owe if they wanted to payoff their account).

Let's run through an example of a customer on a budget to illustrate a classic service agreement where these two balances are not the same. The values in the payoff balance and current balance columns reflect the amount due after the financial transaction has been applied:

Date	Financial Transaction	Payoff Balance	Current Balance
1-Jan-99	Bill: \$125, Budget \$150	125	150
15-Jan-99	Payment: \$150	-25	0
2-Feb-99	Bill: \$175, Budget \$150	150	150
14-Feb-99	Payment: \$150	0	0
3-Mar-99	Bill: \$200, Budget \$150	200	150
15-Mar-99	Payment: \$150	50	0
2-Apr-99	Adj: Mar 3, 97 bill incorrect due to meter exchange discrepancies; manual correction of -\$33.	17	0

Notice the adjustment of -\$33 affects only payoff amount. This is because the customer is on a budget. The adjustment will not affect their monthly payment and therefore it doesn't affect how much they think they owe.

The following table describes the various types of service agreements where these balances may differ.

Type Of Service Agreement	What Payoff Balance Holds	What Current Balance Holds
Deposit	Payoff balance holds the amount of deposit you are holding on behalf of the customer's debt. This amount is showed as a credit (with a negative sign) because you truly owe the customer this money.	Current balance holds the amount the customer owes for a deposit.
Charitable contribution	N/A - charitable contribution service agreements never have a payoff balance.	Current balance holds the amount the customer owes for a charitable contribution.
Payment arrangements	Payoff balance holds the total amount of delinquent debt that remains unpaid. When a payment arrangement is started, you transfer the payoff balance from the utility service agreement to the payment arrangement service agreement. Each billing period, the customer pays down this balance.	Current balance holds the amount the customer owes in respect of the billed payment arrangement amounts.
Utility agreements on a budget plan	Payoff balance holds the actual amount owed (actual bills minus payments).	Current balance holds the amount the customer owes in respect of the billed budget amount.
Loans	Payoff balance holds the payoff amount for the loan, which is the current balance (the billed loan amount) plus the principal balance	Current balance holds the amount the customer owes in respect of the billed amount (the periodic payment amount).

(the unbilled loan amount) and any accrued interest charges.

Adjustment Type And Balances

When you create an adjustment, you must define its adjustment type. The adjustment type controls how payoff balance and current balance are affected by the adjustment amount.

You can only pick adjustment types that make sense for the service agreement. For example, if your organization doesn't allow budget billing, all adjustments for a utility service agreement will affect payoff balance and current balance the same (you can't get the balances out-of-sync).

The various types of adjustments that may be linked to a service agreement are controlled by the adjustment profiles defined on the service agreement's SA type.

FASTPATH:

Refer to [Adjustment Type Controls Everything](#) for more information.

Canceling Adjustments

You may cancel any frozen adjustment. Canceling the adjustment creates another financial transaction that reverses the financial effects of the original adjustment. The impact of the cancellation appears on the customer's next bill. You may view both the original financial transaction and its cancellation on the Adjustment page.

Transfer Adjustments

A convenient mechanism exists to transfer moneys between two service agreements. The net effect of such a request is the creation of two adjustments, each of which is linked to the other. Both adjustments are created together, frozen together, and posted to the GL together. This is useful because you can't create one side of the transfer and without the other. Refer to [How To Create A Transfer Adjustment](#) for more information.

NOTE:

Inter or Intra Account. It's important to be aware that the transfer can be inter or intra account (i.e., the accounts on the two adjustments may be different).

Calculated Adjustments

An adjustment can calculate the adjustment amount using an algorithm. A calculated adjustment can be used to calculate:

- Sales or other taxes for a base amount
- Any charge amount based on a user-supplied quantity, such as feet, miles, hours, etc.
- Others.... Any calculation that can be made by a rate can be applied to an adjustment.

When you create a calculated adjustment, you may be asked to supply a base amount. The user may supply the base amount or the amount could be [defaulted](#) from the adjustment type and possibly overridden by the user prior to calculating the adjustment amount.

When the adjustment is generated, the calculation algorithm may use the base amount and calculation date. The base package algorithm calls the rate application and returns the calculated amount with calculation lines and GL distribution codes.

An adjustment's adjustment type controls whether the adjustment is calculated and the algorithm that performs the calculation.

FASTPATH:

For more information, refer to [Adjustment Type Controls Everything](#) and [Setting Up Calculated Adjustment Types](#).

Adjustment Amount May Be Positive, Negative, Or Zero

An adjustment's amount may be positive, negative or zero:

- A positive amount causes the customer's balance(s) to increase.
- A negative amount causes the customer's balance(s) to decrease.
- A zero amount will not affect the customer's balance(s). A zero amount is odd, but necessary when you need to use an adjustment to correct the GL distribution. Refer to [How To Use An Adjustment To Change Amounts Booked In Your GL](#) for more information.

Adjustment Type Controls Everything

When you create an adjustment, you must define its adjustment type. The topics in this section describe how adjustment type controls the behavior of an adjustment.

Controls Which Balance(s) Are Affected

The adjustment type's financial transaction (FT) algorithm controls how payoff balance and current balance are affected by the adjustment amount.

Defines The GL Account Affected By The Adjustment

Most adjustments affect the general ledger (GL) in some way. The following points describe the source of these GL accounts.

- For normal adjustments (i.e., non-calculated adjustments that affect a single service agreement), there is a single accounting entry generated:
 - One side of the accounting entry is taken from the distribution code on the SA type of the service agreement affected by the adjustment. For example, if you are adjusting the payoff balance on a normal service agreement, the A/R account is constructed from the distribution code on the service agreement's SA type.
 - The other side of the accounting entry is taken from the distribution code on the adjustment's adjustment type. For example, if a late payment charge is created, the "late payment charge" adjustment type references this fee's revenue account.
- For transfer adjustments (i.e., adjustments used to transfer moneys between two service agreements), there are two accounting entries generated - one for the "from" side and one for the "to" side. Each adjustment carries its own set of balanced GL accounting details.

- For each adjustment, one side of the entry is taken from the distribution code on the SA type of the service agreement affected by the adjustment (just like for normal adjustments).
- The other sides of both accounting entries have the same GL account. This account should be the intermediate clearing GL account that is to be used for the transfer. The source of this clearing GL account is the distribution code on the adjustment type used to transfer the funds.
- For calculated adjustments (i.e., adjustments where rates may be applied to calculate the adjustment amount), there is a single accounting entry:
 - For each adjustment, one side of the entry is taken from the distribution code on the SA type of the service agreement affected by the adjustment (just like for normal adjustments).
 - The other side of the entry is taken from the distribution codes that resulted from the rate calculation if the adjustment financial transaction algorithm is set up to use the calculation lines as the distribution code source. If the adjustment financial transaction algorithm is set up to use the adjustment type as the distribution code source, the other side of the accounting entry is taken from the distribution code on the adjustment type.

NOTE:

Not all adjustments affect the GL. As a general rule of thumb, only those adjustments that affect a service agreement's payoff balance affect the GL. So, if you adjust a budget customer's current balance, but don't adjust their payoff balance, the GL is not affected.

Defaults The Adjustment Amount

The adjustment type may default the adjustment amount in one of the following ways:

- The adjustment type may specify a default amount. This would be used for those adjustment types that have a standard charge for all customers that receive this adjustment, for example a non-sufficient funds charge.
- The adjustment type may specify a default adjustment amount algorithm. This would be used for those adjustment types that have a charge that varies based on other factors. For example, a non-sufficient funds charge may be based on a customer's credit rating.

When an amount is defaulted onto a new adjustment it may be overridden by a user.

Calculates The Adjustment Amount

Some adjustment types [calculate the adjustment](#) amount. If the adjustment type uses a calculated amount, a base amount is passed to the rate application, which then returns the calculated amount with calculation lines and GL distribution codes.

The adjustment type's generate adjustment algorithm controls which rate is applied to the base amount. A user supplied calculation date controls which version of the rate is used. The user may supply the base amount or it may be [defaulted](#) from the adjustment type and possibly overridden by the user prior to calculating the adjustment amount.

Controls The Interface To A/P & 1099 Reporting

If the adjustment type is associated with a payment (e.g. a refund or a loan disbursement) of money to a customer, the adjustment type indicates such with a reference to an A/P request type.

When an adjustment that references an A/P request type is frozen, an A/P download request record is created. This record is the interface request to ask your A/P system to cut a check. This interface record is marked with a batch process ID and run number.

- The batch process ID is the background process responsible for creating the flat file that contains check request that is interfaced to your account's payable system. The batch process ID is defined on [Installation Options - Financial](#). The base package is supplied with a skeletal background process (APDL) that must be populated with logic to format the records in the format compatible with your accounts payable system.
- The run number is the batch process ID's current run number.

FASTPATH:

Refer to [Accounts Payable Check Request](#) for more information.

If the resultant check needs to be reported for income tax purposes under a specific 1099 category, the category is also specified on the adjustment type. The 1099 category is in turn interfaced to the A/P system (the system does NOT manage 1099 reporting).

Controls Information Printed On The Bill

If the adjustment appears on the customer's next bill, the verbiage is specified on the adjustment type (and may NOT be overridden on the adjustment).

Controls If The Adjustment Can Be Frozen Prior To Bill Completion

Refer to [Preventing SA Balances And The GL From Being Impacted Until Bill Completion](#) for how adjustment type can control whether adjustments of a given type can be frozen prior to bill completion.

Controls If The Adjustment Requires Approval

If an adjustment's adjustment type references an approval profile, the system will not allow the initiating user to freeze the adjustment. Rather, the initiating user can submit the adjustment for approval. When an adjustment is submitted for approval, the system determines the necessary approval levels and notifies the first approver. The system will freeze the adjustment when last approver approves the adjustment (if the adjustment's adjustment type allows it to be frozen prior to the completion of the next bill).

NOTE:

Only online adjustments are subject to approval. The system assumes that no approval is necessary for adjustments created by batch processes even those whose adjustment type references an approval profile.

FASTPATH:

Refer to [The Big Picture of Adjustment Approvals](#) for more information.

Unbilled Adjustments And Aged Debt

A Frozen adjustment waits in limbo until the customer's next bill is produced. This limbo period could be several weeks if the customer is billed infrequently. When the customer's next bill is completed, all limbo adjustments are linked to the bill. A brief description (as defined on the adjustment type) appears on the printed bill.

It is important to stress the following in respect of these limbo adjustments:

- If the adjustment decreases the amount of debt, the customer's aged debt is affected immediately regardless of whether the adjustment appears on a bill.
- If the adjustment increases the amount of debt, the amount the customer owes from an aged debt perspective may or may not be affected by the adjustment. There is a switch on the financial transaction created for the adjustment called New Charge that controls the arrears behavior. When the FT for this type of adjustment is created, the switch is set to on and the customer's aged debt will not reflect the adjustment amount until the adjustment is swept onto a bill. The moment the adjustment is swept onto the customer's bill, the debt starts aging. A user may turn the switch off to cause the debt to start aging sooner. For this case, the date on which the adjustment starts aging must be defined in the Arrears Date field.
- The amount a customer owes in total is immediately affected by the adjustment regardless of whether the adjustment appears on a bill. This means that amount of aged debt may not be in sync with the total amount owed. This seems odd but is useful from a credit and collections perspective. You see, you probably don't want to start aging an adjustment until the customer has actually seen it.

An Adjustment May Affect More Than Just Customer Balances

FASTPATH:

When an adjustment is frozen or cancelled, a customer's current and payoff balances are affected. However, several other objects may be affected when such events occur. Refer to [Obscure Things That Can Happen](#) for more information.

Maintaining Adjustments

An adjustment is used to change the amount of debt stored on a service agreement. The topics in this section describe the pages on which adjustments are maintained.

FASTPATH:

For more information about adjustments, refer to [The Big Picture Of Adjustments](#).

The Lifecycle Of An Adjustment

The following diagram shows the possible lifecycle of an adjustment.

WARNING:

This diagram only makes sense in the context of the page used to maintain Adjustments. Refer to [Adjustment - Main Information](#) for the details.

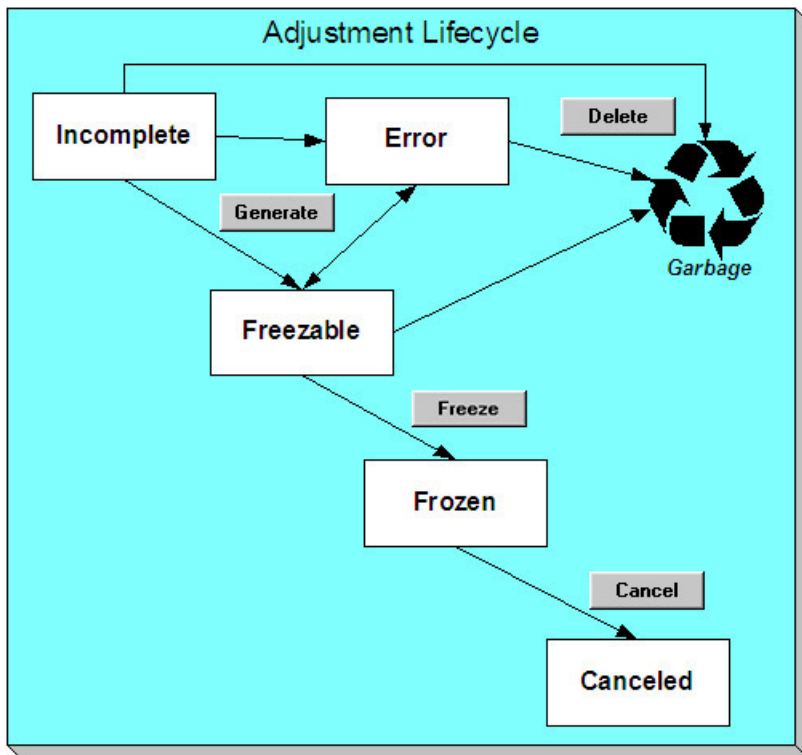

NOTE: Even though New is considered a valid adjustment state, this is only used as default when adding an adjustment. Once the adjustment is saved, it is assigned the appropriate state in the adjustment life cycle. An adjustment will never exist in the New state.

Adjustments are initially created in the Incomplete state. Adjustments in this state don't have a financial transaction. This means, you can change the adjustment type and amount at will.

Click **Generate** to generate a financial transaction for the adjustment. The financial transaction contains the adjustment's effect on the general ledger and on the customer's payoff and current balances. If the adjustment is calculated, the algorithm on the adjustment type's Generate Adjustment event controls how the adjustment is calculated. If the adjustment is calculated, you must specify the calculation date, which is passed as a parameter to the calculation algorithm and is used for calculations that are effective dated (e.g., rate version or bill factor value). The financial transaction (FT) algorithm defined on the adjustment type Adj. Financial Transaction event controls how the financial transaction is constructed. For calculated adjustments, the distribution code may be taken from the adjustment type or the calculation lines.

After generating the financial transaction, the adjustment becomes Freezable. While in this state, you may change the service agreement, adjustment type and amount at will. However, if you change this information, you will have to regenerate the financial transaction (by clicking the Generate button).

In the very rare situation when the system cannot generate the financial transaction because of inconsistent setup data, the adjustment is moved to the Error state. You may regenerate the financial transaction after correcting the source of the error. You may also delete such an adjustment.

Click the delete button to physically remove an Incomplete, Error or Freezable adjustment from the database.

WARNING:

Please be aware that you can prevent specific types of adjustments from being frozen until the account's next bill is completed. Refer to [Preventing SA Balances And The GL From Being Impacted Until Bill Completion](#) for how to enable this feature on your adjustment types.

Click **Freeze** to freeze the adjustment and its financial transaction. After doing this, the adjustment's state becomes Frozen. While in this state, you cannot change the adjustment's type or amount, but you may change:

- When the adjustment starts aging.
- Whether the adjustment appears on a customer's bill.
- The accounting date used to derive the general ledger accounting period(s) to which the financial transaction is booked.

NOTE:

Adjustments may require approval. If the adjustment type referenced on the adjustment has an approval profile, the Freeze button is replaced with a Submit for Approval button. If an adjustment is currently being approved, all action buttons are disabled because the adjustment must be either approved or rejected using the [Adjustment - Approval](#) page.

However, the Delete button is enabled for an adjustment in a freezable state and linked to an approval request that is in a “no approval necessary” state. If the adjustment is deleted a log entry is created on the associated approval request.

Refer to [The Big Picture of Adjustment Approvals](#) for more information.

If you need to remove the financial effects of an adjustment, click **Cancel**. Canceling an adjustment causes the generation of another financial transaction. This new financial transaction reverses the financial impact of the original adjustment.

Adjustment - Main Information

FASTPATH:

The **Description of Page** section below describes the fields on this page. Refer to [How and When To Use An Adjustment](#) for instructions describing how to perform common maintenance functions.

The Main page contains core adjustment information. Open this page using **Menu > Financial > Adjustment > Search**.

WARNING:

All adjustments reference a very important field that controls much validation and processing; this field is called Adjustment Type. Take special care when adding a new adjustment to specify the appropriate Adjustment Type as it affects how the adjustment appears on the customer's bill, how the adjustment is reflected in your general ledger, and much more. After the adjustment is frozen, you may not change its Adjustment Type.

Description of Page

Adjustment Info contains a concatenation of the adjustment amount, adjustment type and status.

NOTE:

Formatting may be performed by a plug-in. The contents of **Adjustment Info** may be formatted by a plug-in algorithm on the [Adjustment Type](#). Refer to the base package's C1-ADT-INFO for an example. If such an algorithm is not plugged-in on the Adjustment Type, the system looks for a corresponding algorithm on the [installation record](#). Refer to the base package's C1-ADI-INFO for examples. If you prefer different formatting logic, your system administrator should configure the system appropriately.

Adjustment ID is the system-assigned, unique identifier of the adjustment.

Account ID is the account to which the adjustment is linked. The name of the main person on the account appears next to the account ID.

Use **Service Agreement ID** to define the service agreement whose value needs to be adjusted. Basic information about the service agreement appears adjacent.

Premise is a display-only field that shows the **Service Agreement's** characteristic premise (i.e., the primary premise associated with the service agreement).

Indicate the **Adjustment Type**. This field is very important as it controls numerous aspects of the adjustment's impact on the customer's balance and your general ledger. This field is gray after the adjustment is frozen.

NOTE:

You can only choose certain adjustment types. The service agreement's SA type has a collection of valid adjustment profiles. You may only reference adjustment types that are listed in one of the adjustment type profiles linked to the SA type.

The list of adjustment types is also restricted to those without a CIS Division and those with a CIS Division that matches the service agreement's CIS Division.

Enter the **Amount** of the adjustment. If the adjustment type is a calculated adjustment, the **Calculated Amount** and **Calculation Date** are displayed. The values of the calculated amount and calculation date are displayed after the adjustment is generated. The calculated amount shows the result of the generate adjustment algorithm. The calculation date is specified when you click Generate for a calculated adjustment type. It is used by the generate adjustment algorithm for any calculations that are effective dated (e.g., rate version calculation group or bill factor value).

NOTE:

Default note. The adjustment amount defaults based on the adjustment type. When you change the adjustment type, the amount changes accordingly. You may change the adjustment amount after it is defaulted.

On Behalf SA ID is a display-only field that is only populated on system-generated adjustments instigated by one customer, but attributed to another customer. For example, if chargeable field work is performed for a customer, but is payable by the customer's meter maintenance service provider, the adjustment will be linked to the service provider and will reference the customer's SA as its **On Behalf SA ID**. This field is only visible if it is populated on the adjustment.

You may not change an adjustment's **Adjustment Status** directly. Rather, you use the buttons in the **Adjustment Actions** area. Refer to [The Lifecycle Of An Adjustment](#) for the details.

If the status is canceled, the **Cancel Reason** is displayed.

Use the **Comments** to describe anything unusual about the adjustment.

The **Creation Date** defines the date on which the adjustment was created.

If the adjustment is subject to approval, a message indicating such appears. Clicking this message navigates the user to the **Approvals** tab. Refer to [The Big Picture of Adjustment Approvals](#) for more information.

The financial transaction (FT) grid contains the financial transactions associated with the adjustment. It only contains information after the adjustment is frozen. If the adjustment is canceled, a second row appears showing the details of the cancellation FT.

- **Financial Transaction ID** is the system-assigned unique identifier of the FT. Click the go to button to transfer to the financial transaction. On this page you can change certain aspects of the FT in question.
- **Arrears Date** is the date the FT starts aging.
- **Accounting Date** is the date the system uses to determine the FT's accounting period in your general ledger.
- **Current Amount** contains the FT's effect on the service agreement's current balance.
- **Payoff Amount** contains the FT's effect on the service agreement's payoff balance.
- **Bill ID** is the bill on which the FT appears (if it has been swept onto a bill). Click the adjacent go to button to transfer to the bill on which the FT appears. Note: an FT is linked to a bill the next time a bill is completed for the service agreement's account.

The **Calculation Lines** grid contains the details of the calculations associated with a [calculated adjustment](#). It only appears if the rate that calculated the adjustment amount created at least one calculation line. One row exists for every calculation

involved in the process. This information is for audit purposes only and cannot be modified. The following information displays in the grid:

- If at least one of the calculation lines has characteristics, **Calc Line Char** displays go to buttons, allowing you to go to characteristics that are linked to a specific adjustment calculation line. This column is only displayed if at least one of the calculation lines has characteristics.
- **Sequence** is the system-assigned unique identifier of the calculation detail row.
- **Description on Bill** is the information about the calculation line that appears on the customer's bill.
- **Calculated Amount** is the calculated amount associated with the calculation line.
- The **Print** switch controls whether information about this line will print on the customer's bill.
- The **Appears in Summary** switch defines if this line's amount also appears on a summary line. This switch plays a part at bill print time - those lines that appear in a summary print in the left dollar column, those that don't appear in a summary print in the right dollar column.
- **Unit of Measure (UOM)** is the unit of measure of the service quantity priced on the calculation line.
- **Time of Use (TOU)** is the time-of-use code of the service quantity priced on the calculation line.
- **SQI** is the service quantity identifier of the service quantity priced on the calculation line.
- **Billable Service Quantity** is the service quantity priced on the calculation line. This quantity differs from the measured consumption if there are pre-processing calculation groups in effect.
- **Base Amount** is used by calculation lines (e.g. taxes) that are cross-referenced to other calculation lines and whose value(s), therefore, depend on the amounts calculated by those other lines. The Base Amount shows the total amount derived from the cross-referenced line(s) that the current line then used to calculate its billed amount.
- **Rate Component Sequence** refers to the sequence number of the rate component on the applicable rate version calculation group that was used to calculate the line. This is only populated if the original rate engine calculated the charges.
- **Calculation Rule** is the rule that calculated the line. This is only populated if the new rate engine calculated the charges.
- **Measures Peak Qty** is checked if the UOM priced on the calculation line is used to measure a peak quantity.
- **Exempt Amount** is the amount of the calculated charge that the customer doesn't have to pay because they are tax exempt.
- **Distribution Code** is the distribution code associated with the calculation line. This distribution code is used to build the general ledger details on the bill segment's financial transaction.
- **Description** describes the characteristic value that was used when the line's amount was calculated. This information is only displayed if the line was calculated using a bill factor (because only bill factors use characteristic values). Refer to [An Illustration Of A Bill Factor And Its Characteristics](#) for more information.

FASTPATH:

For more information, refer to [Calculated Adjustments](#).

The **Adjustment Actions** area contains buttons that you use to commit and cancel the adjustment's financial impact. The adjustment's status controls the button you can see and select. Refer to [The Lifecycle Of An Adjustment](#) for the details.

WARNING:

Please be aware that you can prevent specific types of adjustments from being frozen until the account's next bill is completed. Refer to [Preventing SA Balances And The GL From Being Impacted Until Bill Completion](#) for how to enable this feature on your adjustment types.

Cancel may not be enabled. The cancel button is not enabled if the adjustment is linked to a bill that is written off.

NOTE:

Canceling An Accounts Payable (A/P) Adjustment. If you need to cancel an A/P adjustment (i.e. an adjustment of an adjustment type that has an A/P request type) that has already been extracted by A/P, refer to [How To Cancel An A/P Adjustment After It's Been Selected By A/P](#).

Adjustment - Characteristics

You use this page to link additional information to the adjustment. Open using **Menu > Financial > Adjustment > Search** and navigate to the **Characteristics** page.

Description of Page

The characteristics collection contains information that describes miscellaneous information about the adjustment.

NOTE:

Characteristic Types. You can only choose characteristic types defined on the adjustment's [adjustment type](#).

The following fields display:

Characteristic Type Indicate the type of characteristic.

Characteristic Value Indicate the value of the characteristic.

NOTE:

Default Note. An adjustment's characteristics default from the [adjustment type](#).

Adjustment - Transfer Adjustment

FASTPATH:

The **Description of Page** section below describes the fields on this page. Refer to [How and When To Use An Adjustment](#) for instructions describing how to perform common maintenance functions.

The Transfer Adjustment is used to define the reciprocal adjustment associated with a transfer adjustment (there are always two adjustments associated with a transfer). Open using **Menu > Financial > Adjustment > Search**.

The Main page describes one side of the transfer adjustment; for example, the “transfer from” adjustment. As well, the Transfer Adjustment page describes the reciprocal adjustment; for example, the “transfer to” adjustment.

Description of Page

Adjustment Info contains a concatenation of the adjustment amount, adjustment type and status.

Adjustment ID is the system-assigned, unique identifier of the adjustment.

Account ID is the account to which the adjustment is linked. The name of the main person on the account appears next to the account ID.

Use **Service Agreement ID** to define the transfer to service agreement. Basic information about the service agreement appears adjacent.

Premise is a display-only field that shows the **Service Agreement's** characteristic premise (i.e., the primary premise associated with the service agreement).

The **Adjustment Type** and adjustment **Amount** from the first page are displayed. If you need to change either value, return to the first page.

Adjustment Status shows the status of the transfer to adjustment. If you need to change the adjustment's status, use the action buttons.

Use the **Comments** to describe anything unusual about the adjustment.

Transfer Adj ID is the system-assigned, unique identifier of the adjustment.

The **Creation Date** defines the date on which the adjustment was created.

The financial transaction grid contains the financial transactions associated with the adjustment. It only contains information after the adjustment is frozen. If the adjustment is canceled, a second row appears showing the details of the cancellation FT.

- **Financial Transaction ID** is the system-assigned unique identifier of the FT. Click the go to button to transfer to the financial transaction. On this page you can change certain aspects of the FT in question.
- **Arrears Date** is the date the FT starts aging.
- **Accounting Date** is the date the system uses to determine the FT's accounting period in your general ledger.
- **Current Amount** contains the FT's effect on the service agreement's current balance.
- **Payoff Amount** contains the FT's effect on the service agreement's payoff balance.
- **Bill ID** is the bill on which the FT appears (if it has been swept onto a bill). Click the adjacent go to button to transfer to the bill on which the FT appears. Note: an FT is linked to a bill the next time a bill is completed for the account.

Adjustment - A/P Request

FASTPATH:

The **Description of Page** below describes the fields on this page. Refer to [How and When To Use An Adjustment](#) for instructions describing how to perform common maintenance functions.

The A/P Request page contains information about adjustments used to refund money via an A/P check request. This page is only relevant if:

- The adjustment's adjustment type references an A/P Request Type (i.e., it will be interfaced to your accounts payable system which will cut the check), AND
- The adjustment is frozen.

Open this page using **Menu > Financial > Adjustment > Search** and navigate to the **A/P Request** page.

Description of Page

Adjustment Info contains a concatenation of the adjustment amount, adjustment type and status.

Adjustment ID is the system-assigned, unique identifier of the adjustment.

Account ID is the account to which the adjustment is linked.

NOTE:

Adjustment type controls A/P check requests. The A/P Request information is populated when an adjustment used to refund money via an A/P check request is frozen. Whether or not an adjustment is interfaced to A/P is controlled by the adjustment's adjustment type. The adjustment type's A/P Request Type controls the payment date and the bank.

Name is the name printed on the check. This name is derived from the account's main person:

- If this person has an override mailing name, the first line of the override mailing name is used.

- If this person does not have an override mailing name, the person's primary name is used.

Payment Selection Status is the status of the check request. The values are:

- Not Selected for Payment before it's selected by A/P for payment
- Requested for Payment after it's selected by A/P
- Paid after it's paid by A/P
- Canceled if it's been canceled in A/P
- Hold if it's been held in A/P

Scheduled to Pay is the date on which the check is scheduled to be cut. This is equal to the adjustment date plus the Due Days on the adjustment type's A/P request type.

The following fields are provided in order to support a two-way interface with an A/P system. The system provides the inbound web service C1-UpdateAPCheckRequest that can be used to update these fields.

- **PaymentDate** is the date on which the check was cut in A/P. This field is only populated after A/P cuts the check.
- **Paid Amount** is the amount of the check. This field is only populated after A/P cuts the check.
- **A/P Request ID** is the system-assigned, unique identifier of the A/P check request.
- **Payment Number** is the system-assigned number of the payment in A/P (this number typically appears on the printed check). This field is only populated after A/P cuts the check.

The address information in the bottom frame is the address to which the check is mailed. This is the billing address of the main customer linked to the account. After the adjustment is frozen, this information is automatically populated based on the address information for the account. This information is only modifiable when the Payment Selection Status is Not Selected for Payment.

Adjustment - Adjustment Portal

Select **Menu > Financial > Adjustment > Search** and navigate to the **Adjustment Portal** page to view additional information associated with an Adjustment.

Depending on your implementations requirements, you may define additional zones to appear on this Portal.

The contents of this section describe the zones that are available on this portal page.

General Information

Adjustment ID, **Adjustment Info** are displayed.

Adjustment - Approval

This page only appears after an adjustment has started the approval process. Open this page using **Menu > Financial > Adjustment > Search** and navigate to the **Approval** page.

FASTPATH:

Refer to [The Big Picture of Adjustment Approvals](#) for more information about the approval process.

The topics in this section describe the base-package zones that appear on the Approval Profile portal.

Adjustment Information

The Adjustment Information zone contains display-only information about the adjustment.

Approval Request

The Approval Request zone shows the current and future approvers of an adjustment. This zone only appears if the adjustment is in the approval process.

If the current user has approval authority, the following functions are available:

- **Approve:** to approve the adjustment.
- **Reject:** to reject the adjustment.

Approval Request Log

The Approval Request Log zone contains the history of the adjustment's approval.

Financial - Adjustment Calculation Line Characteristics

This page displays the characteristics that are linked to a specific adjustment calculation line. The information on this page is for audit purposes only and cannot be changed.

Open this page by clicking on the characteristics go to button on the calculation lines grid of the [Adjustment - Main](#) page.

Description of Page

Account is the account to which the adjustment is linked. The name of the main person on the account appears next to the account ID.

The **SA** is the service agreement whose value needs to be adjusted. Basic information about the service agreement appears adjacent.

Premise shows the service agreement's characteristic premise (i.e., the primary premise associated with the service agreement).

The **Adjustment Info** displays information to identify the adjustment, including amount, type, and status.

Adjustment ID displays the identification of the adjustment, and **Calc Line** displays the calculation line with which the characteristics are associated.

The **Description on Bill** displays the description of the calculation line that appears on the customer's bill.

The characteristics grid displays the **Characteristic Types** and the **Characteristic Values** associated with the calculation line.

FASTPATH:

For more information about characteristics, refer to [Setting Up Characteristic Types and Their Values](#).

How and When To Use An Adjustment

NOTE:

A last resort. Adjustments should be viewed as a last resort because you should correct the cause of errors, rather than the effect. For example, if a customer's bill is incorrect, you should fix the customer's rate / meter reads / contract terms and then perform a cancel / rebill. Issuing an adjustment to fudge the balance is really just that - a fudge.

The topics in this section describe how to perform common adjustment maintenance functions.

How To Create A Transfer Adjustment

The following steps describe how to create a transfer adjustment on the Adjustment page.

NOTE:

You cannot use an adjustment type with a calculated amount for transfer adjustments.

WARNING:

These steps only make sense in the context of the page used to maintain Adjustments. Refer to [Adjustment - Main Information](#) for the details.

To create a transfer adjustment:

- Specify the "transfer from" account and service agreement on the Adjustment - Main page.
- Specify the adjustment type and the amount and transfer to the Transfer Adjustment page.
- Specify the "transfer to" service agreement and click the **Generate** and **Freeze** buttons to generate and freeze the adjustments' financial transactions. Please be aware that the **Freeze** button may be disabled for certain types of adjustments. This is because you can prevent specific types of adjustments from being frozen until the account's next bill is completed. Refer to [Preventing SA Balances And The GL From Being Impacted Until Bill Completion](#) for how to enable this feature on your adjustment types.

How To Create A Calculated Adjustment

The following steps describe how to create a [calculated adjustment](#) on the Adjustment page.

WARNING:

These steps only make sense in the context of the page used to maintain Adjustments. Refer to [Adjustment - Main Information](#) for the details.

To create a calculated adjustment:

1. Open **Menu > Financial > Adjustment > Add** and specify the **Service Agreement** that will receive the adjustment.
2. Specify the **Adjustment Type** that calculates the amount, and enter a base **Amount**.
3. Click **Generate**. The **Generate** dialog box opens.
4. In the resulting dialog box, specify an **Accounting Date** and **Generation Reference Date**. Click **Calculate**.
5. Click **Freeze** to freeze the calculated transactions.

The **Calculation Date** that you supply is used by the generate adjustment algorithm for any calculations that are effective dated (e.g., rate version calculation group or bill factor value).

Please be aware that the **Freeze** button may be disabled for certain types of adjustments. This is because you can prevent specific types of adjustments from being frozen until the account's next bill is completed. Refer to [Preventing SA Balances And The GL From Being Impacted Until Bill Completion](#) for how to enable this feature on your adjustment types.

How To Cancel An A/P Adjustment After It Has Been Selected By A/P

Adjustments that are interfaced to A/P (because A/P needs to cut a refund check) sometimes need to be canceled. You may cancel an A/P adjustment in the CIS system while its A/P request is Not Selected. If the A/P request is Requested for Payment or Paid you must first cancel the payment in A/P. Canceling the payment in A/P changes the A/P request in CIS to Canceled. At this point, you can cancel the adjustment in CIS.

How To Correct Normal Service Agreement Debt

If a customer is unhappy with the balance on a "normal" service agreement and you cannot fix the source of their unhappiness (i.e., the bills and payments), create an adjustment. Simply select an adjustment type that describes why you are adjusting the balance and enter the amount of the adjustment (a negative number if you are crediting the customer).

NOTE:

What's normal? There really is no such thing as a "normal" service agreement. We use this term to reference service agreements used to bill for services like utility service, land leases, home warranties, security monitoring, etc. where the current amount is the same as the payoff amount.

WARNING:

A service agreement that is part of a budget plan is NOT normal. Refer to [How To Adjust A Service Agreement On A Budget](#) for more information.

How To Apply Ad Hoc Fees To A Service Agreement

If you need to apply a fee (e.g., late payment charge, connection charge, NSF charge) to a "normal" service agreement, issue an adjustment using the appropriate adjustment type. The adjustment amount should be a positive number so that the customer's balance increases.

WARNING:

Take care if you apply a fee to a service agreement that's on a budget. The adjustment affects current balance and payoff balance by the amount of the fee. If you didn't mean to affect the customer's current balance, you'll have to issue another adjustment to change it.

How To Apply Interest To A Deposit

FASTPATH:

You should only have to issue adjustments to calculate and refund interest if you need to override the system's automated procedures. Refer to [Controls Interest Calculation](#) for the details.

If you need to manually apply interest to a deposit, issue an adjustment using the appropriate adjustment type. The adjustment amount should be a negative number (you are crediting the customer's deposit balance).

If you want to apply the interest to the customer's outstanding balance, refer to [How To Apply A Deposit To Outstanding Debt](#).

If you want to cut a check for the deposit, refer to [How To Refund A Deposit With A Check](#).

How To Apply A Deposit To Outstanding Debt

FASTPATH:

You should only have to issue adjustments to apply a deposit to outstanding debt if you need to override the system's automated procedures. Refer to [Refunding Deposits](#) for the details.

Applying a deposit is a two-step process:

- The deposit service agreement's payoff balance contains the amount of deposit you are holding on behalf of the customer's debt. Its current balance should be zero (i.e., the customer doesn't owe any additional deposit). Before you apply the deposit balance, we recommend making the deposit's current balance equal to the amount to be transferred. You do this by issuing an adjustment that just affects the deposit's current balance. The amount of this adjustment should be a negative number.
 - After the deposit's current balance reflects an appropriate credit amount (equal to the amount to be applied to the customer's debt), use the Transfer Adjustment process to apply the deposit's credit balance to another service agreement's debit balance. The deposit service agreement is the transfer from service agreement; the delinquent service agreement is the transfer to service agreement. The adjustment amount should be a positive number. Refer to [How To Create A Transfer Adjustment](#) for more information.
-

WARNING:

Take care if you apply a deposit to a service agreement that's on a budget. The transfer adjustment affects current balance and payoff balance by the same amount. If you didn't mean to affect the customer's current balance, you'll have to issue another adjustment to change it.

How To Refund A Deposit With A Check

FASTPATH:

You should only have to issue adjustments to apply a deposit to outstanding debt if you need to override the system's automated procedures. Refer to [Refunding Deposits](#) for the details.

Refunding a deposit with a check (cut by your A/P system) is a two step process:

- The deposit service agreement's payoff balance contains the amount of deposit you are holding on behalf of the customer's debt. Its current balance should be zero (i.e., the customer doesn't owe any additional deposit). Before you refund the deposit balance, we recommend making the deposit's current balance equal to the amount to be refunded. You do this by issuing an adjustment that just affects the deposit's current balance. The amount of this adjustment should be a negative number.
- After the deposit's current balance reflects an appropriate credit amount (equal to the amount to be refunded), issue a refund adjustment. The adjustment amount should be a positive number. This adjustment causes a check request to be interfaced to your A/P system.

How To Write-Down Deposit Due

If a customer doesn't pay their deposit and you don't expect them to, create an adjustment to write-down the current balance. Simply select an adjustment type that describes why you are adjusting the balance and enter the amount of the adjustment (a negative number).

How To Refund A Credit Balance With A Check

If you need to refund a credit balance on a "normal" service agreement, issue a refund adjustment using the appropriate adjustment type. The adjustment amount should be a positive number. This adjustment causes a check request to be interfaced to your A/P system.

WARNING:

Take care if you refund a credit balance from a service agreement that's on a budget. The adjustment affects current balance and payoff balance by the amount of the refund. If you didn't mean to affect the customer's current balance, you'll have to issue another adjustment to change it.

How To Transfer A Credit Balance To A Service Agreement In Arrears

Use the Transfer Adjustment process to apply a "normal" service agreement's credit balance to another service agreement's debit balance. The credit service agreement is the transfer from service agreement; the delinquent service agreement is the transfer to service agreement. The adjustment amount should be a positive number. Refer to [How To Create A Transfer Adjustment](#) for more information.

WARNING:

Take care if you apply a credit to a service agreement that's on a budget. The transfer adjustment affects current balance and payoff balance by the transfer amount. If you didn't mean to affect the customer's current balance, you'll have to issue another adjustment to change it.

How To Change The Age Of Debt

If a service agreement's debt is older (or younger) than what it should be (for whatever reason), you should do the following.

- Use the Transfer Adjustment process to re-age the debt. The transfer from and transfer to service agreements will be the same. The adjustment amount should be a negative number. Refer to [How To Create A Transfer Adjustment](#) for more information.
- After creating the transfer adjustment, drill into the transfer to adjustment and populate the arrears date with the day on which the debt should start aging (e.g., if the debt should be 7 days old, the arrears date should be the current date minus 7 days).

WARNING:

Be careful if you transfer debt from a service agreement that's on a budget. Before doing the transfer, you should make the customer's current balance equal their payoff balance.

How To Write-Down A Charitable Contribution Service Agreement Debt

If a customer doesn't want to contribute as much to the charity as the agreed to, create an adjustment to fix the current balance (charity service agreements shouldn't have a payoff balance as the "debt" is voluntary). Simply select an adjustment type that describes why you are adjusting the balance and enter the amount of the adjustment (a negative number).

How To Write-Off Debt

To write-off debt:

WARNING:

You don't have to do the tasks outlined below if you use the [Write Off - Main](#) page. This page does these tasks for you.

- Create a write-off service agreement using the Start Service page (you could also use the Service Agreement page to do this).
 - Use the Transfer Adjustment process to transfer the delinquent debt to the to the write-off service agreement. The original service agreement is the transfer from service agreement; the write-off service agreement is the transfer to service agreement. The adjustment amount should be a negative number. Refer to [Transfer Adjustments](#) for more information.
-

WARNING:

Take care if you transfer debt from a service agreement that's on a budget. Before doing the transfer, you should make the service agreement's current balance equal their payoff balance.

How To Cancel A Service Agreement's Budget

WARNING:

You don't have to do the tasks outlined below if you use the [Account - Budget](#) panel. This panel does these tasks for you.

Canceling a service agreement's budget involves the following steps:

- Update the service agreement to indicate the service agreement is no longer on a budget.
 - Issue an adjustment to make the service agreement's current balance equal the payoff balance.
-

NOTE:

Credit and collections (C&C). You can change the arrears date on the adjustment that synchronizes current and payoff balance to reflect the true age of the debt. You do this on the financial transaction associated with the adjustment. If you do this, C&C will monitor the old debt accordingly.

How To Adjust A Service Agreement On A Budget

If you need to adjust the debt on a service agreement that's on a budget plan, you have to ask yourself why you're adjusting the balance:

- If you're adjusting the balance to correct the payoff balance (for whatever reason), choose an adjustment type that just affects this balance.
- If you're adjusting the balance to correct the current balance (for whatever reason), choose an adjustment type that just affects this balance.
- If you need to adjust both balances equally, choose an adjustment type that affects both.

How To Adjust An Installment Plan Service Agreement

If you need to adjust the debt on a service agreement that's used to bill a total amount in installments, you have to ask yourself why you're adjusting the balance:

- If you're adjusting the balance to correct the payoff balance (for whatever reason), choose an adjustment type that just affects this balance.
- If you're adjusting the balance to correct the current balance (for whatever reason), choose an adjustment type that just affects this balance.

If you need to adjust both balances equally, choose an adjustment type that affects both.

How To Use An Adjustment To Change The GL Distribution

Assume you have a frozen bill segment that affected an incorrect GL distribution code (e.g., it booked revenue to commercial - time-of-use - revenue and it should have booked it to industrial - time-of-use - revenue. You have two ways to correct such a situation:

- You could correct the cause of the incorrect distribution code (probably incorrect GL information on a calculation rule/ pricing rule) and cancel / rebill the bill segment. Refer to [Cancel / Rebill](#) for more information about this method.
- You could create an adjustment that does not impact the customer's balance but does have a GL entry. This GL entry would reverse the effect of the original distribution code and have an offsetting entry to the correct distribution code. The following points explain how to do this:
 - Choose an adjustment type that only impacts the GL (i.e., the adjustment's adjustment type has an FT algorithm that doesn't impact the customer's current or payoff balance, it only impacts the GL).
 - Enter an adjustment amount of zero.
 - Generate the adjustment.
 - Drill into the adjustment's [financial transaction](#) and enter two (or more) GL distribution rows that reflect the redistribution of the amounts.
 - Return to the adjustment and freeze it.

NOTE:

Adjusting statistical amounts. You can use the above approach to change the statistical amount that is interfaced to the general ledger. The statistical amount is simply another column on the financial transaction's GL distribution rows.

Interfacing Adjustments From External Sources

The topics in this section describe how adjustments are uploaded from an external source.

Interfacing Adjustments

The following diagram illustrates the processes involved in the uploading of adjustments into the system.

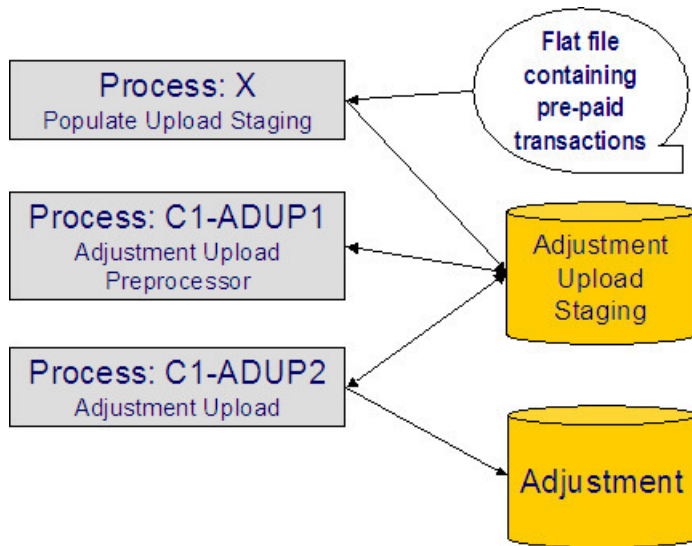

The topics in this section describe how these processes work.

Process X - Populate Adjustment Upload Records

Process X refers to the mechanism used by your organization to populate the various staging tables (shown in the orange section of the following ERD).

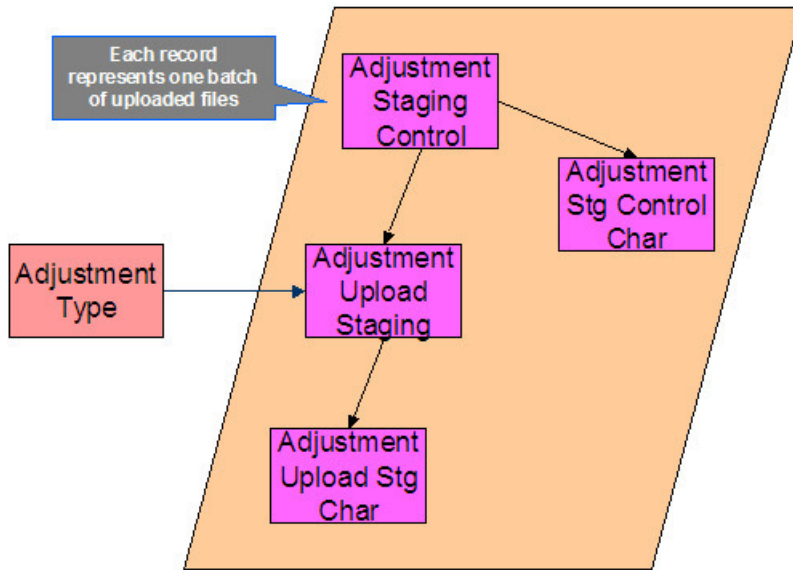

The topics in this section describe each of these tables.

Adjustment Staging Control

You must create an adjustment staging control record for each batch of adjustments to be uploaded into the system. The name of this table is CI_ADJ_STG_CTL. The following describes each column on this table.

Column Name	Length	Req'd	Data Type	Comments
ADJ_STG_CTL_ID	12	Y	N	This is the unique identifier of the adjustment staging control record. This key is a sequential number so you can use a database function to assign the value when populating the table.
CRE_DTTM	15	Y	DateTime	This is the date / time on which the adjustment staging control record was created. This must be populated with the current date / time.
ADJ_STG_CTL_STATUS_FLG	4	Y	A/N	This must be set to P for Pending.
ADJ_STG_UP_REC_CNT	10	Y	N	This is the total number of adjustment upload staging records that are linked to this adjustment staging control.
TOT_ADJ_AMT	13.2	Y	N	This column must equal the sum of

				adjustment amounts on the adjustment upload staging records that are linked to this adjustment staging control.
CURRENCY_CD	3	Y	A/N	This must be a valid currency code in the system. Refer to Defining Currency Codes for more information.
MESSAGE_CATEGORY	5	N	N	Leave this blank. The adjustment upload preprocessor populates this when an error occurs during upload.
MESSAGE_NBR	5	N	N	Leave this blank. The adjustment upload preprocessor populates this when an error occurs during upload.

Adjustment Staging Control Characteristic

You must create an adjustment staging control characteristic record for each characteristic that you would like to link to the adjustment staging control. The name of this table is CI_ADJ_STG_CTL_CHAR. The following describes each column on this table.

Column Name	Length	Req'd	Data Type	Comments
ADJ_STG_CTL_ID	12	Y	N	This must correspond with the prime key of the related CI_ADJ_STG_CTL record.
CHAR_TYPE_CD	8	Y	A/N	This must correspond with a characteristic type that is defined as valid for adjustment staging control. Refer to Setting Up Characteristic Types & Their Values for more information.
SEQ_NUM	3	Y	N	This should be set to 10 unless you have multiple values for a given adjustment staging control and characteristic type.
CHAR_VAL	16	N	A/N	Populate this field if your characteristic type is predefined.

ADHOC_CHAR_VAL	254	N	A/N	Populate this field if your characteristic type is ad-hoc or file location.
CHAR_VAL_FK1 - CHAR_VAL_FK5	50 each	N	A/N	Populate these fields if your characteristic type is foreign key reference. Up to five columns of 50 bytes each are provided to accommodate compound keys.

Adjustment Upload Staging

You must create an adjustment upload staging record for each adjustment you want to upload. The name of this table is CI_ADJ_STG_UP. The following describes each column on this table.

Column Name	Length	Req'd	Data Type	Comments
ADJ_STG_UP_ID	12	Y	N	This is the unique identifier of the adjustment upload staging record. This key is a sequential number so you can use a database function to assign the value when populating the table.
ADJ_STG_CTL_ID	12	Y	N	The ID of the adjustment staging control that is linked to this adjustment upload staging record.
ADJ_TYPE_CD	8	Y	A/N	This must correspond to the prime key of one of your adjustment types. Refer to Setting up Adjustment Types for more information.
ADJ_STG_UP_STATUS_FLG	4	Y	A/N	This must be set to P for Pending.
CREATE_DT	10	Y	Date	The date when the adjustment occurred.
ADJ_AMT	13.2	Y	N	The amount of the adjustment.
ADJ_SUSPENSE_FLG	4	Y	N	This must be set to NSUS for Not In Suspense.
SA_ID	10	N	A/N	This must correspond to a valid service agreement in the system.

If you leave this blank and opt to let the system find the SA during adjustment upload preprocessing, a Determine SA algorithm must be plugged in on the associated adjustment type. This plug-in is meant to derive the SA ID based on supplied miscellaneous information - e.g. information supplied via adjustment characteristic upload staging.

ADJ_ID	10	N	A/N	Leave this blank. The adjustment upload process populates this.
SUSPENSE_ADJ_ID	10	N	A/N	Leave this blank. The adjustment upload process populates this.
MESSAGE_CATEGORY	5	N	N	Leave this blank. The adjustment upload background processes populate this when an error occurs during upload.
MESSAGE_NBR	5	N	N	Leave this blank. The adjustment upload background processes populate this when an error occurs during upload.

Adjustment Characteristic Upload Staging

You must create an adjustment characteristic upload staging record for each characteristic that you would like to link to the adjustment upload staging. The name of this table is CI_ADJ_STG_UP_CHAR. The following describes each column on this table.

Column Name	Length	Req'd	Data Type	Comments
ADJ_STG_UP_ID	12	Y	N	This must correspond with the prime key of the related CI_ADJ_STG_UP record.
CHAR_TYPE_CD	8	Y	A/N	This must correspond with a characteristic type that is defined as valid for adjustment Refer to

[Setting Up Characteristic Types & Their Values](#) for more information.

SEQ_NUM	3	Y	N	This should be set to 10 unless you have multiple values for a given adjustment upload staging and characteristic type.
CHAR_VAL	16	N	A/N	Populate this field if your characteristic type is predefined.
ADHOC_CHAR_VAL	254	N	A/N	Populate this field if your characteristic type is ad-hoc or file location.
CHAR_VAL_FK1 - CHAR_VAL_FK5	50 each	N	A/N	Populate these fields if your characteristic type is foreign key reference. Up to five columns of 50 bytes each are provided to accommodate compound keys.

The Lifecycle of an Adjustment Staging Control Record

The following diagram shows the possible lifecycle of an adjustment staging control record.

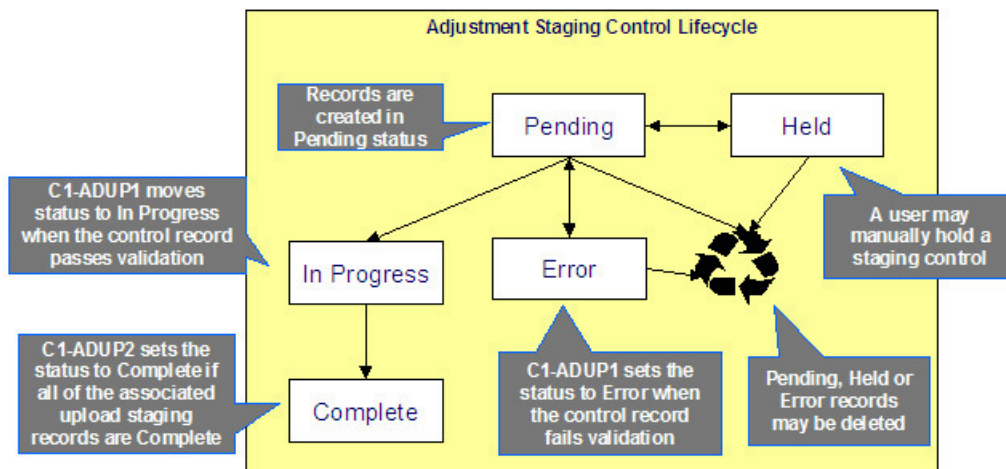

- **Pending.** An adjustment staging control record is created in this state. The C1-ADUP1 process selects pending adjustment staging control records for validation.
- **In Progress.** The C1-ADUP1 process sets a pending record to in progress when the totals on the adjustment staging control are successfully validated against the totals from the associated adjustment upload staging records.
- **Complete.** The C1-ADUP2 process sets the adjustment staging control's status to complete when all adjustment upload staging records linked to the adjustment staging control are complete.

- Error. The C1-ADUP1 process sets a pending record to error if the adjustment staging control fails validation. The status may be set back to pending after the error is fixed.
- Held. The held status is available for situations where you want to prevent or delay the upload of a batch of adjustment staging records. The status may be set back to pending when the batch of records is ready for upload.
- Pending, error and held records may be deleted.

The Lifecycle of an Adjustment Upload Staging Record

The following diagram shows the possible lifecycle of an adjustment upload staging record.

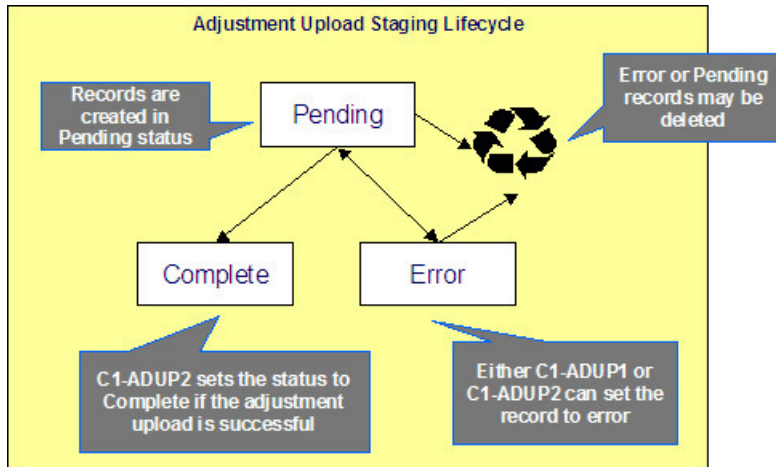

- Pending. Adjustment upload records are created in this state. The C1-ADUP2 process selects pending adjustment upload records and creates adjustments for each of them.
- Complete. The C1-ADUP2 process sets a pending record to complete if an adjustment is successfully created.
- Error. Either C1-ADUP1 or C1-ADUP2 process sets pending record to error when it encounters an error during the upload process. The status may be set back to pending after the error is fixed.
- Pending and error records may be deleted.

Process C1-ADUP1 - Preprocess Adjustment Uploads

The background process (C1-ADUP1) validates adjustment staging control records and populates service agreement IDs on adjustment upload staging records that do not specify an SA ID.

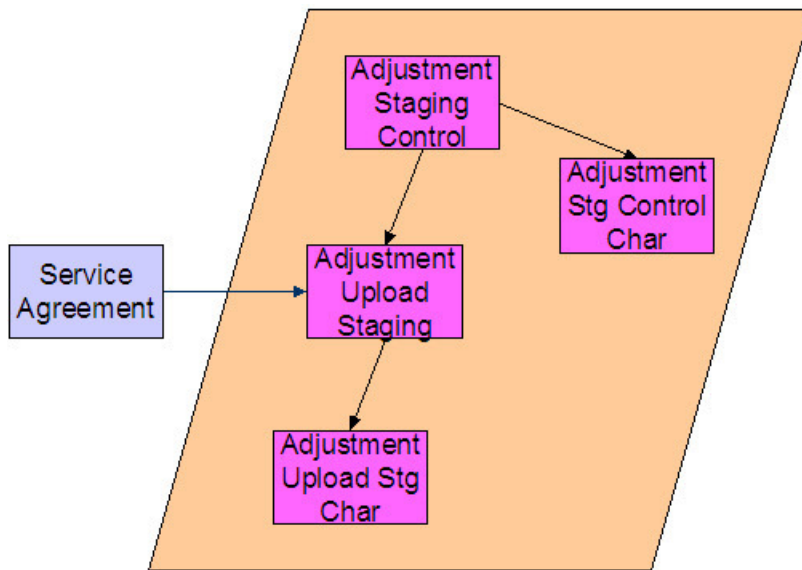

Phase 1 - Validate Adjustment Staging Controls

The following points describe, at a high level, the first phase of the adjustment upload pre-process:

- For each Pending adjustment staging control,
- Check that the record count on the adjustment staging control record equals the number of adjustment upload staging records that are linked to the adjustment staging control.
- Check that the total adjustment amount on the adjustment staging control record equals the sum of the adjustment amounts from the adjustment upload staging records that are linked to the adjustment staging control.
- If the adjustment staging control passes validation, set its status to In Progress. Otherwise, set the status to Error. Create a To Do entry using the inputs To Do type and To Do role (if supplied) for adjustment staging control errors. (Complete any outstanding To Do entries for the adjustment staging control before creating a new To Do entry.)
- If no errors occur, perform To Do cleanup by completing any outstanding To Do entries that were previously created for the adjustment staging control.

NOTE:

You can fix errors by going to the To Do entry and drilling into the adjustment staging control page. Don't forget to change the adjustment staging control's status back to Pending after fixing the error.

Phase 2 - Populate SA ID

The following points describe, at a high level, the second phase of the adjustment upload pre-process:

- For each Pending adjustment upload staging that is linked to an In Progress adjustment staging control AND does not have the SA ID,
- Execute the Determine SA algorithm that is plugged in on the [adjustment type](#).
- If the algorithm returns a valid SA ID, stamp that SA ID onto the adjustment upload staging. If the algorithm also returns an indication that the adjustment is to be put into suspense, set the suspense flag on the adjustment upload staging to In Suspense. Refer to [Suspense Adjustments](#) for more information on how suspense adjustments are handled.

- If the algorithm returns an error, set the adjustment upload staging record's status to Error. Create a To Do entry using the inputs To Do type and To Do role (if supplied) for adjustment upload staging errors. (Complete any outstanding To Do entries for the adjustment upload staging before creating a new To Do entry.)
- If no errors occur, perform To Do cleanup by completing any outstanding To Do entries that were previously created for the adjustment upload staging.

NOTE:

You can fix errors by going to the To Do entry and drilling into the adjustment upload staging page. Don't forget to change the adjustment upload staging's status back to Pending after fixing the error.

Process C1-ADUP2 - Upload Adjustments

The background process (C1-ADUP2) creates adjustments for all adjustment upload staging records that are stamped with an SA ID.

The following diagram and section describe, at a high level, the processing done in the C1-ADUP2 background process.

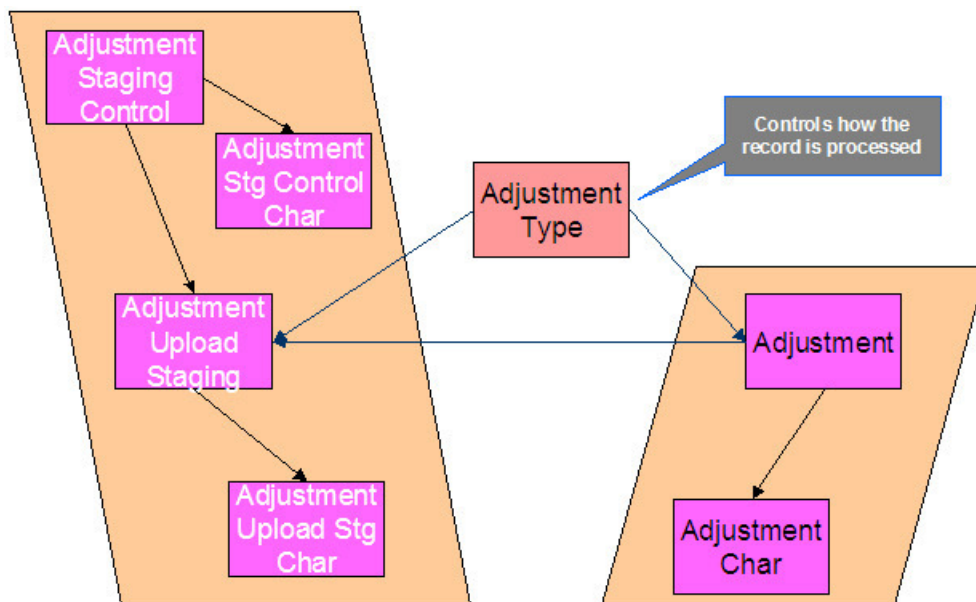

- For each Pending adjustment upload staging that has an SA ID,
- Add a frozen adjustment using the amount, creation date and adjustment type on the staging record.

NOTE:

If the type of adjustment being uploaded is one that is calculated, the algorithm that's plugged in on the adjustment type will calculate the adjustment amount and generate associated calculation lines (if applicable). See [Calculated Adjustments](#) for more information.

- If adjustment creation is successful, update the adjustment ID on the staging record and set the staging record's status to Complete.
- If adjustment creation results in an error, set the staging record's status to Error. Create a To Do entry using the To Do type on which this batch process (C1-ADUP2) is defined as creation process. (Complete any outstanding To Do entries for the adjustment upload staging before creating a new To Do entry.)

- If no errors occur, perform To Do cleanup by completing any outstanding To Do entries that were previously created for the adjustment upload staging.

Suspense Adjustments

What Are Suspense Adjustments?

When the adjustment upload preprocessor is unable to identify a valid SA ID, it can post the adjustment to a suspense SA. This is similar to how a payment is posted to a suspense account when a valid account ID could not be identified during payment upload.

Putting adjustments in suspense is optional. Therefore, this logic sits in a plug-in spot. If suspense adjustments are applicable to you, you must plug in your suspense logic in a Determine SA algorithm on [Adjustment Type](#).

How Are Suspense Adjustments Resolved?

A background process can be run periodically to automatically resolve suspense adjustments. Since rules for resolving suspense may vary, this logic sits in a plug-in spot. You must plug in your resolve logic in a Resolve Suspense algorithm on [Adjustment Type](#).

Process C1-ADURS - Resolve Suspense Adjustments

The batch process refers to the background process (C1-ADURS) that resolves suspense adjustments.

For each adjustment upload staging that is In Suspense, execute the Resolve Suspense algorithm that is plugged in on the [adjustment type](#).

Maintaining Adjustment Staging Control

Use this page to add, view or modify an adjustment staging control record. Open this page using **Menu > Financial > Adjustment Staging Control > Search**

Description of Page

Adjustment Staging Control ID is the unique identifier of the adjustment staging control record.

Create Date/Time is when the adjustment staging control was created. This field is protected after the record is saved.

Number of Staging Records is the number of adjustment upload staging records that are linked to this adjustment staging control record.

Total Adjustment Amount is the total of adjustment amounts from the adjustment upload staging records that are linked to this adjustment staging control record.

Enter the **Currency** for the total adjustment amount on the adjustment staging control. This is also the currency of the adjustment amounts on the associated adjustment upload staging records.

Status shows the state of the adjustment staging control. Possible values are: Pending, In Progress, Complete, Error, and Held.

A **Hold** button appears adjacent to the status description if **Status** is Pending. Click this button to set the status to Held. The adjustment upload process will ignore staging controls in this state.

A **Pend** button appears adjacent to the status description if **Status** is either Held or Error . Click this button to set the status to Pending. An error message box also appears below the status description if **Status** is Error.

Use the **Characteristics** collection to capture miscellaneous information about an adjustment staging control.

- **Characteristic Type** The type of characteristic.
- **Characteristics Value** The value of the characteristic.

NOTE:

You can only choose characteristic types defined as permissible on an adjustment staging control. Refer to [Setting Up Characteristic Types & Their Values](#) for more information.

Maintaining Adjustment Upload Staging

Use this page to add, view, or modify an adjustment upload staging record. Open this page using **Menu > Financial > Adjustment Upload Staging > Search**.

Description of Page

Adjustment Upload ID is the unique identifier of the adjustment upload staging record.

Adjustment Staging Control ID is the identifier of the adjustment staging control to which the adjustment upload staging is linked.

Indicate the **Adjustment Type**. This field is very important as it controls numerous aspects of the adjustment's impact on the customer's balance and your general ledger.

NOTE:

You can only choose certain adjustment types. The service agreement's SA type has a collection of valid adjustment profiles. You may only reference adjustment types that are listed in one of the adjustment type profiles linked to the SA type.

Enter an **Adjustment Amount**.

Creation Date is the date when the adjustment occurred. This will be the creation date on the uploaded adjustment. This field is protected after the record is saved.

Service Agreement indicates the SA to which the adjustment was posted. If the adjustment is in suspense, the label shows **Suspense SA** instead.

Adjustment is a reference to the adjustment that got created from the upload.

Status shows the state of the adjustment upload staging. Possible values are: Pending, Complete, and Error.

If **Status** is Error, a **Pend** button appears adjacent to the status description. In addition, an error message box displays below the status description.

If the adjustment is in suspense, a message appears to indicate the condition and the **Suspense Adjustment** is shown. A different message appears when the suspense is resolved.

Use the **Characteristics** collection to keep miscellaneous information about an adjustment upload staging.

- **Characteristic Type** The type of characteristic.
- **Characteristics Value** The value of the characteristic.

NOTE:

Default Note. An adjustment upload staging's characteristics default from the [adjustment type](#).

Credit & Collection

The system periodically monitors how much your customers owe to ensure they haven't violated your collection criteria. When a violation is detected, the system generates the appropriate events (e.g., letters, disconnect field activities, To Do entries, write-off outstanding debt, etc.). This section describes how to manage your credit & collections processing.

NOTE:

In the section, [The Big Picture Of Credit & Collection \(C&C\)](#), we describe how to set up the control tables that automate most of your credit & collections processing. If you set these tables up properly, the system will manage most of your collection, severance and write-off processes; little or no user intervention should be necessary. You will only access the C&C pages when you need to override what the system does.

The Big Picture Of Credit & Collection

The topics in this section provide background information about a variety of credit & collections issues.

Automating Your C&C Activities

FASTPATH:

Refer to [The Big Picture Of Credit & Collections \(C&C\)](#) to understand how the system monitors overdue debt and initiates the appropriate collection, severance and write-off events when a customer exceeds your debt tolerances.

The Lifecycle Of A Collection Process And Its Events

The following diagram illustrates the lifecycle of a typical collection process and its collection events:

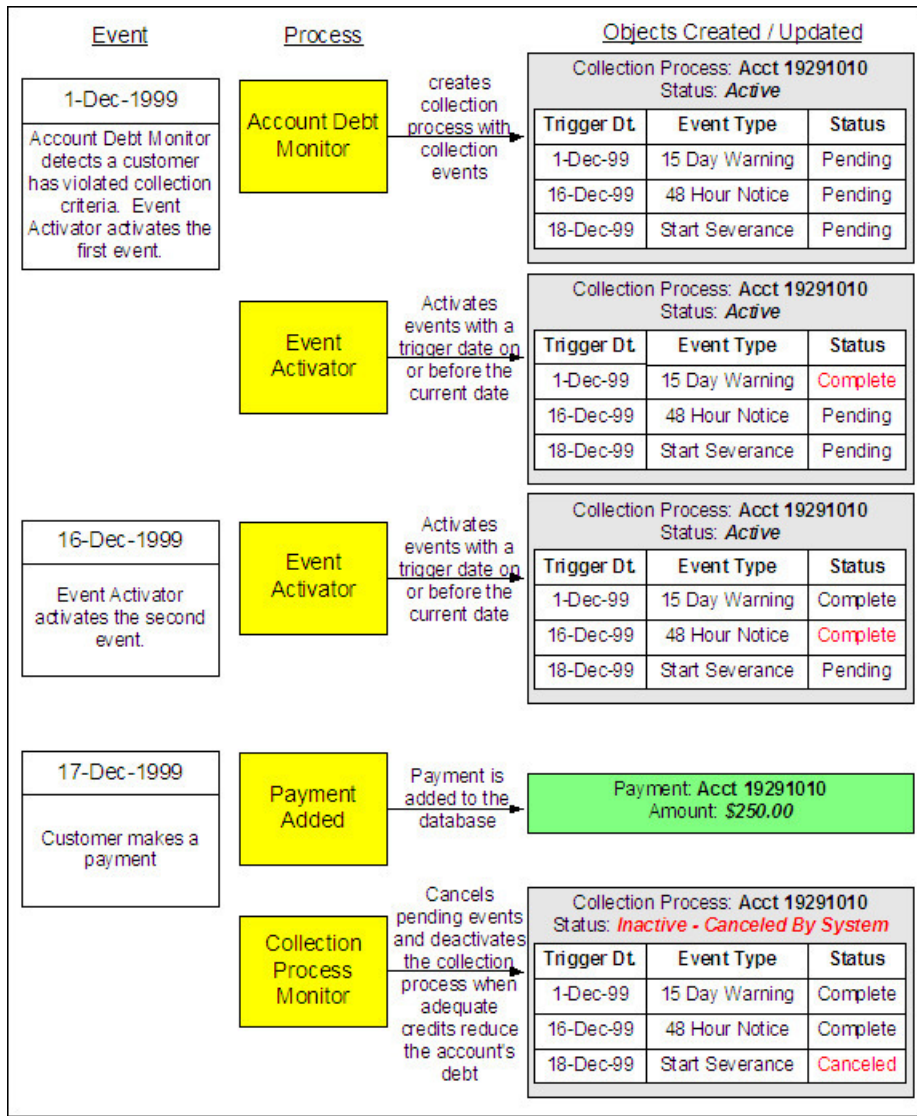

The preceding diagram is referenced in the following topics.

What Is A Collection Process?

A collection process is a series of events (e.g., letters, To Do entries) meant to encourage an account to pay its delinquent debt. Linked to the collection process are the specific service agreements that contributed to the delinquent debt.

How Are Collection Processes Created?

A collection process and its events may be created as follows:

- The Account Debt Monitor is a background process that creates a collection process when an account violates your collection criteria. The collection process has one or more collection event(s). The collection process template associated with the collection process controls the number and type of events.

- A user may create an ad hoc collection process at will. The collection process template controls the number and type of events linked to the collection process.

In the above diagram, the event on 1-Dec-99 shows the creation of a collection process with three collection events. Notice that the events all exist in the Pending state. The events will exist in this state until their trigger date is on or before the current date.

FASTPATH:

Refer to [How Does The Account Debt Monitor Work?](#) to understand how the system monitors overdue debt and initiates the appropriate collection process when a customer exceeds your debt tolerances. Refer to [The Big Picture Of Collection Events](#) for more information about a collection process' events.

When you enable the Control Central alert algorithm, C1-COLLPR-AC, an alert displays when an account has an active collection process. This algorithm is plugged-in on the [installation record](#).

How Are Collection Events Completed?

The event activator runs periodically (at least daily). It looks for collection events with a trigger date on or before the current date. For each such event, the system executes its activity and then completes it.

In the above diagram, the event activator activates pending events on 1-Dec-99 and 16-Dec-99. Notice that the events are moved to the Complete state.

FASTPATH:

Refer to [The Big Picture Of Collection Events](#) for more information about the various types of collection events and what happens when they are completed.

How Are Collection Processes (and their Events) Canceled?

FASTPATH:

Refer to [How Are Collection Processes Cancelled](#) for a description of how and when collection processes are automatically cancelled by the system.

Besides the automated cancellation process, a user may cancel a collection process at will. Refer to [How To Cancel A Collection Process](#) for more information.

What Happens If A Payment Is Not Received?

If a payment (or some other type of credit) is not received by the trigger date of the last event in the process, a severance process is initiated for one or more service agreements. Refer to [The Last Collection Event Should Sever Service Agreement\(s\)](#) for more information.

The Collection Process Background Processes

There are three background processes that automate the creation, activation, and cancellation of collection processes:

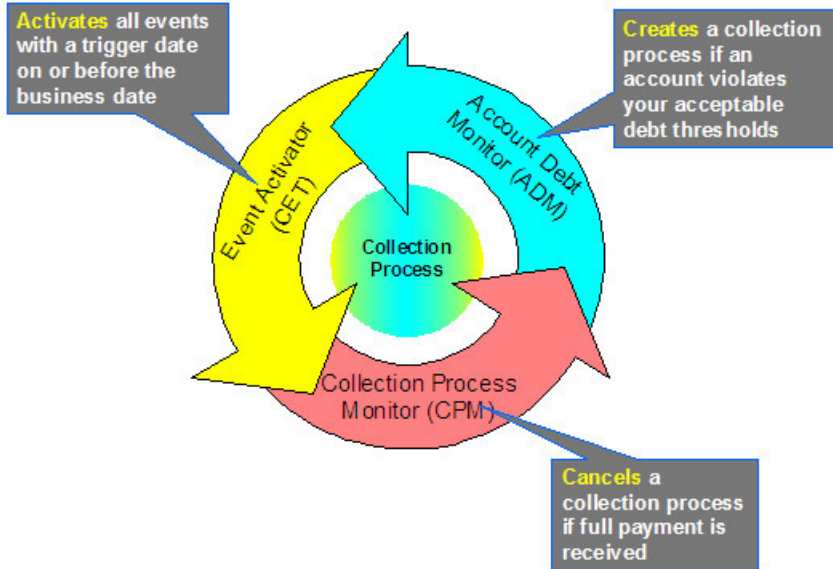

Account Debt Monitor

The Account Debt Monitor (ADM) creates a collection process when an account violates your collection criteria. The collection process has one or more collection event(s). The number and type of events is defined on the collection process's template.

This process has an optional input parameter for CIS Division. It can be used if your implementation requires processing of data by CIS Division. You will need to create a copy of this process's batch control for each CIS Division.

NOTE:

Monitoring account debt is usually done based on a schedule triggered by system events such as a bill or canceled payment. If too much time has gone by since the last debt review, the account can be selected for debt monitoring as well. ADM has an optional input parameter **Include Minimum Days Review**. When set, accounts that have gone too long since their last review are selected along with those scheduled to be reviewed. The minimum days between review is defined on the [customer class](#)

A separate background process (ADM2) only selects accounts based on the minimum days. This process can be used when the option to include minimum days on ADM has not been set. ADM2 does not have an option to be run by CIS Division.

ADM2 does not have an option to be run by CIS Division.

In the above [diagram](#), the account debt monitor creates a collection process (with 3 events) on 1-Dec-99. Notice that the events all exist in the Pending state. The events will exist in this state until their trigger date is on or before the current date.

FASTPATH:

Refer to [How Does The Account Debt Monitor Work](#) for more information.

Collection Event Activator

The Collection Event Activator (CET) runs periodically (at least daily). It looks for collection events with a trigger date on or before the current date. For each such event, the system executes its activity and then completes it.

This process has an optional input parameter for CIS Division. It can be used if your implementation requires processing of data by CIS Division. You will need to create a copy of this process's batch control for each CIS Division.

In the above [diagram](#), the collection event activator activates pending events on 1-Dec-99 and 16-Dec-99. Notice that the events are moved to the Complete state after they are activated.

Collection Process Monitor

The Collection Process Monitor (CPM) runs periodically (at least daily). This process reviews a collection process whenever one of its service agreements' debt is reduced.

This process has an optional input parameter for CIS Division. It can be used if your implementation requires processing of data by CIS Division. You will need to create a copy of this process's batch control for each CIS Division.

At review time, the Collection Process Monitor determines if it can cancel the collection process (because the customer's debt is no longer in a bad state). Refer to [How Does The Collection Process Monitor Work](#) for details describing how this process works.

In the above [diagram](#), the collection process monitor cancels the process on 17-Dec-99. Notice that the events are moved to the Cancelled state and the process becomes Inactive.

The Lifecycle Of A Severance Process And Its Events

The following diagram illustrates the first part of the lifecycle of a typical severance process and its events:

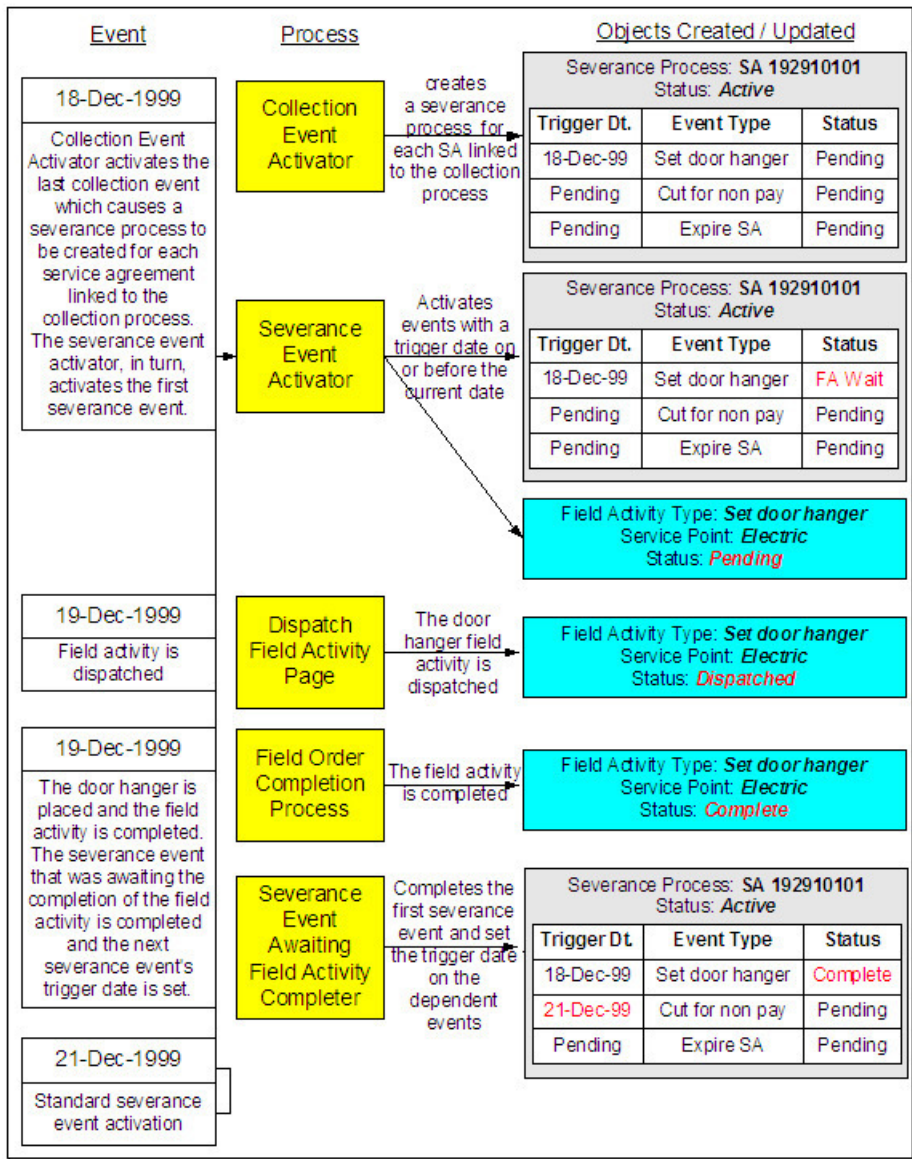

The preceding diagram is referenced in the following topics.

What Is A Severance Process?

A severance process is a series of events (e.g., letters, To Do entries, field activities) that lead to the severance of a service agreement. A separate severance process is required for each service agreement to be severed.

How Are Severance Processes Created?

Severance processes may be created as follows:

- The Collection Event Activator creates a severance process when it completes a "start severance process" collection event. The severance process has one or more severance event(s). The severance process template associated with the severance process controls the number and type of events.

- A user may create an ad hoc severance process at will. The severance process template defined when the severance process is created controls the number and type of events linked to the severance process.

NOTE:

Manual Creation. A user can create a severance process for an account that does not qualify to be on severance according to the cancel criteria algorithm. For example, perhaps your cancel criteria algorithm cancels a severance process when the account's debt falls below a threshold amount. A user can create a severance process for an account whose debt is already below this threshold. Because cancellation is real time, there is no action that will cause this severance process to be canceled. When a manual severance process is created, the system executes the appropriate cancellation criteria algorithm. If the algorithm indicates that the system would have canceled this severance process, a warning is issued. Refer to [How Are Severance Processes Cancelled](#) for more information about cancellation algorithms.

In the above diagram, the event on 18-Dec-99 shows the creation of a severance process with three collection events. Notice that only the first event has a trigger date, this is because the later events' trigger date can only be determined after the first event is completed. Also, notice that the events all exist in the Pending state. The events will exist in this state until their trigger date is on or before the current date.

FASTPATH:

Refer to [How Are Collection Events Completed?](#) for more information about the completion of collection events.

When you enable the Control Central Alert installation algorithm, C1-SEVPR-ACT, an alert displays when an account has an active severance process. This algorithm is plugged-in on the [installation record](#).

How Are Severance Events Completed?

The Severance Event Activator runs periodically (at least daily). It looks for severance events with a trigger date on or before the current date. For each such event, the system executes its activity. The type of severance event dictates what happens to the severance event's state. Refer to [Field Events Versus Office Events](#) for the details.

In the above diagram, the event activator activates a pending event on 18-Dec-99. Take note of the state of the severance event (it becomes Awaiting Field Activity Completion).

FASTPATH:

Refer to [The Big Picture Of Severance Events](#) for more information about the various types of severance events and what happens when they are completed.

How Are Severance Processes (and their Events) Canceled?

FASTPATH:

Refer to [How Are Severance Processes Cancelled](#) for a description of how the system automatically cancels a severance process.

NOTE:

Real time cancellation. Unlike collection processes, the system cancels severance processes real time (i.e., there is no equivalent of the collection process monitor for severance processes). Why are severance processes canceled real time? Because a severance process may have events that create field activities to sever service. These events need to be canceled the moment the FT is frozen, we can't wait until a background process runs. This means that if a customer pays in person for a service agreement that is pending severance, the system will cancel the process and its field activities

(if any) the moment the payment is entered. The logic to cancel the field activities is in an algorithm plugged in on the [installation record](#).

FASTPATH:

Refer to [Setting Up Severance Process Templates](#) for more information about severance process templates. Refer to [Designing Your Reconnection Procedures](#) for more information about how severance processes are used to reconnect services.

Besides the automated cancellation process, a user may cancel a severance process at will.

What Happens If The Customer Does Not Pay?

If a payment (or some other type of credit) is not received by the trigger date of the last event in the severance process, the service agreement is stopped (as long as you've setup your severance process to include an Expire Service Agreement event as the last event). The expiration of the last service agreement will, in turn, trigger a final bill. If the account doesn't pay the final bill, a write-off process will be started.

NOTE:

Final bills. The account will be setup for final billing when the LAST service agreement linked to the account is stopped. Refer to [Finalizing Pending Stops](#) for more information about how the system changes the account's bill cycle when the last service agreement is stopped.

FASTPATH:

Refer to [The Big Picture Of Write Off Processing](#) for more information about the write off process.

The Severance Process Background Processes

The Collection Event Activator creates a severance process when it completes a "start severance process" collection event. The severance process has one or more severance event(s). The severance process template associated with the severance process controls the number and type of events. There are 3 background processes that automate the activation and cancellation of severance events:

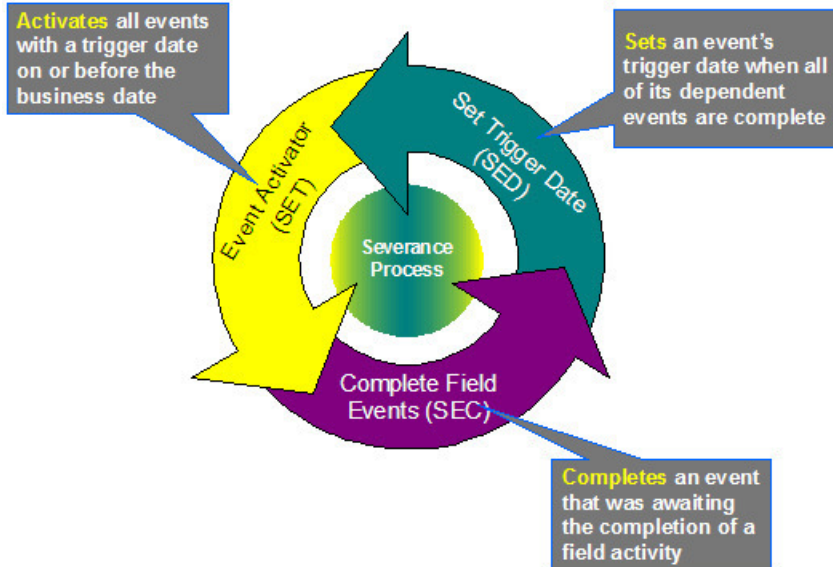

Severance Event Activator

The Severance Event Activator (SET) runs periodically (at least daily). It looks for severance events with a trigger date on or before the current date. For each such event, the system executes its activity. The type of severance event dictates what happens to the severance event's state.

This process has an optional input parameter for CIS Division. It can be used if your implementation requires processing of data by CIS Division. You will need to create a copy of this process's batch control for each CIS Division.

In the above [diagram](#), the event activator activates a pending event on 18-Dec-99. Take note of the state of the severance event (it becomes Awaiting Field Activity Completion).

Completing Severance Events That Are Dependent On The Completion Of A Field Activity

The Complete Field Events (SEC) process runs periodically (at least daily). It looks for severance events that are dependent on the completion of field activities before they can be completed. The system completes each such event when the field activities linked to the event are complete.

This process has an optional input parameter for CIS Division. It can be used if your implementation requires processing of data by CIS Division. You will need to create a copy of this process's batch control for each CIS Division.

In the above [diagram](#), this process completes the event that was Awaiting Field Activity Completion on 19-Dec-99. Take note of the state of the severance event (it becomes Complete).

Set Trigger Date

The Set Trigger Date (SED) process runs periodically (at least daily). It looks for severance events that are dependent on the completion of other events before their trigger date can be set. The system sets the trigger date of each such event when all of its dependent events are complete.

This process has an optional input parameter for CIS Division. It can be used if your implementation requires processing of data by CIS Division. You will need to create a copy of this process's batch control for each CIS Division.

In the above [diagram](#), this process sets the trigger date of the second event on 19-Dec-99.

The Lifecycle Of A Write-Off Process And Its Events

The following diagram illustrates the lifecycle of a typical write-off process and its write-off events:

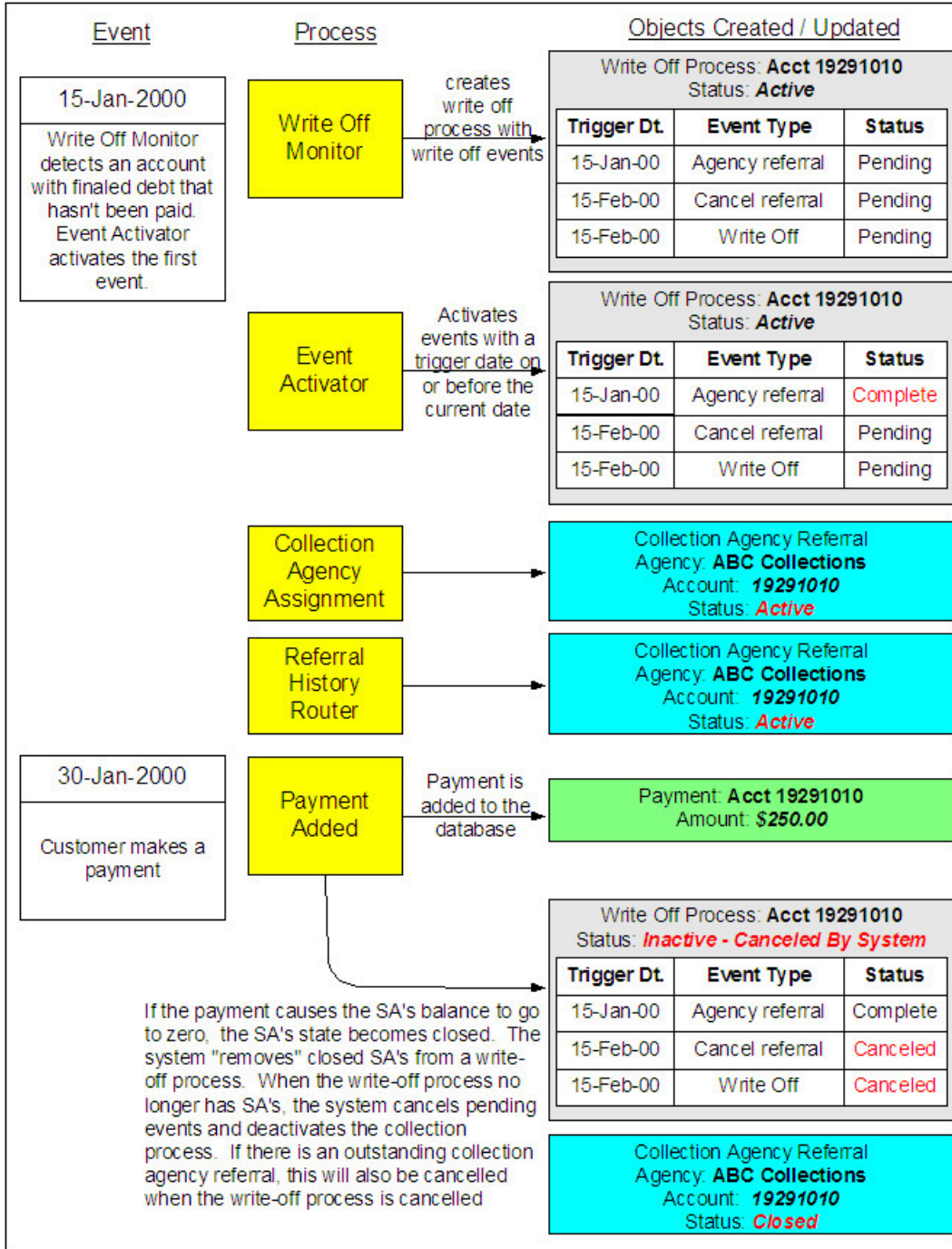

The above diagram is referenced in the following topics.

What Is A Write-Off Process?

A write-off process is a series of events (e.g., letters, collection agency referrals) meant to encourage an account to pay its delinquent debt. Linked to the write-off process are the specific service agreements that contributed to the delinquent debt.

How Are Write-Off Processes Created?

A write-off process and its events may be created as follows:

- The Write Off Monitor is a background process (WPM) that creates a write-off process when an account has finalized, unpaid service agreements. The write-off process has one or more write-off event(s). The write-off process template associated with the write-off process controls the number and type of events.
- A user may create an ad hoc write-off process at will. The write-off process template controls the number and type of events linked to the write-off process.

In the above diagram, the event on 15-Jan-00 shows the creation of a write-off process with three write-off events. Notice that the events all exist in the Pending state. The events will exist in this state until their trigger date is on or before the current date.

FASTPATH:

Refer to [How Does The Write-Off Monitor Work?](#) to understand how the system monitors overdue debt and initiates the appropriate write-off process when a customer has unpaid, finalized service agreements. Refer to [The Big Picture Of Write-off Events](#) for more information about a write-off process' events.

How Are Write-Off Events Completed?

The event activator runs periodically (at least daily). It looks for write-off events with a trigger date on or before the current date. For each such event, the system executes its activity and then completes it.

In the above diagram, the event activator activates a pending event on 15-Jan-00. Notice that the events are moved to the Complete state.

FASTPATH:

Refer to [The Big Picture Of Write-off Events](#) for more information about the various types of write-off events and what happens when they are completed.

How Are Write-Off Processes (and their Events) Canceled?

When a stopped service agreement's balance is reduced to zero (i.e., it closes), the system checks if there is an ongoing write-off process associated with the service agreement. If so:

- The system "removes" the service agreement from the write-off process.
- When the last service agreement is removed from a write-off process, the system cancels all pending write-off events and deactivates the write-off process.
- If the canceled process has collection agency referrals, the system cancels the referrals.

NOTE:

Real time cancellation. Unlike collection processes, the system cancels write-off processes real time (i.e., there is no equivalent of the collection process monitor for write-off processes). This means that if a customer (or collection agency) pays for a service agreement that is linked to write-off process, the system will cancel the process and its collection agency referrals (if any) the moment the payment is entered.

FASTPATH:

Refer to [Setting Up Write Off Process Templates](#) for more information about write off process templates.

Besides the automated cancellation process, a user may cancel a write-off process at will.

What Happens If The Debt Is Not Paid?

If a payment (or some other type of credit) is not received by the trigger date of the last event in the process, the debt will be written off (assuming you designed your write off process template to do such).

NOTE:

The last write-off event should cause debt to be written off. Debt will only be written off if the last write-off event is the type that writes off debt. If the write-off process template contains no such event, nothing further will transpire until the next time the write-off monitor runs (when it will create another write-off process for the unpaid, finalized debt).

FASTPATH:

Refer to [How Is Debt Financially Written-Off?](#) for a description of exactly how debt is written off.

How Is Debt Referred To Collection Agencies

FASTPATH:

Refer to [How Do Collection Agency Referrals Work?](#) for more information about how the system refers debt to a collection agency.

The Write-Off Process Background Processes

There are 2 background processes that automate the creation, activation, and cancellation of write-off processes:

NOTE:

If necessary, you can write-off debt outside of the automated write-off process by simply transferring bad debt to a write-off service agreement using the Write Off transaction.

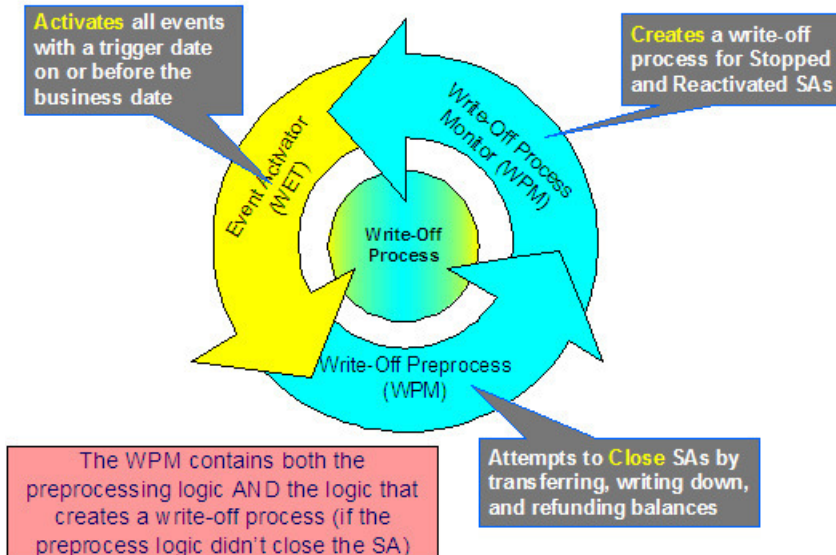

Write-Off Monitor

The Write-Off Monitor (WPM) is a background process that has two functions:

- It attempts to close Stopped and Reactivated service agreements using several methods as described under [Attempt To Close The SA Before Creating A Write Off Process](#).
- If it is unsuccessful at closing a SA, it creates a write-off process. The write-off process has one or more write-off event(s). The write-off process template associated with the write-off process controls the number and type of events.

This process has an optional input parameter for CIS Division. It can be used if you implementation requires processing of data by CIS Division. You will need to create a copy of this process's batch control for each CIS Division.

In the above [diagram](#), the event on 15-Jan-2000 shows the creation of a write-off process with three write-off events. Notice that the events all exist in the Pending state. The events will exist in this state until their trigger date is on or before the current date.

Write-Off Event Activator

The Write-Off Event Activator (WET) runs periodically (at least daily). It looks for write-off events with a trigger date on or before the current date. For each such event, the system executes its activity and then completes it.

This process has an optional input parameter for CIS Division. It can be used if you implementation requires processing of data by CIS Division. You will need to create a copy of this process's batch control for each CIS Division.

In the above [diagram](#), the write-off event activator activates a pending event on 15-Jan-2000. Notice that the event is moved to the Complete state.

Collection Process Maintenance

A collection process is a series of events (e.g., letters, To Do entries) meant to encourage an account to pay its delinquent debt. Linked to the collection process are the specific service agreements that contributed to the delinquent debt. The topics in this section describe the pages on which collection process-related information is maintained.

FASTPATH:

For more information about collection processes, refer to [The Lifecycle Of A Collection Process And Its Events](#).

Collection Process - Main Information

The Main page contains core collection process information. Open this page using **Menu > Credit & Collection > Collection Process > Search**.

FASTPATH:

The **Description of Page** section below describes the fields on this page. Refer to [How To Perform Common Collection Process Functions](#) for more instructions describing how to use this transaction.

Description of Page

Collection Process is a concatenation of summary information about this collection process. It is composed of the name of the main customer on the account, the collection status, the reason code for the collection status, the collection class control name, and the creation date of the process.

Collection Process ID is the unique system-generated identifier for this collection process.

Account ID is the system-generated account number. The name of the main customer on the account and its customer class are displayed next to the ID number.

Collection Status defines the state of the collection process. The following values may exist:

Active The system creates a collection process in the Active state. A collection process remains in this state until the last event linked to the process is complete OR the customer pays the collection amount on the service agreements linked to the process OR you want to stop the process for whatever reason.

Inactive A collection process becomes Inactive when the last event linked to the process is completed OR the customer pays the collection amount on all service agreements linked to the process OR you want to stop the process for whatever reason. The **Reason** field tells you how a collection process became inactive.

FASTPATH:

To completely understand the significance of a collection process' status, refer to [The Lifecycle Of A Collection Process And Its Events](#).

Reason defines how a collection process became Inactive or why a collection process is Active. The following values may exist:

Canceled by User This reason should be used when a user manually inactivates a collection process (for whatever reason).

Canceled by System This reason is populated by the system when it cancels a collection process. The system automatically cancels a collection process when sufficient credits have been posted to the process' service agreements since the process was started.

Events Pending This reason is populated by the system when a process has pending events.

Completed This reason is populated by the system when it completes the last event linked to the collection process.

Collection Class Control defines the debt class (i.e., the type of debt) associated with the collection process. This is important as it controls which service agreements can be linked to the collection process (every service agreement is associated with a specific debt class). This field is gray when there are service agreements linked to the collection process.

NOTE:

Multiple collection processes may be linked to an account. It's important to be aware that if an account's service agreements reference multiple debt classes, a collection process must be created for each debt class that you want to collect.

One collection process per debt class. A given debt class for an account may only have one ongoing collection process at any point in time.

Beneath **Collection Class Control** is displayed a message showing why the system generated the collection process. This information is only displayed for collection processes created by the Account Debt Monitor. If you have plugged in a Collection Process Additional Information algorithm on the [Installation](#) record, the results of the algorithm, if any, is displayed on a separate line.

The following line displays the minimum value payment to the collection process debt class that will cause cancellation of the collection process.

FASTPATH:

For more information, refer to [How Does The Account Debt Monitor Work?](#).

Collection Process Template defines the collection events in the process. You can override these events on the **Events** page.

NOTE:

Changing the template. If you change the template when all events are pending, the system will remove the pending events and replace them with the new template's events.

FASTPATH:

For more information, refer to [Setting Up Collection Process Templates](#).

Creation Date/Time defines the start date/time of the collection process. This is important as it affects the trigger dates of the process' collection events. This field becomes protected after the collection process exists on the database. If you need to change the trigger date on the events you can navigate to the **Events** tab and change the dates manually. Alternatively, you can perform the following "trick":

- Change the **Collection Process Template** to something (anything). Doing this causes the **Create Date/Time** to become unprotected.
- Specify the date of the first collection event in the newly unprotected **Create Date/Time**.
- Change the **Collection Process Template** back to the desired value. When you change the template, the system removes the events and creates new ones using the **Create Date/Time**.

The collection process cancellation logic will cancel a collection process when its account's debt no longer exceeds a given amount (you define this threshold amount when you set up the system). Rather than compare an account's total debt to the threshold amount, the cancellation logic compares the account's debt that is older than X days to the threshold amount. X is the date specified in **Collection Amount Base Date**. You can have the system calculate this date for you by entering the age of the arrears in the field embedded in **Calculate Date Using ___ Days In Arrears**.

FASTPATH:

For more information, refer to [How Are Collection Processes \(and their Events\) Canceled?](#)

Enter any **Comments** about the collection process.

The [tree](#) at the bottom of the page shows a variety of information about the **account** and the collection process including:

- The service agreements linked to the collection process.
- The events linked to the collection process.
- The amount of debt currently associated with the account's debt classes.
- Whether a pay plan exists for the account, or existed at the time the collection process was created.
- The balance for any service agreements linked to the collection process in Inactive status but that have credit balances contributing to the overall debt class arrears for the account.
- A summary of other active collection activities (i.e., collection, severance and write-off processes) associated with the **account**.

Collection Process - SAs (Service Agreements)

The SA page contains the service agreements whose debt is being collected by the collection process. Open this page using **Menu > Credit & Collection > Collection Process > Search** and navigate to the **SAs** page.

FASTPATH:

The **Description of Page** section below describes the fields on this page. Refer to [How To Perform Common Collection Process Functions](#) for more instructions describing how to use this transaction.

Description of Page

The top portion of every page in this page contains the following information:

Collection Process is a concatenation of summary information about this collection process. It is composed of the name of the main customer on the account, the collection status, the reason code for the collection status, the collection class control name, and the creation date of the process.

ID is the unique system-generated identifier for this collection process.

The **Collection SAs** scroll contains the service agreement being collected under this collection process. To modify a service agreement linked to the collection process, simply move to a field and change its value. To add a new service agreement, press the + button to insert a row, then fill in the information for each field. The following fields display:

Service Agreement ID identifies the service agreement being collected. Information about the service agreement is displayed beneath the SA ID.

Status defines the state of the service agreement in respect of the collection process. The following values may exist:

Active An Active service agreement is one currently being collected by the collection process. The service agreement will remain in this state until the last event linked to the process is complete OR the customer pays the collection amount on the service agreement OR you want to remove the service agreement from the collection process for whatever reason.

Inactive A service agreement becomes Inactive within the collection process when the last event linked to the process is completed OR the customer pays the collection amount on the service agreement OR you want to remove the service agreement from the collection process for whatever reason

The **Collection Amount** is the amount of debt that initially triggered the collection process. This will be zero for collection processes that were created manually.

The **Amount Still Owing** is the amount of debt older than the **Collection Amount Base Date** defined on the Main page.

The **Credit Amount** is displayed if the Amount Still Owing is less than zero.

The **SA Balances** area displays how much is owed for the service agreement. The **Days Old** and **Arrears Amount** information shows how old the current balance is. This information will be blank if the current balance is a credit.

NOTE:

Information about debt balances by age is not applicable to [open-item accounts](#).

Current Balance indicates the amount the customer currently owes for the service. **Payoff Balance** indicates the amount the customer would owe if they wanted to close the service agreement. This value is only displayed when it differs from the current balance.

FASTPATH:

Refer to [Current Amount versus Payoff Amount](#) for more information.

Collection Process - Events

The events page contains the activities that will be performed to persuade the customer to pay the outstanding debt. Open this page using **Menu > Credit & Collection > Collection Process > Search** and navigate to the **Events** page.

FASTPATH:

The **Description of Page** section below describes the fields on this page. Refer to [How To Perform Common Collection Process Functions](#) for more instructions describing how to use this transaction.

NOTE:

We strongly recommend that you understand the information described in [How Are Collection Events Completed?](#) before using this page.

FASTPATH:

The number and type of events associated with a collection process are defined by the process's collection process template (which is defined on the first page). Refer to [Setting Up Collection Process Templates](#) for more information.

Description of Page

The top portion of every page in this page contains the following information:

Collection Process is a concatenation of summary information about this collection process. It is composed of the name of the main customer on the account, the collection status, the reason code for the collection status, the collection class control name, and the creation date of the process.

ID is the unique system-generated identifier for this collection process.

The **Collection Events** scroll contains the collection events that comprise the collection process. Only one event is displayed at a time. The inner scroll controls the display of the customer contacts that were created by the system when a particular collection event was triggered.

Event Sequence is the unique identifier of the event.

Collection EventStatus defines the state of the event. The following diagram shows the possible lifecycle of a collection event:

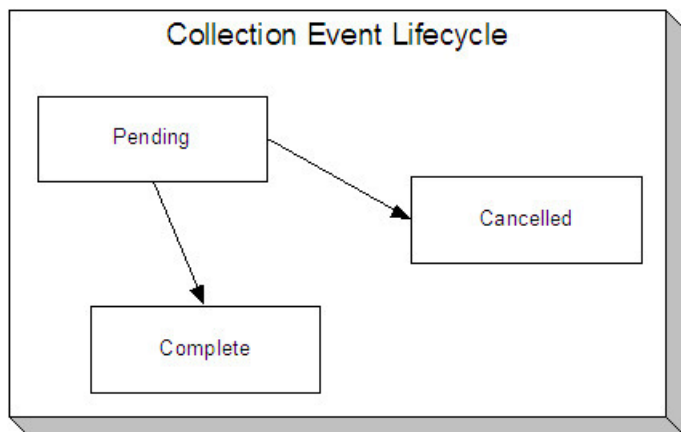

Collection events are initially created in the pending state.

When the system sees a pending event with a **Trigger Date** on or before the current date, the system executes the event's activity and completes the event.

You can cancel an individual collection event by setting the status to cancelled.

The **Collection Event Type** defines the event's activity (e.g., Email sent, a To Do entry is generated, a letter is sent).

FASTPATH:

For more information, refer to [Setting Up Collection Process Templates](#).

The **Trigger Date** defines the date when the system completes (i.e., executes) the event.

FASTPATH:

For more information about a collection event's trigger date, see [Collection Event Trigger Date](#).

If the status of the event is complete, the **Completion Date** is displayed with the date on which the system completes the event. If the status of the event is cancelled, the **Canceled Date** is displayed with the date on which the event was system canceled.

The **Customer Contact** information contains information when the event template causes a letter to be generated (because letters are created by customer contacts).

How To Perform Common Collection Process Functions

The topics in this section describe how to perform common collection process maintenance functions. Refer to [The Lifecycle Of A Collection Process](#) for more information about collection processes. Refer to [The Big Picture Of Collection Processing](#) for high-level information about collection processing.

How To Create A Collection Process

99.9% of all collection processes are created by the [Account Debt Monitor](#) and require no human intervention before they are executed (refer to [How Are Collection Processes Created](#) for information about how the account debt monitor creates collection processes). The other 0.1% are created by users on-line / real time. The following points describe how to create the 0.1%.

- Use **Control Central** to choose the account that requires a new collection process.

- After the account is populated on Control Central, choose the **Collection Process > Add** option on the account context menu to transfer to the collection process transaction in add mode.
- After the Collection Process - Main page appears, specify the appropriate **Collection Class Control**. **Collection Class Control** defines the debt class (i.e., the type of debt) associated with the collection process. This is important as it controls which service agreements can be linked to the collection process (every service agreement is associated with a specific debt class). It's important to be aware that if an account's service agreements reference multiple debt classes, a collection process must be created for each debt class that you want to collect. Also be aware that a given debt class for an account may only have one ongoing collection process at any point in time.
- Choose a **Collection Process Template**. **Collection Process Template** defines the collection events in the process. You can override these events on the Events page. For more information, refer to [Setting Up Collection Process Templates](#).
- Use **Collection Amount Base Date** to define the arrears cutoff date that the system uses when it "removes" a SA from a collection process. The system removes a SA from a collection process when its debt older than X is less than or equal to zero. X is the date specified in **Collection Amount Base Date**. You can have the system calculate this date for you by entering the age of the arrears in the field embedded in **Calculate Date Using ___ Days In Arrears**.
- Navigate to the **SAs** page to define the specific service agreement's whose debt is covered by this collection process. You must define at least one service agreement.
- Save the collection process.

How To Change Collection Events

When a collection process is first created, it has one or more collection events. The events are the activities that will be performed to persuade the customer to pay the outstanding debt.

The number and type of events that are created when a collection process is initiated are defined on the collection process's collection process template. The following points describe how to add / change / delete events on a collection process if the defaulted events are not satisfactory.

- Use **Control Central** to choose the account with the collection process whose events need to be changed.
After the account is populated on Control Central, choose the **Collection Process > Search** option on the account context menu to transfer to the collection process transaction in update mode.

To add a new event, transfer to the **Events** tab and press the + button in the **Collection Events** scroll to add a new event. At this point, the event has not been added to the database; rather, it just exists in memory. Before you add the event to the database, you must specify the following information:
 - Choose an **Event Sequence** so that the new event will be positioned properly in respect of the other events.
 - Choose a **Collection Event Status** of Pending.
 - Choose the desired **Collection Event Type**.
- Use **Trigger Date** to define the date on which the event should be activated (i.e., completed).
To delete an existing event, transfer to the **Events** tab and use the scroll arrows to toggle to the desired collection event. When the desired collection event appears, press the - button to remove the event. At this point, the event has not been removed from the database; rather, it's been removed in memory.

To change an existing event, transfer to the **Events** tab and use the scroll arrows to toggle to the desired collection event. When the desired collection event appears, make the desired changes.

After all desired changes have been made, save the collection process.

How To Cancel A Collection Process

The [Collection Process Monitor](#) will automatically "remove" service agreements from a collection process when their debt has been reduced sufficiently. When all service agreements are "removed" from a collection process, the collection process is canceled. The following points describe how to manually cancel a collection process.

- Use **Control Central** to choose the account with the collection process to be cancelled.
- After the account is populated on Control Central, choose the **Collection Process > Search** option on the account context menu to transfer to the collection process transaction in update mode. A list of all collection processes associated with the account appears. If only one collection process exists, it is automatically selected for you.
- On the **Main** tab, click Cancel.
- When the warning dialog appears, click OK to continue. The collection process and its pending events are canceled.

Severance Process Maintenance

A severance process is a series of events (e.g., field orders, letters, To Do entries) meant to encourage an account to pay its delinquent debt. Linked to the severance process is the specific service agreement being severed. The topics in this section describe the pages on which severance process-related information is maintained.

FASTPATH:

For more information about severance processes, refer to [The Lifecycle Of A Severance Process And Its Events](#).

Severance Process - Main Information

The Main page contains core severance process information. Open this page using **Menu > Credit & Collection > Severance Process > Search**.

FASTPATH:

The **Description of Page** section below describes the fields on this page. Refer to [How To Perform Common Severance Process Functions](#) for more instructions describing how to use this transaction.

Description of Page

The top portion of every page in this page contains the following information:

Severance Process is a concatenation of summary information about this severance process. It is composed of the name of the main customer on the account, the division and SA type, and severance process template code, the process status, the reason code for the process status and the creation date of the process.

Severance Process ID is the unique system-generated identifier for this severance process.

The remaining fields are maintained on the main severance process page.

Service Agreement ID is the system-generated identifier of the service agreement to which the severance process is linked. Adjacent to the ID number is summary information about the SA.

Severance Status defines the state of the severance process. The following values may exist:

Active The system creates a severance process in the Active state. A severance process remains in this state until the last event linked to the process is complete OR the customer pays the collection amount associated with the severance process OR you want to stop the process for whatever reason. The **Reason** field tells you why a severance process is still in the active state.

Inactive A severance process becomes Inactive when the last event linked to the process is completed OR the customer pays the collection amount on the severance process OR you want to stop the process for whatever reason. The **Reason** field tells you how a severance process became inactive.

FASTPATH:

To completely understand the significance of a severance process' status, refer to [The Lifecycle Of A Severance Process And Its Events](#).

Reason defines how a severance process became Inactive or why a severance process is Active. The following values may exist:

Canceled by User This reason should be used when a user manually inactivates a severance process (for whatever reason).

Canceled by System This reason is specified by the system when it cancels a severance process. The system automatically cancels a severance process when sufficient credits have been posted to the process' service agreement since the process was started.

Events Pending This reason is specified by the system when a process has pending events.

Completed This reason is specified by the system when it completes the last event linked to the severance process.

Severance Process Template defines the severance events in the process. You can override these events on the **SeveranceEvents** page. If you change the template after events exist, the system will remove the existing events and replace them with the new template's events.

FASTPATH:

For more information, refer to [Setting Up Severance Process Templates](#).

Create Date/Time defines the start date/time of the severance process. This is important as it affects the trigger dates of the process' severance events. This field becomes protected after the severance process exists on the database. If you need to change the trigger date on the events you can navigate to the **Events** tab and change the dates manually. Alternatively, you can perform the following "trick":

- Change the **Severance Process Template** to something (anything). Doing this causes the **Create Date/Time** to become unprotected.
- Specify the date of the first severance event in the newly unprotected **Create Date/Time**.
- Change the **Severance Process Template** back to the desired value. When you change the template, the system removes the events and creates new ones using the **Create Date/Time**.

The **Collection Amount** is the amount of debt that initially triggered the severance process.

The **Amount Still Owning** is the amount of debt older than the **Severance Amount Base Date**.

The severance process cancellation logic will cancel a severance process when its SA's debt no longer exceeds a given amount (you define this threshold amount when you set up the system). Rather than compare a SA's total debt to the threshold amount, the cancellation logic compares the SA's debt that is older than X days to the threshold amount. X is the date specified in **Severance Amount Base Date**. You can have the system calculate this date for you by entering the age of the arrears in the field embedded in **Calculate Date Using __ Days In Arrears**.

FASTPATH:

For more information, refer to [How Are Severance Processes \(and their Events\) Canceled?](#)

Enter any **Comments** about the severance process.

The [tree](#) at the bottom of the page shows a variety of information about the **service agreement's** account and the severance process including:

- The events linked to the severance process.
-

- The amount of debt associated with the account's debt classes.
- A summary of other active severance activities (i.e., severance, severance and write-off processes) associated with the **service agreement's** account.

Severance Process - Severance Events

The events page contains the activities that will be performed to persuade the customer to pay the outstanding debt. Open this page using **Menu > Credit & Collection > Severance Process > Search** and navigate to the **Events** page.

FASTPATH:

The **Description of Page** section below describes the fields on this page. Refer to [How To Perform Common Severance Process Functions](#) for more instructions describing how to use this transaction.

NOTE:

We strongly recommend that you understand the information described in [How Are Severance Events Completed?](#) before using this page.

FASTPATH:

The number and type of events associated with a severance process are defined by the process's severance process template (which is defined on the first page). Refer to [Setting Up Severance Process Templates](#) for more information.

Description of Page

The top portion of every page in this page contains the following information:

Severance Process is a concatenation of summary information about this severance process. It is composed of the name of the main customer on the account, the SA business unit and SA type, set ID and severance process template name, the process status, the reason code for the process status and the creation date of the process.

ID is the unique system-generated identifier for this severance process.

The **Severance Events** scroll contains the severance events that comprise the severance process. The grid at the bottom (when visible) shows the events that must be completed before the severance event is triggered. Only one severance event is displayed at a time.

Event Sequence is the unique identifier of the event.

Severance EventStatus defines the state of the event.

FASTPATH:

For more information, refer to [Severance Event Lifecycle](#).

The **Severance Event Type** defines the event's activity (e.g., a field order is generated, a To Do entry is generated, a letter is sent).

FASTPATH:

For more information, refer to [Setting Up Severance Event Templates](#).

If **Dependent on Other Events** is turned on, then the event's trigger date is only determined after the event(s) on which it depends are completed. When this switch is on, a grid appears at the bottom of the page in which you define the event(s) on which this event depends.

FASTPATH:

For more information about dependent events, see [Severance Event Dependencies & Trigger Date](#).

The **Trigger Date** defines the date when the system completes (i.e., executes) the event. This field is gray when the event is dependent on the completion of other events.

FASTPATH:

For more information about a severance event's trigger date, see [Severance Event Dependencies & Trigger Date](#).

Days After Prev Response defines how a dependent event's trigger date is calculated. The trigger date is set equal to X days after the last dependent event is completed, where X is the number in this field. This field is gray when the event is not dependent on other events.

FASTPATH:

For more information about dependent events, see [Severance Event Dependencies & Trigger Date](#).

If the status of the event is complete, the **Completion Date** is displayed with the date on which the system completes the event. If the status of the event is cancelled, the **Canceled Date** is displayed with the date on which the event was canceled. The grid at the bottom of the page contains the events on which this event depends. This grid is only visible when the event is dependent on other events (as defined by the Dependent on Other Events switch). To add additional sequences press the + button (insert row), and define the sequence of the event on which this event depends.

Severance Process - Field Activity/Customer Contact

The Field Activity/Customer Contact page contains information about the objects created when the system completes the event. Open this page using **Menu > Credit & Collection > Severance Process > Search** and navigate to the **FA/CC** page.

FASTPATH:

What happens when a severance event is completed (i.e., executed) is dictated by the severance event's template. Refer to [Types Of Severance Events](#) for more information.

Description of Page

The top portion of every page in this page contains the following information:

Severance Process is a concatenation of summary information about this severance process. It is composed of the name of the main customer on the account, the SA business unit and SA type, set ID and severance process template name, the process status, the reason code for the process status and the creation date of the process.

ID is the unique system-generated identifier for this severance process.

The **Severance Events** scroll contains the severance events that comprise the severance process. The grids show the objects created when the system completes each event.

The **Field Activity/SP** grid contains information about the field activities that were created when the event was activated. This information will only be populated with the event's event type causes a field activity to be generated.

The **Customer Contact** area contains information about the customer contacts that were created when the event was activated. This information will only be populated with the event's event type causes a customer contact to be created (note, letters are generated via the creation of a customer contact).

How To Perform Common Severance Process Functions

The topics in this section describe how to perform common severance process maintenance functions. Refer to [The Lifecycle Of A Severance Process](#) for more information about severance processes. Refer to [The Big Picture Of Severance Processing](#) for high level information about severance processing.

How To Create A Severance Process

99.9% of all severance processes are created when a "start severance" collection event is activated by the [Collection Event Activator](#) and require no human intervention before they are executed (refer to [How Are Severance Processes Created](#) for information about how the account debt monitor creates severance processes). The other 0.1% are created by users on-line / real time. The following points describe how to create the 0.1%.

- Use **Control Central** to choose the account that requires a new severance process.
- After the account is populated on Control Central, choose the **Severance Process > Add** option on the account context menu to transfer to the severance process transaction in add mode. If the account has multiple service agreements, you must select the service agreement to be severed.
- After the Severance Process - Main page appears, specify a **Severance Process Template**. **Severance Process Template** defines the severance events in the process. You can override these events on the Events page. For more information, refer to [Setting Up Severance Process Templates](#).
- Use **Severance Amount Base Date** to define the arrears cutoff date that the system uses when it determines if a severance process can be cancelled. The system cancels a severance process when its SA's debt that is older than X is less than or equal to zero. X is the date specified in **Severance Amount Base Date**. You can have the system calculate this date for you by entering the age of the arrears in the field embedded in **Calculate Date Using ___ Days In Arrears**.
- Save the severance process.

How To Change Severance Events

When a severance process is first created, it has one or more severance events. The events are the activities that will be performed to persuade the customer to pay the outstanding debt.

The number and type of events that are created when a severance process is initiated are defined on the severance process's severance process template. The following points describe how to add / change / delete events on a severance process if the defaulted events are not satisfactory.

- Use **Control Central** to choose the account with the severance process whose events need to be changed. After the account is populated on Control Central, choose the **Severance Process > Search** option on the account context menu to transfer to the severance process transaction in update mode.
- To add a new event, transfer to the **Events** tab and press the + button in the **Severance Events** scroll to add a new event. At this point, the event has not been added to the database; rather, it just exists in memory. Before you add the event to the database, you must specify the following information:
- Choose an **Event Sequence** so that the new event will be positioned properly in respect of the other events.
- Choose a **Severance Event Status** of Pending.
- Choose the desired **Severance Event Type**.

- If the activation of the new event is dependent on the successful completion of earlier events, turn on **Dep on Other Event** and then a) specify the sequences of the dependent events in **Event Dependencies** and b) specify the number of days after the completion of the last dependent event when the new event should be activated.
- If the activation of the new event is NOT dependent on the successful completion of earlier events, turn off **Dep on Other Event** and use **Trigger Date** to define the date on which the event should be activated (i.e., completed).
To delete an existing event, transfer to the **Events** tab and use the scroll arrows to toggle to the desired severance event. When the desired severance event appears, press the - button to remove the event. At this point, the event has not been removed from the database; rather, it's been removed in memory.

To change an existing event, transfer to the **Events** tab and use the scroll arrows to toggle to the desired severance event. When the desired severance event appears, make the desired changes.

After all desired changes have been made, save the severance process.

How To Cancel A Severance Process

The system will automatically cancel a severance process when its service agreement's debt has been reduced sufficiently. Refer to [How Are Severance Processes and Events Cancelled](#) for more information.

The following points describe how to manually cancel a severance process.

- Use **Control Central** to choose the account with the severance process to be cancelled.
- After the account is populated on Control Central, choose the **Severance Process > Search** option on the account context menu to transfer to the severance process transaction in update mode. A list of all severance processes associated with the account appears. If only one severance process exists, it is automatically selected for you.
- On the **Main** tab, click Cancel.
- When the warning dialog appears, click OK to continue. The severance process and its events are canceled.

Write-Off Process Maintenance

A write-off process is a series of events (e.g., letters, collection agency referrals) meant to encourage an account to pay its unpaid, finaled debt. Linked to the write-off process are the specific service agreements that contributed to the delinquent debt. The topics in this section describe the pages on which write-off process-related information is maintained.

FASTPATH:

For more information about write-off processes, refer to [The Lifecycle Of A Write Off Process And Its Events](#).

Write Off Process - Main Information

The Main page contains core write-off process information. Open this page using **Menu > Credit & Collection > Write Off Process > Search**.

FASTPATH:

The **Description of Page** section below describes the fields on this page. Refer to [How To Perform Common Write-Off Process Functions](#) for more instructions describing how to use this transaction.

Description of Page

The top portion of every page contains the following information:

Write Off Process is a concatenation of summary information about this write-off process. It is composed of the name of the main customer on the account, the write-off status, the reason code for the write-off status, the write-off class control name, and the creation date of the process.

Write Off Process ID is the unique system-generated identifier for this write-off process.

The remaining fields are maintained on the main write-off process page.

Account ID is the system-generated account number. The name of the main customer on the account and its customer class are displayed adjacent.

Write-off Status defines the state of the write-off process. The following values may exist:

Active The system creates a write-off process in the Active state. A write-off process remains in this state until the last event linked to the process is complete OR the finalized debt is paid off OR you want to stop the process for whatever reason.

Inactive A write-off process becomes Inactive when the last event linked to the process is completed OR the finalized debt is paid off OR you want to stop the process for whatever reason. The **Reason** field tells you how a write-off process became inactive.

FASTPATH:

To completely understand the significance of a write-off process' status, refer to [The Lifecycle Of A Write Off Process And Its Events](#).

Reason defines how a write-off process became Inactive or why a write-off process is Active. The following values may exist:

Canceled by User This reason should be used when a user manually inactivates a write-off process (for whatever reason).

Canceled by System This reason is populated by the system when it cancels a write-off process. The system automatically cancels a write-off process when all finalized debt associated with the process' service agreements is paid.

Events Pending This reason is populated by the system when a process has pending events.

Completed This reason is populated by the system when it completes the last event linked to the write-off process.

Write Off Control defines the write-off debt class (i.e., the type of debt) associated with the write-off process. This is important as it controls which service agreements can be linked to the write-off process (every service agreement is associated with a specific write-off debt class). This field is gray when there are service agreements linked to the write-off process.

NOTE:

Multiple write-off processes may be linked to an account. It's important to be aware that if an account's service agreements reference multiple write-off debt classes, a write-off process is created for each write-off debt class that you want to write-off.

Multiple write-off processes per write-off debt class. A given write-off debt class for an account may have multiple ongoing write-off processes at any point in time. However, a given service agreement may only be on one active write-off process at any point in time.

Write Off Process Template defines the write-off events in the process. You can override these events on the **Events** page.

NOTE:

Changing the template. If you change the template when all events are pending, the system will remove the pending events and replace them with the new template's events.

FASTPATH:

For more information, refer to [Setting Up Write Off Process Templates](#).

Create Date/Time defines the start date/time of the write-off process. This is important as it affects the trigger dates of the process' write-off events. This field becomes protected after the write-off process exists on the database. If you need to change the trigger date on the events you can navigate to the **Events** tab and change the dates manually. Alternatively, you can perform the following "trick":

- Change the Write-off Process Template to something (anything). Doing this causes the **Create Date/Time** to become unprotected.
- Specify the date of the first write-off event in the newly unprotected **Create Date/Time**.
- Change the **Write-off Process Template** back to the desired value. When you change the template, the system removes the events and creates new ones using the **Create Date/Time**.

Enter any **Comments** about the write-off process.

The [tree](#) at the bottom of the page shows a variety of information about the **account** and the write-off process including:

- The service agreements linked to the write-off process.
- The events linked to the write-off process.
- The amount of debt associated with the account's debt classes.
- A summary of other active collection activities (i.e., collection, severance and write-off processes) associated with the **account**.

Write Off Process - SAs (Service Agreements)

The SA page contains the service agreements whose unpaid, finalized debt is being managed by the write-off process. Open this page using **Menu > Credit & Collections > Write Off Process > Search** and navigate to the **SAs** page.

FASTPATH:

The **Description of Page** section below describes the fields on this page. Refer to [How To Perform Common Write-Off Process Functions](#) for more instructions describing how to use this transaction.

Description of Page

The top portion of every page in this page contains the following information:

Write Off Process is a concatenation of summary information about this write-off process. It is composed of the name of the main customer on the account, the write-off status, the reason code for the write-off status, the write-off control name, and the creation date of the process.

ID is the unique system-generated identifier for this write-off process.

To modify a service agreement linked to the write-off process, simply move to a field and change its value. To add a new service agreement, press + to insert a row, then fill in the information for each field. The following fields display:

Service Agreement identifies the service agreement being collected. Information about the service agreement is displayed adjacent.

Write Off SA Status defines the state of the service agreement in respect of the write-off process. The following values may exist:

Active An Active service agreement is one currently being collected by the write-off process. The service agreement will remain in this state until the last event linked to the process is complete OR the service agreement is closed (due to payment in full) OR you want to remove the service agreement from the write-off process for whatever reason.

Inactive A service agreement becomes Inactive when the last event linked to the process is completed OR the service agreement is closed (due to payment in full) OR you want to remove the service agreement from the write-off process for whatever reason

The **Write Off Amount** is the amount of debt that initially triggered the write-off process.

The **SA Balances** area displays how much is owed for the service agreement. The **Days Old** and **Amount** information shows how old the current balance is. This information will be blank if the current balance is a credit.

Current Balance indicates the amount the customer currently owes for the service. **Payoff Balance** indicates the amount the customer would owe if they wanted to close the service agreement. This value is only displayed when it differs from the current balance.

FASTPATH:

Refer to [Current Amount versus Payoff Amount](#) for more information.

Write Off Process - Events

The events page contains the activities that will be performed to persuade the customer to pay the outstanding debt. Open this page using **Menu > Credit & Collection > Write Off Process > Search** and navigate to the **Events** page.

FASTPATH:

The **Description of Page** section below describes the fields on this page. Refer to [How To Perform Common Write-Off Process Functions](#) for more instructions describing how to use this transaction.

NOTE:

We strongly recommend that you understand the information described in [How Are Write-off Events Completed?](#) before using this page.

FASTPATH:

The number and type of events associated with a write-off process are defined by the process's write-off process template (which is defined on the first page). Refer to [Setting Up Write Off Process Templates](#) for more information.

Description of Page

The top portion of every page in this page contains the following information:

Write Off Process is a concatenation of summary information about this write-off process. It is composed of the name of the main customer on the account, the write-off status, the reason code for the write-off status, the write-off class control name, and the creation date of the process.

ID is the unique system-generated identifier for this write-off process.

The **Write Off Events** scroll contains individual write-off events that comprise the write-off process. Only one event is displayed at a time. The grid contains the customer contacts that were created by the system when a particular write-off event was triggered (if any).

Event Sequence is the unique identifier of the event.

Write Off EventStatus defines the state of the event. The following diagram shows the possible lifecycle of a write-off event:

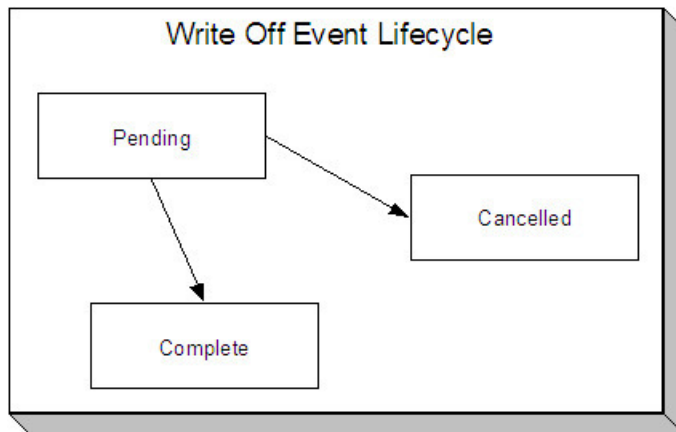

Write-off events are initially created in the pending state.

When the system sees a pending event with a **Trigger Date** on or before the current date, the system executes the event's activity and completes the event.

You can cancel an individual write off event by setting the status to cancelled.

The **Write Off Event Type** defines the event's activity (e.g., the related debt is referred to a collection agency, a To Do entry is generated, a letter is sent).

FASTPATH:

For more information refer to [Setting Up Write Off Process Templates](#).

The **Trigger Date** defines the date when the system completes (i.e., executes) the event.

FASTPATH:

For more information about a write-off event's trigger date, see [Write-off Event Trigger Date](#).

If the status of the event is complete, the **Completion Date** is displayed with the date on which the system completed the event. If the status of the event is cancelled, the **Canceled Date** is displayed with the date on which the event was cancelled.

The **Customer Contact** information contains information when the event template causes a letter to be generated (because letters are created by customer contacts).

How To Perform Common Write-Off Process Functions

The topics in this section describe how to perform common write-off process maintenance functions. Refer to [The Lifecycle Of A Write-off Process](#) for more information about write-off processes. Refer to [The Big Picture Of Write-off Processing](#) for high level information about write-off processing.

How To Create A Write-Off Process

99.9% of all write-off processes are created by the [Write-Off Monitor](#) and require no human intervention before they are executed (refer to [How Are Write-off Processes Created](#) for information about how the account debt monitor creates write-off processes). The other 0.1% are created by users on-line / real time. The following points describe how to create the 0.1%.

- Use **Control Central** to choose the account that requires a new write-off process.

- After the account is populated on Control Central, choose the **Write Off Process > Add** option on the **account context menu** to transfer to the write-off process transaction in add mode.
- After the Write-off Process - Main page appears, specify the appropriate **Write Off Control**. **Write Off Control** defines the debt class (i.e., the type of debt) associated with the write-off process. This is important as it controls which service agreements can be linked to the write-off process (every service agreement is associated with a specific debt class). It's important to be aware that if an account's service agreements reference multiple write-off debt classes, a write-off process must be created for each write-off debt class that you want to collect.
- Choose a **Write Off Process Template**. **Write Off Process Template** defines the write-off events in the process. You can override these events on the Events page. For more information, refer to [Setting Up Write-off Process Templates](#).
- Navigate to the **SAs** page to define the specific service agreement's whose debt is covered by this write-off process. You must define at least one service agreement.
- Save the write-off process.

How To Change Write Off Events

When a write-off process is first created, it has one or more write-off events. The events are the activities that will be performed in the course of the write-off process.

The number and type of events that are created when a write-off process is initiated are defined on the write-off process's write-off process template. The following points describe how to add / change / delete events on a write-off process if the defaulted events are not satisfactory.

- Use **Control Central** to choose the account with the write-off process whose events need to be changed. After the account is populated on Control Central, choose the **Write Off Process > Search** option on the account context menu to transfer to the write-off process transaction in update mode.
To add a new event, transfer to the **Events** tab and press the + button in the **Write Off Events** scroll to add a new event. At this point, the event has not been added to the database; rather, it just exists in memory. Before you add the event to the database, you must specify the following information:
 - Choose an **Event Sequence** so that the new event will be positioned properly in respect of the other events.
 - Choose a **Write Off Event Status** of Pending.
 - Choose the desired **Write Off Type Code**.
 - Use **Trigger Date** to define the date on which the event should be activated (i.e., completed).
To delete an existing event, transfer to the **Events** tab and use the scroll arrows to toggle to the desired write-off event. When the desired write-off event appears, press the - button to remove the event. At this point, the event has not been removed from the database; rather, it's been removed in memory.
To change an existing event, transfer to the **Events** tab and use the scroll arrows to toggle to the desired write-off event. When the desired write-off event appears, make the desired changes.
After all desired changes have been made, save the write-off process.

How To Cancel A Write-Off Process

The system will automatically "remove" service agreements from a write-off process when the close (i.e., when their balance becomes zero). When all service agreements are "removed" from a write-off process, the write-off process is cancelled. Refer to [How Are Write off Processes and Events Cancelled](#) for more information.

The following points describe how to manually cancel a write-off process.

- Use **Control Central** to choose the account with the write-off process to be cancelled.

- After the account is populated on Control Central, choose the **Write Off Process > Search** option on the **account** context menu to transfer to the write-off process transaction in update mode. A list of all write-off processes associated with the account appears. If only one write-off process exists, it is automatically selected for you.
- On the **Main** tab, click Cancel.
- When the warning dialog appears, click OK to continue. The write off process and its pending events are canceled.

Writing Off Uncollectable Debt

The Write-off pages described in this section describe the transaction used to manually transfer bad debt to a write-off service agreement.

Write Off - Main

Most write-offs happen behind-the-scenes as part of the automated write-off processing. If you need to perform a partial write-off or cannot wait for the automated process, open **Menu > Credit & Collection > Write Off > Search**.

FASTPATH:

Refer to [The Big Picture of Write Off Processing](#) for background information about the write-off process.

Description of Page

Account contains the name of the main customer on the account. The **Account ID** is the account whose debt is being written off.

The **Candidate SAs** scroll contains one row for each of the account's service agreements that is eligible for write-off. The system displays the respective age and amount of each SA's debt. The accumulated total of all such debt appears in **Write Off Amount**. The checkbox adjacent to this field is used to confirm that you want to write-off the adjacent debt.

When you click the **Create** button, the system writes off the selected debt by executing the write-off algorithm that's plugged in on the account's [customer class](#). Refer to [The Ramifications of Write Offs in the General Ledger](#) for an explanation of how the base-package algorithm (CCWO-DST) works.

How To Manually Write-Off Debt

To manually write-off debt:

- Select the **Account** in question on [Write Off - Main](#).
- Select the debt to be written off for each **Candidate SA**. You do this by turning on the checkbox adjacent to **Write Off Amount**. You can also vary the amount of the **Write Off Amount**.
- Click the **Create** button.

Write Off - Write Off SAs

The Write Off SAs page shows all write-off service agreements linked to the account along with their respective current and payoff balance. Use **Menu > Credit & Collection > Write Off > Search** and navigate to the **Write Off SAs** page.

Description of Page

Account contains the name of the main customer on the account. The **Account ID** is the account associated with the WO SAs displayed below.

The grid contains an entry for every write-off service agreement linked to the account. The following information is displayed for each write-off service agreement:

- The service agreement's **SA Information** is displayed.
- **Current Balance** contains the WO SA's current balance (i.e., the amount written off).
- **Payoff Amount** contains the WO SA's payoff balance (i.e., the amount written off).

NOTE:

Write off SA. There is a field on SA type called **Special Role**. Only those SA types with a role of Write Off are displayed.

Collection Referral

The Collection Referrals page contains information about an account's debt that has been referred to a collection agency.

FASTPATH:

Refer to [How Do Collection Agency Referrals Work?](#) for more information about how the system creates and maintains collection agency referrals as part of the automated write off processing. In theory, you need only access this page if you need to override the automated processing.

Open **Menu > Credit & Collection > Collection Agency Referral > Search** to maintain this information.

Description of Page

The **Agency Referrals** scroll contains one entry for every collection agency referral associated with the account. The following information is defined for each referral.

Use **Collection Agency** to define the agency to which the referral is being sent.

Start Date is the date on which the referral was initially created.

Referral Status defines if the referral is Active or Closed.

Use **Comments** to describe anything unusual about the referral.

The grid contains the history of interactions with the collection agency. Each time an account's debt is referred to a collection agency, the system creates a referral history record.

You can communicate changes about the referral by inserting a new row in the collection. For example,

- If you need to change the referral amount, insert a row and indicate the **Creation Date** and a **Referral History Reason** of Change Referral.
- If you need to cancel the referral, insert a row and indicate a **Referral History Reason** of Referral Cancellation.
- If the customer pays, insert a row and indicate a **Referral History Reason** of Referral Paid.
- If you need to add a new referral, insert a row and indicate a **Referral History Reason** of Initial Referral.

Collection agency referral records are interfaced to the respective collection agency using the batch process defined on the collection agency control record (refer to [Setting Up Collection Agencies](#)). The **Batch Control** process and the respective **Batch Number** in which the records were interfaced to the collection agency are displayed adjacent.

The **System Generated** switch is on for those collection agency referrals created as part of the automated write-off processing. Refer to [How Do Collection Agency Referrals Work?](#) for more information.

Downloading Collection Agency Referrals

Collection referral records need to be periodically extracted and sent to collection agencies.

C1-CAGYX - Collection Agency Referral Extract

This batch was developed using the plug-in driven extract template. It contains a select record and process record algorithm. The records can be extended to include custom fields that your implementation needs. The process records algorithm type delivered with the system, C1-CAGYX-PR, contains instruction for extending the record.

Collection Agency Extract Record

The topics in this section describe the information that appears on each collection agency extract record type.

Collection Agency Referral Record

This section describes the layout of the record created by C1-CAGYX.

Field	Format	Source/Value/Description
Account ID	A10	Collection Agency Referral's Account
Name	A254	Account's Main Person Primary Name
Person Type	A2	Person or Business Indicator (Main Person)
Person Type Description	A60	Description of Person Type
ID Type	A8	Primary ID Type (Main Person)
ID Value	A100	Primary ID Value (Main Person)
Primary Phone Type	A30	Person Contact Type (Main Person)
Primary Phone Number	A254	Primary Phone Person Contact Number (Main Person)
Primary Phone Number Extension	A6	Primary Phone Person Contact Extension (Main Person)
Email Address	A254	Primary Email Person Contact (Main Person)
Mailing Address	A1241	Mailing Address (Main Person). See below for the fields. See Address Subrecord for the fields.
Service Address	A1241	Service Address of Premise linked to SA being written off. One chosen. Stopped SAs given priority. See below for the fields. See Address Subrecord for the fields.
Customer Class	A8	Account's Customer Class
Customer Class Description	A60	Customer Class Description
Currency	A3	Account's Currency
Referral Activity Date	D10	Collection Referral History Create Date
Referral Activity Reason	A4	Collection Referral History Reason
Referral Activity Reason Description	A60	Collection Referral History Reason Description
Referral Activity Amount	N13.2	Collection Referral History Referral Amount

Initial Referral Date	D10	Collection Agency Referral Initial Referral Date
Initial Referral Amount	N13.2	This is the amount on the record marked with a referral reason of initial. If more than one initial record is found the newest one is chosen by default. A parameter on the process record algorithm allows provides the option of choosing the oldest, newest or some of all initial records. Note: additional initial records can be created manually. The system only creates the first one.
Initial Referral Comments	A254	Collection Agency Referral Comments
Connect Date	D10	If the collection agency referral is linked to a write off process, this is the oldest start date for SAs associated with the write off process. If the collection agency referral is not linked to a write off process this is the oldest start date for SAs on the account, giving preference to stopped SAs.
Disconnect Date	D10	If the collection agency referral is linked to a write off process, this is the latest end date for SAs associated with the write off process. If the collection agency referral is not linked to a write off process this is the latest end date for SAs on the account, giving preference to stopped SAs.
Write Off Date	D10	If the collection agency referral is linked to a write off process, this is the creation date for the write off process. If the collection agency referral is not linked to a write off process, the initial referral date is noted here.
Payments Since Last Activity	N13.2	If the collection agency referral is linked to a write off process, this is the sum of pay segment transactions since the last agency referral history record up to the current record. If the collection agency referral is not linked to a write off process, the sum reflects all SAs.
Canceled Payments Since Last Activity	N13.2	If the collection agency referral is linked to a write off process, this is the sum of canceled pay segment transactions since the last agency referral history record up to the current record. If the collection agency referral is not linked to a write off process, the sum reflects all SAs.
Adjustments Since Last Activity	N13.2	If the collection agency referral is linked to a write off process, this is the sum of adjustment and canceled adjustment transactions since the last agency referral history record up to the current record. If the collection agency referral is not linked to a write off process, the sum reflects all SAs.
Fin Resp - Name	A254	Primary Name of Financially Responsible Person on Account
Fin Resp - Person Type	A2	Person or Business Indicator (Financially Responsible Person)
Fin Resp - Person Type Description	A60	Description of Person or Business Indicator (Financially Responsible Person)
Fin Resp - ID Type	A8	Person's Primary ID Type (Financially Responsible Person)
Fin Resp - ID Value	A100	Person's Primary ID Value (Financially Responsible Person)
Fin Resp - Primary Phone Type	A30	Primary Phone Person Contact Type (Financially Responsible Person)
Fin Resp - Primary Phone Number	A254	Primary Phone Person Contact Number (Financially Responsible Person)
Fin Resp - Primary Phone Number Extension	A6	Primary Phone Person Contact Extension (Financially Responsible Person)
Fin Resp - Mailing Address	A1241	Mailing Address (Financially Responsible Person). See Address Subrecord for the fields.

End of File Footer Record

Field	Element Name	Source/Value/Description
Batch Code	A8	
Batch Number	N10	
Thread Number	N10	
Extract Date/Time	A26	
Records Processed	N10	

Address Subrecord

Used in mailing address and service address, total length = 1241 bytes

Field Name	Format	Source/Value/Description
COUNTY	A3	
ADDRESS1	A254	
ADDRESS2	A254	
ADDRESS3	A254	
ADDRESS4	A254	
CITY	A90	
NUM1	A6	
NUM2	A4	
HOUSE_TYPE	A2	
COUNTY	A90	
STATE	A6	
POSTAL	A12	
GEO_CODE	A11	
IN_CITY_LIMIT	A1	

Payment Arrangements and Pay Plans

Payment arrangements and pay plans are very similar concepts in that they are both used to payoff debt. This section describes each method.

NOTE:

To distinguish between payment arrangements and pay plans, it is helpful to understand some terminology: 1) an agreement with a customer to pay off their debt as part of their future bills (sometimes referred to as "current bill plus") is a **payment arrangement**, 2) an agreement with specifically scheduled payments is called a **pay plan**.

Setting Up Payment Arrangement Requests

A payment arrangement request is used to manage the step-by-step process of starting a payment arrangement. These steps can include: checking the account's eligibility for a payment arrangement, capturing the terms of the payment arrangement

(i.e. amount of the outstanding debt to include in the payment arrangement, down payment amount, installment details, etc.), performing required approvals, monitoring the payment of an applicable down payment, and the actual creation of the payment arrangement service agreement. Refer to [The Big Picture Of Payment Arrangement Requests](#) for more information. The topics in this section describe how to set up a payment arrangement request.

Starting A Payment Arrangement Request

There are multiple ways start a payment arrangement request:

- From Control Central:
 - Select the Account.
 - Navigate to the **Payment Agreements** tab page
 - On the **Payment Arrangement Requests** zone, click on the **New Payment Arrangement** button.
- From the Main Menu: Navigate using **Menu > Credit & Collection > Payment Arrangement Request > Add**.
- From the **Payment Arrangement Request Search** portal, click on the **Add** button on the page header.
- From a page/zone that displays the Account: On the Account context menu, navigate using **Go To Payment Arrangement Request > Add**.

All navigation options launch the [Payment Arrangement Request Process Flow](#), which will take you through each of the steps needed to set up a payment arrangement request.

Maintaining Payment Arrangement Requests

A payment arrangement request is used to start a payment arrangement. Aside from capturing the agreed upon terms of the payment arrangement (such as the service agreements and debts to include, number of installments and installment amount), it can also manage any applicable prerequisites for starting the payment arrangement, e.g. down payments, approvals, etc.

Refer to [The Big Picture Of Payment Arrangement Requests](#) for an overview of payment arrangement request functionality.

This section describes how to view and maintain payment arrangement requests.

Navigate using **Menu > Credit & Collection > Payment Arrangement Request > Search**. You are brought to a query portal with options for searching for payment arrangement requests.

Once a payment arrangement request record has been selected, you are brought to the maintenance portal to view and maintain the selected record.

The **Payment Arrangement Request** zone shows the details of the payment arrangement request. Refer to the zone's embedded help for more information.

The **Notes** zone allows users to capture additional notes on the payment arrangement request.

Payment Arrangement Request Process Flow

The base product provides a **Payment Arrangement Request** process flow type that includes three steps:

- Execution of one or more eligibility criteria, to determine whether or not the account is eligible for a payment arrangement. The results of each eligibility criteria and the overall eligibility result are displayed on the first panel of the process flow
- Setting up the terms of the payment arrangement:
 - The service agreements and debt to include in the payment arrangement
 - If a down payment must be paid prior to starting the payment arrangement, the down payment amount can be a percentage or a fixed-amount portion of the total payment arrangement amount

- The remaining payment arrangement amount (after down payment, if applicable)
- The number of installments
- The installment amount
- Review of the eligibility results and the agreed upon payment arrangement terms before submitting the payment arrangement request

Refer to the **Payment Arrangement Request** process flow panels for more details. Also refer to [Understanding Process Flows](#) for information about how process flows work, in general.

Viewing Payment Arrangement Request History

An account's payment arrangement request history can be viewed on the [Payment Arrangement Requests](#) zone of the [Control Central – Payment Agreements](#) page. Refer to this zone's embedded help for more details.

Setting Up Payment Arrangements

A payment arrangement is an agreement with a customer to payoff severely overdue debt in installments. Bills sent to customers with payment arrangements contain charges for both their current services and their payment arrangement installment amount. Refer to [The Big Picture Of Payment Arrangements](#) for information about the financial ramifications of payment arrangements and for a description of how the system monitors payment arrangements.

The topics in this section describe how to set up a payment arrangement and how to break a payment arrangement (if a customer doesn't fulfill their obligations).

Pay Arrangement - Main

NOTE: This page is used to create the payment arrangement service agreement. If you require eligibility checking and other prerequisites for starting a payment arrangement, set up a [Payment Arrangement Request](#) instead.

This page allows you to set up a payment arrangement. When you create a payment arrangement, the system performs the following functions:

- It creates a payment arrangement service agreement (PA SA). It sets the installment amount on this service agreement equal to the installment amount specified on this page.
- It transfers delinquent debt from each delinquent service agreement(s) to the new PA SA.
- As it transfers the debt to the PA SA, it creates synchronizing adjustments to reduce the PA SA's current balance by the amount transferred. Why? Because when delinquent debt is transferred to the PA SA, its current balance increases. Because current balance contains the amount the customer currently owes, this balance must be reduced because the customer is going to payoff the debt in installments (and therefore they don't currently owe anything on the PA SA).

NOTE:

Payment Arrangement Algorithm. The system only performs the above steps if the new PA SA's SA Type does not reference a Payment Arrangement algorithm. If your implementation uses a Payment Arrangement algorithm, then the logic performed when a payment arrangement SA is created will depend on this algorithm.

You could do the above functions by adding a new service agreement (using the service agreement page) and creating transfer adjustments (using the adjustment page). However, this is tedious. Rather, open **Menu > Credit & Collection > Payment Arrangement > Add** to set up a payment arrangement.

Description of Page

SA (service agreement) **Info** and **SA ID** are displayed on every page. These values only appear after the payment arrangement service agreement (PA SA) exists on the database. The **ID** is a system assigned random number that stays with the payment arrangement service agreement for life. The **SA Info** is a concatenation of important details about the payment arrangement service agreement and its account.

The **Current Balance** that appears beneath **SA Info** contains the PA SA's current balance. When you initially set up a PA SA this balance will be zero. It is only non-zero if the customer has not paid a billed installment.

Payoff Balance beneath **SA Info** contains the PA SA's payoff balance. The payoff balance is the total amount to be paid off over the PA SA's life. It is only non-zero after delinquent funds have been transferred to the PA SA. This balance is only displayed when it differs from the **Current Balance**.

FASTPATH:

Refer to [Current Amount versus Payoff Amount](#) for more information.

Account contains the name of the main customer on the account. **Account ID** is the account associated with the PA SA.

The occurrences of **Current** and **Payoff Balance** below **Account** are the account's respective balances. These values are displayed to help you confirm exactly how much the customer currently owes versus how much they will have to payoff over time (remember, after you transfer funds to a payment arrangement, the amount transferred is reduced from the account's current balance).

The **Candidate SAs** scroll contains one row for each of the account's service agreements with aged debt. The system displays the respective age and amount of each SA's debt. All debt that is checked will be transferred to the PA SA when you click **Create**.

WARNING:

The system automatically indicates that all debt that isn't "new" (i.e., debt that the customer has seen on their bills) should be transferred to the payment arrangement. It does this by checking each parcel of aged debt.

Total is the sum of ALL current balances (not just the checked amounts) from all candidate SAs.

The next two fields are used to populate the arrangement amount (i.e., the amount the customer will be billed on each bill).

- The **Installments** field exists to calculate the **Arrange Amount** (the next field) when a time period has been stipulated. Simply enter the number of installments and tab out. When you tab out of the field, the system sets the **Arrange Amount** equal to **New Payoff Balance / Installments**.

NOTE:

Arrange Amount may not add up. The **Arrange Amount** is rounded up so that if you multiply the number of installments by the calculated installment amount, the result will be greater than the PA SA's payoff amount. Don't worry - only the actual dollar amount of the PA SA's total debt will be billed by the system. The last installment will be slightly lower than the other installments.

- Use the **Arrange Amount** field to define the payment arrangement's installment amount if a specific dollar amount has been stipulated. For example, if the customer agrees to pay off their delinquent debt by paying an additional \$50 on each bill, you'd enter "50" in this field. Note - If you enter a dollar amount in this field and tab out, the system will calculate the number of installments and display the number in the **Installments** field.

New Payoff Balance contains the PA SA's payoff balance. This is the total amount of debt that will be paid off over the lifetime of the PA SA. This value equals the current payoff balance on the PA SA plus all selected debt from the **Candidate SAs** scroll.

Define the **CISDivision** and **SA Type** of the payment arrangement service agreement.

NOTE:

Payment arrangement SA types. There is a field on SA type called Special Role. Only those SA types with a role of Payment Arrangement may be selected.

Clicking **Create** (or **Change**) causes the system to perform the following:

- It adds / updates a payment arrangement service agreement (PA SA). It sets the installment amount on this service agreement equal to the installment amount specified on the page.
 - It transfers delinquent debt from the delinquent service agreement(s) to the PA SA. The adjustment type used to transfer these funds is defined on the PA SA's SA type.
 - It reduces the current balance on the PA SA by the amount of debt transferred to the PA SA. Why? Because when delinquent debt is transferred to the PA SA, its current balance increases. Because current balance contains the amount the customer currently owes, this balance must be reduced because the customer is going to pay off the debt in installments (and therefore they don't currently owe anything). The adjustment type used to transfer these funds is defined on the PA SA's SA type.
-

NOTE:

Payment Arrangement Algorithm. The system only performs the above steps if the new PA SA's SA Type does not reference a Payment Arrangement algorithm. If your implementation uses a Payment Arrangement algorithm, then the logic performed when a payment arrangement SA is created will depend on this algorithm.

You can transfer to the **History** page to view the transfer adjustments that were created by the system when it transferred the selected debt to the PA SA.

Clicking **Break** causes the PA SA to become broken. Please refer to the note below for what transpires when a PA is broken.

NOTE:

Break logic is in a plug-in. Please be aware that the logic that is executed when a payment arrangement is broken exists in a plug-in algorithm (plugged-in on the PA SA's SA type). An implementation can use either a Break Payment Arrangement algorithm which the system calls when a payment arrangement is broken, or the Payment Arrangement algorithm which the system calls when a payment arrangement is created, canceled or broken. These two algorithms are mutually exclusive on the SA Type.

Break Payment Arrangement Algorithm. The base package algorithm (SAT BREAK PA) expires the PA SA and cancels all related frozen adjustments, returning the debt to the original service agreements. Because this logic is in a plug-in, you can develop alternative logic and plug it in if the base package logic is not satisfactory.

How To Set Up A Payment Arrangement

NOTE: The following steps only apply to setting up payments using the [Payment Arrangement – Main](#) page.

To set up a new payment arrangement:

- Select the **Account** in question.
 - Select the debt to be transferred to the payment arrangement (by turning on/off the checkbox adjacent to the **Candidate SAs** amounts).
 - Enter the number of **Installments** and the total **Arrange Amount**.
 - Define the **CIS Division** and **SA Type** of the new payment arrangement service agreement.
-

NOTE: If the service agreement's account's CIS Division's **Restrict to Account CIS Division** flag is set to *Restricted*, the CIS Division is set to the account's CIS Division and cannot be changed

- Click the **Create** button.

How To Add Additional Debt To A Payment Arrangement

To transfer additional debt to an existing payment arrangement:

- Select the **SA ID** of the existing payment arrangement.
- Select the debt to be transferred to the payment arrangement (by turning on/off the checkbox adjacent to the **Candidate SAs** amounts).
- Enter the number of **Installments** and the total **Arrange Amount**.
- Click the **Create** button.

NOTE:

After transfer. After transferring the funds to the payment arrangement service agreement, confirm the account's payoff and current balances make sense (the payoff balance is the total amount of debt that the account will eventually have to payoff, the current balance is how much they currently owe, i.e., the amount that credit and collections monitors). The account's payoff and current balances are displayed in the page's second section. If you do not understand the difference between payoff balance and current balance, refer to [Current Amount versus Payoff Amount](#).

How To Break A Payment Arrangement

You would break a payment arrangement when a customer doesn't make the agreed payments. Typically, your credit and collections processes will break a payment arrangement behind-the-scenes. Refer to [The Big Picture Of Payment Arrangements](#) for information about how the system monitors payment arrangements.

If you want to manually break a payment arrangement simply select the **SA ID** of the existing payment arrangement and click the **Break** button.

How To Cancel A Payment Arrangement

You would cancel a payment arrangement if you made a mistake and never intended to set up the payment arrangement in the first place. To cancel a payment arrangement

- Select the **SA ID** of the existing payment arrangement and navigate to the **History** tab.
- Click the **Cancel** button to cancel the transfer adjustments that were used to transfer debt to the payment arrangement from the customer's regular service agreements.
- Next, navigate to the payment arrangement SA's (PA SA) financial history page (using the service agreement context menu). You will see that there are a few non-canceled adjustments (these were used to change the PA SA's current balance after debt was transferred to the PA SA). Cancel these adjustments by drilling down on these adjustments and then click the **Cancel** button on the adjustment maintenance transaction.
- Finally, display the PA SA on the service agreement maintenance transaction and cancel the payment arrangement.

NOTE:

Payment Arrangement Algorithm. If the payment arrangement SA's SA Type references a Payment Arrangement algorithm, then the logic performed when the PA SA is canceled will depend on this algorithm.

Pay Arrangement - History

Open **Menu > Credit & Collection > Payment Arrangement > Search** and navigate to the **History** page to view the transfer adjustments that were created by the system when it transferred the selected debt to the PA SA.

Description of Page

SA (service agreement) **Info** and **ID** are displayed on every page in this page. These values only appear after the payment arrangement service agreement (PA SA) exists on the database. The ID is a system-assigned random number that stays with the service agreement for life. The SA Info is a concatenation of important details about the service agreement and its account.

Current Balance beneath **SA Info** contains the PA SA's current balance. When you initially set up a PA SA this balance will be zero. It is only non-zero if the customer has not paid a billed installment.

Payoff Balance beneath **SA Info** contains the PA SA's payoff balance. The payoff balance is the total amount to be paid off over the PA SA's life. It is only non-zero after delinquent funds have been transferred to the PA SA. This balance is only displayed when it differs from the Current Balance.

FASTPATH:

Refer to [Current Amount versus Payoff Amount](#) for more information.

Account contains the name of the main customer on the account. **Account ID** is the account associated with the PA SA.

The occurrences of **Current** and **Payoff Balance** below **Account** are the account's respective balances. These values are displayed to help you confirm exactly how much the customer currently owes versus how much they will have to payoff over time (remember, after you transfer funds to a payment arrangement, the amount transferred is reduced from the account's current balance).

The **Adjustment Details** area contains one row for each transfer adjustment used to transfer delinquent debt to the PA SA. Click the Go To button to transfer to the adjustment page to view the details of an adjustment (or to cancel the adjustment if you want to reinstate the debt on the originating service agreement).

Total Frozen Adj is the total amount of debt transferred to the payment arrangement that has not been canceled.

Clicking **Cancel** causes the system to cancel all related frozen adjustments, returning the debt to the original service agreements. You must specify the cancel reason by selecting it from the drop down list when Payment Arrangement Cancellation window is displayed.

Total Canceled Adj is the total amount of debt transferred to the payment arrangement that has been canceled.

Setting Up Pay Plans

A pay plan (PP) is an agreement with a customer to make specific payments on specific dates (as opposed to payment arrangements where the customer makes fixed payments as part of their regular bills).

Consider the following situations that would require a pay plan:

- A customer makes a request to payoff severely overdue debt in one or more installments. The existence of the pay plan insulates the portion of the debt covered by the plan from C&C processing (specifically, from the account debt monitor).
- A commercial or industrial customer cannot or will not post a deposit. This type of pay plan is not specifically paying off past debt; rather, it can be viewed as an installment plan to prepay a regular service agreement.

The topics in the following section describe how to set up a pay plan.

Pay Plan - Main

The pay plan transaction allows you to set up a pay plan. When you create a pay plan, the system performs the following functions:

- It creates an active pay plan using the pay plan type entered.
- It defaults the customer as the payor if no third party is defined.

FASTPATH:

Refer to [The Big Picture Of Pay Plans](#) for information about the financial ramifications of pay plans and for a description of how the system monitors pay plans.

Open **Menu > Credit & Collection > Pay Plan > Search** to maintain a customer's pay plan.

Description of Page

Pay Plan and **Pay Plan ID** only appear after the pay plan is added to the database. **Pay Plan ID** is a system-assigned random number that stays with the pay plan for life. **Pay Plan** is a concatenation of important details about the pay plan.

Account ID identifies the account of the customer for which the pay plan exists. This field is protected once the pay plan is Active.

The **Status** displays the status of the pay plan. Refer to [The Lifecycle Of A Pay Plan](#) for more information about a pay plan's status.

Created by displays the id of the user who created the pay plan and the date and time on which it was created.

Clicking the **Cancel** button causes the pay plan's status to become cancelled.

Last Updated by displays the id of the user who last modified the pay plan and the date and time on which it was changed.

Select a **Pay Plan Type**. The Pay Plan Type defines the **Debt Class** whose debt is insulated by the pay plan. The account's **Current Balance** in this debt class appears beneath as well as the portion that is considered **Delinquent Debt**.

If a 3rd party is responsible for the pay plan's payment, **Third Party Payor** must be checked, and the associated 3rd party selected.

The **Payor Account Id** contains the account ID and name of the person responsible for making the pay plan's payments. If a **Third Party Payor** is responsible, the payor's account appears; otherwise the account whose debt is insulated by the pay plan appears.

The **Start Date** defines the first day on which the pay plan is tracked; it defaults to the current date.

Pay Method defines the manner in which the customer intends to fulfill payments under this pay plan.

NOTE:

Significance of payment method. A pay method can have a grace period associated with it. This period controls when a scheduled payment is considered to be missed. For example, a pay method of "postal" might have a grace period of 3 days. This would give the customer 3 extra days to make the scheduled payments before the pay plan is broken.

In addition to grace period, pay method also control if the system will automatically create an automatic payment on the scheduled payment date. If the pay method so indicates AND the account has been set up for automatic payment, the PPAPAY background process will create [Automatic Payments](#) on the scheduled payment date.

The **Scheduled Payments** grid contains the pay plan's scheduled payments. The **Scheduled Date** and **Scheduled Amount** must be entered for each scheduled payment. The **Total Amount** of the scheduled payments is displayed at the bottom.

Free format **Comments** can be entered to describe any special notes about the pay plan.

How To Set Up A Pay Plan

To set up a new pay plan:

- Select the **Account** in question on [Pay Plan - Main](#).
- Select the **Pay Plan Type** for the type.
- Identify a **Third Party Payor** if there is one.
- Select a **Pay Method**.
- Enter one or more **Scheduled Payments**. The **Total Amount** of the scheduled payments should cover the customer's **Delinquent Debt** if you want the pay plan to protect the customer from additional credit and collection activity.
- Click the **Save** button.

Reviewing Pay Plans

In addition to using this maintenance page for reviewing pay plans, Control Central has a pay plan tree that can be used to view pay plan history, including current status. Refer to [Pay Plan Tree](#) for more information.

Financial Transactions

In this section, we describe the financial transactions generated as a result of your bills, payments and adjustments.

The Big Picture Of Financial Transactions

The topics in this section provide background information about a variety of financial transaction issues.

FASTPATH:

We strongly recommend familiarizing yourself with the topics described in [The Financial Big Picture](#) to fully appreciate the system's financial architecture.

Bill Segment Financial Transactions

A bill segment has a related financial transaction. The financial transaction contains the financial effects of the bill segment on the service agreement's current and payoff balances and on the general ledger.

If a bill segment is cancelled, another financial transaction is created to reverse the original financial transaction. The cancellation financial transaction appears on the next bill produced for the account as a bill correction.

FASTPATH:

For more information about bill segment financial transactions, refer to [Bill Details](#).

Payment Segment Financial Transactions

A payment segment has a related financial transaction. The financial transaction contains the financial effects of the payment segment on the service agreement's current and payoff balances and on the general ledger.

If a payment segment is cancelled, another financial transaction is created to reverse the original financial transaction. The cancellation financial transaction appears on the next bill produced for the account as a negative payment.

FASTPATH:

For more information about payment segment financial transactions, refer to [Payment Details](#).

Adjustment Financial Transactions

An adjustment has a related financial transaction. The financial transaction contains the financial effects of the adjustment on the service agreement's debt and on the general ledger.

If the adjustment is eventually cancelled, another financial transaction will be linked to the adjustment to reverse its financial effect. The cancellation financial transaction appears on the next bill produced for the account as an adjustment.

FASTPATH:

For more information about adjustment financial transactions, refer to [Adjustment Details](#).

Financial Transactions And Aged Debt

When a financial transaction's related bill segment / payment segment / adjustment is frozen, the financial transaction (FT) is also frozen. When an FT is frozen, its service agreement's debt is impacted. It is important to stress the following in respect of this impact:

- The FT's GL details will be interfaced to the GL when the GL interface next executes.
- If the FT decreases the amount of debt, the customer's aged debt is affected immediately regardless of whether the FT appears on a bill.
- If the FT increases the amount of debt, the amount the customer owes from an aged debt perspective may or may not be affected by the FT. There is a switch on an FT called New Charge that controls the arrears behavior. If this switch is on, the customer's aged debt will not reflect the FT amount until the FT is swept onto a bill. The moment the FT is swept onto the customer's bill, the debt starts aging. If this switch is off, the date on which the FT starts aging must be defined in the Arrears Date field.
- The amount a customer owes in total is immediately affected by the FT regardless of whether the FT appears on a bill. This means that the amount of aged debt may not be in sync with the total amount owed. This seems odd, but is useful from a credit and collections perspective. You see, you probably don't want to start aging a FT until the customer has actually seen it.

FASTPATH:

For more information, refer to [Financial Transactions Created Between Bills](#).

Current Balance versus Payoff Balance

FASTPATH:

For information about current and payoff balance in general, refer to [Current Amount versus Payoff Amount](#).

The topics in this section describe when payoff amount differs from current amount for the various types of financial transactions.

Adjustments - Current Balance versus Payoff Balance

FASTPATH:

For information about current and payoff balance for adjustments, refer to [Adjustments - Current Balance versus Payoff Balance](#).

Billing - Current Balance versus Payoff Balance

FASTPATH:

For information about current and payoff balance for bill segments, refer to [Billing - Current Balance versus Payoff Balance](#).

Payment - Current Balance versus Payoff Balance

FASTPATH:

For information about current and payoff balance for payment segments, refer to [Payment - Current Balance versus Payoff Balance](#).

The Source Of GL Accounts On Financial Transactions

FASTPATH:

For information about the source of the distribution codes used to generate the GL accounts on the financial transactions, refer to [The Source Of GL Accounts On Financial Transactions](#).

Obscure Things That Can Happen

The topics in this section provide information about obscure things that can happen when a financial transaction (FT) is frozen.

A Stopped Service Agreement May Be Closed

If an FT causes a Stopped SA's current and payoff balances to become zero, the system closes the service agreement (i.e., the service agreement's status becomes Closed).

A Closed Service Agreement May Be Reactivated

After a service agreement is closed (i.e., after it's stopped and paid-in-full), it's possible for some types of financial transactions to be linked to the service agreement. These financial transactions could cause the current and/or payoff balances to become non-zero. If this happens, the system reactivates the service agreement (i.e., the service agreement's status becomes reactivated).

When a service agreement becomes reactivated, it becomes eligible for review by the write-off process monitor (when it next runs). The write-off process monitor will, in all likelihood, start a write-off process for the reactivated service agreement.

Financial events that can be linked to a closed service agreement are:

- The cancellation of a bill segment
- The freezing of a payment segment
- The cancellation of a payment segment
- The freezing of an adjustment
- The cancellation of an adjustment

A Write-Off Process May Be Deactivated If The SA Is Closed

When a service agreement becomes Closed, it will be removed from any ongoing write-off processes. This removal could cause the write-off process to become Inactive (if this is the last service agreement linked to the write-off process). The inactivation of the write-off process, could, in turn, cause collection agency referrals associated with the write-off process to be cancelled.

A Reactivated Service Agreement May Be Closed

After a service agreement has been reactivated (refer to the previous section for how this happens), a financial transaction (or transactions) may be linked to it that will cause the current and payoff balance to return to zero. If this happens, the system closes the service agreement (i.e., the service agreement's status becomes Closed).

All types of financial transactions can be posted to a Reactivated service agreement.

A Collection Process May Be Canceled When A Credit FT Is Frozen

Periodically, the system determines if an account's debt violates your collection criteria. If so, a collection process is created using the violated criteria's collection process template.

The Collection Process Monitor reviews an active collection process whenever one of its service agreements' debt is reduced. Financial events that can cause service agreement debt to be reduced are:

- The cancellation of a bill segment
- The freezing of a payment segment
- The freezing of an adjustment that credits a service agreement

At review time, the Collection Process Monitor removes any service agreement from a collection process when the service agreement has no debt older than the arrears date on the collection process. When all service agreements are removed, the collection process is cancelled.

FASTPATH:

Refer to [The C&C Monitors](#) for more information about debt monitoring.

A Severance Process May Be Canceled When A Credit FT Is Frozen

If the customer does not respond to a collection process's prodding, the system creates a severance process for each delinquent service agreement associated with the collection process.

The system reviews an active severance process whenever its service agreements' debt is reduced. Financial events that can cause service agreement debt to be reduced are:

- The cancellation of a bill segment
- The freezing of a payment segment
- The freezing of an adjustment that credits a service agreement

At review time, the system determines if the service agreement has no debt older than the arrears date on the severance process. If so, the system looks at the severance process' severance process template:

- If the severance process template indicates that the process can be **Used to sever service**, the system cancels all pending severance events and deactivates the severance process. Note: the only severance processes that are not used to sever service are those that request reconnection of a cut service.
- If the canceled process has field activities,
- If the field activities are not linked to a field order and are still in the pending status, the system cancels the field activities.
- Otherwise, the system generates worklist entries to alert an operator that field activities have been dispatched. The operator must determine how to handle these activities because they could already be scheduled for dispatch (or completed!).

NOTE:

Real time cancellation. Unlike collection processes, the system cancels severance processes real time (i.e., there is no equivalent of the collection process monitor for severance processes). Why are severance processes canceled real time? Because a severance process may have events that create field activities to sever service. These events need to be canceled the moment the FT is frozen, we can't wait until a background process runs. This means that if a customer pays in person for a service agreement that is pending severance, the system will cancel the process and its field activities (if any) the moment the payment is entered.

FASTPATH:

Refer to [The C&C Monitors](#) for more information about debt monitoring.

One Or More Algorithms May Be Executed

If the FT is linked to a service agreement whose SA type has Freeze Algorithms, these algorithms will be executed when the FT is frozen. Because you can code whatever you please in an algorithm, anything could happen. Examples of such algorithm include:

- An algorithm that routes consumption to third party service providers when a bill is frozen (refer to STG SND CONS for more information). This type of algorithm would be plugged in on SA types whose consumption can be interfaced to other service providers.
- A bill message can be added to the account when the system detects that its deposit has been paid in full (refer to DEP PIF MSG for more information). This type of algorithm would be plugged in on deposit SA types.

In addition, FT freeze algorithms can also be defined on an account's customer class. Because you can code whatever you please in an algorithm, anything could happen. An example of such an algorithm is one that cancels match events when an FT is cancelled (refer to CNCL FT MEVT for more information). This type of algorithm would be plugged in on customer classes associated with open item customers.

The Big Picture of Balance Control

The balance control processes are used to check the financial integrity of your system. The contents of this section describe how these processes work.

The Balance Control Background Processes

The following diagram illustrates the balance control background processes:

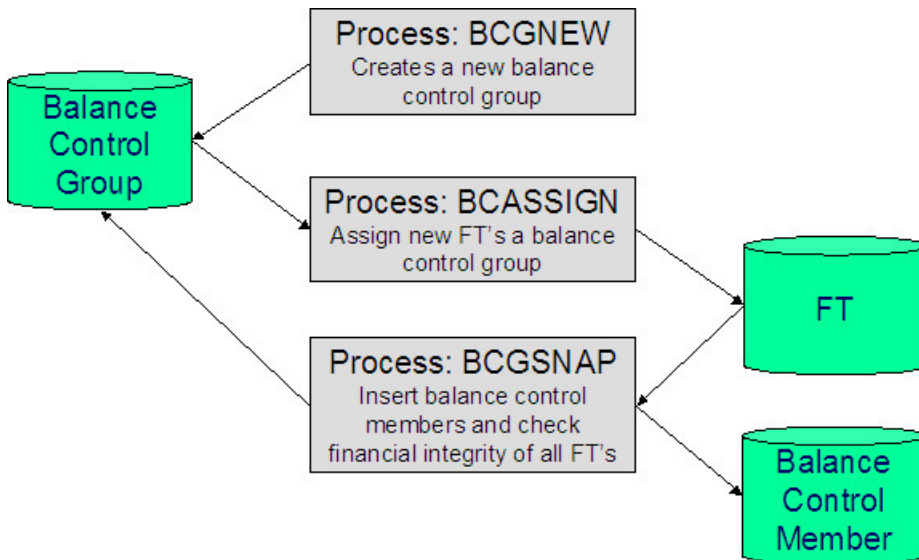

BCGNEW - Create A New Balance Control Group

This process creates a Pending balance control group if one doesn't already exist. You may wonder why an entire process is dedicated to such a trivial task. The reason is because the next process, BCASSIGN, is a multi-threaded (i.e., parallel) process and we only need one Pending balance control group regardless of the number of threads used to assign balance control ID's to financial transactions.

BCASSIGN - Assign New Financial Transactions A Balance Control Group

This multi-threaded (i.e., parallel) process assigns the Pending balance control group to new FTs whose freeze date/time is before the create date/time of the balance control record.

BCGSNAP - Insert BC Members And Check Financial Integrity Of All FTs

This process performs the following two functions:

- It summarizes new financial transactions under the current Pending balance control group as follows:
- It creates a balance control member for every combination of **Division**, **SA Type** and **FT Type** referenced on the financial transactions belonging to the balance control group.
- It updates each balance control member with the following information:
 - The number of financial transactions (FTs)
 - The sum of the total amounts on the FTs in this balance control group.
 - The sum of the current amounts on the FTs in this balance control group.
 - The sum of the total amounts from all FTs (in this and all other balance control groups).
 - The sum of the current amounts from all FTs (in this and all other balance control groups).
- It sets the status of the balance control group to Complete.
- It checks the integrity of the financial transactions in each historical Balance Control Group. It does this by summarizing EVERY financial transaction throughout time and determining if the sums are in sync with the values maintained on the balance control members. If integrity problems are detected, a detailed error message is displayed on the run control associated with the process.

If you opt to run the balance control processes on a nightly basis, you will find that the verification processing will take longer every night (because there are more financial transactions over time). In order to deal with this issue, the **BCGSNAP** process has a parameter that allows you to control which of the above functions is implemented (it's call **VERIFY-ONLY-SW**). In order to speed nightly processing, run this process with the switch set to "G" (this causes new financial transactions to be summarized under a new balance control). Then, once a week (or month), run this process with the switch set to "Y" (this checks the financial integrity of all financial transactions in the system).

If you run the balance control processes less frequently, you can set the **VERIFY-ONLY-SW** to "N" (this causes both of the above functions to execute).

Consider A Backup At This Point

We recommend you backup your database AFTER you run the above processes. Why? So that if a financial integrity problem is spotted in the future, you can compare the current database against the backup to see what changed.

Balance Control Information Is Available Online

Your internal auditors may be interested in the total number and amount of financial transactions that have been posted since a given point in time. You can use the [Balance Control](#) page to see this information.

The GL Interface

The following diagram illustrates the GL Interface.

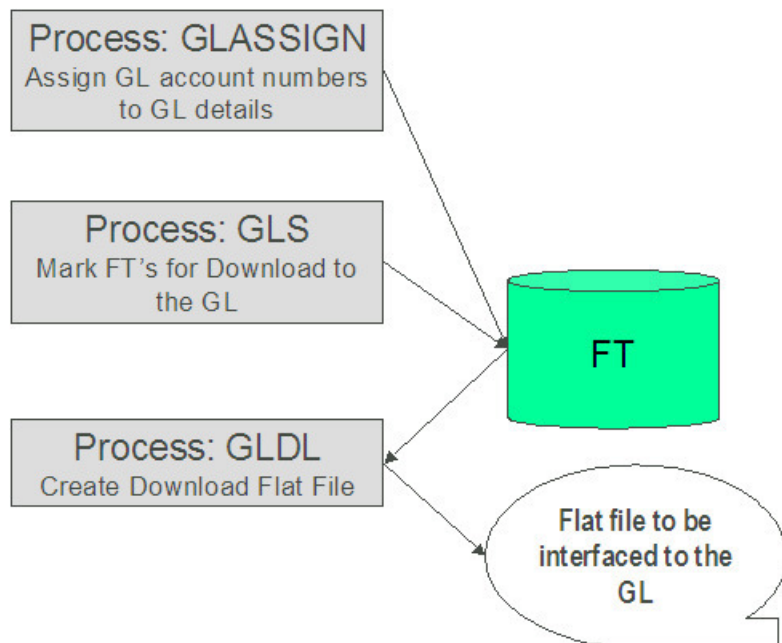

GLASSIGN - Assign GL Account Numbers To GL Details

The GLASSIGN process assigns GL account numbers to the GL details associated with financial transactions. GL account numbers are assigned as follows:

- Every GL detail references a distribution code.
- Every distribution code references a GL assignment algorithm. The base package algorithm simply uses the default GL account associated with the distribution code. However, you can construct your own algorithm(s) to assemble your GL account numbers in your desired fashion. Refer to [Setting Up Distribution Codes](#) for more information about the GL format algorithm.
- The GLASSIGN process simply calls each GL's details distribution code's GL assignment algorithm and updates the GL detail with the result (i.e., the GL account number). This GL account number is then used by the GLDL process when it creates the consolidated journal entry that's interfaced to the GL.

NOTE:

If incorrect GL account numbers get assigned to GL details... If you do not plug in the correct algorithm or your algorithm is wrong, you can correct the GL account numbers that are assigned to the GL details. How? Write a simple program that resets the GL account numbers on the erroneous GL details. Then run GLASSIGN. GLASSIGN will re-execute the distribution code GL assignment algorithm and refresh the account number accordingly.

GLS - Prepare FTs for Download

The GLS process creates FT download staging records for all FTs that are ready to be posted to the GL (the FT download staging records are stored on the FT/Process table). Each FT download staging record is marked with a batch control ID and run number.

- The batch control ID is the process responsible for creating the flat file that contains the consolidated journal entry that is interfaced to your general ledger. The batch control ID is defined on [Installation Options - Financial](#). The system comes with a single GL download program ([GLDL - Create General Ledger Download Flat File](#)). The GL account numbers are provided by the GL account algorithms that are specified on the distribution codes. Refer to [Setting Up Distribution Codes](#) for more information about the GL account algorithm.
- The run number is the batch control ID's current run number.

This process also changes the status of the FT to distributed. You may not change the FT's GL details after this time.

GLDL - Create General Ledger Download Flat File

The GLDL process creates the flat file that contains the consolidated journal entry that is interfaced to your general ledger. One header and multiple detail records are created as described below. At the conclusion of the batch process, a validation is performed to compare debits against credits. If they are not equal, the process terminates with an error.

Header Record Layout

Field Name	Format	Source/Value/Description
REC_TYPE	A1	1 (1 is used for header records)
BATCH_CD	A8	The code for the batch process that created the file. (This value will always be 'GLDL'.)
BATCH_NBR	N10	The batch process will be run many times. This field indicates which of those runs produced a particular output file. This may be thought of as an instance identifier for the batch process.
BATCH_RERUN_NBR	N10	Any given instance of the GLDL batch process may be re-run at any time. If this instance has been re-run, this field will be populated with a number indicating how often.
EXTRACT_DTTM	A26	The date and time of the run that created a particular output file.
DETAIL_REC_CNT	N12	The number of details records
DETAIL_REC_TOTAL_DR	N13.2	This is the sum of FINANCIAL_AMOUNTs from all detail records that were greater than zero (debits).

DETAIL_REC_TOTAL_CR

N13.2

This is the sum of FINANCIAL_AMOUNTs from all detail records that were less than zero (credits).

Detail Record Layout for GLDL

NOTE:

A record is created for each unique occurrence of REC_TYPE, GL_DIVISION, CURRENCY_CD, GL_ACCOUNT and ACCT_PERIOD. If a given GL account has debit and credit FINANCIAL_AMOUNTs, two records will be created - one shows the debit amount, the other shows the credit amount.

Field Name	Format	Source/Value/Description
REC_TYPE	A1	2 (2 is used for detail records)
GL_DIVISION	A5	This is the GL Division from the CI_FT record. It determines a) which Accounting Calendar will be used to calculate the Accounting Period (below) and b) the currency of the FT.
CURRENCY_CD	A3	The currency in which the Amount is denominated.
GL_ACCOUNT	A254	Contains the GL account number as supplied by the distribution code's GL account algorithm .
ACCT_PERIOD	A6	An accounting period in the format YYYYPP where YYYY is the fiscal year and PP is the accounting period. This is derived from the GL detail's FT's accounting date and GL division.
FINANCIAL_AMOUNT	N13.2	This is the debit or credit amount. Debits are represented by positive numbers; credits are represented by negative numbers. If a given GL account has debit and credit entries, two records will be created - one shows the debit amount, the other shows the credit amount.
STAT_CODE	A8	This is the GL distribution code's statistic code (if any)
STAT_AMOUNT	N13.6	This is the statistical amount from the GL detail lines

NOTE:

The GLASSIGN process updates an FT's GL details with the appropriate GL account number.

Financial Transaction

Payment segments, adjustments and bill segment have a corresponding financial transaction. The financial transaction is created by the system when any of the source transactions is created. It contains the financial effects of its corresponding adjustment / bill segment / payment segment.

FASTPATH:

For background information, refer to [The Big Picture Of Financial Transactions](#).

The topics in this section describe the financial transaction page.

Financial Transaction - Main

Use **Menu > Financial > Financial Transaction** to update and maintain financial transaction information.

NOTE:

Navigating from source transactions. On the bill, payment, and adjustment maintenance pages, you can click the financial transaction go to button to transfer to this page.

Description of Page

Most of the attributes on this page are display-only. The following points describe the conditions under which certain fields may be modified:

- **Accounting Date** may be modified until the financial transaction (FT) is interfaced to the GL (i.e., until the **GL Distribution Status** is Distributed).
- **New Charge** may be modified until the FT is swept onto a bill (when the next bill is completed for the FT's account). If **New Charge** is modifiable and turned off, **Arrears Date** must be specified.
- **Show on Bill** and **Correction** can be modified until the FT is frozen.

The remainder of this section defines each of the fields on the page.

FT Type is the type of financial transaction. Values are: Adjustment, Adjustment Cancellation, Bill Segment, Bill Segment Cancellation, Pay Segment, and Pay Segment Cancellation. Click the go to button to view the originating transaction on the adjustment, bill, or payment page.

FT ID is the system-assigned, unique identifier of the financial transaction.

SA ID is the system-assigned, unique identifier of the service agreement to which the financial transaction is linked.

Bill ID is the system-assigned, unique identifier of the bill to which the financial transaction is linked. This field is only populated after the FT is swept onto a bill (and this happens when the next bill is completed for the FT's account).

Sibling ID is the system-assigned, unique identifier of the source transaction associated with the FT.

- If this FT is associated with a bill segment, **Sibling ID** contains the unique identifier of the bill segment.
- If this FT is associated with a payment segment, **Sibling ID** contains the unique identifier of the payment segment.
- If this FT is associated with an adjustment, **Sibling ID** contains the unique identifier of the adjustment.

Parent ID contains the following:

- If this FT is associated with a bill segment, **Parent ID** contains the unique identifier of the bill with which the bill segment is associated.
- If this FT is associated with a payment segment, **Parent ID** contains the unique identifier of the payment with which the payment segment is associated.
- If this FT is associated with an adjustment, **Parent ID** contains the adjustment type.

Create Date/Time are the date and time the FT was created.

Accounting Date is the accounting date that will be used by the general ledger to define the accounting period(s) into which the FT will be booked.

CIS Division is the CIS division associated with the FT. This comes from the CIS division linked to the FT's service agreement's SA type.

GL Division is the GL division associated with the FT. This comes from the GL division linked to the FT's service agreement's SA type.

Show on Bill indicates if the FT will be shown on the customer's bill. You should only turn this off for erroneous FTs that should not be shown to the customer. For example, if you cancel / rebill a bill segment and you want to suppress the resultant FTs on the printed bill, turn this switch off.

New Charge indicates if the FT's charge only starts aging when the FT is swept onto the next bill produced for the account. If you want to manually enter an **Arrears Date** you must turn this switch off. The system leaves this switch set when assigning an arrears date during the bill completion process. This is done so the system knows which FTs were assigned an arrears date during bill completion. If a completed bill is reopened, the arrears date is reassigned when the bill is completed.

Not In Arrears indicates if the FT's financial impact has been canceled and therefore should not be considered for arrears purposes. This switch is turned on by the system when a FT's source transaction is canceled (both the original FT and the cancellation FT are marked as **Not In Arrears**).

Match Event ID is the system-assigned, unique identifier of the match event to which the financial transaction is linked. This field is only enabled for [Open Item Accounts](#). Be aware that changing a financial transaction's match event can result in the balancing / unbalancing of the prior and newly referenced match events.

Arrears Date is the date the FT starts aging. This field is typically blank until the FT is swept onto the account's bill. If you want to start aging an FT on an historical date (for whatever reason), enter the appropriate **Arrears Date**. (Note - you must uncheck the "New Charge" box first in order to do this.) If the arrears date is assigned manually it is not updated during bill completion nor is it adjusted when a bill is reopened and completed again.

Correction causes the FT to be summarized in the correction area of the bill-at-a-glance. This is set by the system automatically when a bill segment is cancelled / rebilled after its parent bill is completed (i.e., sent to the customer).

Redundant indicates if the FT's financial impact is considered irrelevant. This only happens after an FT has reached an age that is no longer relevant for aging purposes (e.g., when the FT is older than 120 days - or whatever age has been set as the Oldest Bucket Age on the Installation Options) and when its balance is exactly equal to zero with respect to other redundant FTs of the service agreement.

Transferred Out indicates if the FT has been transferred to a service provider. This could only happen if the FT is associated with a SA that is associated with a "they bill for us" service provider. Refer to [They Bill For Us](#) for more information.

The **Frozen** switch is turned on when the FT has been frozen (i.e., posted to the service agreement's payoff and/or current balances). If this switch is on, both **Freeze Date/Time** and **Frozen By** are populated.

Current Amount contains the FT's impact on the service agreement's current amount.

Payoff Amount contains the FT's impact on the service agreement's payoff amount.

FASTPATH:

For more information, refer to [Current Balance versus Payoff Balance](#).

Currency Code is the currency code associated with the FT's account.

GL Distribution Status defines the status of the FT in respect of its interface to the general ledger. When an FT is first created, its status is Pending . When an FT is frozen, this value is set to Generated. If you modify the GL details, the status becomes Modified. After it has been marked for interface to the general ledger by the GLS process, the status becomes Distributed.

GL Extract Dates display the **Scheduled** date that the GL details will be marked for interface to the general ledger. Note that this date is typically only set to a future date for FTs associated with automatic payments. **Actual** displays the date that the GL details were actually posted to the general ledger.

The grid at the bottom shows the FT's debits and credits (i.e., the detail journal lines). Debits are shown as positive amounts, credits are negative amounts. The following points describe rules governing if and how the information in the grid can be modified:

- The FT GL details may not be modified if the FT is Pending or Distributed.
- All **Amounts** must sum to zero.
- Multiple FT GL details may be set to affect the **Total Amount** (although they are normally generated with one GL checked to affect total amount).
- All FT GL's checked to affect **Total Amount** must sum to the **Payoff Amount** of the FT.

The following information is displayed:

- **Sequence number** is the system-assigned, unique identifier of the journal line.
- **Total Amount** defines if the journal line contains the total of the other journal lines. For example, on a bill segment for utility service, this would be turned on for the receivable account because its amount equals the sum of the other payable and revenue GL accounts.
- **Distribution Code** is the CIS distribution code from which the GL account constituents are derived.
- If the **GL Account** has been populated, the GL account number is displayed.

FASTPATH:

Refer to [GLASSIGN - Assign GL Account Numbers To GL Details](#) for more information about how the GL account is populated.

- **Amount** defines the journal line's amount.
- **Statistic Amount** defines the statistical amount that will be posted to the GL. This value is only populated on distribution lines created for calculation rules designated as affecting GL statistical quantity.
- **Characteristic Type** and **Characteristic Value** describe the characteristic value that was used when the line's amount was calculated. This information is only displayed if the journal line was derived from bill calculation lines that were calculated using a bill factor (because only bill factor's use characteristic values). Refer to [An Illustration Of A Bill Factor And Its Characteristics](#) for more information.

NOTE:

Tax reporting. A journal line's characteristic value is NOT interfaced to the GL. We have included this attribute on the journal line so that tax reporting can be performed from this system (tax reporting typically necessitates showing each taxing authority - the characteristic value - that participated in a given tax payable GL account).

- If you have configured your installation options to indicate that [fund accounting](#) is practiced, the description of the **Fund** associated with this distribution code is displayed.

Financial Transaction - FT Process

Use **Menu > Financial > Financial Transaction** and navigate to the **FT Process** page to view those ancillary processes that may be triggered as a result of this financial transaction.

NOTE:

Algorithms cause financial transactions to be linked to batch processes. Financial transactions get associated with a given process / batch number when certain algorithms are executed. For example, when a bill segment is frozen, the system executes the freeze algorithms associated with the bill segment's service agreement's SA type. One of these algorithms may check if there are service providers who are interested in the bill segment's consumption, and if so, schedule the consumption to be downloaded by linking the bill segment's financial transaction to the service provider's consumption download process.

Description of Page

This page shows the **Batch Processes** associated with a given **Financial Transaction**. Information on this page may not be modified. This information appears purely for audit purposes.

Account Financial History

This portal shows how an account's current and payoff balance have changed over time. You can access the portal from **Menu > Financial Query > Account Financial History**.

Refer the portal's embedded help for more details.

FASTPATH:

For information about current and payoff balance, refer to [Current Amount versus Payoff Amount](#).

Account Bill / Payment History

This portal shows an account's bills and payments. You can access the portal from **Menu > Financial Query > Account Bill / Payment History**.

For [balance-forward accounts](#), bill rows contain the balance presented on the respective bill, and payment rows contain the amount of the respective payment. However, for [open-item accounts](#), this query behaves differently. Refer to the portal's embedded help for more details.

NOTE:

Credit Notes or Correction Notes. The Bill Correction option on the Installation record controls whether Credit Notes or Correction Notes are allowed. The default transaction type filter displayed is for Credit Note. If your implementation uses Correction Notes, you'll need to change the transaction type filter to reflect this. This is done by overriding the label for lookup value CRNT on the customizable lookup field TXN_FLTR_TYPE_FLG.

SA Financial History

This portal shows how a service agreement's current and payoff balance have changed over time. You can access the portal from **Menu > Financial Query > SA Financial History**.

Refer to the portal's embedded help for more details.

FASTPATH:

For information about current and payoff balance, refer to [Current Amount versus Payoff Amount](#).

SA Non-Accrual Accounting Balance

NOTE:

Only relevant if you practice non-accrual accounting. This transaction is only relevant if you practice non-accrual accounting (e.g., you only pay the taxing authorities when the customer pays you, you defer revenue recognition till a later date, or a combination of the two). Refer to [Payables Cash Accounting](#) and [Deferred Accrual Accounting](#) for more information about non-accrual accounting.

This page displays a grid that shows a service agreement's non-accrual accounting balance for each non-accrual holding distribution code that's been booked to. Use **Menu > Financial Query > SA Non-Accrual Accounting Balance** to open this page.

Description of Page

The following columns are displayed in the grid:

Holding Distribution Code This is a general ledger distribution code used as the holding account for non-accrual accounting. Each holding account that's been used by this service agreement will appear here.

Payable Distribution Code This is the general ledger distribution code to which the payable is (or will be) transferred when the cash event occurs or when the designated revenue recognition date elapses. The system supports revenue recognition on the bill due date.

FASTPATH:

For more information on how the distribution codes are set up, refer to [Setting Up Distribution Codes](#).

Payoff Balance This column shows the service agreement's balance for each non-accrual holding account. If this amount is non-zero, it indicates that for this service agreement we are still holding some payables back until payment is received by the customer, at which time some or all of this amount will be transferred to the payable distribution code.

Accounting Method This column shows which accounting method is used for the distribution.

Accounting Priority This column shows the priority level associated with the distribution code. If more than one distribution code is to receive a payable then the priority level, along with debt age, will determine the order in which the transfers are made.

FASTPATH:

For information about non-accrual accounting, refer to [Payables Cash Accounting](#) and [Deferred Accrual Accounting](#).

Balance Control

This page is used to summarize the financial transactions that belong to a particular balance control group.

FASTPATH:

Refer to [The Big Picture of Balance Control](#) for more information.

NOTE:

Balance Control information is current only as of the Create Date/Time listed. The information displayed on the page is captured when the balance control background process is run. Any financial activity subsequent to the create date and time will not be shown.

Use **Menu > Financial Query > Balance Control** to open this page.

Description of Page

This page displays summarized financial information for a particular balance control group. It also details financial information for all SA Types that belong to the group.

The following fields are displayed on the page:

Group ID This is a sequential value that uniquely identifies a particular balance control run. The Group ID is assigned and incremented automatically every time the Balance Control background process is run.

Status This is the status of the balance control record: Pending, and Complete . The status of the balance control record will only be pending while the balance control background process is being executed. Balance control information is only reliable if the status is complete.

Create Date/Time This is the date and time that the balance control record was created. Financial information displayed on this page will only contain information for financial transactions frozen before this date and time.

Current Amount This is the sum of the current amounts of all FTs that belong to the balance control group.

Payoff Amount This is the sum of the payoff amounts of all FTs that belong to the balance control group.

Current Balance This is the sum of the current amounts of all FTs that belong to this balance control group plus all earlier balance control groups. Therefore this is the instantaneous current balance of the entire CIS as of the create date and time.

Payoff Balance This is the sum of the payoff amounts of all FTs that belong to this balance control group plus all earlier balance control groups. Therefore this is the instantaneous payoff balance of the entire CIS as of the create date and time.

The number of FT information details the number of bill segments, pay segments, adjustments and their cancellations that belong to the balance control group.

Adjustment The total number of adjustments that belong to this balance control group.

Adjustment Cancellation The total number of adjustment cancellations that belong to this balance control group.

Bill Segment The total number of bill segments that belong to this balance control group.

Bill Segment Cancellation The total number of bill cancellations that belong to this balance control group.

Pay Segment The total number of pay segments that belong to this balance control group.

Pay Segment Cancellation The total number of pay cancellations that belong to this balance control group.

The **SA Type** scroll summarizes the FTs that belong to a particular SA Type within the balance control group - otherwise all fields are defined as above. You can scroll through all SA Types that belong to the balance control group.

SA Type The SA Type being summarized.

Match Event

WARNING:

Match Events are only used if you practice [Open Item Accounting](#).

Match events are used to match debit and credit financial transactions together. When financial transactions are linked to a balanced match event, they no longer affect the customer's arrears.

You can use the match event page to do the following:

- Add, change, delete, and cancel match events.
- Add and remove financial transactions from / to a match event.
- Designate financial transactions as being "in dispute" (disputed financial transactions do not affect aged debt until they are resolved).
- View all unmatched financial transactions linked to an account.

FASTPATH:

Refer to [Match Events](#) for a full description of the lifecycle of a match event and a description of how the system automatically creates match events.

Match Event - Main

A typical match event matches a bill's financial transactions with a payment's financial transactions. The **Main** page allows you to define the bill(s) and payment(s) whose financial transactions are matched together. Use **Menu > Financial > Match Event > Search** to open this page.

NOTE:

Debit must equal credits. Before a match event impacts a customer's arrearage, its debits and credits must net to zero for every service agreement referenced on the match event. Until that time, the financial transactions on a match event continue to affect arrearage. The only exception is the case of [disputes](#).

You can match any debit and credit. While the above describes the matching of bills and payments, it's important to remember that a match event matches any type of debit with any type of credit. This means that a match event could match a bill with a credit or correction note, or a payment with a payment cancellation.

You can match any number of payments under a match event. While most match events deal with a single bill and a single payment, there's no limitation to the number of payments on a match event. The only restriction is that the debits and credits must net to zero for all service agreements.

It is better not to mix multiple bills on a single match event. For purposes of bill balance information, it is strongly recommended that you compose your match events with financial transactions limited to a single bill. If you mix financial transactions from multiple bills on a single match event you will not be able to determine the unpaid balance of a partially paid bill.

You can match specific financial transactions. While most match events deal with every financial transaction on a bill and payment, a match event can deal with individual financial transactions. For example, a match event could match a bill segment with a combination of a payment segment and a write-off adjustment. If you need to add or remove a specific financial transaction (i.e., a bill segment, payment segment, or adjustment), navigate to the **FT Details** tab. Perhaps a better way to differentiate between this page and the **FT Details** tab is to consider the example of a bill with 100 bill segments. When you link this bill to a match event, you are actually linking its 100 financial transactions. If you wanted to add only a subset of this bill's financial transactions to the match event, you'd use the **FT Details** tab.

FASTPATH:

Refer to [How To](#) for instructions describing how to perform common match event maintenance functions.

Description of Page

This page is used to maintain the financial transactions (FTs) that are linked to a match event. The remainder of this section defines each of the fields on the page.

Match Event Info and **Match Event ID** only appear after the match event exists on the database. The **ID** is a system assigned random number that stays with the match event for life. **Match Event Info** is a concatenation of important details about the match event and its account.

The next section contains the sum of the **Debit** and **Credit** financial transactions linked to the match event. If the debits and credits do not sum to zero, the **Difference** is also shown.

Account ID defines the account whose financial transactions are matched under this match event. This field is gray after the match event is added to the database.

Match Event Status defines the state of the match event.

- Match events are initially created in the open state. Please note that you may delete an open match event.
- The system automatically changes an open event's status to balanced when the sum of the **Debit(s)** equals the sum of the **Credit(s)** for each service agreement on the match event. It's worth stressing that a match event may contain financial transactions from many service agreements and each service agreement's financial transactions must sum to zero before the match event can become balanced.
- You may re open a balanced event (by adding / removing items so that the match event becomes unbalanced).
- You can cancel a balanced or open match event by changing the **Match Event Status** to cancelled. You must also define a **Cancel Reason** if you cancel a match event. Refer to [How Are Match Events Cancelled?](#) for more information about cancellation.

Turn on **Dispute** if this match event exists to designate certain financial transactions as **disputed**. In addition,

- Describe the reason for the dispute in **Remarks**.
- Link the disputed financial transactions to the match event by selecting the bill(s) below. If only a subset of a bill is disputed:
- Click on the respective hyperlink in the **Unmatched Debits** column grid (this will transfer you to the next tab with these financial transactions displayed).
- Select the bill segments that you want to designate as disputed.
- Press the **Link / Unlink** button to link the selected bill segments to the match event.

NOTE:

Disputing items on a balanced event. The **Dispute** switch will be protected when the match event is Balanced or Cancelled. If the items on a balanced event are being disputed, you must add / remove items so that the match event becomes Open before you can turn on the **Dispute** switch.

The remainder of the page is dynamic depending on the **Match Event Status**:

- If the status is Balanced or Open, a grid appears containing a summary of the bills, payments, credit or correction notes, and payment cancellations that contribute financial transactions to the match event (note, we refer to these collectively as "contributing objects" in the following discussion). The following columns appear in this grid:
- **Transaction Type** defines whether the contributing object is a Bill, Payment, Payment Cancellation, or Credit or Correction Note. In the rare situation when unbilled financial transactions are linked to the match event, a transaction type of Not Billed Yet appears. If the contributing object is a bill its bill id is also displayed. If sequential bill functionality is enabled, the bill's sequential id is displayed instead.
- **Matched Activity Information** contains summary information about the contributing object. This column is blank if the transaction type is Not Billed Yet.
- The remaining columns contain the count and amount of each contributing object's financial transactions categorized as follows (note, you can drill down on the count or amount to see the specific financial transactions (FT's) on the next tab).
- **Matched Debits** summarizes the contributing object's debit FT's that are linked to this match event. A checkbox appears if the count is greater than zero. If you select the checkbox and press the **Link / Unlink** button, these debits will be removed from the match event.

- **Matched Credits** summarizes the contributing object's credit FT's that are linked to this match event. A checkbox appears if the count is greater than zero. If you select the checkbox and press the **Link / Unlink** button, these credits will be removed from the match event.
- **Other Debits** summarizes the contributing object's debit FT's that are NOT linked to this match event.
- **Other Credits** summarizes the contributing object's credit FT's that are NOT linked to this match event.

NOTE:

Adding more financial transactions to a balanced match event. When a match event is Balanced, the grid showing unmatched FT's is suppressed (and therefore you can't add additional FT's to the match event). To expose this grid, simply change the status of the match event to Open.

- If the status is Open, a second grid appears containing a summary of the bills, payments, credit notes, correction notes and payment cancellations with at least one unmatched financial transaction (we refer to these collectively as "unmatched objects" in the following discussion). The following columns appear in this grid:
- **Transaction Type** defines whether the unmatched object is a Bill, Payment, Payment Cancellation, Credit, or Correction Note. A transaction type of Not Billed Yet is used for unbilled financial transactions (e.g., adjustments generated between bills). If the unmatched object is a bill its bill id is also displayed. If sequential bill functionality is enabled, the bill's sequential id is displayed instead.
- **Unmatched Activity Information** contains summary information about the unmatched object. This column is blank if the transaction type is Not Billed Yet.
- The remaining columns contain the count and amount of each unmatched object's financial transactions categorized as follows (note, you can drill down on the count or amount to see the specific financial transactions (FT's) on the next tab).
- **Unmatched Debits** summarizes the unmatched object's debit FT's that are not linked to any match event. A checkbox appears if the count is greater than zero. If you select the checkbox and press the **Link / Unlink** button, these debits will be added to the match event.
- **Unmatched Credits** summarizes the unmatched object's credit FT's that are not linked to any match event. A checkbox appears if the count is greater than zero. If you select the checkbox and press the **Link / Unlink** button, these credits will be added to the match event.
- **Matched Debits** summarizes the unmatched object's debit FT's that are linked to any match event.
- **Matched Credits** summarizes the unmatched object's credit FT's that are linked to any match event.

NOTE:

Credit Notes or Correction Notes. The Bill Correction option on the Installation record controls whether Credit Notes or Correction Notes are allowed. The default Transaction Type displayed is for Credit Note. If your implementation uses Correction Notes, you'll need to change the transaction type filter to reflect this. This is done by overriding the label for lookup value CRNT on the customizable lookup field TXN_FLTR_TYPE_FLG.

The last section contains the running total of the **Debit** and **Credit** financial transactions that have been selected / unselected in the above grids. If debits and credits do not sum to zero, the **Difference** is also shown. These values differ from the values on the top of the page as they are updated when a user selects / unselects an object (whereas the values at the top of the page are only updated when the database is changed).

The **Link / Unlink** button becomes enabled when you select an object in the grids. When you press this button, the financial transactions related to the object are added to / removed from the match event.

Match Event - FT Details

On the **Main** tab, you can add and remove bills, payments, credit notes, correction notes and payment cancellations to / from a match event. When you do this, you are actually adding and removing all of the financial transactions linked to these objects. For example, when you link a bill with 100 bill segments to a match event, you are actually linking its 100 financial transactions.

You need only use the **FT Details** tab when you need to add or remove specific financial transactions. For example, you would use the **FT Details** tab if you need to remove 1 of a bill's 100 financial transactions from a match event.

Use **Menu > Financial > Match Event > Search** and navigate to the **FT Details** page (note, you can also open this page using many of the hyperlinks on the Main and SA Subtotals tabs).

Description of Page

This page is used to maintain the financial transactions (FTs) that are linked to a match event. The remainder of this section defines each of the fields on the page.

Match Event Info and **Match Event ID** only appear after the match event exists on the database. The **ID** is a system assigned random number that stays with a match event for life. The **Match Event Info** is a concatenation of important details about the match event and its account.

The next section contains the sum of the **Debit** and **Credit** financial transactions linked to the match event. If the debits and credits do not sum to zero, the **Difference** is also shown.

The following **Filters** work together to restrict the financial transactions that appear in the grid. The following points describe the various options (note, don't forget to press the search button after specifying the various filter options):

- Use **Transaction Type Filter** to restrict the type of transactions that appear in the grid. The following options are available:
 - All. Use this option if you do not wish to restrict financial transactions based on their transaction type.
 - Bill. This option allows you to view a specific bill's financial transactions. When this option is selected, an input field appears in which you identify the **Bill ID**.
 - Credit Note. This option allows you to view a specific credit note's financial transactions. When this option is selected, an input field appears in which you identify the **Bill ID** (every credit note has a unique bill ID).
 - Correction Note. This option allows you to view a specific correction note's financial transactions. When this option is selected, an input field appears in which you identify the **Bill ID** (every correction note has a unique bill ID).
 - Not Billed Yet. This option allows you to view financial transactions that haven't appeared on a bill yet (e.g., adjustments and corrections).
 - Payment. This option allows you to view a specific payment's financial transactions. When this option is selected, an input field appears in which you identify the **Payment ID**.
 - Payment Cancellations. This option allows you to view a specific canceled payment's financial transactions. When this option is selected, an input field appears in which you identify the **Payment ID**.

NOTE:

Credit Notes or Correction Notes. The Bill Correction option on the Installation record controls whether Credit Notes or Correction Notes are allowed. The default Transaction Type displayed is for Credit Note. If your implementation uses Correction Notes, you'll need to change the transaction type filter to reflect this. This is done by overriding the label for lookup value CRNT on the customizable lookup field TXN_FLTR_TYPE_FLG.

- Use **Linkage Filter** to restrict the transactions based on the match event to which they are linked. The following options are available:
 - All. This option shows all financial transactions regardless of their match event.
 - Linked to another Match Event. This option shows financial transactions linked to a different match event.
 - Linked to any Match Event. This option shows financial transactions linked to any match event.
 - Linked to this Match Event. This option shows financial transactions linked to this match event.

- Unmatched. This option shows financial transactions that are not linked to a match event. This filter is protected and set to Linked to this Match Event if the **Transaction Type Filter** is All.
- Use **Debit / Credit Filter** to restrict the transactions based on whether they are debits or credits. The following options are available:
 - All. This option shows all debit and credit financial transactions.
 - Credit. This option shows all credit financial transactions.
 - Debit. This option shows all debit financial transactions.
- Use the **SA Filter** to define the types of service agreements whose financial transactions appear in the grid. The following options are available:
 - Address. Use this option to restrict financial transactions to those whose service agreements are linked to service points associated with a given **Address, City** and/or **Postal** code. Note, you can specify any combination of these fields.
 - All. Use this option if you do not wish to restrict financial transactions based on service agreement attributes.
 - Geographic Type. Use this option to restrict financial transactions to those whose service agreements are linked to service points associated with a given **Geo Type** and **Value**.
 - SA ID. Use this option to restrict financial transactions to those linked to a specific **Service Agreement**.
 - SA Type. Use this option to restrict financial transactions to those whose service agreements are linked to a given **CIS Division** and **SA Type**.

WARNING:

Don't forget to click the search button after changing the filters.

The **Select All / Clear All** buttons are used to select financial transactions to add to / remove from the match event (note, after selecting the desired financial transactions, you must also press the **Link / Unlink** button at the bottom of the page).

NOTE:

50 financial transactions at a time. Clicking **Select All** selects the first 50 bill segments in the grid. If more than 50 financial transactions exist, you must select them in batches.

The grid that follows contains the financial transactions (FT) that match your search criteria. The following information appears in the grid:

- **Select box.** Select the FT if you want to Link / Unlink it. You implicitly link FT's that are NOT already linked and you implicitly unlink FT's that are already linked. This field is protected if the FT is linked to another match event.
- **FT Amount.** This column contains the amount of the financial transaction.
- **FT Type.** This column indicates the type of financial transaction: Bill Segment, Bill Segment Cancellation, Pay Segment, Pay Segment Cancellation, Adjustment, and Adjustment Cancellation.
- **Arrears Date.** This column contains the financial transaction's arrears date.
- **SA Information.** This column contains a summary of the financial transaction's service agreement.
- **Remarks.** This column highlights the financial transaction's match status: Linked to this match event, Not linked to a match event, Linked to another match event - match event status.
- **Premise Information.** This column contains a summary of the premise (if any) associated with the financial transaction's service agreement.

The last section contains the running total of the **Debit** and **Credit** financial transactions that have been selected / unselected in the grid. If debits and credits do not sum to zero, the **Difference** is calculated. These values differ from the values on the top of the page as they are updated when a user selects / unselects an object (whereas the values at the top of the page are only updated with the database is changed).

The **Link / Unlink** button becomes enabled when you select a row in the grid. When you press this button, the financial transactions related to the object are added to / removed from the match event.

Match Event - Subtotals

Before a match event impacts a customer's arrearage, its debits and credits must net to zero for every service agreement referenced on the match event. This page shows the sum of the debits and credits for every service agreement that contributes at least one financial transaction to the match event. Use **Menu > Financial > Match Event > Search** and navigate to the **Subtotals** page

Description of Page

This page shows the sum of the debits and credits for every service agreement that contributes at least one financial transaction to the match event.

Match Event Info and **Match Event ID** only appear after the match event exists on the database. The **ID** is a system assigned random number that stays with a match event for life. The **Match Event Info** is a concatenation of important details about the match event and its account.

The next section contains the sum of the **Debit** and **Credit** financial transactions linked to the match event. If the debits and credits do not sum to zero, the **Difference** is also shown.

The following **Filters** work together to restrict the service agreements that appear in the grid. The following points describe the various options (note, don't forget to press the search button after specifying the various filter options):

- Use the **SA Filter** to define the types of service agreements whose financial transactions appear in the grid. The following options are available:
 - Address. Use this option to restrict service agreements to those linked to service points associated with a given **Address**, **City** and/or **Postal** code. Note, you can specify any combination of these fields.
 - All. Use this option if you do not wish to restrict service agreements.
 - Geographic Type. Use this option to restrict service agreements to those linked to service points associated with a given **Geo Type** and **Value**.
 - SA ID. Use this option to see a specific **Service Agreement**.
 - SA Type. Use this option to restrict service agreements to those with a given **CIS Division** and **SA Type**.
- Use **Status Filter** to restrict the service agreements based on whether the sum of the debits and credits they contribute to the match event. The following options are available:
 - All. Use this option if you do not wish to restrict service agreements based on this status.
 - Balanced. This option shows only service agreements where the sum of debit and credits nets to zero on this match event.
 - Unbalanced. This option shows only service agreements where the sum of debit and credits do not net to zero on this match event.

WARNING:

Don't forget to click the search button after changing the filters.

The grid that follows contains the service agreements that match your search criteria. The following information appears in the grid:

- **SA Information.** This column contains a summary of important information about the service agreement.
- **Difference.** This column contains the difference between the **Matched Debits** and **Match Credits**. If this is non-zero, the value appears in red.

- **Matched Debits.** This column contains the sum of debit financial transactions that this service agreement contributes to this match event.
- **Matched Credits.** This column contains the sum of credit financial transactions that this service agreement contributes to this match event.
- **Premise Information.** This column contains a summary of the premise (if any) associated with the financial transaction's service agreement.

How To Perform Common Match Event Functions

How To Find The Match Event Associated With A Financial Transaction

If you need to find the match event on which a financial transaction (FT) was matched, display the FT in question on [Financial Transaction - Main](#) and then use the "go to" button adjacent to the **Match Event** to drill to the match event.

NOTE:

The easiest way to display a financial transaction is to find its corresponding [bill](#), [payment](#) or [adjustment](#) and then drill down on the desired transaction.

How To Dispute An Item

Refer to [Disputing Items](#) for background information about disputes.

If a customer wants to dispute an item:

- Turn the match event's dispute switch on.
- Link the disputed financial transaction to the match event.
- Describe in the match event's comments the reason for the dispute.

How To Match A Small Mismatch

Assume the following scenario arises:

- A bill is produced for \$2000
- The customer pays \$1993
- An unbalanced match event will result because the customer didn't pay exactly what is owed

If you want to match this payment to the bill (and leave \$7 for the next bill), do the following:

- Create a transfer adjustment of \$7 where the transfer from / to service agreement is the same. This results in a debit financial transaction (FT) of \$7 and a credit FT of \$7.
- Create a match event (or update the unbalanced match event) where the matched FTs are:
 - The \$1993 payment
 - The credit side of the transfer adjustment (\$7)

- And the \$2000 bill
- Then, if the customer pays their next bill in full, the \$7 debit (associated with the transfer adjustment) will be swept onto it.

NOTE:

Automating small mismatches. The algorithm responsible for matching a payment to a specific bill can have a tolerance amount defined on it. If the payment is within the tolerance limit, this algorithm will do the above for you. In other words, you don't have to manually do the above if you populate the tolerance limit appropriately on this algorithm. Refer to DSOV BILL-ID for more information about this algorithm.

Deposits

In this section, we describe how to manage your deposits.

The Big Picture Of Deposits

The topics in this section provide background information about a variety of deposit issues.

FASTPATH:

We strongly recommend familiarizing yourself with the topics described in [The Financial Big Picture](#) to fully appreciate how deposits fit into the system's financial architecture.

Cash Deposits

Before you can bill a customer for a deposit, there must be a deposit service agreement (SA). Deposit SAs will be created by a CSR using [Start/Stop Service](#) (the same page used to create all other types of service agreements).

Deposit SAs behave just like any other service agreement in that:

- A deposit SA must reference an SA type. Refer to [Service Agreement Type Controls Everything](#) for information about how SA type controls a service agreement's behavior.
- Bill segments will be produced to bill the customer for a deposit. Note, bill segments associated with deposit SAs will appear on the same bill as other bill segments related to its account (i.e., a bill could contain a combination of utility, deposit, and non-utility bill segments).
- When a customer makes a payment, it will be distributed amongst its account's SAs based on each SA's payment distribution priority. This means a single payment could relieve receivable accounts (associated with utility service agreements) and increase a payable account (associated with the deposit service agreement). Refer to [Distributing A Payment Amongst An Account's Service Agreements](#) for more information.
- You can use a transfer adjustment to relieve debt on some other type of service agreement (by transferring all or part of the deposit's credit balance to another service agreement).
- You can use an A/P adjustment to cause a check to be created if you need to manually refund a deposit.
- When you no longer require the deposit, a CSR will stop the deposit SA using [Start/Stop Service](#) (the same page used to stop all other types of service agreements). Refer to [Refunding Deposits](#) for information about how the refund actually takes place.

FASTPATH:

Refer to [Deposit Class Controls Everythingfor information](#) about deposit interest, the recommended deposit amount algorithm, and how deposits are refunded.

NOTE:

An account can have many deposits. You can view all deposits (both cash and non-cash) linked to an account on [Account - Deposits](#).

Refunding Deposits

To refund a deposit, you simply need to change the deposit SA's state to pending stop. The system does everything else (i.e., calculates interest and refunds the deposit to the customer).

There are three ways in which a deposit SA's state can become pending stop:

- The Deposit Refund background process (DEPRFND) make a deposit service agreement pending stop when it detects that the customer meets the automatic refund criteria. Refer to [Defines The Conditions That Cause The System To Automatically Refund A Deposit](#) for a description of how to define the conditions that control automatic refund.
- An operator, at their discretion, may refund a deposit by stopping the deposit SA using [Start/Stop Service](#) (the same page used to stop all other types of service agreements). This page simply changes the deposit SA's state to pending stop.
- The system changes the state of a deposit service agreement to pending stop when it recognizes that all other SAs of its deposit class have also been stopped. This may be necessary, for example, when a customer's utility service agreements have been severed for non-payment. Refer to [Deposit Seizures When Other SAs Are Stopped](#) for more information.

The system changes the state of a pending stop SA to stopped when the process responsible for [Finalizing Pending Stops](#) next runs.

When a deposit SA becomes stopped, the system calculates interest through the stop date. Refer to [Controls Interest Calculation](#) for a description of how interest is calculated.

NOTE:

If you can't wait for this process to run, simply display the deposit SA on [Service Agreement - Main Information](#) and press the stop button.

When the stopped deposit SA is final billed, the system produces a final bill segment that shows the deposit amount being returned to the customer. When the bill segment's bill is completed, the deposit is refunded to the customer as per the deposit refund algorithm on the deposit's deposit class. Refer to [Controls How Deposits Are Refunded To A Customer](#) for a description of how a deposit is refunded.

WARNING:

None of the base package deposit refund algorithms create an A/P adjustment when the deposit service agreement is final billed. Rather, they depend on the [write-off preprocessing](#) to actually refund the deposit to the customer.

Partial Refunds

You can perform a partial refund by creating an adjustment for the deposit SA. If you want to refund the adjustment with a check, this adjustment should be an A/P adjustment (i.e., one that is interfaced to A/P). If you want to refund the adjustment by offsetting some other service agreement's debt, create a transfer adjustment (transferring from the deposit SA to the SA to be relieved).

After creating the adjustment, you'll find that the deposit SA has a positive current amount due (because you debited the deposit SA to refund the credit amount). You should create another adjustment to return the current amount of the deposit to zero. It's important to use an adjustment type that only affects current amount when you do this.

After getting the deposit's current amount back to an expected amount, you will have to change the deposit SA's Total Amount To Bill to reflect the amount of deposit you want to hold for the customer. So, for example, if you were holding a \$500 deposit and you want to refund \$100, you should change the deposit SA's Total Amount To Bill to be \$400.

Total Amount To Bill

Most deposit service agreements contain a "Total Amount To Bill" field. The label for this field is defined on the SA type (on the Billing tab). For deposit SAs, it should be labeled something like **Cash Deposit Amount**. This field should reflect the deposit amount you WANT to hold on this service agreement. Please be aware of the following in respect of this field:

- If the payoff balance (i.e., the current deposit held) is less than the Total Amount To Bill, the system will generate a bill segment to charge the customer for the deposit.
- If the deposit service agreement uses a recurring charge (i.e., you bill the total amount in installments), the amount billed to the customer will not exceed the recurring charge amount (unless the bill segment is prorated).
- If the deposit service agreement does not use a recurring charge, the amount billed will equal the difference between Total Amount To Bill and the service agreement's payoff balance.
- If you need to bill an incremental deposit on an existing deposit service agreement, simply change the deposit service agreement's Total Amount To Bill.
- If the payoff balance (i.e., the current deposit held) is greater than the Total Amount To Bill, the system will NOT refund the excess deposit.

NOTE:

SA Type and Total Amount to Bill. A deposit service agreement's SA type controls if the deposit service agreement uses Total Amount to Bill. Typically, the only SA types that indicate this field can be used are loan and deposit service agreements.

Current Balance versus Payoff Balance

WARNING:

If you do not understand the difference between payoff balance and current balance, refer to [Current Amount versus Payoff Amount](#).

The current balance on a deposit SA contains the amount of the deposit that has been billed, but not paid. The payoff balance on a deposit SA contains the amount of deposit being held. The payoff balance is a negative number because your company owes this money to the customer.

The financial ramifications of a deposit SA are predictable (if you're an accountant). The following table outlines the different financial events and their impact on the general ledger, arrearage history, and the amounts due (both current and payoff).

NOTE:

It's important to be aware that everything that is shown in this table is controlled by how you set up the deposit SA type's bill segment type, payment segment type, and adjustment types. Refer to [Service Agreement Type Controls Everything](#) for how to do this.

Event	GL Accounting	Arrearage Rule	Effect On Payoff Amt	Effect On Current Amt	Payoff Balance	Current Balance
Deposit billed	N/A - the GL is not affected when a deposit is billed	\$100 starts aging	0	+100	0	100
Payment received	Cash 100 Deposit Payable <100>	\$100 relieved accordingly	-100	-100	-100	0
Interest calculated	Interest Exp 5 Deposit Payable <5>	N/A	-5	0	-105	0

The following points describe the events in the above table:

- **Deposit billed.** In this example, the customer is billed for \$100 deposit.
- The customer really thinks they owe the billed amount, \$100. Therefore, current amount is affected. However, if the customer was to cash out, they wouldn't owe your organization anything, therefore payoff amount is not affected.
- Notice that the GL is not affected when the deposit is billed. This is because most organizations do not show a receivable for billed deposits (as it's not a true receivable).
- Because current amount changed by \$100, arrearage history is affected accordingly.
- **Payment received.** With any luck, the client will pay the \$100 that was billed.
- The payment has a normal affect on the GL (debit cash, credit deposit payable). The deposit payable GL account is defined as the deposit SA type's Distribution Code.
- The amount the customer thinks they owe decreases by \$100, therefore current amount is affected by the payment amount. And, if the customer was to cash out, your organization would owe the customer \$100, therefore payoff amount is affected by the payment amount.
- Because current amount changed by \$100, arrearage history is affected accordingly.
- **Interest calculated.** In this example, the system calculates interest of \$5.
- The interest is posted to the GL (the interest expense distribution code is defined on the respective adjustment type).
- The interest amount didn't affect how much the customer thinks is due them. Therefore current amount is unaffected. However, if the customer was to cash out, your organization would owe them \$100 + \$5 (the interest) therefore payoff amount is affected by \$5.
- Because current amount is not changed, arrearage history is not affected.

Multiple Deposits Linked To A Single Account

The system has been designed to allow your customers to have multiple deposits. This is necessary when a deposit is restricted to a specific type of debt. For example, if separate deposits are held for regulated and unregulated debt (and a customer could hold a combination of regulated and unregulated debt), you'd need one deposit for regulated debt and another for unregulated debt.

NOTE:

Deposit class. A deposit's deposit class controls the service agreements that are covered by a given deposit. A deposit's deposit class is defined on its SA type. Refer to [Designing Your Deposit Classes](#) for more information.

It's important to be aware that if your company has multiple classes of deposits, the system will recommend and refund deposits for each individual deposit class. For example, if you have both regulated and unregulated deposit classes, the system will recommend separate deposits for each class. And at refund time, a deposit will be distributed to only those service agreements associated with its deposit class (i.e., a regulated deposit will not be used to satisfy unregulated debt).

Deposits and Credit & Collections

The [account debt monitor](#) monitors deposit service agreements just as it monitors every other service agreement for overdue debt. If the amount of debt on the deposit SA violates your collection criteria, a collection process will start.

FASTPATH:

Refer to [The Lifecycle Of A Collection Process And Its Events](#) for more information.

It's important to be aware that deposit debt can be treated differently from other types of debt linked to an account by creating a specific debt class for the deposit SA type.

FASTPATH:

Refer to [Designing Your Collection Procedures](#) for more information about how to have different collection criteria for different debt classes.

The type of severance process associated with a deposit SA is probably rather simple - you probably will want a To Do entry generated to advise an operator that a customer hasn't paid their deposit.

FASTPATH:

Refer to [The Lifecycle Of A Severance Process And Its Events](#) for more information.

Please see [Deposit Seizures When Other SAs Are Stopped](#) for a description of how the system seizes an active deposit service agreement when normal (i.e., non-cash deposit) service agreements are stopped.

After a deposit SA is stopped, it will be "final billed" the next time the account is billed. Refer to [Refunding Deposits](#) for more information about how deposit refunds are "final billed". If a credit balance remains on the deposit SA after it is final billed, the [Write-Off Monitor](#) will process the deposit SA just like it processes all unpaid and final billed service agreements. If you set up the deposit SA's [write-off controls](#) properly (i.e., you plug in the appropriate refund and write-down algorithms), the write-off monitor will refund / write-down the credit balance (thus causing the deposit SA to close).

Deposit Seizures When Other SAs Are Stopped

Consider the situation when a severance process cuts a service due to non-payment. At some point, if the customer doesn't pay, you'll want to seize the deposit and apply it to the overdue debt. To implement this, the system simply stops the deposit SA when it stops the last SA in its deposit class (refer to [Finalizing Pending Stops](#) for more information about stopping service agreements). Then, when the account is next billed, the standard deposit refund process will offset outstanding debt before it is refunded to a customer.

Refer to [Refunding Deposits](#) for a complete description of how the system refunds a stopped deposit SA's balance to other service agreements in its deposit class.

NOTE:

Deposit class refund method is the key. It's important to stress that the only way the system will use a deposit to offset overdue debt is if the deposit's deposit class has a refund method that does this. If you've set up a deposit class' refund method to cut a check for the entire deposit amount, the system will not offset outstanding debt. Refer to [Deposit Class - Refund Method](#) for more information.

Non-Cash Deposits

When an account is required to post a deposit, they can remit cash or some other type of surety (e.g., letters of credit, surety bonds, 3 rd party deposits). When cash is remitted, a deposit service agreement is used. When some other type of surety is used, a *non-cash deposit* must be created.

Non-cash deposits are held in respect of an account and an account may have an unlimited number of non-cash deposits (note: cash deposits are held in respect of a deposit service agreement that is linked to remitting account). Refer to [Account - Deposits](#) for more information.

Each non-cash deposit must reference a non-cash deposit type. Besides defining the type of surety, the non-cash deposit type also controls:

- Whether such types of non-cash deposits can be highlighted when they are due to expire via the creation of a To Do entry (refer to TD-NCDEX for more information about this To Do entry).
- Whether a reference to a cash-deposit (i.e., service agreement) must be specified. Refer to [3rd Party Deposits](#) for more information about how a cash deposit can be referenced by another party.

FASTPATH:

Refer to [Setting Up Non-Cash Deposit Types](#) for more information.

In addition to non-cash deposit type, each non-cash deposit must reference a deposit class. Why? Because the system amalgamates cash and non-cash deposits when it determines if an account is holding an adequate deposit.

FASTPATH:

Refer to [What Do Deposit Classes Do?](#) for more information.

If you need to use a non-cash deposit to satisfy an account's debt, you must "cash in" the non-cash deposit. When the cash arrives, create a payment and apply it to the customer's outstanding service agreements.

Third Party Deposits

A third party deposit arises when a third party remits cash to cover the deposit needs of one or more accounts. Both cash and non-cash deposits must be created to record a third party deposit. The following example will explain how to do this.

Assume the Salvation Army remits \$5,000 on behalf of 50 customers (where each customer's account is allocated \$100). In this situation, you'd create the following information in the system:

- The Salvation Army must have an account with a deposit service agreement.
- When the Salvation Army remits the funds:

WARNING:

If you do not understand the difference between payoff balance and current balance, refer to [Current Amount versus Payoff Amount](#).

- Create an adjustment to "bill" the deposit service agreement (causing the deposit SA's current balance to be \$5,000 and the payoff balance to be 0).
 - Add a payment for the \$5,000 against the Salvation Army's account. This payment will cause the deposit SA's current balance to be 0 and the payoff balance to be -\$5,000. Note, if you don't mind the Salvation Army's current balance to be -\$5,000 after the payment is made, you wouldn't have to create the adjustment to "bill" the deposit.
 - Create a non-cash deposit for each of the 50 accounts being covered by the cash deposit. On each non-cash deposit, define the appropriate non-cash deposit type (e.g., 3rd party deposit) and amount \$100 each.
 - Interest will be applied to the Salvation Army's deposit service agreement as per the interest algorithm on the deposit SA's deposit class.
 - If you need to use the Salvation Army's payment to payoff overdue debt, you will use a transfer adjustment(s) to transfer from the deposit service agreement to the respective overdue service agreement(s).
-

IMPORTANT:

Be aware that the system will allow the sum of third party deposits to exceed the amount of the cash deposit (in our previous example, the system would allow you to create \$6,000 worth of third party non-cash deposits even though only \$5,000 of cash was remitted).

Deposit Class Controls Everything

A deposit service agreement's SA type references a deposit class. The topics in this section describe how deposit class controls the behavior of a deposit SA.

FASTPATH:

Refer to [Setting Up Deposit Classes](#) for a complete description of the business rules governed by a deposit class.

Controls Interest Calculation

Interest is applied to a deposit SA when:

- A deposit SA is stopped. Refer to [Refunding Deposits](#) for a description of how a deposit SA can be stopped.
 - The Apply Interest background process (DEPINTRF) determined that sufficient time has passed since interest was last calculated. The amount of time between interest calculations is defined on the deposit class. A deposit SA's deposit class controls the following interest calculation functions:
 - The frequency of interest calculation.
 - The algorithm used to calculate the amount of interest (note, the interest rate is defined using a bill factor plugged in on this algorithm).
 - The method used to refund the interest.
-

NOTE:

Adjustments are used to apply interest. Interest is applied to a deposit SA using an adjustment (the adjustment type is also defined on the deposit class).

Controls The Recommended Deposit Amount

The following events cause the calculation of the recommended deposit amount:

- The Deposit Review background process (DEPRVW) compares an account's existing deposit (if any) to the recommended amount.
- A user requests a deposit calculation for a new deposit service agreement by pressing the  button on the [Start Confirmation](#).

A deposit service agreement's deposit class controls the algorithm used to derive the suggested deposit amount.

Defines The Conditions That Cause The System To Recommend A New or Additional Deposit

The Deposit Review background process (DEPRVW) will recommend an additional deposit be billed if the customer doesn't satisfy the definition of a *good customer*.

It's important to be aware that if your company has multiple classes of deposits, the system will recommend deposits for each individual deposit class used by an account. For example, if an account has both regulated and unregulated deposit classes, the system will recommend separate deposits for each class.

When the Deposit Review process analyzes an account's debt, it uses the following deposit class attributes:

- The definition of a good customer (the system only recommends deposits for bad customers).
- The tolerance percent that must be exceeded before the system will recommend an additional deposit for a customer. This tolerance percent prevents the recommendation of small amounts.
- The method used to derive the recommended deposit amount.

Assuming the C1-CR-UP-DRR review method algorithm is specified on the deposit class, the system does not automatically produce bills when an additional deposit is needed. Rather, the system's recommendations appear on the [Deposit Review](#) page. To implement a recommendation, an operator should change the deposit SA's [Total Amount To Bill](#) or add a new deposit SA.

NOTE:

Non-cash deposits are included. It's important to be aware that the system compares the recommended deposit amount against the sum of deposits on hand for a given deposit class. When amalgamating the total deposit on hand, the system includes both cash (i.e., deposit SA's payoff balance) and non-cash deposits.

Defines Automatic Refund Conditions

The Deposit Refund background process (DEPRFND) will refund a deposit to a customer when conditions defined on the deposit SA's deposit class are met. For example, a deposit's deposit class may indicate the system should automatically refund a deposit after the deposit has been held for 6 months and the customer is a good customer (the definition of a "good customer" is also on the deposit class).

Controls How Deposits Are Refunded To A Customer

The method used to refund a deposit to a customer is defined on the deposit SA's deposit class. For example, a deposit's deposit class may indicate the system will first apply the deposit to outstanding debt first and, if funds remain, cut a check.

It's important to be aware that if your company refunds deposits by first offsetting outstanding debt, the system will only offset debt within an individual deposit class. For example, if a customer has two deposits - one for regulated debt, the other for unregulated debt - the regulated deposit will only be used to offset regulated debt.

Deposit Background Processes

The topics in this section describe the background processes that automate deposit processing.

Deposit Interest

The Deposit Interest background process (DEPINTRF) examines all cash deposit service agreements (i.e., service agreements with a SA type with a special role of Cash Deposit). If enough time has passed since interest was last calculated, interest will be calculated using the service agreement's deposit class' Interest Refund Algorithm. Note: interest will be automatically calculated every X months where X is defined in the deposit class' Months Between Interest Refund.

Deposit Refund

The Deposit Refund background process (DEPRFND) examines all cash deposit service agreements (i.e., service agreements with a SA type with a special role of Cash Deposit). If the account meets the service agreement's deposit class' Refund Criteria Algorithm, the system changes the service agreement's state to Pending Stop. Refer to [Refunding Deposits](#) for a description of what happens next.

Review Deposits

The Review Deposits background process (DEPRVW) examines all accounts with service agreements that are governed by a deposit class (i.e., service agreements with an SA type that references a deposit class). If the account fails the deposit class' Good Customer Algorithm, the system calculates the recommended deposit amount (using the deposit class' Deposit Recommendation Algorithm). If the recommended amount exceeds the amount of deposit currently requested, the system will request an additional deposit. The deposit class' **Review Method Algorithm** is used to determine what action to take if the system requests an additional deposit. The system's recommendations appear on the [Deposit Review](#) page.

You may optionally provide a Deposit Class as input to restrict the review to account whose service agreements reference that deposit class.

NOTE:

Preventing small recommendations. The system uses the deposit class's Review Tolerance Percentage to prevent the recommendation of small deposits by the Deposit Review background process. For example, if this field contains 10(%), the system would only recommend an additional deposit if the existing requested deposit amount is less than 90% of the recommended amount.

Multiple deposits could be recommended for an account. Because an account can have service agreements that belong to multiple deposit classes, it is possible for a multiple recommendations to be generated for an account.

Deposit Review

The Deposit Review page shows all accounts for which an additional deposit is recommended.

NOTE:

The [Review Deposits](#) background process inserts rows on this query.

Multiple deposits could be recommended for an account. Because an account can have service agreements that belong to multiple deposit classes, it is possible for a multiple recommendations to be generated for an account.

Open this page using **Menu > Financial Query > Deposit Review.**

Description of Page

Use **Account ID** and / or **Deposit Class** to filter the rows. Each row displays an account / deposit class that holds an inadequate deposit.

NOTE:

Rows are also displayed for errors. Please be aware that if the Recommend Additional Deposit background process encounters an error when it attempts to calculate an account's recommended deposit, these errors also appear as rows in this query.

Press the  button to add a new deposit SA for the customer. Pressing this button causes [Start/Stop Service](#) to open. When this page opens, you should create a new deposit service agreement for the customer (by referencing the appropriate division / SA Type).

If the customer has one or more deposit service agreements, the drill button will be enabled. Pressing it will cause the [Service Agreement - Main Information](#) page to open. When this page opens, you can change Total Amount To Bill to reflect the total amount of deposit you want to hold. When billing next runs, it will bill the customer for the marginal difference between the current deposit held and the deposit amount to bill.

FASTPATH:

Refer to [Defines The Conditions That Cause The System To Recommend A New or Additional Deposit](#) for how rows are added to this query.

Statements

In this section, we describe how to manage your customer's statements.

The Big Picture of Complex Statements

Statements allow you to set up a person to receive a consolidated report of the financial activity for one or more accounts and/or service agreements. This allows you to model complex account scenarios, including the following examples.

- Satellite offices for a company are each responsible for paying their own bill, but the head office would like a consolidated report of the bills for all the satellite offices once a month. In this case, each satellite office is set up as an

account covering the services for their office. The head office does not want to receive individual copies of each bill, but rather a consolidated report of the financial activity for all the offices.

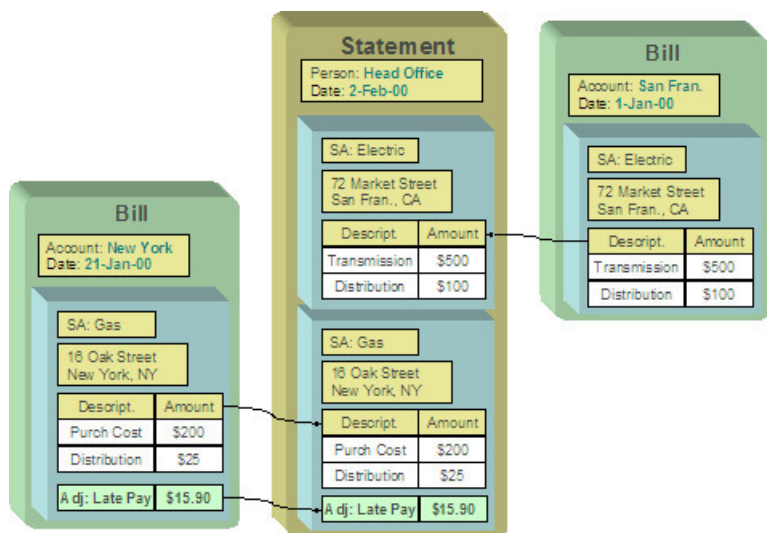

- The head office is responsible for paying the bill. The satellite offices should receive a copy of only their portion of the bill. In this case, a service agreement is set up for each satellite office under the head office's account. Each satellite office should receive a copy of the bill segment information for their office's service agreement.

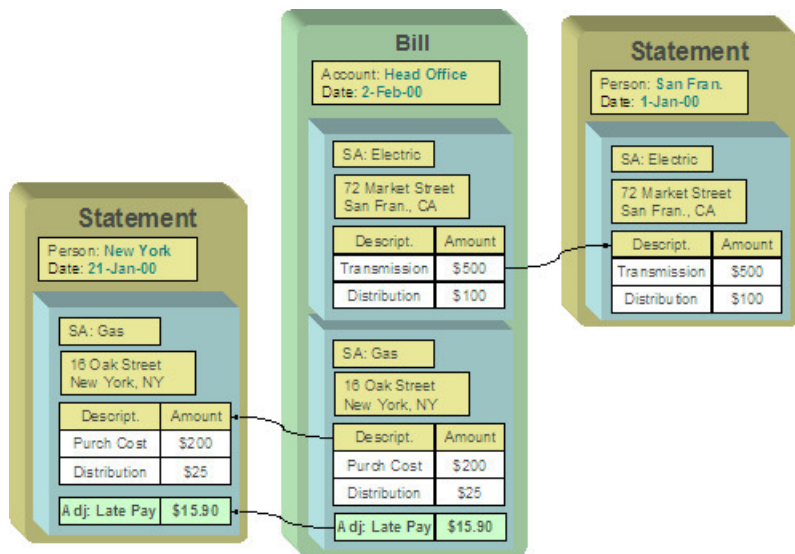

- The head office is responsible for paying the bill. Multiple departments need to see copies of the electric portion of the bill. As illustrated by this scenario, a service agreement or account may appear on many statements.

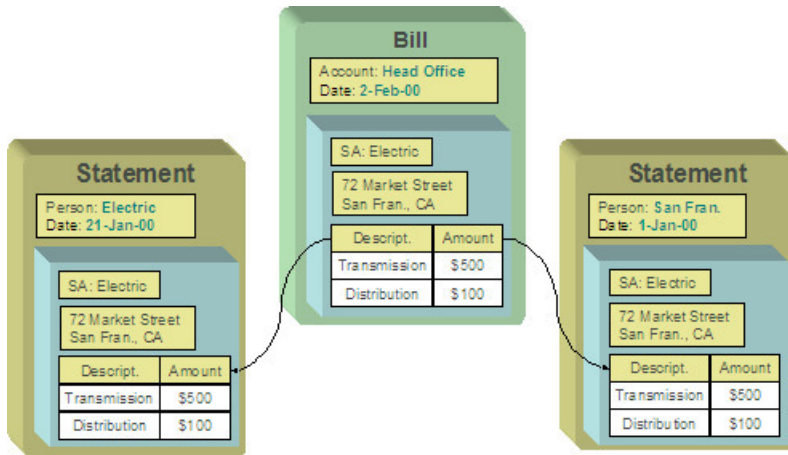

The topics in this section provide additional information about how to set up statements.

Constructing Statements

Statements are produced for a [person](#). Each statement contains the financial transactions for one or more [service agreements](#). The service agreements may belong to any number of [accounts](#). Over time, a person may receive many statements.

When setting up a person to receive statements, it's important to note that a person can receive different statements for different groupings of service agreements. For example, the head office may want a statement of the financial details for the western division offices separately from the eastern division offices.

For each separate statement a person wishes to receive, you will set up a statement construct. On the statement construct, you define the service agreements and/or accounts whose financial information should appear on the statement. If you specify an account on a statement construct, billing information for all the service agreements linked to the account will be included on the statement. The superset of service agreements and accounts defined on a statement construct are called the "construct details".

FASTPATH:

Refer to [Statement Construct Maintenance](#) for more information.

Producing Statements

Statement Cycles

The accounts and service agreements linked to a statement construct may have different bill cycles and as a result, their bills are produced on different dates. So when should a statement containing the consolidation of all this financial information be produced? To answer this question, there is a statement cycle.

Just as with a bill cycle, the statement cycle has a schedule. A statement cycle's schedule controls when a statement should be produced. Each statement construct will point to its own statement cycle.

FASTPATH:

Refer to [Statement Construct Maintenance](#) and [Statement Cycle](#) for more information.

Create Statements Background Process

This statement construction background process (STMPRD) is responsible for periodically creating statements. It works as follows:

- All statement cycles are selected with pending schedules whose production date is on or before the business date.
- For each such cycle, all of its statement constructs are selected. For each statement construct:
 - If a statement already exists for the cycle schedule and construct, it is deleted (this allows for reproduction after a mess up). Note well, this is true even if the statement is printed as you may have only spotted the problem after viewing the printed statement.
 - A statement is created.
 - All SAs associated with the construct details effective on the business date are extracted.
 - All "SA snapshots" associated with bills whose BILL DATE is within the construct detail's start and end dates that are not already linked to one of the construct's statements are linked to the new statement. Note, an "SA snapshot" is created for every service agreement linked to an account when a bill is completed for an account.
 - If no "SA snapshots" are found, the statement is removed.

NOTE:

The following diagram illustrates how the above logic could result in multiple bills for a single service agreement being linked to the same statement.

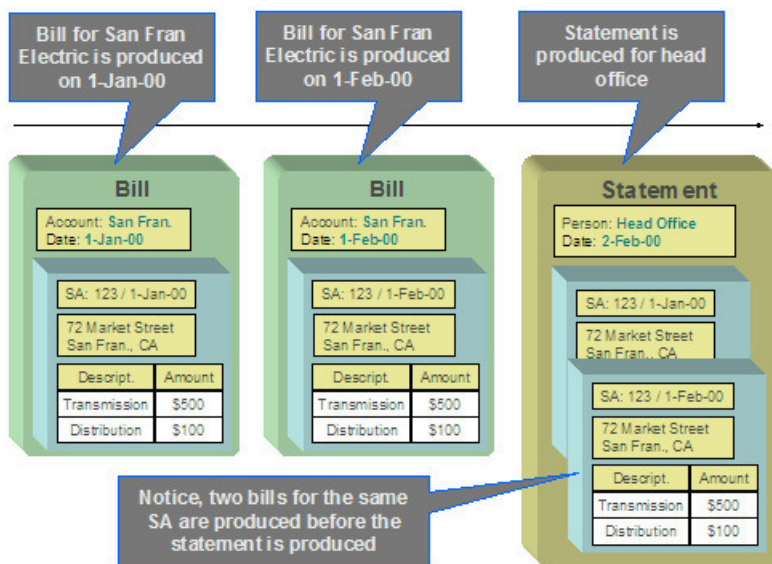

FASTPATH:

Refer to [Statement Maintenance](#) for more information about a statement and its details.

NOTE:

This process is rerunnable. If a problem occurred during the statement creation, simply run the background process again. It will clean up all existing statements for each construct in the current cycle schedule and start again.

FASTPATH:

Refer to [Printing Statements](#) for more information for how a separate background process uses the information snapshot on a statement to construct the extract file used to print the statements.

Statement Routing

Just as with bills, statements require routing information in order for the system to understand how and where to send the statements. For example, the system needs to know the method of routing, the number of copies and the format of the statement. This information is captured on a statement construct.

Where Are Statements Sent

The system extracts a statement's address as per its statement construct's address source. Note, if the address source is Person and the person has a [seasonal address](#) effective on the business date, the seasonal address will be used.

If you need to reprint a statement because it was addressed incorrectly, correct the person's address, and then reprint the statement (by pressing the **Reprint** button on the statement). When you press this button, the statement will be marked for downloading. When your download process next runs, it simply extracts the statement construct's current address.

On-Line Statement Production

Statements may be produced on-line as well as in batch. To produce a statement on-line, simply go to the Statement page, select the correct Construct ID and choose the Generate button.

This statement will include the financial information related to bills for the accounts and service agreements linked to this construct, with the following criteria:

- The bills do not already appear on a statement
- The bill dates fall within the "effective period" for the statement construct. In other words, the bill falls within the start and end period for the statement construct details.

FASTPATH:

Refer to [Statement Maintenance](#) for more information.

How to Regenerate a Specific Statement

There may be times when a specific statement needs to be regenerated. For example, perhaps a cancel / rebill has occurred since the statement was produced, and you wish to recreate the statement to reflect this.

If you need to regenerate a statement using up-to-date information, simply delete the statement and generate a new statement. This may be done on-line.

NOTE:

Statements may be deleted, even if they have already been printed. This enables you to delete and regenerate statements.

FASTPATH:

Refer to [Statement Maintenance](#) for more information.

Printing Statements

The contents of this section describe the technical implementation of printing statements.

Statement Route Types Control The Information Merged Onto Statements

Every statement references a [statement route type](#). The route type controls the following statement print functions:

- It contains an algorithm that is responsible for extracting the information merged onto your statements. Specifically, algorithms of this type create the "flat file records" that are passed to your statement print software. Algorithms of this type are called under the following scenarios:
 - The background process that builds the flat file that's passed to your statement print software calls these algorithms to construct the "flat file records" for each statement.
 - If your statement print software has the ability to construct a real-time image of a statement (in a PDF), you can plug-in an Online Statement Image algorithm on the [Installation Record](#). This type of algorithm will call the statement's dispatch group extract algorithm to extract the information that is merged onto the statement. Refer to [Technical Implementation Of Online Statement Display](#) for the details.
- Refer to [The Statement Extract Records](#) for examples of the record layouts passed to the document composition application.
- It contains the ID of the background process that builds the flat file that's passed to your statement print software. The base package example of this process ([STMDWLD](#)) simply calls each statement's construct's route type's extract algorithm to format the information placed onto the flat file.

Technical Implementation Of Online Statement Display

Users can view an image of any statement if you setup the following:

- Plug-in an Online Statement Display algorithm on the [Installation Record](#). Refer to ONSD-ST for an example of such an algorithm. Note, if your statement print software is not capable of producing a PDF containing an image of a statement, users will not be able to view images of statements.
- Plug-in the appropriate extract algorithm on each [statement route type](#). Algorithms of this type format the records that contain the information that is passed to your printing software. Refer to STEX-TX for an example of such an algorithm.

When you plug-in these algorithms, a button appears on [Statement - Main](#). When a user presses this button, the following takes place:

- The installation record's Online Statement Display algorithm is executed.
- This algorithm calls the statement's route type's extract algorithm. This algorithm constructs the information that's merged onto the statement and returns it to the Online Statement Display algorithm. This algorithm, in turn, passes it to your statement print software.

- Your statement print software renders an image of the statement in a PDF and returns it to the Online Statement Display algorithm.
- And finally, the Online Statement Display algorithm displays the PDF in a separate Adobe session.

Technical Implementation Of Printing Statements In Batch

The background process that extracts statement information ([STMDWLD](#)) reads all statements in a given run number that are marked with its batch control ID. For each statement, it creates numerous records on a flat file. These records contain the information that is merged onto your statements.

The base package example of this process ([STMDWLD](#)) simply calls the extract algorithm on the statement route type to format the information placed onto the flat file. Refer to [Statement Route Types Control The Information On Statements](#) for more information.

NOTE:

If your software doesn't support online statement display. The algorithm that formats statement extract records that's plugged in on [statement route type](#) serves two purposes: 1) it formats the records used to construct online images of a statement, and 2) it formats the records downloaded to your statement print software in batch. If your statement print software does not support the rendering of statement images real time, there is no need to create an extract algorithm. Rather, you should simply develop your own download process that both formats the extract records and downloads them (and then specify this batch process on your statement route type).

Reproducing The Statement Print Flat File

You can reproduce the flat file at any time. Simply request the [STMDWLD](#) process and specify the run number associated with the historic run.

How To Reprint A Specific Statement

If you need to reprint a specific statement, navigate to [Statement - Main](#) and press the **Reprint** button.

If your implementation has [enabled the online creation of statement images](#), you can also press the **Display Statement** button on this page and then print the resultant PDF on your local printer.

The Statement Extract Records

Numerous different types of records are interfaced to the document composition application. However, they all share a common structure:

- The first 4 bytes are called the **Printer Key**. This field is a record type used by the document composition application statement template.
- The next 186 bytes are called the **Sort Key**. This field is used to ensure the various records used to construct a printed statement appear in the correct order in the interface file.
- The next 12 bytes are called the **Mailing Key**. This field is used to control the order in which the formatted statements are printed.
- The remaining bytes contain the **StatementInformation** that appears on the printed statement. The type of information differs for each type of record.

The topics in this section describe each component.

Printer Keys (Record Types)

The following table defines each printer key (i.e., record type) on the statement print flat file.

Record Type	Description	Notes
0010	Global extract information	Required. 1 per flat file.
0100	Statement record	Required. 1 per statement.
0120	Total by currency record	Required. At least one per statement.
0500	Construct detail record	Required. At least one per construct detail linked to the statement construct.
0900	Service agreement record	1 per SA
1100	Bill record	1 per bill
1300	Financial Transaction (FT) record	1 per FT linked to the SA.
3600	End of record type 1100	1 for each bill
3700	End of record type 0900	1 for each SA
5000	End of record type 0500	1 for each statement construct detail
9999	End of record type 0100	1 for each Statement

Sort Key

The following table defines the structure of the sort key that appears on each statement print record. Please note that different components are filled in for each printer key.

Field Name	Format	Record Type	Source/Value/Description
Statement ID	A12	All	Prime key of the statement
Sequence Number	N2	All	Set to "1"
Copy Number	N2	All	Defaulted to "1" on the first copy, set to "1" when a statement is requested on-line
Statement record group	A2	0010	Blank
		0100	10
		0120	20
		0500, 0900, 1100, 1300, 3600, 3700, 5000	30
		9999	60
Construct detail sort sequence 1	N3	0010, 0100, 0120, 9999	blank
		0500, 0900, 1100, 1300, 3600, 3700, 5000	Statement construct's PRT_SEQ
Construct detail sort sequence 2	A10	0010, 0100, 0120, 9999	blank

		0500, 0900, 1100, 1300, 3600, 3700, 5000	Statement construct's STM_CNST_DTL_ID
Premise Indicator	A1	0010, 0100, 0120, 0500, 9999	Blank
		5000	'Z'
		0900, 1100, 1300, 3600, 3700	For a non-premise, this will be 'N' otherwise 'Y'
Premise State	A6	0010, 0100, 0120, 0500, 5000, 9999	Blank
		0900, 1100, 1300, 3600, 3700	Premise's state (if this is for a non-premise, this will be blank)
Premise City	A90	0010, 0100, 0120, 0500, 5000, 9999	Blank
		0900, 1100, 1300, 3600, 3700,	Premise's city (if this is for a non-premise, this will be blank)
Premise Address 1	A58	0010, 0100, 0120, 0500, 5000, 9999	Blank
		0900, 1100, 1300, 3600, 3700	Premise's address line 1 (if this is for a non-premise, this will be blank)
Premise Id	A10	0010, 0100, 0120, 0500, 5000, 9999	Blank
		0900, 1100, 1300, 3600, 3700	Premise's ID (if this is for a non-premise, this will be blank)
SA Print Priority	A2	0010, 0100, 0120, 0500, 5000, 9999	Blank
		0900, 1100, 1300, 3600, 3700	The SA's SA type's print priority
SA Id	A10	0010, 0100, 0120, 0500, 5000, 9999	Blank
		0900, 1100, 1300, 3600, 3700	The SA's SA ID
SA record group	A2	0010, 0100, 0120, 0500, 5000, 9999	Blank
		0900	10
		1100, 1300, 3600	20
		3700	30
Bill Date	A10	0010, 0100, 0120, 0500, 0900, 3700, 5000, 9999	Blank
		1100, 1300, 3600	Bill's bill date in the format YYYYMMDD.
Bill Id	A12	0010, 0100, 0120, 0500, 0900, 3700, 5000, 9999	Blank
		1100, 1300, 3600	Bill's bill id
Bill record group	A2	0010, 0100, 0120, 0500, 0900, 3700, 5000, 9999	Blank
		1100	10

		1300	20
		3600	30
Arrears Date	A10	0010, 0100, 0120, 0500, 0900, 1100, 3600, 3700, 5000, 9999	Blank
		1300	Financial transaction arrears date
FT Type	A2	0010, 0100, 0120, 0500, 0900, 1100, 3600, 3700, 5000, 9999	Blank
		1300	Financial transaction type

Mailing Key

The following table defines the structure of the mailing key that appears on each statement print record.

Field Name	Format	Source/Value/Description
Postal code	A12	This is the postal code on address associated with the statement.

Statement Information

The topics in this section describe the information that appears on each on each statement print record. The following links are provided so that you can move easily to specific topic within this section:

- [Global Extract Information Record \(0010\)](#)
- [Statement Record \(0100\)](#)
- [Total By Currency Record \(0120\)](#)
- [Statement Construct Detail Record \(0500\)](#)
- [Service Agreement Record \(0900\)](#)
- [Bill Record \(1100\)](#)
- [Financial Transaction \(FT\) Record \(1300\)](#)
- [End Bill Record \(3600\)](#)
- [End Service Agreement Record \(3700\)](#)
- [End Statement Construct Detail Record \(5000\)](#)
- [End Statement Record \(9999\)](#)
- [Address Sub-record](#)

Global Extract Information Record (0010)

Field Name	Format	Source/Value/Description
BATCH_CD	A8	Batch Control Code of the extract process.
BATCH_NBR	N10	Batch Number of the extract process
BATCH_RERUN_NBR	N10	Batch Rerun number of the extract process.

STATEMENT_CNT	N10	Count of statements on this extract. Multiple copies of a statement are counted multiple as well.
EXTRACT_DTTM	A31	System time of extraction. Formatted according to user profile.
STMT_ID_START	A12	This is only used when a statement is produced as a result of an online request (from Statement - Main). It contains the Statement Id to extract.
STMT_ID_END	A12	This is only used when a statement is produced as a result of an online request (from Statement - Main). It contains the Statement Id to extract.
THREAD_NBR	N10	This field is only used if statements are extracted in batch. It contains the thread number in which the statement was extracted.
THREAD_CNT	N10	This field is only used if statements are extracted in batch. It contains the total number of threads that were extracted.
STATEMENT_IND	A1	Defaulted to "Y"

[Top of Page](#)

Statement Record (0100)

Field Name	Format	Source/Value/Description
STMT_ID	A12	CI_STM
PER_ID	A10	CI_STM_CNST
STMT_DT	A31	STM_DT from CI_STM. Formatted according to user profile.
COPY_NBR	N1	"1"
NBR_STMT_COPIES	N1	"1"
ENTITY_NAME	A64	Main name of CI_PER (from CI_PER_NAME).
ADDRESS_SBR	A361	Address where the statement should be sent (the address is defined on the statement's statement construct).
ENTITY_NAME1	A64	CI_PER
ENTITY_NAME2	A64	CI_PER
ENTITY_NAME3	A64	CI_PER
DESCR50	A50	CI_STM_CNST

[Top of Page](#)

Total By Currency Record (0120)

One total record will be created for each currency code associated with the FT's associated with the SA snapshots linked to the statement.

Field Name	Format	Source/Value/Description
------------	--------	--------------------------

CURRENCY_CD	A3	This is the currency code associated with the summary information.
CUR_BAL	A30	This is the sum of CUR_AMT snapshot on the SA snapshots (CI_BILL_SA) linked to the statement. SA snapshots (CI_BILL_SAs) are referenced on CI_STM_DTL.
BILL_AMT	A30	This is the sum of CUR_AMT from CI_FT's classified as "corrections" and "current charges" on bill's associated with the statement. Please note, only those FT's associated with SAs linked to the statement will be amalgamated. This is formatted according to user's display profile.
CUR_ADJ_AMT	A30	This is the sum of CUR_AMT from CI_FT's classified as "adjustments" on bills associated with the statement. Please note, only those FT's associated with SAs linked to the statement will be amalgamated. This is formatted according to user's display profile.
CUR_PAY_AMT	A30	This is the sum of CUR_AMT from CI_FT's classified as "payments" on bills associated with the statement. Please note, only those FT's associated with SAs linked to the statement will be amalgamated. This is formatted according to user's display profile.

[Top of Page](#)

Statement Construct Detail Record (0500)

Field Name	Format	Source/Value/Description
STM_CNST_ID	A12	CI_STM_DTL
SA / Account Indicator	A1	A switch to indicate if the statement construct is for a service agreement or an account. 'S' for service agreement, 'A' for account.
Unique ID	A10	The unique identifier of the account or service agreement
SA / Account Info	A160	Contains the standard information about the account or service agreement
STMT_PRT_DESCR	A50	CI_STM_CNST

[Top of Page](#)

Service Agreement Record (0900)

Field Name	Format	Source/Value/Description
SA_ID	A10	CI_SA
Address Information	A120	This is the standard format of a premise address that is displayed throughout the system.

SA Information	A120	This is the standard SA information that is displayed throughout the system
SVC_TYPE_CD	A30	CI_SA_TYPE

[Top of Page](#)

Bill Record (1100)

Field Name	Format	Source/Value/Description
BILL_ID	A12	
Completion Date	A31	Date formatted according to user profile.
Due Date	A31	Date formatted according to user profile.
SA Ending Balance	A30	
FT Exist Indicator	A1	

[Top of Page](#)

Financial Transaction (FT) Record (1300)

Field Name	Format	Source/Value/Description
FT_ID	A12	CI_FT
ARS_DT	A31	CI_FT (The date when the transaction starts aging). Date formatted according to user profile.
AMOUNT	A30	CUR_AMT from CI_FT formatted according to user display profile.
FT_DESCR	A120	Formatted FT information.

[Top of Page](#)

End Bill Record (3600)

Field Name	Format	Source/Value/Description
Dummy field		

[Top of Page](#)

End Service Agreement Record (3700)

Field Name	Format	Source/Value/Description
Dummy field		

[Top of Page](#)

End Statement Construct Detail Record (5000)

Field Name	Format	Source/Value/Description
Dummy field		

[Top of Page](#)

End Statement Record (9999)

Field Name	Format	Source/Value/Description
Dummy field		

[Top of Page](#)

Address Sub-record

The address sub-record that in statement record (0100) is composed of the following:

Field Name	Format	Description
COUNTRY	A3	
ADDRESS1	A64	
ADDRESS2	A64	
ADDRESS3	A64	
ADDRESS4	A64	
CITY	A30	
NUM1	A6	
NUM2	A4	
HOUSE_TYPE	A2	
COUNTY	A30	
STATE	A6	
POSTAL	A12	
GEO_CODE	A11	
IN_CITY_LIMIT	A1	

Statement Construct Maintenance

The statement construct enables you to indicate the collection of accounts and/or service agreements whose financial details should be consolidated for a statement to a given person. The statement construct also contains routing information needed by the system to send the statement to the person in the preferred manner.

Lifecycle of a Statement Construct

The following diagram illustrates the lifecycle of a statement construct.

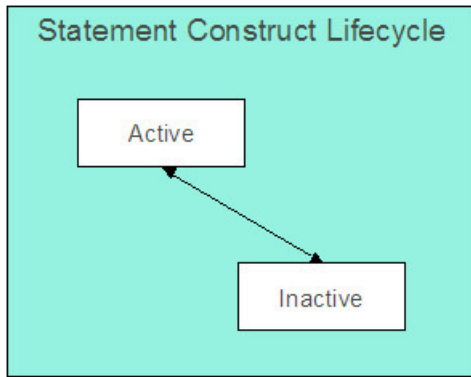

Active: The statement construct will be in this status while a person is actively receiving statements for the accounts and service agreements linked to this construct. A statement construct may transition from this status to inactive.

Inactive: The statement construct will be in this status when a person no longer wishes to receive statements for the accounts and service agreements linked to this construct. A statement construct may transition from this status back to active.

Statement Construct - Main

Open this page using **Menu > Customer Information > Statement Construct > Search.**

Description of Page

Statement Construct is a concatenation of summary information about this record. It is composed of the name of the statement person, the print description and the status.

Statement Construct ID is the unique system-generated identifier for this statement construct.

Person ID is the person who receives the future statements.

NOTE:

A person may be linked to many statement construct records.

Status indicates whether or not this person is currently receiving statements. The values are Active and Inactive.

FASTPATH:

Refer to [Lifecycle of a Statement Construct](#) for more information.

Address Source indicates where the source of the statement's address. The values are Person and Mailing Premise. If the value is person, the person's [mailing address](#) is used. If the value is mailing premise, indicate the **Mailing Premise** to use.

Statement Cycle controls when statements are produced for this statement construct. Refer to [Statement Cycle](#) for a description of how the production schedule is maintained.

Statement Route Type controls how the statement is routed to the **Person** (e.g., via email, postal service, EDI, etc.). Refer to [Statement Route Type](#) for more information on setting up statement route types.

Number of Copies indicates how many copies of the statement the person wishes to receive.

Statement Format indicates if the person receives a Detailed or a Summary statement.

NOTE:

The values for this field are customizable using the Lookup table. The values need to match the formats supported by your statement print software. This field name is STM_FORMAT_FLG.

Print Description is a brief description that can be printed on the statement.

The tree shows the statement construct's details. The nodes expand to show account, premise and service agreement information for the construct details.

NOTE:

Large statement constructs. The tree is hard to use if the statement construct has many details. In this situation, transfer to the adjacent tab page and use the filter to restrict the details that are shown.

Statement Construct - Details

This page is used to maintain the accounts and service agreements where financial transactions should appear on statements produced using this statement construct. Open this page using **Menu > Customer Information > Statement Construct > Search** and navigate to the **Details** page.

Description of Page

Statement Construct is a concatenation of summary information about this record. It is composed of the name of the statement person, the print description and the status.

Statement Construct ID is the unique system-generated identifier for this statement construct.

If a statement construct has a large number of details, you can use the **Details Filter** to limit the details that appear in the grid. The following options are available:

- All. Use this option to view all details linked to the statement construct.
- Person Name. Use this option to restrict details linked to accounts whose main customer has a primary name that matches an input **Name**.
- SAs at an Address. Use this option to only show details linked to service agreements that are linked to service points associated with a given **Address, City** and/or **Postal** code. Note, you can specify any combination of these fields.
- Statement Print Description. Use this option to restrict details to those with a given **Description**.

Don't forget to click the search button after changing the filter.

The grid contains the Accounts and/or Service Agreements whose financial information contributes to this statement construct. Each record in the grid contains the following information:

- **Construct Detail Type** defines if the construct detail is for an entire Account or a single Service Agreement. This field is protected if a statement detail was produced using this construct.
- **Service Agreement/Account** identifies the account (for Account construct details) or the service agreement (for Service Agreement) construct details. This field is protected if a statement detail was produced using this construct.
- **Statement Print Description** is available for use by the extract program to include on the printed statements to help the recipient identify the details.
- **Print Order** control where the financial transactions associated with the account / service agreement appear on the printed statement.
- **Start Date** is the date that this account / service agreement's financial transactions should begin appearing on statements.
- **End Date** is the date that this account / service agreement's financial transactions should stop appearing on statements.

NOTE:

Only financial transactions linked to bills whose BILL DATE is within the construct detail's **Start Date** and **End Dates** will appear on statements.

- **Construct Detail ID** is a system generated unique identifier of the construct detail.

Statement Maintenance

Statements allow you to set up a Person to receive a consolidated report of the financial activity for one or more accounts and/or service agreements. The topics in this section describe how to maintain statements.

NOTE:

The system creates most statements behind-the-scenes. Most statements are created by the system when it processes the statement cycle schedule. You should only have to access the statement pages to regenerate a statement or to add a statement real-time. For information about how the system creates statements, refer to [The Statement Creation Background Process](#).

Lifecycle of a Statement

The following diagram illustrates the lifecycle of a statement.

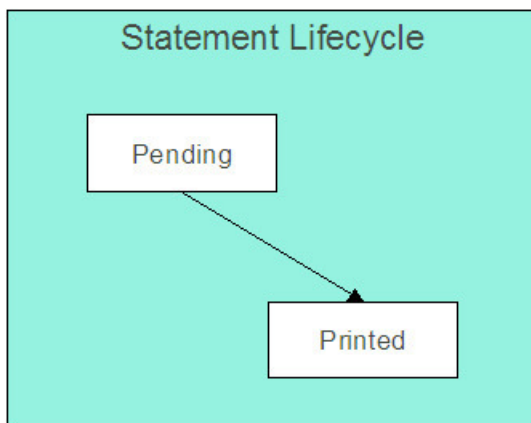

Pending: A statement is created in this state and will remain in this state until the statement details are extracted. When that occurs, it will transition to printed.

Printed: A statement transitions to this state after the details of a statement have been extracted.

Statement - Main

Open this page using **Menu > Financial > Statement > Search**.

NOTE:

Correcting erroneous statements. It's important to be aware that there are very few fields that are directly modifiable by a user. This is because a statement is a summary of financial transactions. If you need to change information on a

statement, you must change the source information (e.g., change the statement's construct or complete additional bills) and then regenerate the statement. Refer to [How To Regenerate A Statement](#) for more information.

Description of Page

Statement is a concatenation of summary information about this record. It is composed of the name of the statement person, the statement construct print description, the create date of the statement and the statement status.

Statement ID is the unique system-generated identifier for this statement.

Indicate the **Construct ID** for the statement construct whose construct details should be included in this statement.

Address is a display-only field that contains the address to which the statement will be sent.

The **Statement Status** indicates the current status of the statement. The values are Pending, Printed.

FASTPATH:

Refer to [Lifecycle of a Statement](#) for more information.

The **Create Date** indicates the date that this statement was created.

The **Batch Control** and **Batch Number** are the batch process and run in which the statement was (or will be) sent to the recipient.

FASTPATH:

Refer to [Printing Statements](#) and to [Statement Route Type](#) for more information.

The **Statement Action** area contains buttons that you use to generate, reprint or delete a statement.

- The **Generate** button enables you to create a statement on-line. Refer to [On-line Statement Production](#) for more information.
 - The **Reprint** button will stamp the latest run number for the statement's batch control. This will enable the statement to be reprinted the next time the batch control process executes. Refer to [How to Reprint A Specific Statement](#) for more information.
 - The **Delete** button will remove the statement and its details from the database. Refer to [How to Regenerate a Specific Statement](#) for more information.
 - The **Display** button will display an online image of the statement when pressed. Refer to [Online Statement Display](#) for more information.
-

NOTE:

You can only use the **Display** button if your system has been configured to display an on-line image; otherwise, a message indicating that the service is not available will appear. This option can only be configured by your technical staff. Refer to [Technical Implementation Of Online Statement Display](#) for more information.

The bottom portion of this page is dedicated to a [tree](#) that shows the statement details. The nodes expand to show every service agreement that will appear on the statement and the financial details that will be swept onto the statement for each service agreement. You may transfer to the details of any of the nodes by selecting that node. Context menus are also available for various nodes to facilitate easy navigation to other pages.

NOTE:

Large statements. The tree will be hard to use if the statement has many service agreements that contributed financial transactions to the statement. In this situation, transfer to the adjacent tab page and use the filter to restrict the service agreements that are shown.

Statement - Details

This page is used to view the service agreements that contributed financial transactions to the statement. Open this page using **Menu > Financial > Statement > Search** and navigate to the **Details** page.

Description of Page

Statement is a concatenation of summary information about the statement. It is composed of the name of the statement person, the statement construct print description, the create date of the statement and the statement status.

Statement ID is this statement's unique system-generated identifier.

If a statement has a large number of service agreements that contributed financial transactions to the statement, you can use the **SA Filter** to limit the service agreements that appear in the grid. The following options are available:

- **All**. Use this option to view all service agreements that contributed financial transactions to the statement.
- **Person Name**. Use this option to only show service agreement linked to accounts whose main customer has a primary name that matches **Person Name**.
- **SAs at an Address**. Use this option to only show service agreements that are linked to service points associated with a given **Address**, **City** and/or **Postal** code. Note, you can specify any combination of these fields.
- **Statement Print Description**. Use this option to only show service agreements associated with a construct detail with a given **Statement Print Description**.

Don't forget to click the search button after changing the filter.

The grid contains service agreements that contributed financial transactions to the statement. If a service agreement's financial transactions appeared on multiple bills, a separate line is displayed for each bill. You can press the go to button adjacent to **Bill Due Date** to be transferred to [Financial Transactions On A Bill](#) where the individual financial transactions associated with the associated service agreement and bill can be viewed. The following information is displayed in the grid:

- **Statement Print Description** is the description of the construct detail associated with the service agreement.
- **Bill's Due Date** is the date of the bill on which the service agreement's financial transactions appear. Press the adjacent go to button to be transferred to [Financial Transactions On A Bill](#) where the individual financial transactions can be viewed.
- **Premise Information** describes the characteristic premise, if any, associated with the service agreement.
- **SA Information** describes the service agreement that contributed financial transactions to the statement.
- **Account Information** describes the account associated with the service agreement whose details appear on the statement.
- **Construct Detail ID** is the unique identifier of the construct detail associated with the service agreement.
- **Statement Detail ID** is the unique identifier of the statement detail on which the service agreement's financial transactions appear.

Sales & Marketing

The sales and marketing functionality satisfies many diverse requirements. For example, you can use this functionality to:

- Enroll new customers using a single transaction (i.e., you don't have to use the person, premise, service point, and start/stop transactions to enroll a new customer who resides at a new premise).
- Sell new products to existing customers.

- Update person, account and premise information using a single transaction.
- Market your services to prospects from a marketing list (and measure the success of your efforts). If the customer responds to your sales efforts, the system will automatically setup the customer, premise and related service agreements.
- Setup marketing surveys and record your customers' responses.
- Quickly create one-time charges.
- Setup [proposals](#) for prospective services (and then send a quotation to the customer for these services).
- And more...

The topics in this section provide more information about the sales and marketing functions.

The Big Picture of Campaigns, Packages, and Orders

Three objects are at the heart of the sales and marketing functionality: **Campaigns**, **Packages**, and **Orders**.

- A **package** defines a basket of goods and services that can be offered to a customer or a prospect.
- A **campaign** is a structured effort to offer a given set of packages to existing customers or new prospects.
- An **order** is created for each customer / prospect to which a campaign is targeted.

The topics in this section provide background information about these objects.

An Overview of Campaigns, Packages and Orders

An order is used to define:

- Demographic information about a customer / prospect.
- Geographic information about the service address.
- The customer's response to eligibility-oriented questions. For example, you can pose questions like: Who is your current energy service provider? / Would you like to pay automatically? / What is your date of birth?

After the above information is defined, the [order transaction](#) presents packages that may be offered to the customer. A package controls the various types of service agreements that will be created if the customer selects the package.

NOTE:

The customer must be eligible for a package. When you setup a [package](#), you define its [eligibility criteria](#). For example, you can setup a package that is only applicable to commercial customers in Toronto who pay automatically and who commit to a one-year service contract.

If the customer elects to take a package, the order transaction sets up / updates the "V" (along with all of the ancillary things that happen when service is initiated, e.g., field activities are created). Please note that in addition to setting up the "V", it's also possible to populate / update other information when a package is selected. For example, you could have the system setup the customer's automatic payment options.

NOTE:

An order can be completed without creating service agreements. It is possible to use the order transaction to simply create / update persons and accounts. Refer to [Marketing Surveys](#) and [Setting up a New Customer Prior To Using Start/Stop](#) for more information.

All orders must reference a campaign. An order's [campaign](#) defines:

- How the campaign's orders use accounts and premises. For example, you can indicate that a given campaign is only targeted at existing premises (thus preventing the creation of a new premise when an order is completed).
- The type of information defaulted onto an order. For example, you can setup a campaign to default a given account management group on all orders linked to the campaign. This account management group will subsequently default onto the new account when the order is completed.
- The validation rules that control how its orders use accounts and premises. Specifically, on a campaign you define if an account / premise is required / optional / not allowed on its orders. In addition, if an account / premise is required or optional, you can control whether new accounts / premises can be created when an order is completed (the alternative is to force each order to use an existing account / premise). These controls prevent the unwanted proliferation of new accounts and premises for campaigns that are targeted at existing accounts and premises.
- The eligibility-oriented questions that are posed to the customer when an order is taken. For example, the questions indicated above - Who is your current energy service provider? / Would you like to pay automatically? / What is your date of birth? - are all defined on the order's campaign.
- The superset of packages that can be offered to a customer whose order references this campaign. An order's campaign defines the types of packages that may be selected.
- In addition to the above, campaigns also control high-level [eligibility rules](#) and [business process flows](#).

NOTE:

Bottom line. Campaigns allow you to define a group of **packages** that a customer is eligible to purchase. Every time a campaign is targeted at a customer, an **Order** is created. The information entered on the order qualifies the customer for one of the campaign's packages. If a customer elects to take a package, the "V" is setup / updated along with all of the ancillary things that happen when service is initiated, e.g., field activities are created, workflow processes are initiated, etc.

Supported Business Processes

Before providing examples of specific business processes, we'd like to highlight that you have control over some aspects of the user-interface flow (i.e., the screen navigation is not hard-coded). The following illustration highlights the potential user-interface flow:

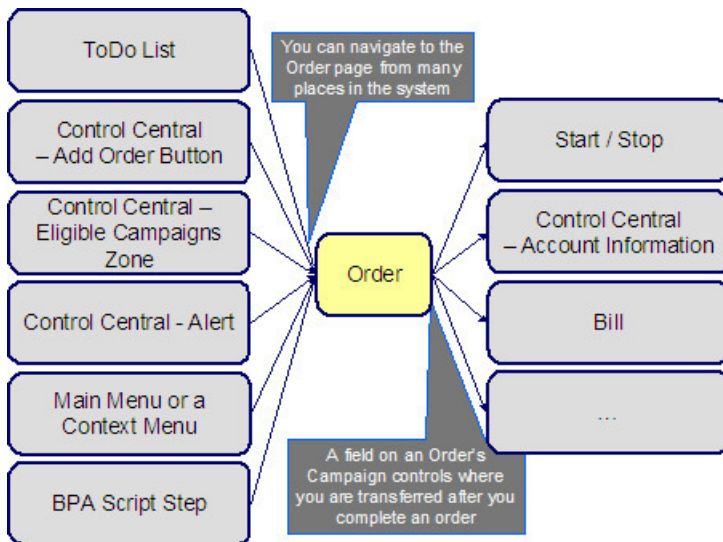

NOTE:

Bottom line. You can navigate to the order transaction from many places in the system. After you complete an order, you are transferred to an appropriate transaction. The specific transaction is controlled by you when you setup the order's [campaign](#).

The topics that follow illustrate specific business process flows that are possible in your implementation of the sales and marketing functionality.

Marketing to Prospects from a Marketing List

The following business process flow illustrates how the sales and marketing functionality would be used to market to prospects uploaded from a marketing database.

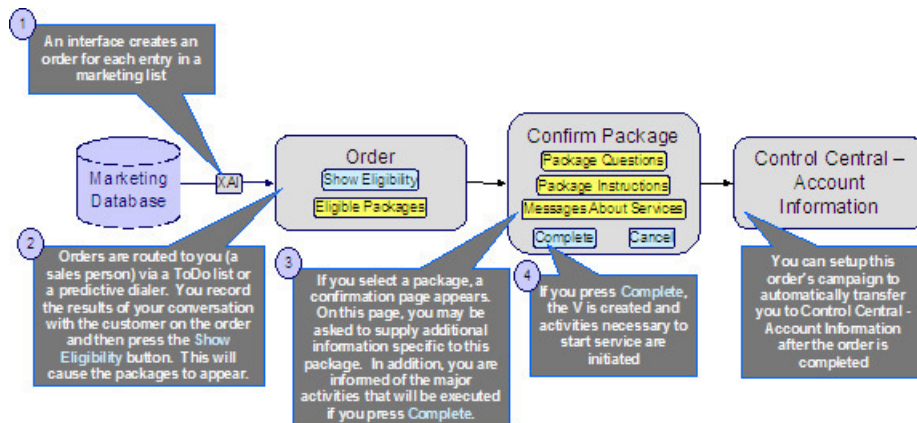

The following points describe the steps in this business process:

- An upload interface creates an [order](#) for each entry in a marketing database.

NOTE:

The system is not supplied with a dedicated interface to upload a marketing list.

- Each [order](#) is routed to a salesperson via a [To Do entry](#) (or via a predictive dialer if your company supports this type of technology).
- The first step in the salesperson's interaction with the prospect will be to confirm the information uploaded from the marketing list (e.g., is your Bob Smith?, is your address 15 Main St?, etc.). Any changes are made to the information saved on the order.
- The salesperson's next step involves posing eligibility-oriented questions related to the campaign. Examples of questions include:
 - **What is your date of birth?** This type of question might be asked if you have packages that are only marketed to senior citizens. Potential answers would be a valid date that's in the past.
 - **Would you be interested in our full-service option (electricity, digital cable and gas)?** Potential options are: yes and no.
 - **Who is your current electric service provider?** Potential answers are: Utility.Com, Reliant Resources, Other.
 - **Would you like to pay automatically?** Potential answers are: Yes, No.
 - **Would you like to pay using a levelized payment plan?** Potential answers are: Yes, No.
 - Etc.

- The gathered information is saved on the order and then the system displays the packages that can be offered to the customer. The available packages may be restricted based on information on the order. For example, some packages are only applicable to senior citizens, while others are only applicable to customers whose current service provider is Utility.com.
- If the customer is interested in a package, the salesperson selects it. Prior to the order being completed, the [package confirmation](#) page is shown. On this page are additional instructions about the package and a description of how the system will be updated if the package is selected (e.g., the types of service agreements will be displayed). In addition, the package may require additional information before it can be chosen. For example, the package may only be selectable if the customer agrees to pay automatically. In this situation, the package confirmation page will require the salesperson to enter the customer's bank and bank account.
- After entering all package-specific information, the order is completed. When the order is completed, the "V" is setup and all work necessary to satisfy the order is initiated (e.g., field activities are created, workflow processes are initiated, etc.).
- And finally, the user is returned to [Control Central - Account Info](#) where an overview of the customer is displayed. From this page, the user can drill down to any service agreement (or to start/stop) to perform any fine-tuning.
- Please be aware that the page to which you are transferred after order completion is controlled by a field on the order's [campaign](#). In our example, it made sense to transfer the user to Control Central as it provides a nice confirmation to the user (it shows a great deal of information about an account). However, you could setup the campaign to take the user to virtually any page in the system. You'll see good examples later in this discussion.

Marketing to Pre-Selected Customers

The following business process flow illustrates how the sales and marketing functionality would be used to market additional services to existing customers selected by a background process.

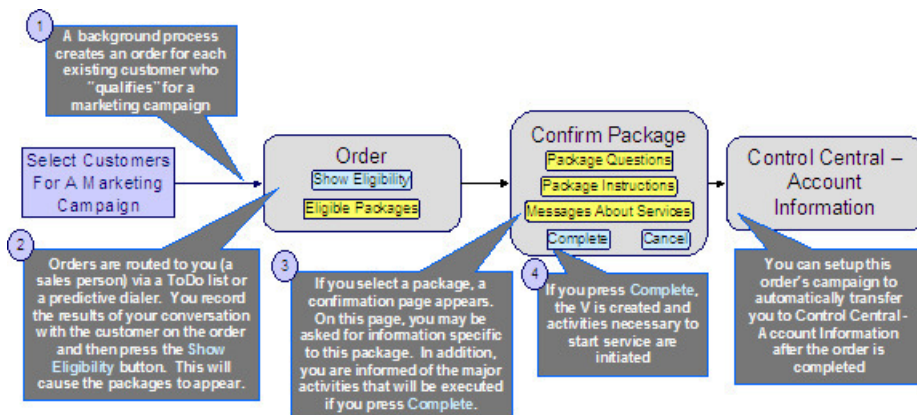

The following points describe the steps in this business process:

- A background process creates an [order](#) for each customer to be targeted under a marketing campaign.

NOTE:

The base package does not have an example of such a background process. Please speak to your support team if you require assistance in developing this type of process.

- Sales people would then process the order as described above.

Real-Time Marketing of Additional Services to a Customer

The following business process flow illustrates how the sales and marketing functionality would be used to market additional services to existing customers when they call in.

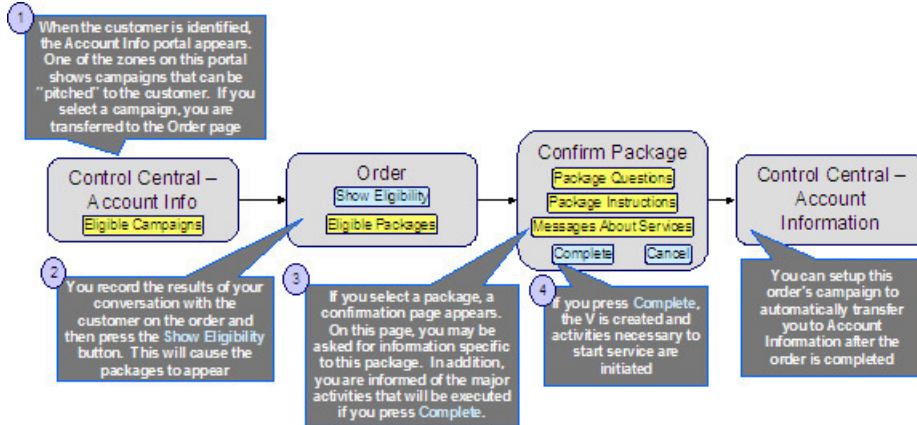

The following points describe the steps in this business process:

- When you find the customer's record on [Control Central - Search](#), you are automatically transferred to the [Account Information](#) portal. One of the zones on this page contains the campaigns that can be offered to the customer.

NOTE:

The "potential campaigns" zone only appears if the CSR has modified their preferences to display this zone.

- If you select a campaign from this zone, you are transferred to the [Order](#) transaction.

NOTE:

An order's campaign controls whether the [Main](#) or [Questions & Misc Fields](#) tab is initially displayed when the order transaction is invoked from this zone. For example, you might want to have the **Main** tab displayed if you want the order-taker to confirm the customer's demographic information before posing questions. Alternatively, you may want to skip this step and immediately present the order-taker with the campaign's questions. Keep in mind that the user can always display the other tab regardless of what is initially displayed.

- You then process the order as described above.

NOTE:

An easy way to create one-time charges. The above business process illustrates how the selection of a package will create one or more new service agreements for a customer. If your organization levies one-time charges (e.g., tree trimming charges, damage assessments, etc.), you can also use the order transaction to create both a "one-time charge" service agreement and create the related billable charge when the order is completed. To do this, setup a campaign with a separate package for each possible one-time charge. If an order is created for this type of campaign and the relevant package is selected, the system will setup the new billable charge service agreement and link the billable charge to it. Refer to [An Easier Way To Create One Time Charges](#) for an example of such a campaign.

Real-Time Marketing of Services to a Prospect

The following business process flow illustrates how the sales and marketing functionality would be used to market services when a new customer calls.

WARNING:

We do not recommend using this business process if your organization's service territory is predefined (i.e., if you've set up the premises and service points for your entire service territory). Why? Because it can result in the creation of new premises and / or service points and you probably don't want this to happen if you've already set everything up. While it is possible to disable the creation of new service points and premises by developing new plug-ins, we'd recommend using the business process described under [How To Add A New Customer From Control Central](#) if a new customer calls in and you have predefined premises and service points.

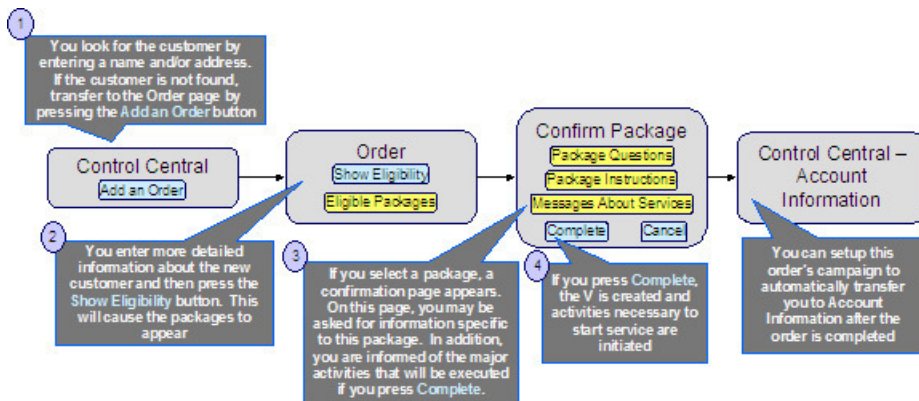

The following points describe the steps in this business process:

- You look for the customer using [Control Central - Search](#). Because the customer is new, you push the Add Order button on Control Central to transfer to the [Order](#) transaction.
- You then process the order as described above.

In order to take advantage of the above business process, it's important that you understand the following points:

- When the order page is opened for a new customer, the order's campaign is defaulted from the [installation record](#). The default campaign on the installation record is "generic" because we don't know anything about the customer (they are new) and therefore we cannot default a campaign targeted to their customer class or geography.
- This default campaign on the installation record must be constructed using one of the following approaches:
 - The default campaign has a package for every potential type of customer who can call up. While this is possible, it's probably not realistic as the data setup burden required to define every type of package could be onerous. However, if you have a limited number of service agreements, this approach is feasible.
 - The default campaign could just be a "dummy" campaign that has no packages. The "real" campaigns will only be shown after basic information about the customer has been recorded on the order and the "show eligibility" button is pressed. These campaigns appear in the order's [eligibility tree](#). The selection of a campaign in this tree will cause the order's campaign to be switched. Note, because the "dummy" campaign has no packages, no packages will appear in the order's eligibility tree when the dummy campaign is referenced on an order.
- The order is then processed as described above.

Setting up a New Customer Prior To Using Start/Stop

The following business process flow illustrates how the sales and marketing functionality would be used to create a new customer prior to using [Start/Stop](#) to start service at an existing premise.

NOTE:

The following business process is similar to that described under [How To Add A New Customer From Control Central](#). The only difference is that the **Order** transaction is used to create a new person and account rather than the **Person** transaction. The order transaction may be a better choice because it lets you define many attributes on person, account and premise that are not accessible on the person page. For example, the order transaction lets you define the customer's automatic payment option, bill after date, override due date, etc. In addition, on an order's campaign, you can define default values of many field values (both real fields and characteristics). These default values are presented on the order transaction and may be overridden by the user at will.

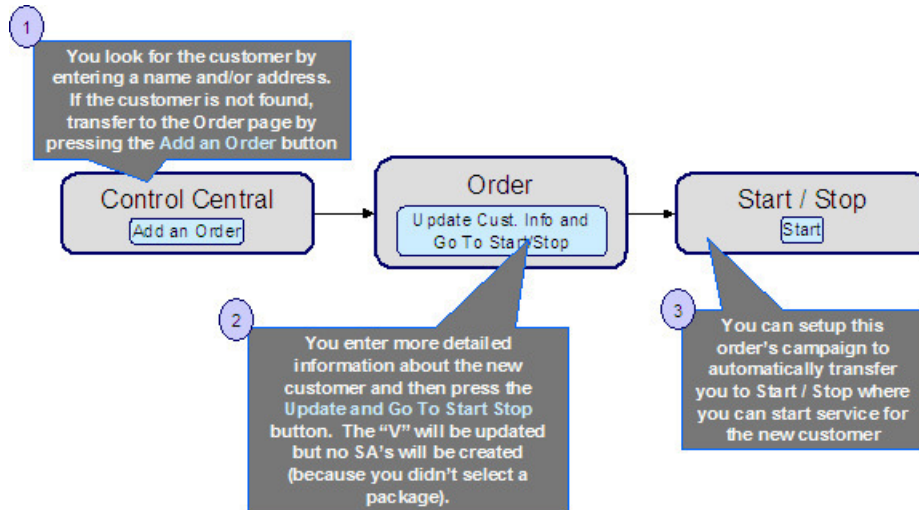

The following points describe the steps in this business process:

- You look for the customer using [Control Central - Search](#). Because the customer is new, you push the "Add Order" button on Control Central to transfer to the [Order](#) transaction.
- You record additional demographic and geographic information about the new customer and confirm all values defaulted from the order's campaign. After all required information is entered, you press the Update Cust. Info and Go To Start/Stop button to create the new person and account and transfer to [Start/Stop](#) to identify the new services desired by the customer.

NOTE:

The button's existence and label are dynamic. In the above example, we indicated that there is a button on the order page called **Update Cust. Info and Go To Start/Stop**. This button's presence on the page and its label are controlled by fields on the [campaign](#). When pressed, the "V" is updated with information on the order and the user is transferred to the "post completion" page (which is also defined on the campaign). You would only enable this button on campaigns whose orders can be completed without selecting a package. In the above example, the campaign doesn't have any packages (because service is intended to be started using Start/Stop). In [Examples of Campaigns and Packages](#) we show other examples of how these fields would be setup for different types of campaigns.

In order to take advantage of the above business process, it's important that you understand the following points:

- When the order page is opened as a result of pressing the Add Order button on [Control Central - Search](#), the order's campaign is defaulted from the [installation record](#). The default campaign on the installation record is "generic" because nothing is known about the new customer and therefore it is impossible to default a campaign targeted to their customer class or geography.
- The campaign on the installation record should be setup to contain default information for the "average" customer. For example, if you typically deal with residential customers, the information on the default campaign should be residential-oriented.

- When a user takes an order for a new customer, they'll change the default information when appropriate. For example, if an industrial customer were being added, they'd change the customer class to "industrial" and then ask to see the campaigns such a customer is eligible to choose (these alternate campaigns are displayed in the order's [eligibility tree](#)). For example, if you've setup campaigns with [eligibility rules](#) that are targeted at industrial customers and the customer class on the order has been changed to "industrial", the user will see these campaigns in the eligibility tree. The user can then change the campaign's order by simply clicking on the desired campaign.

NOTE:

The above example illustrates how an order can be completed without causing the creation of service agreements. Refer to [Marketing Surveys](#) and [Prelude to Start Stop](#) for examples of such campaigns.

Examples of Campaigns and Packages

The topics that follow provide examples of [campaigns](#) and [packages](#) that support several different scenarios. Your organization's campaigns and packages may differ markedly from these examples. Factors that will influence your sales and marketing objects include:

- Whether the type of goods and services marketed to your customers / prospects differs depending on some trait of the customer or the region in which they are located. For example,
 - Your company may have very straightforward packages that only differ based on whether the customer is industrial, residential or commercial. If this describes your company, the setup process will be simple.
 - Alternatively, your company might offer different packages to residential customers based on whether they pay automatically, whether the customer is a senior citizen, whether they purchase multiple services from you, etc. If this describes your company, then you'll have to define the various eligibility criteria and the respective packages applicable to customers who satisfy each criterion.
- Whether premises exist prior to order taking. For example, a company that distributes a commodity has a well-defined geographic area and therefore new premises typically don't arise when orders are taken.
- Whether your company offers many different types of goods and services.
- Whether your rates have charges / discounts that are only applied to some customers. For example, you might have discounts that are applied if the customer is a senior citizen or an employee.
- Which of the [Supported Business Processes](#) you implement.

Use the information that follows to form an intuitive understanding of campaigns and packages. After attaining this understanding, you'll be ready to design your own campaigns and packages.

Campaigns Without Packages

An order that references a campaign without packages will never create service agreements. The following topics describe scenarios when such a campaign would be used.

Marketing Surveys

Some organizations conduct "marketing surveys" to determine general trends amongst their customer base. The following diagram illustrates how such a campaign might look:

Campaign – Residential Survey

Default Info For New Customers / Premises

Not applicable

Questions To Be Posed On Orders

Question	Possible Answers
Electric or gas water heater?	Elec, Gas
How many low-flow toilets?	1 through 9
How many people are in your household?	1 through >12
How would you rate our service?	1 (bad), 2 (OK), 3 (great)
How many outages have you experienced in the last year?	0 through >12

Misc Fields To Be Captured

Not applicable

Campaign Eligibility Rules

Algorithm

Customer class is residential

Potential Packages

Not applicable

Campaign Behavior Controls

Enable button that allows order completion without package selection	Yes
Button Label	Complete Survey
Post completion transaction	Account Info

Note the following about this campaign:

- If the campaign is used to establish new customers, you can define information to default onto orders created for new customers. Because marketing surveys are targeted at existing customers, you don't need new customer default information on the campaign.
- You can define questions to be posed to customers when an order is taken when you setup a campaign. For a "marketing survey" campaign, you'd define each of the survey questions and the permissible answers. When a customer is surveyed, an order is created and their answers are saved on the order.
- On a campaign, you can define additional fields to be updated on persons, accounts and premises when orders associated with the campaign are completed. For example, you could indicate that the account's override due date and automatic payment options should be confirmed when an order is taken. Because marketing surveys are typically only asking questions, you wouldn't need to define additional customer information fields to be confirmed. However, you can if you want.
- All campaigns need at least one eligibility rule. These rules control whether the campaign appears in the "eligible campaigns" [content zone](#) when a customer is selected on Control Central. These rules also control whether the campaign appears on an order's [eligibility tree](#) (campaigns that appear in this tree are alternate campaigns that may be used on the order). Our example has assumed that this is a residential customer survey and therefore it only needs a single eligibility rule. Refer to [The Big Picture Of Campaign Eligibility Rules](#) for more information.
- Because this campaign is used purely to manage a marketing survey, it doesn't need any packages. Packages are only necessary if service agreements are created when an order is completed.

- Because this campaign doesn't have packages, we have indicated that the button that allows orders to be completed without selecting a package is enabled. If you don't enable this button, a user won't be able to complete a marketing survey (and it is only during order completion when the "V" is updated with the information on the order). Notice that we have assigned the button a label of Complete Survey.
- This campaign should be setup to transfer the user to [Control Central - Account Info](#) after the survey is completed.

Prelude to Start/Stop

Consider the example illustrated above under [Setting up a New Customer Prior To Start/Stop](#). In this example, the [order](#) transaction is used to create a new person and account; no service agreements are created when the order is completed. Rather, after the order is completed, the user is automatically transferred to [Start/Stop](#) where they can create service agreements. The following diagram illustrates how such a campaign might look:

Campaign – Add New Customer

Default Info For New Customers / Premises	
Field	Default Value
Customer Class	R
Account Management Group	RE SID

Questions To Be Posed On Orders

Not applicable

Misc Fields To Be Captured

Field	Required / Optional	Default Value
Auto-pay source	Optional	**
Auto-pay account	Optional	**
Date of birth	Optional	**

Campaign Eligibility Rules

Algorithm

This campaign is only used to create new customers

Potential Packages

Not applicable

Campaign Behavior Controls

Enable button that allows order completion without package selection	Yes
Button Label	Update the V / Go To Start
Post completion transaction	Start/Stop

Note the following about this campaign:

- Because this campaign is used to establish new customers, you should define new customer default information. The order taker can override these default values.
- If we assume you don't ask marketing / eligibility-oriented questions when you take-on a new customer then this campaign would not require any questions.

- On a campaign, you can define additional fields to be updated on the related person, account and premise when orders associated with the campaign are completed. For example, you could indicate that the account's override due date and automatic payment options should be confirmed when an order is taken. In our example, we are assuming that we want to define the customer's automatic payment options and their date of birth.
- As described under [Marketing Surveys](#), a campaign's eligibility rule(s) control whether the campaign appears in the "eligible campaigns" [content zone](#) and on an order's [eligibility tree](#). This campaign is odd in that we don't want it to ever appear as an "eligible campaign" because it's only used for NEW customers. In order to make this work you must:
 - Define an eligibility algorithm on this campaign that prevents it from appearing as an "eligible campaigns". Refer to [A Campaign That Is Never Eligible](#) for more information.
 - Update the [installation record](#) to indicate that this campaign is the one that should be used on orders created when a user presses the "Add an Order" button on [Control Central - Search](#). Refer to [Setting up a New Customer Prior To Starting Service](#) for more information about the flow of this business process.
- Because this campaign is used purely to add accounts and persons, it doesn't need any packages. Packages are only necessary if service agreements are created when an order is completed.
- Because this campaign doesn't have packages, we have indicated that the button that allows an order to be completed without selecting a package is enabled. If you don't enable this button, a user won't be able to complete the order (and it is only during order completion when the "V" is updated with the information on the order). Notice that we have assigned the button a label of Update The V and Go To Start.
- This campaign should be setup to transfer the user to [Start/Stop](#) after the order is completed.

Campaigns With Simple Packages

As explained under [Campaigns Without Packages](#), there are several situations that might necessitate a campaign without packages. In this section, we describe simple scenarios of campaigns with packages.

An Easier Way To Create One Time Charges

We use the term "one-time charge" to describe ad hoc charges, e.g., tree trimming charges, damage assessments, etc. The following points describe how one-time charges are levied if you don't use the order transaction:

- Determine if the customer to be invoiced already has an appropriate "one-time charge" service agreement. If one doesn't exist, you must create one using [Start/Stop Service](#).
- Next, a billable charge is added to the "one-time charge" service agreement (using [Billable Charge Maintenance](#)). The billable charge contains the invoice lines and amounts. The system will produce the bill for this charge when the account's bill cycle next executes.

Rather than going through the above multi-step process, you can also use the order transaction to create both a "one-time charge" service agreement AND create the billable charge. In addition, if the customer receiving the charge is new, the order transaction will also create a new person and account at the same time.

To take advantage of this facility, you must set up a campaign that has a separate package for each type of one-time charge as illustrated below. When an order is taken for such a campaign, the user simply selects the package that corresponds with the desired one-time charge. The system will then create the necessary customer and financial information when the package is confirmed.

NOTE:

Billing of one-time charges. The order transaction will not cause a bill to be generated for the customer. Rather, the next time the account is billed, the system will see that there's an unbilled billable charge and create a bill segment for it. This bill segment will appear on the customer's regular bill along with their other charges. If you'd prefer to create the bill for the one-time charges immediately, you could setup the campaign to automatically transfer the user to the

bill transaction where they can [create an ad hoc bill](#). If you do this, you'll need to create a new plug-in algorithm on the billable charge SA type to automatically activate the service agreement when it is created (otherwise the user would have to manually activate the billable charge service agreement before the bill can be generated).

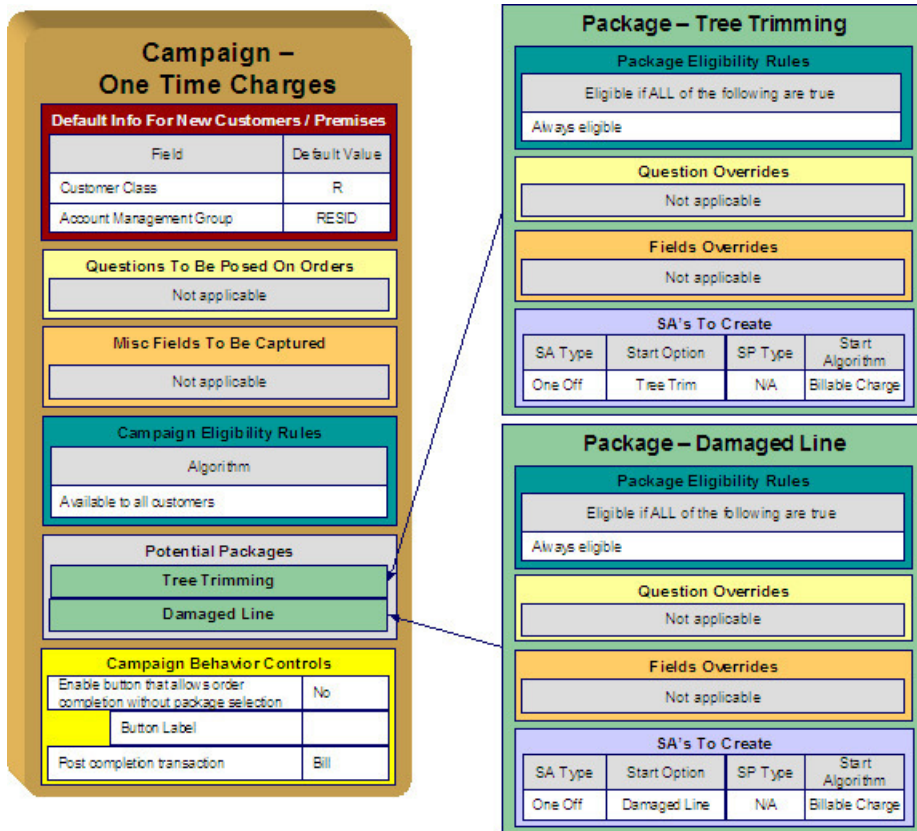

Note the following about this campaign:

- One-time charges can be levied against both new and existing customers. This means that orders associated with this campaign may cause new customers to be created. Therefore, we have specified information to default onto orders for new customers on the campaign. Note that we defined "residential-oriented" default values as the majority of one-time charges are levied against residential customers.
- If we assume you don't ask marketing / eligibility-oriented questions when you levy a one-time charge then this campaign would not require any questions.
- We have assumed that you are not capturing miscellaneous fields when you levy a one-time charge.
- As described under [Marketing Surveys](#), all campaigns need at least one eligibility rule. We have assumed that this campaign's packages can be selected by all types of customers and have therefore specified an eligibility algorithm that will be true for all customers.
- Because this campaign has packages, we have indicated that the button that allows an order to be completed without selecting a package is disabled. This means a user must choose one of the packages to complete the order.
- You might want to setup this campaign to automatically transfer the user to the bill transaction after the order is completed. See the note above the illustration for more information.
- We have assumed that this campaign can be used to levy two kinds of one-time charges - a tree trimming charge and a damaged line charge - and therefore this campaign requires two packages. Note the following about each package:
 - A package's eligibility rules control whether the package can be selected when an order is taken. With more sophisticated campaigns, you may have packages that are only applicable to certain types of customers. In our

example, we've assumed that these types of one-time charges can be levied against all customers and have therefore used "universal" eligibility criteria (i.e., there are no eligibility restrictions). Refer to [A Package That Is Always Eligible](#) for more information.

- On a package, it's possible to define additional questions to be posed if a package is selected. In our example, there are no additional questions to be posed for the one-time charge packages.
- On a package, it's possible to define additional fields to be captured if a package is selected. In our example, there are no additional fields to be captured.
- On a package, you define the types of service agreements to be created if a package is selected. In our example, we only need a single service agreement created / updated if the package is selected and therefore there's just one entry in **SAs To Create**. Please note the following about the information used to create this service agreement:
- The **SA Type** is one that's used for a [billable charge service agreement](#).
- The SA Type's **Start Option** is one that will automatically create a billable charge when a service agreement is created (if a [start option](#) references a [billable charge template](#), a billable charge will be created when this start option is used). In our example, we have assumed a different start option has been setup for each type of one-time charge.
- Billable charge service agreements do not require service points and therefore **SP Type** is not applicable.
- We've indicated a **Start Algorithm** of Billable Charge . Refer to STRM-AS for an example of such an algorithm (type).

Campaigns With Complex Packages

The [Campaigns With Simple Packages](#) illustrated campaigns with very simple packages. In this section, we describe a campaign with more complex packages.

Packages Limited By Answers And Field Values

Assume your organization has a campaign with several packages. Each package has the following restrictions in respect of its use:

- "Package 1" can be offered to residential customers in California who are senior citizens.
- "Package 2" can be offered to residential customers in California who live in single-family homes who are not senior citizens and who heat their homes with electricity.
- "Package 3" can be offered to residential customers in California who live in single-family homes who are not senior citizens and who heat their homes with gas.
- "Package 4" can be offered to residential customers in California who live in multi-family homes who are not senior citizens.

Also assume that all customers are encouraged to pay automatically.

The following diagram illustrates how such a campaign might look:

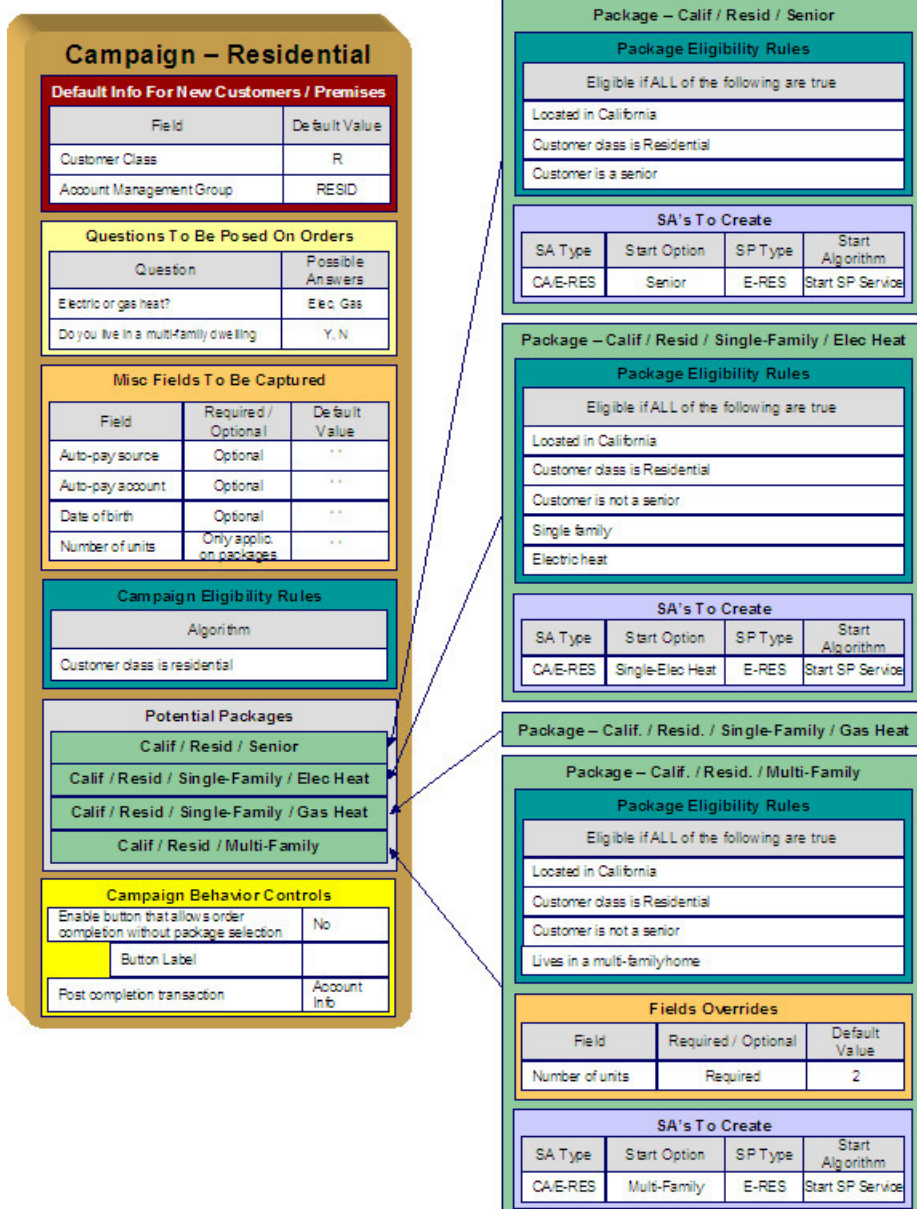

The topics that follow describe the campaign and packages used to support this scenario. We'll start by explaining each package. Then we'll describe how the campaign will be setup. This seems backwards, but it mirrors how you should design this type of campaign:

- [Senior Citizen Package](#)
- [Single-Family Electric Package](#)
- [Single-Family Gas Package](#)
- [Multi-Family Package](#)
- [The Campaign](#)

Senior Citizen Package

The package that is offered to residential customers in California who are senior citizens has the following traits:

- It has eligibility rules that restrict its use to customers who meet the following criteria:

- Customer class = Residential
- Division = California
- Birth date equates to that of a senior citizen
- We only need a single service agreement created if the package is selected and therefore there's just one entry in SAs To Create. Please note the following about the information used to create this service agreement:
 - The **SA Type** is one that's used for an electric residential service agreement (hence the E-RES SA type).
 - The SA Type's **Start Option** is one that will automatically setup the service agreement with the appropriate rate and contract options for a senior citizen.
 - The service agreement needs to be linked to an electric residential service point (hence the E-RES SP type).
 - We've indicated a Start Algorithm of Start SP Service. Refer to STRM-VT for an example of such an algorithm (type).
- We have not shown additional questions or miscellaneous fields in this package. This is because this package doesn't have additional questions or additional fields.

[Top of the Page](#)

Single-Family Electric Package

The package that is offered to residential customers in California who live in single-family homes who are not senior citizens and who heat their homes with electricity has the following traits:

- It has eligibility rules that restrict its use to customers who meet the following criteria:
 - Customer class = Residential
 - Division = California
 - Birth date does not equate to that of a senior citizen
 - The premise is a single-family home
 - The premise is heated with electricity
- We only need a single service agreement created if the package is selected and therefore there's just one entry in SAs To Create. Please note the following about the information used to create this service agreement:
 - The **SA Type** is one that's used for an electric residential service agreement (hence the E-RES SA type).
 - The SA Type's **Start Option** is one that will automatically setup the service agreement with the appropriate rate and contract options for this type of customer.
 - The service agreement needs to be linked to an electric residential service point (hence the E-RES SP type).
 - We've indicated a Start Algorithm of Start SP Service. Refer to STRM-VT for an example of such an algorithm (type).
- We have not shown additional questions or miscellaneous fields in this package. This is because this package doesn't have additional questions or additional fields.

[Top of the Page](#)

Single-Family Gas Package

The package that is offered to residential customers in California who live in single-family homes who are not senior citizens and who heat their homes with gas has the following traits:

- It has eligibility rules that restrict its use to customers who meet the following criteria:
 - Customer class = Residential
 - Division = California

- Birth date does not equate to that of a senior citizen
- The premise is a single-family home
- The premise is heated with gas
- We only need a single service agreement created if the package is selected and therefore there's just one entry in SAs To Create. Please note the following about the information used to create this service agreement:
 - The **SA Type** is one that's used for a gas residential service agreement (hence the G-RES SA type).
 - The SA Type's **Start Option** is one that will automatically setup the service agreement with the appropriate rate and contract options for this type of customer.
 - The service agreement needs to be linked to a gas residential service point (hence the G-RES SP type).
 - We've indicated a Start Algorithm of Start SP Service. Refer to STRM-VT for an example of such an algorithm (type).
- We have not shown additional questions or miscellaneous fields in this package. This is because this package doesn't have additional questions or additional fields.

[Top of the Page](#)

Multi-Family Package

The package that is offered to residential customers in California who live in multi-family homes who are not senior citizens has the following traits:

- It has eligibility rules that restrict its use to customers who meet the following criteria:
 - Customer class = Residential
 - Division = California
 - Birth date does not equates to that of a senior citizen
 - The premise is a multi-family home
- This package requires additional information that was not requested at the campaign-level. We're going to assume that the multi-family rate needs to know the number of units in the building. This means that this package needs an additional field (number of units).
- We only need a single service agreement created if the package is selected and therefore there's just one entry in SAs To Create. Please note the following about the information used to create this service agreement:
 - The **SA Type** is one that's used for an electric residential service agreement (hence the E-RES SA type).
 - The SA Type's **Start Option** is one that will automatically setup the service agreement with the appropriate rate and contract options for this type of customer.
 - The service agreement needs to be linked to an electric residential service point (hence the E-RES SP type).
 - We've indicated a Start Algorithm of Start SP Service. Refer to STRM-VT for an example of such an algorithm (type).
- We have not shown additional questions in this package. This is because this package doesn't have additional questions.

[Top of the Page](#)

The Campaign

Note the following about this campaign:

- Orders can be created for both new and existing customers. Because new customers are possible, we have specified information to default onto orders for new customers. Note that we defined "residential-oriented" default values (but remember, these values can be overridden on the order).

- The questions on the campaign are those whose answers play a part in each package's eligibility. You could also ask additional [marketing survey-oriented](#) questions that have nothing to do with package eligibility.
- The miscellaneous fields highlight an interesting situation. Notice that the date-of-birth and "automatic payment" fields are optional. However the field that holds the number of dwelling units is "only applicable on packages". When a field has this designation, the user will only be prompted to supply this field's value if a package is chosen where this field is applicable. In our example, only the Multi Family Package uses this field. This package will be setup to indicate that this field is required whereas the other packages will be setup to indicate that this field is not used.

NOTE:

Bottom line. The "miscellaneous fields" on a campaign must also include package-specific fields.

- All campaigns need at least one "highlight rule". These rules control whether the campaign appears in the "eligible campaigns" [content zone](#) when a customer is selected on Control Central. Also note that "highlight rules" also control whether the campaign appears on an order's eligibility tree (campaigns that appear in this tree are alternate campaigns that may be used on the order).
- We're going to assume that this is a residential campaign and therefore you would specify a highlight rule that returns true if the customer's customer class is residential.
- Because this campaign has packages, we have indicated that the button that allows an order to be completed without selecting a package is disabled. This means a user must choose one of the packages to complete the order.
- This campaign is setup so that the user will be transferred to [Control Central - Account Info](#) after the order is completed. This is a subjective decision as you could transfer the user to a variety of transactions. It's just that the Account Info page provides a nice confirmation of how the customer looks after the order has updated / created new information.

Packages Limited By Current State Of Service

Assume your organization has a campaign with several packages. Each package has the following restrictions in respect of its use:

- "Package 1" can be offered to residential customers in California who have gas service, but don't have electric service.
- "Package 2" can be offered to residential customers in California who have electric service, but don't have gas service.
- "Package 3" can be offered to residential customers in California who have neither electric nor gas service.

The following diagram illustrates how such a campaign might look:

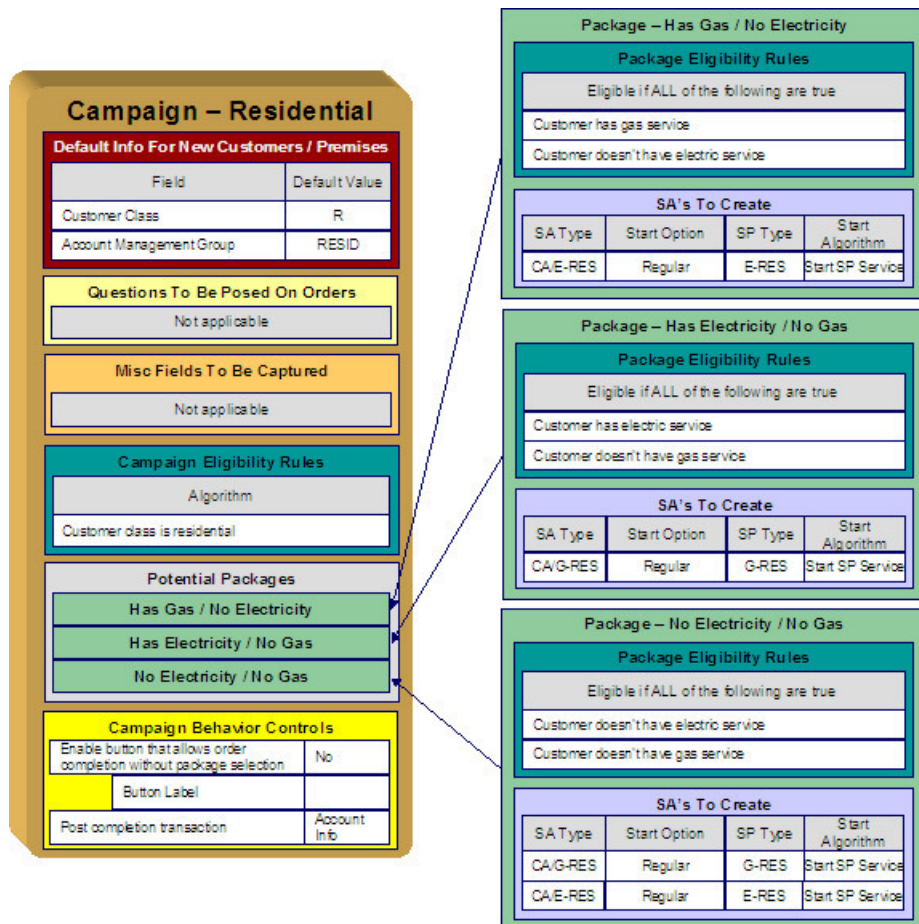

The topics that follow describe the campaign and packages used to support this scenario. We'll start by explaining each package. Then we'll describe how the campaign will be setup. This seems backwards, but it mirrors how you should design this type of campaign:

- [Has Gas / No Electricity Package](#)
- [Has Electricity / No Gas Package](#)
- [No Electricity / No Gas Package](#)

Has Gas / No Electricity Package

The package that is offered to customers that currently have gas service, but don't have electricity service has the following traits:

- It has eligibility rules that restrict its use to customers who meet the following criteria:
 - Customer has gas service
 - Customer doesn't have electricity service
- Refer to [A Package With Service Type Comparisons](#) for more information.
- We only need a single service agreement created if the package is selected and therefore there's just one entry in SAs To Create. Please note the following about the information used to create this service agreement:
 - The **SA Type** is one that's used for an electric residential service agreement (hence the E-RES SA type).
 - The SA Type's **Start Option** is one that will setup the service agreement with the appropriate rate and contract options.
 - The service agreement needs to be linked to an electric residential service point (hence the E-RES SP type).

- We've indicated a Start Algorithm of Start SP Service. Refer to STRM-VT for an example of such an algorithm (type).
- We have not shown additional questions or miscellaneous fields in this package. This is because this package doesn't have additional questions or additional fields.

[Top](#)

Has Electricity / No Gas Package

The package that is offered to customers that currently have electric service, but don't have gas service has the following traits:

- It has eligibility rules that restrict its use to customers who meet the following criteria:
 - Customer has electric service
 - Customer doesn't have gas service
- We only need a single service agreement created if the package is selected and therefore there's just one entry in SAs To Create. Please note the following about the information used to create this service agreement:
 - The **SA Type** is one that's used for a gas residential service agreement (hence the G-RES SA type).
 - The SA Type's **Start Option** is one that will setup the service agreement with the appropriate rate and contract options.
 - The service agreement needs to be linked to a gas residential service point (hence the G-RES SP type).
 - We've indicated a Start Algorithm of Start SP Service. Refer to STRM-VT for an example of such an algorithm (type).
- We have not shown additional questions or miscellaneous fields in this package. This is because this package doesn't have additional questions or additional fields.

[Top](#)

No Electricity / No Gas Package

The package that is offered to customers that don't currently have electricity or gas service has the following traits:

- It has eligibility rules that restrict its use to customers who meet the following criteria:
 - Customer doesn't have electric service
 - Customer doesn't have gas service
- We need two service agreements created (one for electricity, one for gas).
- We have not shown additional questions or miscellaneous fields in this package. This is because this package doesn't have additional questions or additional fields.

The Big Picture Of Package Eligibility Rules

The packages described under [Examples of Campaigns and Packages](#) have a variety of eligibility rules. Designing these rules can be easy or time-consuming; it all depends on the complexity of your business rules. We'll walk you through several examples to help you form an intuitive understanding of how to setup eligibility rules. Once you've acquired this intuition you'll be ready to design the eligibility rules for your own packages.

NOTE:

Don't confuse package eligibility rules with those associated with a campaign. Package eligibility rules control whether a customer is allowed to choose a package on the order transaction. Campaign eligibility rules control whether a campaign is highlighted on the "eligible campaigns" [content zone](#) and on an order's [eligibility tree](#).

Criteria Groups versus Eligibility Criteria

Before we provide concrete examples of eligibility criteria, we need to explain two concepts: Criteria Groups and Eligibility Criteria. A package's criteria groups control whether a customer is eligible to choose a package. At a high level, it works like this:

- A criteria group has one or more eligibility criteria. A group's criteria control whether the group is considered TRUE or FALSE for a given customer.
- When you create a group, you define what should happen if the group is TRUE or FALSE. You have the following choices:
 - The customer is eligible to choose the package
 - The customer is not eligible to choose the package
 - The next group should be checked.

We'll use the following example to help illustrate these points. Assume a package exists that can only be selected if:

- The customer resides in California and their current retail supplier is company A, B or C
- OR, the customer resides in Nevada and their current retail supplier is company X, Y or A

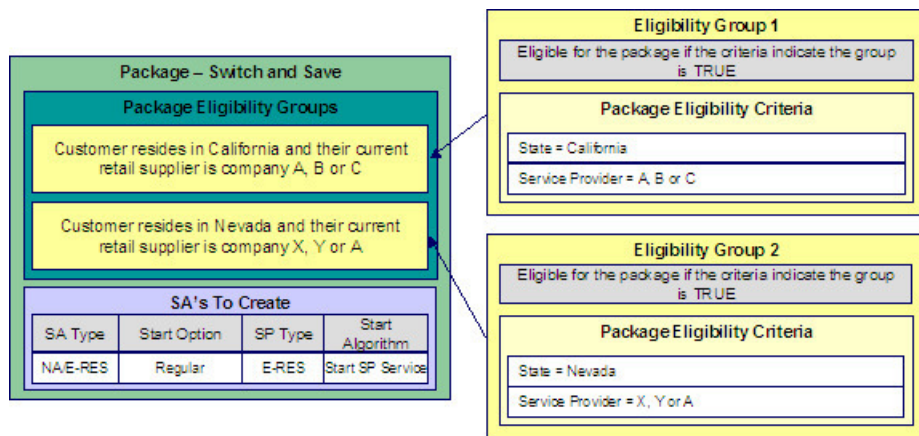

This package requires two eligibility groups because it has two distinct conditions:

- IF (STATE = CALIFORNIA AND (SERVICE PROVIDER IN (A, B, C)))
- IF (STATE = NEVADA AND (SERVICE PROVIDER IN (X, Y, A)))

If either condition is true, then the customer is eligible for the package.

You'd need to setup the following criteria groups in order to support this requirement:

Group No.	Group Description	If Group is TRUE	If Group is FALSE
1	Customer resides in California and their current retail supplier is company A, B or C	Eligible	Check next group

2	Customer resides in Nevada and their current retail supplier is company X, Y or A	Eligible	Ineligible
---	---	----------	------------

The following criteria will be required for each of the above groups:

Group 1: Customer resides in California and their current retail supplier is company A, B or C

Seq	Logical Criteria	If Eligibility Criteria is TRUE	If Eligibility Criteria is FALSE	If Insufficient Data
10	State = California	Check next condition	Group is false	Group is false
20	Electric retail supplier in (A, B, C)	Group is true	Group is false	Group is false

Group 2: Customer resides in Nevada and their current retail supplier is company X, Y or A

Seq	Logical Criteria	If Eligibility Criteria is TRUE	If Eligibility Criteria is FALSE	If Insufficient Data
10	State = Nevada	Check next condition	Group is false	Group is false
20	Electric retail supplier in (X, Y, A)	Group is true	Group is false	Group is false

The next section describes how you'd setup the specific logical criteria in each of the groups.

Defining Logical Criteria

When you setup an eligibility criterion, you must define two things:

- The field to be compared
- The comparison method

You have the following choices in respect of identifying the **field to be compared**:

- You can choose one of the miscellaneous fields on the order (keep in mind that miscellaneous fields also hold the answers to any questions posed on the order).
- You can execute an algorithm to retrieve a field value from someplace else in the system. This is a very powerful feature, but it's not terribly intuitive. We'll present a few examples later in this section to illustrate the power of this approach.

You have the following choices in respect of identifying the **comparison method**:

- You can choose an operator (e.g., >, <, =, BETWEEN, IN, etc.) and a comparison value.
- You can execute an algorithm whose job it will be to perform the comparison (and return TRUE, FALSE or INSUFFICIENT DATA). This is also a very powerful feature, but it's not terribly intuitive. We'll present a few examples later in this section to illustrate the power of this approach.

The [Examples Of Package Eligibility Rules](#) provide numerous examples to help you understand this design.

Examples Of Package Eligibility Rules

The topics in this section provide examples about how to setup package eligibility rules.

A Package That Is Always Eligible

If a package is always eligible, it still needs an eligibility group. Good examples of such packages are shown under [An Easier Way To Create One Time Charges](#). A package that is always eligible would require the following eligibility information:

Group No.	Group Description	If Group is TRUE	If Group is FALSE
1	Always eligible	Eligible	Eligible

The following criteria will be required for this group:

Group 1: Always eligible

Seq	Field to Compare	Comparison Method	If TRUE	If FALSE	If Insufficient Data
10	Algorithm: retrieve order's account	Algorithm: Always true	Group is true	Group is true	Group is true

This group's criterion is odd in that it's not comparing anything. In order to setup this criterion, you have to use the following "trick":

- **Field to Compare.** You can pick any miscellaneous field on the campaign. If the campaign has no miscellaneous fields, you'll need to setup an algorithm to retrieve a field from the order (refer to PKEL-ENRFLD for an example of this type of algorithm). In the above example, we used an algorithm to retrieve the order's account.
- **Comparison Method.** We chose a comparison algorithm that always returns a value of TRUE (refer to PKCC-DEFAULT for an example of this type of algorithm).
- You'll notice that if a value of TRUE is returned, the Group is true (and we've setup the group to indicate a true group means the customer is eligible for the package).

We understand this is a little complicated, but this design provides the power necessary to support very complex criteria. The following sections provide more examples to help you form a better understanding of these concepts.

A Package With A Time Span Comparison

The Senior Citizen Package has the following eligibility rules:

- Customer class = Residential
- Division = California
- Birth date equates to that of a senior citizen

These rules require only one eligibility group on the package. It would look as follows:

Group No.	Group Description	If Group is TRUE	If Group is FALSE
1	Residential, Calif, Senior	Eligible	Ineligible

The following criteria will be required for this group:

Group 1: Residential, Calif, Senior

Seq	Field to Compare	Comparison Method	If TRUE	If FALSE	If Insufficient Data
10	Algorithm: retrieve order's customer class	= R	Check next condition	Group is false	Group is false
20	Algorithm: retrieve order's division	= CA	Check next condition	Group is false	Group is false
30	Misc Field On Order: Date of Birth	Algorithm: True if senior	Group is true	Group is false	Group is false

The first two criteria are easy; they simply retrieve a field on the order and compare it to a given value. If the comparison doesn't result in a TRUE value, the Group is false (and, the group indicates that if the group is false, the customer isn't eligible for the package). If the comparison results in a TRUE value, the next condition is checked.

The last criterion contains a time span comparison. Time span comparisons are used to compare a date to something. In our example, we have to determine the age of the customer based on their birth date. If the resultant age is > 65, they are considered to be a senior citizen. To pull this off, you can take advantage of a comparison algorithm supplied with the base package as described below.

- Field to Compare. The miscellaneous field in which the customer's birth date is held is selected.
- Comparison Method. We chose a comparison algorithm that returns a value of TRUE if the related field value (the customer's date of birth) is greater than 65 years (refer to PKCC-TIMESPN for an example of this type of algorithm).

You'll notice that if a value of TRUE is returned by the True if senior algorithm, the group is true (and we've setup the group to indicate a true group means the customer is eligible).

NOTE:

The time span algorithm can be used to compare days, weeks, months, etc. Refer to PKCC-TIMESPN for more information about this algorithm.

A Package With Service Type Comparison

The Has Gas / No Electricity Package has the following eligibility rules:

- Customer has gas service
- Customer doesn't have electricity service

These rules require only one eligibility group on the package. It would look as follows:

Group No.	Group Description	If Group is TRUE	If Group is FALSE
1	Has Gas, Doesn't Have Electricity	Eligible	Ineligible

The following criteria will be required for this group:

Group 1: Has Gas, Doesn't Have Electricity					
Seq	Field to Compare	Comparison Method	If TRUE	If FALSE	If Insufficient Data
10	Algorithm: check if customer has gas service	= TRUE	Check next condition	Group is false	Group is false

20	Algorithm: check if customer has electric service	= TRUE	Group is false	Group is true	Group is false
----	---	--------	----------------	---------------	----------------

Both criteria are similar - they check if the customer has a given type of service and act accordingly. We used a "field to compare" algorithm to pull this off, but this algorithm is a bit counter intuitive (but understanding it will provide you with another way to implement complex eligibility criteria):

- **Field to Compare.** We chose a "field to compare" algorithm that checks if an account has service agreements that belong to a given set of service types. It returns a value of TRUE if the customer has an active service agreement that matches one of the service types in the algorithm. In our example, the "check if customer has gas service" algorithm returns a value of TRUE if the customer has at least one active service agreement whose SA type references the gas service type. The "check if customer has electric service" algorithm is almost identical, only the service type differs. Refer to PKEL-SVCTYP for an example of this type of algorithm.
- **Comparison Method.** We simply compare the value returned by the algorithm to TRUE and indicate the appropriate response.

NOTE:

Bottom line. The "field to compare" algorithm isn't actually returning a specific field's value. Rather, it's returning a value of TRUE or FALSE (this is not a misspelling). This value is, in turn, compared by the "comparison method" and the group is set to true, false or check next accordingly.

A Package With More Complex Operators

One of the eligibility groups described under [Criteria Groups versus Eligibility Criteria](#) has the following eligibility rules:

- Customer must live in California
- Service provider is A, B or C

The eligibility group in which these rules would be defined looks as follows:

Group No.	Group Description	If Group is TRUE	If Group is FALSE
1	Lives in California, current service provider is either retailer A, B or C	Eligible	Ineligible

The following criteria will be required for this group:

Group 1: Lives in California, current service provider is either retailer A, B or C					
Seq	Field to Compare	Comparison Method	If TRUE	If FALSE	If Insufficient Data
10	Algorithm: retrieve order's state	= CA	Check next condition	Group is false	Group is false
20	Misc Field On Order: Current electric supplier	IN A, B, C	Group is true	Group is false	Group is false

This example is very simple. The only thing worth pointing out is that a number of operators can be used when you define a "comparison method". Refer to [Package - Eligibility](#) for the complete list of operators.

The Big Picture Of Campaign Eligibility Rules

In the previous section, we explained how to [Design Eligibility Rules For A Package](#). In this section, we explain how to design eligibility rules for a campaign.

A campaign's eligibility rules control two things:

- Whether the campaign appears in the Eligible Campaigns [content zone](#). This content zone suggests possible campaigns for the current customer displayed on control central. You might want to use this zone if you have different campaigns that are offered to different types of customers. Refer to [Real-time Marketing of Additional Services to a Customer](#) for an example of how this content zone can be used to "up sell" additional services.
- Whether the campaign appears on an order's [eligibility tree](#). Campaigns that appear in this tree are alternate campaigns that may be used on the order. Refer to [Real-time Marketing of Services to a Prospect](#) for an example of how an order's eligibility tree can contain alternate campaigns for an order.

Designing these criteria can be easy or time-consuming; it all depends on the complexity of your business rules. We'll walk you through several examples to help you form an intuitive understanding of how to setup campaign eligibility rules. Once you've acquired this intuition you'll be ready to design the eligibility rules for your own packages.

NOTE:

Don't confuse eligibility rules for a package with those associated with a campaign. Package eligibility rules control whether a customer is allowed to choose a package. Campaign eligibility rules control whether a campaign is highlighted on the Eligible Campaigns [content zone](#) and on an order's [eligibility tree](#).

Campaign Eligibility Rules Are Not Strictly Enforced

While the system prevents ineligible packages from being selected for an order (based on the [package's eligibility rules](#)), the system does not strictly enforce a campaign's eligibility rules. In other words, a user can change the campaign on an order to any active campaign. This "laxness" is intentional; otherwise it could become impossible to change an order's campaign.

It might be more helpful to think of campaign eligibility rules as "highlight conditions". These "highlight conditions" simply control whether the campaign appears in the Eligible Campaigns [content zone](#) and on an order's [eligibility tree](#).

Campaign Eligibility Rules Are Defined Using Algorithms

You define a campaign's eligibility rules using one or more algorithms on the [campaign](#). These algorithms are relatively straightforward as they simply return one of the following values:

- Eligible. Meaning the customer is eligible for the campaign.
- Ineligible. Meaning the customer is not eligible for the campaign
- Check Next Algorithm. Meaning that the next algorithm should be checked. You'd only design an algorithm to return such a value if multiple algorithms are used to determine a customer's eligibility for a campaign.

NOTE:

Bottom line. A customer is eligible for a campaign if at least one of its eligibility algorithms returns a value of "eligible".

The [Examples Of Campaign Eligibility Rules](#) provide numerous examples to help you understand this design.

Examples Of Campaign Eligibility Rules

The topics in this section provide examples about how to setup campaign eligibility rules.

A Campaign That Is Always Eligible

If a campaign is always eligible, it would require a simple eligibility algorithm that returns an indication that it is always eligible. A good example of such a campaign is shown under [An Easier Way To Create One Time Charges](#). Refer to CAEL-DEFAULT for an example of this type of eligibility algorithm.

A Campaign That Is Never Eligible

If a campaign is never eligible, it would require a simple eligibility algorithm that returns an indication that it is ineligible. A good example of such a campaign is shown under [Prelude To Start/Stop](#). Refer to CAEL-DEFAULT for an example of this type of eligibility algorithm.

A Campaign For Residential Customers

If a campaign should only be targeted at residential customers, it would require a simple eligibility algorithm that returns an indication of eligible if the customer's customer class is residential. A good example of such a campaign is shown under [Marketing Surveys](#). Refer to CAEL-CC for an example of this type of eligibility algorithm.

A Campaign For California, Residential Customers

If a campaign should only be targeted at residential customers in California, it would require two eligibility algorithms:

Algorithm No	Algorithm	Example Algorithm
1	Indicate Check Next Algorithm if customer class is "residential"	Refer to CAEL-CC for an example of this type of eligibility algorithm.
2	Indicate Eligible if division is "California"	Refer to CAEL-DIV for an example of this type of eligibility algorithm.

Designing Campaigns and Packages

Designing [campaigns](#) and [packages](#) can be simple or challenging. Factors that will influence the complexity of the design process include:

- Whether the type of goods and services marketed to your customers / prospects differs depending on some trait of the customer or the region in which they are located. For example,

- Your company may have very straightforward packages that only differ based on whether the customer is industrial, residential or commercial. If this describes your company, the setup process will be simple.
- Alternatively, your company might offer different packages to residential customers based on whether they pay automatically, whether they are a senior citizen, whether they purchase multiple services from you, etc. If this describes your company, then you'll have to define the various eligibility criteria and the respective packages applicable to customers who satisfy each criterion.
- Whether premises exist prior to order taking. For example, a company that distributes a commodity has a well-defined geographic area and therefore new premises typically don't arise when orders are taken.
- Whether your company offers many different types of goods and services.
- Whether your rates have charges / discounts that are only applied to some customers. For example, you might have discounts that are applied if the customer is a senior citizen or an employee.
- Which of the [Supported Business Processes](#) you implement.

The topics in this section provide a structured approach to design your campaigns and packages.

Determine The Place Of Start/Stop

Before you can design your campaigns and packages, you must determine if your organization will use [start / stop](#) to initiate new service agreements or whether new service can be initiated using the [order](#) transaction. Refer to [Order versus Start / Stop](#) for information to help you make this decision.

If you decide to use [start / stop](#) to initiate service, we'd recommend creating the following types of campaigns:

- Create a campaign similar to that described under [Prelude to Start / Stop](#).
- If you levy one-time charges, you may also want to create a campaign similar to that described under [An Easier Way To Create One Time Charges](#).
- If your organization performs marketing surveys, you may also want to create a campaign similar to that described under [Marketing Surveys](#).

If you decide to use the [order](#) transaction to initiate new service, follow the steps outlined in the following sections. Note that we use the example described under [Packages Limited By Answers And Field Values](#) when describing the design process.

Determine Which Types Of Service Agreements Are Created

WARNING:

We have assumed that you have already designed your organization's SP types, SA types, start options and rates. If you have not yet done this, we recommend familiarizing yourself with the concepts described in [Designing SP Types](#), [Rates](#) and [Defining Service Agreement Types](#) before designing your campaigns and packages.

Start off by determining the different types of service agreements that can be created if a package is selected. In our [example campaign](#), only one SA type is used - E-RES (electric residential service).

Determine The Different Start Options That Exist For Each Type Of Service Agreement

After you know which SA types are going to be created, determine the potential [start options](#) that can be used for each SA type. In our [example campaign](#), several start options are possible for the E-RES (electric residential service):

SA Type	Start Option
E-RES	Senior
E-RES	Single-Elec Heat
E-RES	Single-Gas Heat
E-RES	Multi-Family

Determine The SP Type (if any) For Each Service Agreement

The SA types and start options control how the service agreement will look (i.e., they control the rate, contract riders, characteristics, interval profiles, time-of-use maps, etc. defaulted onto new service agreements created when a package is selected). During this step, you define the SP type of the service point that will be linked to the service agreement. If several different types of SP types can be used for a service agreement, you'll have to choose one as this is the type of service point that will be created when the service agreement is created. If you plan to allow the package to be used to start service at an existing premise (and you don't want the system to create new service points), you will have to develop new plug-ins. Please speak to your implementation group if you need more information.

In our [example campaign](#), only one SP type is created (or reused if the premise already has a service point of this type) - E-RES (electric residential service point):

SA Type	Start Option	SP Type
E-RES	Senior	E-RES
E-RES	Single-Elec Heat	E-RES
E-RES	Single-Gas Heat	E-RES
E-RES	Multi-Family	E-RES

NOTE:

Many service agreements don't need SP types. For service agreements that don't use service points (e.g., deposit service agreements, charitable contributions, one-time charges, etc.), you don't have to reference a SP type.

Determine The Method Used To Create Each Service Agreement

For each SA Type / Start Option / SP Type combination, determine the algorithm that will be used to create the service agreement and the service point. The base package is supplied with a limited number of such algorithm types (refer to STRM-AS and STRM-VT for examples).

SA Type	Start Option	SP Type	Start Method
E-RES	Senior	E-RES	Algorithm: Create new service agreement and stop old service agreement if active SA with the same service type exists
E-RES	Single-Elec Heat	E-RES	Algorithm: Create new service agreement and stop old service

E-RES	Single-Gas Heat	E-RES	agreement if active SA with the same service type exists Algorithm: Create new service agreement and stop old service agreement if active SA with the same service type exists
E-RES	Multi-Family	E-RES	Algorithm: Create new service agreement and stop old service agreement if active SA with the same service type exists

Extract Algorithms From The Start Method

The start methods illustrated above all require the same algorithm:

Algorithm Type	Algorithm	Parameter Values
Create SP and create SA (see STRM-VT)	Always create new SA and stop existing SA	2 (stop existing service)

Determine Which Combinations Can Be Grouped Under A Package

Now you determine which combinations of service agreements can be offered to a customer as a package. In our [example campaign](#), a customer can only choose one type of service agreement (i.e., each entry in our table is mutually exclusive). This means that each entry is a separate package:

Package	SA Type	Start Option	SP Type	Algorithm
1	E-RES	Senior	E-RES	STRM-VT (Switch Option)
2	E-RES	Single-Elec Heat	E-RES	STRM-VT (Switch Option)
3	E-RES	Single-Gas Heat	E-RES	STRM-VT (Switch Option)
4	E-RES	Multi-Family	E-RES	STRM-VT (Switch Option)

FASTPATH:

Refer to [Packages Limited By Current State Of Service](#) for an example of a package that has multiple service agreements.

Determine Package Eligibility Rules

The topics in this section describe the eligibility rules for each package in our [example campaign](#).

NOTE:

Assumption. This section assumes you are comfortable with the information in [The Big Picture Of Package Eligibility](#).

Eligibility Rules For Package 1

Package 1 (the senior package) in our [example campaign](#) has the following eligibility rules:

- Customer class = Residential
- Division = California
- Birth date equates to that of a senior citizen

These rules require only one eligibility group on the package. It would look as follows:

Group No.	Group Description	If Group is TRUE	If Group is FALSE
1	Residential, Calif, Senior	Eligible	Ineligible

The following criteria will be required for this group:

Group 1: Residential, Calif, Senior					
Seq	Field to Compare	Comparison Method	If TRUE	If FALSE	If Insufficient Data
10	Algorithm: retrieve order's customer class	= R	Check next condition	Group is false	Group is false
20	Algorithm: retrieve order's division	= CA	Check next condition	Group is false	Group is false
30	Misc Field On Order: Date of Birth	Algorithm: True if senior	Group is true	Group is false	Group is false

Eligibility Rules For Package 2

Package 2 (the single-family / electric heat package) in our [example campaign](#) has the following eligibility rules:

- Customer class = Residential
- Division = California
- Birth date does not equate to that of a senior citizen
- Lives in a single-family home
- House is heated with electricity

These rules require only one eligibility group on the package. It would look as follows:

Group No.	Group Description	If Group is TRUE	If Group is FALSE
1	Residential, Calif, Non Senior, Single Family, Electric Heat	Eligible	Ineligible

The following criteria will be required for this group:

Group 1: Residential, Calif, Non Senior, Single Family, Electric Heat

Seq	Field to Compare	Comparison Method	If TRUE	If FALSE	If Insufficient Data
10	Algorithm: retrieve order's customer class	= R	Check next condition	Group is false	Group is false
20	Algorithm: retrieve order's division	= CA	Check next condition	Group is false	Group is false
30	Misc Field On Order: Date of Birth	Algorithm: True if senior	Group is false	Check next condition	Group is false
40	Misc Field On Order: Type of Residence	= S (single family home)	Check next condition	Group is false	Group is false
50	Misc Field On Order: Type of Heat	= E (electric)	Group is true	Group is false	Group is false

Eligibility Rules For Package 3

Package 3 (the single-family / gas heat package) in our [example campaign](#) has the following eligibility rules:

- Customer class = Residential
- Division = California
- Birth date does not equate to that of a senior citizen
- Lives in a single-family home
- House is heated with gas

These rules require only one eligibility group on the package. It would look as follows:

Group No.	Group Description	If Group is TRUE	If Group is FALSE
1	Residential, Calif, Non Senior, Single Family, Gas Heat	Eligible	Ineligible

The following criteria will be required for this group:

Group 1: Residential, Calif, Non Senior, Single Family, Gas Heat

Seq	Field to Compare	Comparison Method	If TRUE	If FALSE	If Insufficient Data
10	Algorithm: retrieve order's customer class	= R	Check next condition	Group is false	Group is false
20	Algorithm: retrieve order's division	= CA	Check next condition	Group is false	Group is false
30	Misc Field On Order: Date of Birth	Algorithm: True if senior	Group is false	Check next condition	Group is false
40	Misc Field On Order: Type of Residence	= S (single family home)	Check next condition	Group is false	Group is false

50	Misc Field On Order: Type of Heat	= G (gas)	Group is true	Group is false	Group is false
----	--------------------------------------	-----------	---------------	----------------	----------------

Eligibility Rules For Package 4

Package 4 (the multi-family package) in our [example campaign](#) has the following eligibility rules:

- Customer class = Residential
- Division = California
- Birth date does not equate to that of a senior citizen
- Lives in a multi-family home

These rules require only one eligibility group on the package. It would look as follows:

Group No.	Group Description	If Group is TRUE	If Group is FALSE
1	Residential, Calif, Non Senior, Multi Family	Eligible	Ineligible

The following criteria will be required for this group:

Group 1: Residential, Calif, Non Senior, Single Family, Gas Heat					
Seq	Field to Compare	Comparison Method	If TRUE	If FALSE	If Insufficient Data
10	Algorithm: retrieve order's customer class	= R	Check next condition	Group is false	Group is false
20	Algorithm: retrieve order's division	= CA	Check next condition	Group is false	Group is false
30	Misc Field On Order: Date of Birth	Algorithm: True if senior	Group is false	Check next condition	Group is false
40	Misc Field On Order: Type of Residence	= M (multi family home)	Group is true	Group is false	Group is false

Extract Algorithms From The Eligibility Rules

The eligibility rules illustrated above require the following algorithms:

Algorithm Type	Algorithm	Parameter Values
Retrieve a field from the order for eligibility comparison (see PKEL-ENRFLD)	Retrieve Order's Customer Class	Field name: CUST_CL_CD
Retrieve a field from the order for eligibility comparison (see PKEL-ENRFLD)	Retrieve Order's Division	Field name: CIS_DIVISION
Time span comparison (see PKCC-TIMESPN)	Determine if birth date equates to that of a senior	Time span type: YEAR Operator: >=

Extract Miscellaneous Fields From The Eligibility Rules

During this step, you extract miscellaneous fields that must be captured on the order in order drive your eligibility rules.

Misc. Field	Where Stored	Why Is It Needed
Date of birth	Person characteristic	Numerous eligibility rules use this field to determine if a customer is a senior citizen
Type of Residence	Premise characteristic	Numerous eligibility rules use this field to qualify a customer for a package
Type of Heat	Premise characteristic	Numerous eligibility rules use this field to qualify a customer for a package

NOTE:

Fields explicitly referenced on every order. You'll notice that we didn't list those fields referenced in the eligibility rules that are explicitly referenced on every order (e.g., customer class, state, division, etc.). This is because these types of fields come "for free".

Determine Additional Information That Is Required If A Package Is Selected

During this step, you determine if there's any information that needs to be created when a package is selected that can't be defaulted from its start option. In our [example campaign](#), package 4 (the Multi-Family Home package), also needs to know the number of housing units at the premise (this information is probably needed to calculate a specific charge in the rate). None of the other packages require additional information. The extra field has been appended to our miscellaneous field table.

Misc. Field	Where Stored	Why Is It Needed
Date of birth	Person characteristic	Numerous eligibility rules use this field to determine if a customer is a senior citizen
Type of Residence	Premise characteristic	Numerous eligibility rules use this field to qualify a customer for a package
Type of Heat	Premise characteristic	Numerous eligibility rules use this field to qualify a customer for a package
Number of Units in House	Premise characteristic	The electric SA created by package 4 requires the number of units when it calculates the ongoing bill segments

Determine If There Are Additional Questions / Fields For Your Packages

Our [example campaign](#) indicates that all customers are encouraged to pay automatically. In order to pay automatically several fields are required (Start Date, End Date, Autopay Source (i.e., bank / credit card), Account Number, Account Name, Expiration Date). These fields are not "explicitly referenced" on the order and therefore must be captured as miscellaneous fields. We have appended these fields to our list of miscellaneous fields:

Misc. Field	Where Stored	Why Is It Needed
Date of birth	Person characteristic	Numerous eligibility rules use this field to determine if a customer is a senior citizen
Type of Residence	Premise characteristic	Numerous eligibility rules use this field to qualify a customer for a package
Type of Heat	Premise characteristic	Numerous eligibility rules use this field to qualify a customer for a package
Number of Units in House	Premise characteristic	The electric SA created by package 4 requires the number of units when it calculates the ongoing bill segments
Auto Pay Start Date	Account / Autopay Start Date Column	Used if a customer pays automatically
Auto Pay End Date	Account / Autopay End Date Column	Used if a customer pays automatically
Auto Pay Source	Account / Autopay Source	Used if a customer pays automatically
Auto Pay Account Number	Account / Autopay Account ID	Used if a customer pays automatically
Auto Pay Account Name	Account / Autopay Account Name	Used if a customer pays automatically
Auto Pay Account Expiration Date	Account / Autopay Account Expiration Date	Used if a customer pays automatically

We're going to assume that we don't capture any additional marketing-oriented questions. If we did, we'd need additional fields to hold the response to each question.

Determine If Additional Instructions Should Be Shown

If a package is selected, you can present additional instructions to the user informing them of special tasks they should perform (or special instructions they should give to the customer). For example, you could instruct the user to inform customers who aren't senior citizens that they should call back if they become seniors as they may qualify for a better rate. These instructions can be defined on each package.

For the sake of brevity, we will assume no additional instructions are necessary when a package is selected.

Determine If There Are Campaign-Level Fields / Questions

Next, you determine if there are additional fields that need to be captured regardless of the package that's selected. For example, you may want to capture additional demographic or geographic information for marketing purposes.

While our [example campaign](#) has no such requirement, for illustration purposes we'll assume you ask the customer to rate the quality of service they have experienced (assuming they are a current customer). This additional question requires another entry in our list of miscellaneous fields.

Misc. Field	Where Stored	Why Is It Needed
Date of birth	Person characteristic	Numerous eligibility rules use this field to determine if a customer is a senior citizen

Type of Residence	Premise characteristic	Numerous eligibility rules use this field to qualify a customer for a package
Type of Heat	Premise characteristic	Numerous eligibility rules use this field to qualify a customer for a package
Number of Units in House	Premise characteristic	The electric SA created by package 4 requires the number of units when it calculates the ongoing bill segments
Auto Pay Start Date	Account / Autopay Start Date Column	Used if a customer pays automatically
Auto Pay End Date	Account / Autopay End Date Column	Used if a customer pays automatically
Auto Pay Source	Account / Autopay Source	Used if a customer pays automatically
Auto Pay Account Number	Account / Autopay Account ID	Used if a customer pays automatically
Auto Pay Account Name	Account / Autopay Account Name	Used if a customer pays automatically
Auto Pay Account Expiration Date	Account / Autopay Account Expiration Date	Used if a customer pays automatically
Service Rating	Person characteristic	Campaign level marketing question

Determine The Properties Of Every Miscellaneous Field

At this point, you have amalgamated all miscellaneous fields required for the campaign and its packages. Now you have to define the following for each field:

- Prompt On Order. This is the prompt that will prefix the field when the [order](#) is taken. The following table provides examples.
- Campaign Applicability. This controls whether the field is optional , required, or only applicable on package(s).
 - A value of required means the order taker must enter a valid value before packages are displayed for selection.
 - A value of optional means the order taker can leave the field blank prior to package selection. You can make an optional field required on individual packages. For example, you would probably make **Date of birth** required on the Senior package.
 - A value of only applicable on packages is used for fields that are only captured for specific packages. Fields of this type are suppressed prior to package selection. When you setup a package, you indicate if the field is applicable (if so, the user is only prompted for the field if the package is selected).
- Type Of Response. This controls where the field is stored when the order is completed and how it is validated. You have two options: characteristic or column.
 - If a field is a Characteristic, you must define which entity the characteristic value is to be stored on when the order is completed (Person, Account, Premise or Order). You must also define the **Characteristic Type** as this controls the characteristic value entered by the user.
 - If a field's value resides is a column (as opposed to a characteristic value), you must define the [column reference](#). A field's column reference controls three things:
 - How the field's value is retrieved. A field's value is retrieved when an existing person / account / premise is referenced on an order.
 - How the field's value is validated. A field's value is validated before package eligibility is determined and before the order is completed.
 - How the field's value is posted (i.e., updated on the database). A field's value is posted when an order is completed.

FASTPATH:

Refer to [Extract Column References From Miscellaneous Fields](#) for more information about column references.

- **Default Value On Order.** This controls whether the order taker is supplied with a default value when an order is created. Note well: for optional and only applicable on package fields, you can specify a different default value on each package.

Misc. Field	Prompt On Order	Campaign Applicability	Type Of Response	Default Value On Order
Date of birth	What is your date of birth (used to qualify for senior discount)?	Optional	Characteristic Entity: Person Char Type: Date of birth	
Type of Residence	What type of residence do you live in?	Required	Characteristic Entity: Premise Char Type: Type of residence	S (single family)
Type of Heat	How do you heat your home?	Required	Characteristic Entity: Premise Char Type: Type of heat	E (electric)
Number of Units in House	How many units are in the entire house?	Only applicable on package(s)	Characteristic Entity: Premise Char Type: Number of units in house	
Auto Pay Start Date	What day would you like to start automatic payment processing (YYYY-MM-DD)?	Optional	Column Column Reference: Auto Pay Start Date	
Auto Pay End Date	What day would you like to stop automatic payment processing (leave blank if not applicable)?	Optional	Column Column Reference: Auto Pay End Date	
Auto Pay Source	From what type of credit card / bank will the funds be debited?	Optional	Column Column Reference: Auto Pay Source	
Auto Pay Account Number	What is your credit card / bank account number?	Optional	Column Column Reference: Auto Pay Account Number	
Auto Pay Account Name	What is the name on your account?	Optional	Column Column Reference: Auto Pay Account Name	
Auto Pay Account Expiration Date	If paying with a credit card, what is the expiration date (MM-YYYY)?	Optional	Column Column Reference: Auto Pay Credit Card Expiration Date	
Service Rating	Please rate our service	Optional	Characteristic Entity: Person	1 (excellent)

Extract Characteristic From The Miscellaneous Fields

Characteristic Type	Type	Valid Values	Entities On Which Characteristic Can Be Defined
Date of birth	Ad hoc value: use validation algorithm to confirm date is > 1-Jan-1900 and < 28-Feb-2002	Not applicable	Person, Order
Type of Residence	Predefined value	S: Single-Family M: Multi-Family	Premise, Order
Type of Heat	Predefined value	E: Electric G: Gas	Premise, Order
Number of Units in House	Ad hoc value: use validation algorithm to confirm value is > 0	Not applicable	Premise, Order
Service Rating	Predefined value	0: Not applicable 1: Excellent 2: Very Good 3: Good 4: Poor	Person, Order

Extract Column References From The Miscellaneous Fields

The [miscellaneous fields](#) illustrated above require the following column references (we describe the referenced algorithms at the bottom of the table):

Column Reference	Retrieval Algorithm	Validation Algorithm	Post Algorithm	Foreign Key Reference
Auto Pay Start Date	Retrieve account's current automatic payment information	Validate automatic payment information	Post automatic payment information	
Auto Pay End Date	N/A - this field is handled by the Retrieval Algorithm on Auto Pay Start Date	N/A - this field is handled by the Validation Algorithm on Auto Pay Start Date	N/A - this field is handled by the Post Algorithm on Auto Pay Start Date	
Auto Pay Source	N/A - this field is handled by the Retrieval Algorithm on Auto Pay Start Date	N/A - this field is handled by the Validation Algorithm on Auto Pay Start Date	N/A - this field is handled by the Post Algorithm on Auto Pay Start Date	Auto pay source
Auto Pay Account Number	N/A - this field is handled by the Retrieval Algorithm on Auto Pay Start Date	N/A - this field is handled by the Validation Algorithm on Auto Pay Start Date	N/A - this field is handled by the Post Algorithm on Auto Pay Start Date	

Auto Pay Account Name	N/A - this field is handled by the Retrieval Algorithm on Auto Pay Start Date	N/A - this field is handled by the Validation Algorithm on Auto Pay Start Date	N/A - this field is handled by the Post Algorithm on Auto Pay Start Date
Auto Pay Expiration Date	N/A - this field is handled by the Retrieval Algorithm on Auto Pay Start Date	N/A - this field is handled by the Validation Algorithm on Auto Pay Start Date	N/A - this field is handled by the Post Algorithm on Auto Pay Start Date

There are three types of algorithms referenced in the above table:

- **Retrieval algorithm.** A column's retrieval algorithm retrieves the column's current value from the database. You'll notice that only one of our columns uses a retrieval algorithm. This is because we've used a sophisticated example of a group of columns that are retrieved at the same time. When you have such a group of columns, nominate one of the columns to do the retrieval work and specify the retrieval algorithm on it.
- **Validation algorithm.** A column's validation algorithm validates the column's value prior to the database being updated. You'll notice that only one of our columns uses a validation algorithm. This is because we've used a sophisticated example of a group of columns that are validated as a group. When you have such a group of columns, nominate one of the columns to do the validation work and specify the validation algorithm on it.
- **Post algorithm.** A column's post algorithm updates the column's value on the database when the order is completed. You'll notice that only one of our columns uses a post algorithm. This is because we've used a sophisticated example of a group of columns that are posted together. When you have such a group of columns, nominate one of the columns to do the posting work and specify the posting algorithm on it.

Notice that we have indicated that one of the columns has a "foreign key reference". You declare a "foreign key reference" if the valid values for a column are defined on another table in the system (this also affects the order user interface as a dropdown appears for columns that have foreign key references). In our example, Auto Pay Source is the only column whose valid values are defined on the automatic payment source control table.

Extract Algorithms From The Column References

The column references illustrated above require the following algorithms:

Algorithm Type	Algorithm	Parameter Values
Retrieve automatic payment information from an account (see CRRT-AP)	Retrieve automatic payment information from an account	Param 1 = Auto Pay Start Date Column Reference Param 2 = Auto Pay End Date Column Reference Param 3 = Auto Pay Source Column Reference Param 4 = Auto Pay External Account Id Column Reference Param 5 = Auto Pay Expiration Date Column Reference Param 6 = Auto Pay Name Column Reference
Validate automatic payment information (see CRVL-AP)	Validate automatic payment information	Param 1 = Auto Pay Start Date Column Reference Param 2 = Auto Pay End Date Column Reference

Param 3 = Auto Pay Source Column Reference
 Param 4 = Auto Pay External Account Id Column Reference
 Param 5 = Auto Pay Expiration Date Column Reference
 Param 6 = Auto Pay Name Column Reference

Post automatic payment information (see CRPS-AP)

Post automatic payment information

Param 1 = Auto Pay Start Date Column Reference

Param 2 = Auto Pay End Date Column Reference

Param 3 = Auto Pay Source Column Reference

Param 4 = Auto Pay External Account Id Column Reference

Param 5 = Auto Pay Expiration Date Column Reference

Param 6 = Auto Pay Name Column Reference

Determine Account / Premise Dependency For Each Column Reference

Later in the design process (see [Determine How The Campaign Behaves](#)), you define on the campaign whether an account (and premise) is required, optional or not allowed on its orders. Your selection impacts how you setup column references. This is a little complicated so let's use an example:

- Assume you've setup a campaign to indicate a premise can optionally be defined on its orders.
- If the order-taker doesn't define a premise on an order, any premise-oriented questions and miscellaneous fields (Q&MF) should be suppressed on the order.
- It's easy for the system to know which Q&MFs to suppress when a Q&MF's response is held in a characteristic (because you must define on the campaign if the response will reside in an account, premise, person or order characteristic). For column reference Q&MFs, the system doesn't know if the response is account-oriented, premise-oriented or neither because algorithms handle the validation / updating of the response.
- Therefore, when you use column references on a campaigns Q&MFs, you must define if the responses are account-oriented or premise-oriented (so that the system can suppress the Q&MF when the user doesn't enter an account or premise on the order).

The following table contains the column references defined above as well as their dependency

Column Reference	Question Dependency
Auto Pay Start Date	Must have account
Auto Pay End Date	Must have account
Auto Pay Source	Must have account
Auto Pay Account Number	Must have account
Auto Pay Account Name	Must have account

You'll notice that each column reference is account-oriented (this is because automatic payment fields are stored on the respective account).

Determine If Any Properties Are Overridden On Any Package

At this point, you have defined the properties of all miscellaneous fields at the campaign level. You now need to determine if any of your packages need to override any of these properties. In general, you can only override miscellaneous fields whose campaign applicability is optional or only applicable on package(s).

Our [example campaign](#) has only two overrides:

Package 1 requires the following miscellaneous field overrides:

Misc. Field	Override Prompt (seen if a package is selected)	Override Package Applicability	Override Default Value
Date of birth	Not overridden	Required	Not overridden

Package 4 requires the following miscellaneous field overrides:

Misc. Field	Override Prompt (seen if a package is selected)	Override Package Applicability	Override Default Value
Number of Units in House	Not overridden	Required	2

WARNING:

If you override field properties on a campaign's packages, you will not be able to change the properties of the field at the campaign level.

Determine The Eligibility Rules For The Campaign

NOTE:

Assumption. This section assumes you are comfortable with the information in [The Big Picture Of Campaign Eligibility](#).

The easiest way to determine a campaign's eligibility is to examine each package's eligibility criteria and abstract common eligibility restrictions onto the campaign. It's important to remember that campaign-level eligibility is only used to highlight if the campaign MAY contain applicable packages; campaign-level eligibility is not strictly enforced.

The packages on our [example campaign](#) are all targeted at residential customers in California. Therefore we'll take advantage of two base package algorithms to construct the campaign's eligibility criteria.

Algorithm Type	Algorithm	Parameter Values
Check if account's customer class is in a predefined list (see CAEL-CC)	If customer class is "residential", check next algorithm	If customer's customer class is in list: 30 (check next) If customer's customer class is not in list: 20 (ineligible)

List of customer classes: R

Check if account's division is in a predefined list (see CAEL-DIV)

If division is "California", customer is eligible

If customer's CIS division is in list: 10 (eligible)

If customer's CIS division is not in list: 20 (ineligible)

List of customer classes: CA

Determine How The Campaign Behaves

The final step before you're ready to setup the campaign involves defining a variety of behavioral functions as described below:

- You need to define how the campaign uses accounts and premises. Specifically, on a campaign you define if an account / premise is required / optional / not allowed on its orders. In addition, if an account / premise is required or optional, you can control whether new accounts / premises can be created when an order is completed (the alternative is to force each order to use an existing account / premise). These controls prevent the unwanted proliferation of new accounts and premises for campaigns that are targeted at existing accounts and premises.
- Many fields on an order (e.g., phone type, customer class, division, account management group) can be defaulted on orders created for new customers. You will see these fields on [Order - Main](#). Think about each such field and whether a default value is appropriate. Keep in mind that the order taker can override any of these default values.
- An order taker can indicate that they want to [hold an order](#) if they need to do further research before continuing with an order. A background process (TD-ECBK) will create a [To Do entry](#) for held orders as a reminder to get back in touch with the customer on a future date. You can define the default To Do role assigned to such To Do entries when you create a campaign. Keep in mind that this value can be overridden when the order taker holds an order.
- You can indicate on a campaign the transaction to which the user should be transferred when orders are completed. Refer to [Supported Business Processes](#) for examples of how you might want to use this field.

Setup Sequence

And now you're ready to set up your campaign. The following points describe the order in which this should be done:

WARNING:

We have assumed that you have already designed your organization's SP types, SA types, start options and rates. If you have not yet done this, we recommend familiarizing yourself with the concepts described in [Designing SP Types, Rates and Defining Service Agreement Types](#) before designing your campaigns and packages.

- Setup any new [column references](#) required by the campaign's [miscellaneous fields](#). You will have to leave the retrieve, validate and post algorithms blank until after the next step.
- Setup any new [algorithms](#) required by:
 - The packages' [eligibility rules](#).
 - The packages' [start methods](#).
 - The campaign's [eligibility rules](#).
 - The campaign's [column references](#).
- Update the relevant [column references](#) with the appropriate retrieve, validate and post algorithms.
- Setup any new [characteristic types](#) required by the campaign's [miscellaneous fields](#).

- Create the [campaign](#) using the information you designed above. Specifically:
 - You defined the question and miscellaneous fields under [Determine The Properties Of Every Miscellaneous Field](#).
 - You defined the eligibility rules under [Determine The Eligibility Rules For The Campaign](#).
 - You defined everything else under [Determine How The Campaign Behaves](#).
 - We recommend leaving the campaign's status as Inactive until all packages are entered.
- Create the campaign's [packages](#) using the information you designed above. Specifically:
 - You defined the question and miscellaneous field overrides under [Determine If Any Properties Are Overridden On A Package](#).
 - You defined the eligibility rules under [Determine Package Eligibility Rules](#).
 - You defined the instructions under [Determine If Additional Instructions Are Required](#).
- Change the [campaign's](#) status to Active.

NOTE:

The default campaign on the installation record. If the campaign you've setup is the "default" campaign used when a user presses the Add Order button on [Control Central](#), make sure to specify it as the default campaign on the [installation record](#). Refer to [Setting up a New Customer Prior To Starting Service](#) for more information.

Other Useful Information

The topics in this section contain miscellaneous information about the sales & marketing functions.

Order versus Start/Stop

There are two different ways to start service for a customer:

- As described under [definitions](#), you can use the [order](#) transaction to start service.
- Alternatively, you can use [start / stop](#).

The following table provides insight into the pros and cons of each method (after this table you will find our recommendations):

Issue	Order	Start/Stop
New customer setup	Information about the new customer can be entered on the order page. A person / account will be setup when the order is completed.	A new person and account must be setup prior to using Start/Stop. See How To Add A New Customer From Control Central for more information.
New premise setup	Information about the new premise can be entered on the order page. A premise (and service points) will be setup when the order is completed.	A new premise and service point(s) must be setup prior to using Start/Stop.
Updates to existing customer information	Changes to a customer's existing account and/or person info may be entered on the order page. The related person and/or account will be updated when the order is completed.	Start/Stop cannot be used to update person or account information. Rather, you must transfer to the person or account page and make the necessary changes.

Incomplete orders	The order transaction allows you to record customer information and hold it without starting service. The customer can call back in the future and you can continue where you left off.	You cannot leave a start half-finished - you either have to complete the start or cancel it.
Stop current service, start new service	The order transaction does not currently provide a mechanism for stopping service (it can only be used to start service).	Start/Stop can be used to stop a customer's current service and start new service.
Automatic versus manual start option selection (start options are used to default a great deal of information onto a service agreement)	If a customer selects a package, the system creates service agreements using the start options defined in the package (i.e., you do not have to select a start option for each service agreement that's created).	When you start service, you must define the specific start option for each service agreement created (actually, you only have to do this for those types of service agreements that use start options).
Starting premise and non-premise oriented services	If a customer selects a package, the system can create both premise and non-premise oriented service agreements. For example, when a package is selected, the system can create electric, gas, deposit, and charitable contribution SAs (based on the information defined on the package).	Multiple premise-oriented service agreements can be created in one interaction. However, a separate interaction is required for each non-premise oriented service agreement.
Changes after completion	An order cannot be modified after it is completed. Any changes (cancellations prior to starting service, changes of the start date, etc.) must be performed using the start/stop transaction.	The start/stop transaction allows you to cancel and make changes to pending start service agreements.
Field activity visibility	After an order is completed, the user is transferred to control central where field activities associated with the premise can be seen in trees and context zones.	All field activities associated with all premises associated with all pending starts / stops are shown on the start / stop transaction.
Address changes	Address changes entered on the order transaction are applied when an order is completed (i.e., when a package is selected). They are not held awaiting service agreement activation.	When you enter an address change on the start / stop transaction, this address change is saved until the first pending start or stop is activated. This means that the address change is effectively held until the start/stop is activated.

Based on the above, we'd recommend the following:

- If your organization has well-defined service locations (i.e., premises) AND a premise's service point type controls the types of services offered to the customer, you should probably only use the order transaction to setup new customer information. The new service agreements should be setup using [start / stop](#). See [Prelude To Start/Stop](#) for more information.
- In all other situations, we'd recommend using the [order](#) transaction to start service. If customers typically stop and start service in tandem, we'd recommend the following steps:
 - Stop the customer's existing service using [start / stop](#).
 - Return to [Control Central - Account Info](#) and select the appropriate campaign from the appropriate portal zone. Keep in mind that the portal zones displayed on this page are based on the user's preferences and security profile. Therefore this zone may not be available to all users.
 - When you select the appropriate campaign, you'll be transferred to the [order](#) transaction where you can start the desired package for the customer.

Orders Cannot Be Changed After They Are Completed

The [Lifecycle of an Order](#) indicates that once an order is complete, it cannot become pending again. In addition to this rule, we'd like to stress that once an order is complete, you cannot make any changes to the order except to add new [log entries](#).

Premise and SP Characteristics May Be Populated From Postal Defaults

If you specify a new premise on the order transaction and you complete the order, a new premise will be created. This premise's characteristics can be populated from two different sources:

- You could have designed the campaign to have its orders capture premise characteristics. You do this by adding miscellaneous fields to the campaign that are premise characteristics.
- You could have set up [postal defaults](#) for the premise's country and postal code.

If a given characteristic is referenced on both of the above, the characteristic value on the campaign is used as the premise's characteristic value.

As described above, service points may be created when a package is selected (it depends on the [SA to Create algorithm](#) that you've used on the selected package). The base package algorithms that create a new service point when a package is selected will populate the service point's characteristics using the information on the postal defaults (if specified). Refer to STRM-VT for an example of this type of SA to create algorithm.

To Do List Processing

In the base package, there are two To Do lists that may be affected by orders:

- Highlight pending orders. This To Do list contains orders that are in the pending state. Refer to Pending To Do Entries (TD-EPND) for more information about this To Do list.
- Highlight held orders. This To Do list contains orders that are in the held state. Refer to Held To Do Entries (TD-ECBK) for more information about this To Do list. Refer to [Order - Hold Dialog](#) for more information about holding orders.

Hold and Cancel Reason Codes

In [Lifecycle of an Order](#), we illustrated how a user can hold a pending order. Before a user can hold an order, they must supply an [Order Hold Reason](#).

The same is true if a user wants to cancel a pending or held order (i.e., they must supply a [Order Cancellation Reason](#)).

These reason codes are purely for audit purposes.

Automatically Cancelling Old Orders

The system is delivered with a batch process, Cancel Pending/Held Orders (C1-CNPHO), that can be used to cancel held and/or pending orders that have been open for more than a specified number of days. Refer to the batch control description for more detail.

The delivered process is built using the [Plug-in Driven Background Processes](#) framework. Your implementation can introduce alternate logic, by duplicating this batch control and replacing the select and/or process records algorithms. For example, you can introduce a process record algorithm to create a To Do Entry instead of cancelling the order. Adjust the batch parameters to align with any custom logic you introduce.

Additional Things Can Happen When An Order Is Completed

An optional plug-in spot exists on [customer class](#) where you can introduce additional logic to be executed when an order is completed for an account that belongs to this customer class.

Another optional plug-in spot exists on [campaign](#) where you can introduce additional logic to be executed when an order is completed for the campaign.

New Premises and Accounts Are Only Created if an Order is Completed

It's important to understand that a premise and account are only created when an order is completed. This means you can explore alternatives with a prospect who resides at a new premise without introducing the premise / account. However, the system creates a person if you save an order so that an audit of the customer interaction exists in the system.

Premise Geographic Types Are Populated In An Unusual Way

A [premise's geographic ID's](#) are used by [Control Central](#) when you look for a customer / premise using geographic identifiers.

NOTE:

Geographic coordinates are optional. An [installation option](#) controls whether at least one geographic coordinate is required on every premise.

The following points describe how the geographic ID's are populated on premises that are created when an order is completed:

- If a [postal default](#) exists for the new premise's country / postal code, any geographic identifiers on the postal default are copied onto the new premise.
 - If a postal default hasn't been setup for the new premise's country / postal code, the premise will have a single geographic identifier. It is constructed as follows:
 - The geographic type is defaulted from the [campaign](#).
 - The geographic value is set to ***.
-

NOTE:

Potential error. If neither the campaign nor the postal defaults results in a geographic type AND the [installation record](#) indicates at least one geographic type is required on a premise, an error is generated explaining that either postal defaults or the campaign should be populated with default geographic information.

Account And Premise Usage Are Controlled By The Campaign

When you set up a campaign, you define how the campaign's orders use accounts and premises. Refer to the description of Account Usage and Premise Usage under [Campaign - Main](#) for more information.

Maintaining Orders

The order transaction can be used to satisfy many diverse requirements. For example, you can use an order to:

- Enroll new customers using a single transaction (i.e., you don't have to use the person, premise, service point, and start / stop transactions to enroll a new customer who resides at a new premise).
- Sell new products to existing customers.
- Update existing person, account and premise information using a single transaction.
- Market your services to prospects uploaded from a marketing list (and measure the success of your efforts). If the customer responds to your sales efforts, the system will automatically setup the customer, premise and related service agreements.
- Setup marketing surveys and record your customers' responses.
- Quickly create one-time charges.
- Set up proposals for prospective services (and then send a quotation to the customer for these services).
- And more...

The topics in this section describe the order transaction. Refer to [The Big Picture of Campaigns, Packages and Orders](#) for general information about orders.

Lifecycle of an Order

The following diagram illustrates the lifecycle of an order.

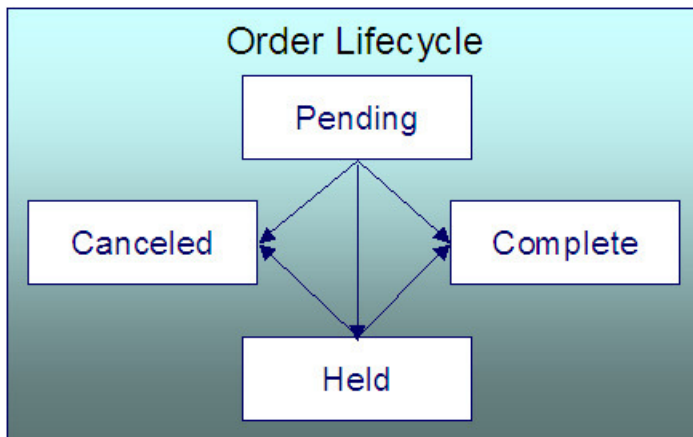

Pending An order starts its life in the Pending state. An order remains in this state until you Cancel, Complete or Hold it.

Held You Hold an order when you want to save an order pending future information. For example, you would hold an order if you need to perform research on the perfect rate for the customer before completing the order. A Held order can be Completed or Canceled.

Complete When a customer selects a package of goods and services, the "V" is updated, service agreements are initiated, and the order becomes Complete. No changes may be made to a Complete order.

Canceled A Pending or Held order may be Canceled.

Order User Interface Flow

The diagram that appears below illustrates the anticipated navigation path used to process an order.

WARNING:

An order's campaign controls many aspects of the user interface flow. The illustration that appears below is a sample of what's possible; it may not mirror how your team has setup your company's campaigns.

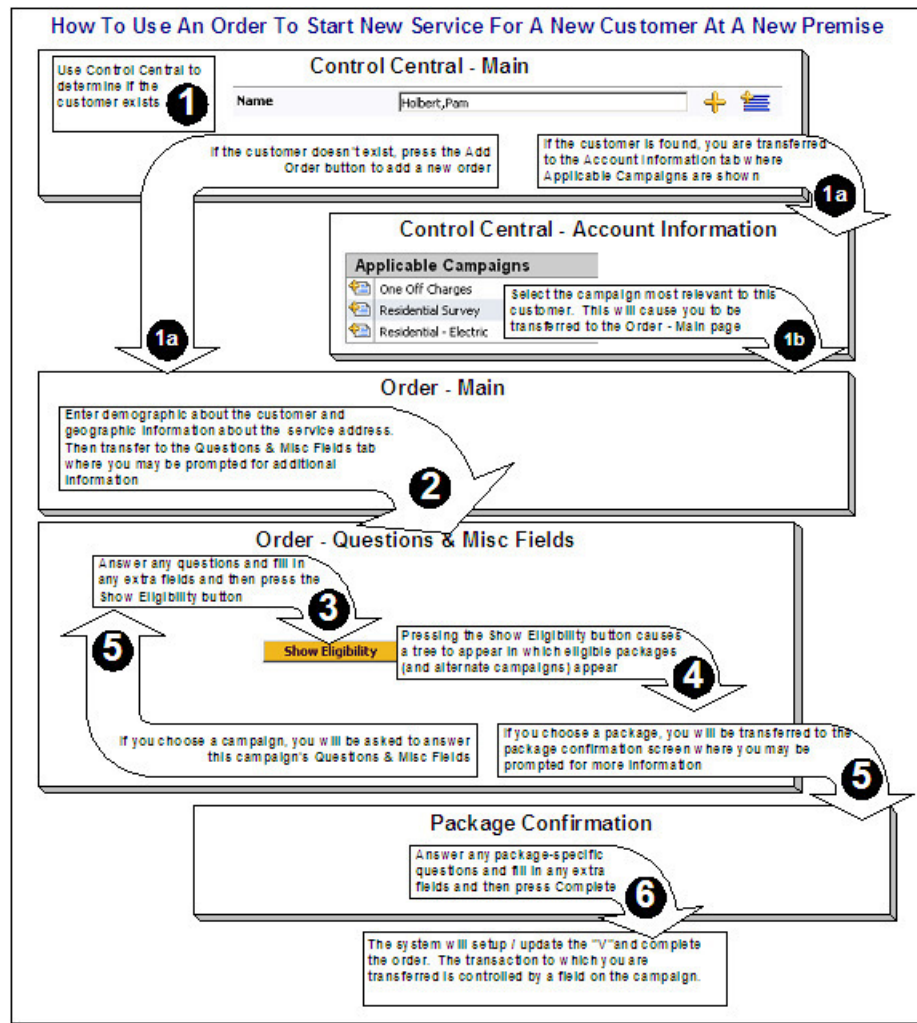

Order - Main

This page is used to define demographic and geographic information about the customer / prospect.

FASTPATH:

Refer to [The Big Picture of Campaigns, Packages and Orders](#) for more information about orders.

Open this page using **Menu > Sales & Marketing > Order > Search.**

FASTPATH:

Refer to [Order User Interface Flow](#) for information about how to use this page.

Description of Page

Order contains a concatenation of the customer's name, campaign, package (if the order is completed), status and start date. **Order ID** is the system-assigned unique identifier of the order. These values only appear after the order is added to the database.

Status contains the state of the order. Refer to [Lifecycle of an Order](#) for information about the valid values and the state transition rules. Additional information may also be displayed based on the status:

- If the order's status is Held, the following information is also displayed: the hold reason, the name of the user who held the order, and the date and time when a reminder for the order is due to be created.
- If the order's status is Canceled, the following information is also displayed: the cancel reason, the name of the user who canceled the order, and the date and time when the order was canceled.
- If the order's status is Complete, the following information is also displayed: the name of the user who completed the order and the date and time when the order was completed.

Press the **Hold** button to hold a Pending order. Refer to [Order - Hold Dialog](#) for a description of the pop-up window used to hold an order.

Press the **Cancel** button to cancel a Pending or Held order. Refer to [Order - Cancel Dialog](#) for a description of the pop-up window used to cancel an order.

If the **Campaign** has been setup to allow the completion of orders without selecting a package, a button appears to the right of **Cancel**. The label that appears in the button is defined on the **Campaign**. When pressed, the order is completed. When the order is completed,

- [The "V"](#) is setup / updated.
- All questions and miscellaneous fields (defined on the next tab) are posted to the appropriate object.
- [Optional plug-ins](#) are executed.
- You will be transferred to the order completion transaction that's defined on the **Campaign** (if any).

If the order references an existing person, account, or premise and the related person / account / premise has changed after their information was snapshot on the order, the **Out of Sync** section appears. This section highlights which objects have changed since the order was last saved. In addition, the **Sync** button appears. When pressed, the order is updated with the current field values for these objects.

An order's **Campaign** controls many aspects of the order's behavior. For example, it controls:

- The type of information defaulted onto an order.
- The eligibility-oriented questions that are displayed on the next tab.
- The superset of packages that can be offered to a customer.

- In addition to the above, campaigns also control high-level [eligibility rules](#) and [business process flows](#).

An order's **Campaign** is defaulted as follows:

- When you select a customer on [Control Central - Search](#), you are automatically transferred to the [Account Information](#) portal. One of the [zones](#) on this portal page contains the campaigns that can be offered to the customer. If you select a campaign from this zone, you are transferred to the [Order](#) transaction with the respective Campaign defaulted. Note, the Applicable Campaigns zone only appears if the CSR has modified their preferences to display this zone.
- In all other situations, the order's campaign defaults from the [Installation Record](#).

You may change an order's **Campaign** at will. Note that changing the campaign will result in the **Questions & Misc Fields** (the next tab) being refreshed with values associated with the new campaign. However, other values typically defaulted from the campaign (such as default customer class) do not get refreshed so that data you may have entered does not get overwritten.

Start Date defines the date on which service will start. This date becomes the start date on service agreements created when this order is completed. If you need to change the start date on these service agreements, transfer to [Start/Stop](#) (where all of the pending start service agreements will appear).

NOTE: Manual date entry is disabled on the start date and the date picker must be used when the Disable Manual Date Entry **Option Type** on the Customer Information Options [Feature Configuration](#) has been enabled.

The topics that follow describe the remaining sections on this page

Order - Main - Person Information

The **Person Information** section contains demographic information about the customer / prospect.

WARNING:

This page contains a subset of person-oriented information. If you need to define other person-oriented information, transfer to [Person - Main](#) after the order is completed.

If this is a new customer, select Create New Person and enter demographic information in the fields that follow. Otherwise, select Use Existing Person and use the **Name** field or press the search button to find the customer. After you select an existing person, the following events takes place:

- The person's name appears beneath the person search (and the person context menu can now be used to drill down to person-oriented pages). Note, the person's name is formatted by a plug-in algorithm on the [installation record](#). Refer to the base package's name format algorithm (PERS-INFO) for an example. If you prefer different formatting logic, your system administrator should configure the system appropriately.
- If any of the Questions & Misc Fields (on the next tab) are used to capture person-oriented characteristics, the person's existing characteristic values are defaulted.
- If the selected person has at least one account, information about the account is displayed in the **Account Information** section (if the **Campaign** makes uses of accounts). In addition, if any of the Questions & Misc Fields (the next tab) are used to capture account-oriented characteristics, the account's existing characteristic values are populated in the respective rows on this tab.
- Information about the person is displayed in the fields that follow.

Use **Person/Business** to indicate if the customer is a Person or a Business. This value controls how the person's primary name is validated. Note, for new customers, this value defaults based on the **Campaign**.

Names are used by [Control Central](#) when you look for a customer based on their name. In addition, a person's primary name is the addressee on the person's bill unless overridden by the **Override Mailing Name** (defined on [Person - Correspondence](#)

[Information](#)). To modify a name, simply move to a field and change its value. To add a new name, press + to insert a row, then fill in the information for each field. The following fields display:

- Use **Name Type** to indicate if the name is an Alias, Alternate Representation, Doing Business As, Legal, or Primary name. Note, for new persons, a value of Primary is defaulted.
- Use **Person Name** to define the person's name. Note well, the name is case sensitive.

NOTE:

Alternate representations of a person's name. You would use an Alternate Representation for a person's name when you have an alternate ways to define the person's primary name. Alternate representations are typically used in countries that use multiple character sets (e.g., the Primary name is entered in Chinese, the Alternate Representation is entered in English). When a person has an alternate name, both the main and alternate names can be used to search for a person. The Alternate Representation **Name Type** only appears if you have enabled alternate addresses on the installation record. Refer to the description of the Alternate Representation field under [Installation - Main](#) for more information.

Validation and formatting are performed by plug-ins. The validation that is applied to **Person Name** (e.g., a comma separating the last and first name - Smith,Patricia) is controlled by a plug-in algorithm on the [installation record](#). More than one algorithm can be plugged into this plug-in spot. Algorithms plugged into this plug-in spot can also perform formatting such as removing special characters that your implementation's business rules do not allow in person names. Other algorithms can be configured to remove or replace text.

-
- The **Do Not Format** switch can be used to bypass any person name formatting done by the algorithms described above. Validation such as requiring name separator is still applied, but no further formatting is applied. Setting the switch only applies while the record is being saved and is then reset. The switch is reset because the formatting is only applied when the record is subsequently changed. This switch is only shown if the Enable Person Name Format Bypass **Option Type** on the Customer Information Options [Feature Configuration](#) has been enabled

Person Contacts are used by Control Central to look for accounts and persons. For new customers, the person contact type(s) default based on the Campaign. To modify a person contact, simply move to a field and change its value. To add a new person contact, press + to insert a row, then fill in the information for each field. The following fields display:

- **Person Contact Type** indicates the type of contact such as, home phone, cell phone, or work email.
- **Contact Information** contains the specific contact information such as, the phone number or email address. Enter the contact information in the format described.

NOTE: Formatting is performed by a plug-in. The format that is applied to **Contact Information** is controlled by the algorithm that is plugged in on the respective person contact type (refer to Setting Up Person Contact Types for more information). If you prefer a different format, your system administrator should configure this algorithm appropriately.

-
- Enter the **Extension**, if any, of the contact information. (This field is only active when the contact's contact routing is phone or fax.)
 - The **Primary** switch must be set for exactly one person contact for each contact routing.
 - **Do Not Disturb (From)** and **Do Not Disturb (To)** indicate the times when a person contact should not be used. (**Note:** these fields are active when the Person Contact Type's Allow Do Not Disturb information is set to *Optional*.)

Phone numbers are used by [Control Central](#) to look for accounts and persons. For new customers, the phone type(s) default based on the **Campaign**. To modify a telephone number, simply move to a field and change its value. To add a new telephone number, press + to insert a row, then fill in the information for each field. The following fields display:

- **Phone Type** indicates the type of phone number, e.g., Home, Mobile, Business, ...
- Use **Phone Number** to define the telephone number. Enter the telephone number in the format described by the **Phone Format**.

NOTE:

Formatting is performed by a plug-in. The format that is applied to a **Phone Number** is controlled by the algorithm that is plugged in on the respective **Phone Type**. You can also have this plug-in convert input values into formatted values, e.g., this algorithm could transform all numbers into a formatted string. If you prefer a different format, your system administrator should configure this algorithm appropriately.

- Enter the **Extension**, if any, of the telephone number.

NOTE: The Person Phone grid appears when the Legacy Person Phone and Email Option Type on the Customer Information Options Feature Configuration has been enabled.

A person's **ID** has several uses:

- It is used by **Control Central** when you look for a customer / premise based on their ID.
- It is used to highlight potential duplicate persons.
- **Control Central** displays a person's primary identification in the search results area to help a user identify the customer when multiple customers match the search criteria.

The person ID usage flag on the **installation record** indicates whether or not at least one id for a person is required or optional. The ID Type defaults from the **installation record** based on the **Person Type** (Person versus Business). The following fields are used to define a customer's primary ID.

- Select the type of identification from the **ID Type** drop down.
- Enter the identification number in the **ID Number** field. Please note that if the ID number should be formatted (e.g., dashes in an American social security number), you do not have to include the delimiter (e.g. dashes). You can enter the ID number as a contiguous value and the system will format it for you. The format is shown adjacent to the **ID Number** field.

NOTE:

Formatting is performed by a plug-in. The format that is applied to a person ID number(e.g., dashes in an American social security number) is controlled by the algorithm that is plugged in on the respective **ID Type**. If you prefer a different format, your system administrator should configure this algorithm appropriately.

A person can have many forms of identification. The order transaction only caters for a single form of ID (as this is the most typical situation). If you want to specify additional person ID's, you must transfer to **Person - Main** after the person is created (persons are created when the order is saved).

Specify the customer's **Email ID** (if any).

NOTE: **EmailID** appears when the Legacy Person Phone and Email Option Type on the Customer Information Options Feature Configuration has been enabled.

Define the **Language** in which the person prefers their bills and correspondence printed.

NOTE:

Default note. The person's language defaults from **Installation Options - Person**.

FASTPATH:

Refer to **Customer Language** for more information on options for supporting multiple languages for your customers.

Use **Life Support / Sensitive Load** to indicate if the person has life support or sensitive load equipment. Valid values are: LS/SL (i.e., the person has life support / sensitive load equipment), None. If the customer has LS/SL equipment, make a note of the type of equipment in the **Life Support / Sensitive Load Notes**.

NOTE:

A premise can also have life support / sensitive load information. If the equipment is physically linked to the premise (e.g., a hospital has life support equipment), you should NOT specify the life support information on the person. Rather, after the premise is added, transfer to [Premise - Misc](#) and specify life support information on the premise.

Life support affects alerts and C&C. If life support / sensitive load information is specified, an alert will appear when the person is displayed on control central. In addition, if a person has life support or sensitive load equipment, it is possible for a different credit & collection severance process to be kicked off if the person's account associated has overdue debt. Refer to [Designing Your Severance Procedures](#) for more information.

Order - Main - Service Address

The **Service Address** section contains geographic information about the service address:

WARNING:

This page contains a subset of premise-oriented information. If you need to define other premise-oriented information, transfer to [Premise - Main](#) after the order is completed.

Whether or not a premise is required or even allowed on an order is controlled by an option on the **Campaign**. If the **Campaign** disallows the use of a premise, this section will be suppressed. If the **Campaign** allows the use of a premise, an indication of whether a premise is optional or required is displayed adjacent to **Service Address**.

If a premise is allowed on the order, use the dropdown at the top of this section to tell the system about this order's premise:

- Select No Premise Information if you do not want to associate a premise with this order (e.g., for a one-time charge).
- Select Create New Premise if this is a new premise. You should enter the new premise's address in the remaining fields in this section.
- Select Use Existing Premise if an existing premise should be used on the order. Use the **Address** and **City** fields or press the search button to find the premise. Refer to [Control Central - Search Facilities](#) for suggestions in respect of how to use these fields. After you select an existing premise, the following events takes place:
 - The premise's description appears beneath the premise search fields (and the premise context menu can now be used to drill down to premise-oriented pages).
 - If any of the Questions & Misc Fields (the next tab) are used to capture premise-oriented characteristics, the premise's existing characteristic values are defaulted.
 - Information about the premise is displayed in the fields that follow.

Use **Premise Type** to describe the type of service location.

The address's constituent fields vary based on the **Country**. Please refer to the [Country](#) page for more information.

Populate **Trend Area** if the **Postal** is blank. The **Postal** and the **Trend Area** cannot both be blank as the **Trend Area** is a required field on the premise and its value is typically defaulted from [postal defaults](#).

NOTE:

Default note. The values of several fields on this and the next page default based on the **Country** and the **Postal**. Refer to [Setting Up Premise & Service Point Postal Defaults](#) for more information. Also note, there are several premise-oriented fields that do not appear on this transaction that will be populated on the premise based on the **Country** and **Postal** (e.g., characteristics, time zone, trend area, geo ID's).

Use **CIS Division** to define the jurisdiction in which the premise is located.

Order - Main - Account Information

The **Account Information** section contains account-oriented information.

WARNING:

This page contains a subset of account-oriented information. If you need to define other account-oriented information, transfer to [Account - Main](#) after the order is completed.

Whether or not an account is required or even allowed on an order is controlled by an option on the **Campaign**. If the **Campaign** disallows the use of an account, this section will be suppressed. If the **Campaign** allows the use of an account, an indication of whether an account is optional or required is displayed adjacent to **Account Information**.

If an account is allowed on the order, use the dropdown at the top of this section to tell the system about this order's account:

- Select No Account Information if you do not want to associate an account with this order (e.g., for a person-oriented marketing survey).
- Select Create New Account if this is a new account. You should enter the new account's information in the remaining fields in this section.
- Select Use Existing Account if an existing account should be used on the order. If an existing person was selected above, one of the person's accounts (if any) will be automatically displayed in the **Account Information**. In addition, if the order references an existing person, the account search will be limited to accounts associated with this person. If an **Existing Account** is selected, the following takes place:
 - Basic information about the account appears beneath the search area (and the account context menu can now be used to drill down to account-oriented pages).
 - If any of the Questions & Misc Fields on the next tab are used to capture account-oriented characteristics, the account's existing characteristic values are defaulted.
 - Information about the account is displayed in the fields that follow.

If you have set the Installation Option CIS Division Control flag, you must define the new account's **CIS Division**. The values are restricted to the user's CIS Division(s). See Users and CIS Division for more information. The value is defaulted to user's primary CIS Division.

Customer Class plays a part in:

- If and when a customer is subject to late payment charges.
 - The account's default collection class and when the account debt monitor reviews an account. Refer to [The Big Picture of Credit & Collections](#) for more information about how and when an account's debt is reviewed.
 - And several other functions. Refer to [Setting Up Customer Classes](#) for more information.
-

NOTE:

Default note. For new accounts, the **Campaign** can default the **Customer Class**. If the campaign does not define a customer class, it can be defaulted from the CIS Division, if shown, or installation options.

The optional Account **Management Group** controls the roles assigned to To Do entries associated with an account. Refer to [Setting Up Account Management Groups](#) for more information.

NOTE:

Default note. For new accounts, **Management Group** defaults based on the **Campaign**.

The remaining fields are used to describe how the bill should be routed to the customer.

WARNING:

When an order is completed, several fields that do not appear on this page that reside on [Account - Person](#) are populated. For example, **Account Relationship Type**, **Bill Format**, **Number of Copies**, **Receives Notification** are all populated with default values. If you need to override the default values, transfer to [Account - Person](#) after the account is added.

Use **Bill Route Type** to define how the bill is sent to the customer. This field's value defaults from the [Installation Record](#). This value is important as it controls many options on the remainder of this page. If the **Bill Route Type** indicates that bills are routed via Fax, the person's fax number is displayed adjacent (the system knows which of a [person's phone numbers](#) is a fax number by the **Phone Type**). If the **Bill Route Type** indicates that bills are routed via Email, the person's **Email** address is displayed adjacent. If the **Bill Route Type** indicates that bills are routed via the Postal service, you must choose an appropriate **Address Source** to define which address should be used. Refer to [Setting Up Bill Route Types](#) for more information about bill route types.

If the **Bill Route Type** indicates that bills are routed via the Postal service, you must choose the appropriate **Address Source** to define which address should be used.

- Choose Mailing Premise on Account if bills should be sent to the address associated with the Mailing Premise on the first page. This address is displayed adjacent.
- Choose Person if bills should be sent to the [person's mailing address](#). This address is displayed adjacent.
- Choose Account Override if bills should be sent to an override address specified below. Typically, you would only choose this option if the person has multiple accounts and each account's bills should be sent to a different address.

If you select a **Address Source** of Account Override, you must enter the address to which bills will be sent in the following address constituents. The number and type of address constituents is based on the **Country** (refer to [Defining Countries](#) for more information on address constituents). These fields will be protected for other **Address Sources**. Note, the **Country** defaults from [Installation Options - System](#) and several other constituents default based on the **Country** and **Postal** if a [Postal Default](#) exists for the postal code.

NOTE:

By default, the **Address Source** field is protected on Order – Main page if the **Bill Route Type** is set to a value other than Postal. To enable the **Address Source** field for all **Bill Route Types** in most circumstances, set the Always Enable Address Source option type on the General System Configuration feature configuration to Y.

Regardless of the **Always Enable Address Source** option value, **Address Source** and **Address Information** are displayed but both are disabled when **Bill Routing Method** is *Not Postal* and **Quote Routing Method** (on Account – Persons page) is *Postal*. A message “*The Main Person receives Quotes at this address. To edit it, go to the 'Persons' tab on the Account.*” is displayed next to the **Address Source**.

Order - Questions & Misc. Fields

This page has several purposes:

- The order's Campaign can define questions to be posed to customers when an order is taken. For example, you could ask the customer "marketing survey" questions (e.g., please rate our service, how do you heat your home?, etc.). This page allows you to capture the customer's response.
- The order's Campaign can also be setup to capture additional fields to be updated on the order's person / account / premise when the order is completed. For example, you could indicate that the account's override due date and automatic payment options should be captured when an order is taken. This page allows you to capture these field values.

- The order's Campaign can also be setup to pose eligibility-oriented questions that qualify the customer for packages of goods and services. For example, you might have a campaign with packages that can only be selected if the customer commits to a year's worth of service. This page allows you capture the customer's response to these types of questions.
- After entering the above information (and the information on the Main page), you can use this page to select a package of goods and services for the customer.
- You can use this page to switch the campaign on the order (which would result in new questions and miscellaneous fields appearing).

FASTPATH:

Refer to [The Big Picture of Campaigns, Packages and Orders](#) for more information.

Open this page using **Sales & Marketing, Order** and then navigate to the **Questions & Misc Fields** tab.

FASTPATH:

Refer to [Order User Interface Flow](#) for information about how to use this page.

Description of Page

Order contains a concatenation of the customer's name, campaign, package (if the order is completed), status and start date. **Order ID** is the system-assigned unique identifier of the order. These values only appear after the order is added to the database.

Status contains the state of the order. Refer to [Lifecycle of an Order](#) for information about the valid values and the state transition rules. Additional information may also be displayed based on the status:

- If the order's status is Held, the following information is also displayed: the hold reason, the name of the user who held the order, and the date and time when a reminder for the order is due to be created.
- If the order's status is Canceled, the following information is also displayed: the cancel reason, the name of the user who canceled the order, and the date and time when the order was canceled.
- If the order's status is Complete, the following information is also displayed: the name of the user who completed the order and the date and time when the order was completed.

Press the **Hold** button to hold a Pending order. Refer to [Order - Hold Dialog](#) for a description of the pop-up window used to hold an order.

Press the **Cancel** button to cancel a Pending or Held order. Refer to [Order - Cancel Dialog](#) for a description of the pop-up window used to cancel an order.

If the **Campaign** has been setup to allow the completion of orders without selecting a package, a button appears to the right of **Cancel**. The label that appears in the button is defined on the **Campaign**. When pressed, the order is completed. When the order is completed,

- [The "V"](#) is setup / updated.
- All questions and miscellaneous fields (defined on the next tab) are posted to the appropriate object.
- [Optional plug-ins](#) are executed.
- You will be transferred to the order completion transaction that's defined on the **Campaign** (if any).

If the order references an existing person, account, or premise and the related person / account / premise has changed after their information was snapshot on the order, the **Out of Sync** section appears. This section highlights which objects have changed since the order was last saved. In addition, the **Sync** button appears. When pressed, the order is updated with the current field values for these objects.

The number and type of **Questions & Misc Fields** is controlled by the [Campaign](#).

NOTE:

Some questions can be suppressed. The campaign contains an indication if each question is account-oriented, person-oriented, premise-oriented or order-oriented. If the question is account-oriented and no account is defined on the **Main** tab, the question will be suppressed. If the question is premise-oriented and no premise is defined on the **Main** tab, the question will be suppressed.

Each row in this grid has a **Prompt** and a **Response**. The value of each **Prompt** is defined on the **Campaign**. The **Response** holds the answer supplied by the customer. Please note the following about the **Response** field:

- On a **Campaign**, you can indicate which questions / miscellaneous fields are required. The Response for a required field is prefixed with an asterisk - * .
- The value of a Response can default from a variety of sources:
 - If an existing person was selected on the **Main** page AND the response is used to capture a [person characteristic](#), the existing characteristic value will be defaulted.
 - If an existing premise was selected on the **Main** page AND the response is used to capture a [premise characteristic](#), the existing characteristic value will be defaulted. If no value exists, the characteristic values will default based on the postal defaults associated with the service address's **Country** and **Postal**.
 - If an existing account was selected on the **Main** page AND the response is used to capture an [account characteristic](#), the existing characteristic value will be defaulted.
 - Otherwise, the characteristic value is defaulted from the **Campaign**.
- The type of field used to capture a Response is controlled by the Campaign. Depending on the type of Response you may see [Go To](#) buttons and [Search](#) buttons.

After entering the **Responses** to the **Questions & Misc Fields**, press the **Show Eligibility** button.

The following may occur when this button is pressed:

- If a new customer is specified on the Main page, a warning will advise you that a new person will be added. The system needs to add a new person so that an audit of the customer interaction exists.
- The tree expands to show the Order - Eligibility Tree containing package, ineligible package, error package, and other campaign nodes:
 - Each **Package** node contains a package that is linked to the campaign whose [Eligibility Criteria](#) allows its selection by the customer. You can expand this node to see the various service agreements that will be created if you select the package. Selecting one of these packages causes the [Order - Package Confirmation](#) page to appear in which you can confirm your selection.
 - The **Ineligible Package(s)** node contains packages whose [Eligibility Criteria](#) prevents their selection by the customer.
 - The **Error Packages** node contains packages whose [Eligibility Criteria](#) have returned errors (if any).
 - The **other campaign(s)** node contains alternative campaigns that may be substituted for the current campaign on the package. Selecting one of these campaigns will cause the campaign to be changed on this order. Changing a campaign on an order will result in new questions and miscellaneous fields appearing. Refer to [The Big Picture Of Campaign Eligibility](#) for more information.

NOTE:

Some nodes can be suppressed. To increase page performance with large campaigns, you can define a [feature configuration](#) to suppress the display of the Ineligible Packages, Error Packages or Other Campaign nodes. If a node is suppressed, it does not appear on the eligibility tree and the system does not process the information necessary to display the node.

Order - Log

This page contains an audit trail of significant events that transpired in the history of this order.

Open this page using **Menu > Sales & Marketing > Order > Search** and navigate to the **Log** page.

Description of Page

Order contains a concatenation of the customer's name, campaign, package (if the order is completed), status and start date. **Order ID** is the system-assigned unique identifier of the order. These values only appear after the order is added to the database.

Status contains the state of the order. Refer to [Lifecycle of an Order](#) for information about the valid values and the state transition rules. Additional information may also be displayed based on the status:

- If the order's status is Held, the following information is also displayed: the hold reason, the name of the user who held the order, and the date and time when a reminder for the order is due to be created.
- If the order's status is Canceled, the following information is also displayed: the cancel reason, the name of the user who canceled the order, and the date and time when the order was canceled.
- If the order's status is Complete, the following information is also displayed: the name of the user who completed the order and the date and time when the order was completed.

Press the **Hold** button to hold a Pending order. Refer to [Order - Hold Dialog](#) for a description of the pop-up window used to hold an order.

Press the **Cancel** button to cancel a Pending or Held order. Refer to [Order - Cancel Dialog](#) for a description of the pop-up window used to cancel an order.

Campaign contains basic information about the order's campaign.

Package only appears if the order has been completed. It contains basic information about the package.

Start Date contains the date on which the service agreement's created by the order will be started.

The **Log** contains an audit trail of significant events that transpired in the history of this order. There are two types of entries in the log:

- The system automatically adds log entries when key events occur. These entries may not be removed or changed.
- Users may add log entries by pressing the + button and then specifying the Details.

Order - Package Confirmation

The Package Confirmation page allows you to check the package you selected before [the V](#) is created / updated for the customer. This page opens when you select a package from the eligibility tree on [Order - Questions & Misc Fields](#).

WARNING:

If you press the **Complete** button, a variety of objects may be created (service agreements, service points, a premise, an account, field activities, etc.). If you need to change any of these objects after order completion, you must transfer to the respective page on which the object is maintained. You can also use [Start/Stop](#) to make changes to the service agreements created by this transaction.

Description of Page

Order contains a concatenation of basic information about the order. **Order ID** is the system-assigned unique identifier of the order. These values only appear after the order is added to the database.

Campaign contains basic information about the order's campaign.

Package contains basic information about the package.

Premise is the address at which service will be delivered.

Person is the name of the customer.

Account is the name of the customer and their customer class.

Start Date contains the date on which the service agreement's created by the order will be started.

The **Questions & Misc Fields** grid contains the questions and miscellaneous fields that appeared on the order. Note well, it is possible to design a campaign and a package where some fields are optional on the campaign but required for a specific package. The **Response** of all required fields for the selected package are prefixed with an asterisk. Refer to [Order - Questions & Misc Fields](#) for information about the rows in this grid.

NOTE:

Changing your answers could cause the package to become ineligible. As described earlier, the fields you enter on an order play are what the system uses to determine if a package can be selected for a customer. If you change the answers to the **Questions & Misc Fields**, the package may no longer be eligible and an error will be presented to you. You will have the choice of reverting to the original answers or returning to the order page where you can select an eligible package.

Additional questions / misc fields are possible. It is possible to design a campaign where certain field values are only visible on specific packages. In this scenario, the **Questions & Misc Fields** grid may contain additional rows for a given package. Refer to [Designing Campaigns and Packages](#) for more information.

The **Instructions** grid contains package-specific suggestions. These instructions are defined on the [package](#).

The **Messages** grid contains system-generated messages that summarize what will happen if you press the **Complete** button.

Press the **Complete Order** button if you are satisfied with the information on the order. Otherwise, press **Do Not Use this Package** to change or cancel the order.

Order - Hold Dialog

The **Order - Hold** dialog opens if you press the **Hold** button on the order transaction. You use it to define why the order is being held and when you want to be reminded to check up on the order.

Description of Page

Use **Hold Reason** to define why the order is being held.

The following fields are used to control the [To Do entry](#) that will be created to remind you about this order.

- Use **Reminder Date / Time** to define the latest date on which the To Do entry should be created. The reason we indicated this should be the latest date is because the background process (TD-ECBK) that's responsible for creating these To Do entries has a parameter called "lead time". This parameter is used to define the number of days before the **Reminder Date** that the To Do entry should be created.
- If the To Do entry should be addressed to a group of users, choose a **ReminderType** of Send to Role and enter the user group's **To Do Role**. Note, the To Do Role will default from the order's campaign.
- If the To Do entry should be addressed to a specific user, choose a **ReminderType** of Send to User and enter the user's User ID in **To Do User**.
- **Log Notes** are used to describe why the order is being held. This information appears in the [log entry](#) that is created by the system when you hold an order.

If there are any To Do entries (with a status of Open or Being Worked On) that drill down to this order, a message is displayed indicating that existing To Do entries for this order will be completed. If the order is already in Hold status,

existing To Do entries are completed when you click the OK button and a new To Do entry is created when the background process responsible for creating the To Do entries runs.

Order - Cancel Dialog

The Order - Cancel dialog opens if you press the **Cancel** button on the order transaction. You use it to define why the order is being canceled.

Description of Page

Use **Cancel Reason** to define why the order is being canceled.

Use **Log Notes** to describe why the order is being canceled. This information appears in the [log entry](#) that is created by the system when you cancel an order.

Maintaining Campaigns

When you add an [order](#), you must reference its [campaign](#). An order's campaign controls:

- The type of information defaulted onto an order. For example, you can setup a campaign to default a given account management group on all orders linked to this campaign. This account management group will then default onto accounts created when the campaign's orders are completed.
- The eligibility-oriented questions that are posed to the customer when an order is taken. For example, the questions indicated above - Who is your current energy service provider? / Would you like to pay automatically? / What is your date of birth? - are all defined on the order's campaign.
- The superset of packages that can be offered to a customer whose order references this campaign. An order's campaign defines the types of packages that may be selected.
- In addition to the above, campaigns also control high-level [eligibility rules](#) and [business process flows](#).

The topics in this section describe the campaign transaction.

FASTPATH:

Refer to [The Big Picture of Campaigns, Packages and Orders](#) for general information about campaigns. Refer to [The Big Picture Of Campaign Eligibility Rules](#) for a discussion of how to control which campaigns can be used for different types of customers. Refer to [Designing Campaigns and Packages](#) for guidelines describing how to design your campaigns.

Lifecycle of a Campaign

The following diagram illustrates the lifecycle of a campaign.

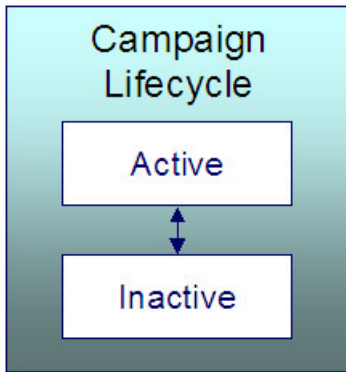

Active An Active campaign may have orders created in respect of it.

Inactive By Inactivating the campaign, you are preventing it from being used on future orders. In addition, Inactive campaigns do not appear in the [Applicable Campaigns](#) zone.

Campaign - Main

This page is used to define basic information about a campaign.

FASTPATH:

Refer to [The Big Picture of Campaigns, Packages and Orders](#) and [Designing Campaigns and Packages](#) for more information.

Open this page using **Menu > Sales & Marketing > Campaign > Search**.

Description of Page

Campaign is the user-defined code that uniquely identifies the campaign. The campaign's description appears adjacent.

Description briefly describes the campaign.

Campaign Status describes the state of the campaign. Refer to [Lifecycle of a Campaign](#) for more information.

The following fields contain values to be defaulted onto this campaign's orders. The user who takes the order may override these default values. Note well, these default values are only applicable for new persons - they will not override field values defined on existing persons.

- The system requires all persons to be defined as either a Person or a Business. Use **Default Person / Business** to define the default value for persons created by this campaign's orders.
- Every person contact defined for a person must reference a person contact type. Use **Default Person Contact Type 1**, **Default Person Contact Type 2**, and **Default Person Contact Type 3** to define the first three [person contact type](#) defaults for persons created by this campaign's orders.

NOTE: Person Contact Types appears when the Legacy Person Phone and Email Option Type on the Customer Information Options Feature Configuration has **not** been enabled

- Every phone number defined for a person must reference a [phone type](#). Use **Default Phone Type 1** and **Default Phone Type 2** to define the first two phone types defaults for persons created by this campaign's orders.

NOTE: Phone Types appears when the Legacy Person Phone and Email Option Type on the Customer Information Options Feature Configuration has been enabled.

Premise Usage controls if and how this campaign's orders use premises. You have the following options:

- Select Not Allowed if this campaign's orders do not reference a premise.
- Select Optional if this campaign's orders do not have to reference a premise. This option also means that a new OR existing premise may be specified on the order. Note, if an order references a new premise, the premise will be created when the order is completed.
- Select Optional - Existing Premise Only if this campaign's orders do not have to reference a premise. This option also means that only an existing premise may be specified on an order.
- Select Required if this campaign's orders must reference a premise. This option also means that a new OR existing premise may be specified on the order. Note, if an order references a new premise, the premise will be created when the order is completed.
- Select Required - Existing Premise Only if this campaign's orders must reference a premise. This option also means that only an existing premise may be specified on an order.

The following fields contain values to be defaulted onto this campaign's orders. The user who takes the order may override these default values. Note well, these default values are only applicable for new premises - they will not override field values defined on existing premises.

- The system requires all premises to reference a [premise type](#). Use **Default Premise Type** to define the default value for premises created by this campaign's orders.
- Every geographic ID defined for a premise must reference a [geographic type](#). Use **Default Premise Geo Type** to define the default value for premises created by this campaign's orders. Refer to [Premise Geographic Types Are Populated In An Unusual Way](#).

Account Usage controls if and how this campaign's orders use accounts. You have the following options:

- Select Not Allowed if this campaign's orders do not reference an account.
- Select Optional if this campaign's orders do not have to reference an account. This option also means that a new OR existing account may be specified on the order. Note, if an order references a new account, the account will be created when the order is completed.
- Select Optional - Existing Account Only if this campaign's orders do not have to reference an account. This option also means that only an existing account may be specified on an order.
- Select Required if this campaign's orders must reference an account. This option also means that a new OR existing account may be specified on the order. Note, if an order references a new account, the account will be created when the order is completed.
- Select Required - Existing Account Only if this campaign's orders must reference an account. This option also means that only an existing account may be specified on an order.

The following fields contain values to be defaulted onto this campaign's orders. The user who takes the order may override these default values. Note well, these default values are only applicable for new accounts - they will not override field values defined on existing accounts.

- The system requires all accounts to belong to a [customer class](#). Use **Default Customer Class** to define the default value for accounts created by this campaign's orders.
- An account may reference an [account management group](#). Use **Default Acct Management Group** to define the default value for accounts created by this campaign's orders.

If a user [holds](#) one of the campaign's orders, they can have a [To Do entry](#) generated on a future date to remind them about the order. Use **Default Hold To Do Role** to define the [group of users](#) to whom the To Do entry will be sent. Note well, the user who holds an order can indicate that the related To Do entry should be addressed to a specific user ID rather than a **Role**.

Use **Order Open Option** to define the page that is displayed when a user adds a new order for this campaign. This field is only relevant when the order transaction is invoked in "add mode" and a campaign is passed to this transaction (e.g., if a user adds an order from the [Applicable Campaigns Zone](#)).

A user can be automatically transferred to a different transaction when they complete an order. Refer to [Supported Business Processes](#) for examples of transactions that we anticipate being used. Use **Navigation Option** to define this transaction. Note,

- Leave **Navigation Option** blank if the user should remain on the order transaction after completion.
- You can setup **Navigation Options** to transfer to the user to a tab other than the main tab.

If a user is allowed to complete this campaign's order's without selecting a package,

- Turn on **Allow Order Compl w/o Package** and
- Use **Order Compl w/o Package Label** to define the message to appear in the button used to complete such orders.

FASTPATH:

Refer to [Campaigns Without Packages](#) for examples of campaigns where you would enable the above fields.

Use **Long Description** to provide an overview of this campaign.

The grid at the bottom of the page summarizes this campaign's questions and miscellaneous fields. To change this information, press the adjacent go to button (which will transfer you to the [Questions and Misc Fields](#) tab). To add additional information, transfer to the [Questions and Misc Fields](#) tab and press the + button.

Campaign - Questions and Misc. Fields

This page is used to define the following type of information:

- An order's campaign can define questions to be posed to customers when an order is taken. For example, you could ask the customer "marketing survey" questions (e.g., please rate our service, how do you heat your home?, etc.).
- An order's campaign can also be setup to capture additional fields to be updated on the order's person / account / premise when the order is completed. For example, you could indicate that the account's override due date and automatic payment options should be captured when an order is taken.
- An order's campaign can also be setup to pose eligibility-oriented questions that qualify the customer for packages of goods and services. For example, you might have a campaign with packages that can only be selected if the customer commits to a year's worth of service.

FASTPATH:

Refer to [Designing Campaigns and Packages](#) for information describing how to design this type of information for your campaigns.

Open this page using **Sales & Marketing, Campaign** and navigate to the **Question & Misc Fields** tab.

Description of Page

WARNING:

This information is not intuitive; we strongly recommend that you follow the guidelines under [Designing Campaigns and Packages](#) before attempting to enter this information.

Campaign is the user-defined code that uniquely identifies the campaign. The campaign's description appears adjacent.

The **Questions & Misc Fields** scroll contains one row for each question / miscellaneous field captured on this campaign's orders. The following fields are used:

- **Prompt on Order** contains the prompt that is shown to the user when the **order** is taken. Refer to [Determine The Properties Of Every Miscellaneous Field](#) for examples.

- **Brief Description** is simply a brief description of the question / miscellaneous field.
- **Sort Sequence** controls the order in which the question appears on the order.
- **Applicability** controls whether the field is Optional , Required, or Only Applicable on Package.
 - A value of Required means the order taker must enter a valid value before packages are displayed for selection.
 - A value of Optional means the order taken can leave the field blank prior to package selection. You can make an Optional field Required on individual packages.
 - A value of Only Applicable on Package is used for fields that are only captured for specific packages. Fields of this type are suppressed prior to package selection. When you setup a [package](#), you indicate if the field is applicable (if so, the user is only prompted for the field if the package is selected).
- **Type of Response** controls where the field is stored when the order is completed and how it is validated. You have two options: Characteristic or Column.
 - If a field is a Characteristic, you must define which entity the characteristic value is to be stored on when the order is completed (Person, Account, Premise or Order). You must also define the **Characteristic Type** as this controls the characteristic value entered by the user.
 - If a field's value resides in a Column (as opposed to a characteristic value), you must define the [column reference](#). A field's **Column Reference** controls three things:
 - How the field's value is retrieved. A field's value is retrieved when an existing person / account / premise is referenced on an order.
 - How the field's value is validated. A field's value is validated before package eligibility is determined and before the order is completed.
 - How the field's value is posted (i.e., updated on the database). A field's value is posted when an order is completed.

FASTPATH:

Refer to [Extract Column References From Miscellaneous Fields](#) for more information about column references.

- If a field's value resides in a Column (as opposed to a characteristic value), you must also define whether the question / field is dependent on the order referencing an account or premise. You do this by populating **Question Dependency** with one of the following values:
 - Select Must Have Account if this question / field should only appear if the order references an account (new OR existing).
 - Select Must Have Premise if this question / field should only appear if the order references a premise (new OR existing).
 - Select No Dependency if this question / field should always appear.

FASTPATH:

Refer to [Determine Account / Premise Dependencies For Column References](#) for more information.

- **Default Column Value / Default Char Value** controls whether the order taker is supplied with a default value when an order is created. Note well: for Optional and Only Applicable on Package fields, you can specify a different default value on each package.

Campaign - Algorithms

This page defines plug-in algorithms that are executed for orders associated with this campaign. Open this page using **Menu** > **Sales & Marketing** > **Campaign** > **Search** and navigate to the **Algorithms** page.

Description of Page

Campaign is the user-defined code that uniquely identifies the campaign. The campaign's description appears adjacent.

The grid contains **Algorithms** that control campaign-oriented functions. You must define the following for each plug-in algorithm:

- Specify the **System Event** with which the algorithm is associated (see the table that follows for a description of all possible events).
- Specify the **Sequence** and **Algorithm** for each **System Event**. You can set the **Sequence Number** to 10 unless you have a **System Event** that has multiple **Algorithms**. In this case, you need to tell the system the **Sequence** in which they should execute.

You can define algorithms for the following **System Events**:

System Event	Optional / Required	Description
Campaign Eligibility	Required	<p>A campaign's eligibility algorithms control two things:</p> <ul style="list-style-type: none"> - Whether the campaign appears in the Applicable Campaigns Zone. This content zone suggests possible campaigns for the current customer displayed on control central. You might want to use this zone if you have different campaigns that are offered to different types of customers. Refer to Real-time Marketing of Additional Services to a Customer for an example of how this content zone can be used to "up sell" additional services. - Whether the campaign appears on an order's eligibility tree. Campaigns that appear in this tree are alternate campaigns that may be used on an order. Refer to Real-time Marketing of Services to a Prospect for an example of how an order's eligibility tree can contain alternate campaigns for an order. <p>Refer to The Big Picture Of Campaign Eligibility for information about these algorithms.</p>
Order Completion	Optional	<p>When an order is completed for this campaign, algorithms plugged into this spot are called to do additional work (e.g., create a customer contact). You need only specify this type of algorithm if you require additional work to be performed when an order is completed for this campaign.</p>

Campaign - Package

A package controls the various types of service agreements that will be created if the customer selects the package. This page summarizes all packages that may be selected on orders associated with this campaign. Open this page using **Menu > Sales & Marketing > Campaign > Search** and navigate to the **Package** page.

Description of Page

Campaign is the user-defined code that uniquely identifies the campaign. The campaign's description appears adjacent.

The grid contains an entry for every package associated with this campaign. To view or change a package, press the adjacent go to button (which will transfer you to [Package - Main](#)). To add a new package, use the **Campaign** context menu to transfer to [Package - Main](#) in add mode.

Maintaining Packages

After a user enters basic information about a customer on an [order](#), they are shown the various packages that may be offered to the customer. A package controls the various types of service agreements that will be created if the customer selects the package.

If the customer elects to take a package, the system sets up / updates the "V" (along with all of the ancillary things that happen when service is initiated, e.g., field activities are created).

The topics in this section describe the package transaction.

FASTPATH:

Refer to [The Big Picture of Campaigns, Packages and Orders](#) for general information about packages. Refer to [The Big Picture Of Package Eligibility Rules](#) for a discussion of how to control which packages can be used for different types of customers. Refer to [Designing Campaigns and Packages](#) for guidelines describing how to design your packages.

NOTE:

An order can be completed without selecting a package. It is possible to use the order transaction to simply create / update persons and accounts. Refer to [Campaigns Without Packages](#) for more information.

Lifecycle of a Package

The following diagram illustrates the lifecycle of a package.

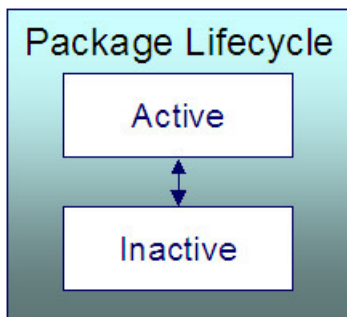

Active An Active package may be selected on an order.

Inactive By Inactivating a package, you are preventing it from being selected on future orders.

Package - Main

This page is used to define basic information about a package.

FASTPATH:

Refer to [The Big Picture of Campaigns, Packages and Orders](#) and [Designing Campaigns and Packages](#) for more information.

Open this page using **Menu > Sales & Marketing > Package > Search**.

Description of Page

Package contains a concatenation of basic information about the package. **Package ID** is the system-assigned unique identifier of the package. These values only appear after the order is added to the database.

Use **Campaign** to define the campaign to which this package belongs.

Use **Description** and **Long Description** to describe the package.

Status defines the state of the package. Refer to [Lifecycle of a Package](#) for information about the valid values and the state transition rules.

The tree at the bottom of the page summarizes the information that appears on the remaining tabs. You can click on a hyperlink to transfer you to the appropriate tab with the relevant information displayed.

Package - SAs To Create

This information on this page controls the type of service agreement(s) / service point(s) that are created if this package is selected on an order.

FASTPATH:

Refer to [The Big Picture of Campaigns, Packages and Orders](#) and [Designing Campaigns and Packages](#) for more information.

Open this page using **Sales & Marketing, Package** and navigate to the **SAs To Create** tab.

Description of Page

Package contains a concatenation of basic information about the package. **Package ID** is the system-assigned unique identifier of the package. These values only appear after the order is added to the database.

WARNING:

This following information is not intuitive; we strongly recommend that you follow the guidelines under [Designing Campaigns and Packages](#) before attempting to enter this information.

The **SAs To Create** scroll contains one row for every service agreement that will be created if this package is selected on an order. The following fields are used:

- **CIS Division** and **SA Type** define the [type of service agreement](#) to be created.
- **Start Option** controls how the system will populate the new service agreement with default values. Refer to [start options](#) for more information.
- **SP Type** defines the type of service point that will be created / reused. Refer to [Designing SP Types](#) for more information.
- **Start Method Algorithm** controls how the system creates the new service agreement and service point. Refer to [Determine The Method Used To Create Service Agreements](#) for more information.
- **Create Proposal SA** controls if the new service agreement is a real or a proposal SA. This switch only appears if the quotation Contract Management module is not [turned off](#). Refer to [Proposal Service Agreements Must Exist](#) for more information.

Package - Questions & Misc Fields

It is possible to design a campaign so that the user is prompted for additional information when a package is selected on an order. This page is used to define how the package overrides the questions and miscellaneous fields defined on the [campaign](#).

FASTPATH:

Refer to [The Big Picture of Campaigns, Packages and Orders](#) and [Designing Campaigns and Packages](#) for more information.

Open this page using **Menu > Sales & Marketing > Package > Search** and navigate to the **Questions & Misc Fields** page.

Description of Page

Package contains a concatenation of basic information about the package. **Package ID** is the system-assigned unique identifier of the package. These values only appear after the order is added to the database.

Campaign contains a concatenation of basic information about the campaign.

WARNING:

The following information is not intuitive; we strongly recommend that you follow the guidelines under [Designing Campaigns and Packages](#) before attempting to enter this information.

The grid contains one row for every [Questions & Misc Field](#) defined on the **Campaign**. You need only modify this information if this package behaves differently than the campaign (e.g., a field is required on the package, but optional on the campaign). To override a field on this package, turn on the **Override** switch and change the appropriate fields. There are several restrictions in respect of what can be overridden as described below:

- If a question / miscellaneous field is Required on the campaign, no fields may be overridden on the package.
 - If a question / miscellaneous field is Optional on the campaign, you may override all field values. However, if the package has been used on a Completed order, you may not change its **Applicability** to be Required.
 - If a question / miscellaneous field is designated as only applicable on package on the campaign, you should designate its applicability as Required, Optional or Not Used On This Package. If the field is either Required or Optional on this package, you may also override the other field values. Please note that if the package has been used on a Completed order, you may not change its **Applicability** to be Required.
-

FASTPATH:

Please refer to the Description of Page that appears under [Campaign - Questions & Misc Fields](#) for a description of the fields on the page.

Package - Eligibility

This page is used to define the conditions under which a package can be selected on an order.

FASTPATH:

Refer to [The Big Picture Of Package Eligibility](#) and [Determine Package Eligibility Rules](#) for more information.

Open this page using **Menu > Sales & Marketing > Package > Search** and navigate to the **Eligibility** page.

Description of Page

Package contains a concatenation of basic information about the package. **Package ID** is the system-assigned unique identifier of the package. These values only appear after the order is added to the database.

WARNING:

The following information is not intuitive; we strongly recommend that you follow the guidelines under [The Big Picture Of Package Eligibility](#) and [Determine Package Eligibility Rules](#) before attempting to enter this information.

The **Eligibility Criteria Group** scroll contains one entry for each group of eligibility criteria. The following fields may be defined for each group:

- Use **Sequence** to control the relative order in which the group is executed when the system determines if the package can be selected on an order (smaller numbers are executed before larger numbers).
- Use **Description** and **Long Description** to describe the criteria group.
- Use **If Group is True** to define what should happen if the eligibility criteria (defined in the following grid) return a value of True.
 - Choose Eligible if this package can be selected on the order.
 - Choose Ineligible if this package cannot be selected on the order.
 - Choose Check Next Group if the next criteria group should be checked.
- Use **If Group is False** to define what should happen if the eligibility criteria (defined in the following grid) return a value of False.
 - Choose Eligible if this package can be selected on the order.
 - Choose Ineligible if this package cannot be selected on the order.
 - Choose Check Next Group if the next criteria group should be checked.

The grid that follows contains the package's eligibility criteria. Think of each row as an "if statement" that can result in the related eligibility group being True or False. For example, you might have a row that indicates the customer is eligible for the package if their customer class is residential. The following bullets provide a brief description of each field on an eligibility criterion. Please refer to [Defining Logical Criteria](#) for several examples of how this information can be used.

- Use **Sequence** to control the order in which the criteria are checked.
- Use **Criteria Field** to define the field to compare:
 - Choose Field if you want to compare a response to a question / miscellaneous field to a given value. Push the adjacent search button to select the field.
 - Choose Algorithm if you want to compare anything other than a response to a question / miscellaneous field. Push the adjacent search button to select the algorithm that is responsible for retrieving the comparison value.
- Use **Criteria Comparison** to define the method of comparison:
 - Choose Algorithm if you want an algorithm to perform the comparison and return a value of True, False or Insufficient Data.
 - Choose any other option if you want to compare the **Criteria Field Type** using a logical operator. The following options are available:
- Use >, <, =, >=, <=, <> (not equal) to compare the **Criteria Field Type** using standard logical operators. Enter the comparison value in the adjacent field.
- Use In to compare the **Criteria Field Type** to a list of values. Each value is separated by a comma. For example, if a field value must equal 1, 3 or 9, you would enter a comparison value of 1,3,9.
- Use Between to compare the **Criteria Field Type** to a range of values. For example, if a field value must be between 1 and 9, you would enter a comparison value of 1,9. Note, the comparison is inclusive of the low and high values.

- The next three fields control whether the related logical criteria cause the eligibility group to be considered True or False:
 - Use **If True** to control what happens if the related logical criterion returns a value of True. You have the options of Group is true, Group is false, or Check next condition. If you indicate Group is true or Group is false, then the package will be judged Ineligible or Eligible based on the values defined above in **If Group is False** and **If Group is True**.
 - Use **If False** to control what happens if the related logical criterion returns a value of False. You have the options of Group is true, Group is false, or Check next condition. If you indicate Group is true or Group is false, then the package will be judged Ineligible or Eligible based on the values defined above in **If Group is False** and **If Group is True**.
 - Use **If Insufficient Data** to control what happens if the related logical criterion returns a value of "Insufficient Data". You have the options of Group is true, Group is false, or Check next condition. If you indicate Group is true or Group is false, then the package will be judged Ineligible or Eligible based on the values defined above in **If Group is False** and **If Group is True**.

Package - Instructions

This page is used to define special instructions that should be presented to the user when they select this package. This information appears on the [Order - Package Confirmation](#) page.

FASTPATH:

Refer to [Determine If Additional Instructions Are Needed](#) for more information.

Open this page using **Menu > Sales & Marketing > Package > Search** and navigate to the **Instructions** page.

Description of Page

Package contains a concatenation of basic information about the package. **Package ID** is the system-assigned unique identifier of the package. These values only appear after the order is added to the database.

The grid contains a row for each instruction to be presented to the user when they select a package. The following fields are used:

- Use **Sort Sequence** to control the relative order of the instruction.
- Use **Display Icon** to control the icon that prefixes the instruction. Refer to [Display Icons](#) for more information.
- Use **Description** to define the text of the instruction.

The Big Picture of Program Management

The program management functionality satisfies many diverse requirements. For example, you can use this functionality to:

- Market your products and/or services to customers and measure the success of your efforts.
- Encourage customers to enroll in various sales and marketing initiatives. For example, you can use program management to organize a campaign to encourage customers to participate in a conservation program, or to sign up for special contract options.
- Set up marketing surveys and record your customer's responses.
- Assign representatives to accounts.
- And more...

The topics in this section provide more information about the program management functionality.

The Big Picture of Initiatives, Leads, and Representatives

Three objects are at the heart of the program management functionality: **Initiatives**, **Leads**, and **Representatives**.

- An **initiative** defines a structured campaign that outlines the efforts to encourage customers to participate in a program targeted at a specific market segment.
- A **lead** is an instance of an initiative for targeted customers.
- There are two types of Representatives:
 - A **Sales Representative** is a user or group of users who can be assigned to follow up or manage leads. This representative is also responsible to sell or encourage the customer to participate in a program.
 - A **Third Party Representative** is a third party (typically external) who can receive assignments to perform specific tasks within a lead; such as, undertaking a visit to a property to perform an inspection, and installation work)

The topics in this section provide background information about these objects.

The Big Picture of Initiatives

An initiative defines a structured campaign designed to encourage customers to participate in a program. An initiative can:

- Target a market segment by specifying criteria that must be satisfied before leads are generated for customers.
- Ensure that customers are still eligible to participate in a program at sign up or enrollment time.
- Define a structured marketing effort for the events or actions that should take place during the life of a lead to encourage a customer to participate in the program.
- Define whether the lead is related to other objects (such as, the premise) in addition to the account.
- Contain sub-initiatives. Together, an initiative and its subsidiary initiatives form an initiative hierarchy. This supports reporting purposes and the analysis of the success of different market segments and marketing efforts.

Refer to [Maintaining Initiatives](#) for more information.

About Initiative Hierarchies

Initiatives form an initiative hierarchy when one initiative is configured as a sub-initiative to a parent initiative. An initiative hierarchy can be used when a program is targeted at several market segments, or when different market segments each require a unique marketing effort to be executed. Initiative hierarchies can be up to five levels deep.

The following is a general example of a multi-level initiative hierarchy:

- Level 1 could be a “strategy” initiative.
- Level 2 could contain multiple campaigns. Each campaign can have a different way of marketing the strategy.
- Level 3 could define multiple marketing efforts. Each effort can have a different method for marketing the campaign.
- Level 4 could contain market segments that are the targets of a marketing effort.

NOTE: The terms used above are just for the example. Your implementation would define the actual terms used for the levels in an initiative hierarchy.

A **parent initiative** may be set up for reporting purposes, in which case you could choose to configure the initiative so that no leads are generated for it. For example, a “strategy” may not have eligibility criteria or lead event type profile defined against it. It may simply have sub-initiatives to define segments, and those segments could be the initiatives for which leads

are generated. Reporting is able to be performed at the multiple levels in order to summarize the effectiveness of the sub-initiatives.

The Components of an Initiative

The topics in this section provide information about the components of an initiative.

About Initiative Eligibility Criteria

Each initiative can define its target market by specifying the criteria that must be satisfied before a customer is invited to participate in a program. It can also confirm that the customer is still eligible to participate in a program at sign up or enrollment time. An initiative may have zero, one, or many eligibility criteria. Each customer is subjected to these criteria to determine whether they will have a lead generated for them for the initiative and/or whether they are still eligible to sign up or enroll into a program.

Designing these criteria can be easy or time-consuming; it all depends on the complexity of your business rules. The base product provides a number of initiative eligibility criteria types. Most of them perform comparisons based on a specific field; for example, one of the criteria types checks whether an account has submitted a rebate claim for a specific conservation program. Some types of eligibility criteria could simply check whether or not a specific condition is true. For instance, a base-supplied eligibility criteria business object checks that there is no active credit and collection process for the account.

Other types of eligibility criteria perform comparisons with scalar values (such as, a number of days, number of kwh) or with derived values (such as, attributes of an account). The base product provides a Freeform Criteria business object that can be used for these purposes. This business object provides flexibility in that the value to supply in the comparison field is driven by a Derive Value Algorithm Type. A number of these algorithm types are delivered with this business object. Your implementations can add to these algorithm types as needed.

Your implementation can decide to use specific criteria business objects (base-supplied and/or implementation-specific), extend the base-supplied Freeform Criteria business object, or a mixture of both. Refer to [Designing Initiative Eligibility Criteria](#) for more details.

To set up an eligibility criterion, you must define the following:

- When the eligibility criterion should be executed - also called criteria execution point
- The field to be compared
- The comparison method

For the **criteria execution point**, the options include:

- Prior to a lead being generated for a customer
- Prior to the customer being signed up or enrolled into a program
- Both of the above

For the **field to be compared**, you can execute an algorithm to:

- Retrieve a field value or values from someplace else in the system (such as, the customer class or types of services associated with the customer)
- Derive a value based on some data from someplace else in the system (such as, the number of days since the last lead was created for the customer)

For the **comparison method**, you select the operator to perform the comparison on the field to be compared. The result from the algorithm will be TRUE, FALSE, or INSUFFICIENT DATA. Each of these results should specify the next action. The valid actions include:

- Indicate that the customer is eligible
- Indicate that the customer is not eligible

- Check the next condition
- Issue an error (this option is only available for Insufficient Data)

Refer to [Defining Eligibility Criteria for an Initiative](#) for more information about setting up eligibility criteria on an initiative.

About Related Object Criteria

Each initiative can define its target market by specifying the criteria that must be satisfied before a customer is invited to participate in a program (see [About Initiative Eligibility Criteria](#) for more information). An initiative may also be targeted at a specific entity (or related object) for that customer; for example, assume a customer has two properties in two different states - one in State A and one in State B. The customer may only be invited to participate, or be eligible, for a program for their specific property located in State A. In this situation, each eligible customer may then be subjected to Related Object Criteria following the execution of Initiative Eligibility Criteria to determine which of their properties are eligible to participate in a program (meaning, have one lead generated just for the account if one of their properties meets the criteria or a lead generated for each of the customer's eligible properties).

An initiative defines the related object(s) to associate with leads via the Object Nomination algorithm on the initiative business object. The lead generation process executes the object nomination algorithm after executing initiative eligibility criteria. The base-supplied Initiative parent business object (C1-Initiative) is configured with an object nomination algorithm that retrieves the premises that are associated with the account's active and pending start service agreement's service points. The algorithm applies the related object criteria (configured on the initiative) to each premise and if the premise is deemed eligible, it is returned as a related object for the lead.

Designing related object criteria can be easy or time-consuming. It all depends on the complexity of your business rules. The base product provides examples of related object criteria that looks for one or more premises to associate with a lead. One example checks for premises with a specific service point type. Another looks for a premise using its geographic value. For additional ways to find premises to link to a lead, implementations can either add specific related object criteria business objects (similar to the base samples) or extend the base-supplied Freeform Premise Criteria business object. The Freeform Premise Criteria business object provides flexibility in that the value to supply in the comparison field is driven by a Derive Value Algorithm Type. A number of these algorithm types are delivered with this business object. Your implementation can add to these algorithm types as needed. Refer to [Designing Related Object Criteria](#) for more details.

When you set up a related object criterion, you must define two things:

- The field to be compared.
- The comparison method.

For the **field to be compared**, you can execute an algorithm to retrieve a field value or values from someplace else in the system; for example, retrieve a premise's service point types for which the customer has service.

For the **comparison method**, select the operator to perform the comparison on the field to be compared. The result from the comparison will be TRUE, FALSE, or INSUFFICIENT DATA. Each of these results should specify the next action. The valid actions include:

- Indicate that the related object is eligible
- Indicate that the related object is not eligible
- Check the next condition
- Issue an error

Refer to [Defining Related Object Criteria for an Initiative](#) for more information.

Examples of Initiative Criteria

The following is an example of how to set up initiative criteria.

Initiative: Smart Rate Program For Residential Customers

The program targets summertime pricing for residential customers. Customers are required to reduce energy use between 2 PM and 7 PM for no more than 15 summer days, which are referred to as smart days. A higher rate is charged during this time period. A discounted rate is applied for all other times during the season.

Initiative Eligibility Criteria

To be eligible for this initiative, the account must be a residential account with an average daily usage that is more than 10 kWh, not currently on a smart rate program, and is on either the ERES1 or ERES2 rate schedule. The account must also not have any active credit and collection process.

Sequence	Description	Criteria Field Algorithm	Operator	Comparison Value	If True	If False	If Insufficient Data	Criteria Execution Point
10	Residential customers	Retrieve Customer Class (Define an algorithm instance for base algorithm type C1-ICGETACEL, Retrieve account attribute)	=	R	Check next condition	Not Eligible	Not Eligible	Both (lead generation and enrollment)
20	Average daily usage > 10 kWh	Retrieve average daily kWh usage (Define an algorithm for base algorithm type C1-ICGETAVSQ, Retrieve average service quantity)	>	10	Check next condition	Not Eligible	Not Eligible	Both (lead generation and enrollment)
30	Not on a smart rate program	Retrieve all contract options (Use base algorithm C1-ICGETCOPT)	=	295076574659 (Contract option for smart day events)	Not Eligible	Check next condition	Not Eligible	Both (lead generation and enrollment)
40	Account is current	Check if Account Is Current (Use base	=	true	Check next condition	Not Eligible	Not Eligible	Both (lead generation and enrollment)

Sequence	Description	Criteria Field Algorithm	Operator	Comparison Value	If True	If False	If Insufficient Data	Criteria Execution Point
		algorithm C1-ICCHKACCU)						
50	Active service on eligible rate	Retrieve all active rates (Use base algorithm C1-GETACTVRT)	IN	ERES1, ERES2	Eligible	Not Eligible	Not Eligible	Both (lead generation and enrollment)

Related Object Criteria

If the account is eligible, the premise(s) associated with the account's active and pending start service agreement's service points of type E-RES will be linked to the lead as related object(s).

Sequence	Description	Criteria Field Algorithm	Operator	Comparison Value	If True	If False	If Insufficient Data
10	Premises with E-RES (electric residential) service points	Retrieve Premise SP Types (Base algorithm C1-ICPRMSPTY)	=	E-RES	Eligible	Not Eligible	Not Eligible

About the Lead Event Type Profile

Each initiative can define a structured marketing effort for the events or actions that should take place during the life of a lead to encourage a customer to participate in a program. Each event or action is defined by a Lead Event Type. For example, one event could be that a letter or an email is sent to a customer. The collection and sequencing of lead event types defined on an initiative is referred to as the Lead Event Type Profile.

Refer to [Creating Initiatives](#) and [Maintaining Initiatives](#) for more information on setting up and maintaining the Lead Event Type Profile on an initiative.

About the Initiative Log

Every initiative has a log holding its history. Entries are added to the log when meaningful events occur, for example:

- When an initiative is created.
- When an initiative's status changes (e.g. transitions to the active, accumulate statistics, inactive states).
- When lead related background processes are submitted for execution.
- When users want to manually add log entries as desired.

The Lifecycle of an Initiative

The following diagram shows the possible lifecycle of an Initiative:

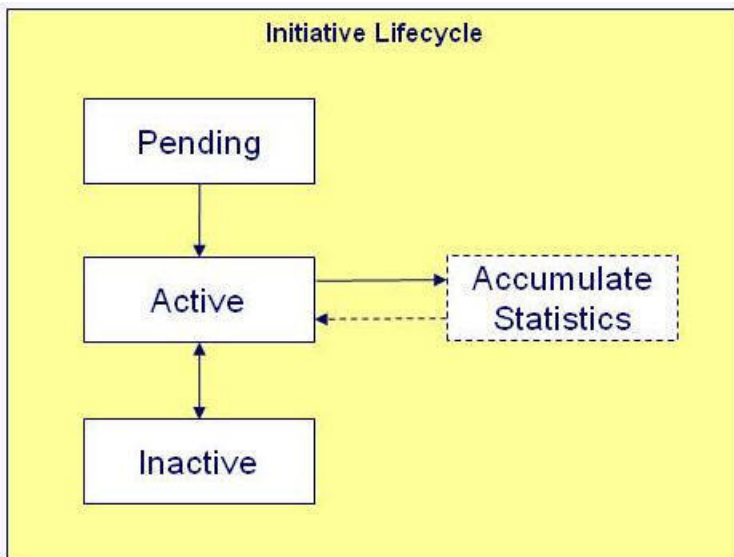

Pending state: An initiative starts out in a pending state.

Active state: An initiative is transitioned manually by a user to the active state. Leads can only be generated for an initiative in an active state.

Accumulate Statistics state: A user or the system may transition an active initiative to a periodically transitioning accumulate statistics state. During this state, statistics for the initiative are accumulated prior to returning back to the active state.

Inactive state: An initiative may be transitioned manually by a user to the inactive state when they want to deactivate the initiative either temporarily or permanently. A user can manually place the initiative back to the active state from the inactive state.

Refer to [Maintaining Initiatives](#) for more information.

Initiative Information Can Be Overridden

“Initiative info” is the concatenated string of information that summarizes an initiative throughout the system. The base-package logic constructs this string by concatenating the following information:

- Initiative description
- Status of the initiative
- Start date and end date (if available) of the initiative

If you'd prefer a different info string, you can develop a new algorithm and plug-it in on the Initiative's maintenance object.

The Big Picture of Leads

A lead is an instance of an initiative for a targeted customer. A lead may contain events or actions that are there to encourage a customer to participate in a program.

Refer to [Maintaining Leads](#) for more information about working with Leads.

How Leads Are Created

Leads are created as follows:

- The system can generate a lead, or leads, for each customer that satisfies the initiative eligibility criteria and/or related object criteria that is defined on an initiative.
- Users can manually create a lead at their discretion.

Refer to section [Creating Leads from an Initiative](#) and [Manually Creating a Lead](#) for more information.

The Components of a Lead

A lead has two components: A **Lead Event** and a **Lead Log**.

Lead Event

A lead has one or more lead events. These events are the actions designed to encourage a customer to participate in a program. For example, one event could be that a letter or an email is sent to a customer.

Refer to [The Big Picture of Lead Events](#) for more information.

Lead Log

Every lead has a log holding its history. Entries are added to the log when meaningful events occur, for example:

- When a lead is created
- When a lead's status changes (e.g. transitions to the active, successful or discarded state)
- When a lead event executes
- Users can manually add log entries as desired.

The Lifecycle of a Lead

The following diagram shows the possible lifecycle of a Lead:

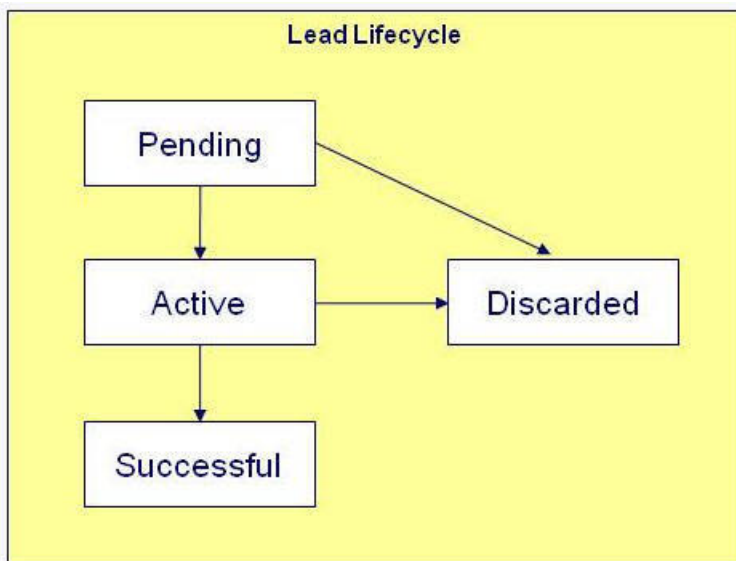

Pending state: Leads can be created in either the **Pending** or **Active** state. By generating them in the **Pending** state, you can verify the targeted customers before actively marketing the initiative.

Active state: Leads can be created in either the **Pending** or **Active** state. When a lead is created or transitioned to the **Active** state, lead events are created to encourage the customers to participate in the initiative. For example, one event could be that a letter or an email is sent to a customer. The lead events and the sequence in which they occur are defined on the initiative's lead event type profile. The lead remains in the active state while it is being actively marketed to the customer.

Successful state: The system infers that a lead has succeeded by the creation of other data in the system, at which time the lead transitions to the **Successful** state. For example:

- If an active lead for a customer is related to a rebate claim conservation program, the lead is determined to be successful when that rebate claim is filed for the customer.
- If an active lead for a customer is related to a contract option, the lead is determined to be successful when the customer's service agreement is linked to that contract option.
- If an active lead for a customer is related to a campaign, the lead is determined to be successful if a completed order exists for the customer for the campaign.
- If an active lead is assigned to a third party representative (to perform one or more tasks), the lead is determined to be successful if the Notify Third Party lead event is completed.

Discarded state: An unsuccessful lead transitions to the **Discarded** state after a certain amount of time has passed, as defined on the initiative. If the initiative does not specify a time period, the lead remains in the active state until a user manually discards it.

Refer to [Maintaining Leads](#) for more information.

Advanced Analysis of Leads

Leads can be sent to an external system (such as Oracle DataRaker) for advanced analysis prior to activating the lead.

The base product provides Advanced Analysis System Lead (C1-AdvancedAnalysisLead) business object for this purpose. Its lifecycle includes steps to send the lead to the external system and activate/discard the lead based on the result of analysis..

Additional configuration is needed in Program Management master configuration to enable external analysis/validation. See master configuration embedded help for more details.

The Lifecycle of a Lead with Advanced Analysis

The following describes the states of a Lead that is sent to an external system for advanced analysis prior to activation..

(Refer to the C1-AdvancedAnalysisLead business object to view the lifecycle diagram.)

Pending state: Leads can be created in either the **Pending** or **Ready for Extract** state. By generating them in the **Pending** state, you can verify the targeted customers before actively marketing the initiative.

Ready for Extract state: At this state, leads are ready to be sent to the external system for analysis. A monitor batch process is defined on this state, to ensure that leads in this state are transitioned only when the batch process runs.

Waiting for Analysis state: When a lead is transitioned to this state, an outbound message containing lead information is sent to the external system.

Error state: The lead is transitioned to this state if the system is unable to send the outbound message. Retry logic on this state will attempt to resend the lead to the external system. Leads in this state can also be **Discarded** if needed.

Active state: When a lead completes external analysis, the External Validation and External Activation Priority flags on the lead are updated. An inbound web service sends back the lead and transitions the lead into the **Active** state. An enter algorithm evaluates the External Activation Priority flag. If the lead is marked as being a priority for activation (based on settings in master configuration), the lead stays in the **Active** state. Otherwise, the lead is **Discarded**.

When a lead is in the **Active** state, lead events are created to encourage the customers to participate in the initiative. For example, one event could be that a letter or an email is sent to a customer. The lead events and the sequence in which they occur are defined on the initiative's lead event type profile. The lead remains in the active state while it is being actively marketed to the customer.

Successful state: The system infers that a lead has succeeded by the creation of other data in the system, at which time the lead transitions to the **Successful** state. For example:

- If an active lead for a customer is related to a rebate claim conservation program, the lead is determined to be successful when that rebate claim is filed for the customer.
- If an active lead for a customer is related to a contract option, the lead is determined to be successful when the customer's service agreement is linked to that contract option.
- If an active lead for a customer is related to a campaign, the lead is determined to be successful if a completed order exists for the customer for the campaign.
- If an active lead is assigned to a third party representative (to perform one or more tasks), the lead is determined to be successful if the Notify Third Party lead event is completed.

An enter algorithm on this state sends an outbound message, to notify the external system about lead success.

Discarded state: Leads that are evaluated as non-priority for activation are transitioned to this state. Unsuccessful leads also transition to this state after a certain amount of time has passed, as defined on the initiative. If the initiative does not specify a time period, unsuccessful leads remain in the **Active** state until a user manually discards it.

Refer to [Maintaining Leads](#) for more information.

Lead Information Can Be Overridden

“Lead info” is the concatenated string of information that summarizes a lead throughout the system. The base-package logic constructs this string by concatenating the following information:

- Initiative description
- Status of the lead
- Creation date/time of the lead.

If you'd prefer a different info string, you can develop a new algorithm and plug-it in on the Lead's maintenance object.

Leads Are Highlighted As Alerts

If you plug-in the appropriate alert algorithm (C1-OPENLDALR) on the Installation record, alert(s) will be shown for open leads associated with the person, account and premise in context. A separate alert is shown for each unique Lead that is in a non-final state. Each alert message shows the Lead's info string.

How and When Are Leads Activated

Leads are activated as follows:

- The system can generate a lead for each customer that satisfies the initiative eligibility criteria and/or related object criteria that is defined on an initiative. The leads can be created in either a Pending or Active state. These leads can then be activated by a background process when required by the user.
- Users can manually activate a lead at their discretion.

Refer to section [Creating Leads from an Initiative](#) and [Maintaining a Lead](#) for more information.

How are Leads Completed

The system infers that a lead has succeeded by the creation of other data in the system, at which time the lead transitions to the **Successful** state. For example:

- If an active lead is related to a rebate claim conservation program, the lead is determined to be successful when that rebate claim is filed for the customer.

- If an active lead is related to a contract option, the lead is determined to be successful when the customer's service agreement is linked to that contract option.
- If an active lead for is related to a campaign, the lead is determined to be successful if a completed order exists for the customer for the campaign.
- If an active lead is assigned to a third party representative, to perform one or more tasks, the lead is determined to be successful if the Notify Third Party lead event is completed.

Users can also manually transition a lead to the Successful state at their discretion. Refer to [Maintaining a Lead](#) for more information about working with Leads.

How Are Leads Discarded

When leads are sent to an external system for analysis prior to lead activation, a possible result of the analysis is that the lead is flagged as non-priority for activation. When this occurs, the lead is discarded.

Unsuccessful leads transition to the Discarded state after a certain amount of time has passed, as defined on the initiative. The initiative's lead event type profile can include an event that automatically discards a lead after a designated number of days. If the initiative does not specify this auto-discard event, the lead remains in the active state until a user manually discards it.

Some types of lead events can also trigger a lead to be discarded when specific conditions are met; for example, a lead that is assigned to a third party representative can be automatically discarded when the third party representative finds that the account is ineligible for the initiative. Refer to [The Lifecycle of a Third Party Representative](#) for more details.

In addition, automatic lead discards capture a lead discard reason. Lead event types that support auto-discard define their respective default lead discard reasons. Refer to [Setting Up Lead Event Types](#) and [Maintaining a Lead](#) for more information

Sign Up Options Can Be Overridden

The lead's Sign Up special action button performs the following:

- Displays a Sign Up UI map (if one exists) to capture additional inputs for sign up processing.
- Executes a Sign Up service script to process the sign up.
- Displays a confirmation map if the sign up is successful.

The Sign Up UI map and Sign Up service script can be overridden via options on the initiative's business object. Refer to [Overriding Initiative Sign Up Options](#) for more details.

The Big Picture of Lead Events

A lead has one or more lead events. These events are the actions designed to encourage a customer to participate in a program. For example, one event could be that a letter or an email is sent to a customer.

You define the number and type of events to be initially inherited by a lead by configuring the Lead Event Type Profile on an initiative. Refer to [About the Lead Event Type Profile](#) for more information.

A lead event can include one or more steps. The lead event type defines a list of step types, if applicable.

The topics in this section provide additional information about lead events.

How are Lead Events Created

If a lead is created in a Pending state, there are no lead events associated with the lead. It is only when leads are created in or transitioned to the Active state, that lead events are created for the lead. The initial number of events and when the events shall occur are inherited from the lead's initiative.

Some types of events can also get created as a result of special actions on the lead. For instance, when a lead process requires a third party representative to perform one or more tasks after signup, the Sign Up action on the Lead portal automatically creates the Notify Third Party lead event.

The Components of a Lead Event

A lead event can have one or more steps. The lead event's business object defines whether or not steps are applicable to that type of event. The corresponding lead event type defines the valid step types. For an example, refer to the Third Party Lead Event (C1-ThirdPartyLeadEvt) and Send Notification to Third Party Lead Event Type (C1-LETypeNotifyThirdParty) business objects provided in base.

Lead Event Log

Every lead event has a log holding its history. Entries are added to the log when meaningful events occur, for example:

- When a lead event is created.
- When a lead event's status changes (e.g. transitions to the completed or cancelled state).
- Details of the content sent (if applicable).
- Users can manually add log entries as desired.

The Lifecycle of a Lead Event

The following diagram shows the possible lifecycle of a Lead Event business object:

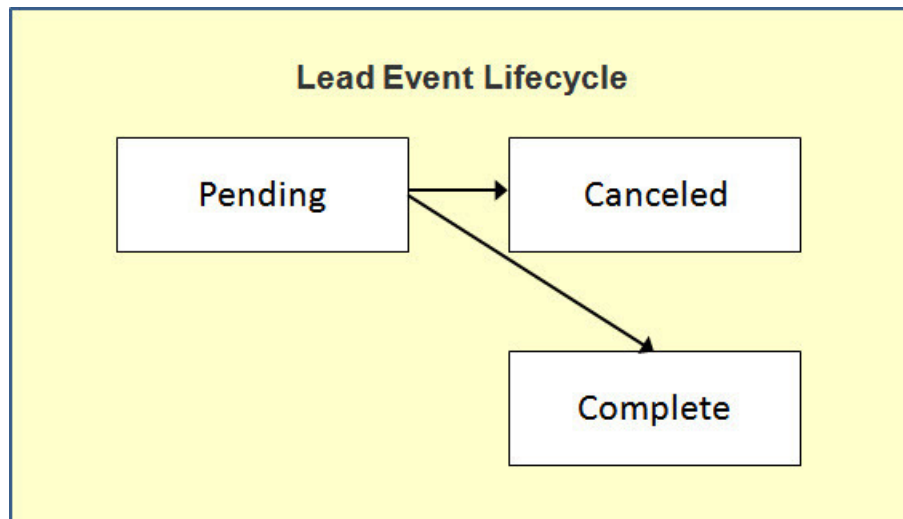

Pending state: Lead events are initially created in the Pending state. A lead event can take a number of paths after it is created; it all depends on how you've configured the system.

Complete state: A lead event contains a date when it should be activated. This is referred to as its trigger date. On this date, the system invokes the algorithm associated with the lead event to execute the event or action. A user may complete a pending event at their discretion.

Cancelled state: A pending event will be cancelled automatically by the system when a lead is canceled. A user may cancel a pending event at their discretion.

Refer to [Maintaining Lead Events](#) for more information.

The Lifecycle of a Third Party Lead Event

The following diagram shows the possible lifecycle of a Third Party Lead Event business object:

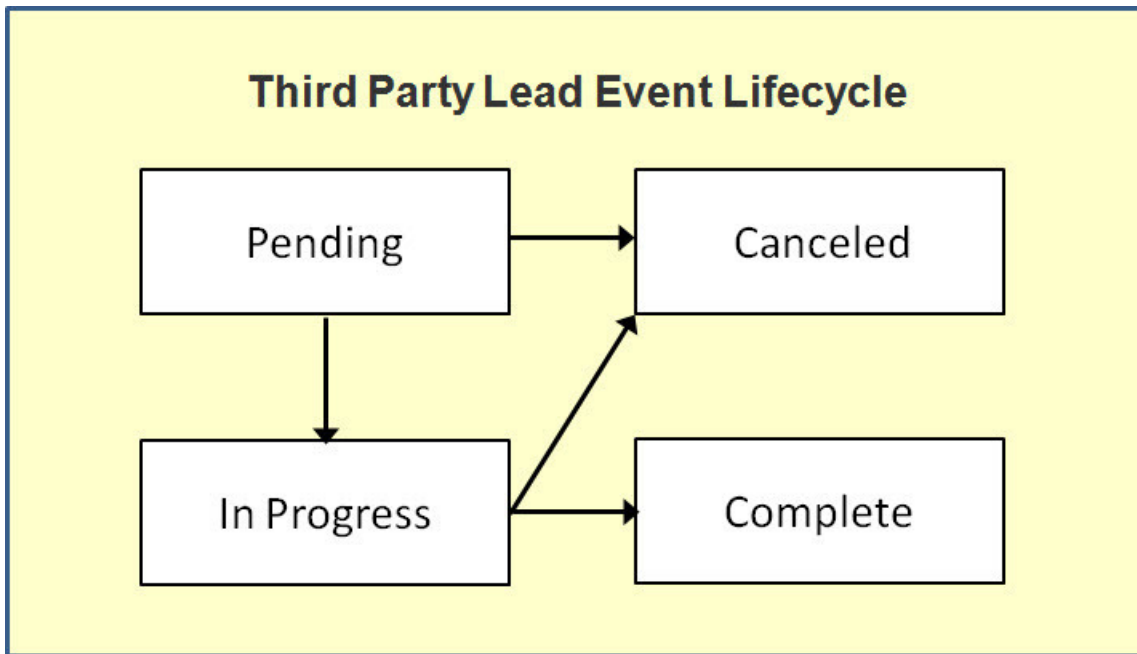

Pending state: Third party lead events are initially created in the Pending state. A third party lead event can take a number of paths after it is created; it all depends on how you've configured the system.

In Progress state: A third party lead event contains a date when it should be activated. This is referred to as its trigger date. On this date, the system invokes the algorithm associated with the lead event to execute the event or action. The lead event is set to In Progress and the lead event is sent to the third party representative.

Complete state: A third party lead event may be completed based on updates received from the third party. In most cases, the third party lead event is completed when all the event steps are complete. In addition, a user may complete an In Progress event at their discretion.

Cancelled state: A Pending or In Progress third party lead event will be cancelled automatically by the system when the lead is canceled. A user may cancel a Pending or In Progress event at their discretion.

Refer to [Maintaining Third Party Lead Events](#) for more information.

Lead Event Information Can Be Overridden

“Lead Event info” is the concatenated string of information that summarizes a lead event throughout the system. The base-package logic constructs this string by concatenating the following information:

- Lead event type description
- Status of the lead event
- Trigger date of the lead event

If you'd prefer a different info string, you can develop a new algorithm and plug-it in on the Lead Event's maintenance object.

Third Party Lead Event Step Information Can Be Overridden

The **Initiative Leads** zone on the **Third Party Representative** portal shows an event step information string for **Last Complete Step** and **Next Pending Step**. A base-package service script constructs this string by concatenating the following information:

- Step type description
- Intended Work Date/Time
- Completion Date/Time

You can override this by specifying an **Override Step Information Script** on the Program Management Master Configuration.

See [Program Management Master Configuration](#) for more details.

How and When Lead Events Are Activated

A lead event contains the date it should be activated; this is referred to as its trigger date. On this date, the Lead Event Periodic Monitor Process (a background process (C1-LDEVT)) invokes the algorithm associated with a lead event's event type. The algorithm, in turn, will decide on the state in which to leave the lead event.

If a user can't wait for the Lead Event Periodic Monitor Process real-time, they can click a button on Lead Event – Main to activate / trigger an event online in real-time. Refer to [Maintaining Lead Events](#) for more information.

You control how a lead event's trigger date is populated by configuring the Lead Event Type profile in an initiative. You indicate the number of days the lead event should be activated after the creation of the lead. Refer to [Maintaining Initiatives](#) for more information.

Activating Events Should Add a Log Entry

As described previously, a lead and lead event have a log holding a history of meaningful events in their lives. Most algorithms associated with a lead event's event type will add an entry to both the lead and lead event logs.

These log entries are more than just an audit trail as they also reference the objects that are created during execution. For example, if an algorithm creates a customer contact, the ID of the customer contact will be referenced on the log (and end-users will be able to drill down on the log entry to see the customer contact).

How Lead Events Are Cancelled

A pending lead event will be cancelled automatically by the system when the lead is canceled.

A user may cancel a pending lead event at their discretion. Refer to [Maintaining Lead Events](#) for more information.

A third party representative can also initiate the cancellation of a lead event. Refer to [The Lifecycle of a Third Party Lead Event](#) for more details.

The Big Picture of Sales Representatives

A sales representative is a group or individual who can be assigned to follow up and manage leads.

Individual sales representatives can be members of one or more groups, and they can be an internal user or an external party.

Groups can be used to control which sales representatives are allocated to the leads for an initiative. For example, you can set up a group whose sales representatives are responsible for industrial customers. Initiatives that target industrial

customers can then be configured so that this group is specified as the only one whose sales representatives can be assigned the initiative's leads.

Because many reports will aggregate information for all sales representatives in a group, you may choose to set up a sales representative group just for reporting purposes.

The topics in this section provide additional information about Sales Representatives.

The Lifecycle of a Sales Representative

The following diagram shows the possible lifecycle of a Sales Representative:

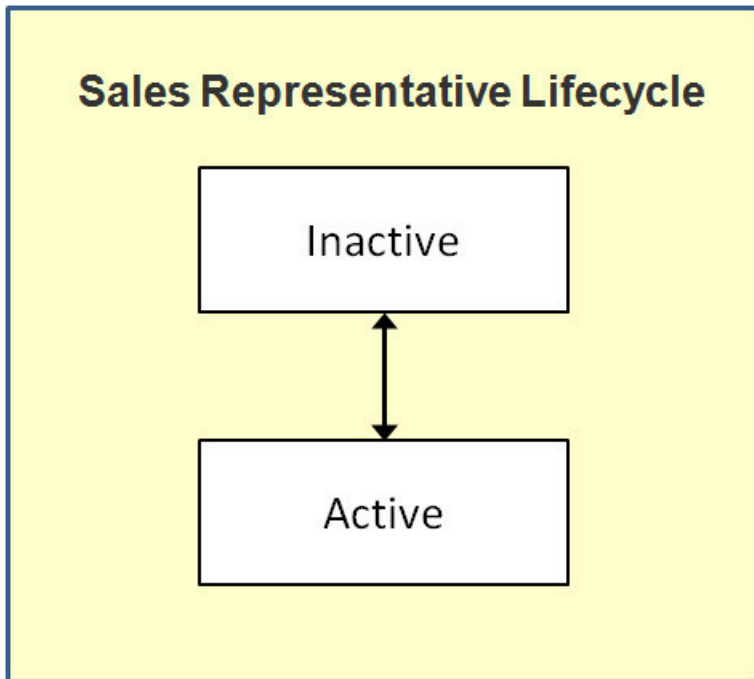

Active state: A Sales Representative starts out in an active state.

Inactive state: A Sales Representative may be transitioned manually by a user to the inactive state when they want to deactivate the Sales Representative either temporarily or permanently. A user can manually place the Sales Representative back to the active state from the inactive state.

Refer to [Maintaining Sales Representatives](#) for more information.

Sales Representative Log

Every Sales Representative has a log holding its history. Entries are added to the log when meaningful events occur, for example:

- When a Sales Representative is created
- When a Sales Representative's status changes (e.g. transitions to the inactive state)
- Users can manually add log entries (you might want to think of these as "diary" entries) as desired.

The Big Picture of Third Party Representatives

A third party representative is similar to a sales representative except that they are typically not internal employees and they have a different set of responsibilities.

Lead-related tasks may be outsourced to a third party representative who is better equipped to perform the work. These tasks may include pre-installation visits, energy audits, equipment installation, and equipment recycling. An initiative's lead event type profile defines whether or not lead-related work is sent to a third party representative.

Work is typically sent to a third party representative when a customer signs up for an initiative. The base product provides an online Sign Up action on active leads. This action creates a Third Party Lead Event that triggers the third party notification.

The third party representative is also responsible for providing updates to the system about the assigned leads. These updates can include event status updates, updates to important date/time information (e.g., completion date/time) and comments. This feedback enables users of the system to monitor the progress of leads and provide any necessary customer service.

Refer to the [The Lifecycle of a Third Party Lead Event](#) for more details on third party lead events.

The topics in this section provide additional information about Third Party Representatives.

The Lifecycle of a Third Party Representative

The following diagram shows the possible lifecycle of a Third Party Representative:

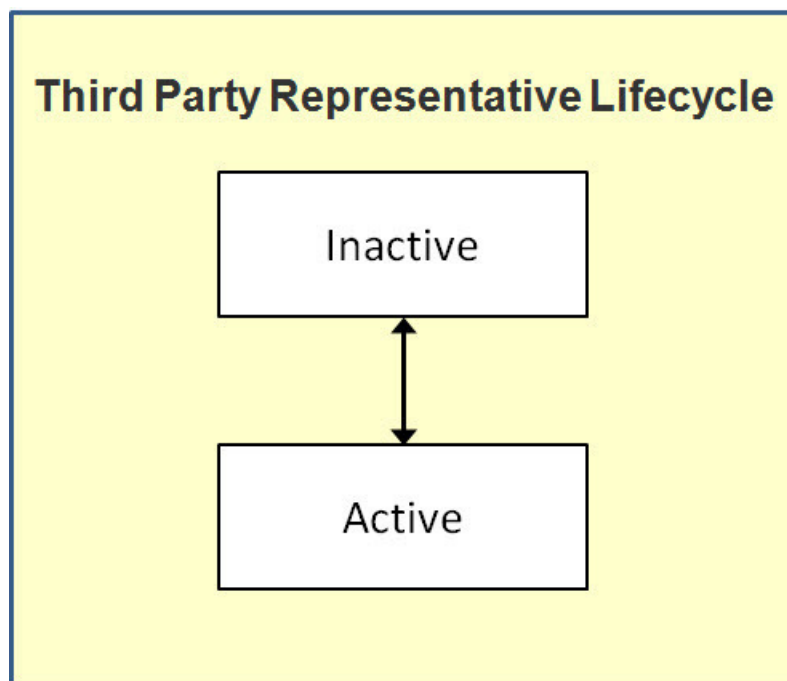

Active state: A Third Party Representative starts out in an active state.

Inactive state: A Third Party Representative may be transitioned manually by a user to the inactive state when they want to deactivate the Third Party Representative either temporarily or permanently. A user can manually place the Third Party Representative back to the active state from the inactive state.

Refer to [Maintaining Third Party Representatives](#) for more information.

Third Party Representative Log

Every Third Party Representative has a log holding its history. Entries are added to the log when meaningful events occur, for example:

- When a Third Party Representative is created.

- When a Third Party Representative's status changes (e.g. transitions to the inactive state).
- Users can manually add log entries as desired.

Maintaining Initiatives

An initiative defines a structured campaign that outlines the efforts to encourage customers to participate in a program targeted at a specific market segment.

Refer to [The Big Picture of Initiatives](#) for more information about initiatives.

Initiative Portal

You use the Initiative portal to maintain initiatives.

The **Main** page contains the following zones:

- **Initiative:** Displays the basic information about the initiative.
- **Initiative Eligibility Criteria Overview:** Displays initiative eligibility criteria associated with the initiative.
- **Related Object Criteria Overview:** Displays criteria for finding one or more related objects (such as, a premise) to link to a lead.
- **Initiative Hierarchy:** Displays the entire hierarchy of initiatives that the selected initiative is a part of.
- **Initiative Leads:** Displays the leads that are associated with the initiative.
- **Lead Processing:** Allows you to submit the lead generation or lead disposition batch process.

The **Statistics** page contains the following

- **Lead Summary by Representative:** Displays the summary of leads for the initiative hierarchy, grouped by representatives.
- **Initiative Leads:** Displays the leads that are associated with the initiative.
- **Lead Outcome Graph:** Displays the number of leads linked to the initiative hierarchy that entered the final state within the last 24 months.
- **Lead Statistics:** Displays statistics for the leads associated with the initiative.
- **Lead Monthly Statistics:** Displays statistics for the leads associated with the initiative on a monthly basis.
- **Unassigned Leads:** Displays leads that are not yet assigned to a sales representative and are not in a final state. (**Note:** Leads can be assigned to a sales representative in bulk.)

How To Perform Common Initiative Functions

The topics in this section describe how to perform common initiative functions from the Initiative portal.

Creating Initiatives

Use this procedure to create a new Initiative.

1. Select **Menu > Sales & Marketing > Initiative > Add.**
2. Select the business object that will define the initiative and click **OK.**
3. Enter the initiative's name, (short) description, detailed description, start date, and end date.
4. Specify if the initiative is a master or a subsidiary initiative.

- a) If the initiative is a **Subsidiary Initiative**, search for and select the initiative that is the parent to this initiative.
- 5. Specify whether the master initiative will participate in demand-side analytics processing through Contract Option Participation Analysis.
- 6. Specify whether or not leads can be generated for the initiative.
 - a) If leads can be generated, complete the options regarding communication channel and related object creation.
- 7. In the Third Party Notification section, specify the Lead Event Type to use to notify a third party. This lead event type is used when creating a third party notification lead event, if applicable, when a customer signs up or enrolls into a program.
- 8. In the Lead Reassignment Notification section, indicate how the system should respond if a lead is reassigned to another sales representative.
- 9. In the Statistics Notification section, specify how often, in hours, the statistics for the initiative should be updated.

A background process accumulates the statistics for an initiative when enough time has elapsed since the statistics were last updated. A user may also manually initiate the process to update the statistics for an initiative.
- 10. If this initiative will have leads, add lead event types in the Lead Event Type Profile section to define the events or actions that will occur during the lifetime of the lead to encourage the customer to participate in the initiative. To add lead event types in the Lead Event Type Profile section:
 - a) Assign an **Event Sequence** to each list entry.
 - b) Search for and select a **Lead Event Type** to indicate the type of lead event to generate for each list entry (for example send customer an email or create a customer contact).
 - c) Specify the number of **Days After Lead Creation** that the related lead event will be triggered.
- 11. Click **Save**.

Maintaining an Initiative

The topics in this section describe procedures for maintaining an initiative:

Allowable Record Actions on an Initiative

Use this procedure to maintain an initiative using standard record actions.

1. Select **Menu > Sales & Marketing > Initiative > Search**.
2. Enter your search criteria in the Initiative Query zone.
3. Click **Refresh**.
4. In the search results list, click the link for the initiative you want to maintain. The selected initiative opens in the Initiative portal.
5. Click the appropriate record action button:
 - **Edit** – Click the **Edit** button to edit the main attributes of an initiative. When you click **Save**, the system updates the record.
 - **Duplicate** – Click the **Duplicate** button to create a duplicate of the initiative being displayed. Before the new object is added to the database, a window appears asking you to enter the unique identifier of the new object. When you click **OK**, the system creates the record by copying the original record.
 - **Activate** – Click the **Activate** button to transition a pending or inactive initiative to the active state.
 - **Deactivate** – Click to **Deactivate** button to transition an active initiative to an inactive state.

- **Refresh Statistics** - Click the **Refresh Statistics** button to manually initiate the accumulation of the statistics for the initiative.
- **Delete** – Click the **Delete** button and click **OK** to delete the initiative from the database. Before you delete an initiative, the system verifies that the initiative is not referenced anywhere in the system. If it is, you cannot delete it. For example, if you attempt to delete an initiative, the system ensures the initiative has not been referenced on a lead, etc.

Defining Eligibility Criteria for an Initiative

Use this procedure to define eligibility criteria for an initiative. The following steps apply to each criterion.

Prerequisites: You must create an initiative that can have leads before you can define eligibility criteria for the initiative.

1. Select **Menu > Sales & Marketing > Initiative > Search**.
2. Enter your search criteria in the Initiative Query zone.
3. Click **Refresh**.
4. In the search results list, click the link for the initiative that you want to maintain. *(The selected initiative opens in the Initiative portal.)*
5. To define eligibility criteria for the initiative, click the **Add** link in the Initiative Eligibility Criteria Overview zone title bar. *(This zone is displayed for initiatives that can have leads.)*
6. Select the business object that will define the initiative criteria and click **OK**.

The base package provides a number of initiative eligibility criteria business objects. Each business object defines its valid comparison algorithm(s), operator(s), and value(s). Refer to the maintenance maps of these business objects for details. For more information about eligibility criteria types, refer to [About Initiative Eligibility Criteria](#).

7. Enter a sequence number, description, detailed description, and criteria execution point for the criterion.
8. Complete the Criteria Comparison section. Each business object defines the valid selections for: **Algorithm**, **Comparison Operator** and **Comparison Value**.
9. Complete the Comparison Results section. Specify the action for each possible comparison outcome - meaning, **If True**, **If False**, and **If Insufficient Data**.

Refer to the embedded help on the maintenance map for more details on these fields.

Refer to the embedded help on the maintenance map for more details on these fields.

10. Click **Save**.

Repeat steps 5 to 10 to add additional criterion for the initiative.

Defining Related Object Criteria for an Initiative

Use this procedure to define related object criteria for an initiative. The following steps apply to each criterion.

Prerequisites: You must create an initiative that can have leads before you can define related object criteria for the initiative.

1. Select **Menu > Sales & Marketing > Initiative > Search**.
2. Enter your search criteria in the Initiative Query zone.
3. Click **Refresh**.

4. In the search results list, click the link for the initiative you want to maintain. The selected initiative opens in the Initiative portal.
5. To define related object criteria for the initiative, click the **Add** link in the Related Object Criteria Overview zone title bar. *(This zone is displayed for initiatives that can have leads.)*
6. Select the business object that will define the initiative criteria and click **OK**.

The base package provides a number of related object criteria types that attempt to link an account's premise(s) to the lead. Each initiative criteria business object defines its valid comparison algorithm(s), operators and value(s). Refer to the maintenance maps of these business objects for details. For more information on eligibility criteria types, refer to [About Related Object Criteria](#).

7. Enter a sequence number, description, and detailed description for the criterion.
8. Complete the Criteria Comparison section. Each business object defines the valid selections for: **Algorithm**, **Comparison Operator**, and **Comparison Value**.
Refer to the embedded help on the maintenance map for more details on these fields.
9. Complete the Comparison Results section. Specify the action to take for each possible outcome of the comparison - meaning, **If True**, **If False**, and **If Insufficient Data**
Refer to the embedded help on the maintenance map for more details on these fields.
10. Click **Save**.

Repeat steps 5 to 10 to add additional criterion for the initiative.

Viewing Initiative Hierarchy

The Initiative Hierarchy zone on the Initiatives portal displays the hierarchy the selected initiative is a part of. By clicking on any initiative in the hierarchy, you will be navigated to the selected initiative.

Creating Leads from an Initiative

The topics in this section describe how to create leads from an Initiative.

Bulk Creation of Leads

Use this procedure to create leads in bulk.

1. Select **Menu > Sales & Marketing > Initiative > Search**
2. Enter your search criteria in the Initiative Query zone.
3. Click **Refresh**.
4. In the search results list, click the link for the initiative you want to maintain.
The selected initiative opens in the Initiative portal.
5. To create leads for the initiative, click **Lead Generation** on the Lead Generation and Disposition zone. This zone is displayed for initiatives in the active state, can have leads and allows a batch job to be submitted for the creation of leads.
 - Select the **Lead Status** to leave the created leads in. Valid values are Pending or Active. Creating leads in a pending state allows a user to confirm the lead population prior to activating these leads
 - Specify the **Number of Leads to Generate**. This may be used to create a sample set of leads to test the initiative's eligibility criteria.

- Specify the **Email Address**. You may optionally specify an email address if you want to be informed when the batch job completes

6. Click **OK**.

Uploading Leads

NOTE: This functionality is to be used on small volume uploads.

1. Select **Menu > Sales & Marketing > Initiative > Search**.
2. Enter your search criteria in the Initiative Query zone.
3. Click **Refresh**.
4. In the search results list, click the link for the initiative you want to maintain. The selected initiative opens in the Initiative portal.
5. To upload Leads for an initiative, click the **Lead Upload** link in the Initiative Leads zone title bar. This displays the Lead Upload page, which you can use to upload a CSV file containing account IDs for which leads will be generated.
6. Click **Submit**.

Managing Leads from an Initiative

The procedures in this section describe how to manage leads from an initiative.

Viewing Initiative Leads

The Initiative Leads zone is displayed on both the Main page and the Statistics page.

By default, the Initiative Leads zone is populated with all leads for the initiative (or initiative hierarchy group) for all sales representatives.

On the Statistics page, you can limit the set of leads using the Lead Summary by Representative zone. See [Viewing Lead Summary by Representative](#) for details.

The following is displayed in the result set for each lead:

- Basic **Lead** information for the initiative's lead. You can navigate to the lead by clicking on the lead.
- **Customer Information** related to the lead. You can navigate to the account related to the lead by clicking on the customer information.
- The **Last Complete Event**. You can navigate to the lead event by clicking on the last complete event for a lead.
- For open leads, the **Next Pending Event**. You can navigate to the lead event by clicking on the next pending event for a lead.
- The **Sales Representative** shows the representative assigned to the lead.

Activating, Deleting, and Discarding Leads for an Initiative in Bulk

Use the following procedure to activate, delete or discard leads for an initiative.

1. Select **Menu > Sales & Marketing > Initiative > Search**
2. Enter your search criteria in the Initiative Query zone.
3. Click **Refresh**.

4. In the search results list, click the link for the initiative you want to maintain.
The selected initiative opens in the Initiative portal.
5. Scroll, as needed, to the Lead Processing zone.
6. To activate, delete or discard leads for the initiative, click **Lead Disposition**. This allows a batch job to be submitted for the activation, deletion or discarding of leads.
 - Select the **Pending Lead Disposition** to indicate the action to take on pending leads. The possible actions are: Activate (pending leads), Delete (in case of erroneous generation), Ignore.
 - Select the **Active Lead Disposition** to indicate to action to take on active leads. The possible actions Ignore and Discard.
 - Select the **Discard Reason** to be used for any active leads that get discarded. The values are maintained on the Status Reason control table.
 - Specify the **Email Address**. You may optionally specify an email address if you want to be informed when the batch job completes
7. Click **OK**.

Viewing Initiative Statistics

The Statistics page displays statistical information about the leads of the current initiative in context. It shows the following:

- Lead counts by sales representative and status
- List of leads
- Graph of completed and discarded leads over a period of time
- Graph of leads by status
- Graph of active leads per sales representative
- Graph of open, completed and discarded leads over a period of time
- Graph of the top discard reasons over a period of time

The following sections describe these zones. You can also refer to each zone's embedded help for more details.

Viewing Lead Summary by Representative

The Lead Summary by Representative zone displays a summary of leads for the initiative (or initiative hierarchy group) by individual representative. If the Initiative is configured not have a sales representative, the zone will group those leads under 'Leads without Representative'.

To limit the summary of leads by sales representative:

1. Select **Menu > Sales & Marketing > Initiative > Search**.
2. Enter your search criteria in the Initiative Query zone.
3. Click **Refresh**.
4. In the search results list, click the link for the initiative you want to maintain.
The selected initiative opens in the Initiative portal.
5. Go to the **Statistics** page and scroll, as necessary, to view the Lead Summary by Representative zone.
6. Specify **Start Date** and/or **End Date** to limit the summary to leads created within this date range. If specified, start date must be on or before the current date and end date must be on or after the start date. If left blank, end date is defaulted to the current date.

7. If **Include Inactive Leads** is set to No, leads for the initiative (or initiative hierarchy group) regardless of status are included.

The following is displayed in the result set:

- A summary line for the individual sales representative shows the total Lead Count.
- A breakdown is included beneath each sales representative summary line that shows a subtotal Lead Count by lead state.
- An icon is displayed that allows broadcasting of the representative, initiative, date range and lead state (if available) to other zones on the portal. Lead state broadcast is only available on the subtotal lines.

Graphs and Statistics for an Initiative

The following zones display statistics for the initiative's leads.

NOTE: The system periodically refreshes the statistics for an initiative when the time specified on an initiative has lapsed. A user may also manually initiate the refreshing of statistics if required.

Lead Outcome Graph

This Lead Outcome Graph zone shows the number of Leads linked to the initiative (or initiative group hierarchy) that entered the final state in the last 24 months starting from the most recent completed Lead.

The date shown on the X-axis will be the first day of the month. Note that the information displayed here is based on the most recent completed Lead as of the time the Initiative Statistics is accumulated.

Lead Statistics

The Lead Statistics zone has two charts to provide statistics for leads for the initiative:

- **Leads by State:** The chart shows the number of leads for each state in the lead's lifecycle as of the initiative's Statistics Date/Time. Each state can be represented by a unique color. These colors are defined on the Program Management master configuration. Refer to [Program Management Master Configuration](#) for setting up program management options for more information.
- **Active Leads by Representative:** The chart shows the top five individual sales representatives for the initiative (i.e. sales representatives with the largest number of active leads assigned to them as of the Statistics Date/Time). The top five sales representative can be represented by a unique color. These colors are defined on the Program Management master configuration. Refer to [Program Management Master Configuration](#) for setting up program management options for more information.

Lead Monthly Statistics

The Lead Monthly Statistics zone has two charts to provide statistics for leads for the initiative:

- **Leads by State:** The chronological graph highlights the number of open, completed and discarded leads over time for the initiative in context. The date displayed on the x-axis represents the start date of the statistics period. For example, 01-01-2013 shows statistics for the period 01-01-2013 through 01-31-2013. Each State can be represented by a unique color. These colors, along with the number of months to display are defined on the Program Management master configuration. Refer to [Program Management Master Configuration](#) for setting up program management options for more information.
- **Active Leads by Representative:** The chronological graph highlights the top 4 discard reasons over time for the initiative in context. Statistics for all other discard reasons are accumulated in a catch-all bucket. The date displayed on the x-axis represents the start date of the statistics period. For example, 01-01-2013 shows statistics for the period 01-01-2013 through 01-31-2013. Each Discard Reason can be represented by a unique color. These colors, along with the number of months to display are defined on the Program Management master configuration. Refer to [Program Management Master Configuration](#) for setting up program management options for more information.

Displaying and Assigning Unassigned Leads

Use the following procedure to review and assign, as appropriate, non-final and unassigned leads that are associated to the initiative in context.

1. Select **Menu > Sales & Marketing > Initiative > Search**.
2. Enter your search criteria in the Initiative Query zone.
3. Click **Refresh**.
4. In the search results list, click the link for the initiative you want to maintain. The selected initiative opens in the Initiative portal.
5. Go to the **Statistics** page and scroll, as necessary, to view the Unassigned Leads Zone.
6. Enter a Start Date and End Date range that encompasses the desired period.
7. Click **Refresh** to view unassigned leads that were created within the period specified.
8. (optional) Assign one or more leads from the result set:
 - a) Select the unassigned leads from the results set.
 - b) Enter the sales representative that will be assigned the leads.
 - c) Press **Assign to Sales Rep**.
 - d) Select the Sales Representative from the dropdown menu and click **OK**.

Maintaining Leads

A lead is an instance of an initiative for a targeted customer. A lead may contain events or actions that are there to encourage a customer to participate in a program

The topics in this section describe the common functions associated with leads.

My Leads

You can use the My Lead menu item to maintain leads.

- If your User ID is linked to a Sales Representative, you are navigated to the Sales Representative portal with the user in context.
- If your User ID is not linked to a Sales Representative, you are navigated to the Leads Query portal.

Lead Portal

You use the Leads portal to maintain leads. This portal contains the following zones:

- **Lead:** Displays the basic information about the lead.
- **Lead Events:** Displays the events associated with the lead in chronological order.
- **Related Leads:** Displays the leads that are related to the current lead's related objects (e.g. account).
- **Attachments:** Displays uploaded documents that are related to the lead.
- **Notes:** Displays all notes for the lead and its lead events.

- **Third Party Event:** if a third party lead event exists, this zone displays the lead event's information, including the event steps

How To Perform Common Lead Functions

The topics in this section describe how to perform common lead maintenance functions from the Lead portal.

Manually Creating a Lead

Use this procedure to manually create a new lead.

1. Select **Menu > Sales & Marketing > Lead > Add.**
2. Select the lead's Initiative and click **OK.**
The Account Lead page displays so that you can complete the lead.
Enter the following information as required by the Initiative:
3. Search for and select the **sales representative** for the lead.
4. Indicate how the customer requested information about the initiative in the **response channel.**
5. Indicate if the customer has **signed up** for the initiative.
6. Search for and select the **account** that will be associated to the lead.
7. Search for and select the **premise** that will be associated to the lead.
8. Click **Save.**

NOTE: Leads can also be created through the Initiative context menus and Account context menus.

Maintaining a Lead

1. Select **Menu > Sales & Marketing > Lead > Search.**
2. Enter your search criteria in the Lead Query zone.
3. Click **Refresh.**
4. In the search results list (not applicable if Lead ID is specified in the search criteria), click the link for the lead you want to view maintain. The selected lead opens in the Lead portal.

NOTE: You may also navigate to the Lead portal by clicking on the appropriate lead from various portals and zones. Examples include:

- Dashboard Portal: Alerts zone
 - Initiative Portal: Initiative Leads zone
 - Sales Representative Portal: Initiative Leads zone or Initiative Lead Events
-

5. Click the appropriate record action button:

Buttons that appear when the lead is Pending:

- **Edit** – Click the **Edit** button to allow you to edit the main attributes of the lead. When you click **Save**, the system updates the record.

- **Delete** – Click the **Delete** button and click **OK** to delete a pending lead from the database. Before you delete a lead, the system verifies that the lead is not referenced anywhere in the system. If it is, you cannot delete it.
- **Activate** – Click the Activate button to transition a pending lead to the active state. When a lead is activated, lead events for the lead are created to encourage the customers to participate in the initiative.

Buttons that appear when the lead is Active:

- **Edit** – *see the description above.*
 - **Discard** – Select the **Discard** button to inactivate an active lead. Select a **Status Reason** indicating why the lead is being inactivated and click **Save**. The values are maintained on the Status Reason control table
 - **Complete** – Click the **Complete** button to indicate that an active lead has been successful.
 - **Sign Up** – Click the **Sign Up** button to initiate a script that is defined on the Initiative’s business object. The base package script **C1-IntvSignU** reevaluates the customer to determine if they are still eligible to participate in a program, indicates the customer has signed up or enrolled on the lead and creates a third party lead event (if applicable) to notify the relevant third party of the actions to be performed. The Response Channel on the lead is also updated for analytical purposes
6. Click the **Add Notes** button, in the Notes zone, to capture additional information for the lead.
 7. The **Third Party Event Zone** displays third party lead event (if any) details along with the steps involved in the lead event

Adding New Lead Events to a Lead

1. Select **Menu > Sales & Marketing > Lead > Search**.
2. Enter your search criteria in the Lead Query zone.
3. Click **Refresh**.
4. In the search results list, click the link for the lead you want to view maintain. The selected lead opens in the Lead portal.
5. To add a lead event to the lead, click the **Add Lead Event** link in the Lead Events zone title bar.
6. Search for and select the appropriate lead event type.
7. Specify the Trigger Date of when the lead event is to be executed.
8. Specify the Communication Channel to indicate what form the event will be sent.
9. Click **Save**.

Repeat steps 5 to 9 for add additional lead events.

Adding Lead Notes

1. Select **Menu > Sales & Marketing > Lead > Search**.
2. Enter your search criteria in the Lead Query zone.
The C1-owned base package search options include:
 - Name and address
 - Related object
 - Representative and initiative

- Lead ID
3. Click **Refresh**.
 4. In the search results list, click the link for the lead you want to view maintain. The selected lead opens in the Lead portal.
 5. Scroll, as necessary, to view the Notes zone.
 6. Click the **Add Notes** link in the zone's title bar.
 7. Enter the desired information in the **Add Notes for Lead** pop-up window and click **Save**.

Maintaining Lead Events

A lead event is an event or action in a lead to take place to encourage a customer to participate in a program. A lead may contain many lead events.

The Lead Event portal is used to maintain lead events. This portal contains the following zones:

- **Lead Event:** Displays the basic information about the lead event.
- **Notes:** Displays user-defined comments about this lead event

To maintain a lead event:

1. Select **Menu > Sales & Marketing > Lead Event > Search**.
2. Enter your search criteria in the Lead Event Query zone.
3. Click **Refresh**.
4. In the search results list, click the link for the lead event you want to maintain. The selected lead opens in the Lead Event portal.

NOTE: You may also navigate to the Lead Event portal by clicking on the appropriate lead event from various portals and zones. Examples include:

- Initiative Portal: Initiative Leads zone
- Sales Representative Portal: Initiative Leads zone or Initiative Lead Events

-
5. Click the appropriate record action button:
 - **Edit** – Click the **Edit** button to allow you to edit the main attributes of the lead event. When you click Save, the system updates the record.
 - **Complete** – Click the **Complete** button to indicate a pending lead event is completed.
 - **Cancel** - Select the **Cancel** button to cancel a pending lead event.
 6. Click the **Add Notes** icon, in the Notes zone, to capture additional information for the lead.

Maintaining Third Party Lead Events

A third party lead event represents an action within a lead to either encourage a customer to participate in a program, or perform an on-site service. A lead may contain one or more third party lead events.

The Lead Event portal is used to maintain third party lead events. This portal contains the following zones:

- **Lead Event:** Displays the basic information about the lead event.

- **Notes:** Displays user-defined comments about this lead event

To maintain a third party lead event:

1. Select **Menu > Sales & Marketing > Lead Event**.

2. Enter your search criteria in the Lead Event Query zone.

The C1-owned base package search options include:

- Name and address
- Related object
- Initiative and representative
- Lead and lead event

3. Click **Refresh**.

4. In the search results list, click the link for the lead event you want to maintain. The selected lead opens in the Lead Event portal.

NOTE: You may also navigate to the Lead Event portal by clicking on the appropriate lead event from various portals and zones. Examples include:

- Initiative Portal: Initiative Leads zone
 - Sales Representative Portal: Initiative Leads zone or Initiative Lead Events
-

5. Click the appropriate record action button:

- **Edit** – Click the **Edit** button to allow you to edit the main attributes of the lead event. When you click Save, the system updates the record.
- **In Progress** – Click the **In Progress** button to initiate the notification process and have the third party lead event sent to the representative.
- **Cancel** - Select the **Cancel** button to cancel a pending lead event.

6. Click the **Add Notes** icon, in the Notes zone, to capture additional information for the lead.

Maintaining Sales Representatives

A Sales Representative is a user or group of users who can be assigned to follow up on leads and responsible for selling the initiatives product or service to the customer.

The topics in this section describe the common functions associated with Sales Representatives.

Sales Representatives Portal

You use the Sales Representative portal to maintain sales representatives. This portal contains the following zones:

- **Sales Representative:** Defines the basic information about the representative.
- **Initiative Lead Summary:** Lists initiatives and information about leads for each initiative for the representative. Clicking the broadcast icon from the summary table in this zone displays the following additional zones:
 - **Initiative Leads:** Displays leads for the initiative and representative.
 - **Initiative Lead Event Summary:** Displays lead event statistics for the initiative lead and representative.
 - **Initiative Lead Events:** Displays lead events for the initiative lead and representative.

- **Group’s Representatives:** This zone is displayed for a representative group and lists the individual representatives who are members of the group.
- **Representative’s Groups:** This zone is displayed for an individual representative and lists the representative groups of which this representative is a member.

How To Perform Common Sales Representative Functions

The topics in this section describe how to perform common sales representative functions from the Sales Representative portal.

Creating Sales Representatives

Use this procedure to create a new sales representative.

1. Select **Menu > Sales & Marketing > Sales Representative > Add.**
2. Select the sales representative type that will define the representative and click **OK.**
3. Enter the appropriate information for the representative:
 - For a Group Sales Representative:
 - Specify the Sales Representative name and description.
 - Search for and select Individual Sales Representative who will be a member of the group.
 - For an Individual Sales Representative:
 - Specify the Sales Representative name and description.
 - Search for and select User for the individual sales representative.
 - Search for and select Group Sales Representative that the individual sales representative will be a member of.
4. Click **Save.**

Maintaining Sales Representatives

1. Select **Menu > Sales & Marketing > Sales Representative > Search.**
2. Enter your search criteria in the Sales Representative Query zone.
3. Click **Refresh.**
4. In the search results list, click the link for the sales representative you want to maintain. The selected sales representative opens in the Sales Representative portal.

NOTE: You may also navigate to the Sales Representative portal by clicking on the appropriate Sales Representative from various portals and zones. Examples include:

- Initiative Portal: The Initiative Zone or the Lead Summary By Representative.
- Lead Portal: Lead zone

-
5. Click the appropriate record action button:
 - **Edit** – Click the **Edit** button to allow you to edit the main attributes of a sales representative. When you click **Save**, the system updates the record

- **Duplicate** – Click the **Duplicate** button to create a duplicate of the sales representative being displayed. Before the new object is added to the database, a window appears asking you to enter the unique identifier of the new object. When you click **OK**, the system creates the record by copying the original record
 - **Deactivate** – Click the **Deactivate** button to transition an active sales representative to an inactive state
 - **Delete** – Click the **Delete** button and click **OK** to delete the sales representative from the database. Before you delete a sales representative, the system verifies that the sales representative is not referenced anywhere in the system. If this is the case, you cannot delete the representative. For example, if you attempt to delete a sales representative, the system ensures the sales representative is not referenced on a lead, etc.
6. For an individual sales representative, you can add the sales representative to another group by clicking the **Add Rep to Another Group** link in the Representative's Group zones title bar. Select a group sales representative and click **Save**. You can remove the representative from a group (or groups) by selecting the group(s) and clicking the **Remove Rep from Group(s)** button.
 7. For a representative group, you can add a representative to the group by clicking the **Add Rep To This Group** link in the Group's Representatives zone's title bar. Search for and select the individual sales representative to add to the group and click **Save**. You can remove representatives from a group by selecting the representatives and clicking the **Remove Rep(s) from Group** button.

Displaying Leads and Lead Event Information for a Sales Representative

From the Initiative Lead Summary zone on the Sales Representative portal, you can broadcast a representative, initiative, date range and lead state (if available) to other zones on the portal.

Displaying Leads Associated Information for a Sales Representative

The Initiative Lead Summary zone on the Sales Representative portal displays the leads that have been assigned to the sales representative. If the representative is a group, leads are summarized for all individuals in the group.

To limit the summary of leads for the sales representative:

1. Select **Menu > Sales & Marketing > Sales Representative > Search**.
2. Enter your search criteria in the Sales Representative Query zone.
3. Click Refresh.
4. In the search results list, click the link for the sales representative you want to view or manage. The selected sales representative opens in the Sales Representative portal.
5. Specify **Start Date** and/or **End Date** to limit the summary to leads created within this date range. If specified, start date must be on or before the current date and end date must be on or after the start date. If left blank, end date is defaulted to the current date.
6. If **Only Show Active Initiatives** is set to **Yes**, only leads linked to initiatives in the active state are summarized. Otherwise, leads for all initiatives regardless of status are included.
7. Click **Refresh**.

The following is displayed in the result set:

- A summary line for each initiative shows the total **Lead Count** for the individual or group rep.
- A breakdown is included beneath each initiative summary line that shows a subtotal **Lead Count** by lead state.
- An icon is displayed that allows broadcasting of the representative, initiative, date range and lead state (if available) to other zones on the portal. Lead state broadcast is only available on the subtotal lines.

Sales Representative Initiatives Leads Zone

By clicking on one of the broadcast items in the Initiative Lead Summary zone, the Initiative Leads zone on the Sales Representative portal is populated with relevant lead information for the selected item. If the sales representative is a group, leads for all individuals in the group are shown.

The following is displayed in the result set for each lead:

- Basic **Lead** information for the initiative's lead. You can navigate to the lead by clicking on the lead.
- **Customer Information** related to the lead. You can navigate to the account related to the lead by clicking on the customer information.
- The **Last Complete Event**. You can navigate to the lead event by clicking on the last complete event for a lead.
- For open leads, the **Next Pending Event**. You can navigate to the lead event by clicking on the next pending event for a lead.
- The **Sales Representative** shows the rep assigned to each lead.

For information about using this zone to reassign leads to another representative, see [Reassigning Leads for a Sales Representative](#).

Initiatives Lead Event Type Summary

By clicking on one of the broadcast items in the Initiative Lead Summary zone, the Initiative Lead Event Type Summary zone is displayed. If the representative is a group, lead events are accumulated for all individuals in the group. The summary spans the 14 day period on/after the Start Date which defaults to current date if blank. If you want to specify the start date, click Refresh to update the zone.

The following is displayed in the result set:

- The **Event Count** shows the total number of events for a specific Event Type on each day within the 14 day period. You can click on the broadcast icon to see a list of events for the **Event Date** and **Event Type** on the Initiative Lead Events zone.
- The **Event Status** bar provides a breakdown of the total event count by status. Each color segment shown represents a different event status for pending, completed and canceled events. Colors used are defined on the program management master configuration.
 - Hover the mouse pointer over a segment of the bar to see the respective count and status represented by the segment.
 - Click on a segment of the bar to broadcast the event date, event type and event status. Broadcasting from the event status bar instead of the broadcast icon will limit the Initiative Lead Events zone to a particular status.

Initiatives Lead Events Summary

By clicking on one of the broadcast items in the Initiative Lead Event Type Summary zone, the Initiative Lead Events zone is populated. This zone displays lead events for the initiative, representative, lead event type (if available) and status (if available). If the representative is a group, events for all individuals in the group are shown. Only lead events with a trigger date on or after the **Start Date** are displayed.

The following is displayed in the result set:

- **Event Date** and **Lead Event** information is shown for each event. You can navigate to a specific lead event by clicking on a lead event.
- **Lead** shows the lead information for the initiative's lead. You can navigate to the lead by clicking on a lead.

- **Customer Information** related to the lead. You can navigate to the account related to the lead by clicking customer information for a lead.
- The **Sales Representative** shows the representative assigned to the lead.

Reassigning Leads for a Sales Representative

To reassign leads from one sales representative to another sales representative:

1. On the Initiatives Leads zone, select the leads that you want to reassign and click **Reassign Rep.**
2. Select the Sales Representative to reassign the selected lead to and click **Save.**

Maintaining Third Party Representatives

A Third Party Representative is someone who can receive assignments to perform specific tasks within a lead; such as, undertaking a visit to a property to perform an inspection or an installation. Refer to [The Big Picture of Third Party Representatives](#) for more information

The topics in this section describe the common functions associated with Third Party Representatives.

Third Party Representatives Portal

The Third Party Representative portal is used to maintain third party representatives. This portal contains the following zones:

- **Third Party Representative:** Defines the basic information about the third party representative.
- **Initiative Lead Summary:** Displays a summary of initiatives that have leads assigned for the third party representative. Clicking the broadcast icon from the summary table in this zone displays the following additional zones:
 - **Initiative Leads:** Displays leads for the broadcasted initiative and third party representative.
 - **Unassigned Leads:** Displays unassigned leads for the broadcasted initiative that are not yet assigned to a third party representative.

How To Perform Common Third Party Representative Functions

The topics in this section describe how to perform common representative functions from the Third Party Representative portal.

Creating Third Party Representatives

Use this procedure to create a new third party representative.

NOTE: Before adding the third party representative, they must be added as a Person without an account in the system. For more information about this process, see [How To Add A New Customer From Control Central](#).

1. Select **Menu > Sales & Marketing > Third Party Representative > Add.**
2. Enter the appropriate information for the representative:
 - Specify the Third Party Representative name and description.
 - Search for and select the Person record for the third party representative.
 - Select the External System that will be used to communicate to the third party representative.

3. Click **Save**.

Maintaining Third Party Representatives

1. Select **Menu > Sales & Marketing > Third Party Representative**.
2. Enter your search criteria in the Third Party Representative Query zone.
3. Click **Refresh**.
4. In the search results list, click the link for the third party representative you want to maintain. The selected third party representative opens in the Third Party Representative portal.
5. Click the appropriate record action button:
 - **Edit** – Click the **Edit** button to allow you to edit the main attributes of a third party representative. When you click **Save**, the system updates the record
 - **Duplicate** – Click the **Duplicate** button to create a duplicate of the third party representative being displayed. Before the new object is added to the database, a window appears asking you to enter the unique identifier of the new object. When you click **OK**, the system creates the record by copying the original record
 - **Deactivate** – Click the **Deactivate** button to transition an active third party representative to an inactive state
 - **Delete** – Click the **Delete** button and click **OK** to delete the third party representative from the database. Before you delete a third party representative, the system verifies that the third party representative is not referenced anywhere in the system. If it is, you cannot delete it. For example, if you attempt to delete a third party representative, the system ensures the third party representative is not referenced on a lead, etc.

Displaying Leads Associated Information for a Third Party Representative

The Initiative Lead Summary zone on the Third Party Representative portal displays the leads that have been assigned to the Third Party representative.

To limit the summary of leads for the sales representative:

1. Select **Menu > Sales & Marketing > Third Party Representative > Search**.
2. Enter your search criteria in the Third Party Representative Query zone.
3. Click **Refresh**.
4. In the search results list, click the link for the sales representative you want to view or manage. The selected sales representative opens in the Sales Representative portal.
5. Specify **Start Date** and/or **End Date** to limit the summary to leads created within this date range. If specified, start date must be on or before the current date and end date must be on or after the start date. If left blank, end date is defaulted to the current date.
6. If **Only Show Active Initiatives** is set to **Yes**, only leads linked to initiatives in the active state are summarized; otherwise, leads for all initiatives regardless of status are included.
7. Click **Refresh**.

The following is displayed in the result set:

- A summary line for each initiative shows the total **Lead Count** for the third party representative.
- A breakdown is included beneath each initiative summary line that shows a subtotal **Lead Count** by lead state.
- An icon is displayed that allows broadcasting of the third party representative, initiative, date range and lead state (if available) to other zones on the portal. Lead state broadcast is only available on the subtotal lines.

The Initiative Leads zone on the Third Party Representative portal displays the leads that have been assigned to the third party representative. The following is displayed in the result set for each lead:

- Basic **Lead** information for the initiative's lead. You can navigate to the lead by clicking on the lead.
- **Customer Information** related to the lead. You can navigate to the account related to the lead by clicking on the customer information.
- The **Last Completed Step**. You can navigate to the lead event by clicking on the event/step information.
- For active third party lead events, the **Next Pending Step**. You can navigate to the lead event by clicking on the event/step information.
- The **Sales Representative** shows the representative assigned to the lead.

The Unassigned Leads zone on the Third Party Representative portal displays active leads that are not yet assigned to a third party representative. The following is displayed in the result set for each lead:

- Basic **Lead** information for the initiative's lead. You can navigate to the lead by clicking on the lead.
- **Customer Information** related to the lead. You can navigate to the account related to the lead by clicking on the customer information.
- The **Sales Representative** shows the representative assigned to the lead.
- You can assign leads to the third party representative using the **Assign to Third Party** button.

See [Displaying and Assigning Leads to a Third Party Representative](#) for more information.

Displaying and Assigning Leads to a Third Party Representative

Use the following procedure to view leads that are not assigned to a third party representative, and assign one or more of those leads to the third party representative in context.

1. Select **Menu > Sales & Marketing > Third Party Representative > Search**.
2. Enter your search criteria in the Third Party Representative Query zone.
3. Click **Refresh**.
4. In the search results list, click the link for the third party representative you want to view. The selected third party representative opens in the Third Party Representative portal.
5. The **Initiative Lead Summary** zone shows the initiatives that have leads assigned to the third party representative in context. Click the broadcast button on an initiative to view its unassigned leads.
6. Scroll down to view the **Unassigned Leads** zone. This zone will display if there are active leads (for the broadcast initiative) that are not yet assigned to a third party representative.
7. To assign one or more leads to the third party representative in context:
 - a) Select the unassigned lead(s) from the results set.
 - b) Press **Assign to Third Party**.
 - c) Click **OK**.

Rates

When you set up a customer in the system, you create a service agreement for every service that the customer uses. The most important information specified on a service agreement is the rate. The rate controls:

- How the service's charges are calculated.
- How the charges are described on the customer's bills.
- How the general ledger is affected by the charges.

It's important to understand that while *most* service agreements are associated to a rate, you may have service agreements that don't use a rate to calculate their charges; for example, you may have [billable charge](#) service agreements to bill a customer for charges that have been calculated in an external system. Whether or not a service agreement uses a rate and the list of rates that can be specified on a service agreement are controlled by the service agreement's [SA Type](#).

In addition to calculating charges for service, your implementation can also use rates to calculate [adjustments](#).

FASTPATH:

Refer to [How Rates Affect The Information On A Bill](#) for how billing uses the information in a rate to calculate a bill segment. Refer to [Calculated Adjustments](#) for how to use a rate to calculate an adjustment.

NOTE:

Do not equate a rate in your legacy system with a rate in this system. You may find that the system's flexibility will result in fewer rates than you have today. For example, your current rate structure may have three rates for service because there are different prices based on the customer's geographic area. In this system, however, you can set up a single rate and vary the price based on where the customer lives.

This chapter describes the structure and process to configure rates.

NOTE:

If you're using Oracle Utilities Rate Cloud Service, refer to the [Oracle Utilities Rate Cloud Service](#) chapter in the *Business User Guide*, and the [Defining Oracle Utilities Rate Cloud Service Options](#) chapter in the *Administrative User Guide* for information about how the rate functionality works in the context of that cloud service.

Rate schedules created using the new rate engine are referred to as **Calculation Rule-Based Rates** or, simply, **Rates**; and those created using the original rate engine are referred to as **Component-Based Rates**. This chapter focuses on Calculation Rule-Based Rates, unless stated otherwise.

CAUTION:

Component-Based Rates, or classic rates, is not the recommended approach for new implementations. Component-Based Rates is intended for upgrading customers who currently use this rate structure and have not converted to Calculation Rule-Based Rates.

Calculation Rule-Based Rates

Calculation Rule-Based Rates (Rates) offer a flexible and reusable structure to calculate charges, centralize configuration, and reduce your development effort and time.

This chapter describes the structure and process to configure Rates.

All Calculation Rule-Based Rates Share a Common Structure

The basic components used to calculate charges are **Calculation Rules**. Each calculation rule is configured to perform a specific type of calculation, such as calculating tax charges, the number of days in a billing period, or the amount of consumption used by a customer in a billing period.

Calculation rules are organized into **Calculation Groups**, which are logical collections of calculation rules that can be referenced by rate schedules. Calculation rules and groups are commonly "generic" and can be applied to multiple rates.

Furthermore, calculation groups can be nested within other calculation rules. When the parent rule is processed, it executes all the rules that are nested in its referenced group. This strategy allows a single rule to execute any number of nested rules. Nesting also allows common calculations to be encapsulated into a set of calculation rules that can be included in multiple rates.

Calculation groups are defined for a rate schedule in one of three ways:

- **Pre-Processing Calculation Groups** perform initial calculations in preparation for the rate version calculation group.
- **Rate Version Calculation Groups** are effective-dated calculation groups that perform the main calculations of the rate schedule.
- **Post-Processing Calculation Groups** perform calculations after rate version calculation groups are executed.

See [About Calculation Groups](#) for more information.

At the highest level, every rate has a single rate schedule that contains basic information that shouldn't change over time; such as, the billing frequency, currency, and the rate's proration strategy. This information combined with the calculations groups, and other high-level configuration, comprise the Rate Schedule

Control Tables That Must Be Set Up Before Creating a Rate Schedule

This section describes tables that must be set up before you can add a rate schedule.

Master Configuration

The **Rate Engine Configuration** master configuration can be used to define the behavior of the Rate Schedule portals used when creating rate schedules.

To edit this master configuration, select **Admin > Master Configuration**, and click the edit icon for the **Rate Engine Configuration**.

The **Rate Engine Implementation** dropdown list defines which rate engine(s) will be used by your organization.

- **Calculation-Rule Based** indicates that your implementation uses calculation rule-based rates, which require the configuration of rate schedules with calculation groups and calculation rules.
- **Component-Based** indicates that your implementation uses component-based rates, which require the configuration of rate versions with rate components, and rate schedules with SQ and register rules.
- **Both** indicates that your implementation uses both rate engines. If this applies to you, then the system will use this option to ease navigation as follows:
 - Select **Menu > Rates > Rate Schedule > Add** to launch the page to add a new rate schedule. *(A hyperlink is included to take the user to the component-based rate schedule maintenance page, if necessary.)*
 - Select **Menu > Rates > Rate Schedule > Search** to launch the **Rate Schedule Query** portal.
 - The query results attempt to highlight component-based rates by appending **"(Component-Based)"** to the rate schedule's description.
 - Once a rate schedule is selected from the result set, the system navigates the user to either the calculation rule-based **Rate Schedule portal** or the component-based **Rate Schedule page**.

The **External Communication** section is used when the rate engine needs to communicate with an external system. For example, service quantities are needed to test a rate on the **Rate Check** portal. These service quantities may be entered on the portal, retrieved from an existing bill segment, or (in the case of a service agreement that requires bill determinants) request service quantities from Oracle Utilities Meter Data Management.

- **Request Type** identifies the various data requests that can be made to an external system. Request types are defined in the RATE_EXT_REQ_TYPE_FLG lookup field. To introduce additional request types, add appropriate lookup values to this lookup field for each request type you wish to support.

The base package includes the following business objects to be defined on the outbound message types created for such requests:

- **Rate Check Usage:** C1-UsageRequestOutMsg (used to request bill determinants from MDM on the rate check portal)
- **External System** and **Outbound Message Type** are used when creating the outbound message for the data request.

Defining Frequency Codes

When you create a rate schedule, you must enter a code defining the frequency in which the prices are expressed, e.g., monthly, quarterly, biannual, etc. To set up frequency codes, open **Admin > Rates > Frequency**.

Description of Page

Enter a unique **Frequency ID** and **Description** for each frequency.

Before entering the remaining fields, you must analyze the "proration provisions" in your rates. For example, consider a rate used to calculate charges for a "month's worth of service". Assume this rate's charges will not be prorated when the customer's service period is anywhere between 27 and 33 days. This rate requires a frequency that indicates:

- **12 Periods / Year** (because it's a monthly rate).
- **MinimumDays Offset** equal to 3.
- **MaximumDays Offset** equal to 3.

When the system creates a bill using a rate with this frequency, it compares the number of days of consumption on the bill to the minimum and maximum number of days inferred by the rate's frequency. In the example above, the minimum number of days would be 27 (365 days / 12 period per year - 3 offset for minimum days). The maximum number of days would be 33 (365 days / 12 periods per year + 3 offset for maximum days). Therefore, if a bill's consumption period is less than 27 days or more than 33 days, the bill's charges are prorated.

NOTE:

Overriding the system's standard proration logic. If the standard proration logic does not satisfy your requirements, you may plug in an override proration algorithm to calculate the proration factors as required by your implementation. For example, we have encountered companies who treat a year as have 360 days rather than 365 days. Such a company would need to develop an override proration algorithm and plug it on the [Installation](#) record.

Where Used

Every Rate Schedule must have a frequency. Refer to [Defining Rate Schedules](#) for more information.

Setting Up Bill Factors

This section describes bill factors and how they are used to levy the many charges referenced in a rate.

WARNING:

Most bill factors exist to support calculations performed by calculation rules. This means that you must design your calculation rules before you can design your bill factors. We strongly recommend that you design "on paper" how each rate's calculation rules look before attempting to set up bill factors.

An Overview of Bill Factors

The primary reason that calculation rules exist is to define how much to charge for the services sold by your company. When you create calculation rules, you have four ways to indicate how much to charge:

- Specify the value directly in the calculation rule.
- Define that the value is defined in a *bill factor*.
- Define that the value is calculated by a *for calculation purposes only* calculation rule.
- Tell the calculation rule to call an algorithm to get the price.

The remainder of this section describes the bill factor approach. The other methods are discussed in [Case Study: Three Simple Rates](#).

Bill factors are used to pass a value to a calculation rule; such as specifying a tax rate. To further illustrate this, you could specify the current tax rate, say 6%, directly in every rate's calculation rules OR you could indicate every rate should levy the current state tax rate and have the system look up the applicable rate when it calculates bills. The latter approach involves using a bill factor to indicate that the amount to charge should be retrieved from someplace other than the calculation rule when a bill is calculated.

You can use bill factors to define any of the following types of charges:

- A flat amount. This would typically be used to define service charges, minimum charges, and asset charges.
- An amount for a given unit of measure. This would typically be used to define the price for measured consumption (such as, the price per therm).
- A percentage. This would typically be used for tax rates and discount percents.

As a rule of thumb, you would use a bill factor (rather than specify the value in the calculation rule) when any of the following situations exist:

- The same charge exists in many rates. For example, if there are three rates that all contain the same service charge, it would make sense to use a bill factor to levy this charge rather than specify the same value on three calculation rules.
- The amount being charged is dependent upon some physical characteristic of the customer's equipment. For example, if the price differs depending on whether the customer owns the transformer, you would use a bill factor to specify the price.
- The amount being charged is dictated by some external organization and therefore can change independently from the rate. For example, tax percentages and use fees are set by taxing authorities and can be changed at any time (and you don't want to change the rate when these charges change).
- The amount being charged varies depending on WHERE the customer lives. If you have a rate where the price per gallon differs depending on where the customer lives, you should use a bill factor to levy this type of charge.
- A charge (or discount) is only levied for a subset of customers for defined periods of time. For example, if you have a discount that is only given to customers who have had service for more than two years, you would use a bill factor to specify the discount percent.
- The price differs per customer. For example, you may have a rate for large gas customers where the price per therm is different for every customer. In this situation, you would use a bill factor to specify the price.
- The price differs based on the number of weeks of consumption. This typically occurs in a deregulated environment when the price charge is based on the weighted average spot market price in effect during the bill period.

WARNING:

As you can deduce, bill factors are extremely flexible. While the flexibility makes for a very powerful rate engine, it also presents you a dizzying array of options. We have discovered that to take advantage of the flexibility, you need to gain

an overall understanding of the pricing and taxation provisions in ALL of your rates. Only then can you make logical and pragmatic decisions in respect of the number and type of bill factors.

The Structure of a Bill Factor

All bill factors share a common structure as illustrated below:

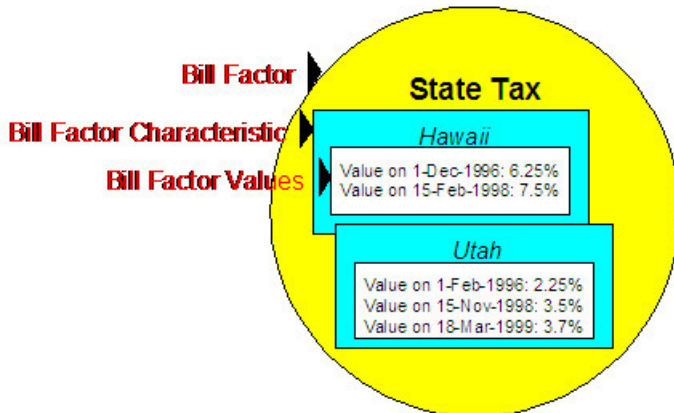

The above example shows a standard bill factor, which is made up of the following tables:

- **Bill Factor.** A **bill factor** contains descriptive information and attributes that control how the bill factor may be used in the system.
- **Bill Factor Characteristic.** All bill factors have the capability of having different values depending on some characteristic of the premise or service point. For example, a bill factor used to levy a state tax would have a different tax rate depending on the state in which the customer resides. A **bill factor characteristic** must exist for every state with a tax (states without a tax will not be linked to the state tax bill factor). At billing time, if the system cannot find a bill factor characteristic that corresponds with the customer's state of residence, the charge will be skipped.
- **Bill Factor Value.** Each bill factor characteristic may have many **bill factor values** over time. To continue with our state tax example, each state with a tax can have different tax rates over time. There are different ways in which a bill factor's values may be defined:
 - For bill factors whose values are applicable to many customers where only one value is effective on a given date (such as, a city tax) the values are defined using bill factor values. Refer to [Defining Bill Factor Values](#) for more information.
 - For bill factors whose value differs per customer, the value is defined in the customer's service agreement. Refer to [Service Agreement - Contract Value](#) for more information about bill factors in contract terms.
 - For bill factors whose values are applicable to many customers where more than one value is effective on a given date (such as, an interval price or a weighted average price) the values are defined on an interval value set. Refer to [Defining Interval Values](#) for more information about interval value sets.

An Illustration of a Bill Factor and Its Characteristics

The following picture illustrates how a bill factor and its characteristics are used to retrieve the relevant state tax at billing time:

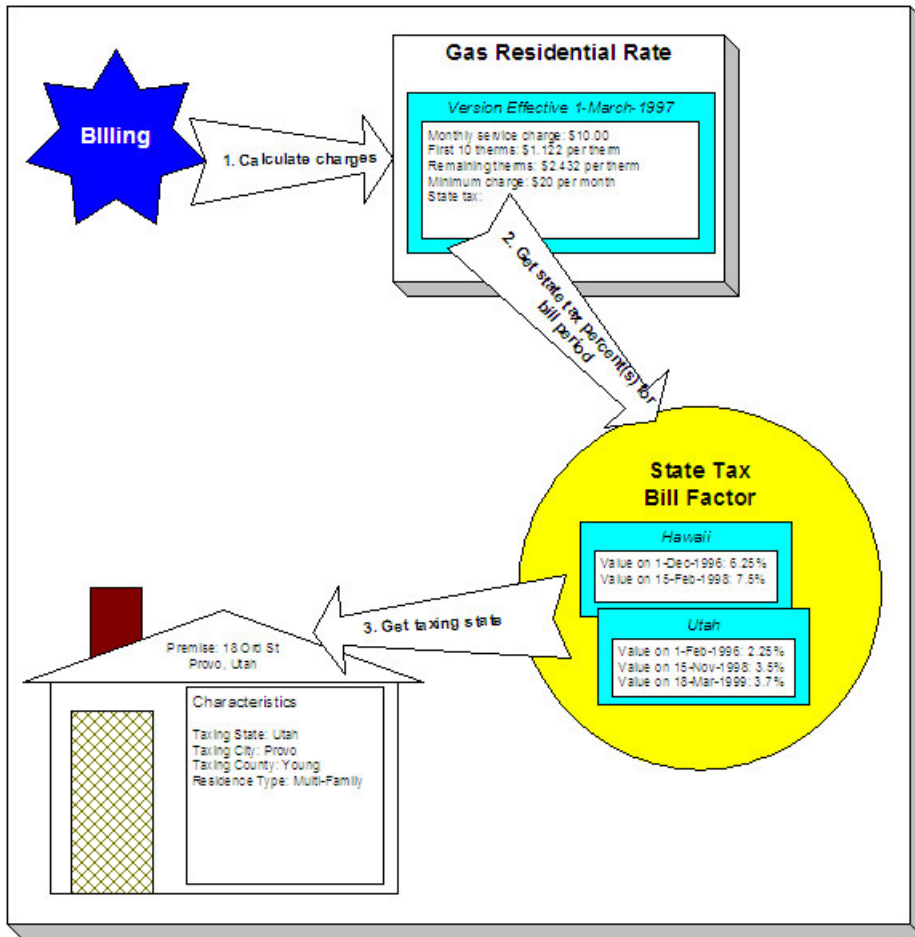

The following points describe the illustration:

- At billing time, the billing engine sends a request to a rate to calculate the charges for a customer's consumption.
- The rate calculates charges without bill factors until it encounters the calculation rule that levies state tax. This calculation rule references a bill factor. This means the rate must get the tax rate(s) in effect during the billing period from this bill factor.
- The state tax bill factor contains an attribute defining that the premise's taxing state characteristic controls the bill factor value. The bill factor therefore extracts the taxing state from the premise.

NOTE:

Deriving characteristic values. Rather than have the system extract the characteristic value from an entity, you can setup the system to derive the characteristic value when the rate is calculated. For example, if all of your customers are located in a single state, you may not want to maintain the taxing state on every premise. To do this, you could setup the rate to "hard code" a taxing state of say Hawaii. This is an advanced topic, but it may prove useful for your implementation. Refer to [Deriving / Passing In Characteristic Values](#) for the details.

- The premise returns the taxing state and the bill factor extracts the tax rate(s) in effect during the bill period and returns them to the rate.
- The rate applies the tax percents and returns the charges to billing.

NOTE:

Some bill factors don't need a characteristic. There are bill factors whose value does not differ based on a characteristic. For example, if your organization offers employee discounts, the discount percent is probably the same

for all employees and therefore this bill factor doesn't need a characteristic to select the bill factor value at billing time. However, because of the relational design of the system, every bill factor value must reference both a bill factor and a characteristic value. Therefore, if you have bill factors whose value is not related to a characteristic, you must specify a characteristic type on the bill factor with a characteristic value that is exactly the same as the characteristic type.

FASTPATH:

For more information about setting up characteristics, see [Setting Up Characteristic Types and Their Values](#) .

Deriving/Passing In Characteristic Values

In [An Illustration of a Bill Factor and Its Characteristics](#), we described how the system retrieves a characteristic value from a premise when a bill factor is encountered that uses a premise characteristic. This is a very common technique and is easy to understand. However, there are situations when an entity in Oracle Utilities Customer Care and Billing doesn't contain the appropriate characteristic value and therefore other techniques must be used. These techniques may not apply to your implementation, but they're worth understanding to help you form an intuitive understanding of rate application:

- There are implementations that only use the Oracle Utilities Customer Care and Billing rate engine. These implementations do not setup accounts, premises, etc. Rather, they simply setup their rate schedules, calculation rules, and bill factors. The rate engine is called from another application. This means the rate engine can't retrieve characteristic values from within Oracle Utilities Customer Care and Billing (because there are no objects where the characteristic values are defined). In this situation, the application that calls the rate engine must supply the characteristic types and values to be used when a bill factor requires this type of information.
- Assume you have a charge that is based on the account's customer class and the service agreement's revenue class. The characteristic value for this type of charge is not extractable through a single entity. Rather, the system must construct the characteristic value in real-time by concatenating information from the account and service agreement that is being billed. In this situation, you can use pre-processing calculation group to derive this characteristic type and value. This calculation group would create a characteristic type and value in real time by concatenating the account's customer class and the service agreement's revenue class. This characteristic type and value only exists in memory while the rate application executes.

When you setup a bill factor to use a characteristic whose value is derived or passed in, you need to define its characteristic source as Characteristics Collection. This source tells the system to extract the characteristic value from memory rather than extracting it from an object within the system.

NOTE:

The plug-in spots on a calculation rule have access to the Characteristics Collection. You might find this useful if you have a calculation rule that needs to calculate characteristic values for subsequent calculation rules.

Defining Bill Factors

You create a bill factor for every type of charge whose value is not specified directly in a calculation rule.

It is recommended to use two windows to set up a bill factor. On the first, you define general information describing how the bill factor is used in the system. On the second, you define all the characteristic values for the bill factor.

Defining General Bill Factor Information

Begin to define a bill factor by selecting **Menu > Rates > Bill Factor > Add**.

Description of Page

Enter a unique **Bill Factor** code and a **Description** for the bill factor.

Use **Bill Factor Type** to indicate if this bill factor uses Regular, Interval (i.e., real-time), or Time of Use values.

- **Regular.** Indicates that this bill factor's values are specified on [Bill Factor Value - Main](#) or on [Service Agreement - Contract Values](#).
- **Interval.** Indicates that this bill factor's values are specified on [Defining Interval Values](#)
- **Time of Use.** Indicates that this bill factor's values are specified on [Bill Factor TOU Values](#) or on [SA Interval Billing Info - TOU Contract Values](#) (**Note:** This option is only applicable to Component-Based Rates).

Enter a **Currency Code** to define the bill factor's denomination, or currency. This field is disabled if the bill factor is referenced on a calculation rule.

NOTE:

Bill factors referenced on a calculation rules must be denominated in the same currency as is the rate.

Select the **Value Type** to define the kind of value maintained by this bill factor. The Value Type options are:

- **Charge.** The value maintained in this bill factor is a fixed amount (e.g., a flat charge).
- **Percentage.** The value maintained in this bill factor is a percentage.
- **Unit Rate.** The value maintained in the bill factor is a price per service quantity.

This field is disabled if the bill factor is already referenced on a calculation rule or if the bill factor already has values

Turn on **Error If No Value** if the system should create a billing error when a bill factor value doesn't exist for the characteristic value linked to the customer. To clarify, understand that there are different types of bill factors:

- Those that should have a value for every customer whose rate references the bill factor. A bill factor used to levy the relevant state tax is a good example (assuming every state has a tax). For this type of bill factor, if the system cannot find a bill factor value for the taxing state, it must generate a billing error because data is missing from the system. You would turn on **Error if No Value** for this type of bill factor.
- Those that only have a value when the customer has a characteristic value that levies a charge. A bill factor used to levy the relevant city tax is a good example (because not all cities levy taxes). For this type of bill factor, if the system cannot find a bill factor value for the city in which the customer lives, the calculation rule will be skipped and no billing error will be generated. You would turn off **Error if No Value** for this type of bill factor

Bill factors used to levy taxes may or may not be eligible for tax exemptions; it's up to the respective taxing authority. Customers who are eligible for the tax exemption will have their tax obligation reduced (or nullified) at billing time. For bill factors that are eligible for tax exemptions, turn on **Tax Exemption**. If a service agreement is fully or partially exempt for the taxes defined by a given bill factor, the bill factor and the exemption information for the customer must be indicated on the Service Agreement page. This field will be disabled if the bill factor is referenced as being tax exempt in a service agreement.

FASTPATH:

For more information about how to make a customer tax exempt, refer to [Service Agreement - Tax Exemptions](#).

Some types of bill factors do not have the same value for all customers. Rather, their value may be unique for every customer or it may be unique for some customers and common for others. For example, you may have rates where the price per kilowatt-hour is defined for every customer using the rate. You may have other rates where certain customers have their own price per kilowatt-hour defined and other customers who use the value defined on the bill factor. For any type of bill factor where a customer may have their own unique price, turn on **Value In Contract Term**. For any service agreement that has a unique value for a given bill factor, the bill factor and the service agreement's value must be indicated on the [Service Agreement](#) page. When applying the rate for a bill factor of this type, the system will first check for the existence of

a contract value for the service agreement and if one is not found, it will use the value on the bill factor. This field will be disabled if a contract term referencing this bill factor exists.

NOTE:

The **Error if No Value** switch also affects what happens if there is no contract term for the bill factor. If the error switch is on, a billing error will be generated. If the error switch is off, no billing error will be generated and the calculation rule will be skipped.

FASTPATH:

For more information about how to specify a bill factor value in a customer's contract, refer to [Service Agreement - Rate Info](#).

Contract riders are used when the charge associated with the bill factor is only applicable to some customers for some period of time. For example, if a bill factor is used to provide a discount during the first 3 months of service, then a contract rider would be used. Turn on **Contract Rider Applicability** if the bill factor's applicability is contingent on the existence of a contract rider. This field will be gray if a contract rider referencing this bill factor exists on a service agreement.

FASTPATH:

For more information about how to establish a contract rider for a customer, refer to [Service Agreement - Contract Riders](#).

The proration information tells the system how to handle changes to bill factor values and their optional contract riders that may occur during a customer's bill period. Turn on **Allow Proration** if changes to the bill factor's value and/or contract riders should be prorated. If the **Bill Factor Type** is not specified as Interval and if changes should **not** be prorated, indicate the **Rate Selection Date Algorithm** to use when the system retrieves bill factor values or determines if contract riders are applicable.

If you have sub service agreements, turn on **Use Sub SA Contract** terms if billing should access contract riders, values, tax exemptions from the sub SA rather than the master. If this switch is off, the system will use the master SA's riders, contract value, and tax exemptions when it creates bills for a sub service agreement. Refer to [Sub Service Agreements](#) for more information.

If the Contract Management module is not **turned off**, which includes [umbrella agreement management](#), and you have checked either Tax Exemption, Value in Contract Term or Contract Rider Availability, indicate the **Terms of Service Usage**. Valid values are Check SA Only, Check TOS Only and Check TOS First, then SA. Refer to [Overriding Rate Terms](#) for details about how to set this value based on your business needs.

Bill Factor Tree

The right half of this page is dedicated to a tree that shows the bill factors characteristics and their respective values (for Regular bill factors) or interval value Sets (for Interval bill factors). You can use this tree to both view high level information about these objects and to transfer to the respective page in which an object is maintained by using the available Go To buttons.

Where Used

Many types of Rate Components may use a Bill Factor to define the price being charged. Refer to [Designing Calculation Groups and Rules](#) for more information.

The BILPC-TOTAL algorithm type that is used to levy late payment charges references the bill factor that defines the late payment charge percent. Refer to [SA Type - Main](#) for more information about this algorithm.

A Service Agreement references Bill Factors as follows:

- When a service agreement's Apply To calculation rule references tax exemptable bill factors AND the customer is tax exempt, the service agreement will define the bill factors from which the customer is exempt. Refer to [Service Agreement - Tax Exemptions](#) for more information.

- When a service agreement's rate references bill factors whose prices are customer-specific (i.e., specified on a contract term), the service agreement will contain prices for these bill factors. Refer to [Service Agreement - Contract Values](#) for more information.
- When a service agreement's rate references bill factors that are contingent on contract riders, the service agreement will define the rider period (if any) for these bill factors. Refer to [Service Agreement - Contract Riders](#) for more information.

Setting Up Bill Factor Characteristics

After defining general information about a bill factor, open **Menu > Rates > Bill Factor > Search** and navigate to the **Bill Factor Characteristics** page to define characteristic values where applicable. For example, a bill factor used to levy the applicable city tax would require the definition of every city that levies a tax.

NOTE:

If all values for a bill factor are specified in contract terms, you do not need to set up Bill Factor Characteristics.

Description of Page

Enter a **Characteristic Type** to indicate the type of characteristic that controls how the bill factor's value is defined. This field will be disabled if Bill Factor Characteristics are specified in the following grid.

The **Characteristic Source** defines where the system retrieves the characteristic value at billing time. The Characteristic Source options are:

Account	The characteristic type's value will be retrieved from the service agreement's account.
Characteristic Collection	Refer to Deriving / Passing In Characteristic Values for an explanation of this value.
Main Person	The characteristic type's value will be retrieved from the main person linked to the service agreement's account.
N/A	The characteristic type's value is the same for all customers using the rate. If this option is used, you must still choose a Characteristic Type. This Characteristic Type should have a single Characteristic Value. The ID of the characteristic value must be identical to the ID of the characteristic type.
Premise	The characteristic type's value will be retrieved from the service agreement's characteristic premise.
SA	The characteristic type's value will be retrieved from the service agreement.
SP	The characteristic type's value will be retrieved from the customer's service point. If multiple service points are linked to the service agreement, one will be chosen at random.

FASTPATH:

For more information about characteristics, see [Setting Up Characteristic Types and Their Values](#) and [An Illustration Of A Bill Factor And Its Characteristics](#).

Use the add and remove buttons to define the **Characteristic Values** that are relevant for the bill factor's Characteristic Type. For example, if the bill factor is used to levy a city tax, you would define the city's that have a city tax in the above collection.

Use the **Minutes Per Interval** if your Bill Factor is of type Interval. This defines, for each characteristic value, the number of minutes expected between each record of interval data.

Use the **External ID** if the values for this characteristic are interfaced to the system from an external source and you want to record an identifier for the source.

NOTE:

If the bill factor's value is the same for all customers, you still must link a "dummy" characteristic value to the bill factor. In other words, you'll have to create a characteristic type called "n/a" and define for it a characteristic value of "n/a". Then, on the bill factor, you reference the "n/a" characteristic type and on the above window, you indicate a characteristic value of "n/a".

Defining Bill Factor Values

After the bill factor and its characteristic values are defined, you define the price / percent and GL distribution associated with each bill factor characteristic. The topics in this section describe the pages used to set up this information.

Bill Factor Value - Main

After the bill factor and its characteristic values are defined, select **Menu > Rates > Bill Factor Value** to define the price / percent applicable to each bill factor characteristic.

IMPORTANT:

You do not set up Bill Factor Values for bill factors whose values are specified in an interval value data set or if all the values are customer specific and are defined as contract terms. Refer to [Defining Interval Values](#) for more information about interval value sets. Refer to [Service Agreement - Contract Value](#) for more information about bill factors in contract terms.

Description of Page

Enter the **Effective Date** and respective **Value** for the bill factor and characteristic value. The first date should be the earliest date on which the bill factor's charges are effective. Subsequent effective dates and values are required whenever the value changes.

NOTE:

Default note. A **Value** of 0, zero, will be defaulted.

Bill Factor Value - GL Distribution

Select **Menu > Rates > Bill Factor Value** and navigate to the **GL Distribution** page to define the GL account affected by the bill factor characteristic.

Description of Page

If the bill factor characteristic's charges are booked to a different GL account depending on the characteristic value, specify the appropriate **DistributionCode** for each **Revenue Class**.

IMPORTANT:

Specifying distribution codes on a bill factor is optional. You would only do this if the GL distribution code differs based on the characteristic value (such as, the city tax payable GL account differs depending on the city). If you do not enter the above information, the distribution code will be used.

The GL distribution code on the bill factor's value will not be used in the following cases:

- Value derived solely on contract value or contract value in combination with contract rider and/or tax exemption, where characteristic value is no longer used to determine the bill factor value.
 - Value derived in calculate service quantity and math calculation rules where multiple bill factors may be configured in the rule resulting to multiple values contributing to the calculation of the line amount.
-

Rate Schedule Execution

When a rate schedule is executed, the system executes the calculation rules contained in the calculation groups defined for the rate schedule as follows:

1. First, the system executes the calculation rules defined within Pre-Processing Calculation Groups.

- The rate engine may a bill segment calculation header for pre-processing calculations, if bill calculation lines are to be created.
- Calculation groups are executed in order according to the Sequence defined on the rate schedule.
- Calculation rules within each group are executed according to the Sequence configured within the group.

2. Next, the system executes the calculation rules within the Rate Version Calculation Groups. The system uses the Effective Date on each calculation group to determine which group(s) to execute. If more than one version of a calculation group is in effect during the billing period, the system may prorate the calculations, based on the configuration of the rate schedule.

- The rate engine creates a separate bill segment calculation header for each rate version calculation group.
- Calculation rules within each group are executed according to the Sequence configured within the group.

3. Finally, the system executes the calculation rules defined within Post-Processing Calculation Groups.

- The rate engine creates a separate bill segment calculation header for post-processing calculations.
- Calculation groups are executed in order according to the Sequence defined on the rate schedule.
- Calculation rules within each group are executed according to the Sequence configured within the group.

Additional Information.

- After every rate version calculation group is processed, the rate application returns the calculation details to the process that called it. This point is important as it means that rate application executes in memory (i.e., it does NOT insert the calculation details on the database, rather, it returns them to whatever process called rate application). Because rate application executes in memory, it can be used to perform billing calculations in many parts of the system. For example:
- Both online and batch billing use rate application to calculate the charges that are eventually saved on the bill's bill segments.
- The [Rate Check](#) transaction calls rate application when you want to check a rate real-time. When you use this transaction, you enter the consumption that's passed into rate application and then rate application shows you the calculation details that result.
- Plug-ins exist that call rate application to estimate bill segments when adequate billing history doesn't exist. For example, the BUDCALC-PH budget recommendation algorithm calls rate application to calculate a budget amount for a customer without adequate history. Another example is the DEPRECOM-MBT deposit recommendation algorithm. This plug-in calls rate application to calculate a recommended deposit amount for a customer without adequate history.

Understanding Calculation Groups and Rules

This section provides descriptions of calculation groups and calculation rules, and describes how to identify components of rates that can be defined using calculation rules and groups.

About Calculation Groups and Rules

This section includes descriptions of calculation groups and calculation rules.

About Calculation Groups

Calculation groups are collections of calculation rules that are applied to calculate quantities for billing and billing charges for service agreements.

As noted previously, calculation groups are associated with specific rate schedules in one of three ways:

- **Pre-Processing Calculation Groups:** These are generally used to derive service quantities or measure measured quantities. The following illustrate some use cases of when a pre-processing calculation group might be needed:
 - When a rate contains prices for things that aren't measured directly by the customers' meters. For example, if the rate calculates a charge based on a service agreement's contracted quantity.
 - When a meter measures something in a unit of measure that has to be converted into a different unit of measure before it can be rated. For example, a meter measures gas in cubic feet, but the rate contains prices in therms. During billing, a separate bill segment calculation header is produced for each Rate Version Calculation Group used to calculate charges. An additional calculation header is added if Pre-Processing Calculation Groups create bill calculation lines and by default, all these calculation lines are linked to a single calculation header. Before invoking the rate's Pre-Processing Calculation Groups, the rate engine processor builds the initial service quantity (SQ) collection based on the item collection and final values in the read collection.
- **Rate Version Calculation Groups:** These are the calculation groups used create a bill segment for the service agreement. Calculation rules that support rate version proration such as Service Quantity, Stepped Service Quantity, Item Type, Flat Charge, Maximum and Minimum Charge, must be executed only in a rate version calculation group. When the system creates a bill segment for a service agreement, it checks if multiple Rate Version Calculation Groups are in effect during the bill period. If so, it uses the rate's **Allow RV Proration** and **RV Selection Date** values to determine if it should prorate the various Rate Version Calculation Groups, or if it should pick one of the Rate Version Calculation Groups effective during the bill period. Rate Version Calculation Groups are executed after the rate's pre-processing calculation groups.
 - **Effective Date:** defines the date on which each rate version calculation group becomes effective.
 - **Description on Bill:** Specifies the description of the rate version calculation group on the bill. This description is saved on bill calculation details created using this rate version calculation group. Substitution characters may be used to substitute variables into the description during billing. Refer to [How To Use Description on Bill](#) in the [Defining Calculation Rules](#) chapter for a discussion of the various substitution variables.
- **Post-Processing Calculation Groups:** These are similar to Pre-Processing Calculation Groups, except that these are executed after the Rate Version Calculation Groups. The intended types of functionality include applying taxes on calculated charges, or deriving more complex GL distribution. Calculation rules that support rate version proration such as Service Quantity, Stepped Service Quantity, Item Type, Flat Charge, Maximum and Minimum Charge, are not designed to be executed in post and pre-processing calculation groups. During billing, a separate bill segment calculation header is produced for each Rate Version Calculation Group used to calculate charges. An additional calculation header is added if Post-Processing Calculation Groups create bill calculation lines and by default, all these calculation lines are linked to a single calculation header.

Calculation groups can also be referenced by "Execute Calculation Group" calculation rules. See "Execute Calculation Group Rules - Nesting Calculation Rules" in [About Calculation Rules](#) for more information.

About Calculation Rules

Calculation rules are standard and custom rules that perform calculations used when calculating quantities for billing and billing charges for a customer's service agreements.

Calculation rules are created for a specific calculation group. For example, if you were configuring two calculation groups and both included a specific calculation rule, you would need to create two instances of the calculation rule, one for each group.

Attributes used to define calculation rules typically include the following:

- **Basic Information:** Basic information about the calculation rule, including its name and description, the calculation group to which the rule belongs, the sequence of the rule within the group, the description that appears on the bill, and other information. This information is standard for most calculation rules.
- **Parameters:** The parameters used by the rule. Parameters are specific to each rule. See [Base Package Calculation Rule Descriptions](#) for details about the calculation rules included with the base package.

Execute Calculation Group Rules - Nesting Calculation Rules

Execute Calculation Group rules are used to define business logic to allow reference to a separated specified calculation group. This allows rules that are used frequently to be bunched under a single calculation group, which can be referenced / called by other rules as needed. For example, if a set of standard rules should be applied to all rate schedules, this set of rules can be configured as part of a calculation group, which is referenced by a single calculation rule of this type. Execute Calculation Group rules use the following options:

- **Referred Calculation Group:** defines the calculation group referenced by the rule.
- **Characteristics:** defines additional calculation rule attributes that may be used in rate processing or for reporting purposes. A calculation rule's characteristics are copied onto the resultant bill lines for those characteristic types that are allowed on bill segment calculation lines.

NOTE: There is a limit of 99 calculation groups that can be called from a calculation group defined directly on a rate schedule or via related child calculation groups when using Execute Calculation Group calculation rules.

Eligibility Criteria

Calculation rule eligibility criteria are user-definable conditions that could cause a given calculation rule to be applied or skipped. This can involve the evaluation of some attribute of the service agreement, or service point, or something else entirely.

A calculation rule can have multiple eligibility criteria for determining if the rule should be applied or skipped, based on a user-defined sequence. Each eligibility criteria uses the following settings:

- **Criteria Comparison:** defines the specific comparison for the criteria, based on the following:
 - **Criteria Field Type:** the means used to retrieve the value of the criteria field (algorithm, bill factor, calculation line, characteristic, contract quantity, service quantity, or historic service quantity)
 - **Comparison Operator:** the operator used in the comparison
 - **Comparison Value:** a user-specified value to which the retrieved value is compared (using the comparison operator)
- **Comparison Results:** defines how the rule should behave, based on the results of the comparison defined under Criteria Comparison:
 - **If True:** the action to take if the comparison is true
 - **If False:** the action to take if the comparison is false

- **If Insufficient Data:** the action to take if there is insufficient data to perform the comparison

Calculation Line Category Types

Calculation line category types are used to establish connections between calculation rules. Calculation rules can specify a member category and value to which they belong. When this same category and value are referenced as a "Target Category" by other rules (the rule is applied to the results of rate version calculation rules (defined in the same rate schedule) that belong to the category and value.

For example, calculation rules whose results are subject to taxes might belong to the "Subject to Tax" (TAXABLE) category and "County Tax" value. Apply To calculation rules defined for the same rate schedule with a target category of "Subject to Tax" and "County Tax" values are applied to "Subject to Tax" member rules.

Calculation Line Category Types are defined by the following:

- **Calculation Line Category Type:** The unique identifier of a calculation line category type definition
- **Description:** The description of the calculation line category type.
- **Category Values:** The valid category values for the calculation line category type.

Base Package Calculation Rules

Oracle Utilities Customer Care and Billing includes the following base package calculation rule types that can be used when creating calculation rules:

- **Apply To:** Used to create bill lines that levy charges based on amounts calculated on other bill lines.
- **Calculate Final Reading Values:** Used to determine the final values for readings based on user-defined UOM/TOU/SQI.
- **Calculate Service Quantity:** Used to derive or calculate a service quantity that is eventually inserted into the bill segment SQ collection.
- **Copy Service Quantity From Master Bill Segment:** Used to copy all the entries from the master bill segment SQ collection to the sub bill segment SQ collection.
- **Execute Calculation Group:** Used to call and pass parameters to another calculation group.
- **Flat Charge:** Used to create bill lines that levy service charges and fees that aren't based on how much the customer uses.
- **Item Type:** Used to create bill lines that levy charges based on the number and type of items used by a customer. The system keeps track of items on the service point(s) linked to the customer's service agreement.
- **Math:** Used to derive interval data based on a formula, and apply TOU mappings and/or other operations to the derived data to calculate service quantities
- **Maximum Charge:** Used to create bill lines that levy charges only when the sum of previously calculated lines is more than the maximum charge amount.
- **Minimum Charge:** Used to create bill lines that levy charges only when the sum of previously calculated lines is less than the minimum charge amount.
- **Service Quantity:** Used to create bill lines that levy charges based on some type of consumption.
- **Simple Summary:** Used to create a "subtotal" on the bill, by summarizing bill lines produced by other calculation rules in the same calculation group.
- **Stepped Service Quantity:** Used to create bill lines that levy charges based on some type of consumption when different prices are applied to different ranges of consumption (for example, the first 50 kWh are \$0.43 per kWh, anything in excess of 50 kWh is charged at \$0.71 per kWh)
- **Summary:** Used to create a "subtotal" on the bill. It exists purely for reporting and informational purposes.

See [Base Package Calculation Rule Descriptions](#) for details about each of these calculation rules.

Designing Calculation Groups and Rules

Before starting to design calculation groups and rules for your rates, please review the concepts outlines in the **Designing Rate Components** section in the [Rates](#) chapter. That section provides a good background for understanding how to break down rates into component pieces that can be modeled by calculation groups and rules.

This section provides guidelines for how to design and plan the calculation groups and rules you will need for your rates, and provides a simple case study of how to define the calculation rules and groups you might use for a set of rates for a small municipal electric company.

Analyzing Your Rates and Identifying Calculation Rules and Groups

One of the steps you will go through when implementing your rates is to look at the bill lines for your rates and ask yourself what are the variables that cause each line's charges to be calculated the way they are. After you've determined all of the potential bill lines you can start designing your calculation groups and rules. Typically, you create one calculation rule for every line that can appear on the customer's bill. These rules can be grouped in different configurations based on how you want your bills to appear and the needs of your implementation. Recall that bill segment calculation headers are created for Pre-Processing, Rate Version, and Post-Processing calculation groups. In addition, most rules can be configured generate a bill line.

Best Practices

When designing calculation groups and rules, the following general rules apply:

- **Pre-Processing Calculation Groups.** Perform any initial processing or conversions that should occur before the rate version calculation group. This can include:
 - Calculating the number of days in a billing period (Calculate Service Quantity)
 - Calculating service quantities that are not measured (demand, kVa, etc.) (Calculate Final Reading Values, Calculate Service Quantity, Math)
 - Validating that consumption is within tolerances set by the rate (residential limits, etc.) (Calculate Service Quantity, with eligibility criteria)
- Calculations processed by calculation rules should be performed by **Rate Version Calculation Groups.** This includes most charge calculations, including:
 - Charges based on service quantities (Service Quantity, Stepped Service Quantity)
 - Customer charges (Flat Charge)
 - Minimum/maximum charges (Minimum Charge, Maximum Charge)
 - Discounts (Apply To)
 - Taxes (Apply To)
 - Summaries (Summary, Simple Summary)
- Additional processing should be performed by **Post-Processing Calculation Groups.** This can include:
 - Allocating consumption/revenue (energy revenue vs. demand revenue) (Service Quantity)

Example Configurations

Let's look at a couple of different possible configurations for a simple electric rate that includes the following:

- Customer Charge
- Service Charge (price per kWh)

- Minimum Charge
- Discount

This rate could be set up in the following ways:

- A single Rate Version calculation group that contains a calculation rule for each of the above
- A set of Rate Version calculation groups as follows:
 - A calculation group for "flat" charges, such as the Customer Charge
 - A calculation group for consumption-based charges (including the Service Charge and Minimum Charge).
 - A calculation group for discounts or other charges applied to the total of other charges (which would include the Discount)

There are no hard and fast rules concerning how calculation rules should be grouped. How this is done should be based on the specific needs of the implementation but it's a good idea to look for ways to keep your configuration simple for maintenance and upkeep purposes. This includes changes to existing rates as well as adding/removing rates over time.

Reusing Calculation Rules

One of the steps you will go through when implementing your rates is to look at the bill lines for your rates and ask yourself what are the variables that cause each line's charges to be calculated the way they are. After you've determined all of the potential bill lines you can start designing your calculation groups and rules. Typically, you create one calculation rule for every line that can appear on the customer's bill. These rules can be grouped in different configurations based on how you want your bills to appear and the needs of your implementation. Recall that bill segment calculation headers are created for Pre-Processing, Rate Version, and Post-Processing calculation groups. In addition, most rules can be configured generate a bill line.

Identifying Calculation Rules that can be Shared/Reused

As you analyze the bill lines used by your rates, you should look for bill lines that utilize similar or identical variables or calculations. These calculations are candidates for reuse. For example, if all of your residential rates offer a discount for early payment, you would want to create a single rule to calculate that discount, and then use it each of the rates to which it applies.

How to Reuse Calculation Rules

There are two approaches that can be used to reuse calculation rules.

- **Encapsulating Rules in a Calculation Group**

This approach involves grouping rules that can be applied to more than one rate into a single calculation group. You would use this approach when you identify charges and other components in your rates that apply to multiple rates, but that can be grouped together. Taxes for multiple types of jurisdictions (for example, State, County, and City) would be suitable for this approach.

To use this approach, you simply create a calculation group that contains the rules to be applied to more than one rate. For the tax example, you might create the following group and rules:

Calculation Group: Taxes, which includes:

Calculation Rule: State Tax (Apply To)

Calculation Rule: County Tax (Apply To)

Calculation Rule: City Tax (Apply To)

This "Taxes" calculation group can be included as a Rate Version Calculation Group in each of the rates to which the taxes apply. This calculation group could also be referenced by an "Execute Calculation Group" rule, as outlined below.

- **Using "Execute Calculation Group" Rules**

This approach involves creating a calculation group that contains one or more rules, which is then referenced by another "Execute Calculation Group" rule. This approach can be used when you identify a charge or calculation that could be applicable within one or more calculation groups. For example, if multiple rates involve calculating peak demand (or some other quantity that is not measured by your customers' meters), you could create a "Calculate Demand" rule and include it in a group that is then referenced by an "Execute Calculation Group" rule.

To use this approach, you create a calculation group that contains the calculation rules to be used within multiple calculation groups. You then create an "Execute Calculation Group" rule that references the group. Last, you include this "Execute Calculation Group" rule in the calculation groups to which it applies. For the calculate demand example, you might create the following:

Calculation Rule: Calculate Demand (Execute Calculation Group), which references:

Calculation Group: Calculate Demand, which includes:

Calculation Rule: Calculate Demand (Calculate Service Quantity)

The "Calculate Demand" Execute Calculation Group rule can be included in any calculation group used to calculate service quantities that includes calculating peak demand.

"Execute Calculation Group" rules can be used with any calculation group. To return the taxes example from above, if you wanted to include your "Taxes" calculation group within other groups, you could use the following:

Calculation Rule: Taxes (Execute Calculation Group), which references:

Calculation Group: Taxes, which includes:

Calculation Rule: State Tax (Apply To)

Calculation Rule: County Tax (Apply To)

Calculation Rule: City Tax (Apply To)

See "Execute Calculation Group Rules - Nesting Calculation Rules" in [About Calculation Rules](#) for more information about Execute Calculation Group rules.

Leveraging Eligibility Criteria to Dynamically Apply Calculation Rules

Another tool to consider when creating your calculation groups and rules is Eligibility Criteria. Eligibility criteria allow you to define rules that determine the conditions under which a calculation rule is applied or not.

For example, if you need to calculate demand for one or more of your rates, you might create separate calculation rules to calculate demand based on interval values of different units of measure (kWh vs kVarh for instance). You could create rules for each and include them in a single "Calculate Demand" calculation group, but assign eligibility criteria to each such that they are only executed when processing for the specified unit of measure.

See Eligibility Criteria in [About Calculation Rules](#) for more information about eligibility criteria and how they can be used with calculation rules. In addition, refer to **The Big Picture of Rate Component Eligibility Rules** in the [Rates](#) chapter for additional background on eligibility criteria.

Case Study: Three Sample Rates

Let's look at a sample set of rates, and how they might be implemented. We'll also look at which components of these rates can be shared.

Rates

The following rates are electric rates offered by a small municipal electric company.

Rate	Domestic Rate A	Commercial Rate B	Power Rate C
Cost of Service	Stepped charges, as follows:	Stepped charges, as follows:	1. Customer Charge:\$52.00

Rate	Domestic Rate A	Commercial Rate B	Power Rate C
	<p>\$3.08 for the first 10 kWh or less, plus</p> <p>19.23 cents per kWh for the next 40 kWh, plus</p> <p>15.44 cents per kWh for the next 150 kWh, plus</p> <p>14.93 cents per kWh for the next 300 kWh, plus</p> <p>14.71 cents per kWh for all kWh in excess of 500 kWh</p>	<p>\$2.95 for the first 10 kWh or less, plus</p> <p>19.23 cents per kWh for the next 40 kWh, plus</p> <p>18.85 cents per kWh for the next 50 kWh, plus</p> <p>16.86 cents per kWh for the next 400 kWh, plus</p> <p>15.45 cents per kWh for the next 3,000 kWh, plus</p> <p>14.87 cents per kWh for all kWh in excess of 3,500 kWh.</p>	<p>2. Demand: \$11.44 per KW</p> <p>3. Energy: \$11.28 cents per KWH</p> <p>Billing Demand</p> <p>The Billing Demand for any month shall be the greater of the following:</p> <ol style="list-style-type: none"> 1. The maximum 15 minute measured demand during the month as measured in kilowatts, or 2. 70% of the maximum 15 minute measured demand as so determined during the preceding 11 months.
Discount	<p>Discount of ½ cent per kilowatt-hour after the first 10 kilowatt-hours, if paid on or before the discount expiration date.</p> <p>For qualifying elderly residents, an additional 10% discount is allowed on the basic rate if paid on or before the discount expiration date and no arrears exist on their accounts.</p>	Discount of ½ cent per kilowatt-hour after the first 10 kilowatt-hours, if paid on or before the discount expiration date.	Discount of 10% exclusive of purchased power and fuel adjustment charge paid on or before the discount expiration date.
Purchased Power and Fuel Adjustment	<p>An upward or downward adjustment applied to all kWh sold, based on the total cost of purchased power and fuel compared to the portion of that cost contained in the base rate (11.615 cents/kWh).</p> <p>The purchase power and fuel adjustment shall be rounded to the sixth decimal place and shall be applied to all kilowatt-hours sold in the following month.</p>	See Domestic Rate A	See Domestic Rate A
Misc.	N/A	N/A	Minimum Bill The Customer Charge
Taxes	State, County, and City Taxes	State, County, and City Taxes	State, County, and City Taxes

Calculation Rules

Now let's look at these same rates in terms of how we might implement them using calculation rules. The table below lists the type of calculation rule used for each item on the rate.

Rate	Domestic Rate A	Commercial Rate B	Power Rate C
Cost of Service	Stepped Charges:	Stepped Charges:	Customer Charge: <ul style="list-style-type: none"> • Flat Charge calculation rule

Rate	Domestic Rate A	Commercial Rate B	Power Rate C
	<ul style="list-style-type: none"> Stepped Service Quantity calculation rule Minimum Charge calculation rule (note that the first tier is a fixed price for the first 10 kWh or less) 	<ul style="list-style-type: none"> Stepped Service Quantity calculation rule Minimum Charge calculation rule (note that the first tier is a fixed price for the first 10 kWh or less) 	Demand: <ul style="list-style-type: none"> Service Quantity calculation rule Math calculation rule (to calculate demand from interval values)* Energy: <ul style="list-style-type: none"> Service Quantity calculation rule *Could be included in either a Pre-Processing or Rate Version Calculation Group
Discount	Discount: <ul style="list-style-type: none"> Apply To calculation rule Elderly Discount: <ul style="list-style-type: none"> Apply To calculation rule 	Discount: <ul style="list-style-type: none"> Apply To calculation rule 	Discount: <ul style="list-style-type: none"> Apply To calculation rule
Purchased Power and Fuel Adjustment	PPF Adjustment: <ul style="list-style-type: none"> Service Quantity calculation rule Note: The PPF adjustment rate would be defined as a Bill Factor, updated monthly based on the prior month's total cost.	PPF Adjustment: <ul style="list-style-type: none"> Service Quantity calculation rule 	PPF Adjustment: <ul style="list-style-type: none"> Service Quantity calculation rule
Misc.	N/A	N/A	Minimum Bill: <ul style="list-style-type: none"> Minimum Charge calculation rule
Taxes	State, County, and City Taxes: <ul style="list-style-type: none"> Apply To calculation rule (one for each type of tax) 	State, County, and City Taxes: <ul style="list-style-type: none"> Apply To calculation rule (one for each type of tax) 	State, County, and City Taxes: <ul style="list-style-type: none"> Apply To calculation rule (one for each type of tax)

Shared Components

Now, let's look at the components of these rates that can be shared.

Discounts: Rates A and B both use the same discount, so we could create a single "AB Discount" calculation rule that could be used with both rates. Note: Either this could be in its own calculation group that is listed among the Rate Version Calculation Groups for each rate, or the group could be referenced by an "Execute Calculation Group" rule which in turn would be included in one of the other Rate Version Calculation Groups used in each rate.

Purchased Power and Fuel Adjustment: Rates A, B, and C all use the same adjustment for purchased power and fuel, so we could create a single "PPF Adjustment" calculation rule that could be used with all three rates. Again, this calculation rule could be in its own calculation group listed on the rate, or in a group referenced by an "Execute Calculation Group" rule included in another group.

Taxes: Rates A, B, and C are all subject to the same taxes, so we could create calculation rules for each type of tax (State, County, and City) in a single group that could be used with all three rates. Again, these calculation rules could be in their

own calculation group listed on the rate, or in a group referenced by an "Execute Calculation Group" rule included in another group.

The Big Picture of Calculation Rule Eligibility Rules

You can use eligibility rules to define the criteria when a calculation rule should be applied (or skipped); for example,

- You may have a calculation rule that generates an employee discount. This calculation rule may have eligibility criteria that requires the person to have a given characteristic type and value (this assumes you use a person characteristic to identify employees) before the calculation rule is applied.
- You may have a calculation rule that applies a surcharge if the customer uses 25% more than they used in the same period in prior year.

NOTE:

Eligibility rules are optional. If you add eligibility rules to a calculation rule, the calculation rule will be skipped or applied per the instructions in the rules. If you don't add eligibility rules to a calculation rule, however, the calculation rule will be executed – this is because calculation rules are eligible by default

The topics in this section describe eligibility rules.

A Rate Component is Eligible by Default

If you don't want to setup eligibility rules, you don't have to. If you don't specify eligibility rules on a calculation rule, it's eligible and will be processed by rate application.

Defining Logical Eligibility Criteria

When you setup an eligibility criterion, you must define three things:

- The field to be compared
- The comparison method
- The comparison results

Criteria Comparison

You have the following choices in respect of identifying the **Criteria Field Type**:

- **Algorithm.** You can execute an algorithm to retrieve a field value from someplace else in the system. This is a very powerful feature, but it's not terribly intuitive. We'll present an example later in this section to illustrate the power of this approach.
- **Bill Factor.** You can retrieve a bill factor value to use as a field value in the comparison.
- **Calc Line.** You can retrieve a calculation line amount to use as a field value. The value is derived by summing calculation lines defined as members of a target category.
- **Characteristic.** You can retrieve a characteristic value linked to any of the following:
 - The service agreement being billed
 - The service agreement's account
 - The main person linked to the service agreement's account

- The characteristic premise linked to the service agreement
- One of the service points linked to the service agreement
- In addition, you can retrieve a characteristic value from the Characteristic Collection where values are derived while the rate is being calculated (characteristic values can be created by calculation rules)
- **Contract Quantity.** You can retrieve a contract quantity for the service agreement.
- **Service Quantity.** You can retrieve the value of a given service quantity from the SQ collection based on a specified UOM / TOU / SQL.
- **Historical Quantity.** You can derive a value based on the service agreement's historical bill segment service quantities for the specified UOM / TOU / SQL.

You have the following choices in respect of identifying the **Comparison Method**:

- You can choose an operator (e.g., >, <, =, BETWEEN, IN, etc.) and a comparison value

Comparison Results

Once you have this information and have applied your comparison, you must define what action should be taken. You must specify what to do if the results are True, False, or Insufficient Data.

- **If True or False.** You have the option to apply the rule or not, or check the next condition.
- **If Insufficient Data.** You have the option apply the rule or not, check the next condition, or generate an error.

See [Examples of Calculation Rule Eligibility Rules](#) for illustrations of these rules.

Examples of Calculation Rule Eligibility Rules

The topics in this section provide examples about how to setup calculation rule eligibility rules.

A Calculation Rule with a Service Quantity Comparison

Imagine a calculation rule that is only eligible if the customer is a low-income customer and has used more than 1,000 kWh. This calculation rule would need the following eligibility rules:

- Customer is a low income customer
- The customer has used more than 1,000 kWh during the bill period

These rules will look as follows:

Seq	Field to Compare	Comparison Method	If TRUE	If FALSE	If Insufficient Data
10	Main person characteristic: Characteristic type = Low income indicator	= YES	Check next condition	Do Not Apply Rule	Do Not Apply Rule
20	SQ value: UOM = KWH	>= 1,000	Apply Rule	Do Not Apply Rule	Error

The criteria are similar - they retrieve a value and compare it to something:

The first criterion is fairly simple:

- **Field to Compare.** We indicate that the value of the Low Income Indicator characteristic is kept on the main person linked to the account should be retrieved. We assumed that this characteristic type has values of YES and NO.
- **Comparison Method and Results.** We indicate that if the person has a characteristic value of YES, then we should check the next condition; otherwise, we indicate if the eligibility rule is false or there is insufficient data, the calculation rule is skipped.

The second criterion works similarly:

- **Field to Compare.** We indicate the service quantity (SQ) that holds the total amount of KWH that should be retrieved.
- **Comparison Method and Results.** We simply compare the value to 1,000. If the SQ is greater than or equal to 1000, the eligibility rule is True and the calculation rule is applied. If the SQ is less than 1000, the eligibility rule is false and the calculation rule is skipped. If there is insufficient data, there is an error generated.

A Calculation Rule with a Characteristic Lookup and Consumption Comparison

Imagine a calculation rule that is eligible for customers who have signed up for a consumption reduction program and have low consumption. This would require the following criteria:

- Check that the customer has signed up for the reduction program.
- Check to see that the customer's consumption is lower than the threshold.

These rules will look as follows:

Seq	Field to Compare	Comparison Method	If TRUE	If FALSE	If Insufficient Data
10	Check if the customer has signed up for the reduction program	= Y	Check next condition	Do Not Apply Rule	Do Not Apply Rule
20	Check if consumption is less than the threshold	< = 100 Kilowatt	Apply Rule	Do Not Apply Rule	Do Not Apply Rule

The criteria are similar - they retrieve a value and compare it to something:

The first criterion works as follows:

- **Field to Compare.** We indicate the value of the reduction program characteristic type (CI_CLMSM) is found on the service agreement. We assumed that this characteristic type has values of Y and N.
- **Comparison Method and Results.** Comparison Method and Results. We indicate that if the service agreement has a characteristic value of Y, then we should check the next condition. If the condition is false or insufficient data, the calculation rule is skipped.

The second criterion works as follows:

- **Field to Compare.** We indicate the service quantity (SQ) that holds the total amount of KW that should be retrieved.
- **Comparison Method and Results.** We indicate that we want to compare the service quantity to the threshold (100 kW). If the service agreement's bill segment has a service quantity that is less than or equal to 100 kW, it is True and the calculation rule is applied. If the condition is false or insufficient data, the calculation rule is skipped.

A Calculation Rule with a Discount for Being on Autopay

Imagine a calculation rule that is only eligible if the current customer has signed up for Autopay. This calculation rule would need the following eligibility rule:

- Customer has Autopay

This rule will look as follows:

Seq	Field to Compare	Comparison Method	If TRUE	If FALSE	If Insufficient Data
10	Algorithm: check if customer has Autopay	= Y	Apply Rule	Do Not Apply Rule	Do Not Apply Rule

The criterion calls an algorithm that performs a logical comparison.

The criterion works as follows:

- **Field to Compare.** We chose a "field to compare" algorithm that checks if the account associated with the bill segment is on Autopay. If an autopay setup exists, then it returns a value of Y. If not, however, it returns N
- **Comparison Method and Results.** We simply compare the value returned by the algorithm to Y and indicate the appropriate response. If the condition is true, the calculation rule is applied. If the condition is false or insufficient data, the calculation rule is skipped.

NOTE:

Refer to CI_CHK_APAY for more information about this algorithm.

Working with Calculation Groups and Rules

This section outlines how users work with calculation groups and calculation rules.

Defining Calculation Groups

Use this procedure to define calculation groups.

- Select **Menu > Rates > Calculation Group > Add.**
- Enter a **Name** for the calculation group.
- Enter a short **Description** and **Detailed Description** for the group.
- Click **Save.**

NOTE: You can also add a calculation group directly from the Rate Schedule portal. The **Add Calculation Group** action on the Pre-Processing Calculation Groups, Rate Version Calculation Groups and Post-Processing Calculation Groups sections allows you to create the calculation group and link the new group to the Rate Schedule.

To add a calculation rule to the calculation group, click the **Add Rule** link in the **Calculation Rules List** zone title bar. See [Defining Calculation Rules](#) for more information about creating calculation rules.

You can now create calculation rules for this group.

See [About Calculation Groups](#) for more information about calculation groups.

Searching and Maintaining Calculation Groups

Use this procedure to search for and view a calculation group.

- Select **Menu > Rates > Calculation Group > Search.**
- Enter your search criteria.

You can search by **Calculation Group** name or **Description**.

- Click **Refresh**.
- In the search results list, click the **Description** link for the calculation group you want to view or edit. The selected calculation group is displayed in the **Calculation Group** portal. You use this portal to maintain calculation groups. This portal includes the following zones:
 - **Calculation Group**: Defines basic information about calculation group
 - **Calculation Rules List**: lists the calculation rules belonging to the group. Eligibility criteria referenced by a calculation rule are listed indented beneath each rule. If a calculation rule in turn references a calculation group, the calculation group executed by the rule is displayed.
 - **Referencing Rates Schedules List**: lists the rates schedules that reference the group
 - **Referencing Calculation Rules List**: lists the calculation rules that reference the group

Use this procedure to maintain a calculation group:

- Select **Menu > Rates > Calculation Group > Search** to navigate to the Calculation Group Query portal.
- Search for and select the appropriate calculation group.
- Click **Edit**, **Delete**, or **Duplicate** as appropriate.
- To add a calculation rule to the calculation group, click the **Add Rule** link in the **Calculation Rules List** zone title bar. See [Defining Calculation Rules](#) for more information about creating calculation rules.
- To update the sequence values for all calculation rules in the group, click the **Resequence All Rules** link in the **Calculation Rules List** zone title bar.
 - Edit the sequence values for all rules by specifying new **Start Sequence** and **Increment By** values.
 - Click **OK** to update the calculation rules with new sequence numbers.
- To Edit or Delete a specific calculation rule in the group, select the **Edit** or **Delete** icon in the Calculation Rules List zone as appropriate.
- To Delete one or more of the calculation rules in the group:
 - Select one or more of the calculation rules you want to delete.
 - Click **Delete Calc Rules**.
 - Click **OK** to delete the selected calculation rules
- To update the bill print details for one or more of the calculation rules in the group:
 - Select one or more of the calculation rules for which you want to change the bill print details.
 - Click **Update Bill Print**.
 - Edit the bill print details for the selected calculation rules.
 - Click **Save** to update the selected calculation rules with the new bill print details.
- To change the sequence values for one or more of the calculation rules in the group:
 - Select one or more of the calculation rules for which you want to change the sequence values.
 - Click **Resequence Rules**.
 - Edit the sequence values for all the selected calculation rules.
 - Click **Save** to update the selected calculation rules with the new sequence values.

See [About Calculation Groups](#) for more information about calculation groups.

Defining Calculation Line Category Types

Use this procedure to define calculation line category types.

- Select **Menu > Rates > Calculation Line Category Type > Add.**
- Enter a **Category Type** name for the category type.
- Enter a short **Description** and **Detailed Description** for the category type.
- Define the **Category Value** and **Description** for each value for the category type.
- Click **Save.**

You can now reference this category and its values as either the Member Category or Target Category on calculation rules.

See "Calculation Line Category Types" in [About Calculation Rules](#) for more information about calculation line category types.

Maintaining Calculation Line Category Types

Use this procedure to search for and maintain calculation line category types.

- Select **Menu > Rates > Calculation Line Category Type > Search.**
The **Calculation Line Category Type List** zone displays the calculation line category types defined in the system.
- Click the broadcast icon for the calculation line category type you wish to view and/or edit.
The selected calculation line category type is displayed in the **Calculation Line Category Type** zone.
- Click **Edit, Delete,** or **Duplicate** as appropriate.

See "Calculation Line Category Types" in [About Calculation Rules](#) for more information about calculation line category types.

Defining Calculation Rules

Use this procedure to define calculation rules.

- Select **Menu > Rates > Calculation Rule > Add.**
- Select the **Calculation Group** to which the rule will belong.
- Select the **Calculation Rule BO** for the calculation rule.
Refer to [Base Package Calculation Rule Descriptions](#) for detailed descriptions of the available calculation rules and their associated business objects.
- Enter name for the **Calculation Rule.**
- Enter the **Sequence** for the rule. This designates the order in which the rule will be executed within its parent calculation group.
- Enter a short **Description** and **Detailed Description** for the rule.
- Enter or select other parameters for the rule as appropriate.
Refer to [Base Package Calculation Rule Descriptions](#) for detailed descriptions of the available calculation rules and the parameters used by each.
- Click **Save.**

See [About Calculation Rules](#) for more information about calculation rules.

How to Use Description on Bill

Enter the verbiage to appear on the bill segment in the **Description On Bill**. Turn on **Print** if the verbiage should appear on the printed bill.

NOTE:

Suppressing calculation details on the printed bill. Only calculation rules that are used to calculate intermediate values are typically suppressed on a bill. For these types of calculation rules, we recommend using **Description on Bill** to show users how the line was calculated, but select No from the **Print** dropdown menu. This way, users will see the calculation details on the [Bill Segment - Calc Lines](#) window, but the customer won't see it on their bill.

Many lines that appear on a bill do not contain static verbiage. Rather, the printed lines contain information from the calculation process. For example, the bill line for state tax would typically contain the tax percent.

You control exactly what is substituted in the bill line by entering one or more of the following substitution variables in the **Description on Bill** field:

NOTE: If none of the following substitution characters satisfy your need, there is a plug-in option on the calculation rule business object that allows customer modified variables. Algorithms can be attached to the business object as a Build Line Description system event.

Substitution Character	What It Does
%A	<p>Replaces the substitution character with the amount of the bill line.</p> <p>Please be aware of the following:</p> <ul style="list-style-type: none">• If the calculation rule isn't designated as being "for calculation purposes only" (FCPO), all trailing zeroes up to the decimal position of the rate's currency will be removed. If the calculation rule is designated as being "for calculation purposes only" (FCPO), the number of decimal places as defined in the calculation rule's precision will be shown.• All leading zeroes will be removed unless the value is between 1 and -1 in which case a leading 0 will appear before the decimal place.• The Symbol on the Currency control table will prefix the value.• The position of the negative sign and currency symbol is dependent on the display profile of the user who generate the bill (or who submitted the batch billing process).
%B	<p>Replaces the substitution character with the begin/start date covered by the bill calculation line.</p> <p>If the charge is proratable, %B may be used in conjunction with %E to display the period covered by the bill calculation line.</p>
%C	<p>Replaces the substitution character with the number of items being billed. Leading zeroes are suppressed.</p>
%D	<p>Replaces the substitution character with message 10101 from message category 11109. This message is maintained in the standard message table.</p>

We recommend this message be set to "(prorated for %1 of %2 days)" where %1 will be substituted with the number of days of prorated consumption charged on the bill line and %2 will be the "normal" days associated with the rate's prices. This message will only be substituted when the calculation rule is prorated. Note, neither %1 nor %2 are required.

Either this character OR %F should be used when you desire to substitute the price / percent into the bill line.

If the charge is proratable, %D should be used in conjunction with %R to print an appropriate message when the charges are prorated.

%E

Replaces the substitution character with the end date covered by the bill calculation line.

If the charge is proratable, %E may be used in conjunction with %B to display the period covered by the bill calculation line.

%F

Replaces the substitution character with message 10102 from message category 11109. This message is maintained in the standard message table.

We recommend this message be set to "(prorated by %1)" where %1 will be substituted with the factor used to prorate the charge. This message will only be substituted when the calculation rule is prorated. Note, %1 is not required.

If the charge is proratable, %F should be used in conjunction with %I to print an appropriate message when the charges are prorated.

%H

Replaces the substitution character with the high value defined on the calculation rule used to calculate the specific stepped charge on the bill line.

%I

Replaces the substitution character with the value specified in the calculation rule / bill factor.

If the value is a percent,

- all leading and trailing zeroes will be suppressed,
- and a "%" will be suffixed to the resultant value.

If the value is not a percent,

- all trailing zeroes up to the decimal position of the rate's currency will be removed,
- and all leading zeroes will be removed unless the value is between 1 and -1 in which case a leading 0 will appear before the decimal place,
- and note that the position of the negative sign and currency symbol is dependent on the display profile of the user who generate the bill (or who submitted the batch billing process).

Either this character OR %R should be used when you desire to substitute the price / percent into the bill line. Using %I will cause the value as specified in the calculation rule to be substituted regardless of whether the charges are prorated.

If the charge is proratable, %I should be used in conjunction with %F to print an appropriate message when the charges are prorated.

%L	Replaces the substitution character with the low value defined on the calculation rule used to calculate the specific stepped charge on the bill line.
%M	Replaces the substitution character with the item type defined on the calculation rule used to calculate the specific item type charge on the bill line. This is only applicable to calculation rule-based rates.
%O	Replaces the substitution character with the description of the time-of-use (TOU) code being billed on this line
%Q	Replaces the substitution character with the service quantity being billed. Leading zeroes are suppressed. The decimal places shown are specified in a field on the Unit Of Measure control table. If you wish to suppress trailing zeroes after the decimal, you must set up the Allow Consumption Zero Suppression In Bill Description option type on the Financial Transaction Options Feature Configuration .
%R	Replaces the substitution character with the value specified in the calculation rule / bill factor. Either this character OR %I should be used when you desire to substitute the price / percent into the bill line. Using %R causes the prorated price / percent to be printed in the bill line (%I causes the price / percent as specified in the rate to be printed during proration situations). If the charge is proratable, %R should be used in conjunction with %D to print an appropriate message when the charges are prorated.
%S	Replaces the substitution character with the summed amount. All trailing zeroes up to the decimal position of the rate's currency will be removed. All leading zeroes will be removed unless the value is between 1 and -1 in which case a leading 0 will appear before the decimal place. The Symbol on the Currency control table will prefix the value. If the value is negative, a "-" will prefix the value. This character should only be used with Minimum, Apply To, and Summary calculation rules.
%T	Replaces the substitution character with message 10103 from message category 11109. This message is maintained in the standard message table. We recommend this message be set to "(%1% exempt)" where %1 will be substituted with the tax exemption percent as specified in the service agreement. This message will only be substituted when the calculation rule's bill factor is eligible for tax exemptions AND the customer is exempt from the tax. Note, %1 is not required.
%V	Replaces the substitution character with the "C1-ADDSC" characteristic ad hoc value retrieved by the calculation rule used to calculate the charge on the bill line.
Lines that don't print	If the bill line is not printed (as defined by the Print option), message 10104 from message category 4 will be appended to the bill line. This message is maintained in the standard message table. We recommend this message be "NOT SEEN BY CUSTOMER!" This message appears in the bill line that appears in the billing windows but does not appear on the customer's bill.

The following are examples of the content of common **Description on Bills** along with how the line would look on the customer's bill:

Description on Bill On Calculation Rule	How It Looks On A Bill
%C lamp pole(s) at %I per pole %F	1,234 lamp pole(s) at \$5.00 per pole (prorated by .3333)
%C lamp pole(s) at %R per pole %D	1,234 lamp pole(s) at \$1.50 per pole (prorated for 10 of 30 days)
First %Q kWh at %I per kWh %F	First 100.32 kWh at \$0.12349 per kWh (prorated by .3333)
First %Q kWh at %R per kWh %D	First 100.32 kWh at \$0.12349 per kWh (prorated for 10 of 30 days)
%Q kWh at %I per kWh	100.32 kWh at \$0.12349 per kWh
State sales tax %R %T	State sales tax 6.25% (50% exempt)
Minimum charge of %I %F	Minimum charge of \$10.00 (prorated by .3333)
Subtotal of %S	Subtotal of \$1,123.23
Charges for %O: %Q kW at %I per kW	Charges for Off Peak Winter: 234.43 kW at \$0.05 per kW

The prorated references will only appear if the calculation rule's charges are prorated due to a short or long bill period.

Searching and Maintaining Calculation Rules

Use this procedure to search for and maintain calculation rules.

- Select **Menu > Rates > Calculation Rule > Search**.
- Enter your search criteria.
Available query options include **Calculation Rule** and **Calculation Rule BO**.
 - When searching by **Calculation Rule**, you can search by **Calculation Group**, **Calculation Rule** name, or **Description**.
 - When searching by **Calculation Rule BO**, you can search by **Business Object**, or **Description**.
- Click **Refresh**.
- In the search results list, click the **Description** link for the calculation rule you want to view or edit. To navigate to the rule's calculation group, click the **Calculation Group** link.
The selected calculation rule is displayed in the **Calculation Rule** portal. You use this portal to maintain calculation rules. This portal includes the following zones:
 - **Calculation Rule**: Defines basic information about calculation rule
 - **Eligibility Criteria List**: Lists optional eligibility criteria for the current calculation rule. Eligibility criteria are used to determine whether a calculation rule should be applied (or skipped) during rate processing.

Use this procedure to maintain a calculation rule:

- Select **Menu > Rates > Calculation Rule > Search** to navigate to the Calculation Rule Query portal.
- Search for and select the appropriate calculation rule.
- Click **Edit**, **Delete**, or **Duplicate** as appropriate.
- To define eligibility criteria for the rule, click the **Add** link in the **Eligibility Criteria List** zone title bar. See "Eligibility Criteria" in [About Calculation Rules](#) for more information.

See [About Calculation Rules](#) for more information about calculation rules.

Defining Calculation Rule Eligibility Criteria

Use this procedure to define eligibility criteria for a calculation rule.

Prerequisites: You must create a calculation rule before you can define eligibility criteria.

- Click the **Add** link in the **Eligibility Criteria List** zone title bar.
- Enter a **Sequence** number, **Description**, and **Detailed Description** for the criteria.
- Complete the **Criteria Comparison** section as follows:
 - **Criteria Field:** the means used to retrieve the value of the criteria field (algorithm, bill factor, calculation line, characteristic, contract quantity, service quantity, or historic service quantity)
 - **Comparison Operator:** the operator used in the comparison
 - **Value:** a user-specified value to which the retrieved value is compared (using the comparison operator)
- Complete the **Comparison Results** section as follows:
 - **If True:** the action to take if the comparison is true
 - **If False:** the action to take if the comparison is false
 - **If Insufficient Data:** the action to take if there is insufficient data to perform the comparison
- Click **Save**.

See [The Big Picture of Calculation Rule Eligibility Rules](#) for more information.

Creating Rate Schedules

This section outlines how users work with rate schedules.

Defining Rate Schedules

Use this procedure to define rate schedules.

Prerequisites: You must configure an instance of the **Rate Engine Configuration** master configuration in order to create and/or maintain rate schedules.

- Select **Menu > Rates > Rate Schedule > Add**.
The Rate Schedule maintenance screen opens. To navigate to the Component-Based Rate Schedule page, click **Switch to Component-Based**.
- Enter a code for the **Rate Schedule**.
- Enter a short **Description** for the rate schedule.
- Select the **Service Type** (Electric Service, Gas Service, etc.) for the rate schedule.
- Select the **Frequency** (monthly, quarterly, etc.) for the rate schedule
- Select the **Currency Code** used with the rate schedule.
- Select whether or not the rate schedule will **Allow Estimates** when performing calculations.
- Select whether or not the rate schedule will **Allow RV Proration** when performing calculations.
- Select the **RV Proration Date**, used if the rate schedule does NOT allow RV proration. Valid options include Accounting Date, Bill End Date, and Bill Start Date.

- Define the **Pre-Processing Calculation Groups** used by the rate schedule. If the calculation groups do not exist yet, use the **Add Calculation Group** action to add each new calculation group and link it to the rate schedule. Refer to the embedded help for more information.

For each pre-processing calculation group, specify:

- **Sequence:** The sequence in which the group is executed when the pre-processing groups are processed.
- **Description:** A description of the calculation group
- **Calculation Group:** The calculation group.

Use the **Add/Remove Links** action on each calculation group to maintain the cross-references between the rules in the group. This action includes an ability to maintain a rule's target categories.

- Define the **Rate Version Calculation Groups** used by the rate schedule. If the calculation groups do not exist yet, use the **Add Calculation Group** action to add each new calculation group and link it to the rate schedule. Refer to the embedded help for more information.

For each rate version calculation group, specify:

- **Effective Date:** The date on which each rate version calculation group becomes effective
- **Description on Bill:** Specifies the description of the rate version calculation group on the bill. This description is saved on bill calculation details created using this rate version calculation group. Substitution characters may be used to substitute variables into the description during billing. Refer to [How To Use Description on Bill](#) for a discussion of the various substitution variables.
- **Calculation Group:** The calculation group.

Use the **Add/Remove Links** action on each calculation group to maintain the cross-references between the rules in the group. This action includes an ability to maintain a rule's target categories.

- Define the **Post-Processing Calculation Groups** used by the rate schedule. If the calculation groups do not exist yet, use the **Add Calculation Group** action to add each new calculation group and link it to the rate schedule. Refer to the embedded help for more information.

For each post-processing calculation group, specify:

- **Sequence:** The sequence in which the group is executed when the post-processing groups are processed.
- **Description:** A description of the calculation group
- **Calculation Group:** The calculation group.

Use the **Add/Remove Links** action on each calculation group to maintain the cross-references between the rules in the group. This action includes an ability to maintain a rule's target categories.

- Define one more recommended **Meter Configuration Types** for meters linked to service agreements (by way of their service points) for the rate schedule.
- Define one or more **Bill Messages** that should appear on bills that use the rate schedule. For each message, specify
 - **Bill Message:** The message that should appear on the bill.
 - The **Start Date** and **End Date** when the bill message should appear on the bill. Leave **End Date** blank if the message should appear indefinitely,
- Click **Save**.

This rate schedule can now be referenced on service agreements.

Searching and Maintaining Rate Schedules

Use this procedure to search for and view a rate schedule.

Prerequisites: You must configure an instance of the **Rate Engine Configuration** master configuration in order to create and/or maintain rate schedules.

- Select **Menu > Rates > Rate Schedule > Search**.
- Enter your search criteria.
You can search by **Rate Schedule, Description, or Rate Engine** (Calculation Rule-Based or Component-Based).
- Click **Search**.
- In the search results list, click the **Description** link for the rate schedule you want to view or edit.

NOTE: Component-based rate schedules will be highlighted by having "(Component-Based)" appended to their listing in the search results.

- The selected rate schedule is displayed in the (Calculation Rule-Based) **Rate Schedule** portal. You use this portal to maintain rate schedule. This portal includes the following zones:
 - **Rate Schedule:** Defines basic information about the rate schedule.
 - **Rate Schedule Tree:** Displays the hierarchy of Calculation Groups and Calculation Rules for the Rate Schedule. Only the most recent rate version calculation group is initially displayed. In this zone you can:
 - Click a calculation group or calculation rule link to go to the Calculation Group or Calculation Rule portal for the associated calculation group or calculation rule.
 - Click the Broadcast icon for a calculation rule to open the Cross Reference Rule zone. This zone displays the rate schedule's calculation rules that are members of the broadcast calculation rule's target category.
 - Click the **Show All Rate Versions** button to display all rate versions for the rate schedule. This will also display the **Show Effective Rate Version** button, which you can use to display the information for the most recent rate version.

Use this procedure to maintain a rate schedule:

- Select **Menu > Rates > Rate Schedule > Search** to navigate to the Rate Schedule Query portal.
- Search for and select the appropriate rate schedule.
 - The selected rate schedule is displayed in the (new) **Rate Schedule** portal.
 - Click **Edit, Delete, or Duplicate** as appropriate.

NOTE:

If you select a component-based rate schedule, the selected rate schedule is displayed in the (component-based) **Rate Schedule** page.

Base Package Calculation Rule Descriptions

This section provides detailed descriptions of each of the base package calculation rules provided with Oracle Utilities Customer Care and Billing. The descriptions of the calculation rules below contain the following information

- **Rule Name:** The name of the rule
- **Base Package Calculation Rule Business Object:** The base package business object used by the rule
- **Apply Calculation Rule Algorithm Type / Algorithm:** The base package algorithm type and algorithm specified in the "Apply Calc Rule" system event for the rule
- **Rule Parameters:** Parameters used to define the rule (if applicable). Does not include common parameters used by all rules (see Common Parameters).

- **Example:** One or more example configurations of the rule. Note that all examples use default values for all Apply Calculation Rule Algorithm Parameters.

Common Parameters

All calculation rules use the following common parameters:

- **Calculation Group:** The calculation group to which the rule belongs
- **Calculation Rule:** The user-defined name given to the calculation rule
- **Sequence:** The relative position of the calculation rule in respect of the other rules in the calculation group. This controls the order in which the system performs the calculation.
- **Description:** A short description of the rule. This is used as the Information String for the rule in the user interface.
- **Detailed Description:** A detailed description of the rule.

In addition, several of the base package calculation rules also use the following parameters:

- **Description On Bill:** The text that appears on the bill line generated for this calculation rule. Variables can be used to dynamically generate text (such as, price and quantity) when billing calculates the charges. Refer to [How To Use Description on Bill](#) for more information about available substitution variables.
- **Print (Yes or No):** A flag that specifies if the bill line created by this calculation rule should appear on the customer's bill. All bill lines are shown on Bill Segment - Calculation Details. However, only those lines marked as Print are presented to the customer.
- **Print If Zero (Yes or No):** A flag that specifies if a bill line should be printed if the bill line's value is zero.
- **Rounding Type:** This flag specifies if the calculated value should be rounded Down, Up, or Nearest. Used with Precision to control how the system rounds the rule's calculated value.
- **Precision:** This field defaults to a value consistent with the decimal positions defined on the rate schedule's currency code. Used with Rounding Type to control how the system rounds the rule's calculated value.
- **FCPO (For Calculation Purposes Only):** A flag that indicates if this calculation rule exists purely to calculate a value used by another calculation rule. When set to Yes, the system does not include the calculated amount in the bill total. The following are required when FCPO is set to Yes:
 - **Create Bill Line:** Determines if a bill line should be created for the rule (if there is no need to show the results to the customer or a user, there is no need to create a bill line).
 - **FCPO Retention Rule:** If a bill line created, this defines if the FCPO amount should be set to zero on the bill line or whether the bill line's amount should be set equal to the FCPO amount.
- **Override Proration:** A flag that specifies if an override proration algorithm should be used. This is used in situations when the standard proration logic does not satisfy your requirements. In this case, you may plug in an override proration algorithm to calculate the proration factors required by your implementation. This algorithm can be specified on the calculation rule business object or on the parent calculation rule business object if the override proration applies to all rates.
- **Seasonal (Yes or No):** A flag that specifies if charges associated with the calculation rule are only levied during a specific season. If set to "Yes", the following must be specified:
 - **Season Start:** Defines the start of the season for the calculation rule.
 - **Season End:** Defines the end of the season for the calculation rule.
 - **Seasonal Prorate Method:** Defines how the system should prorate a seasonal charge when a bill segment's period is not entirely within the seasonal period. The following options are available:
 - **Accounting Date, Consumption End Date and Consumption Start Date** options will not prorate the charge calculated by the calculation rule. Rather, it will only calculate the charge if the accounting date associated with the

bill segment is within the seasonal period, or if the consumption period's end date is within the seasonal period, or if the consumption period's start date is within the seasonal period respectively.

- **Prorate** will prorate the calculation rule charge based on number of days in the season that is included in the bill period.
- The **Prorate Seasonal SQ** option is only pertinent if you have:
 - Seasonal service quantity (SQ) charges, AND
 - Meters that measure seasonal consumption on separate registers, AND
 - You have a bill that crosses seasonal boundaries, AND
 - You have multiple rate version calculation groups effective across the bill period.

If the Prorate Seasonal SQ option is used, the system will prorate the charge calculated by a SQ calculation rule based on the number of days in the season that is included in the rate version calculation group's period.

- **GL Distribution:** If the charge calculated by the calculation rule impacts the general ledger, you must define the distribution code used to construct the GL account.
 - **Distribution Code Source:** Specifies the type of GL distribution to use for this calculation rule. If the calculation rule's charges should be booked to a single GL account regardless of the service agreement's SA Type's revenue class, select the **Specific Distribution Code** source and enter a **Distribution Code**.
If the calculation rule's charges are booked to a different GL account depending on the service agreement's revenue class, select the **Revenue Class** source and insert the appropriate **Revenue Class** and **Distribution Code** for each that uses the rate.
- **Cross Reference:** Defines the calculation line categories that the resultant calculation details belong to. For example, for a rate that calculates city and state taxes on consumption and demand based charges, the following categories could be used to calculate these taxes:
 - A calculation line category type called "Taxable" with a category value for City Tax and another for State Tax.
 - Each of the rate's calculation rules used for consumption and demand based charges should define the Member Category(s) that it belongs to ("Taxable - City Tax" and "Taxable - State Tax"). In other words, these rules would be defined as a member of the city tax and state tax categories.
 - The Apply To rules used to calculate city tax and state tax should define the respective Target Category(s) ("Taxable - City Tax" and "Taxable - State Tax") that they are applied to.
There are two types of cross-reference categories:
 - **Target Category:** Specifies the category that the calculation rule targets. Used with Apply To, Maximum Charge, and Minimum Charge calculation rules.
 - **Member Category:** Specifies the category to which the calculation rule belongs.
- **Characteristics:** Defines additional calculation rule attributes that may be used in rate processing or for reporting purposes. A calculation rule's characteristics are copied onto the resultant bill lines for those characteristic types that are allowed on bill segment calc lines. You can indicate that "C1-ADDSC" characteristic ad hoc value of a bill line should be substituted into the bill line's description by using the %V substitution variable in the calculation rule's **Description On Bill** field.

Calculation Rule Validation

All calculation rules are validated when created to ensure they contain proper data needed to perform their calculations. The algorithms used to perform these validations are performed by the algorithms specified in the "Validation" system event on the calculation rule's business object.

Calculation Rules

This section provides descriptions for the base package calculation rules.

Apply To

Apply To calculation rules create bill lines that levy charges based on amounts calculated on other bill lines. Apply To calculation rules must define the respective target category that they are applied to. The calculation rule(s) that compute charges to which "Apply To" rules will be applied must be defined as members of the target category. See **Cross-Reference** under [Common Parameters](#) for more information about Member and Target categories.

- **Rule Name:** Apply To
- **Base Package Calculation Rule Business Object:** C1-ApplyTo
- **Apply Calculation Rule Algorithm Type / Algorithm:** C1-APPLYTO
- **Rule Parameters:**
 - **Calculation Details:** Details regarding how the calculation rule performs its calculations:
 - **Error If No Value:** Indicates what should happen if the system cannot find any calculation rules that are members of the target category at billing time.
 - **Seasonal:** See [Common Parameters](#).
 - **Value Type:** Defines if the price is a Charge, Percentage or Unit Rate.
 - **Value Source:** specifies the source of the price. Depending on the value source selected, either a Bill Factor, Value, or Value Algorithm is required.
 - **Example:** The following calculation rule applies a county tax other calculation rules that belong the "Taxable - County Tax" category.
Calculation Group: Taxes
Calculation Rule: CNTYTAX
Sequence: 530
Description: County Tax
Description On Bill: County sales tax %R %T
Print: Yes
Print if Zero: No
Rounding Type: Nearest
Precision: 0.01
FCPO: No
Override Proration: No
Calculation Details:
 - **Error If No Value:** No
 - **Seasonal:** No
 - **Value Type:** Percentage
 - **Value Source:** Bill Factor
 - **Bill Factor:** County Tax
GL Distribution:

- **Distribution Source Code:** Specific Distribution Code
- **Distribution Code:** Payable - County Tax
Cross Reference:
- **Target Category (Category Type / Value):** Taxable / County Tax
- **Member Category (Category Type/Value):** Summary Item / Summary Line

Calculate Final Reading Values

Calculate Final Reading Values calculation rules determine the final values for readings based on user-defined UOM/TOU/SQI.

- **Rule Name:** Calculate Final Reading Values
- **Base Package Calculation Rule Business Object:** C1-CalculateFinalValue
- **Apply Calculation Rule Algorithm Type / Algorithm:** C1-CALCFNVL
- **Rule Parameters:**
 - **Calculation Details:** Details regarding how the calculation rule performs its calculations:
 - **Unit of Measure:** The unit of measure for the measured quantity.
 - **Time of Use:** The time of use for the measured quantity.
 - **Service Quantity Identifier:** The service quantity identifier for the measured quantity.
 - **Retain Measured SQ:** indicates whether to save the accumulated measured quantity entry in the SQ collection. If this value is set to No, it means the value will be removed from the SQ collection. Before any pre-processing rule is executed, the rate engine will place the sum / max value of the read details into the SQ collection. For example, if the read details contain entries for measured CCF, there will be an entry in the SQ collection for the total CCF from all read details. This might be what is needed, but it may be extraneous if a rule converts the measured quantity into therms. In this situation, the SQ collection only needs therms and the CCF entry can be removed.
 - **Formula:** Defines the formula used to calculate the final read quantity. Bill Factors (or scalar variables) to be used in the calculation are designated as Vn, where n matches the number assigned to the variable (i.e. V1 = Bill Factor 1, V2 = Bill Factor 2, etc.). Measured Quantity is referenced as MQ in the formula. Mathematical operations supported include addition, subtraction, multiplication and division. For example: $(MQ * V1)$ would be the formula to convert CCF to THERM.
 - **Scalar Variables:** Defines the scalar variables or Bill Factors to be used in the calculation. When referenced in the formula, scalar variables are designated as Vn, where n matches the number assigned to the variable (i.e. V1 = Bill Factor 1, V2 = Bill Factor 2, etc.). Note that only regular bill factors may be used in the formula. Interval and Time of Use bill factors are not supported.
 - **Sequence:** Designates the number of the variable (V1, V2, etc.)
 - **Bill Factor:** The Bill Factor used for the variable.
 - **Result:** Defines the type of data (**Unit of Measure, Time of Use, and/or Service Quantity Identifier**) to be used for the final quantity calculated by the rule.
 - **Processing:** The following processing takes place:
 - The rule will process each read detail whose initial UOM matches the measured quantity UOM.
 - It substitutes the reference to MQ in the formula with each read's measured quantity and then calls the formula service passing the defined bill factors as variables 1 to n. The read's end date is passed as the effective date.
 - It then populates each read's final value with the results of the formula and it populates the final UOM / TOU / SQI with the values defined on the rule.

- It populates the SQ collection with the results (this will either add a new value if the Final UOM / TOU / SQI is not present in the SQ collection, OR it will update the existing SQ quantity with the sum or max of the calculated value depending on the Final UOM's measure's peak value). Note, the initial and final values of such an SQ will be the calculated value.
- It then removes the measured UOM / TOU / SQI from the SQ collection if the rule has been configured as such.
- **Example:** This calculation rule converts CCF (as recorded on the meter) to therms for billing purposes.

Calculation Group: CCF to Therm Conversion (Calculate SQ - SQ and BF)

Calculation Rule: CCF2TH

Sequence: 10

Description: Convert CCF to TH

Calculation Details:

- **Unit of Measure:** 100 cubic feet of gas
- **Retain Measured SQ:** Yes
- **Formula:** $MQ * V1 * V2$
Scalar Variables (Sequence / Bill Factor):
- 1 / Pressure adjustment zone
- 2 / Take point for therm conv.fac
- **Result:**
- **Unit of Measure:** Thermal units

Calculate Service Quantity

Calculate Service Quantity calculation rules derive or calculate a service quantity that is eventually inserted into the bill segment SQ collection. Calculate Service Quantity calculation rules are generally used to either manipulate measured consumption, or to derive quantities that are not measured by a meter.

- **Rule Name:** Calculate Service Quantity
- **Base Package Calculation Rule Business Object:** C1-CalculateServiceQuantity
- **Apply Calculation Rule Algorithm Type / Algorithm:** C1-CALC-SQ
- **Rule Parameters:**
 - **Scalar Variable 1 (Scalar Variable 2, Scalar Variable 3, ... Scalar Variable 5):** Defines one of the scalar variables to be used in the calculation. When used in formulas, scalar variables are designated as Vn, where n matches the number assigned to the variable (i.e. V1 = Scalar Variable 1, V2 = Scalar Variable 2, etc.).
 - **Type:** Defines the type of variable and can be one of the following:
 - **Algorithm:** an algorithm is responsible for retrieving the scalar variable value, e.g. calculate number of days in the bill period.
 - **Bill Factor:** the value for a specified bill factor that is in effect for the period.
 - **Calculated Line:** the value is derived by summing previously calculated lines defined as members of a target category.
 - **Characteristic Value:** the value is derived by summing characteristic values of a given characteristic type.
 - **Contract Quantity:** the value for a given contract quantity type specified on a service agreement.
 - **Historical Service Quantity:** the value is derived based on the SA's historical bill segment service quantities for the specified UOM / TOU / SQI. The Aggregate Function defines the calculation to perform on the set of

historical service quantities retrieved to derive a single value. Average, Maximum, Minimum and Sum are supported.

- **Service Quantity:** service quantities from the bill period's SQ collection, based on a specified UOM / TOU / SQL. This type of variable allows this rule to make use of values calculated by other rules.
- **Previous Quantity:** the value is derived from the SA's most recent frozen bill segment service quantities for the specified UOM / TOU / SQL.
- **Missing Value Action:** Defines what should take place if the system is unable to retrieve or derive a value for a particular scalar variable. Valid options are as follows:
 - Select **Error** to create an exception
 - Select **Skip** to exit the rule and process the next rule
 - Select **Use Default Value** if the scalar variable should be set to the default value specified
- **Calculation Details:** Details regarding how the calculation rule performs its calculations:
 - **Calculation Rule Processing:** Indicates if the rule is **Always** executed by rate application, even if the consumption details on the original bill segment are to be used when the system recalculates a bill segment. If the rule should not be executed when the consumption details on the original bill segment are used, indicate that the calculation rule should only be executed on the **Initial SQ Calculation**.
 - **Fail Action:** Indicates the action to take if an error is encountered when applying the rule's formula. Available options are to either create a bill segment **Error**, or to **Skip** the calculation rule.
 - **Calculation Rule Output:** Specifies whether calculation rule should add or update a **Service Quantity** entry in the bill period's SQ collection, or create a bill **Calculation Line**, or **Both**.
 - **Retain SQ:** Indicates whether to save the calculated value on the bill segment. If this value is set to **No**, it means the value will only exist in the SQ collection while the rate engine is calculating. A value of **No** should be used for SQ entries that do not have to be retained for audit or analytic purposes.
 - **Formula Source:** Specifies the type of formula to use for the rule. Valid options include "Simple Formula" and "Conditional Formula".
 - **Formula:** Specify the **Simple Formula** to apply. Scalar variables to be used in the calculation are designated as Vn, where n matches the number assigned to the variable (i.e. V1 = Scalar Variable 1, V2 = Scalar Variable 2, etc.). Mathematical operations supported include addition, subtraction, multiplication and division. For example: $(V1*V2)/2$.
 - **Conditional Formula:** this allows comparison between one or more pairs of operands to determine the specific formula to execute. A conditional formula can utilize one or more conditions. Each condition comprises the following:
 - **Operand 1:** the first operand in the condition. Can reference an expression with one or more scalar variables (designated as Vn), e.g. $[V1+V2]$ or $[(V1/V2)*V3]$.
 - **Operator:** the operator used to compare Operand 1 with Operand 2.
 - **Operand 2:** the second operand in the condition. Can reference an expression with one or more scalar variables, or a constant (similar to Operand 1).
 - **True Action:** indicates how to proceed if the comparison between the operands is true. Can be one of the following:
 - **Apply True Formula:** indicates that the True Formula be executed.
 - **Check Next Condition:** indicates that the next condition should be checked.
 - **True Formula:** the formula to apply if True Action is set to Apply True Formula. Can reference an expression with one or more scalar variables (designated as Vn), or a constant.
 - **False Action:** indicates how to proceed if the comparison between the operands is false. Can be one of the following:

Apply False Formula: indicates that the False Formula be executed.

- **Check Next Condition:** indicates that the next condition should be checked.
- **False Formula:** the formula to apply if the False Action is set to Apply False Formula. Can reference a vector (designated as IVn, where n is the number of the vector) or an expression referencing one or more vectors or a scalar variable (designated as Vn).
- **Result:** Define the **Unit of Measure**, **Time of Use** and/or **Service Quantity Identifier** to be used if this calculation rule inserts or updates a service quantity in the bill period's SQ collection.
- **Example:** This calculation rule calculates total kWh from On Peak and Off Peak service quantities.

Calculation Group: Calculate KWH

Calculation Rule: TOTKWH

Sequence: 10

Description: Total amount of KWH (On Peak + Off Peak)

Scalar Variable 1:

- **Type:** Service Quantity
- **Missing Value Action:** Error
- **Unit of Measure:** Kilowatt hour
- **Time of Use:** On Peak
- **SQ To Use:** Billable

Scalar Variable 2:

- **Type:** Service Quantity
- **Missing Value Action:** Error
- **Unit of Measure:** Kilowatt hour
- **Time of Use:** Off Peak
- **SQ To Use:** Billable

Calculation Details:

- **Calculation Rule Processing:** Always
- **Fail Action:** Error
- **Calculation Rule Output:** Service Quantity
- **Retain SQ:** No
- **Formula Source:** Simple Formula
- **Formula:** V1 + V2

Result:

- **Unit of Measure:** Kilowatt hour

Copy Service Quantity from Master Bill Segment

Calculate Final Reading Values calculation rules determine the final values for readings based on user-defined UOM/TOU/SQI.

- **Rule Name:** Copy Service Quantity From Master Bill Segment
- **Base Package Calculation Rule Business Object:** C1-CopySQFromMasterBillSegment
- **Apply Calculation Rule Algorithm Type / Algorithm:** C1-CPY-MB-SQ

- **Rule Parameters:**
 - **Characteristics:** Defines characteristic(s) and corresponding value(s) that are to be passed to the referenced calculation group.
 - **Characteristic Type:** Defines the characteristic type that is to be associated to the calculation rule.

NOTE:

Characteristic Types for rates must be configured to be used on a calculation rule and/or in the characteristic collection. Refer to [Defining Characteristic Types](#) for information on how to set up characteristic types.

- **Characteristic Value:** Defines the parameter value that will be associated to the characteristic type.

Execute Calc Group

Execute Calc Group calculation rules call another calculation group, and pass characteristics and their values to the referenced calculation group.

- **Rule Name:** Execute Calculation Group
- **Base Package Calculation Rule Business Object:** C1-CalcRuleReferredCalcGroup
- **Apply Calculation Rule Algorithm Type / Algorithm:** C1-ACALR-RFG
- **Rule Parameters:**
 - **Referenced Calculation Group:** Defines the calculation group that's being called.
 - **Calculation Group:** Defines the calculation group that's being called.
 - **Characteristics:** Defines characteristic(s) and corresponding value(s) that are to be passed to the referenced calculation group.
 - **Characteristic Type:** Defines the characteristic type that is to be passed to the referenced calculation group.

NOTE:

Characteristic Types for rates must be configured to be used on a calculation rule and/or in the characteristic collection. Refer to [Defining Characteristic Types](#) for information on how to set up characteristic types.

- **Characteristic Value:** Defines the parameter value that will be associated to the characteristic type.

Flat Charge

Flat Charge calculation rules create bill lines that levy service charges and fees that aren't based on how much the customer uses. For example a flat charge calculation rule may be used to apply a monthly service charge of \$10 to a customer's bill.

- **Rule Name:** Flat Charge
- **Base Package Calculation Rule Business Object:** C1-FlatCharge
- **Apply Calculation Rule Algorithm Type / Algorithm:** C1-FLAT-CHRG
- **Rule Parameters:**
 - **Calculation Details:** Details regarding how the calculation rule performs its calculations:
 - **Seasonal:** See [Common Parameters](#).
 - **Value Type:** Defines the type of value to use for the rule. For Flat Charge rules, this should be set to **Charge**.

- **Value Source:** Specifies the source of the price used to calculate the charge. Depending on the source selected, this will be a Bill Factor, Value, or Algorithm.
- **Example:** This calculation rule levies a customer charge.
Calculation Group: Customer Charge
Calculation Rule: CSTCHG
Sequence: 20
Description: Customer Charge
Description On Bill: Customer Charge
Print: Yes
Print if Zero: No
Rounding Type: Nearest
Precision: 0.01
FCPO: No
Override Proration: No
Calculation Details:
 - **Seasonal:** No
 - **Value Type:** Charge
 - **Value Source:** Value
 - **Value:** 5**GL Distribution:**
 - **Distribution Source Code:** Specific Distribution Code
 - **Distribution Code:** Revenue - Energy**Cross Reference:**
 - **Member Category (Category Type / Value):** Subject to tax / City taxable

Item Type

Item Type calculation rules create bill lines that levy charges based on the number and type of items used by a customer. The system keeps track of items on the service point(s) linked to the customer's service agreement.

- **Rule Name:** Item Type
- **Base Package Calculation Rule Business Object:** C1-ItemType
- **Apply Calculation Rule Algorithm Type / Algorithm:** C1-ITEMTYPE
- **Rule Parameters:**
 - **Calculation Details:** Details regarding how the calculation rule performs its calculations:
 - **Seasonal:** See [Common Parameters](#).
 - **Item Type:** Defines the types of items to which charges are applied. When defining more than one item type on a single calculation rule, you can indicate that the item type of a bill line should be substituted into the bill line's description by using the %M substitution variable in the calculation rule's **Description On Bill** field.
 - **Error If No Value:** A flag that indicates (Yes or No) if a bill error should be generated if the item type specified on the calculation rule was not supplied at billing time.
 - **Value Type:** Defines the type of charge. Valid options include Charge, Percentage, or Unit Rate.

- **Value Source:** Defines the source of the price used to calculate the charge. Depending on the source selected, this will be a Bill Factor, Value, or Algorithm.
 - **Value/Bill Factor/Algorithm:** The specific Value, Bill Factor, or Algorithm that serves as the source of the price used to calculate the charge.
- **Example:** This calculation rule calculates charges for light poles.
Calculation Group: Lamp Charges
Calculation Rule: POLE CHARGE
Sequence: 10
Description: Pole Charge
Description On Bill: %C lamp poles at %R per pole %D %I
Print: Yes
Print if Zero: No
Rounding Type: Nearest
Precision: 0.01
FCPO: No
Override Proration: No
Calculation Details:
- **Seasonal:** No
 - **Items:**
 - **Item Type:** Pole(s)
 - **Error If No Value:** No
 - **Value Type:** Unit Rate
 - **Value Source:** Value
 - **Value / Bill Factor /Algorithm:** 3
GL Distribution:
 - **Distribution Source Code:** Specific Distribution Code
 - **Distribution Code:** Revenue - Area Lighting
Cross Reference:
 - **Member Category (Category Type / Value):** Charges / Total Charges
 - **Member Category (Category Type / Value):** Charges / Lamp Charges

Math

Math calculation rules derive interval data based on a formula, and apply TOU mappings and/or other operations to the derived data to calculate service quantities.

- **Rule Name:** Math
- **Base Package Calculation Rule Business Object:** C1-Math
- **Apply Calculation Rule Algorithm Type / Algorithm:** C1-MATH
- **Rule Parameters:**
 - **Vector 1 (Vector 2, Vector 3, ..., Vector 5):** Defines one of the vectors (Vector 1, 2, 3, ..., 5) to be used in the calculation. When used in formulas, interval values for vectors are designated as IV1, IV2, IV3, ..., IV5.

- **Vector Type:** Defines the type of vector. Valid options include **Interval Bill Factor** and **Interval Service Quantity**.
- **Bill Factor:** Defines the Interval Bill Factor from which interval values are derived for the vector.
- **Unit of Measure/Time of Use/Service Quantity Identifier:** The UOM/TOU/SQI used to retrieve interval values from either the usage request service quantity entries given a usage request ID and usage period, or from the rate engine buffer populated prior to calling rate application.
- **Missing Interval Data Action:** Defines the action to take (**Error** or **Skip**) if interval data is missing for the expected period
- **Scalars:** Defines scalar variables to be used in the calculation. When used in formulas, scalar variables are designated as Vn, where n is the number of the variable (based on the sequence in which they are defined in the list).
 - **Scalar Type:** Defines the type of variable. Can be one of the following:
 - **Bill Factor:** The value for a specified bill factor that is in effect for the billing period.
 - **Set Function:** The result of applying a function to a set of interval measurement values (defined as a vector).
 - **Service Quantity:** Service quantities from the current SQ list, based on a specified UOM, TOU, or SQI. This type of variable allows this rule to make use of values calculated by other rules.
 - **Bill Factor:** Defines the bill factor used to retrieve the variable value (applicable only if Scalar Type is Bill Factor)
 - **Unit of Measure:** Defines the UOM for service quantities to retrieve from the SQ list (applicable only if Scalar Type is Service Quantity).
 - **Time of Use:** Defines the TOU for service quantities to retrieve from the SQ list (applicable only if Scalar Type is Service Quantity).
 - **Service Quantity Identifier:** Defines the SQI for service quantities to retrieve from the SQ list (applicable only if Scalar Type is Service Quantity).
 - **SQ to Use:** Every service quantity supplied to a rate has two quantities; the quantity initially measured, and the quantity that should be priced by the rate. Most of the time these two amounts will be the same, unless another rule has executed and caused the billable quantity to change. Each rule needs to know if it should use the **Initial** or **Billable** quantity.
 - **Set Function:** Defines the function used to calculate a scalar value from a set of interval values (defined as a vector). This is applicable only if Scalar Type is Set Function). Can be one of the following:
 - **Average:** calculates the average of the vector's interval measurement values.
 - **Count:** returns the number of interval measurements.
 - **Max:** returns the maximum value from the vector's interval measurement values.
 - **Min:** returns the minimum value from the vector's interval measurement values.
 - **Total:** calculates the total of the vector's interval measurement values.
 - **Vector:** the vector to be used for this variable (applicable only if Scalar Type is Set Function). Can be one of the following:
 - **FV** (Final Vector Interval Value): the vector containing the results of the formula defined in the Calculation Details section.
 - **IV1** (Vector 1 Interval Value): the vector defined as Vector 1.
 - **IV2** (Vector 2 Interval Value): the vector defined as Vector 2.
 - **IV3** (Vector 3 Interval Value): the vector defined as Vector 3.
 - **IV4** (Vector 4 Interval Value): the vector defined as Vector 4.
 - **IV5** (Vector 5 Interval Value): the vector defined as Vector 5.

- **Missing Value Action:** Defines the action to take (**Error**, **Skip**, or **Use Default Value**) if data is missing for the scalar variable for the expected period
- **Default Value:** The default value to use if data is missing for the scalar variable. Applicable only if Missing Value Action is Use Default Value.
- **Calculation Details:** Details regarding how the calculation rule performs its calculations:
 - **Calculation Rule Processing:** Indicates if the rule is **Always** executed by rate application, even if the consumption details on the original bill segment are to be used when the system recalculates a bill segment. If the rule should not be executed when the consumption details on the original bill segment are used, indicate that the calculation rule should only be executed on the **Initial SQ Calculation**.
 - **Fail Action:** Indicates the action to take if an error is encountered when applying the rule's formula. Available options are to either create a bill segment **Error**, or to **Skip** the calculation rule.
 - **Calculation Rule Output:** Specifies whether calculation rule should add or update a **Service Quantity** entry in the bill period's SQ collection, or create a bill **Calculation Line**, or **Both**.
 - **Retain SQ:** Indicates whether to save the calculated value on the bill segment. If this value is set to **No**, it means the value will only exist in the SQ collection while the rate engine is calculating. A value of **No** should be used for SQ entries that do not have to be retained for audit or analytic purposes.
 - **Formula Source:** Specifies the type of formula to use for the rule. Valid options include "Simple Formula" and "Conditional Formula".
 - **Formula:** Specify the **Simple Formula** to apply. Scalar variables to be used in the calculation are designated as V_n , where n matches the number assigned to the variable (i.e. V_1 = Scalar Variable 1, V_2 = Scalar Variable 2, etc.). Mathematical operations supported include addition, subtraction, multiplication and division. For example: $(V_1 * V_2) / 2$.
 - **Conditional Formula:** this allows comparison between one or more pairs of operands to determine the specific formula to execute. A conditional formula can utilize one or more conditions. Each condition comprises the following:
 - **Operand 1:** the first operand in the condition. Can reference an expression with one or more scalar variables (designated as V_n), e.g. $[V_1 + V_2]$ or $[(V_1 / V_2) * V_3]$.
 - **Operator:** the operator used to compare Operand 1 with Operand 2.
 - **Operand 2:** the second operand in the condition. Can reference an expression with one or more scalar variables, or a constant (similar to Operand 1).
 - **True Action:** indicates how to proceed if the comparison between the operands is true. Can be one of the following:
 - Apply True Formula:** indicates that the True Formula be executed.
 - Check Next Condition:** indicates that the next condition should be checked.
 - **True Formula:** the formula to apply if True Action is set to Apply True Formula. Can reference an expression with one or more scalar variables (designated as V_n), or a constant.
 - **False Action:** indicates how to proceed if the comparison between the operands is false. Can be one of the following:
 - Apply False Formula:** indicates that the False Formula be executed.
 - Check Next Condition:** indicates that the next condition should be checked.
 - **False Formula:** the formula to apply if the False Action is set to Apply False Formula. Can reference a vector (designated as IV_n , where n is the number of the vector) or an expression referencing one or more vectors or a scalar variable (designated as V_n).
- **Result:** Defines how service quantities are inserted into the SQ list. Math calculation rules can insert one or more entries into the SQ list.

- **Result Source:** Defines the method to use to calculate for the service quantity. Can be one of the following:
 - **Set Function Against Derived Vector:** Applies a function to the derived interval values. The function to be applied is specified in the Set Function field.
 - **Scalar Formula Result:** Applies a user-defined formula. The formula is specified in the Scalar Formula field.
- **Set Function:** the function to apply to the derived interval values (applicable only if Result Source is set to Set Function Against Derived Vector). Can be one of the following:
 - **Average:** Calculates the average of the derived interval measurement values.
 - **Count:** Returns the number of derived interval measurements.
 - **Max:** Returns the maximum value from the derived interval measurement values.
 - **Min:** Returns the minimum value from the derived interval measurement values.
 - **Total:** Calculates the total of the derived interval measurement values.
- **Scalar Formula:** the formula to apply (applicable only if Result Source is set to Scalar Formula). Variables used in this formula must be defined in the Scalars section. When referenced in formulas, scalar variables are designated as Vn (where n is the number of the variable).
- **Unit of Measure:** the UOM to be used when inserting service quantity entries
- **Time of Use:** the TOU to be used when inserting service quantity entries
- **Service Quantity Identifier:** the SQI to be used when inserting service quantity entries
- **Apply TOU Map:** Indicates if a TOU map should be applied to the derived interval values. If TOU periods and values are returned as a result of TOU mapping, then service quantity entries are inserted.
- **TOU Map:** Defines the TOU Map to apply to the derived interval values (applicable only if Apply TOU Map is set to Yes).
- **TOU Mapping Function:** Defines the function to apply to the derived interval values when calculating for the time of use values (applicable only if Apply TOU Map is set to Yes). Can be one of the following:
 - **Max:** Returns the maximum value from the derived interval values for each TOU period.
 - **Sum:** Returns the sum of the derived interval values for each TOU period.
- **Processing:**

Math rules derive interval values based on a formula, and apply TOU mappings and/or other operations to the derived data to calculate billing quantities. Examples include the following:

 - Derive an interval data curve (vector) given a formula. For example, derive a power factor curve given a formula using kWh and kVarh curves.
 - Apply TOU mapping to a derived interval data curve. For example, after deriving the power factor curve, perform TOU mapping on the result.
 - Perform mathematical operations on SQ entries. For example, get total kWh consumption by adding "kWh On Peak", "kWh Off Peak", and "kWh Shoulder Peak" where "kWh On Peak", "kWh Off Peak", and "kWh Shoulder Peak" were calculated by a previous calculation rule.

Each interval data curve is defined as a vector parameter (the rule can define up to 5 vectors). Mathematical operations defined by the "Vector Processing" parameters can be performed between vectors (e.g. IV1 * IV2) and between vectors and scalar variables (e.g. IV1 * V1).
- **Example:** This calculation rule calculates prices for interval usage by multiplying an interval service quantity times an interval price bill factor.

Calculation Group: Electric Commercial - Interval Pricing

Calculation Rule: INTDPRICING

Sequence: 10

Description: KWH Interval Prices

Description On Bill: kWh Interval Prices

Print: Yes

Print if Zero: No

Rounding Type: Nearest

Precision: 0.01

FCPO: No

Vector 1:

- **Vector Type:** Interval Service Quantity
 - **Unit of Measure:** Kilowatt hour
 - **Missing Interval Data Action:** Error
- Vector 2:**

- **Vector Type:** Interval Bill Factor
 - **Bill Factor:** Interval Prices
 - **Missing Interval Data Action:** Error
- Calculation Details:**

- **Calculation Rule Processing:** Always
- **Fail Action:** Error
- **Calculation Rule Output:** Calculation Line
- **Formula Source:** Simple Formula
- **Simple Formula:** IV1 * IV2

Result:

- **Result Source:** Set Function Against Derived Vector
 - **Set Function:** Total
- GL Distribution:**
- **Distribution Source Code:** Specific Distribution Code
 - **Distribution Code:** Revenue - Energy

Maximum Charge

Maximum Charge calculation rules are used to create bill lines that levy charges only when the sum of previously calculated lines is more than the maximum charge amount. Maximum charge calculation rules must define the respective target category that they are applied to. The calculation rule(s) that compute charges that the maximum is levied on must be defined as members of the target category. See **Cross-Reference** under [Common Parameters](#) for more information about Member and Target categories.

Note that if the values being compared are negative values, the comparison is NOT done on the absolute values, but rather on the actual values. For example, imagine you have a maximum discount of \$ -2.00 and previous calculation rules have calculated a discount of \$ -3.00. You want a calculation rule to create a bill line for \$1.00 to reduce the discount. A maximum charge calculation rule will not work in this case because -3 is considered less than -2. For this business scenario you should use a Minimum Charge calculation rule.

Note: Maximum Charge calculation rules are rare. You tend to only see them in deregulated markets where customers have agreed to pay the market rate but want a cap on the maximum they'll pay each bill period.

- **Rule Name:** Maximum Charge

- **Base Package Calculation Rule Business Object:** C1-Maximum
- **Apply Calculation Rule Algorithm Type / Algorithm:** C1-MAXIMUM
- **Rule Parameters:**
 - **Calculation Details:** Details regarding how the calculation rule performs its calculations:
 - **Error If No Value:** Indicates what should happen if the system cannot find any calculation rules that are members of the target category at billing time.
 - **Seasonal:** See [Common Parameters](#).
 - **Value Type:** Defines the type of value to use for the maximum value for the rule. For Maximum Charge rules, this should be set to **Charge**.
 - **Value Source:** Specifies the source of the price used to calculate the charge. Depending on the source selected, this will be a Bill Factor, Value, or Algorithm.
 - **Example:** This calculation rule sets a maximum charge for area lighting.

Calculation Group: Customer-Owned Street & Highway Lighting

Calculation Rule: MAXCHRG

Sequence: 20

Description: Maximum Charge - Area Lighting

Description On Bill: Maximum Charge

Print: Yes

Print if Zero: No

Rounding Type: Nearest

Precision: 0.01

FCPO: No

Override Proration: No

Calculation Details:

- **Error If No Value:** No
- **Seasonal:** No
- **Value Type:** Charge
- **Value Source:** Value
- **Value:** 100
- **GL Distribution:**
 - **Distribution Source Code:** Specific Distribution Code
 - **Distribution Code:** Revenue - Area Lighting
- **Cross Reference:**
 - **Target Category (Category Type / Value):** Revenue / Maximum Consumption Charge

Minimum Charge

Minimum Charge calculation rules create bill lines that levy charges only when the sum of previously calculated lines is less than the minimum charge amount. Minimum charge calculation rules must define the respective target category that they are applied to. The calculation rule(s) that compute charges that the minimum is levied on must be defined as members of the target category. See **Cross-Reference** under [Common Parameters](#) for more information about Member and Target categories.

Note that if the values being compared are negative values, the comparison is NOT done on the absolute values, but rather on the actual values. For example, imagine you have a minimum discount of \$ -2.00 and previous calculation rules have calculated a discount of \$ -1.00. You want a calculation rule to create a bill line for \$ -1.00 to apply a further discount. A minimum charge calculation rule will not work in this case because -1 is considered more than -2. For this business scenario you should use a maximum charge calculation rule.

- **Rule Name:** Minimum Charge
- **Base Package Calculation Rule Business Object:** C1-Minimum
- **Apply Calculation Rule Algorithm Type / Algorithm:** C1-MINIMUM
- **Rule Parameters:**
 - **Calculation Details:** Details regarding how the calculation rule performs its calculations:
 - **Error If No Value:** Indicates what should happen if the system cannot find any calculation rules that are members of the target category at billing time.
 - **Seasonal:** See [Common Parameters](#).
 - **Value Type:** Defines the type of value to use for the minimum value for the rule. For Minimum Charge rules, this should be set to **Charge**.
 - **Value Source:** Specifies the source of the price used to calculate the charge. Depending on the source selected, this will be a Bill Factor, Value, or Algorithm.
 - **Example:** This calculation rule defines a minimum charge for use with residential electric rates.
Calculation Group: Electric Residential
Calculation Rule: MINCHRG
Sequence: 50
Description: Minimum Charge
Description On Bill: Minimum Charge
Print: Yes
Print if Zero: No
Rounding Type: Nearest
Precision: 0.01
FCPO: No
Override Proration: No
Calculation Details:
 - **Error If No Value:** No
 - **Seasonal:** No
 - **Value Type:** Charge
 - **Value Source:** Value
 - **Value:** 75
GL Distribution:
 - **Distribution Source Code:** Specific Distribution Code
 - **Distribution Code:** Revenue - Miscellaneous
 - **Cross Reference:**
 - **Target Category (Category Type / Value):** Charges / Energy Charges
 - **Member Category (Category Type / Value):** Summary Item / Summary Line

- **Member Category (Category Type / Value):** Taxable - State Tax
- **Member Category (Category Type / Value):** Taxable - City Tab

Service Quantity

Service Quantity calculation rules create bill lines that levy charges based on some type of consumption.

Frequently the amount consumed is measured by a meter's registers and sometimes it's calculated using Pre-Processing calculation and sometimes it's derived based on the type of item (such as, lamps). Regardless of how the amount consumed is calculated, the charge for the consumption amount is levied using this type of calculation rule.

- **Rule Name:** Service Quantity
- **Base Package Calculation Rule Business Object:** C1-ServiceQuantity
- **Apply Calculation Rule Algorithm Type / Algorithm:** C1-SQ
- **Rule Parameters:**
 - **Calculation Details:** Details regarding how the calculation rule performs its calculations:
 - **Unit of Measure:** The UOM used as the service quantity that the price is applied to.
 - **Time of Use:** The TOU used as the service quantity that the price is applied to.
 - **Service Quantity Identifier:** The SQI used as the service quantity that the price is applied to.
 - **Error If No Value:** A flag that indicates (Yes or No) if a bill error should be generated if the UOM/TOU/SQI specified on the rule was not supplied at billing time.
 - **Measures Peak:** Indicates (Yes or No) if the UOM/TOU/SQI specified for the rule is used to measure peak (demand) values.
 - **GL Statistical Qty:** A flag that specifies (Yes or No) if GL journal lines generated for this calculation rule should also contain the service quantity amount as a statistical quantity. You would use this option if you keep track of both dollar amounts and consumption units in your general ledger.
 - **Seasonal:** See [Common Parameters](#).
 - **Value Type:** Defines the type of price to be used in the rule's calculations. Valid options include Charge, Percentage, or Unit Rate.
 - **Value Source:** Defines the source of the price used in the rule's calculations. Depending on the source selected, this will be a Bill Factor, Value, or Algorithm.

- **Example:** This calculation rule calculates charges based a customer's KWH consumption.

Calculation Group: Electric Residential Charges

Calculation Rule: KWHCHRG

Sequence: 10

Description: kWh Unit Rate

Description On Bill: Usage %Q at %R per kWh

Print: Yes

Print if Zero: No

Rounding Type: Nearest

Precision: 0.01000

FCPO: No

Override Proration: No

Calculation Details:

- **Unit of Measure:** Kilowatt hour
- **Error If No Value:** Yes
- **Measures Peak:** No
- **GL Statistical Qty:** Yes
- **Seasonal:** No
- **Value Type:** Unit Rate
- **Value Source:** Value
- **Value:** 0.0482000
- **GL Distribution:**
 - **Distribution Source Code:** Specific Distribution Code
 - **Distribution Code:** Revenue - Electric - Residential
- **Cross Reference:**
- **Target Category:**
 - **Category Type:**
 - **Category Value:**
- **Member Category (Category Type / Value):** Revenue / Consumption Charge

Simple Summary

Simple Summary calculation rules create a "subtotal" on the bill by summarizing bill lines produced by other calculation rules in the same calculation group.

- **Rule Name:** Simple Summary
- **Base Package Calculation Rule Business Object:** C1-SimpleSummary
- **Apply Calculation Rule Algorithm Type / Algorithm:** C1-SIMP-SUMM
- **Rule Parameters:**
 - **Referenced Calculation Rules:** Defines the calculation rules that should be included in the summary. Note that any calculation rules listed here must belong to the same calculation group as the Summary rule.
- **Example:** This calculation rule creates a summary of TOU-based charges (based on rules within the same calculation group as this rule).

Calculation Group: Commercial TOU Electric Charges

Calculation Rule: KWHTOT

Sequence: 40

Description: Consumption Subtotal

Description On Bill: Consumption Subtotal

Print: Yes

Print if Zero: No

Rounding Type: Nearest

Precision: 0.01

FCPO: No

Referenced Calculation Rules:

- Off Peak - kWh
- On Peak - kWh
- Shoulder Peak - kWh

Cross Reference:

- **Member Category (Category Type / Value):** Taxable / State Tax

Stepped Service Quantity

Stepped Service Quantity calculation rules create bill lines that levy charges based on some type of consumption when different prices are applied to different ranges of consumption (for example, the first 50 kWh are \$0.43 per kWh, anything in excess of 50 kWh is charged at \$0.71 per kWh)

- **Rule Name:** Stepped Service Quantity
- **Base Package Calculation Rule Business Object:** C1-SteppedSQ
- **Apply Calculation Rule Algorithm Type / Algorithm:** C1-STPD-SQ
- **Rule Parameters:**
 - **Calculation Details:** Details regarding how the calculation rule performs its calculations:
 - **Unit of Measure:** The UOM used as the service quantity that the price is applied to.
 - **Time of Use:** The TOU used as the service quantity that the price is applied to.
 - **Service Quantity Identifier:** The SQI used as the service quantity that the price is applied to.
 - **Error If No Value:** A flag that indicates (Yes or No) if a bill error should be generated if the UOM/TOU/SQI specified on the rule was not supplied at billing time.
 - **Measures Peak:** Indicates (Yes or No) if the UOM/TOU/SQI specified for the rule is used to measure peak (demand) values.
 - **GL Statistical Qty:** A flag that specifies (Yes or No) if GL journal lines generated for this calculation rule should also contain the service quantity amount as a statistical quantity. You would use this option if you keep track of both dollar amounts and consumption units in your general ledger.
 - **Create Step Summary:** Stepped service quantity calculation rules may be configured with either a single step or multiple steps. The Create Step Summary flag is used to produce a summary bill segment calculation line if the calculation rule has multiple steps. Valid options include:
 - **Summarize Step Lines, Print:** Creates a stepped charge summary bill line that will appear on the customer's bill.
 - **Summarize Step Lines, Do Not Print:** Creates a stepped charge summary bill line that will be shown on Bill Segment - Calculation Details, but not appear on the customer's bill.
 - **Step Calculation Details:**
 - **Seasonal:** See [Common Parameters](#).
 - **Step Multiplier Algorithm:** Specifies the algorithm that will be used calculate the step boundaries. Used only if step boundaries are dynamic and are calculated based on something that's only known at billing time.
 - **Values:** Defines the values associated with each of the ranges (steps) of consumption used by the rule. For example, if the charge is applicable to the first 300 kilowatt-hours, you would enter Low Value 0 and High Value 300. When multiple tiers exist, the high value of the first tier is the low value of the second tier (and so on). To extend our example, the second tier would have a low value of 300; the high value may be left blank (the system assumes a blank high value means "to infinity").

- **Low Value:** Defines the low value for the consumption range. This field supports values of up to 14 digits and 4 decimal places (e.g. a maximum value of 99,999,999,999,999.9999).
You can indicate that the low value of a bill line should be substituted into the bill line's description by using the %L substitution variable in the calculation rule's **Description On Bill** field.
 - **High Value:** Defines the high value for the consumption range. This field supports values of up to 14 digits and 4 decimal places (e.g. a maximum value of 99,999,999,999,999.9999).
You can indicate that the high value of a bill line should be substituted into the bill line's description by using the %H substitution variable in the calculation rule's **Description On Bill** field.
 - **Value Type:** Defines the type of price to be applied to the consumption range in the rule's calculations. Valid options include Charge, or Unit Rate.
 - **Value Source:** Defines the source of the price to be applied to the consumption range in the rule's calculations. Depending on the source selected, this will be a Bill Factor, Value, or Algorithm.
 - **Value/Bill Factor/Algorithm:** Specifies the Bill Factor, Value, or Algorithm used when calculating charges for the consumption range.
- **Example:** This calculation rule calculates charges for electric service based on stepped charges for kWh consumption during the Fall
Calculation Group: Electric Residential - Stepped
Calculation Rule: KWHSTFL
Sequence: 10
Description: Fall kWh Stepped Charges
Description On Bill: Usage %Q kWh at %I per kWh %F
Print: Yes
Print if Zero: No
Rounding Type: Nearest
Precision: 0.01000
FCPO: No
Override Proration: No
Calculation Details:
 - **Unit of Measure:** Kilowatt hour
 - **Error If No Value:** No
 - **Measures Peak:** No
 - **GL Statistical Qty:** Yes
 - **Create Step Summary:** Create Summary, Do Not Print**Step Calculation Details:**
 - **Seasonal:** Yes
 - **Seasonal Prorate Method:** Accounting Date
 - **Season Start:** 09-01
 - **Season End:** 11-30
 - **Value 1:**
 - **Low Value:** 0
 - **High Value:** 300

- **Value Type:** Unit Rate
- **Value Source:** Value
- **Value / Bill Factor / Algorithm:** 0.0485
- **Value 2:**
 - **Low Value:** 300
 - **High Value:** [blank]
 - **Value Type:** Unit Rate
 - **Value Source:** Value
 - **Value / Bill Factor / Algorithm:** 0.0564
 - **GL Distribution:**
- **Distribution Source Code:** Specific Distribution Code
- **Distribution Code:** Revenue - Electric - Residential
- **Cross Reference:**
- **Member Category (Category Type / Value):** Revenue / Consumption Charge

Summary

Summary calculation rules create a "subtotal" on the bill. It exists purely for reporting and informational purposes. Summary calculation rules must define the respective target category that they are applied to. The calculation rule(s) that compute charges should be included in the summary must be defined as members of the target category. See **Cross-Reference** under [Common Parameters](#) for more information about Member and Target categories.

- **Rule Name:** Summary
- **Base Package Calculation Rule Business Object:** C1-Summary
- **Apply Calculation Rule Algorithm Type / Algorithm:** C1-SUMMARY
- **Rule Parameters:**
 - **Calculation Details:** Details regarding how the calculation rule performs its calculations:
 - **Error If No Value:** Indicates what should happen if the system cannot find any calculation rules that are members of the target category at billing time.
- **Example:** This calculation rule creates a consumption summary on the bill based on other calculation rules included in the rate that belong to the "Revenue / Consumption Charge" category.

Calculation Group: Electric Residential Charges

Calculation Rule: USGSUM

Sequence: 30

Description: Usage Summary

Description On Bill: Summary

Print: Yes

Print if Zero: No

Rounding Type: Nearest

Precision: 0.01000

FCPO: No

Calculation Details:

- **Error If No Value:** No
Cross Reference:
- **Target Category (Category Type / Value):** Revenue / Consumption Charge
- **Member Category (Category Type / Value):** Summary / Summary of Consumption Charge

Rate Check

This section describes the features and functionality of Rate Check.

About Rate Check

The **Rate Check** feature allows you to test your rate schedules under different scenarios. For example, you can test your rates for an existing account using previous bill segments, or by providing user-specified bill period and service quantities.

Performing a Rate Check

NOTE: The Rate Check portal works with both calculation rule-based and component-based rate schedules.

Use this procedure to perform a rate check.

- Select **Menu > Rates > Rate Check**.
- Select the **Rate Schedule** for the rate check.
- Select the **Service Agreement** for the rate check.
- Select the **Bill Segment** for the rate check (if you wish to base the rate check on an existing bill segment).
- Enter the **Start Date**, **End Date**, and **Accounting Date** for the rate check.
- Select the **Revenue Class** for the rate check.
- If you are basing the rate check on user-specified **Service Quantities**, enter the following for each as applicable:
 - **UOM:** The unit of measure applicable for the rate check (based on the specified rate schedule)
 - **TOU:** The time of use applicable for the rate check (based on the specified rate schedule)
 - **SQL:** The service quantity identifier applicable for the rate check (based on the specified rate schedule)
 - **Measured Quantity:** The amount of the service quantity specified.
- **Service Point ID:** The service point which recorded the service quantities, if applicable
Note: If you specified a Service Agreement and Bill Segment, this section is populated based on the selected data, but can be manually overwritten.
- Specify characteristic types and values for any **Characteristics** are applicable to the rate check. Characteristic types and values are used to apply appropriate bill factor values during rate processing.
- If you are using a calculation rule-based rate schedule, specify if the system **Should Trace** the process. This produces logs that outline the calculation groups and rules used by the rate schedule.
- Execute the rate check:
 - If you wish to execute the rate check using a specified bill segment or service quantities, click **Check Rate**.
 - If you wish to execute the rate check using billing determinants retrieved from an external system (such as Oracle Utilities Meter Data Management), select the appropriate function from the **Select Function** dropdown list.

Viewing the Results of a Rate Check

The outcome of the rate check process is displayed on the **Results** tab. This tab contains the following zones:

- **Main:** Displays results of the rate check, including:
 - **Rate Schedule:** The rate schedule used in the rate check
 - **Revenue Class:** The revenue class used for the rate check.
 - **Bill Period:** The start and end dates for the bill period used by the rate check.
 - **Consumption Period:** The start and dates for the consumption period used by the rate check.
 - **Accounting Date:** The Accounting Date used by the rate check.
 - **Calculated Amount:** The calculated total for the rate check
- **Calculation Lines:** Displays the bill calculation headers and lines for the rate schedule.
- **Read Details:** Displays meter read details for the consumption used in the rate calculation.
- **SQ Details:** Displays a list of service quantities used in the rate calculation.
- **Characteristics:** Displays characteristics referenced by the rate calculation (if applicable).
- **Trace Log:** Displays logs that outline the calculation groups and rules used by the rate schedule. This zone is populated only if using a calculation rule-based rate schedule, and if the Should Trace dropdown list is set to "No".

Effective Dates and Price Proration

This section describes how proration applies to different types of calculation rules. Proration implies assessing charges proportionately.

The term "proration" describes two different issues:

- Prorating a charge whose value changes during a bill period. For example, if a tax rate changes during a bill period and you've indicated that such changes should be prorated, the system prorates the tax change (e.g., 20 days at 5% and 10 days at 6%).
- Prorating charges when the time period being billed is not in sync with the time period in which the charges were defined in the rate. For example, if a rate contains a flat monthly charge and the bill period spans two months, the flat charge must be prorated.

This is a complicated topic as it's possible for many proration issues to exist on a single bill. For example, on a single bill:

- The rate structure can change several times during the bill period (i.e., multiple rate versions are effective).
- The taxing authority changes the tax rate.
- The customer's tax exemption changes.
- The customer-specific price can change.
- etc.

Types of Proration

The following section describes the types of proration performed by applying a rate.

FASTPATH:

For more information on how prorated charges are presented on the printed bill, refer to [How To Use Description On Bill](#).

Consumption Period Proration

A rate schedule specifies its frequency. Bill segments generated using a rate are expected to have a consumption period that corresponds to this frequency. When a bill segment's consumption period falls outside of the rate frequency's normal period, proratable service quantities may be adjusted to match the normal period for calculation. The service quantities are then re-adjusted based on calculation period proration.

FASTPATH:

Refer to [Service Quantity Proration](#) for more information about these calculations.

Calculation Period Proration

There can be multiple versions of a given rate over time. Each version has an effective date. When the system detects that a rate schedule has multiple versions of a rate in effect during a bill period, it may or may not prorate the charges. You control exactly how the system handles this situation using the rate schedule's proration parameters.

If multiple rate versions are effective during the consumption period and the rate schedule is configured to prorate the rate versions, a given bill segment will contain a set of bill calculation lines for each rate version. You should consider quite carefully how to handle this situation on your printed bills as rate version proration can confuse a customer.

FASTPATH:

Refer to [Defining Calculation Rules](#) for more information.

Bill Factor Proration

A rate contains calculation rules. The primary reason a calculation rule exists is to define how much to charge for the services sold by your company. When you create calculation rules, you have two ways to indicate how much to charge:

- You can specify the value directly in a calculation rule.
- You can have the calculation rule use a bill factor that contains the value.

Bill factors are effective-dated (meaning, their values may change over time). When the system detects that a calculation rule's bill factor has multiple values in effect during a bill period, it may or may not prorate the charges. You control exactly how the system handles this situation using the bill factor's proration parameters.

FASTPATH:

Refer to [Defining Bill Factors](#) and [Bill Factor Value Proration](#) for more information.

Tax Exemption Proration

Bill factors that levy taxes may or may not be eligible for tax exemptions; it's up to the respective taxing authority. Customers who are eligible for tax exemptions will have their tax obligation reduced (or nullified) at billing time.

Whether or not a customer is tax exempt (and the percent exempt) is defined on the service agreement's tax exemption page. A customer's tax exemptability is effective-dated (it may change over time). If a customer's tax exemptability changes during a bill period, the system may or may not prorate the charges. You control exactly how the system handles this situation using the bill factor's proration parameters.

Contract Value Proration

Some types of bill factors do not have the same value for all customers. For example, you may have rates where the price per kilowatt-hour can be different for every customer using the rate.

For bill factors whose value is customer-specific, the value is defined on the service agreement's contract value page. The contract value is effective-dated (it may change over time). If a customer's contract value changes during a bill period, the system may or may not prorate the changes. You control exactly how the system handles this situation using the bill factor's proration parameters.

Contract Rider Proration

Contract riders are used when the charge associated with a bill factor is only applicable to some customers for some period of time. For example, if a bill factor is used to provide a discount during the first three months of service, then a contract rider would be used.

A customer's contract rider applicability period is defined on the service agreement's contract rider page. A rider's applicability may change during a customer's bill period. You control exactly what the system does when a rider's applicability changes during a bill period using the bill factor's proration parameters.

A Service Agreement's Rate Changes Are Not Prorated

A service agreement's rate is effective-dated (it may change over time). When the system calculates a service agreement's bill segment when multiple rates are effective during the bill period, it will use a single rate from the service agreement's rate history. The system chooses the rate as per the service agreement's SA type's rate selection date.

FASTPATH:

Refer to [SA Type - Rate](#) for more information.

Proration Factors

The purpose of calculation rules is to generate bill calculation lines. When rate application builds bill calculation lines, it may also prorate the charges.

There are multiple types of proration performed by rate application. Service quantities, step boundaries, rate values, and bill factor values may all be prorated as part of applying a rate.

We need to establish some terms in order to understand the calculations.

Normal Days

As mentioned previously, the rate schedule references a frequency that specifies the number of times per year that service agreements referencing the rate are expected to bill. The following formula dictates a rate frequency's normal days: $365 \text{ days} / \text{number of periods per year}$.

Example:

- For a monthly frequency (12 periods per year), $365 / 12 = 30$ days.
- For a quarterly frequency (4 periods per year), $365 / 4 = 91$ days.

FASTPATH:

Refer to [Defining Frequency Codes](#) for more information.

Consumption Period Factor

Before applying a rate, the bill segment's consumption period is determined. The ratio of normal days to consumption period days is the consumption period factor.

The system uses the Minimum and Maximum Days Offset on the rate's [Frequency](#) to determine whether or not the calculation rule should be prorated due to a short or long consumption period.

If the number of days in the consumption period is within the tolerance of days determined by the specified on the rate's frequency, the consumption period factor is 1 (not applicable).

Example:

If the consumption period spans 60 days and the rate's normal days equals 30 days then the consumption period factor is:

- $30 \text{ days} / 60 \text{ days} = 0.5$

If the consumption period spans 31 days and the rate's normal days equals 30 days and the maximum offset is 3 days, the consumption period factor is 1 (not applicable) because the consumption period days falls within the tolerance specified on the frequency.

FASTPATH:

For more information on how a bill segment's consumption period is determined, refer to [How the System Requests How Much Was Consumed](#). For more information on specifying minimum and maximum offset days on frequency, refer to [Defining Frequency Codes](#).

Calculation Period Factor

The calculation period is the date range where a rate version is effective during the consumption period. For each rate version that is effective during the consumption period, a bill segment calculation period is created. A set of bill calculation lines is created for each calculation period.

A calculation period factor is determined for each calculation period. The calculation period factor is the ratio of calculation period days to normal days. If the consumption period factor is 1 (not applicable), then the calculation period factor is the ratio of calculation period days to consumption period days.

Example:

If the consumption period covers April 1 to April 30 and there was a new effective rate version as of April 21, there are two calculation periods.

- Calculation period April 1 to April 20, calculation period factor = $20 \text{ days} / 30 \text{ days} = 0.6666667$.
- Calculation period April 21 to April 30, calculation period factor = $10 \text{ days} / 30 \text{ days} = 0.3333333$.

BF Value Period Factor

The bill factor value period is the date range where a proratable bill factor value is effective during the calculation period.

When a bill factor value changes during the calculation period, the results is that multiple bill calculation lines are generated for the same calculation rule.

The ratio of the number of days within the calculation period that a distinct value is effective to the number of days in the calculation period determines the BF value period factor. When the bill factor is set up not to prorate, the BF value period factor is 1 (not applicable).

Example:

If the state tax rate changes from 6% to 6.5% on April 16 and the calculation period is April 1 to April 30, there are two bill factor value periods.

- Bill factor value period April 1 to April 15, BF value period factor = 15 days / 30 days = 0.5.
- Bill factor value period April 16 to April 30, BF value period factor = 15 days / 30 days = 0.5.

FASTPATH:

Refer to [Defining Bill Factors](#) for more information on specifying whether the bill factor allows proration.

Overriding Proration Factors

If the system logic for determining proration factors does not satisfy your requirements, you may plug in an override proration algorithm to calculate the proration factors as required by your implementation.

- For Calculation Rule-Based Rates, the override proration algorithm is specified in the calculation rule's business object.
- For Component-Based Rates, the overriding proration algorithm is specified in the [Installation](#) record.

The system is delivered with an algorithm type that sets the proration factors to 1 (not applicable) when a predefined characteristic is specified on a calculation rule. Refer to OVPF-NOPROR for more information.

Service Quantity Proration

When a bill calculation line is generated for a service quantity type calculation rule, the applicable service quantity is multiplied by the consumption period factor. That product is then multiplied by the calculation period factor to determine the prorated service quantity for the bill calculation line.

Example:

Customer's electricity bill segment's consumption period is from April 1 through May 15. A new rate version for the rate schedule is effective as of April 16. 100 kWh is consumed.

Assuming a monthly frequency, if the consumption period spans 45 days and the first calculation period spans 15 days, and the applicable service quantity is 100 kWh; then:

- Consumption period factor = 30 normal days / 45 days = 0.6666667.
- Calculation period factor = 15 days / 30 normal days = 0.5.
- Prorated service quantity = 100 kWh x 0.6666667 x 0.5 = 33 kWh.

The next calculation period extends to the end of the consumption period (30 days):

- Consumption period factor does not change = 0.6666667.
- Calculation period factor = 30 days / 30 days = 1.0.
- Prorated service quantity = 100 kWh x 0.6666667 x 1.0 = 67 kWh.

Measures Peak

If the calculation rule specifies that the service quantity measures peak, then service quantity proration is not performed. Although service quantities are not prorated if a calculation rule measures peak, calculation rule values (like price per kW) are prorated.

FASTPATH:

Refer to [Calculation Rule Value Proration](#) for more information.

Step Proration

If a calculation rule's charges are based on stepped pricing then the step boundaries are also prorated (as long as the calculation rule is not marked as measures peak). Step boundaries are multiplied by the calculation period factor to determine the adjusted steps boundaries.

Example:

Assuming a monthly frequency, if the calculation rule's step boundaries are 100 kWh to 300 kWh, and the calculation period is 45 days; the step boundaries are prorated as:

- $45 \text{ days} / 30 \text{ days} \times 100 \text{ kWh} = 150 \text{ kWh}$.
- $45 \text{ days} / 30 \text{ days} \times 300 \text{ kWh} = 450 \text{ kWh}$.

Step Multipliers

If the calculation rule specifies that the steps be multiplied by the result value of another calculation rule, step proration is not performed. It is assumed that the result value from the referenced calculation rule has already been prorated, as the referenced step calculation rule is subject to [Calculation Rule Value Proration](#).

Calculation Rule Value Proration

Except for summary type calculation rules (which are not prorated at all), a value is specified on the calculation rule. The value may be a unit rate, percentage or charge. The value may be specified directly on the calculation rule, derived from a bill factor, derived from another calculation rule, or calculated by an algorithm.

Regardless of where the calculation rule value comes from, it will be multiplied by the calculation period factor when determining the charge on a bill calculation line. Exceptions to this rule are:

- Unit rate values where the calculation rule's measures peak attribute is not checked.
- Percentage values.
- Calculation rule values derived from another calculation rule.

Even though the calculation rule values are not prorated for unit rate and percentage value types, if these rate values change during the calculation period due to a bill factor value change, bill factor value proration still applies.

Values derived from another calculation rule are not subject to rate value proration, as calculation rule value proration was already performed on the referenced calculation rule. Again, if the bill factor value changed on the referenced calculation rule, bill factor value proration still applies.

Example:

A calculation rule charges \$2.00 per kW. The rate schedule's normal days equals 30, and the calculation period spans 15 days. The peak kW service quantity is 50 kW.

- The calculation period factor is 0.5 (15 days / 30 days).
- Calculation rule value proration yields $\$2.00 \times 0.5 = \1.00 per kW.

FASTPATH:

For more information on bill factor value proration, refer to [Bill Factor Value Proration](#).

Bill Factor Value Proration

Bill factor value proration behaves the same way any time a bill factor value changes within a calculation period. This could be due to a change in a tax rate, a contract rider becoming effective, a tax exemption expiring, etc.

Multiple bill calculation lines are generated for a given calculation rule when a prorable bill factor value changes during the calculation period.

Example:

If the state tax rate changes from 6% to 6.5% on April 16, and the calculation period is April 1 to April 30.

- The first BF value factor period April 1 to April 15, so BF value period factor is 0.5.
- The value used in the first bill calculation line for state tax is $6\% \times 0.5 = 3\%$.
- The second bill factor value period is April 16 to April 30, so the BF value period factor is 0.5.
- The value used in the second bill calculation line for state tax is $6.5\% \times 0.5 = 3.25\%$.

Example of Generating Prorated Bill Calculation Lines

Let's say that 1200 kWh was consumed from March 17 to April 30. The peak kW for the consumption period is 20 kW.

A monthly rate schedule E-COM1 exists with two rate versions.

Rate version effective prior to April 1 has the following components:

- \$0.05 per kWh.
- \$1.00 per kW.

Rate version effective as of April 1 has the following calculation rules:

- \$0.04 per kWh; as of April 16, \$0.07 per kWh (new effective bill factor value).
- \$1.50 per kW; as of April 16, \$1.25 per kW (new effective bill factor value).

Calculation Period March 17 to March 31

The consumption period spans 45 days, so the consumption period factor is $30 \text{ normal days} / 45 \text{ days} = 0.6666667$.

This calculation period spans 15 days, so the calculation period factor is 0.5.

Service quantity proration for the first calculation period yields:

- $1200 \text{ kWh} \times 0.6666667 \text{ (consumption period factor)} \times 0.5 \text{ (calculation period factor)} = 400 \text{ kWh}$.

- $20 \text{ kW} \times 1$ (not applicable) = 20 kW.

Calculation rule value proration for the first calculation period yields:

- $\$0.05 \times 1$ (not applicable) = \$.05 per kWh.
- $\$1.00 \times 0.5$ (calculation period factor) = \$0.50 per kW.

First Set of Bill Calculation Lines

Bill calculation line 1: $400 \text{ kWh} \times \$0.05 = \20.00 .

Bill calculation line 2: $20 \text{ kW} \times \$0.50 = \10.00 .

Calculation Period April 1 to April 30

This calculation period spans 30 days, so the calculation period factor is 1.

Service quantity proration for the calculation period yields:

- $1200 \text{ kWh} \times 0.6666667$ (consumption period factor) $\times 1$ (calculation period factor) = 800 kWh.
- $20 \text{ kW} \times 1$ (not applicable) = 20 kW.

Calculation rule value proration for the first calculation period yields:

- $\$0.04 \times 1$ (not applicable) $\times 0.5$ (BF value period factor) = \$0.02 per kWh.
- $\$0.07 \times 1$ (not applicable) $\times 0.5$ (BF value period factor) = \$0.035 per kWh.
- $\$1.50 \times 1$ (calculation period factor) $\times 0.5$ (BF value period factor) = \$0.75 per kW.
- $\$1.25 \times 1$ (calculation period factor) $\times 0.5$ (BF value period factor) = \$0.625 per kW.

Second Set of Bill Calculation Lines

Bill calculation line 1: $800 \text{ kWh} \times \$0.02 \text{ per kWh} = \16.00 .

Bill calculation line 2: $800 \text{ kWh} \times \$0.035 \text{ per kWh} = \26.00 .

Bill calculation line 3: $20 \text{ kW} \times \$0.75 \text{ per kW} = \15.00 .

Bill calculation line 4: $20 \text{ kW} \times \$0.625 \text{ per kW} = \12.50 .

Seasonal Proration

Seasonal proration adds another layer of complexity. If calculation rules are specified to prorate seasonally, the seasonal period specified on a given seasonal calculation rule dictates how a calculation rule's value or associated service quantity is prorated.

There are two proration methods, Prorate and Prorate Seasonal SQ, which may be specified on seasonal calculation rules. Both of these proration methods behave the same way with respect to calculation rule value proration. If a given seasonal calculation rule is eligible for [Calculation Rule Value Proration](#), the ratio of days in the season that are applicable during the calculation period to the days in the calculation period determines the seasonal factor. When it comes to service quantity proration, the two proration methods are different. If a given seasonal calculation rule is eligible for [Service Quantity Proration](#), it prorates the service quantities as follows:

- Prorate. A seasonal factor is calculated as the ratio of days in the season that are applicable during the calculation period to the days in the calculation period. This ratio is applied along with the consumption period factor and calculation period factor to determine the prorated service quantity.
- Prorate seasonal SQ. In this case, it is assumed that either the meter measures seasonal consumption on separate registers or the consumption has been split into separate service quantities by other means (like an SQ rule). To determine a prorated seasonal service quantity, the seasonal proration factor is calculated as for a Prorate seasonal calculation rule. The seasonal factor is then multiplied by another ratio of total consumption period days to days in the season that are

applicable for the total consumption period. This modified seasonal factor is applied along with the consumption period factor and calculation period factor to determine the prorated service quantity.

NOTE:

Prorate seasonal SQ. Specify this option only if you can determine the seasonal consumption as an independent service quantity for use by rate application. Because the service quantities themselves dictate the applicability of the calculation rule, a given service quantity need not appear in rate versions effective outside the season (i.e. a rate version effective on October 1 may not include calculation rules that charge for kWh/summer).

Override Seasonal Proration. If the seasonal functionality provided with the system does not work for your organization, you may override the logic using the Override Seasonal Proration plug-in spot on the [installation](#) record. For example, perhaps the seasonal period is determined dynamically based on the scheduled meter read date of the bill cycle.

Example (Prorate):

Let's say that 600 kWh and 50 kW are the billable service quantities for a consumption period from April 1 to April 30. Prorate seasonal calculation rules are defined on a monthly rate that charge \$0.05 per kWh and \$0.75 per kW from January 1 to April 15. Prorate seasonal calculation rules are defined on the same rate version that charge \$0.06 per kWh and \$0.80 per kW between April 16 and December 31. Assume only one rate version is effective for the consumption period.

- The consumption period factor is 1 (not applicable).
- The calculation period factor is 1.0.
- The seasonal factor for the kWh calculation rule whose season is effective from January 1 to April 15 is 0.5 (15 season days in calculation period / 30 days in the calculation period).
- The resulting bill calculation line uses service quantity proration:
 - 600 kWh x 0.5 (seasonal factor) x \$0.05 = \$15.00.
- The seasonal factor for the kW calculation rule whose season is effective from January 1 to April 15 is also 0.5.
- The resulting bill calculation line uses calculation rule value proration:
 - 50 kW x \$0.75 x 0.5 (seasonal factor) = \$18.75.
- The seasonal factor for the kWh calculation rule whose season is effective from April 16 to December 31 is 0.5.
- The resulting bill calculation line uses service quantity proration:
 - 600 kWh x 0.5 (seasonal factor) x \$0.06 = \$18.00.
- The seasonal factor for the kW calculation rule whose season is effective from April 16 to December 31 is also 0.5.
- The resulting bill calculation line uses calculation rule value proration:
 - 50 kW x \$0.80 x 0.5 (seasonal factor) = \$20.00.

Example (Prorate seasonal SQ):

Let's say that a given meter measures winter consumption separate from summer consumption. The meter itself measures kWh/summer on a register between June 21 and September 18, and measure kWh/winter on another register at other times of the year.

We are generating a bill segment with a consumption period from September 2 to October 30. A monthly rate schedule has two rate versions effective during the consumption period. The latest rate version is effective on October 1.

Each of the rate version calculation groups have Prorate seasonal SQ seasonal calculation rules defined. The first rate version's calculation rules charge \$0.06 per kWh/summer and \$0.05 per kWh/winter. The second rate version calculation group has a single calculation rule that charges \$0.05 per kWh/winter.

Assume that the billable service quantities are 800 kWh/summer and 1600 kWh/winter.

First set of bill calculation lines (September 2 to September 30):

- The consumption period factor is 30 normal days / 60 consumption days = 0.5.
- The calculation period factor is 30 calculation days / 30 normal days = 1.0.
- calculation rule 1 (\$0.06 per kWh/summer):
- The seasonal factor 17 seasonal days / 30 calculation days = 0.5666667.
- The modified seasonal factor is 0.5666667 x 60 consumption days / 17 seasonal days = 2.0.
- The resulting bill calculation line:
- 800 kWh/summer x 0.5 (consumption period factor) x 2.0 (modified seasonal factor) x \$0.06 = \$48.00.
- calculation rule 2 (\$0.05 per kWh/winter):
- The seasonal factor is 12 seasonal days / 30 calculation days = 0.4.
- The modified seasonal factor is 0.4 x 60 consumption days / 42 seasonal days = 0.571428.
- The resulting bill calculation line:
- 1600 kWh/winter x 0.5 (consumption period factor) x 0.571428 (modified seasonal factor) x \$0.05 = \$22.86.

Second set of bill calculation lines (October 1 to October 30):

- The consumption period factor is 30 normal days / 60 consumption days = 0.5.
- The calculation period factor is 30 calculation days / 30 normal days = 1.0.
- Calculation rule 1 (\$0.05 per kWh/winter):
- The seasonal factor 30 seasonal days / 30 calculation days = 1.0.
- The modified seasonal factor is 1.0 x 60 consumption days / 42 seasonal days = 1.428571.
- The resulting bill calculation line:
- 1600 kWh/winter x 0.5 (consumption period factor) x 1.428571 (modified seasonal factor) x \$0.05 = \$57.14.

FASTPATH:

For more information on specifying seasonal proration options, refer to [Defining Calculation Rules](#).

Price Changes and Interval Quantities

All of the above sections described situations where the service quantities will be prorated due to changes in the price during the billing period. The above sections assume that the bill contains a simple metering scenario, where reads will not exist on the date of the price break.

However, consider an interval billing example. There are two basic pricing scenarios for interval quantities:

- Interval prices are applied to interval quantities. In this case, proration is not applicable because the prices are changing at small intervals and the appropriate usage rules in Oracle Utilities Meter Data Management understand how to apply the prices to the interval quantities.
- Time of use prices. In this case, interval quantities are being mapped to time of use codes. Oracle Utilities Meter Data Management can compare interval quantities to a time of use map to create billing determinants for Oracle Utilities Customer Care and Billing. These will result in new entries in the bill segment's SQ collection when received by Oracle Utilities Customer Care and Billing. Calculation rules are then apply the appropriate price(s) for each SQ. In the time of use pricing scenario, it is possible for the prices to change during the usage or billing period. When usage requests are created by Oracle Utilities Customer Care and Billing, they will contain rate version date breaks to indicate to Oracle Utilities Meter Data Management to calculate the usage for each rate version period. Proration should not be necessary when the rate is applied for each usage (rate version) period. However, if prices are configured as bill factors and there

are changes in bill factor values within the usage period, then proration may occur as the date breaks when bill factor values change are not included in the usage request from Oracle Utilities Customer Care and Billing.

Setting Up Estimated Consumption for Items

Some types of physical devices (such as, items) use power but a meter does NOT measure the power consumed. The most common example is a street light. If this situation exists for your company AND if the amount charged for the lamp varies based on the amount of estimated power used, then you will have to maintain estimated DAILY consumption for each type of item. The system uses this information at billing time to estimate how much power was used by the customer's items and then prices the estimated consumption as per the terms in the service quantity calculation rule.

Select **Admin > Rates > Item Type SQ Estimate** to define estimated consumption.

Description of Page

Select the **Item Type** using the search.

Enter the estimated daily consumption in the **Daily Service Quantity**. Each Service Quantity has an **Effective Date** so that changes in the estimated quantities may be recorded over time.

NOTE:

The unit of measure of the daily service quantity is displayed adjacent to the item type description. This value is defined on the item type table. Refer to [Device Types](#) for more information.

Where Used

This information is used when the system calculates a bill segment for a service agreement that references service points with items. If the items reference item types for which the system should estimate consumption, the system extracts the daily consumption amount from this table.

Setting Up Degree Days (and Average Temperatures)

Many organizations print degree-day and/or average temperature information on their customers' bills. Select **Admin > Billing > Degree Days > Search** to define these values for a given trend area.

Description of Page

The easiest way to define degree days is to select a **Trend Area** and **Month In Year** and tab out of the field. The system generates one row in the **Degree Days** collection for each day of the month. After the days exist in the collection, you should define the following for each day:

Degree Day This is a unit of measure used to express the extent to which temperatures vary from a specific reference temperature on a given date.

Maximum Temperature This is the maximum temperature on a given date.

Minimum Temperature This is the minimum temperature on a given date.

Average Temperature This is the average temperature on a given date.

Where Used

This information may be used by your bill print routines.

United Kingdom VAT and CCL

The topics in this section provide information about value added tax (VAT) and climate change levy (CCL) charges that are specific to non-domestic customers in the United Kingdom market.

NOTE:

Applicable for UK market. This section is only relevant for the United Kingdom market. Other markets may disregard this section.

UK VAT Overview

Two rates of VAT, referred to as standard rate VAT and reduced rate VAT, are applicable to energy related charges in the UK. Domestic (i.e., residential) customers always pay VAT at the reduced rate. Non-domestic customers on the other hand normally pay standard rate VAT. However, part or all of the energy related charges for a non-domestic customer might be subject to reduced rate VAT. De minimis and VAT declarations affect the percentage of the energy related charges that is subject to each VAT rate:

- If average daily usage at a premise for a given service type does not exceed a certain threshold (the de minimis limit), all energy related charges at that premise / service type are taxed at the reduced rate.
- Some non-domestic customers, such as those with a mixed-use premise, may be eligible to pay reduced rate VAT on part or all of their energy related charges. Customers may file a VAT declaration specifying the percentage of their energy related charges that are eligible for reduced rate VAT - refer to [Maintaining Declarations](#) for more information. If the declared percentage exceeds a given threshold, the declared percentage is deemed to be 100% and the customer pays VAT at the reduced rate on all energy related charges at that premise. VAT declarations are non-transferable and must be filed for each account, premise, and service type combination.

In addition to the potential for different rates of VAT to be applicable on a bill, UK tax regulations require that excess credits are considered a prepayment of energy related charges together with VAT. Refer to [Excess Credits and UK VAT](#) for more information.

The system comes supplied with various algorithms types that can be used to perform the VAT calculations.

UK CCL Overview

The climate change levy (CCL) is based on the amount of energy used that is subject to standard rate VAT. Similarly to VAT declarations, customers may file for exemption from CCL. A CCL declaration specifies the percentage of the CCL charges that the customer is exempt from - refer to [Maintaining Declarations](#) for more information. CCL declarations are non-transferable and must be filed for each account, premise, and service type combination.

CCL charges themselves are subject to standard rate VAT.

UK VAT and CCL Bill Examples

The following examples show how a bill for a non-domestic customer is affected by de minimis, VAT declarations, and CCL declarations. In the examples, standard rate VAT of 17.5%, reduced rate VAT of 5%, a VAT declaration threshold of 60%, and a CCL charge of 0.43p per unit of energy are used.

Example 1 - Normal Account

This example shows the bill for a normal non-domestic account with no declarations and consumption above the de minimis limit. Standard rate VAT is applied to all energy related charges (the standing charge and the per unit charge) and to the CCL charge.

Bill Line	Amount
Standing Charge	10.00
2,000 units @ 10p	200.00
CCL on 2,000 units @ 0.43p	8.60
VAT @ 17.5% on 218.60	38.25
Total	256.85

Example 2 - Account with Consumption Under the De Minimis Limit

In this example, consumption does not exceed the de minimis limit and therefore reduced rate VAT is applied to all the energy related charges. There is no climate change levy because only units subject to standard rate VAT are subject to CCL.

Bill Line	Amount
Standing Charge	10.00
2,000 units @ 10p	200.00
VAT @ 5% on £210.00	10.05
Total	220.05

Example 3 - Account with VAT Declaration

This example is for a non-domestic account with a VAT declaration of 20%. Consumption is above the de minimis limit. CCL applies to only 80% of the total units as 20% is subject to reduced rate VAT and therefore exempt. 80% of the energy related charges (the standing charge and the per unit charge) and all of the CCL charge are subject to standard rate VAT. 20% of the energy related charges are subject to reduced rate VAT.

Bill Line	Amount
Standing Charge	10.00
2,000 units @ 10p	200.00
CCL on 1,600 units @ 0.43p	6.88
VAT @ 17.5% on £174.88	30.60
VAT @ 5% on £42.00	2.10
Total	249.58

Example 4 - Account with VAT Declaration and CCL Declaration

This example is for a non-domestic account with a VAT declaration of 20% and a CCL declaration of 10%. Consumption is above the de minimis limit. CCL applies to only 80% of the total units as 20% is subject to reduced rate VAT and therefore exempt. The customer gets a credit (CCL relief) for 10% of the CCL charges as a result of the CCL declaration. 80% of the energy related charges (the standing charge and the per unit charge) and all of the CCL charge less the CCL reliefs are subject to standard rate VAT. 20% of the energy related charges are subject to reduced rate VAT.

Bill Line	Amount
Standing Charge	10.00
2,000 units @ 10p	200.00
CCL on 1,600 units @ 0.43p	6.88
CCL relief	<0.68>
VAT @ 17.5% on £174.20	30.48
VAT @ 5% on £42.00	2.10
Total	248.78

Billing and UK VAT

The following sections describe how VAT rules are implemented when a bill is produced.

Application of De Minimis

The de minimis rule specifies that all energy related charges at a premise be subject to reduced rate VAT if the total usage at a premise does not exceed a certain threshold. To determine if de minimis applies, the total billed consumption for a premise must therefore be known. However, energy usage at a premise may be measured with several meters and billed by multiple service agreements. To ensure that the final billed consumption for the premise is used to determine if de minimis applies, all service agreements for an account of a given service type at a given premise should be billed together and de minimis should be checked after the bill segments have been generated. In addition, all bill segments on one bill for consumption at a given premise must be for the same bill period.

NOTE:

Bill segments from different periods may not appear on the same bill. If a bill segment is canceled, all bill segments associated with consumption at a given premise for the same service type must be canceled and re-billed together. You cannot re-bill the bill segment on a bill for a different period.

An **Apply De Minimis Rule** Customer Class – Pre Bill Completion algorithm type CPBC-DMCH is supplied with the base package that checks for de minimis at bill completion time. The base bill completion algorithm type checks that for any service agreement that was billed, bill segments for all the account's service agreements with the same service type and characteristic premise exist on the bill. It then calculates the total consumption for the premise and determines if de minimis applies. If de minimis applies, it sets a bill characteristic whose value is the premise ID to indicate that de minimis applies and regenerates the bill segment. Refer to the **Apply De Minimis Rule** algorithm type CPBC-DMCH for more information on how this type of algorithm operates.

For calculation rule-based rates, the **Apply VAT to Cross-Referenced Charges** calculation rule business object (C1-**ApplyVatToCrossRefCharge**) calculates standard and reduced rate VAT and applies the de minimis rule if the bill characteristic for de minimis is found. Refer to [Calculation of VAT](#) for more information. Note that during the initial generation of each bill segment, the characteristic will not exist and standard rate VAT will be applied. This means that if you look at a bill before it is complete, VAT may not be accurately reflected.

NOTE:

Batch billing cannot regenerate re-billed bill segments. If you cancel and rebill a bill segment, you should complete the bill on-line so that the re-billed bill segments can be regenerated if de minimis applies.

Calculation of VAT

To calculate VAT, the percentages of energy related charges subject to standard rate VAT and reduced rate VAT must be determined. As these percentages vary from customer to customer and even from one bill to the next for the same customer, their calculation must take place at billing time and is handled by the following:

For calculation rule-based rates, the **Apply VAT to Cross Referenced Charges** business object (**C1–ApplyVatToCrossRefCharge**) is provided to calculate the percentages of energy related charges subject to standard rate and reduced rate VAT, taking into account de minimis and any VAT declaration that is in effect for the service type, account, and premise. The percentages can then be applied to the appropriate charges that are cross-referenced.

Calculation of CCL

CCL is a charge per unit of energy subject to standard rate VAT. It is therefore dependent on the same percentage of energy related charges subject to standard rate VAT determined during the calculation of VAT.

For calculation rule-based rates, a **Calculate Climate Levy and Relief Charges** calculation rule business object (**C1–ApplyCCLCharges**) is provided to calculate CCL charges and CCL relief, taking into account any CCL declarations that are in effect for the service type, account, and premise.

Excess Credits and UK VAT

When a financial transaction that results in a credit balance for a service agreement is frozen, the amount of the excess credit must be accounted for as a prepayment of energy related charges and VAT. VAT is calculated at the reduced rate for domestic customers and at the standard rate for non-domestic customers. When the excess credit is used, the VAT liability is reversed.

A **Create Excess Credit GL Details** Customer Class FT freeze algorithm type CFTZ-VAT-GL is provided to create additional GL detail entries for unbilled revenue and VAT liability when the freezing of an FT results in a credit balance or a change to a service agreement's credit balance.

Excess Credit GL Accounting Example

The following example shows the additional GL details that are created when a service agreement's balance changes and the starting or ending balance is a credit. For this example, a single VAT rate of 10% is used simply to illustrate the principle.

The service agreement has a zero starting balance. Note the following:

- When the first payment is received, the overpayment results in a credit balance and additional GL entries are created to recognize the unbilled energy revenue and unbilled VAT liability.
- When the second bill segment is created, the credit balance is reduced and additional GL entries are created to back out the unbilled GL entries, up to the amount of the credit balance.
- When the bill segment is canceled, the service agreement again has a credit balance and additional GL entries are created to recognize the unbilled energy revenue and unbilled VAT liability.

Event	Normal GL Accounting	Additional GL Accounting	SA Balance
Bill segment for £110 created	A/R 110		110
	Revenue <100>		
	VAT <10>		
Payment of £330 is received	Cash 330	A/R 220	<220>
	A/R <330>	Unbilled Energy <200>	
		Unbilled VAT <20>	
Bill segment for £275 created	A/R 275	A/R <220>	55
	Revenue <250>	Unbilled Energy 200	
	VAT <25>	Unbilled VAT 20	
Payment of £55 is received	Cash 55		0
	A/R <55>		
Bill segment for £275 is canceled	A/R <275>	A/R 275	<275>
	Revenue 250	Unbilled Energy <250>	
	VAT 25	Unbilled VAT <25>	

Setting Up The System For UK VAT and CCL

The following sections provide an overview of how to configure the system to apply UK VAT and CCL charges for non-domestic customers.

Bill Segment Freeze Installation Option

Select Freeze at Bill Completion as the bill segment freeze option. The system determines if de minimis applies at bill completion time and has to regenerate the bill segments as necessary.

Customer Class

Create a separate customer classes for non-domestic customers.

Service Agreements

You must configure the system so that each service agreement that must be checked for de minimis is only linked to service points at a single premise. The service agreement must reference that premise as its characteristic premise. Refer to [Application of De Minimis](#) for more information.

Bill Factors for UK VAT and CCL

- Standard Rate VAT

- Reduced Rate VAT
- VAT Declaration Percentage Threshold. Set up a separate bill factor for each service type as the thresholds differ based on service type.
- De Minimis Average Daily Amount Threshold. Set up a separate bill factor for each service type as the de minimis amounts differ based on service type.
- Climate Change Levy (CCL) Per Unit Price. Set up a separate bill factor for each service type as the CCL per unit prices differ based on service type.

Characteristic Type for De Minimis Amounts

Set up a characteristic type to use for the bill characteristic that indicates when de minimis applies. Define the type of characteristic value as a Foreign Key Value and specify a foreign key reference that points to the premise table. Specify this characteristic type as parameters to the algorithms that apply the de minimis rule and that apply VAT.

You need to define a characteristic type for every service type that is subject to the de minimis rule, as the de minimis limit may apply for one service type but not another on the same bill.

NOTE: A **De Minimis Premise** Characteristic Type is provided that may be used for a specific service type. For additional service types, additional characteristic types will need to be defined.

Distribution Code

Define the following distribution codes:

- Unbilled Prepaid Energy Related Charges
- Unbilled Prepaid VAT

These distribution codes are required as parameters to the algorithms to create the GL details for excess credit.

UOM / TOU / SQI

If using calculation rule-based rates, the calculation rule that calculates CCL requires the consumption that is subject to standard rate VAT as a service quantity.

Define the UOM / TOU / SQI used to store these service quantities.

Service Quantities

If using calculation rules-based rates, the algorithm that checks if the de minimis applies, requires a service quantity containing the total consumption. Unless you have registers that measure the total consumption independent of time of use or interval, you will need to set up a pre-processing calculation group with a calculation rule to aggregate the usage into one service quantity.

Algorithms for UK VAT and CCL

Add the following [algorithms](#):

- Apply De Minimis Rule. Define an algorithm for each service type for which de minimis should be checked. Plug the algorithm(s) in on the customer class for the Pre Bill Completion system event. Refer to the CPBC-DMCH algorithm type for more information about the base package algorithm.
- Create Excess Credit GL Details. Plug this algorithm in on the customer class for the FT Freeze system event. Refer to the CFTZ-VAT-GL algorithm type for more information about the base package algorithm.
- Highlight Effective Declarations for Account and Premise. Plug this algorithm in on the installation option for the Control Central Alert system event. Refer to the CCAL-DECL algorithm type for more information about the base package algorithm.

Calculation Rules to Charge VAT and CCL

Four additional calculation rules are required to charge for VAT and CCL on non-domestic rates:

- Calculate standard rate VAT
 - Calculation Rule Type= Apply VAT to Cross Referenced Charges
 - VAT Calculation Type = Standard Rate
 - Specify the De Minimis Characteristic Type
 - Specify Declaration Percentage Threshold Bill Factor
 - Specify Value Source. It is recommended that you use a value source of Bill Factor and reference the bill factor you set up for standard rate VAT.
 - Note that the calculation rule overrides description on bill
 - Cross-reference the calculation line category for energy related charges that are subject to VAT
- Calculate reduced rate VAT
 - Calculation Rule Type = Apply VAT to Cross Referenced Charges
 - VAT Calculation Type = Reduced Rate
 - Specify the De Minimis Characteristic Type
 - Specify Declaration Percentage Threshold Bill Factor
 - Specify Value Source. It is recommended that you use a value source of Bill Factor and reference the bill factor you set up for standard rate VAT.
 - Note that the calculation rule overrides description on bill
 - Cross-reference the calculation line category for energy related charges that are subject to VAT
- Calculate CCL and CCL Relief
 - Calculation Rule Type = Calculate Climate Change Levy and Relief Charges
 - UOM/TOU/SQI = the identifier of the service quantity that the prices applies to
 - Specify Value Source. It is recommended that you use a value source of Bill Factor and reference the bill factor you set up for standard rate VAT.
 - Note that the calculation rule overrides description on bill
- VAT on CCL
 - Calculation Rule Type = Apply To
 - Value type = Percentage
 - Specify Value Source. It is recommended that you use a value source of Bill Factor and reference the bill factor you set up for standard rate VAT.

- Cross-reference the calculation line category for the total CCL and CCL Relief related charges

Setting up the calculation rules as above produces separate lines for VAT on energy related charges and on CCL (i.e., lines will be created for standard rate VAT on energy related charges, reduced rate VAT on energy related charges, and standard rate VAT on CCL charges).

You can set up rates to calculate standard rate VAT on energy related charges and CCL together as follows:

- Calculate standard rate VAT charges
 - Calculation Rule Type = Apply VAT to Cross Referenced Charges
 - FCPO = Yes
 - VAT Calculation Type = Standard Rate
 - Specify the De Minimis Characteristic Type
 - Specify Declaration Percentage Threshold Bill Factor
 - Value Source = Value
 - Value = 100
 - Note that the calculation rule overrides description on bill
 - Cross-reference the calculation line category for energy related charges that are subject to VAT
- Calculate CCL and CCL Relief
 - Calculation Rule Type = Calculate Climate Change Levy and Relief Charges
 - UOM/TOU/SQI = the identifier of the service quantity that the prices applies to
 - Specify Value Source. It is recommended that you use a value source of Bill Factor and reference the bill factor you set up for standard rate VAT.
 - Note that the calculation rule overrides description on bill
- Calculate standard rate VAT
 - Calculation Rule Type = Apply To
 - Value type = Percentage
 - Specify Value Source. It is recommended that you use a value source of Bill Factor and reference the bill factor you set up for standard rate VAT.
 - Cross-reference the calculation line category for the total CCL and CCL Relief related charges
- Calculate reduced rate VAT:
 - Calculation Rule Type = Apply VAT to Cross Referenced Charges
 - VAT Calculation Type = Reduced Rate
 - Specify the De Minimis Characteristic Type
 - Specify Declaration Percentage Threshold Bill Factor
 - Specify Value Source. It is recommended that you use a value source of Bill Factor and reference the bill factor you set up for standard rate VAT.
 - Note that the calculation rule overrides description on bill
 - Cross-reference the calculation line category for energy related charges that are subject to VAT

Quotes

A quote allows you to show a customer how their bill segments will look if a given set of pricing terms is applied to a given amount of consumption. If the customer accepts a quote, one or more real service agreements are created.

FASTPATH:

Refer to [Defining Quotation Options](#) for how to setup the system to enable quotation functionality.

NOTE:

Separate module. Please note that the quoting functionality is part of the Contract Management module. If this module is not applicable to your business you may turn it off. Refer to [Turn Off A Function Module](#) for more information.

The topics in this section describe the quotation functionality.

The Big Picture Of Quotations

The topics in this section provide background information about a variety of quotation features and functions.

WARNING:

If you are not familiar with the concepts described under [Sales and Marketing](#), [Billing](#), [Rates](#) the quotation functionality will be difficult to understand.

Basic Quotation Concepts

The section describes basic quotation concepts.

A Quote Shows How Bill Segments Might Look

A quote shows how a customer's bill segments will look if a given set of pricing terms is applied to a given amount of consumption. The following example illustrates how a quote might look that provides a customer with two different options for their electric service. If the customer elects either option, a new service agreement would be created.

Quote Account: 1231231123 - ABC Supply

Quote Detail 1		Quote Detail 2	
SA Type: Electric	Rate: EQ-10	SA Type: Electric	Rate: AA-34
72 Market Street San Fran., CA		72 Market Street San Fran., CA	
Period: 1-Jan-00 - 31-Jan-00		Period: 1-Jan-00 - 31-Jan-00	
Descript.	Amount	Descript.	Amount
Usage < Cap	\$500	Hedge	\$400
Usage > Cap	\$100	> Hedge	\$201
Period: 1-Feb-00 - 28-Feb-00		Period: 1-Feb-00 - 28-Feb-00	
Descript.	Amount	Descript.	Amount
Usage < Cap	\$525	Hedge	\$625
Usage > Cap	\$111	> Hedge	\$1

Please note the following about a quote:

- A quote is related to an account.
- A quote can contain many quote details. A quote detail shows how bill segments will look if a given set of pricing terms (e.g., rates, riders, contract quantities, contract options, etc.) is applied to a given amount of consumption.
- A quote detail may contain many simulated bill segments. For example, a quote detail could show the customer what their monthly bills would be if a given set of pricing terms were used over the course of several months (where each month has different consumption levels and different prices).
- A quote may contain multiple quote details for the same service. For example, a quote can contain four different pricing options for the same service (where each option is shown using a separate quote detail). The customer can then compare them and choose the optimum option.
- A quote may contain quote details for multiple premises and multiple services at each premise. For example, a quote can contain quote details for electric and gas service at multiple premises.

Proposal Service Agreements Must Exist

You cannot create a quote unless its account has at least one proposal service agreement (SA). A proposal SA contains the pricing terms, legal terms, and template consumption used to generate the simulated bill segments that appear on a quote. It might be helpful to view a proposal SA as special type of service agreement that is ignored when a bill is produced for an account.

The topics in this section provide detailed information about proposal SAs.

Proposal SAs Contain Pricing Terms

The pricing terms (e.g., rates, contract quantities, riders, bill factor values, etc.) used to generate a quote detail's simulated bill segments reside on a special type of service agreement (SA) referred to as a "proposal SA". Proposal SAs are like real SAs in many respects. In fact, you can view and change a proposal SAs pricing terms using the same transaction used to maintain real service agreements (i.e., [service agreement maintenance](#)).

NOTE:

Quote details are rather empty. A quote detail doesn't contain the pricing terms or template consumption. Rather, a quote detail references a proposal SA and the proposal SA contains the pricing terms and template consumption.

Legal Terms and Conditions May Be Specified On Both Proposal And Real SAs

In addition to containing pricing terms, proposal SAs also contain the legal terms and conditions (T&Cs) that govern the proposal.

Proposal Service Agreement

SA Type: **Electric**

72 Market Street
San Fran., CA

Rate: **EQ-10**

Quantity Type	Value
Subscribed Demand	10
Hedge Percentage	15

Terms & Conditions

This quote requires a commitment of at least 6 months. Early cancellation results in a fee of 2 times the average bill amount.

This quote was calculated using historical market prices. The historical market prices should not be assumed to be the same in the future

Your master list of terms and conditions are defined when you setup your control tables. The system defaults a service agreement's T&Cs from the [start option](#) used to initially create it. You can change a SA's T&Cs at will.

NOTE:

Real SAs and proposal SAs can reference T&Cs. Both proposal and real SAs can reference T&Cs. The T&Cs on a proposal SA are those that will apply if the customer accepts the related quote detail. The T&Cs on a real SA are those that apply while the SA is active.

Proposal SAs Contain Billing Scenarios And Template Consumption

In addition to the pricing terms and the legal terms and conditions, a proposal SA also contains [billing scenarios](#). A billing scenario defines:

- The number of simulated bill segments that will be generated when a quote detail is produced for the proposal SA.
- The bill period of each simulated bill segment.
- The amount of consumption to be priced under each simulated bill segment. Note this statement is only true for non-interval consumption. *Note: Proposal SAs that use interval consumption are not supported in C2M. Load curves and TOU mapping are handled in Oracle Utilities Meter Data Management.*

A proposal SA's billing scenarios can be created as follows:

- A plug-in spot exists on SA type called Proposal SA Creation. Algorithms plugged into this spot can setup billing scenarios. Refer to [Enabling The Automatic Generation Of Billing Scenarios](#) for more information about how to do this.
- A user can add / change / delete billing scenarios on a proposal SA using [Service Agreement - Billing Scenario](#).

Proposal SAs Differ From Real SAs

A proposal SA is just like any other SA in that it contains the pricing terms that are used to generate how much the customer owes for service. In fact, the [service agreement maintenance transaction](#) is used to maintain both types of service agreements (however, you cannot use this transaction to create a proposal SA; proposal SAs can only be created using the [order transaction](#)).

However, there are differences between proposal SAs and real SAs:

- Billing ignores proposal SAs.
- Proposal SAs cannot have financial transactions.
- Proposal SAs are not subject to credit and collections.
- Proposal SAs do not appear on lists of "active" SAs in the system's various zones, grids and trees.
- Fieldwork is not performed for proposal SAs.
- A proposal SA's state transition is very different from a real SA. Refer to [The Lifecycle Of A Service Agreement](#) for an illustration of a real SAs state transition. Refer to [Proposal SA State Transition](#) for an illustration of a proposal SAs state transition.

Proposal SA State Transition

The following diagram shows the possible lifecycle of a proposal SA.

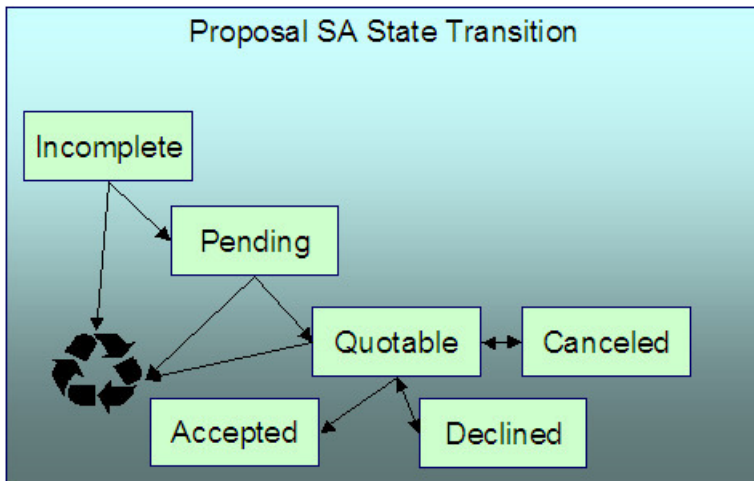

You should never see an Incomplete proposal SA as this is a transitory state used when a proposal is first initiated using the [Order](#) transaction. The system always transitions such proposal SAs to the Pending state. Please note that when a proposal SA becomes Pending, the system executes any Proposal SA Creation algorithms plugged in on the proposal SA's SA type. You might use such algorithms to generate billing scenarios or initiate a workflow process that requests template consumption from the prospect.

A proposal SA exists in the Pending state while you are working on the proposal. For example, you might want to leave the proposal SA in this state while you wait for the prospect to send you their historical consumption.

A proposal SA is Quotable when a quote detail can be generated for it (at least one billing scenario must be linked to the proposal SA before it can become Quotable). Note, proposal SAs can be modified when they are Quotable.

NOTE:

Automatically transitioning a proposal SA to the Quotable state when it's first created. As described earlier, you can setup a proposal SA creation algorithm to automatically create billing scenarios when a proposal SA is created. The base package algorithm can also automatically transition the proposal SA to the Quotable state (thus making it ready for quotation). Refer to [Enabling The Automatic Generation Of Billing Scenarios](#) for more information.

A proposal SA becomes Accepted when a customer accepts one of its quote details.

A proposal SA becomes Declined when a customer declines one of its quote details (or its quote expires). A Declined proposal SA can be "reopened" (by making it Quotable). You may need to do this if you want to change a proposal SA's terms in preparation of generating a new quote detail.

A proposal SA becomes Canceled when a quote detail is withdrawn (or its quote expires). You may need to do this if you want to change a proposal SA's terms in preparation of generating a new quote detail.

Incomplete, Pending and Quotable proposal SAs may be deleted.

Orders Are Used To Create Proposal SAs

Proposal SAs can only be created using the [order](#) transaction. This transaction allows a user to pose eligibility-oriented questions to a customer or prospect. The system determines which [packages](#) of goods and services for which they are eligible based on the answers to the questions. If the customer is interested in receiving a package, one or more SAs (real and/or proposal) are created using the [SAs To Create](#) information defined on the selected package.

NOTE:

You must setup campaigns and packages before you can create an order. If you are not familiar with the [order](#) transaction, you should take the time to form an intuitive understanding of the concepts described under [Sales & Marketing](#). With this knowledge in place, you can design and set up the campaigns and packages necessary to allow an order to create proposal SAs. Keep in mind that a single switch controls whether real SAs or a proposal SAs are created when a package is selected on the order transaction. This switch resides on [Package - SAs To Create](#).

A package could create a combination of real and proposal SAs. When a customer elects to take a package of goods and services (via the [order](#) transaction), the system creates a service agreement for each SA type / start options defined on the package's [SAs To Create](#). It is possible to setup a package to create both real and proposal SAs. For example, the customer may be calling you to start electric service, but they may also be interested in seeing a proposal for gas service.

You don't create special SA types for proposal SAs. The SA type on a proposal SA is the same as the SA type on the real SA that's created when the proposal SA is accepted. This is because the business rules on your SA types govern both real and proposal SAs.

You don't need special start options for proposal SAs. The start options that you setup to default information onto new, real service agreements are also referenced on the [SA To Create](#) information used to create proposal SAs.

Proposal SAs May Be Grouped Under An Umbrella Agreement

Each proposal SA may be part of a larger contract for multiple services that you are negotiating with a customer or group of customers. You may use an [umbrella agreement](#) and its collection of terms of service records to group together multiple proposal service agreements.

Creating Quotes And Quote Details

Once an account has quotable proposal SAs, you can generate a quote for the account using the quote maintenance transaction. When you generate a quote for an account, you can include quote details for any / all of the account's quotable proposal SAs.

The logic used to create a quote detail's simulated bill segments is not hard-coded. Rather, the system calls the algorithm plugged in on the proposal SA's [SA type](#) in the Proposal SA - Bill Segment Generation plug-in spot. Refer to [Enabling The Generation Of Simulated Bill Segments](#) for information about this plug-in spot.

The major difference between a bill segment linked to a quote detail and one linked to a bill is that a quote detail's bill segments are calculated using simulated consumption. This means that the financial information on quote details is not a guess - it's what the bill would be if a given amount of consumption was priced using the pricing terms (as long as you opt to use rate application to calculate the simulated bill segments).

In addition to this major difference, there are a few minor differences between a real bill segment and a simulated bill segment:

- A quote detail bill segment does not have a foreign key to a bill. Rather, it references a quote detail.
- A quote detail bill segment's prime key is inherited from its quote detail (rather than its bill).
- A quote detail bill segment can never have a financial transaction linked to it.
- A quote detail bill segment doesn't have read details.
- A quote detail bill segment's state transition is simpler (it's either in the Error state or OK).

Completing A Quote Creates Quote Routings (And More)

When a quote's quote details are all OK, you change the status of the quote to complete to indicate the quote is ready to be sent to the customer or prospect.

When a quote is completed, the system creates a [quote routing](#) for each person who receives a copy of the account's quotes. When you indicate a person should receive a copy of the account's quotes, you define the routing method (e.g., email, fax, post) and the appropriate address.

NOTE:

Recipients of quotes. You define who receives a copy of an account's quotes on the [Account - Persons](#) page. The system assumes (by default) that the main person linked to the account should receive the account's quotes. You can subsequently indicate any person linked to the account should receive its quotes (and turn off the creation of quotes for the main person). In addition, you can manually add additional quote routings to a quote if you need to send the quote to individuals not currently linked to the account. Refer to [How To Reprint A Quote](#) for more information.

The information that appears on the quote routing record is controlled by the [quote route type](#) specified on the respective account / person information:

- If the quote route type's routing method is email or fax and the system has been configured to use notification preferences for quote routing, a quote routing is created for each active contact preference whose notification type is associated with the **quote route type** specified on the respective account / person information. Refer to *Bill and Quote Routing in Designing Notification Types* for more information. Otherwise, quote routings are created as follows:
 - If the quote route type indicates the person's quotes are routed via fax, the person's fax number is used as the routing information. The system knows which of a person's person contacts is a fax number is by the contact routing or which of a person's phone numbers is a fax number by the phone type.

- If the quote route type indicates the person's quotes are routed via email, the person's [Email address](#) is used as the routing information. The system knows which of a person's person contacts is an email or knows where to find the person email.
- If the quote route type indicates the person's quotes are routed via the postal service, the address constituents are populated with the address specified on the **bill** address source that is also specified on the [account / person information](#). Note, if the person has a [seasonal address](#) effective on the business date, the seasonal address will be used regardless of the value of **bill address source**.

Regardless of whether the quote is routed via fax, email or post; the routing record is also stamped with the batch process and run number that performs the download of the quote information. The batch process is defined on the quote route type. Refer to [Printing Quotes](#) for more information about this batch process.

In addition to creating routing information at completion time, the system executes any quote completion algorithms plugged in on the account's customer class. For example, you may want to create a workflow process to manage the processing of the quote. To do this, you plug in a Quote Completion Algorithm that creates a workflow process on the respective [customer class](#).

Accepting / Declining Quote Details

A customer can accept or decline each quote detail on a quote.

When a quote detail is accepted, the system:

- Changes the state of the related proposal SA to accepted.
- Executes the Proposal SA - Acceptance algorithms plugged in on the proposal SA's SA type. The base package algorithm creates a real SA by copying the information from the proposal SA. The real SA is created in the pending start state. This new SA behaves similarly to a pending start SA that's created via the [Order](#) or [Start/Stop](#) transactions (e.g., field activities are initiated if the SA type has been setup accordingly).

When a quote detail is declined, the user must supply a decline reason. The system then changes the state of the related proposal SA to declined.

FASTPATH:

Refer to [Proposal SA State Transition](#) for more information about a proposal SA's states.

NOTE:

Reopening a declined proposal SA. If a customer changes their mind about a declined proposal SA, you can return it to the quotable state using the [service agreement maintenance transaction](#).

Rejecting an entire quote. If all details on a quote are being declined, you can simply change the state of the quote to closed rather than reject each quote detail. Refer to [Closing Quotes](#) for more information.

Tinkering With Proposal SAs After Quote Generation

The system allows a quotable proposal SA to be changed, EVEN IF QUOTE DETAILS HAVE BEEN GENERATED. This is intentional as otherwise you would have to create an entirely new proposal SA if you wanted to send another quote for slightly different terms. Your technical team could always introduce a user exit to prevent this from happening if you really didn't want this to take place.

Because the system allows this, a potential issue is that the customer may end up accepting a proposal SA that differs from the terms on their quote (e.g., you could change the SA after the quote detail is generated). For this reason, we snapshot the

version number of the proposal SA on the quote detail at the time it's generated. If a proposal SA is accepted and its version number differs from the value on its quote details, a warning is produced.

A warning is also issued if you change a proposal SA and a quote detail exists (reminding you to generate a new quote / quote detail).

In addition to the above, it's also important to understand that the system intentionally allows multiple quotes to reference a given proposal SA. This allows you to leave multiple quotes open that reference the same proposal SA(s).

Closing Quotes

Every quote has an expiration date. The [CLOSEQTE](#) background process closes quotes on their expiration date. This process changes the state of all related proposal SAs to canceled or declined (an input parameter of this process controls which state is used).

You can also close a quote real time using the quote maintenance transaction. When you do this, the system asks if the related proposal SAs should be left as quotable or if they should be changed to canceled or declined.

NOTE:

Reopening a declined proposal SA. If a customer changes their mind about a declined proposal SA, you can return it to the quotable state using the [service agreement maintenance transaction](#).

Alerts

The [alert zone](#) highlights if:

- The selected account has pending or complete quotes. Refer to [Quote Lifecycle](#) for more information.
- The selected account has pending or quotable proposal SAs. Refer to [Proposal SA State Transition](#) for more information.

Trees

The [account tree](#) highlights:

- The existence of non-closed quotes
- The existence of proposal SAs and their related quote details

Printing Quotes

The contents of this section describe the technical implementation of printing quotes.

Quote Routings Are Created For Each Recipient Of A Quote

Refer to [Completing A Quote Creates Quote Routings](#) for a description of how the system constructs the information used to route a quote to one or more recipients.

Quote Route Types Control The Information Merged Onto Quotes

Every quote routing references a [quote route type](#).

The quote route type controls the following quote functions:

- It contains an algorithm that is responsible for extracting the information merged onto your quotes. Specifically, algorithms of this type create the "flat file records" that are passed to your quote-print software. Algorithms of this type are called under the following scenarios:
 - The background process that builds the flat file that's passed to your quote-print software calls these algorithms to construct the "flat file records" for each quote. Refer to [Technical Implementation of Printing Quotes In Batch](#) for the details.
 - If your quote-print software has the ability to construct a real-time image of a quote (in a PDF), you can plug in an Online Quote Display algorithm on the [Installation Record](#). This type of algorithm calls the quote's dispatch group extract algorithm to extract the information that is merged onto the quote. Refer to [Technical Implementation Of Online Quote Display](#) for the details.
- Refer to [The Quote Extract Records](#) for examples of the record layouts passed to the document composition application.
- It contains the ID of the background process that builds the flat file that's passed to your quote-print software. The base package example of this background process ([QUOTROUT](#)) simply calls the extract algorithm on the routing record's route type to format the information placed onto the flat file.

NOTE: CIS Division can override the extract algorithm and/or the background process found on the quote route type. The system processes first check the quote's account's CIS Division for an override specific for the quote route type.

Technical Implementation Of Online Quote Display

Users can view an image of any quote if you set up the following:

- Plug in an Online Quote Display construction algorithm on the [Installation Record](#). Refer to ONQD-DOC1 for an example of such an algorithm. Note if your quote-print software is not capable of producing a PDF containing an image of a quote, users will not be able to view images of quotes.
- Plug in the appropriate extract algorithm on each [quote route type](#). Algorithms of this type format the records that contain the information that is passed to your printing software. Refer to QTEX-EX for an example of such an algorithm.

When you plug in these algorithms, a button appears on [Quote - Main](#). When a user clicks this button, the following takes place:

- The installation record's Online Quote Display algorithm is executed.
- This algorithm calls the quote's route type's extract algorithm. This algorithm constructs the information that's merged onto the quote and returns it to the Online Quote Display algorithm. This algorithm, in turn, passes it to the quote-print software.
- The quote-print software renders an image of the quote in a PDF and returns it to the Online Quote Display algorithm.
- And finally, the Online Quote Display algorithm displays the PDF in a browser session. Note that the client must have Adobe Acrobat Reader installed to view PDF files.

Technical Implementation Of Printing Quotes In Batch

The batch process that extracts quote information reads all quote routing records in a given run number that are marked with its batch control ID. For each quote routing record, it creates numerous records on a flat file. These records contain the information that is merged onto your quotes.

The base package example of this process ([QUOTROUT](#)) simply calls the extract algorithm on the routing record's route type to format the information placed onto the flat file. Refer to [Quote Route Types Control The Information On Quotes](#) for more information.

NOTE:

If your software doesn't support online quote display. The algorithm that formats quote extract records that's plugged in on [quote route type](#) serves two purposes: 1) it formats the records used to construct online images of a quote, and 2) it formats the records downloaded to your quote print software in batch. If your quote printing software does not support the rendering of quote images real time, there is no need to create an extract algorithm. Rather, you should simply develop your own download process that both formats the extract records and downloads them (and then specify this batch process on your quote route type).

Reproducing The Quote Print Flat File

You can reproduce the flat file at any time. Simply request the quote production background process and specify the run number associated with the historic run.

How To Reprint A Quote (For The Original Recipients or For Someone New)

A copy of a quote is sent to every individual / business specified in the [quote's routing details](#). The system creates the routing details when a quote is completed. Refer to [Completing A Quote Creates Quote Routings](#) for more information about how this information is compiled during quote completion.

If you want to reprint a quote OR if you want to send a quote to someone other than the original recipients:

- Navigate to the [Quote - Main](#) page.
- Transfer to the [Quote - Quote Routings](#) tab.
- Insert a new row (click the + button). Note that you can only insert information on a quote that is Complete.
- Specify the name and address to which the quote should be sent. If you want to send the quote to someone other than the original recipient, specify the individual's name and address.
- Save the quote.

If a quote is Complete but the print process hasn't yet executed, you may change the name and address on the original routing details; you don't have to insert a new routing row.

The Quote Extract Records

Numerous different types of records are interfaced to the document composition application. However, they all share a common structure:

- The first 4 bytes are called the **Printer Key**. This field is a record type used by the document composition application quote template.
- The next X bytes are called the **Sort Key**. This field is used to ensure the various records used to construct a printed quote appear in the correct order in the interface file.

- The next 12 bytes are called the **Mailing Key**. This field is used to control the order in which the formatted quotes are printed.
- The remaining bytes contain the **QuoteInformation** that appears on the printed quote. The type of information differs for each type of record.

The topics in this section describe each component.

Printer Key (Record Types)

The following table defines each printer key (i.e., record type) on the quote print flat file.

Record Type	Description	Notes
0010	Global extract information	Required. 1 per flat file
0100	Quote record	Required. 1 per Quote.
0200	Quote Detail record	1 per quote detail.
0300	Terms and Conditions record	1 per terms and conditions linked to the proposal SA.
0400	Bill segment record	1 per bill segment linked to the quote detail.
0500	Bill calculation header	1 per bill calculation header linked to the bill segment.
0600	Bill calculation line	1 per bill calculation line linked to the bill calculation header.
0700	End of record type 0500	1 for each bill calculation header
0800	Read detail	1 for each meter read detail linked to the bill segment.
0900	SQ detail	1 for each service quantity detail linked to the bill segment.
1000	End of record type 0400	1 for each bill segment.
1100	End of record type 0200	1 for each quote detail.
9999	End of record type 0100	1 for each quote.

Sort Key

The following table defines the structure of the sort key that appears on each quote print record. Please note that different components are filled in for each printer key.

Field Name	Format	Source/Value/Description
Quote ID	A12	
Sequence Number	N2	The sequence number of the account / person information associated with this quote routing information.
Quote record group	A2	10 Quote 20 Quote Detail

		30 Quote end
Quote Detail ID	A12	
Quote Detail record group	A2	10 Quote Detail record 20 SA Terms and Conditions 30 Bill Segment 40 Quote Detail record end
SA T&C Short Description	A60	
Bill Segment End Date	A10	
Bill Segment Id	A12	
Bill Segment Group	A2	10 Bill segment 20 Bill segment calculation group 30 Bill segment read detail 40 Bill segment SQ detail 50 Bill segment end
Bill Calc Header Sequence	N2	
Bill Calc Header Group	A2	10 Bill calculation header 20 Bill calculation line 30 Bill calculation end
Line Seq	N4	Defines order of rows for similar record types

Mailing Key

The following table defines the structure of the mailing key that appears on each quote print record.

Field Name	Format	Source/Value/Description
Postal code	A12	This is the postal code on the quote routing record.

Quote Information

The topics in this section describe the information that appears on each on each quote print record. The following links are provided so that you can move easily to specific topic within this section:

- [Global Extract Information \(0010\) Record Definition](#)
- [Quote \(0100\) Record Definition](#)
- [Quote Detail \(0200\) Record Definition](#)
- [SA Terms and Conditions \(0300\) Record Definition](#)
- [Bill Segment \(0400\) Record Definition](#)
- [Bill Calculation Header \(0500\) Record Definition](#)
- [Bill Calculation Line \(0600\) Record Definition](#)

- [End of Bill Calculation Header \(0700\) Record Definition](#)
- [Bill Segment Read \(0800\) Record Definition](#)
- [Bill Segment SQ \(0900\) Record Definition](#)
- [End of Bill Segment \(1000\) Record Definition](#)
- [End of Quote Detail \(1100\) Record Definition](#)
- [End of Quote \(9999\) Record Definition](#)
- [Address Sub-Record Definition](#)

Global Extract Information (0010) Record Definition

This is a "header" record that contains information about the extract run as a whole.

NOTE:

Please be aware that if you do not sort your extract file by **CIS Sort Key** after it is produced, this record will physically be the last record on the extract file.

Field Name	Format	Source/Value/Description
BATCH_CD	A8	Batch Control Code of the extract process.
BATCH_NBR	N10	Batch Number of the extract process
BATCH_RERUN_NBR	N10	Batch Rerun number of the extract process.
QTE_CNT	N10	Count of quotes on this extract.
EXTRACT_DTTM	A26	System time of extraction.
QUOTE_ID_START	A12	This is only used when a quote is produced as a result of an online request (from Quote - Main). It contains the Quote Id to extract.
QUOTE_ID_END	A12	This is only used when a quote is produced as a result of an online request (from Quote - Main). It contains the Quote Id to extract.
THREAD_NBR	N10	This field is only used if quotes are extracted in batch. It contains the thread number in which the quote was extracted.
THREAD_CNT	N10	This field is only used if quotes are extracted in batch. It contains the total number of threads that were extracted.

[Top of Page](#)

Quote (0100) Record Definition

Field Name	Format	Source/Value/Description
QUOTE_ID	A12	CI_QUOTE
ACCT_ID	A10	CI_QUOTE
EXPIRE_DTTM	A26	CI_QUOTE
QUOTE_STAT_FLG	A2	CI_QUOTE
CURRENCY_CD	A3	CI_ACCT
CUR_SYMBOL	A4	CI_CURRENCY_CD

ENTITY_NAME1	A64	CI_QUOTE_RTG. Mailing Entity Name1.
ENTITY_NAME2	A64	CI_QUOTE_RTG. Mailing Entity Name2.
ENTITY_NAME3	A64	CI_QUOTE_RTG. Mailing Entity Name3.
ADDRESS_SBR	A361	CI_QUOTE_RTG. Refer to its components in a later section.
EMAILID	A254	CI_QUOTE_RTG
PHONE-FAX	A64	CI_QUOTE_RTG

[Top of Page](#)

Quote Detail (0200) Record Definition

Field Name	Format	Source/Value/Description
QUOTE_DTL_ID	A12	CI_QUOTE_DTL
SA_ID	A10	CI_QUOTE_DTL
TOTAL_AMT	N13.2	CI_BSEG_CALC. Sum of all calculation amounts (quote detail's bill segments).
PREMISE_ID	A10	CI_SA (Characteristic Premise)
ADDRESS_SBR	A361	CI_PREM. Refer to its components in a later section.
SA_TYPE_DESCR	A60	CI_SA_TYPE_L
SVC_TYPE_CD	A30	CI_SVC_TYPE_L
SA_VERSION	N5	CI_QUOTE_DTL
QTE_DTL_SA_VERSION	N5	CI_QUOTE_DTL
RS_DESCR	A60	CI_RS_L. Description of Rate effective on SA start date.

[Top of Page](#)

SA Terms and Conditions (0300) Record Definition

Field Name	Format	Source/Value/Description
START_DT	A10	CI_SA_TC
END_DT	A10	CI_SA_TC
TC_TYPE_CD	A12	CI_TC
DESCR	A60	CI_TC_L
TC_TYPE_TXT	A2000	CI_TC_L

[Top of Page](#)

Bill Segment (0400) Record Definition

Field Name	Format	Source/Value/Description
START_DT	A10	CI_BSEG
END_DT	A10	CI_BSEG
BSEG_STAT_FLG	A2	CI_BSEG

BSEG_AMT

S13.2

CI_BSEG_CALC_LN

[Top of Page](#)

Bill Calculation Header (0500) Record Definition

Field Name	Format	Source/Value/Description
START_DT	A10	CI_BSEG_CALC
END_DT	A10	CI_BSEG_CALC
RS_CD	A8	CI_BSEG_CALC
CALC_AMT	S13.2	CI_BSEG_CALC
DESCR_ON_BILL	A254	CI_BSEG_CALC

[Top of Page](#)

Bill Calculation Line (0600) Record Definition

Field Name	Format	Source/Value/Description
APP_IN_SUMM_SW	A1	CI_BSEG_CALC_LN
CALC_AMT	S13.2	CI_BSEG_CALC_LN
EXEMPT_AMT	S13.2	CI_BSEG_CALC_LN
UOM_CD	A30	CI_BSEG_CALC_LN
TOU_CD	A30	CI_BSEG_CALC_LN
SQI_CD	A30	CI_BSEG_CALC_LN
BILL_SQ	S12.6	CI_BSEG_CALC_LN
DESCR_ON_BILL	A254	CI_BSEG_CALC_LN

[Top of Page](#)

End of Bill Calculation Header (0700) Record Definition

Field Name	Format	Source/Value/Description
Dummy field		

[Top of Page](#)

Bill Segment Read (0800) Record Definition

NOTE: The Bill Segment Read (0800) Record is not applicable for Customer to Meter (C2M). A quote detail bill segment doesn't have read details.

[Top of Page](#)

Bill Segment SQ (0900) Record Definition

Field Name	Format	Source/Value/Description
UOM_CD	A30	CI_BSEG_SQ
TOU_CD	A30	CI_BSEG_SQ
SQI_CD	A30	CI_BSEG_SQ

SQ_DEC_POS	N1	CI_BSEG_SQ
BILL_SQ	S12.6	CI_BSEG_SQ

[Top of Page](#)

End of Bill Segment (1000) Record Definition

Field Name	Format	Source/Value/Description
Dummy field		

[Top of Page](#)

End of Quote Detail (1100) Record Definition

Field Name	Format	Source/Value/Description
Dummy field		

[Top of Page](#)

End of Quote (9999) Record Definition

Field Name	Format	Source/Value/Description
Dummy field		

[Top of Page](#)

Address Sub-Record Definition

The address that appears in both the quote record (0100) and the quote detail record (0200) is composed of the following:

Field Name	Format	Description
COUNTRY	A3	
ADDRESS1	A64	Refer to Completing A Quote Creates Quote Routings for a description of conditions when this field will contain a fax number or an Email address rather than the first line of a postal address (this only occurs for a bill record (0100)).
ADDRESS2	A64	
ADDRESS3	A64	
ADDRESS4	A64	
CITY	A30	
NUM1	A6	
NUM2	A4	
HOUSE_TYPE	A2	
COUNTY	A30	
STATE	A6	
POSTAL	A12	
GEO_CODE	A11	

[Top of Page](#)

Maintaining Quotes

A quote allows you to show a customer how their bill segments will look if a given set of pricing terms is applied to a given amount of consumption. If the customer accepts the quote, real service agreements are created.

FASTPATH:

Refer to [The Big Picture Of Quotations](#) for background information about quotes.

The topics in this section describe how to maintain quotes.

The Lifecycle Of A Quote And Quote Detail

The topics in this section describe the lifecycle of the various quote objects.

Quote Lifecycle

The following diagram shows the possible lifecycle of a quote.

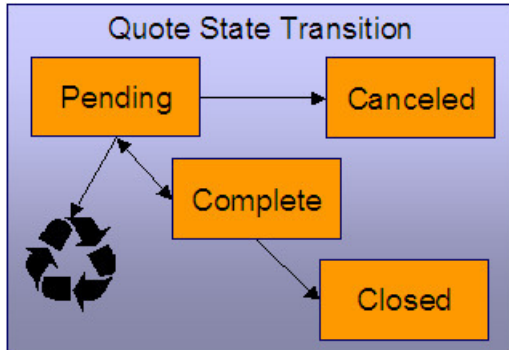

Pending A quote starts its life in the Pending state. Refer to [Creating Quotes And Quote Details](#) for more information.

A quote remains Pending until you Cancel or Complete it.

You may delete a Pending quote. Deleting a pending quote also deletes its quote details.

Canceled You cancel a quote if you want a record of a Pending quote that was never sent to a customer.

Complete A quote becomes Complete when it is ready to be sent to a customer. No changes may be made to a Complete quote. Refer to [Completing A Quote](#) for a description of what happens when a quote is completed.

A Complete quote may be reopened. You would only do this if you need to prevent blatant errors from being sent to the customer. For example, if you notice an incorrect quote detail, you could reopen the quote, regenerate or delete the erroneous quote details, and then recomplete the quote.

Closed A Complete quote becomes Closed when its terms are no longer valid. Refer to [Closing Quotes](#) for more information.

Quote Detail Lifecycle

The following diagram shows the possible lifecycle of a quote detail.

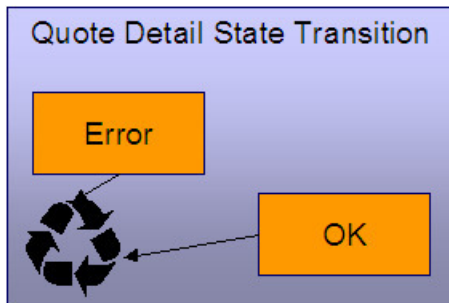

When a quote detail is generated, it is placed in the Error or Ok state depending on whether the system successfully generated simulated bill segments for each billing scenario linked to the related proposal SA. A quote detail may be deleted if its parent quote is Pending. Refer to [Creating Quotes And Quote Details](#) for more information.

Quote - Main

This page is used to maintain quotes. This page provides many diverse functions:

- You can [generate](#), [complete](#), [close](#), reopen, and cancel a quote.
- You can regenerate and delete quote details.
- You can [accept](#), [decline](#) and cancel the proposal SAs that contribute a quote detail to the quote.

You should not attempt to use this transaction until you are comfortable with the concepts described under [The Big Picture of Quotations](#).

Open this page using **Menu > Sales & Marketing > Quote > Search**.

Description of Page

Quote Info contains a concatenation of important information about the quote (e.g., its expiration date and status). **Quote ID** is the system-assigned unique identifier of the quote. These values only appear after the quote is added to the database.

Account ID identifies the customer or prospect associated with the quote. The name of the account's main customer appears adjacent.

Quote Status contains the state of the quote. Refer to [Quote Lifecycle](#) for information about the valid values and the state transition rules.

If your system has been configured to display an online image of a quote, a **Display Quote** button appears adjacent to the quote's status. When clicked, an online image of the quote is displayed. Refer to [Technical Implementation Of Online Quote Production](#) for how to enable this feature.

Expiration Date / Time identifies when the quote's terms are no longer valid. Refer to [Closing Quotes](#) for how the system uses this information to automatically close a quote.

Refer to [Quote Actions](#) for a description of each **Quote Action** button.

This transaction has sophisticated logic that can be used to perform mass updates to the quote's quote details and their related proposal SAs. These mass update actions are executed by selecting quoted details (in the grid) and then clicking the desired action button at the bottom the page. The remainder of this section describes how to use this mass update functionality.

The **Select All** / **Clear All** buttons are used to select / unselect the quote details. These buttons are disabled when the quote is Closed.

NOTE:

100 quote details at a time. Clicking **Select All** selects the first 100 quote details in the grid. If more than 100 quote details exist, you must select them in batches.

The grid that follows contains the quote details linked to the quote. The following information appears in the grid:

- **Select box.** Before you can perform any of the mass update actions at the bottom of the page, at least one quote detail must be selected. This field is disabled when the quote is Closed. You can use the **Select All** and **Clear All** buttons to change the value of the switch for all quote details in the grid.
- **Click the go to button** to transfer to the [Quote - Quote Detail](#) tab with the corresponding quote detail positioned in the scroll. On this page, you can see the details of the quote detail's simulated bill segments (and, from there, drill down into the details of each bill segment).
- The **Quote Detail Info** column contains a concatenation of a quote detail's division, SA type, start option, status, start date, and premise information (this information comes from the quote detail's proposal SA).
- The **Total Amount** column contains the sum of the quote detail's simulated bill segments.
- The **Remarks** column highlights special circumstances associated with the quote detail.
 - Proposal SA has been changed since the quote was created appears if the proposal SA was modified after the quote detail was generated. If you'd like to recalculate this quote detail, select this row and click the **Regenerate** button at the bottom of the page to regenerate the quote detail's simulated bill segments.
 - Quote detail contains bill segments in error appears if any of the simulated bill segments linked to the quote detail are in error. Click the adjacent go to button to transfer to the [Quote - Quote Detail](#) tab where the state of each simulated bill segment is shown. You can correct simulated bill segments that are in error by **Regenerating** the quote detail (and you do this by selecting the quote detail and clicking the Regenerate button at the bottom of the page).

The **Quote Detail Actions** and **Proposal SA Actions** can be used to perform mass updates to the selected quote details in the grid. Refer to [Quote Detail Actions](#) and [Proposal SA Actions](#) for the details.

Action Buttons On Quote Main

The topics in this section describe the various action buttons on the [Quote - Main](#) page.

Quote Actions

The topics in this section describe the **Quote Action** buttons on the [Quote - Main](#) page. The following links are provided so that you can move easily to specific topic within this section:

- [Generate](#)
- [Complete](#)
- [Close](#)
- [Reopen](#)
- [Cancel \(Quote\)](#)

Generate

The **Generate** button causes one or more quote details to be created for the account's Quotable proposal SAs. This button is enabled when there is at least one Quotable proposal SA linked to the selected **Account ID**.

When clicked, the **Generate Quote** window opens.

You must specify the following parameters to generate quote details:

- Indicate if quote details should be created for All Proposal SAs or for a Specific Proposal SA.
- If you indicated a quote detail should be generated for a Specific Proposal SA, also specify the **Proposal SA ID**.

After specifying the parameters, click **Generate** to create the quote details for quotable proposal SAs.

FASTPATH:

Refer to [Creating Quotes And Quote Details](#) for more information.

WARNING:

If the quote has existing quote details for the designated proposal SAs, they are deleted when you generate quote details (i.e., the system regenerates existing quote details). You can also regenerate quote details by selecting them on the Main page and clicking the **Regenerate** button.

[Top of Page](#)

Complete

The **Complete** button causes the quote to become complete. This button is enabled when the quote is pending and all quote details linked to the quote are OK.

FASTPATH:

Refer to [Completing A Quote Creates Quote Routings](#) for a description of what happens during quote completion.

[Top of Page](#)

Close

A quote is closed when its terms are no longer valid (i.e., when the related proposal SAs can no longer be accepted). Most quotes are closed automatically by the system (refer to [Closing Quotes](#) for how this takes place).

If you want to close a quote real time, click the **Close** button. When this button is clicked, the system opens the **Close Quote** window and asks if anything should be done with the related proposal SAs.

In the resulting window, you must specify one of the following **Proposal SA Actions**:

- Choose No Action if you don't want to change the status of the related proposal SAs.
- Choose Decline if you want the status of the proposal SAs that have contributed quote details to the quote to be changed to declined . You must also define a **Decline Reason**.
- Choose Cancel if you want the status of the proposal SAs that have contributed quote details to the quote to be changed to canceled .

[Top of Page](#)

Reopen

The **Reopen** button causes a quote to return to the pending state. You would only reopen a quote if you need to prevent blatant errors from being sent to the customer. For example, if you notice an incorrect quote detail, you could reopen the quote, regenerate or delete the erroneous quote detail, and then recomplete the quote.

This button is enabled if the quote is complete.

[Top of Page](#)

Cancel (Quote)

The **Cancel** button causes the quote to become canceled. You would cancel a quote if you want a record of a pending quote that was never sent to a customer. This button is enabled when the quote is pending.

Canceling the quote does NOT cancel the related proposal SAs. If you want to cancel the related proposal SAs, you have the following options:

- You can click the [Close](#) button rather than the **Cancel** button. When you close a quote, you are given the option of also canceling the proposal SAs that contributed a quote detail to the quote.
- Before canceling the quote, you can select the quote details and click the [Cancel](#) button at the bottom of the page (in the Proposal SA Actions section). When you click this button, the system cancels the proposal SAs linked to the quote details.
- You can transfer to the [Quote - Quote Details](#) tab and then drill down to the each proposal SA (using the SA context menu button). This transfers you to [Service Agreement - Main](#) where you can cancel the proposal SA.

Quote Detail Actions

The topics in this section describe the **Quote Detail Action** buttons on the [Quote - Main](#) page. These buttons are used to perform a given action to the quote details that are selected in the quote details grid.

- The **Regenerate** button is used to delete and recreate the selected quote details. This button is enabled if the quote is pending and at least one row in the quote details grid is selected.
- The **Delete** button is used to delete the selected quote details. This button is enabled if the quote is pending and at least one row in the quote details grid is selected.

Proposal SA Actions

The topics in this section describe the various **Proposal SA Action** buttons on the [Quote - Main](#) page. These buttons are used to perform a given action to the proposal SAs associated with the selected quote details.

The **Accept** button is used to accept the proposal SA associated with the quote detail. This button is enabled if the quote is pending or complete and at least one row in the quote details grid is selected.

When you accept a proposal SA, you are asked to supply the **Start Date** of the real service agreement that will be created.

Refer to [Accepting / Declining Quote Details](#) for more information about how accepting a quote detail causes a real service agreement to be created.

Decline

The **Decline** button is used to decline the proposal SA associated with the quote detail. This button is enabled if the quote is pending or complete and at least one row in the quote details grid is selected. When you decline a proposal SA, you are asked to supply a **Decline Reason**.

Refer to [Accepting / Declining Quote Details](#) for more information about declining a quote detail.

Cancel

The **Cancel** button is used to cancel the proposal SA associated with the quote detail. This button is enabled if the quote is pending or complete and at least one row in the quote details grid is selected.

Quote - Quote Details

This page is used to view a summary of the simulated bill segments linked to a quote detail.

Open this page using **Menu > Sales & Marketing > Quote > Search** and navigate to the **Quote Details** page to define this information. You can also display a quote detail by clicking the respective go to button in the quote details grid on the main tab.

Description of Page

Quote Info contains a concatenation of important information about the quote (e.g., its expiration date and status). **Quote ID** is the system-assigned unique identifier of the quote. These values only appear after the quote is added to the database.

The **Quote Details** scroll contains one entry for every quote detail linked to the quote (a summary of these quote details also appears on the Main tab). The remainder of this section describes the information displayed for each quote detail.

NOTE:

You don't have to use the scroll. If the quote has many quote details, you don't have to use the scroll to work through them. Rather, you can use the go to button in the quote details grid on the main tab to position the respective quote detail in the following scroll. Also note, you can use Alt - and Alt + to scroll to the next and previous quote details in the scroll.

You cannot maintain quote details on this page. All maintenance functions (generate, delete, accept, decline and cancel) are performed on the **Main** tab.

Premise Info is the address of the main premise associated with the service agreement (as defined on the service agreement's characteristic premise). It's important to note that the service agreement may cover service at multiple premises, but only one may be defined as the main premise.

Quote Detail ID is the system-assigned unique identifier of the quote detail.

SA Info is a concatenation of the proposal SA's division, SA type, start option (if any), status and start date.

SA Version is a snapshot of the proposal SA's version number at the time the quote detail was generated. This information is used by the system to detect if the proposal SA was modified after the quote detail was created.

Total Amount is the sum of the quote detail's simulated bill segments.

Create Date / Time is the date and time the quote detail was generated.

Remarks highlight special circumstances associated with the quote detail. Please see the description of this field on the main tab for more information.

The grid contains a row for each simulated bill segment linked to the quote detail. The following information appears in the grid:

- The first go to button transfers you to the [bill segment page](#) where the details of the simulated bill segment are shown.
- **Bill Segment Period** defines the start and end dates of the simulated bill segment.
- **Amount** contains the amount of the bill segment.
- **Remarks** highlight special circumstances associated with the bill segment.
- **Billing Scenario ID** allows you to go to the proposal [SA's billing scenario](#) where you can tinker with consumption and the bill segment period used to generate this bill segment. Refer to [Proposal SAs Contain Billing Scenarios](#) for more information.

Quote - Quote Routings

This page is used to view the recipients of a quote. Refer to [Printing Quotes](#) for a discussion of how this information is used to produce quote images.

This page is also used to request a new copy of a quote.

NOTE:

No routing information until completion. A quote has no routing information until it is complete. At [completion time](#), the system creates a routing detail for every person linked to the account that receives a copy of its quotes. Refer to [Printing Quotes](#) for more information about how this information is constructed.

Use **Menu > Sales & Marketing > Quote > Search** and navigate to the **Quote Routings** page.

Description of Page

Quote Info contains a concatenation of important information about the quote (e.g., its expiration date and status). **Quote ID** is the system-assigned unique identifier of the quote. These values only appear after the quote is added to the database.

The **Quote Routing Information** scroll contains an entry for each recipient of the quote. This information is disabled after the quote has been routed to the recipient. The remainder of this discussion describes the fields that can be defined for each recipient of the quote.

Person ID identifies the person who was originally associated with the routing record. You may change the **Person ID** to any person in the system as this information is only used to default the recipient's name and address information, below.

The **Quote Routing Parameters** area contains information explaining how and when the quote is routed to the recipient. This information is gray when the quote routing information has been extracted or if a quote is reopened:

- **Quote Route Type** is the method used to transmit the quote to the customer. This information defaults from [Account - Person Information](#).
- **Batch Control** is the identifier of the batch of quotes in which the recipient's copy was downloaded. Embedded in this identifier is the batch control ID and the batch number. Note, this batch process is defined on the Quote Route Type or CIS Division.
- **Sequence** is the system-assigned identifier assigned to this quote routing.
- Turn on **Do Not Extract** if the quote should not be routed to the individual for whatever reason.
- **Reprint** is checked if an operator created this routing. This switch is populated by the system and is always protected.
- **Extract Date/Time** is the date and time the quote was downloaded. This information only appears after the download has commenced.

The **Mailing Address Information** area contains the recipient's name and address.

- If the recipient has an [override mailing name](#), **Name1**, **Name2** and **Name3** contain the person's override mailing name. Otherwise, **Name1** contains the recipient's primary name (this name might also include a prefix or suffix if the related [Account - Person](#) relationship has these fields defined).
- The remaining fields are the recipient's address. Refer to [Completing A Quote Creates Quote Routings \(And More\)](#) for information about how the system constructs the recipient's address
- If the recipient's address is a mailing address (as opposed to fax or email), the **Country** associated with the address controls the fields that appear in the address. Refer to [Defining Countries](#) for more information on the address constituents.
- If a user manually adds a routing record, the mailing address information defaults from the information on the current routing record.
- If a user specifies a **Person ID** that is linked to the quote's account, the **Quote Route Type** defined for this person on the account is defaulted.
- If a user specifies a **Person ID** that is not linked to the quote's account, the **Quote Route Type** on the [installation record](#) is defaulted. Note, if the quote route indicates the quote is routed via the postal service, the system will only be able to default the person's address if the person has an override mailing address on their [correspondence information](#).
- If the user changes the **Quote Route Type** after the initial default, the system populates the address information as described above.

Service Credits

"Service credits" is a term used to describe a special program designed to reward a customer for service along with benefits related to such a program. For each program that a customer participates in, there is a service credit membership record. Service credit events are used to record the "points" earned and redeemed for the membership. The topics in this section provide further details related to the service credit functionality.

FASTPATH:

For information about designing and setting up your control tables for configuring service credit functionality, refer to [Designing Your Service Credit Options](#).

NOTE:

Service credits are optional. Service credits may not be set up in your system; they are only used if your company offers rewards programs to customers.

Penalty Points. The service credits functionality is described in the documentation with the assumption that it is used for accumulating points to reward your customers. However, if your company has a business need to record penalty points for a customer, the service credits functionality may be used for that purpose as well.

The Big Picture Of Service Credit Membership

If a customer is participating in a rewards program, the customer has a service credit membership. The topics in this section provide background information about a variety of service credit membership features and functions.

Who are the Members?

Each membership has one or more "members". The members are defined by the accounts linked to the membership and by the financially responsible person(s) linked to each account.

A typical membership is linked to only one account. However, in some cases more than one account is linked to the membership. For example, a customer may have one account for residential service and one for commercial service, but both accounts are part of the same membership. In this example, one person with multiple accounts is linked to the membership, so there is only one member.

For each account linked to the membership, the service related to the account may be used to calculate the accumulated credits for the membership. Refer to [How Are Service Credits Earned?](#) for more information.

NOTE:

An account may not be linked to more than one membership of the SAME membership type at a given point in time. In other words, an account may not have two United Airlines frequent flier memberships (otherwise, the account would accumulate double miles). However, an account may be linked to more than one membership if they are of different membership types. For example, an account may have a capital credits membership and a United Airlines frequent flier membership.

When you find a customer's record on [Control Central - Search](#), you are transferred to the [Account Information](#) portal. One of the zones on this page contains information about memberships for the customer.

NOTE:

Portal Preferences. The service credit membership zone only appears if you have modified your preferences to display this zone. Refer to [Portal Preferences](#) for more information.

Joint Membership

It is possible for more than one person to belong to the same membership. These persons may be linked to the same account or to different accounts. A typical scenario would be a married couple that shares in a membership. This is considered a "joint" membership.

The number of "members" for a membership is mainly for information purposes and typically has no bearing on the service credit amounts calculated for the membership. There may be legal restrictions or business practice restrictions controlling how you may set up your members. For example:

- In an airline's frequent flier program, a separate frequent flier account would exist for each customer. It is possible for you to create a frequent flier membership with more than one "member", but for the system, the important information is the external frequent flier miles number linked to the membership. The customer linked to this number accumulates the miles. For this case, your business practice may be that the person with the frequent flier account must be the only financially responsible person.
- For a capital credits membership, you may be required to distinguish between "single" memberships and "joint" memberships. If a single person gets married and would like the spouse to be added as a member, your practice may be to expire the single membership and to create a new "joint" membership to include both spouses.

NOTE:

Co-op Members. Do not confuse the "members" of a co-op with the members linked to a service credit membership. At a cooperative, most customers are considered "members" of the co-op. However, in the system, separate membership records are created for each single or joint membership.

Changing the Membership Accounts

The link between the accounts and the membership is NOT effective dated. This means that if the list of accounts for a membership changes, you need to stop the membership and start a new one with the new list of accounts.

NOTE:

Stopping Memberships. Stopping a membership does not necessarily prevent new service credits from accumulating. Refer to [Stopping a Membership vs. Inactivating a Membership](#) for more information.

Membership Application

Your business practice may dictate that the customer complete an enrollment form. Depending on your practice, the form may need to be received prior to starting membership or it may simply be a mechanism to gather supplemental information once the membership has begun.

Either way, you may consider setting up the system to handle forms as follows:

- Design your membership type to include a creation algorithm that generates a letter when the membership is created. The letter template could include the form to be filled out.

- Create the new membership in pending status. The letter and form are sent to the customer and the pending status indicates that you are waiting for the completed form. Refer to the [Lifecycle of a Membership](#) for more information.
- When the paperwork is received, change the status of the membership to active.

NOTE:

Membership Events for Pending Memberships. The system allows events to be created for pending memberships assuming that paperwork is supplemental information that should not prevent service credits from accumulating. If your business practice dictates that the paperwork must be received prior to accumulating service credits, the algorithm or background process that creates events for memberships of this type should be coded to only create events for active memberships. Refer to [How Events Are Created](#) for more information.

Creation of a Membership

Memberships may be created using the [membership](#) page when a customer has signed up for a special program. In addition, it may be your business practice to automatically create a membership under certain circumstances when a customer has signed up for service.

For example, if you are a co-op, perhaps every new customer is automatically enrolled in a capital credits membership. Or perhaps signing up for cable service automatically entitles your customers to membership in the free pay-per-view movies program. For these cases, the recommendation is to use the [order](#) page to start service for your customer and to use questions and miscellaneous fields to record information needed to set up the new membership correctly. Refer to [Using Campaigns & Packages to Create a Membership](#).

Membership Fees

Some memberships may require a fee to be paid by the customer when joining. The behavior of this fee may differ depending on whether it is refundable or not.

- If the fee is nonrefundable, you create an SA with a simple adjustment or a one time billable charge to levy the fee. Refer to [Defining Control Tables for a Nonrefundable Fee](#).
- If the fee is refundable, in addition to defining the SA to hold the fee, you need to put code in place to initiate the refund. Refer to [Setting Up a Refundable Fee](#) for more information.

Stopping a Membership vs. Inactivating a Membership

You may stop a membership by entering an end date for the membership. However, depending on how events are created for your membership, stopping the membership may not prevent new events from being created. For example:

- If you stop a frequent flier membership on May 15th and a bill is subsequently created for the period May 1st through June 1st, your business rules may dictate that frequent flier miles should be accumulated for this bill because the membership was active for part of the period covered by the bill.
- For a capital credits membership, capital credit allocations are calculated for the prior year. If a membership stopped in the middle of the previous year, the membership should still get capital credits for the part of the year that the membership was still in effect.
- Capital credit retirements are calculated based on capital credit allocations accumulated in the past. If a membership has been expired, the members are still eligible for retirement amounts for the accumulated capital credit allocations. These retirements may continue for many years after a membership is stopped.

NOTE:

Membership Status. For all the above scenarios, the system assumes that the status of the membership remains active.

You may have some circumstances where you do not want new events to accumulate after a membership is stopped. To prevent new events from being created, you must change the status of the membership to inactive.

If a customer moves away or otherwise stops service with your company, your business rules dictate whether or not the membership should be stopped or changed to inactive. The following issues must be considered:

- Will service credit events still get created for these memberships? If so, is that acceptable?
 - For frequent flier memberships, the miles are calculated based on new bill amounts for the membership's service agreements. If the SAs that contribute to the membership are expired, no new bills are generated so no new miles are accumulated.
 - For capital credits, after a customer moves away, the capital credit allocation for the final year of the customer's service may still need to be calculated. In addition, this customer is eligible for the capital credit retirement amounts, even though they are no longer a customer.
 - What happens if the customer returns to your company and signs on for service again? Assuming that the same account number is used, is it ok for the membership to be automatically reinstated? Or should the customer reapply? If the customer should reapply, you may consider updating the membership with a stop date when the customer originally stopped service.
-

NOTE:

There is nothing in the system logic that automatically updates the membership stop date or the status when service agreements that contribute to the membership are stopped.

The Big Picture of SC Events

The service credit events record the accumulation and redemption of awards earned by the membership. The topics in this section provide background information about a variety of service credit event features and functions.

NOTE:

Events. For convenience, this document often refers to service credit events simply as "events".

Event Amounts May Contribute to a Balance

The event amount may be positive or negative, based on whether the event is accumulating points earned for the membership or redeeming points for the membership. For some types of memberships, these credit and debit amounts should be added together to produce the overall balance for the membership.

For some types of memberships, a balance is not applicable. This is true for memberships where the redemption of the points does not occur within the system. For example, if the membership accumulates frequent flier miles on behalf of an airline, the customer redeems the earned miles with the airline, not with your company. As a result, there is no need to calculate a balance for the membership.

If you want the system to calculate a balance, you must set a switch on the [membership type](#) page. For memberships that calculate a balance, the balance may be viewed on the membership page.

Events May Indicate a Fiscal Year

For some types of memberships, the amount of each event is associated with a specific fiscal year. This is true for capital credit memberships where capital credit allocations are calculated for a fiscal year. When the capital credits are redeemed (also called retired), the retirement events must also indicate a fiscal year. Because all events for this type of membership are related to a fiscal year, the system can calculate the balance for the events by fiscal year.

If you want the system to require a fiscal year for every event in the membership, you must set a switch on the [membership type](#) page. For memberships that calculate a balance and indicate a fiscal year, the balance for each fiscal year may be viewed on the membership page.

Events May Indicate a Subcategory

For some types of memberships, the amount of each event is further grouped by a subcategory. This is common for capital credit memberships where multiple capital credit allocations are calculated. For example, each year, you may calculate allocations for generation and for transmission. Events for memberships of this type must indicate a subcategory.

Cooperatives that allocate capital credits for more than one subcategory, typically want to view the balance of the events over time broken down into these subcategories. When the capital credits are redeemed or retired, the retirement events must also indicate a subcategory. Because all events for this type of membership are related to a subcategory, the system can calculate the balance for the events by subcategory.

NOTE:

Partial Retirement. For some cooperatives, it is common that certain capital credit allocations are never retired. Refer to [Partial Retirement](#) for more information.

If you want the system to require a subcategory for every event in the membership, you must define the valid subcategories on the [membership type](#) page. For memberships that calculate a balance and indicate a subcategory, the balance for each subcategory may be viewed on the membership page.

NOTE:

Calculating Subcategory Balances. If events for your membership indicate a subcategory and fiscal year, balances for the membership are calculated for both groupings.

An Event May Cause Other Actions to Occur

When an event is generated, there are often other actions that need to take place. For example:

- If an event is created that allocates points for the customer, you may want to generate a temporary message on the customer's next bill.
- If a capital credit allocation event is created, the general ledger is affected so an adjustment must be created to post to the general ledger. Refer to [Financial Transactions for an Event](#) for more information.
- If an event is created to add frequent flier miles, the event must be marked for extraction so that the information is sent to the appropriate airline. Refer to [Interface Membership Information to a Third Party](#) for more information.
- If an event to retire capital credits is created, the customer's balance is affected so an adjustment must be created to transfer the capital credit to the members' service agreements. Refer to [Financial Transactions for an Event](#) for more information.

The system relies on algorithms linked to the event type to perform the actions described above and any other action that may be required by your business.

FASTPATH:

Refer to [Service Credit Event Types](#) for more information about the algorithms provided with the base product.

NOTE:

Event Cancellation Algorithms. The event type also defines algorithms to be executed when an event is canceled.

Financial Transactions for an Event

An event may be related to financial transactions. There are two types of financial transactions that may be linked to the event:

- Financial transactions that contributed to the event. These are bills, payments or adjustments that caused the event to be created. For example, if you generate an event for frequent flier miles as a result of some amount billed for the customer, the bill segments associated with the billed amount are linked to the event. The FTs are linked to the event for audit purposes.
- Financial transactions that are created by the event. In [an event may cause other actions to occur](#), we saw examples where an event completion algorithm may cause adjustments to be created. The FT ID for these adjustments is linked to the event as audit.

NOTE:

Automatically Canceling Event Financial Transaction. The created by financial transactions may get canceled if the event is canceled AND you have plugged in an appropriate [Event Cancellation Algorithm](#).

For financial transactions that are created by the event, the system must post the financial transactions to one or more appropriate service agreements. The service agreement to use depends on your business rules. For example:

- If the event affects the balance of accounts linked to the membership, the event completion algorithm may create adjustments for [service agreements that contribute to the membership](#).
- If the event affects the general ledger and does not affect any balance for the account, the event completion algorithm simply needs a service agreement to use for the resulting adjustment. Rather than arbitrarily picking any service agreement in this case, a special [miscellaneous service agreement](#) should be linked directly to the membership for such adjustments.

How Events Are Created

Although a user may create an event manually on the [service credit event](#) page, most events are created automatically by an algorithm or by a background process. The following topics further describe these options.

Events Created by an Algorithm

You would design an algorithm to create your events if the event should be triggered by an occurrence in the system, such as starting service or generating a bill. For example, perhaps every time you are billed for electric and/or gas service, the system adds one frequent flier mile for every \$10 spent on service. Refer to [How Are Service Credits Earned?](#) for more information.

The base product provides a bill completion algorithm to create an event as a result of the amount billed for service agreements linked to the membership. Refer to CBCM-SC for more information.

Events Created as a Result of a Background Process

You would use a background process to create the event if the calculation is done periodically or on an ad-hoc basis and does not get triggered by something occurring in the system. For example, the capital credit allocation and retirement processes are typically run once a year, when the business has determined that they are ready to calculate these amounts.

FASTPATH:

Refer to [Allocating Capital Credits](#) and [Capital Credit Retirement](#) for more information.

Creating Pending Events

Events may be created in pending or complete status. Only complete events cause the completion event algorithms to run and [cause other actions to occur](#). You may use the status of pending if you want to review the calculated amount prior to completing the event.

For example, when a cooperative runs the background process to [allocate capital credits](#), it may create the new events in the pending status. This allows the co-op to review the total amount of capital credits calculated for all members. If this total is in line with the co-op's expectations, they run the background process again creating the new events in complete status. Only at this point do the completion event algorithms run.

Events May Be Transferred

In some situations, you may want to transfer service credit events from one membership to another on the [service credit event](#) page. For example, if a member dies, you may decide to transfer earned service credits to the membership for a beneficiary. When transferring a service credit:

- The target membership must be of the same membership type as the original membership.
- The original service credit event is canceled and any event cancellation algorithms linked to the [SC event type](#) are executed.
- A new service credit event is created and completed and any event completion algorithms linked to the [SC event type](#) are executed.
- The new service credit event references the original event ID in the **Transferred From** event field.

NOTE:

Contributed to FTs linked to the original event are not transferred to the new event. If you have created by FTs linked to the original event, the recommendation is to ensure that an event cancellation algorithm cancels this FT and that an event completion algorithm for the new event creates an appropriate new FT for the new membership.

CPCRALOC - Allocating Capital Credits

The base product provides a background process (CPCRALOC) that allocates capital credits to members of a cooperative. The result of this process is the creation of new service credit events for capital credit memberships. This background

process is typically run after the profits for the previous year are calculated. During that time, this job could be run a number of times for any of the following reasons:

- At the beginning of the allocation process, you may know the total amount to allocate to all members; however, you may estimate the allocation factor that determines the individual amounts that get distributed to the members. You may need to change your estimate and rerun the process until all the individual allocations add up to the desired total amount. To run the job with the estimated allocation factors, indicate that you want events created as pending. When you confirm the correct allocation factor, a final run should be executed with an indication that the events should be created as complete. Every time the process runs, it will first remove any pending events for the same input event type, subcategory and fiscal year. Refer to [Creating Pending Events](#) for more information.
- If the cooperative has more than one subcategory, the process must be run for each subcategory. In fact, the above trial-and-error process may need to be followed for each subcategory.

You must provide the [service credit event type](#) to use for the new events. This process determines the membership type related to the event type. The process then finds all pending and active memberships for this membership type. To calculate the capital credit allocation, the system finds all applicable bill segments for each [service agreement that contributes to the membership](#).

Capital credit allocations are calculated for a specific [fiscal year](#). The fiscal year is input to the background process and is stamped on any new events created by the process. The system also uses the fiscal year to determine the applicable bill segments for the membership's SAs. It uses the bill segment's accounting date and the [accounting calendar](#) to determine the fiscal year for each bill segment.

NOTE:

Canceled Bill Segments. Any bill segments that were canceled in the fiscal year are included as well.

Accounting Calendar. This process assumes that only one accounting calendar exists for the company. This is the case for companies that operate in a single jurisdiction, which is true for cooperatives.

Allocation Period. If the membership was only effective for part of the fiscal year, the allocations are only calculated for the period of time that the membership was in effect.

For each applicable bill segment, the system determines the SQ total and the total sales amount for each segment. To calculate the totals correctly, a characteristic type and value to identify SQ bill lines must be provided to the background process and a characteristic type and value to identify bill lines contributing to the total sales amount must be provided to the background process.

FASTPATH:

Refer to [Identifying SQ and Sales Information for Historical Bill Segments](#) for more information.

If your membership type indicates subcategories to be used for the events, you must provide a subcategory as input. If you have multiple subcategories for your membership, this process must be run once for each subcategory.

The calculation of the capital credit allocation amount typically uses an allocation factor. This factor is often different for each subcategory. You will probably define a different bill factor for each subcategory and use the appropriate bill factor when submitting the process for each subcategory.

This process also assumes that the allocation factor differs by the customer's revenue class. It assumes that the bill factor's characteristic type is revenue class. Refer to [Designing Bill Factors for Credit Allocation](#) for more information. For each service agreement linked to the membership, the appropriate allocation factor is determined based on the revenue class for the SA type.

Capital credits for the input subcategory are calculated as follows:

Fiscal year sales amount - (fiscal year SQ amount * revenue class allocation factor) = Allocation Amount

The calculated amount is compared against a minimum amount, input to the background process. If the calculated amount is less than the minimum, no event is stored for this amount.

After determining the amount, a new service credit event is created for the membership. The event is stamped with the input subcategory, service credit event type and fiscal year.

The FTs for all the bill segments used to determine the allocation amount are linked to the event as contributed to FTs. Refer to [Financial Transactions for an Event](#) for more information.

NOTE:

Rerunnable Process. This process is restartable and rerunnable. When running the process, for each membership the system checks whether there is already a complete event for the input service credit event type, subcategory and fiscal year. If so, it does not create a new event.

FASTPATH:

Refer to CPCRALOC for more information.

CPCRRETR - Capital Credit Retirement

NOTE:

Calculation Method. There are various calculations that different cooperatives may use when determining the amount to retire. The base product has provided one calculation method.

This background process is run when a cooperative is ready to pay out allocated capital credits to its members. This process is referred to as retirement. The result of this process is the creation of new service credit events for capital credit memberships. Capital credits are paid as the cooperative's financial position permits. During that time, this job could be run a number of times for any of the following reasons:

- You may choose to run the process and [create pending events](#) to review the results prior to finalizing the retirement. When you are happy with the results, a final run should be executed with an indication that the events should be created as complete. Every time the process runs, it will first remove any pending events for the same input event type and subcategory.
- If the cooperative has more than one subcategory, the process may be run separately for each subcategory. You may also run the process with no subcategory indicated and then all subcategories are processed.

NOTE:

Partial Retirement. For some cooperatives there may be capital credits for some allocated amounts that are never retired. If that is the case, simply run this process for each subcategory whose amounts do get retired.

You must provide the [service credit event type](#) to use for the new events. This process determines the membership type related to the event type. The process then finds all pending and active memberships for this membership type.

This process receives a percentage to retire as input. It determines the current balance of all completed events for the subcategory. The retirement amount for the subcategory is calculated as the current balance * input percentage to retire. The process then determines the outstanding balance for each subcategory and fiscal year combination. For every combination that still has a balance, the process creates events to relieve the outstanding balance for the oldest fiscal year first. It creates events for subsequent fiscal years until the full retirement amount is used.

In order for the process to be rerunnable and restartable, a Control ID is used to mark retirement events that are created by the process. The Control ID is input to the routine and is determined by the user. When the process runs, it determines whether an event already exists for the subcategory / Control ID combination. If so, new events are not created for that subcategory. If you run the process multiple times for the reasons described above, you should use the same Control ID each time. This way the system knows that the process is being run again for the same retirement calculation.

FASTPATH:

Refer to CPCRRRETR for more information.

Maintaining Service Credit Memberships and Their Events

The topics in this section describe how to maintain a service credit membership and its events.

FASTPATH:

Refer to [The Big Picture Of Service Credits](#) for background information about service credits.

Service Credit Membership

The topics in this section describe how to maintain service credit memberships. Refer to [The Big Picture Of Service Credit Membership](#) for background information about memberships.

Lifecycle of a Membership

The following diagram shows the possible lifecycle of a service credit membership.

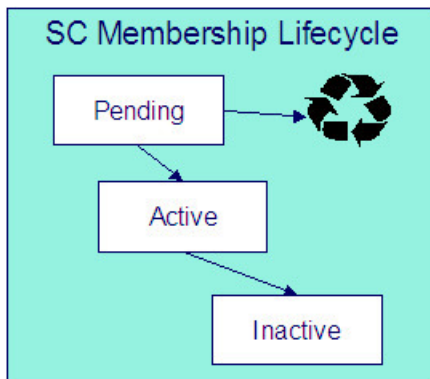

Pending A service credit membership may start out in the Pending state. A membership is typically created in this state if the creation of the membership requires approval or any manual step (e.g. waiting for paperwork) that needs to be completed prior to activation.

NOTE:

Events for Pending Memberships. Service credit events may still be created for membership records in the Pending state.

Active A service credit membership is in the Active state when a customer is actively participating in a service credit membership. A membership may be created in the Active state or it may transition to the Active state from Pending when all the necessary approval or paperwork is complete.

NOTE:

Manual Activation Only. There is no system functionality that automatically changes the status of a membership from Pending to Active. This is a manual step.

Inactive If a customer is no longer actively participating in a service credit membership, change the status to Inactive. This will prevent any new events from being created for the membership.

Service Credit Membership - Main

This page is used to maintain and display general information about a service credit membership. Open this page using **Menu > Customer Information > Service Credit Membership > Search.**

Description of Page

Membership Info and **Membership ID** are displayed on every page. These values only appear after the membership exists on the database. The **ID** is a system-assigned random number. The **Membership Info** is a concatenation of important details about the membership.

Membership Status defines the state of the membership.

FASTPATH:

Refer to [Lifecycle of a Membership](#) for more information about membership status.

Click the **Activate** button to activate a Pending membership. When this button is clicked, the system executes any Membership Activation algorithms that are linked to the [service credit membership type](#).

Click the **Inactivate** button to transition an Active membership to Inactive. When this button is clicked, you are prompted to provide an **Inactive Reason** and the system executes any Membership Inactivation algorithms that are linked to the [service credit membership type](#).

Indicate the **SC Membership Type**. This field is important as it controls numerous aspects of the behavior of the membership and its events.

FASTPATH:

For more information about what the membership type controls, refer to [Setting Up Service Credit Membership Types](#).

Indicate the **Start Date** and **End Date**, which define the period for which this membership is effective. Leave the end date blank if this membership is effective indefinitely. Refer to [Stopping a Membership vs. Inactivating a Membership](#) for more information.

If this membership is related to a record in an external system, use the **External ID** to indicate the unique identifier of the record in the external system.

If events linked to your membership may generate miscellaneous adjustments, indicate the **Service Agreement** to use for these [miscellaneous transactions](#). The account for this service agreement must be one of the accounts linked to the membership.

The **Events** grid displays the events linked to the membership. To view any of the events use the drill down button.

If your SCM type indicates that the membership has a balance, the tree at the bottom displays information about the balance of the membership based on the amounts for completed events. If the SCM Type indicates subcategories and/or a fiscal year is required, subtotals for completed events are also displayed for each subcategory / fiscal year and by fiscal year / subcategory, if applicable. If any pending events exist, the tree includes a node with information about these events.

Service Credit Membership - Account

This page is used to maintain the accounts linked to a service credit membership. Open this page using **Menu > Customer Information > Service Credit Membership > Search** and navigate to the **Account** page.

Description of Page

Indicate the **Account ID** for each account linked to this membership. Typically a membership will be linked to only one account. However, if a person has multiple accounts and the service credits should span the accounts, multiple accounts are linked to the same membership.

The Service Credit Membership zone on the Account Information portal contains information about memberships for the current customer. (When you find one of the customer's records on [Control Central - Search](#), you are automatically transferred to the [Account Information](#) portal.)

NOTE:

Portal Preferences. The Service Credit Membership zone only appears if you have modified your preferences to display this zone.

Service Credit Membership - Characteristics

The characteristics page contains information that describes miscellaneous information about the service credit membership. Open this page using **Menu > Customer Information > Service Credit Membership > Search** and navigate to the **Characteristics** page.

Description of Page

NOTE:

Characteristic Types. You can only choose characteristic types defined as permissible on the service credit membership record. Refer to [Setting Up Characteristic Types & Their Values](#) for more information.

To modify a characteristic, simply move to a field and change its value. To add a new characteristic, click + to insert a row then fill in the information for each field. The following fields display:

Effective Date Define the date on which the characteristic becomes effective. The effective date defaults from the [Installation Record](#).

Characteristic Type Indicate the type of characteristic.

Characteristic Value Indicate the value of the characteristic.

NOTE:

Default Note. A service credit membership's characteristics default from the [service credit membership type](#).

Service Credit Membership - Membership Tree

The membership tree page displays accounts, SAs and persons linked to the service credit membership. Open this page using **Menu > Customer Information > Service Credit Membership > Search** and navigate to the **Membership Tree** page.

Description of Page

The tree displays each account linked to the membership. For each account, a node exists for:

- Each service agreement whose SA type is included in the service credit [membership type](#) 's SA type collection.
- Each financially responsible person linked to the account. These persons are considered the [members](#).

Maintaining Service Credit Events

Service credit events record credits earned or redeemed for a given membership. The topics in this section describe how to maintain service credit events. Refer to [The Big Picture of Service Credit Events](#) for background information about memberships and their events.

Lifecycle of a Service Credit Event

The following diagram shows the possible lifecycle of a service credit event.

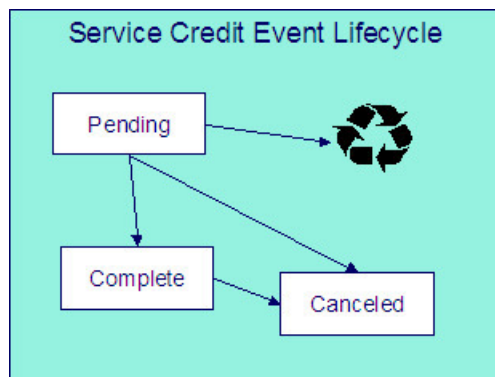

Pending A service credit event may start out in the Pending state. An event is typically created in this state when a review of the event is desired before completing it. Refer to [Creating Pending Events](#) for more information.

Complete A service credit event is typically created in the Complete state. When an event is completed, the system executes any event completion algorithms indicated on the [service credit event type](#).

Canceled If a service credit event is no longer valid, it may be Canceled. When an event is canceled, the system executes any event cancellation algorithms indicated on the [service credit event type](#).

Service Credit Event - Main

Open this page using **Menu > Customer Information > Service Credit Event > Search**.

Description of Page

The **Service Credit Event Info** is a concatenation of important details about the service credit event. The **Service Credit Event ID** is a unique system-assigned random number. These values only appear after the service credit event exists on the database.

Service Credit Event Status defines the state of the service credit event.

FASTPATH:

Refer to [Lifecycle of a Service Credit Event](#) for more information.

Click the **Complete** button to change a Pending event to Complete. When this button is clicked, the system executes any event completion algorithms that are linked to the [service credit event type](#).

Click the **Transfer** button to transfer this event to another membership. When this button is clicked, you are prompted to provide the membership ID to transfer the event to. The new membership must have the same membership type as the original membership. Refer to [Events May Be Transferred](#) for more information.

Click the **Cancel** button to cancel this event. When this button is clicked, the system executes any event cancellation algorithms that are linked to the [service credit event type](#).

The **Create Date/Time** captures the date and time that this event was created. This defaults to the system date/time.

Indicate the service credit **Membership ID** to which this event should be linked.

Indicate the **Service Credit Event Type**. This field may define algorithms to be executed when the event is completed or canceled. Refer to [Setting Up Service Credit Event Types](#) for more information.

If your [service credit membership type](#) indicates one or more subcategories to be associated with events for this type of membership, indicate the appropriate **Subcategory Name** for this event.

If your [service credit membership type](#) indicates that fiscal year is required, indicate the appropriate **Fiscal Year** for this event.

Enter the **Service Credit Event Amount**. If your [service credit membership type](#) indicates that your membership has a balance, this amount is used to calculate the overall balance for the membership as well as a balance for the subcategory and/or fiscal year, if applicable.

If this event was created as a result of a transfer from another membership, the **Transferred From Event ID** is displayed.

If the information about this event may be [downloaded to a third party](#) system, you should have an event completion algorithm that stamps the appropriate **Batch Control** and **Batch Number** onto the event.

The FT collection displays information about [financial transactions related to this event](#). Two different categories of financial transactions may be linked to the event.

- FTs that contributed to this event. These financial transactions played a part in the creation of this event. For example, if frequent flier miles are earned as a result of newly created bill segments, the FTs related to these bill segments are linked to the event and marked as contributed to FTs. This information is purely for audit purposes. It is the responsibility of the algorithm or background process that creates the event to populate the collection of contributed to FTs. Refer to [How Events Are Created](#) for more information.

NOTE:

The amount of the contributed to FTs will not necessarily add up to the amount of the event. Refer to the algorithm or background process that calculates the amount of the event to understand how the event amount is calculated based on the amount of the contributed to FTs

-
- FTs that were created by this event. These financial transactions are created as a result of this event. For example, if you have generated a capital credit allocation event, perhaps you need to post information to the general ledger. An allocation event should therefore generate an adjustment to post the effect on the GL. The adjustment's FT is linked to the event as an audit. In order to create a financial transaction related to this event, you must plug in an appropriate event completion algorithm on your [service credit event type](#).

FASTPATH:

Refer to [An Event May Cause Other Actions to Occur](#) for more information.

Loans

There are many reasons why your company may loan money to customers. For example, your company may loan money to:

- Finance service upgrades (e.g., to change to dual fuel)
- Support economic development (e.g., to extend a power line)
- Promote energy conservation (e.g., customers borrow to insulate their house)

NOTE:

Loans are optional. You need only set up loans if your organization loans money to customers. For information on setting up the system to enable loans, refer to [Defining Loan Options](#).

The Big Picture Of Loans

The topics in this section provide background information about loans.

Loans Are Service Agreements

Loans are initiated by creating a loan service agreement for a customer. The loan service agreement (and its SA type) contains the loan's terms, including the loan amount, periodic payment amount, the number of amortization periods, the interest rate, and the periodicity of the bills. Loan service agreements are just like other service agreements in many ways:

- The system bills the customer for the periodic payment amount using information on the service agreement.
- The customer pays the billed amount.
- If the customer doesn't pay, [credit and collections](#) may start a collection process to encourage the customer to pay (depending upon how the loan debt class has been set up on your system).

Loan service agreements differ from other service agreements in the following ways:

- Loans have [interest charges](#).
- Loans have [amortization schedules](#).
- Loan SAs are maintained on a separate transaction (refer to [Loan - Main](#) for more information).

NOTE:

Loan service agreements are created using Start/Stop. Loan service agreements are created using [start/stop](#) just like all other service agreements. The start/stop transaction has special loan functionality that allows an operator to specify the service agreement-specific loan terms described above. A start option can be specified to override the SA type's interest bill factor.

Loan Interest Charges

When a bill is generated for a loan, the interest charge is calculated using an algorithm. The base package loan interest charge algorithm type (LINT-SI) calculates simple interest based on:

- Unbilled principal (i.e., the payoff balance minus the current balance)
 - The number of billing periods covered by the bill
 - The interest rate
-

NOTE:

No interest on interest and no interest on past due amounts. Just like a classic home loan, the base package algorithm does not calculate interest on interest, nor does it calculate interest on past due amounts. However, your system may be set up to levy a late payment charge.

After the interest charge is calculated, the bill segment FT algorithm generates the financial transactions for the bill. The base package FT algorithm generates a financial transaction that adds the interest charge to the payoff balance. In other words, if the customer wanted to pay off the loan, they would owe the principal balance plus the interest charge.

FASTPATH:

For more information, refer to [Billing For Loans And Interest Calculation](#).

Loan Amortization Schedules

A loan's periodic payment amount is calculated such that the customer repays the loan in equal amounts over the term of the loan (with the exception of the first and last bill segments, which are typically for different amounts). The amortization schedule is a projection of the amount of principal and interest in each payment over the life of the loan. The amortization schedule may change, for example if the interest rate changes or the customer makes an overpayment (reducing the principal balance).

The amortization schedule is a theoretical projection of the future. The term theoretical is used because the customer's actual payments can cause the schedule to change. For example, if a customer overpays a bill, the loan's length decreases and the amount of principal and interest in each scheduled payment changes.

A loan's amortization schedule is calculated when you click the **Calculate** button on [Loan - Main](#). When this button is clicked, an algorithm plugged in on the loan SA type actually calculates the amortization schedule.

You can view a loan's latest amortization schedule using [Loan - Main](#). You can also change the loan's payment periods or periodic payment amount on this page and recalculate the loan's amortization schedule.

Negative Amortization

The system does not allow you to use a periodic payment amount that is less than the periodic interest amount. If it did, the customer's payoff balance would increase over time (this is referred to as "negative amortization"). There are two methods you can use to specify a payment amount in the system. Depending on which method you use, the system informs you of negative amortization differently:

- If you enter a payment amount that is too small on the Start confirmation page or in the **Renegotiate Future Payments** grid on [Loan maintenance](#), you get an error message when you click the **Calculate** button. You must fix the payment amount before you can start the loan or save your changes.
- If you manually override the **Payment Amount** on [Loan maintenance](#), you can save a payment amount that is too small to cover the interest charges. However, the system notifies you that it is not able to calculate the **Forecasted Schedule** because of negative amortization. Additionally, bill segments for the loan SA are produced in error until the payment amount is adjusted appropriately.

Loan Overpayments

Overpayments reduce the principal amount (the amount owed on the loan), which follows the philosophy adopted by a typical home loan. When the payment is made, any overpayments are distributed according to the overpayment distribution algorithm defined for the customer class. Typically, loan service agreements should be set up so that the overpayment is applied to the principal balance.

When the payment transaction is frozen, the system checks to see if there is a credit amount on the loan SA's current balance. If a credit exists, the customer has made an overpayment and an adjustment is created to transfer the amount of the credit from the SA's current balance to its payoff balance, thus reducing the principal by the amount of the overpayment.

FASTPATH:

For more information about the adjustments created for loan overpayments, refer to [Overpayments On Loans](#).

NOTE:

Overpayments and interest. The base package interest calculation algorithm (plugged in on the loan's SA type) does not take into consideration the exact date that the overpayment is made when calculating the interest for the period. It only takes into consideration the outstanding principal amount (payoff balance - current balance) at the time of the interest calculation.

The Lifecycle Of A Loan

Loans have the same [lifecycle as other service agreements](#) (e.g., pending start, active, pending stop). You should rarely have to manually change a loan service agreement's status. Why? Just like other service agreements, the system changes the status behind-the-scenes when various events take place. For example, loans in the pending start state are automatically activated by a system background process.

If you need to manually change a loan service agreement's status (e.g., you need to cancel a loan that was inadvertently started), you can do so from [Service Agreement - Main](#).

Finalizing And Closing A Loan

A loan SA is automatically stopped when the last bill segment is generated for the loan. If the remaining principal balance (plus accrued interest) is less than or equal to the loan payment amount, the SA status is changed to pending stop and the bill segment is marked as the closing bill segment. The SA can then be stopped by the user (manually using the SA page) or by the SA activation background process. When the customer pays the last bill, the loan SA is closed.

FASTPATH:

For more information about transitioning SAs from pending stopped, refer to [Finalizing Pending Stops](#).

Navigating To The Loan Maintenance Page

Any of the following methods can be used to navigate to the [Loan Maintenance](#) transaction:

- A user can set up a [favorite link](#) associated with the loan transaction.

- Via any of the following menus:
 - Account context menu
 - Service agreement context menu
 - Menu

NOTE:

Alerts and Loans. If the loan SA type is set up with an alert, the [Alert Zone](#) highlights if a loan exists for the current account. You are transferred to the SA maintenance transaction (not the loan maintenance transaction) if you drill down on the alert.

Loan Maintenance

You can use loan maintenance to view the loan's amortization schedule and financial history as well as to change the terms of a loan, including the loan amount (prior to SA activation only), interest rate, payment amount and number of payment periods.

NOTE:

Starting Loans. You cannot start a loan from Loan - Main; you must use Start/Stop. Refer to [How To Start A Loan Service Agreement](#) for information.

Open **Menu > Customer Information > Loan > Search** to maintain a loan.

Description of Page

The fields at the top of the page are informational only. The **Payoff Balance** is the total amount owed by the customer (excluding any interest that may have accrued since the last bill). The **Current Balance** is the amount currently owed by the customer. The **Principal Balance** is the total principal amount left unbilled. Refer to [Payoff Balance and Current Balance for Loans](#) for more information.

The **Loan Amount** is the amount originally loaned to the customer. The **Standard Interest Rate** is the standard interest rate defined on the loan's SA type. If the SA type allows, the standard interest rate may be overridden by a start option and/or manually. The **Next Payment Amount** is the effective periodic payment amount as of the next bill.

The **Payment(s)** shows the number of payments that were used to calculate the original loan schedule.

The **Override Interest Rate** grid is used to override the standard interest rate. The interest rate can only be modified if the loan's SA type allows it. Note that changing the interest rate changes the loan amortization schedule. To override the interest rate:

- Specify an **End Date** for the override rate in effect if there is one.
- Click + and specify the **Start Date** and the new **Interest Rate**. You can also specify the **End Date** of the new override rate, but this is not required.

The **Payment Amount** grid is used to maintain the effective periodic payment amount. Note that changing the payment amount changes the amortization schedule. To change the payment amount:

- Click + and specify the **Effective Date** and the new payment **Amount**.

NOTE:

Entering a payment amount that is too small. If you save a payment amount that is too small to cover the periodic interest charges, this causes [negative amortization](#). The system is not able to recalculate the amortization schedule and bill segments are produced in error until the problem is corrected.

The **History** grid shows the loan's financial history in reverse chronological order. The financial history grid displays the following information:

- The **Arrears Date** is used to compute how many days old the debt is. In the context of a loan, debt only refers to the billed amount (the amount the customer needs to pay to stay current).
- **Financial Transaction Type** displays the type of financial transaction except for adjustments. For adjustments, the adjustment type's description is shown.
- **Current Amount** is the effect of the FT on the service agreement's current balance.
- **Current Balance** is the amount owed by the customer at the time of the transaction.
- **Payoff Amount** is the effect of the FT on the service agreement's payoff balance. The value is grayed out if it is the same as the current amount.
- **Payoff Balance** is the total amount owed by the customer. The value is grayed out if it is the same as the current balance.

WARNING:

If you do not understand the difference between payoff balance and current balance, refer to [Payoff Balance And Current Balance For Loans](#).

The **Forecasted Schedule** displays the loan amortization schedule. The first row of the schedule shows the current cumulative interest, current cumulative principal and the current principal balance. All other rows show the future amortization schedule based on the loan details. The forecasted schedule includes the following information:

- The **Loan Period** displays the forecasted payment period dates based on the billing frequency and the payment periodicity. The Loan Period is blank for the first row, which shows current cumulative amounts.
- The **Amount** displays the projected amount of that payment. The Amount is zero for the first row, which shows current cumulative amounts only.
- The **Interest** displays the projected amount of interest in the payment amount. The Amount is zero for the first row, which shows current cumulative amounts only.
- The **Principal** displays the projected amount of principal in the payment amount. The Amount is zero for the first row, which shows current cumulative amounts only.
- The **Cumulative Interest** is the total interest amount that would theoretically be billed at that loan period.
- The **Cumulative Principal** is the total principal amount that would theoretically be billed at that loan period.
- The **Principal Balance** is the remaining principal balance that would theoretically be remaining at the loan period.

NOTE:

Forecasted schedule. The loan schedule algorithm calculates the values in the forecasted schedule. Depending on the algorithm set up for your installation, the values may have a different meaning.

The **Renegotiate Future Payments** area allows you to change the terms of the loan. You can modify the following options:

- You can modify the **Loan Amount** only if the SA has not been activated. After the SA is activated, this field is for information only.
- The **Interest Rate** allows you to change the interest rate. When changing the interest rate, specify either the number of payment amounts or the payment amount and click Calculate to recalculate the amortization schedule.
- The **Number of Payment Periods** allows you to change the number of periods remaining in the loan's term. The **Frequency** displays the periodicity of the payments. If you change the number of payment periods, use the Calculate button to recalculate the payment amount.
- The **Payment Amount** allows you to change the amount of individual payments. If you change the payment amount, use the Calculate button to recalculate the number of periods.

- The **Calculate** button recalculates the payment amount (when you specify the interest rate and the number of payment periods) or the number of payment periods (when you specify the interest rate and the payment amount) and recomputes the loan amortization schedule based on these new terms.

NOTE:

Implementing New Loan Terms. The changes that you make using **Override Interest Rate, Payment Amount** and **Renegotiate Future Payments** do not take effect until you save the loan. Changes made to the **Renegotiate Future Payments** section are only valid for save after you click Calculate, and they override any other changes.

Saving Renegotiated Future Payments. When you save a loan that has renegotiated payments, the system may add new records for the override interest rate, payment amount, or both. It uses the start date of the next loan period as the start date of the new interest rate and/or as the effective date of the new payment amount. If the loan has not yet been billed, the system updates the interest rate and/or payment amount created when the loan was started.

How To

The topics in this section describe how to perform common loan functions.

How To Start A Loan Service Agreement

Loan service agreements are created using [start/stop](#) just like all other service agreements. The start/stop transaction has special loan functionality that allows an operator to specify the service agreement-specific loan terms described above.

Creating a loan service agreement involves the following steps:

- Select the account on Control Central then open Start/Stop.
- Enter a **Start Date** and a **Start Method** of Start a SA.
- Indicate the **CIS Division / SA Type** of the loan service agreement and click the **Start** button.

NOTE: If the service agreement's account's CIS Division's **Restrict to Account CIS Division** flag is set to *Restricted*, the CIS Division is set to the account's CIS Division and cannot be changed.

- After you click **Start**, the Start Confirmation page appears. When you select a loan service agreement type, the Start Confirmation page displays special fields that allow you to specify the loan's terms.
- Select a loan **Start Option**. The start option includes the adjustment type for booking the principal amount, and can also include defaults for the initial loan amount, periodic payment amount, payment periods, and interest rate. The system uses the information on the start option to populate the service agreement's default parameters. You can manually override these parameters:
 - Enter the **Loan Amount** (the amount that the customer is borrowing). Note that the label for the Total Amount To Bill (e.g., Loan Amount) may appear differently depending on how the SA type was defined.
 - The system can automatically calculate either the payment amount (based on the loan amount and the payment periods) or the payment periods (based on the loan amount and the payment amount). Enter either the **Payment Amount** or the **Payment Periods** and click **Calculate**. Note that the label for the Recurring Charge (e.g., Payment Amount) may appear differently depending on how the SA type was defined.
 - Once the loan parameters are populated, click **Start**.

The loan is created in the pending start state. The next time the SA activation process runs, it will activate the loan SA. If you want to activate the loan immediately, navigate to the service agreement page and click **Activate SA**.

NOTE:

Overriding the Interest Rate. The **Interest Rate** is a display only field. The interest rate is taken from the value of the interest bill factor defined on the SA type or the contract value of the interest bill factor on the start option if one is defined. After starting a loan, you can manually override the interest rate using [Loan - Main](#) if the SA type allows it.

Changing The Loan Amount. You can use loan maintenance to change the loan amount for an SA as long as the SA has not yet been activated. It may be helpful to transfer to [Loan - Main](#), and verify the amortization schedule before activating the SA.

How To Modify The Terms Of A Loan

After a loan is active, you may want to modify its terms. You can change number of payment periods, the payment amount, and the interest rate (if allowed by the SA type). To modify the terms of a loan:

- Navigate to the [Loan maintenance](#) page.
- If you used the account context menu, the loan you want to modify may be displayed. If not, use the search dialog that appears to search for and select the loan you want to modify.
- In the **Renegotiate Future Payments** section, change the interest rate (if allowed), the number of payments, or the payment amount. Note that either the number of payments or payment amount must be blank.
- Click **Calculate**. The **Forecasted Schedule** is recalculated along with either the new payment amount or the new number of payments (depending on which was left blank).
- If the renegotiated payments are satisfactory to the customer, save the changes.

When you save the changes, appropriate entries are made in the **Override Interest Rate** and **Payment Amount** grids.

NOTE:

Saving Loan Modifications. You must save the renegotiated payments after clicking Calculate for the loan modifications to be effective.

How To Adjust Loans

You issue ad hoc adjustments if you need to change a loan's principal and/or current balance outside of the normal billing and payment functions.

An adjustment can:

- Change a loan's payoff balance.
 - Change a loan's current balance (i.e., how much the customer thinks they currently owe).
 - Change both the loan's payoff and current balance.
-

FASTPATH:

For details about the adjustment types to apply, refer to [Adjusting Loan Amounts](#). For information about creating adjustments, refer to [Adjustments](#).

How To Stop A Loan Service Agreement

Normally, a loan SA is automatically stopped when the bill segment for the last payment in the amortization schedule is generated for the loan (refer to [Finalizing And Closing A Loan](#)).

If a customer decides to payoff a loan before the term is complete, you can:

- Transfer to the SA maintenance page for the loan service agreement, specify an **End Date** for the loan, and click Save. This transitions the loan SA to pending stop.

NOTE:

End Date. The loan SA cannot be stopped until the specified end date is reached, so do not specify an end date that is in the future unless you do not want to stop the loan until that date.

Once the loan is in pending stop and the end date has been reached, the system transitions the loan SA to stopped. On the service agreement's normal bill cycle, the system final bills the SA for any outstanding balance plus accrued interest charges.

If you want to stop the loan and create the final bill immediately, complete these additional steps:

- On the loan's SA maintenance page, click the Stop SA button to transition the loan SA to stopped.
- Manually, [create a bill](#) for the loan service agreement. Remember that if you only want to generate a bill segment for a specific service agreement (e.g., the loan service agreement), transfer to the bill segment page. From there, you can generate and freeze a bill segment for a specific service agreement. When finished, return to the bill page and complete the bill.

When the customer pays the final bill, the loan SA is closed by the system.

FASTPATH:

For more information about SA states, refer to [The Lifecycle Of A Service Agreement](#).

Non-Billed Budgets

A Non-Billed Budget (NBB) is a payment plan used to level out a customer's payments over time. Non-billed budgets are typically used when your company bills on an infrequent basis and you want to provide your customers with a mechanism to make smaller payments more frequently. For example:

- Rather than receive a bill once a quarter, a customer could set up an Non-Billed Budget to pay fortnightly
- Rather than pay two large bills a year, the customer could set up an Non-Billed Budget to pay 10 out of 12 months (sparing themselves during the holiday season)

Non-Billed Budgets can cover one or more service agreements linked to the same account. You can have multiple active Non-Billed Budgets for an account, but any given service agreement can only be covered by a single Non-Billed Budget at any point in time.

NOTE:

Non-Billed Budgets are optional. The business processes described in this section are only relevant if your organization offers Non-Billed Budgets to its customers.

FASTPATH:

For information about setting up non-billed budget functionality for your system, refer to [Defining Non-Billed Budget Options](#).

The Big Picture Of Non-Billed Budgets

The following topics provide background information about Non-Billed Budgets.

Non-Billed Budget Service Agreements

Non-Billed Budgets are initiated by creating a Non-Billed Budget service agreement for a customer. The Non-Billed Budget SA and its SA type maintain the details of the Non-Billed Budget, such as recommendation rules, covered SAs, scheduled payments and credit balance. Non-Billed Budgets are just like other service agreements in some ways:

- Non-Billed Budgets have a current and a payoff balance.
- If the customer doesn't pay a monitored Non-Billed Budget, credit & collections may start a collection process to encourage the customer to pay (depending upon how the debt class has been set up on your system).

Non-Billed Budgets differ from other service agreements in the following ways:

- Non-Billed Budgets have a special role of Non-Billed Budget.
- Non-Billed Budgets have scheduled payments.
- Non-Billed Budgets maintain a list of covered SAs (utility and other service agreements to which the Non-Billed Budget applies)
- Non-Billed Budgets are started and maintained on a separate transaction (refer to [Non-Billed Budget - Main](#) for more information).

Which SAs Are Covered By A Non-Billed Budget?

A Non-Billed Budget can apply towards one or more of the account's billable SAs whose SA type is flagged as Eligible for Non-Billed Budget. SAs can be added to or removed from a Non-Billed Budget at any time. Additionally, an SA can be linked to more than one Non-Billed Budget as long as the Non-Billed Budgets to which it is linked do not have overlapping start and end dates.

A list of the SAs covered by a non-billed budget is maintained with the Non-Billed Budget SA. This list is used at bill completion to determine the financial transactions that should occur.

Non-Billed Budgets Versus Other Plans For Payment

Unlike a regular budget but like a payment plan, a Non-Billed Budget has one or more scheduled payments. However, unlike payment plans, bills are not produced for the scheduled payment amounts. Instead, customers are simply notified of the payment schedule and it is their responsibility to make the scheduled payments. In general, the following statements highlight the differences between Non-Billed Budgets and other payment plans.

- There is a payment schedule that is not dependent on billing, unlike [budget plans](#).
- Non-Billed Budgets are not limited to SAs of a single debt class, unlike [pay plans](#).
- Debt is not transferred from regular SAs to the non-billed budgets, unlike [payment arrangements](#).

WARNING:

Non-Billed Budgets and Budget Plans! An SA should not be on a Non-Billed Budget if it is on a [budget plan](#). A Non-Billed Budget overrides any budget functionality in most cases. However, placing an SA that is on a budget on a Non-Billed Budget may result in indeterminate results. For example, when the Non-Billed Budget is broken, the stop algorithm for the Non-Billed Budget syncs current and payoff balances for those utility SAs that were covered by the Non-Billed Budget.

There Are Two Types Of Non-Billed Budgets

There are two types of Non-Billed Budgets: monitored and unmonitored. As the terms suggest, the difference between monitored and unmonitored Non-Billed Budgets is whether they are monitored by the account debt monitor. However, this also means that monitored and unmonitored Non-Billed Budgets receive different financial treatment by the system.

In general, monitored Non-Billed Budgets have their current balances monitored by the account debt monitor while the current balances of any covered SAs are zero (and therefore don't violate any debt collection criteria). With monitored Non-Billed Budgets, customers make required prepayments that are applied towards their utility bills (until the Non-Billed Budget is stopped). They are responsible for making sure the payments on their Non-Billed Budget are up to date, but they do not have to payoff any balances on covered SAs.

Unmonitored Non-Billed Budgets do not have their current balances monitored by the account debt monitor while the current balances of any covered SAs are maintained and therefore subject to the account debt monitor. When customers are set up on an unmonitored Non-Billed Budget, the payments that they make towards the budget are optional. They are, however, financially responsible for paying the current balances of any covered SAs.

FASTPATH:

Refer to [Financial Transactions For Unmonitored Non-Billed Budgets](#) for detailed information about the financial differences between monitored and unmonitored Non-Billed Budgets.

NOTE:

SA Type Determines Monitored Status. The SA type that you select when setting up a Non-Billed Budget determines whether it is monitored or unmonitored (i.e., it's a setting on the SA type). Your company may choose to implement only monitored non-billed budgets, only unmonitored Non-Billed Budgets, or both.

Navigating To The Non-Billed Budget Maintenance Page

Any of the following methods can be used to navigate to the [Non-billed Budget Maintenance](#) transaction:

- An alert in the [Alert Zone](#) highlights if a Non-Billed Budget exists for the current account. You are transferred to the non-billed budget transaction if you drill down on the alert.
- You can setup an order's [campaign](#) to automatically transfer a user to the Non-Billed Budget transaction whenever an order is completed for a given SA. This might be useful for campaigns that are associated with services that are typically on a Non-Billed Budget.
- A user can setup a [favorite link](#) associated with the Non-Billed Budget transaction.
- Via any of the following menus:
 - Account context menu
 - Service agreement context menu
 - Menu menu

Recommending Scheduled Payments

When creating a Non-Billed Budget, you must select a recommendation rule. The recommendation rule establishes the amount to be paid and the dates on which the payments are due. In other words, the recommendation rule creates a recommended payment schedule.

The recommendation rules that you can use are specific to your implementation. The recommendation rule that you select can have default values for its parameters. If your implementation allows, you can manually override one or more of these default values. For example, you may be able to specify the period covered by the Non-Billed Budget and the day of the month on which the payments are due.

If your implementation allows, you can manually modify the recommended payment schedule to suit the needs of a particular customer.

FASTPATH:

Refer to [Designing Recommendation Rules](#) for more information.

Maintaining Non-Billed Budgets

Non-Billed Budget service agreements are started and maintained on a different transaction than other SAs. The topics in this section explain how to start and maintain Non-Billed Budgets.

Non-Billed Budget - Main

The Main page contains basic information about the Non-Billed Budget. Open **Menu > Customer Information > Non-Billed Budget > Search** to maintain this information.

Description of Page

Non-Billed Budget SA (service agreement) information and **SA ID** are displayed on each page. These values only appear after the service agreement exists on the database. The **SA ID** is a system assigned random number that stays with a service agreement for life. The **Non-Billed Budget SA** information is a concatenation of important details about the service agreement and its account.

The **Account ID** is identification of the account that is financially responsible for the service agreement.

Indicate the **CIS Division** and **SA Type**. These fields control aspects of the service agreement's behavior, such as whether the Non-Billed Budget is monitored or unmonitored. These fields are gray when the status is not Pending Start.

NOTE: If the service agreement's account's CIS Division's **Restrict to Account CIS Division** flag is set to *Restricted*, the CIS Division is set to the account's CIS Division and cannot be changed.

FASTPATH:

For more information about Non-Billed Budget SA types, refer to [Defining Non-Billed Budget Options](#).

If **Scheduled Payment Auto Pay** is Included in Auto Pay and the account is set up for automatic payment, the scheduled payments are covered by auto pay. If Excluded from Auto Pay, the scheduled payments are excluded from auto pay if it is set up for the account.

Recommendation Rule is used to create a recommended payment amount and payment schedule. The SA type controls which recommendation rules are allowed for the Non-Billed Budget SA.

Current Balance indicates the amount the customer currently owes on the Non-Billed Budget. If the Non-Billed Budget is unmonitored, the current balance is always zero.

Payoff Balance displays the total amount the customer would owe if they wanted to close the service agreement. For Non-Billed Budgets, the payoff balance typically represents an accumulated credit that has not yet been distributed to the covered SAs (at bill completion time or when the Non-Billed Budget is stopped).

The **Start Date** defines when the financial relationship begins. The **End Date** is a display only field that indicates when the financial relationship terminates. The **Expiration Date** is the date on which the SA expires. The **Renewal Date** is the date on which the SA is scheduled to be renewed by the SA renewal background process. If the SA is not renewed by the expiration date, the stop process is initiated.

The **Recommendation Rule Parameter Values** grid specifies the parameters and their values to use for the selected recommendation rule:

- **Parameter** is the name of the parameter from the recommendation rule algorithm type.
- **Value** is the value used for the parameter. If the recommendation rule allows, you can override the default values by specifying your own.

NOTE:

The recommendation rule's payment schedule algorithm type (NBPS-MON) controls the number and type of parameters. The recommendation rule controls the default values and whether they can be overridden.

The **Covered Service Agreements** grid lists the utility and other SAs that are on the Non-Billed Budget. You must create the list of covered SAs before the recommendation rule can recommend a payment amount and list of scheduled payments. The grid displays the **SA ID**, **SA Information**, **Current Balance** and **Payoff Balance** for covered SAs.

The scheduled payments grid displays the scheduled payments created by the recommendation rule (after you click the Recommend NBB button). You can manually create or modify the **Scheduled Date** and or **Scheduled Amount** of any scheduled payment in the list. The **Total of Scheduled Payments** shows the total of all scheduled payments in the list.

FASTPATH:

Refer to [Scheduled And Actual Payments On The Non-Billed Budget](#) for more information on what occurs when the base [Non-Billed Budget scheduled payment background process](#) processes scheduled payments that are due.

In the Action grid:

- Click **Recommend** to create a recommended payment schedule based on the recommendation rule.
- Click **Renew** to manually renew the Non-Billed Budget. This executes the SA renewal algorithm for the SA type and returns new renewal and expiration dates for the SA.
- Click **Break** to manually cancel the Non-Billed Budget. This executes the break Non-Billed Budget algorithm defined for the SA type, and changes the status of the SA to pending stop.

Non-Billed Budget - History

The Financial History page displays the Non-Billed Budget's historical financial transactions. Open **Menu > Customer Information > Non-Billed Budget > Search** and navigate to the **History** page to view this information.

Description of Page

Non-Billed Budget SA (service agreement) information and **SA ID** are displayed on each page. These values only appear after the service agreement exists on the database. The SA ID is a system assigned random number that stays with a

service agreement for life. The Non-Billed Budget SA information is a concatenation of important details about the service agreement and its account.

The **Account ID** identifies who is financially responsible for the service agreement.

The grid shows the Non-Billed Budget's financial history in reverse chronological order, including:

- The **Arrears Date** is used to compute how many days old the debt is. For monitored Non-Billed Budgets, debt refers to the scheduled payment amounts (i.e., the customer only owes the scheduled payment amounts up to the most recent scheduled payment date). The arrears date for a schedule payment is the scheduled payment date.
- **Financial Transaction Type** displays the type of financial transaction except for adjustments. For adjustments, the adjustment type's description is shown.
- **Current Amount** is the effect of the FT on the service agreement's current balance.
- **Current Balance** is the amount owed by the customer at the time of the transaction.

How To

The topics in this section describe how to perform common Non-Billed Budget functions.

How To Start A Non-Billed Budget Service Agreement

To set up a new Non-Billed Budget:

- Navigate to the Non-Billed Budget maintenance page.
- If the account is not already specified, select the **Account** for which you want to start the Non-Billed Budget.
- Define the **CIS Division** and **SA Type** to use for the Non-Billed Budget service agreement.
- If necessary, change the **Start Date** (the current date is defaulted).
- Select the **Recommendation Rule** to use and modify any of the default parameters to meet the needs of the customer.
- Verify the list of **Covered Service Agreements**. All the account's SAs that are eligible for Non-Billed Budget are listed. Click  to remove unwanted SAs from the list.
- Click **Recommend**.
- On the pop-up dialog, specify the **Schedule Start Date** and click **Recommend**.
- Make any necessary changes to the expiration date, renewal date and scheduled payments grid and click Save.

How To Cancel / Stop Non-Billed Budget SAs

To stop a Non-Billed Budget:

- Navigate to the Non-Billed Budget maintenance page.
- If the account with the Non-Billed Budget you want to stop is not specified, select the **Account** of the Non-Billed Budget you want to stop.
- If the account has more than one Non-Billed Budget SA, select the Non-Billed Budget you want to stop.
- Click **Break**.

How To Renew Non-Billed Budgets

Most Non-Billed Budgets are renewed automatically by a background process. However, you may manually renew Non-Billed Budgets that are eligible for renewal if desired.

To renew a Non-Billed Budget:

- Navigate to the Non-Billed Budget maintenance page.
- If the account with the Non-Billed Budget you want to renew is not specified, select the **account** of the Non-Billed Budget you want to renew.
- If the account has more than one Non-Billed Budget SA, select the Non-Billed Budget you want to renew.
- If desired, change the recommendation rule or any of the parameters.
- Click **Renew**.

The new expiration and renewal dates are calculated and the new payment schedule is appended to the list of scheduled payments.

How To Set Up Automatic Payment For A Non-Billed Budget

If a customer wants to pay their non-billed budget scheduled payments automatically:

- Set up the account for automatic payment (as described under [How To Set Up A Customer To Pay Automatically](#)).
- Navigate to the Non-Billed Budget Maintenance page and select the Non-Billed Budget for the account.
- Set the **Scheduled Payment Auto Pay** field to indicate that the scheduled payments are Included in Auto Pay.

Case Management

NOTE:

Separate module. The Case Management functionality is associated with a separate Case Management module. If this module is not applicable to your business you may turn it off. Refer to [Turn Off A Function Module](#) for more information.

Your organization can use case management functionality to manage a variety of situations, such as:

- a high-bill complaint,
- a bankruptcy,
- an inspection of a premise,
- a customer's request for literature,
- a contractor's request to extend a line,
- a customer's rejection of a quote,
- a customer's request to change information on a future date,
- the processing of a market message in a deregulated environment

NOTE:

Your implementation controls how your cases behave. Since virtually all aspects of case management functionality are controlled by your implementation, you can use it to handle a myriad of business requirements. Refer to [Defining Case Management Options](#) for the details.

Background Topics

The topics in this section provide background information about case management functionality.

Case Type

A case is controlled by the case type that it references. Some aspects of the case that are controlled by the case type include:

- The [lifecycle](#) of the case
- The [applicability](#) of a person, account, and/or premise on the case
- Which [fields are required](#) during the various stages of a case's life
- Which users can [access cases](#) of a given type
- Additional processing that should take place when a case enters or leaves a given state

Refer to [Case Type Controls Everything](#) for a description of the business rules that you control when you set up your case types.

Creating Cases

To create a case, open the [case management](#) page in add mode, select the appropriate case type, fill in the other necessary fields, and click save. Oracle Utilities Customer Care and Billing also includes scripts that can help create cases. Refer to [Scripts and Cases](#) for more information.

You can also develop plug-ins and user exits to so that the system will create cases when specific events take place. For example, you could set the system to create a case when an umbrella agreement is ready for renewal or when a quote is created.

Please refer to [Maintaining Cases](#) for a detailed description of the case page and field descriptions.

Log Information

A case log contains an entry for every recorded event during the lifecycle of the case. There are two types of log entries:

- **Automatic entries.** The system automatically creates an entry in the log when a case is created or there is a [status change](#). Users cannot modify or delete these log entries.
- **Manual entries.** Users can add manual entries to record significant events at their discretion.

Refer to [Case - Main](#) for the page used to view the log.

Refer to [Case Statistics for a Given Status](#) for information about a report that uses the log to provide productivity statistics.

Alerts

The [alert zone](#) will highlight if the person / account / premise in context have cases in a state that is configured as "alertable" if you plug-in the appropriate algorithm on the installation record. Refer to [Alert Info Is Controlled By An Installation Plug-In](#) for the details.

To Do's and Cases

You can configure the system to inform users of cases that require their attention. Refer to [To Do's and Cases](#) for the details.

Reports

Several reports summarize case information. Refer to the [Reports](#) chapter for the details.

Maintaining Cases

Your organization can use the case management functionality to manage a variety of situations, such as:

- a high-bill complaint,
- a bankruptcy,
- an inspection of a premise,
- a customer's request for literature,
- a contractor's request to extend a line,
- a customer's rejection of a quote,
- a customer's request to change information on a future date,
- the processing of a market message in a deregulated environment

NOTE:

Since an implementation can configure virtually every aspect of a case, the look and feel of the case management page are dynamic based on how [case types](#) have been configured.

Case - Main

Open the case management page by selecting **Menu > Customer Information > Case > Search**.

Main Information

Case Info contains a concatenation of important information about the case. **CaseID** is the system-assigned unique identifier of the case. These values only appear after the case is added to the database.

NOTE:

Formatting may be performed by a plug-in. Refer to [Case Info May Be Formatted By An Algorithm](#) for more information.

Case Type defines the type of case. This field is protected after the case has been added. Refer to [Case Type Controls Everything](#) for more information.

NOTE: Available case types can be restricted by CIS Division. The restriction of case type by CIS division is dynamic. It is based on the account in context, the premise in context, or the current user. The restriction of case type is applied using these rules in sequence.

- If there is an account in context and that account has a CIS Division, that CIS Division is used to restrict the case types that appear.
 - If there is a premise in context and that premise has a CIS Division, that CIS Division is used to restrict the case types that appear. Note: If there are both an account and premise in context, the account CIS Division is used.
 - If there is no account or premise in context with a CIS Division and the current user is associated with CIS Division(s) those CIS Division(s) are used to restrict the case types that appear. See [Users and CIS Division](#) for more information.
-

Status shows the current state of the case. Refer to [Case Lifecycle](#) for more information.

If the case has any To Do entries associated with it, a hyperlink will appear summarizing the number and status of the entries. You can select the link to view these entries. Refer to [To Do's and Cases](#) for more information.

Date / Time Opened shows when the case was created. If the case is in a final state, the **Date / Time Closed** will also be shown. Refer to [One Initial State and Multiple Final States](#) for more information.

Script references the business process assistant script that can help you work on the case. You can click on the hyperlink to execute this script. This field is hidden if no script is associated with this case's current Status. Refer to [Scripts and Cases](#) for more information.

The **Actions** section contains buttons you can use to action the case. This area is suppressed if no actions can be performed for the case given its current status. A button will be gray if you do not have security rights to the action. Refer to [Buttons Are Used To Transition A Case](#) for more information.

When the user adds a new case or changes the state of a case manually the system attempts to auto-transition the case to subsequent statuses as necessary. If auto-transition rules apply to the new state (and to subsequent ones) they would be executed right away. If the case has been automatically transitioned to its current state the following message area appears right after the action area. If an error is encountered in the process a corresponding error message is displayed in the Auto-transition Message Area. Refer to [Automatic Transition Rules](#) for more information.

NOTE:

The Auto-transition Message Area only appears when a case has just been automatically transitioned to its current state online. It only remains visible until the data for the case is refreshed.

Use the **Comments** area to describe anything interesting or unusual about the case.

Person references the person associated with this case. This field is suppressed if the Case Type indicates that a person is not allowed on cases of this type. This field is protected if the case is closed (i.e., if its status is defined as being final). This value is defaulted to the Person currently displayed in the Dashboard.

Account references the account associated with this case. This field is suppressed if the Case Type indicates that an account is not allowed on cases of this type. This field is protected if the case is closed (i.e., if its status is defined as being final). This value is defaulted to the Account currently displayed in the Dashboard.

Premise references the premise associated with this case. This field is suppressed if the Case Type indicates that a premise is not allowed on cases of this type. This field is protected if the case is closed (i.e., if its status is defined as being final). This value is defaulted to the Premise currently displayed in the Dashboard.

NOTE:

The case type controls the relationship validation among person, account, and premise.

Responsible User references the user who has overall responsibility for the case. This field is suppressed if the Case Type indicates that a responsible user is not allowed on cases of this type. This field is protected if the case is closed (i.e., if its status is defined as being final).

The **Contact Information** area is used to define how to contact the individual who initiated the case. These fields are suppressed if contact information is not allowed on cases of this type. The fields cannot be modified if the case is in a closed status. The following information can be defined.

Contact Person references the person who should be contacted. This defaults to the Person defined above.

Preferred Contact Method indicates how the person prefers to be contacted. The following options are available:

- Not Applicable. If the person doesn't want to be contacted (or the contact method is unusual), use this option. You might want to consider describing the situation in the Contact Instructions.
- Person Contact. If this method is selected, select a person contact related to the Person link to the customer contact. The customer contact must contain a Person to use this method.
- Postal. If this method is selected, the Contact Person's address appears. Refer to [Where Does The Address Come From](#) for a description of which address the system displays.

The following methods appear when the Legacy Person Phone and Email **Option Type** on the Customer Information Options [Feature Configuration](#) has been enabled.

- Email. If this method is selected, the Contact Person's email address appears adjacent.
- Phone. If this method is selected, the Contact Person's phone number appears.
- Fax. If this method is selected, the Contact Person's fax number appears (the system knows which of a person's phone numbers is a fax number by the phone type).
- SMS. If this method is selected, the Contact Person's short message service (SMS) information displays.

NOTE: While on a case, users can add a person contact by selecting Add Person Contact from a Person Context menu. This will open a portal-based page that allows a person contact to be added. This process will not lose context or information that has been added to the case. The new person contact can be used within the case.

Contact Instructions indicates any special instructions indicated for when or how to return a call.

Callback Phone Type, Callback Phone Number, and Extension indicate the actual phone number and phone type that should be used to call.

Characteristics

The **Characteristics** grid contains fields that contain important information about the case. This grid is suppressed if the Case Type does not use characteristics. This grid is protected if the case is closed (i.e., if its status is defined as being final).

You can only choose **Characteristic Types** defined as permissible for this case type. Refer to [Additional Information](#) for more information. If you attempt to use an **Action** to transition a case into a status that requires additional information, a pop-up will prompt you for the additional fields. Refer to [Required Fields Before A Case Enters A State](#) for more information.

Case - Log

To view the log entries associated with a case, open by selecting **Menu > Customer Information > Case > Search** and navigate to the **Log** page.

Description of Page

The **Log** grid displays log entries (in reverse chronological order) that audit the progress of the case. Please note the following about the entries in this grid:

- The system automatically creates log entries when a case is created, every time its status changes, or whenever an error occurs during the transition of a case. Algorithms plugged into a case type state can also be configured to create log entries. You cannot modify or delete the log entries.
- You can manually add a log entry by pressing the + button and enter the **Details**. You cannot modify or delete this information after saving it.
- The following information appears in the grid:
- **Log Date/Time** contains the date and time the log entry was created.
- **Details** contains user-specified or system-generated information about the log entry.
- **Related Object** is populated on log entries that were created to record the creation of some other object. For example, if a case plug-in creates a customer contact, the related object contains information about the customer contact. Please note that if the object description is shown in blue, you can click on the object's description to drill down to the object.
- **Log User** contains the user who caused the log entry to be created.
- **Log Type** indicates how the log entry was created. The possible values are:
 - Created. Only one entry per case will be of this type. This entry is automatically created by the system when the case is created.
 - User Details. A user creates this type of entry manually.
 - Status Transition. This type of entry is created by the system each time the case's status is changed (as a result of pressing one of the Action buttons).
 - System. An algorithm on the case type state may be designed/configured to create this type of entry when it does something auditable. For example, an algorithm that creates a customer contact could insert a log entry to show that it did this (it will also populate the FK to the customer contact, which will appear in the **Related Object** column).
 - Transition Error. The background status transition process creates an entry of this type if an error occurs when automatically updating a case to a subsequent status (as directed by either an Enter Status algorithm or an Auto-Transition algorithm). An entry of this type lists the case states involved with the failed transition, and the algorithm in which the error was generated.
 - Exception. The background status transition process creates an entry of this type under the same circumstances as a Transition Error. A log entry of this type indicates why the background transition failed.

NOTE:

The values for this field are customizable using the Lookup table. This field name is CASE_LOG_TYPE_FLG.

Premise Management

NOTE:

Separate module. The Premise Management functionality is associated with a separate Premise Management module. If this module is not applicable to your business you may turn it off. Refer to [Turn Off A Function Module](#) for more information.

The premise management functionality facilitates the following:

- Grouping premises together under a single parent premise

- Quick & efficient setup and maintenance of apartment complexes and high-rises
- A single view of properties for a landlord, including service status
- Ability to change the landlord or service status for a group of premises in one transaction
- And more...

The topics in this section describe premise management functionality.

Overview

The topics in this section provide background information about premise management functionality.

Define Premise Hierarchy

Premise management allows you to define premise hierarchy. For example, you could also have the notion of

- A building
- Multiple floors
- Multiple apartments per floor

To define this hierarchy you must create a [premise](#) for each level in the hierarchy and for each "child" premise, indicate its appropriate parent premise. Once you have set up your premise hierarchies, you may view the hierarchies on trees on the premise page and on the control central [premise tree](#).

In addition, the system provides the following [alerts](#):

- When viewing a parent premise, an alert indicates how many child premises exist
- When viewing a child premise, an alert indicates that it is linked to a parent premise.

Manage Premises for a Landlord

The premise management page provides the ability to view all the premises for the landlord along with information about the accounts linked to each premise.

You may use this page to assign, change or remove the landlord agreement for multiple premises in a single action. For example if a landlord sells their properties to another person, this page facilitates updating all premises with one action rather than changing the landlord for each premise separately. For example, if the landlord sells only a portion of their properties.

This page may also be used to start or stop service for one or more premises for the landlord. For example, a landlord plans to sell a high-rise apartment complex with 100 apartments. Imagine that 8 of these apartments are vacant and the landlord's account is currently paying for any usage to these apartments. In addition to changing the landlord agreement for all 100 apartments to the new landlord, the service for the vacant apartments should be transferred to the new landlord. A user can go to premise management, use the search criteria to view all premises for this landlord in a given apartment complex whose service is currently being paid for by the landlord and start service for these premise for the new landlord. (Using the back-to-back start/stop functionality, service will be stopped for the old landlord.)

Manage Groups of Premises

The powerful search criteria on the premise management page allows you to view different groups of premises based on any combination of account information, landlord information, parent premise address information and general geographic type information. You may also define search criteria such as "premises **not** linked to account 1234567890" or "premises linked to **any** landlord" or "premises **not** linked to any parent premise". For example, you could display all premises in a given latitude / longitude that are not linked to any parent premise.

Once your search results display the desired list of premises, you could perform mass updates such as assigning a parent premise or starting service. Following are examples of situations where this page would be helpful:

- The developer of a high-rise condominium complex is ready to start service for a group of condos. A user uses the premise management search criteria to display the premises linked to a give parent premise (representing the condo complex) that are not linked to any account. The user selects the premises in this list that the developer would like to start and starts service for all premises at once.
- There is a shopping mall in your service territory and each store in an individual premise. You may decide to define a parent premise for the entire shopping mall and link each store's premise to the parent. Once the parent premise is defined, a user navigates to the premise management page and displays the individual premises based on a similar address or based on a similar geographic type. The user then assigns the parent premise for all the individual premises using a single action.

Premise Management Page

This page allows you to display a list of premises using a combination of search criteria. In addition, you can perform actions on one or more of the resulting premises, including:

- Assigning a parent premise to one or more premises
- Removing the link to a parent premise from one or more premises
- Assigning a landlord to one or more premises
- Removing the link to a landlord from one or more premises
- Start service for one or more premises
- Stop service for one or more premises

Open this page using **Menu > Customer Information > Premise Management**.

Description of Page

The top half of the page is where you enter the criteria used to search for premises.

NOTE:

Multiple search criteria may be specified. You can search for premises using a combination of search criteria. For example, if you enter both a **Parent Premise Filter** of Linked To Any Premise and an **Account Filter** of Not Linked to Any Account; only those premises that have a parent premise but are not linked to an account will be displayed.

At least one positive criterion is required. You may not define your search criteria to only use filter values that start with "Not Linked...". At least one "positive" filter value is required.

The following table describes each of the different search methods.

Search Method	Description
Landlord Filter	Use this filter to narrow down your search based on landlord. Enter one of the following values: Not Applicable

	<p>Linked To This Landlord - for this option, you must enter a Landlord Agreement</p> <p>Not Linked To This Landlord - for this option, you must enter a Landlord Agreement</p> <p>Linked To Any Landlord</p> <p>Not Linked To Any Landlord.</p> <p>A filter value of Not Applicable defaults.</p>
Parent Premise Filter	<p>Use this filter to narrow down your search based on parent premise. Enter one of the following values:</p> <p>Not Applicable</p> <p>Linked To This Parent Premise - for this option, you must enter a Premise ID for the parent premise</p> <p>Not Linked To This Parent Premise - for this option, you must enter a Premise ID for the parent premise</p> <p>Linked To Any Parent Premise</p> <p>Not Linked To Any Parent Premise.</p> <p>A filter value of Not Applicable defaults.</p>
Account Filter	<p>Use this filter to narrow down your search based on account. Enter one of the following values:</p> <p>Not Applicable</p> <p>Linked To This Account - for this option, you must enter an Account ID</p> <p>Not Linked To This Account - for this option, you must enter an Account ID</p> <p>Linked To Any Account</p> <p>Not Linked To Any Account.</p> <p>A filter value of Not Applicable defaults.</p>
Premise Filter	<p>Use this filter to narrow down your search based on account. Enter one of the following values:</p> <p>Located At This Address - for this option, you must enter address constituents</p> <p>Located At This Geographic Type / Value - for this option, you must enter a Geo Type and Value</p> <p>Not Applicable</p> <p>Show This Specific Premise - for this option, you must enter a Premise ID</p> <p>A filter value of Not Applicable defaults.</p>

The **Select All / Clear All** buttons are used to select premises if you plan on issuing any of the mass update actions at the bottom of the page. Refer to the description of the "mass update" actions below for more information.

NOTE:

50 premises at a time. Clicking **Select All** selects the first 50 premises in the grid. If more than 50 premises exist, you must select them in batches.

The grid that follows contains the premises that match your search criteria. The following information appears in the grid:

- Select box. Use this checkbox to select premises for mass update actions.
- The **Premise Information** column shows information about each premise. Click the hyperlink to transfer to the [Premise](#) page where you can update information about the premise in question.
- The **Account Information** column shows information about all accounts linked to the premise, if any. Only accounts with non-canceled, non-closed service agreements linked to this premise are displayed. The column displays the name of the customer's main person followed by a list of status values for any of the account's service agreements linked to this premise. For example, you may see Customer A (pending stop), Customer B (pending start). If multiple service agreements linked to the account & premise have the same status, the status is only displayed once.
- The **Parent Premise Information** column displays information about the premise's parent premise, if one exists.
- The **Landlord Information** column displays the landlord agreement description for the premise's landlord, if there is one.

This transaction has sophisticated logic that can be used to perform "mass updates" to the premises that appear in the grid using the buttons at the bottom of the page. The buttons are enabled if you select at least one row from the premise grid. The following points describe these mass update actions:

Start Service

The **Start Service** button is used to start service for one or more premises. When clicked, the **Start SA Groups Confirmation** window opens.

NOTE:

Similar to Start/Stop. This page is similar to the Start SA Confirmation page that appears on start/stop. The differences are to accommodate starting multiple premises.

In order to start service for the selected premises, select the **Account ID**.

The **Start Date** is the date on which the service is scheduled to start.

Use **Start Requested By** to indicate the name of the person who requested the start.

Check **Include Child Premises** if all the child premises in the hierarchy below the selected premises should also be started for this account.

Click **Show SA Groups** to populate the remainder of the page.

The **Service Points** section summarizes the service points that exist for all the chosen premises. A row is displayed for each different **SP Type** along with a **Count** of the number of service points of that type. By default, all rows are checked, assuming that you want to start service for all service points (and the SA Groups To Start scroll below displays proposed SAs to start for each SP type). You may uncheck any SP Type row if you do not wish to start service for that SP type. Click **Show SA Groups** to rebuild the SA Groups To Start information.

WARNING:

This page displays summary information about the service agreements and service points that are being turned on. It is recommended that you start groups of premises that have similar service point configurations. If you attempt to start service for many premises, each with different service point configurations, the start logic may be very complicated to verify on this page.

The **SA Groups To Start** scroll contains an entry for every service agreement that will be created if you click the **Start** button. If you do not want a service agreement to be created, click the - button or uncheck **Start this SA Group**. If you would like to start service agreements that are not SP-based service agreements (for example a deposit or a connection charge), click the + button to add a new SA group. The system assumes that you want to create a new service agreement for each selected premise.

Turn on the **Start this SA Group** switch if you want service agreements of this type to be created. If this is the first customer at the selected premises, this switch is checked for all service agreements that appear in the scroll. For each premise that was linked to a previous customer, this switch is on only for those types of service agreements used by the previous customer(s). (We assume the new customers only want the services used by the previous customers). Service agreements that are possible, but were not used by the previous customers, appear in the scroll with this switch turned off.

If Start This SA Group is checked, the system displays a message indicating the number of service agreements (for the number of service points) that will be created if you choose Start.

For a description of the remaining fields, refer to [Start/Stop - Start Confirmation](#).

Click **Start**. Standard [start](#) logic is followed when clicking start.

NOTE:

The start button is disabled if changes are made to fields on the page that may impact the SA Groups To Start collection. You must click **Show SA Groups** to rebuild the SA groups and enable the start button.

Stop Service

The **Stop Service** button is used to stop service for one or more premises.

NOTE:

that this functionality stops service for any account linked to the selected premises. If you want to stop service at the selected premises for only certain accounts, use the account filter criteria to narrow down the selection of premises prior to clicking Stop Service.

When clicked, the **Stop SA Group Confirmation** window opens.

In order to stop service for the selected premises, enter a **Stop Date**.

Enter a **Restrict to Account** if you want to stop only service agreements linked to this account. If not specified, all active services agreements for the premise are stopped regardless of the account.

Use **Stop Requested By** to indicate the name of the person who requested the stop.

Check **Include Child Premises** if the child premises in the hierarchy below the selected premises should also be stopped.

Click **Show SA Groups** to populate the remainder of the page.

The system builds a collection of service agreements currently linked to the service points for the selected premises. The grid contains the **CIS Division** and **SA Type** for each SA "group" and displays the number of service agreements in the **SA Group Summary**.

By default, the system checks each SA group assuming that you want to stop service for all SAs. You may uncheck any of the SA groups to not stop service for those SAs.

Click **Stop**. Standard [stop](#) logic is followed when clicking stop.

NOTE:

The stop button is disabled if changes are made to fields on the page that may impact the SA collection. You must click **Show SA Groups** to rebuild the SA collection and enable the stop button.

Assign Parent Premise

The **Assign Parent Premise** button is used to assign a parent premise to one or more premises. When clicked, the **Assign Parent Premise** window opens.

Specify the **Parent Premise ID** and click **Assign**.

Remove Parent Premise

The **Remove Parent Premise** button is used to remove the parent premise from one or more premises. When clicked, the parent premise ID of all selected premises is reset.

Assign Landlord

The **Assign Landlord** button is used to assign a landlord to one or more premises. When clicked, the **Assign Landlord** window opens.

Specify the **Landlord** agreement ID.

Check **Include Child Premises** if the child premises in the hierarchy below the selected premises should also be assigned this landlord.

Click **Assign**.

Remove Landlord

The **Remove Landlord** button is used to remove the landlord agreement from one or more premises. When clicked, the **Remove Landlord** window opens.

Check **Include Child Premises** if all the child premises in the hierarchy below the selected premises should also have their landlord agreement removed.

Click **Remove**.

Umbrella Agreement Management

Your organization may use umbrella agreement functionality to manage many situations, including (but not limited to) the following:

- Creating a "negotiated contract" with a large customer with many sites.
- Creating a "negotiated contract" with all customers in a common geographic area, for example a specific city or an apartment complex
- Grouping and managing the proposal service agreements created during the quoting process
- Managing the renewal process for special contracts
- Applying override rate terms to one or more service agreements for a given effective period
- more...

NOTE:

Separate module. The umbrella agreement functionality is part of the Contract Management module. If this module is not applicable to your business you may turn it off. Refer to [Turn Off A Function Module](#) for more information.

Overview Of Umbrella Agreement & Terms Of Service

An umbrella agreement is used to group together terms for a contract. It contains high level information about the contract such as the effective dates, the renewal date, if applicable and an account management group, if applicable. You may also define characteristics and [contacts](#) for the umbrella agreement.

The terms of the umbrella agreement are defined using one or more terms of service (TOS) records. For each TOS record, you must link one or more service agreements to indicate the services covered under the TOS.

UA

ID: 41786547792 Des cr: McDonald's Contract
 UA Type: Large Cust Contract Period: 01-Oct-04 – 03-Sep-04

Terms of Service ID: 4553269781
 Des cr: Grouping of McDonald's electric services
 TOS Type: Electric Template SA: n/a

SA	Description
3994822544	CA/E-COM, ECOM-1, Active, 8-1-98
3994829303	CA/E-COM, ECOM-1, Active, 2-14-99

Covered Entity	Value	Description
Person	1548779358	McDonald's Corp
Service Type	E	Electric

Terms of Service ID: 455324166
 Des cr: Grouping of McDonald's gas services
 TOS Type: Gas Template SA: n/a

SA	Description
3994827536	CA/G-COM, GCOM-1, Active, 8-1-98
3994822521	CA/G-COM, GCOM-1, Active, 2-14-99

Covered Entity	Value	Description
Person	1548779358	McDonald's Corp
Service Type	G	Gas

The Terms of Service may point to a 'template service agreement' as a way to specify the rating terms and conditions to be used by all service agreements linked to the TOS. If a TOS does not define a template SA, then the TOS is used largely as a grouping mechanism rather than a billing mechanism.

Umbrella agreements and their terms of service records are used to support specific business scenarios that your organization supports.

TOS Covered Entities

Your implementation may configure a Terms of Service type to require that entities "covered" by the terms of service record be referenced on the TOS. For example, imagine that you define an umbrella agreement to provide special discounts to all the McDonalds franchises in your service area. When creating the terms of service record for the umbrella agreement, you may link the person record representing the McDonalds corporate entity as a covered entity for the TOS.

NOTE:

that there is no base product functionality that uses this collection. However, your implementation may use this information in an algorithm, for example, it could be used in a campaign / package eligibility algorithm.

Refer to [Terms Of Service Covered Entities](#) for information about defining covered entities for a terms of service type.

Rate Terms Overridden By Terms Of Service

Your organization may require rate information to be temporarily overridden for a service agreement that is linked to a TOS. In order to do this, the TOS record must reference a template SA. Refer to [Overriding Rate Terms](#) for information about defining your Terms of Service types to support template service agreements.

The topics in this section further describe the possible rate term overrides that may occur when a service agreement is linked to a terms of service record.

Rate Schedule Override by TOS

If a service agreement is linked to a terms of service, you may configure the system to use the rate schedule from the terms of service record's template SA rather than the one from the customer's service agreement. The customer's SA type controls this option.

FASTPATH:

Refer to [Configure SA Types for Umbrella Agreements](#) for more information.

If a service agreement is linked to a terms of service record, the rate information tree on the service agreement's rate info tab tells the user whether the rate from the service agreement or from the template SA on the TOS is currently applicable.

If a given service agreement's rate schedule is being taken from the terms of service record's template SA, then the override rate schedule is used not just in bill calculations, but for any logic that requires the service agreement's rate schedule. For example, one of the recommended budget amount algorithms may estimate consumption and apply the service agreement's rate. In this case, the rate used by the algorithm is the one linked to the terms of service record's template SA.

Override Of Other Rate Terms By TOS

There are other terms associated with a rate that may change when linking a service agreement to a terms of service record that has a template SA. These include contract riders, contract terms and tax exemptions.

When applying the rate to create the customer's bill segment, if a bill factor on any of the calculation rules indicates that it is eligible for tax exemptions, contract terms or contract riders, a flag on the bill factor indicates where the system should look for the appropriate value. The Terms of Service Usage flag tells the system to find applicable information either on the TOS's template SA only, on the customer's SA only or it should first check the TOS, then check the customer's SA.

FASTPATH:

Refer to [Configure Bill Factors for Umbrella Agreements](#) for more information.

NOTE:

Independent of rate source. The flag values on the bill factors are independent of the rate source setting for the SA type. For example, your implementation may configure the SA type's rate source to indicate that rate should be taken from the TOS template SA. However, if a bill factor is eligible for tax exemptions, your implementation may configure the bill factor to indicate that the exemption information should be taken from the customer's SA, not the template SA.

Umbrella Agreement Renewal

Although umbrella agreement records require an end date, your organization probably allows for renewal of agreements. A renewal may involve full re-negotiation of all terms, or may be as simple as extending the current terms. If umbrella

agreements of a given type are eligible to be renewed, you configure the UA type to indicate how to calculate the renewal date and which algorithm to execute when the renewal date is reached.

Umbrella Agreement Renewal Background Process

The UA renewal background process ([UARENEW](#)) finds complete umbrella agreements whose renewal date has arrived and executes the renewal algorithm for the associated UA type.

NOTE:

It is the responsibility of the renewal algorithm to update the renewal date as per the business practice. Refer to [Renewable Umbrella Agreements](#) for more information.

Umbrella Agreements & Proposals

Umbrella agreements and their terms of service records may reference proposal service agreements. This functionality allows you to create the full contract for your customer during the quoting stage.

Additional Umbrella Agreement Topics

The following topics describe additional functionality related to umbrella agreements.

Umbrella Agreement Alerts

The [alert zone](#) will highlight if any of the account's SAs are linked to an effective umbrella agreement (via a non-canceled terms of service record).

Orders And Umbrella Agreements

When starting new service for a given account and premise, you may know ahead of time that the new service should be linked to an existing umbrella agreement. For example, perhaps all the service in a specific low income housing area qualifies for a special negotiated contract for the next year.

The system provides algorithms to allow you to add a new service agreement to an existing terms of service record when using the [Order](#) transaction to start service.

Refer to [Configure A Campaign To Link An SA To A Terms Of Service](#) for more information.

Umbrella Agreement Reports

The system supplies a [Report](#) providing umbrella agreement information for one or more umbrella agreements.

Umbrella Agreement Maintenance

Umbrella agreements help you manage your contracts by allowing you to group together service agreements for the contract with one or more terms of service records for the umbrella agreement.

Lifecycle Of An Umbrella Agreement

The following diagram illustrates the lifecycle of an umbrella agreement.

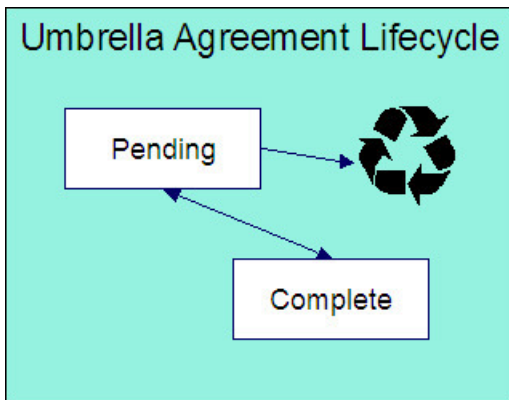

Pending The umbrella agreement is created in pending status.

You may delete a pending umbrella agreement. Deleting a UA also deletes its terms of service records.

Complete Only complete umbrella agreements are considered effective. You may transition a UA to complete if there is at least one terms of service record linked to it and if none of its TOS records are in pending status.

Under unusual circumstances, a complete umbrella agreement may be changed back to pending to correct errors.

Umbrella Agreement - Main

Open this page using **Menu > Umbrella Agreement Management > Umbrella Agreement > Search.**

Description of Page

Umbrella Agreement Info contains a concatenation of important information about the umbrella agreement. **Umbrella AgreementID** is the system-assigned unique identifier of the umbrella agreement. These values only appear after the UA is added to the database.

Umbrella Agreement Status shows the current state of the UA. The buttons adjacent to the status allow you to transition the UA's status.

- Click **Complete** to change the status of a pending umbrella agreement to complete.
- Click **Reopen** to change the status of a complete umbrella agreement back to pending.

FASTPATH:

Refer to [Lifecycle of an Umbrella Agreement](#) for more information.

Enter a **Description** for the umbrella agreement.

The **Umbrella Agreement Type** defines the type of umbrella agreement. Refer to [Setting Up Umbrella Agreement Types](#) for more information.

The **Start Date** and **End Date** define the effective dates of the contract. If the UA type is renewable, the **Renewal Date** indicates the date the umbrella agreement is processed by the [renewal background process](#).

You may assign an **AccountManagement Group** to this umbrella agreement. The AMG controls the roles assigned to [To Do entries](#) associated with the umbrella agreement. Refer to [Setting Up Account Management Groups](#) for more information.

Use the **Comments** area to describe anything interesting or unusual about the umbrella agreement.

This bottom of this page contains a [tree](#) that shows the various objects linked to the umbrella agreement. You can use this tree to both view high-level information about these objects and to transfer to the respective page in which an object is maintained.

Umbrella Agreement - Contacts

The contacts page defines persons associated with the umbrella agreement. Open this page using **Menu > Umbrella Agreement Management > Umbrella Agreement > Search** and navigate to the **Contacts** page.

Description of Page

The contacts collection allows you to define persons that are associated with the umbrella agreement. For each contact, define the **Person ID** for the person record that contains the demographic information for the contact. For each contact, use the **Comments** to define information about the contact.

Umbrella Agreement - Characteristics

The characteristics page contains information that describes miscellaneous information about the umbrella agreement. Open this page using **Menu > Umbrella Agreement Management > Umbrella Agreement > Search** and navigate to the **Characteristics** page.

Description of Page

NOTE:

Characteristic Types. You can only choose characteristic types defined on umbrella agreement's [umbrella agreement type](#).

The following fields display:

Characteristic Type Indicate the type of characteristic.

Characteristic Value Indicate the value of the characteristic.

NOTE:

Default Note. An umbrella agreement's characteristics default from the [umbrella agreement type](#).

Terms Of Service Maintenance

A terms of service (TOS) record defines one or more service agreements participating in a given umbrella agreement. The TOS record may also reference a template SA that could be used to override rate terms for the participating service agreements.

Lifecycle Of Terms Of Service

The following diagram illustrates the lifecycle of a terms of service record.

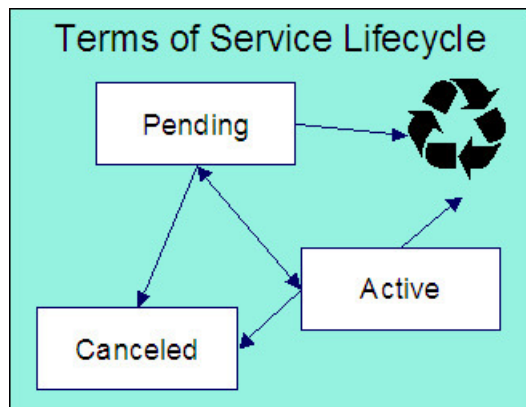

Pending The terms of service record is created in pending status. You may delete a pending TOS. If you want to keep a record of the TOS, you may cancel it rather than deleting it.

Active Only active terms of service records are considered effective. Change the status to active when you have entered all the desired information for this TOS. You may delete an active terms of service if the umbrella agreement is still pending. (Otherwise you must cancel the TOS.)

Canceled You may cancel a pending or active terms of service if it should no longer be used. Canceling a terms of service record unlinks all its service agreements.

Terms Of Service - Main

Open this page using **Menu > Umbrella Agreement Management > Terms of Service > Search**.

Description of Page

Terms of Service Info contains a concatenation of important information about the terms of service record. **Terms of ServiceID** is the system-assigned unique identifier of the terms of service record. These values only appear after the TOS is added to the database.

The **Umbrella Agreement ID** defines the umbrella agreement to which this terms of service is linked.

Status shows the current state of the terms of service record. The buttons adjacent to the status allow you to transition the TOS record's status.

- Click **Activate** to change the status of a pending terms of service record to active.
- Click **Pend** to change the status of an active terms of service record back to pending.
- Click **Cancel** to change the status of a pending or active terms of service record to canceled.

FASTPATH:

Refer to [Lifecycle Of Terms of Service](#) for more information.

Enter a **Description** for the terms of service record.

The **Terms of Service Type** defines the type of terms of service record. Refer to [Setting Up Terms of Service Types](#) for more information.

Use the **Comments** area to describe anything interesting or unusual about the umbrella agreement.

The **Characteristics** collection contains information that describes miscellaneous information about the terms of service record.

NOTE:

Characteristic Types. You can only choose characteristic types defined on the terms of service record's [terms of service type](#).

The following fields display:

Characteristic Type Indicate the type of characteristic.

Characteristic Value Indicate the value of the characteristic.

NOTE:

Default Note. A terms of service record's characteristics default from the [terms of service type](#).

The **Covered Entities** collection allows you to define specific entities that are "covered" by this terms of service record. Refer to [TOS Covered Entities](#) for more information.

NOTE:

Characteristic Types. You can only choose covered entity characteristic types defined on the terms of service record's [terms of service type](#).

The following fields display:

Covered Entity Characteristic Type Indicate the type of characteristic used to define this covered entity type.

Characteristic Value Indicate the value of the characteristic used to define the covered entity value.

NOTE:

Default Note. A terms of service record's covered entity types default from the [terms of service type](#).

Terms Of Service - SAs

This page is used to maintain the service agreements linked to the terms of service record.

Open this page using **Menu > Umbrella Agreement Management > Terms of Service > Search** and navigate to the SAs page.

Description of Page

Terms of Service Info contains a concatenation of important information about the terms of service record. **Terms of ServiceID** is the system-assigned unique identifier of the terms of service record.

The filters control the service agreements that appear in the grid. The following points describe the various options:

- Use the **SA Filter** to define the types of service agreements that appear in the grid. The following options are available:
 - Account. Use this option to restrict service agreements to those linked to a given **Account ID**.
 - Address. Use this option to restrict service agreements to those linked to service points associated with a given **Address, City** and/or **Postal** code. Note, you can specify any combination of these fields.
 - All. Use this option if you do not wish to restrict service agreements based on service agreement attributes.
 - All Proposals. Use this option to restrict service agreements to only proposal service agreements.

- All Real SAs. Use this option to restrict service agreements to only "real" service agreements (i.e., not proposal SAs).
- Geographic Type. Use this option to restrict service agreements to those linked to service points associated with a given **Geographic Type** and **Geographic Value**.
- SA Type. Use this option to restrict service agreements to those linked to a given **CIS Division** and **SA Type**.
- Specific SA. Use this option to reference a specific **SA ID**.
- Use **Status Filter** to restrict the service agreements based on their status. Status values for both proposal service agreements and regular service agreements are included in the filter. The following options are available:
 - All. This option shows all service agreements, including proposal service agreements, regardless of status.
 - Refer to [Service Agreement Lifecycle](#) for the various status values for real service agreements.
 - Refer to [Proposal SA State Transition](#) for more information about status values for proposal service agreements.

Don't forget to click the search button after changing the filters.

The grid that follows contains the **Service Agreements** that match your search criteria along with its **Account Info**.

Use the "+" to link new service agreements to the terms of service record.

NOTE:

Link SA Using Order. You may also [link a service agreement to a TOS through orders](#) if you have configured an appropriate campaign and package.

Note you may remove a service agreement from the TOS using the delete button as long as the change has not been committed to the database. As soon as the SA's link to the TOS has been committed to the database, you must use the **Remove** action to unlink the service agreement.

The **Select All / Clear All** buttons are used to select service agreements if you plan on issuing the mass update action **Remove** at the bottom of the page. Clicking **Remove** removes the service agreement from the terms of service record.

Overdue Financial Obligations

The system periodically monitors how much your customers owe to ensure they haven't violated your overdue rules. When a violation is detected, the system creates an overdue process. The overdue process contains the events meant to prod the customer to pay (e.g., letters, disconnect field activities, To Do entries, write-off outstanding debt, etc.). This section describes how to manage your overdue (i.e., collections) processing.

NOTE:

The overdue processing module has been designed to collect on virtually anything from an unpaid bill to an unmatched financial transaction. You tell the system what you collect on by configuring the various overdue processing control tables. In this release, the base-package is delivered with the algorithms that support collecting on overdue bills. If your organization practices [balance-forward accounting](#) (i.e., collection is based on overdue service agreement balances), you will not use this functionality. Rather, you will use the functionality described under [Credit and Collections](#).

Overdue Processing Background Information

In the section, [The Big Picture Of Overdue Processing](#), we describe how overdue processing works and how to set up the control tables that automate most functions. You will find that many of your questions regarding when and how overdue and cut processes are created and canceled are described in this section.

Overdue Process Maintenance

An overdue process is a series of events (e.g., letters, To Do entries) meant to encourage an account to pay its delinquent debt. The topics in this section describe the pages on which overdue processes are maintained.

FASTPATH:

Refer to [The Big Picture Of Overdue Processes](#) for background information.

Overdue Process - Main

The Main page contains core overdue process information. Open this page using **Menu > Credit & Collection. > Overdue Process > Search**

Description of Page

NOTE:

Refer to [How To Perform Common Overdue Process Functions](#) for more instructions describing how to use this page.

Overdue Process contains a concatenation of important information about the process. **Overdue ProcessID** is the system-assigned unique identifier of the process. These values only appear after the overdue process is added to the database.

NOTE:

Summary information may be overridden. Refer to [Overdue Process Information Is Overridable](#) for how your implementation can override the summary information that appears throughout the system.

Account ID identifies the overdue process's account.

NOTE:

Multiple overdue processes may be linked to an account. It's important to be aware that it's possible for multiple, active overdue processes to be linked to an account. The [Alert zone](#) will contain a summary of the account's overdue processes.

Status defines the state of the overdue process. The following values may exist:

- Active, Events Pending. Overdue processes are initially created in this state. An overdue process remains in this state until there are no Pending or Waiting events.
- Inactive, Canceled by User. An overdue process will exist in this state when it's been manually canceled by a user. Navigate to the **Log** tab to see when this happened and who did it.
- Inactive, Canceled by System. An overdue process will exist in this state when it's been canceled by the system (typically because the overdue obligations were satisfied). Navigate to the **Log** tab to see when this happened.
- Inactive, Completed. An overdue process will exist in this state when the system completes its last event. Navigate to the **Log** tab to see when this happened.

The **Cancel** button appears if the overdue process is Active, Events Pending and the process's **Overdue Process Template** has a Cancel Logic plug-in. Click this button to [cancel the process](#).

The **Trigger Events** button appears if the overdue process is Active, Events Pending. Click this button to activate all pending events that are [ready for activation](#).

NOTE:

If you can't wait for the Overdue / Cut Event Manager to run. The [Overdue / Cut Event Manager](#) is a background process that activates events on their trigger date. If you don't want to wait for this process to run, you can click the **Trigger Events** button on the **Main** tab to activate the process's events (that are ready for activation).

Overdue Process Template defines the template that was used to [create the overdue process's events](#). You can override these events on the **Events** page. This field is unprotected when the process is Active and all events are in either the Pending or Canceled states.

NOTE:

Changing the template. If you change the template, the system will delete the events and replace them with the new template's events.

Start Date/Time defines the start date/time of the overdue process. This field is protected after the overdue process is saved on the database. This field is used to derive the trigger date of some overdue events when the process is first created. Subsequent changes to the start date change the trigger dates on the events accordingly.

Inactive Date/Time is the date and time that the overdue process became Inactive. This field is hidden if the process is Active. You can see more details about when and how the inactivation occurred by navigating to the **Log** tab.

Base Date is reserved for future releases. This field is protected when the overdue process is Inactive.

Enter any **Comments** about the overdue process. This field is protected when the overdue process is Inactive.

The **Collecting On** grid holds the [overdue objects](#). For example, if this process manages overdue bills, the grid contains a list of the bills being collected on by this process. This grid is unprotected when the process is Active. The following points describe the columns that appear in the grid:

- Press the + button to add a new overdue object to the process.
- Press the - button to remove an overdue object to the process.
- The next column contains the unique identifier of the overdue object. For example, if this process manages overdue bills, this column will contain the bill ID. The type of object that's specified in this column is control by the [overdue process template](#).
- **Original Amount** contains the [original amount](#) of the overdue object.
- **Unpaid Amount** contains the [unpaid amount](#) of the overdue object.

The [Trees](#) at the bottom of the page shows a variety of information about the overdue process including its events and cut processes. You can click on hyperlinked tree nodes to navigate to the page on which the related object is maintained.

Overdue Process - Events

This page contains the activities that are performed to persuade the customer to pay the outstanding debt. Open this page using **Menu > Credit & Collection > Overdue Process > Search** and navigate to the **Events** page.

Description of Page

NOTE:

Refer to [How To Perform Common Overdue Process Functions](#) for more instructions describing how to use this page.

Refer to the first tab for a description of **Overdue Process** and **Overdue Process ID**.

The **Overdue Events** scroll contains the process's overdue events. Refer to [Overdue Processes Are Created From Templates](#) for information about how the system defaults a process's events from its template.

- Note, all information in the scroll is protected if the event's Status is Complete or Canceled.
- **Event Sequence** is the unique identifier of the event.
- **Status** defines the [state of the event](#).
- The **Cancel** button appears if the event is Pending or Waiting, and the event's **Overdue Event Type** has a Cancel Logic plug-in. Click this button to cancel the event.
- The **Overdue Event Type** defines the event's activity (e.g., Email sent, a To Do entry is generated, a letter is sent).
- The remaining fields work in unison:
 - If **Dependent on Other Events** is turned on, the event can only be triggered after the events specified in the **Event Dependencies** grid are all Complete or Canceled. You use the **Days After** field to define when this event is activated. For example, if you enter 5, this event will be activated 5 days after all of the dependent events are completed / cancelled. If you enter 0, this event will be activated immediately after the dependent events are completed / cancelled. Refer to [Calendar vs Work Days](#) for a descriptions of how days are counted.

If all dependent events are already Completed or Canceled , you cannot specify **Days After**. Rather, you must enter the desired activation date in the **Trigger Date** field.

- If **Dependent on Other Events** is turned off, enter the desired activation date in the **Trigger Date** field. If this field is off, the **Days After** field and the **Event Dependencies** grid are hidden.

NOTE:

If you can't wait for the Overdue / Cut Event Manager to run. The [Overdue / Cut Event Manager](#) is a background process that activates events on their trigger date. If you don't want to wait for this process to run, you can click the **Trigger Events** button to activate the process's events (that are ready for activation).

Overdue Process - Log

This page contains [log entries](#) that highlight significant events in the process's life. Open this page using **Menu > Credit & Collection > Overdue Process > Search** and navigate to the **Log** page.

Description of Page

Please note the following about the entries in this grid:

- The system automatically creates log entries when significant events occur. Refer to [Overdue Log](#) for more information.
- You can manually add a log entry to an Active process by pressing the + button and enter the **Details**. You cannot modify or delete this information after saving it.
- The following information appears in the grid:
 - **Date/Time** contains the date and time the log entry was created.
 - **Details** contain the user-specified or system-generated information about the log entry.
 - **Relate Object** is populated on log entries that were created to record the creation of some other object. For example, if an overdue event creates a customer contact, the related object contains information about the customer contact. Please note that if the object description is shown in blue, you can click on the object's description to drill down to the object.
 - **Related Process / Event** appears if the log entry was created by an overdue event, a cut process or a cut event. It references the unique identifier of the process / event.
 - **Log User** contains the user who caused the log entry to be created.
 - **Log Type** indicates how the log entry was created. The possible values are:
 - User. A user manually created this entry.

- System. This system created this entry.

How To Perform Common Overdue Process Functions

The topics in this section describe how to perform common overdue process maintenance functions. Refer to [The Big Picture Of Overdue Processing](#) for high-level information about overdue processing.

How To Create An Overdue Process

99.9% of all overdue processes are created by the [Overdue Monitor](#) and require no human intervention. The other 0.1% are created by users on-line / real time. The following points describe how to create the 0.1%.

- Use **Control Central** to choose the account that requires a new overdue process.
- After the account is populated on Control Central, choose the **Overdue Process** + option on the account context menu to transfer to the overdue process transaction in add mode for the account.
- After the [Overdue Process - Main](#) page appears, specify the appropriate **Overdue Process Template**. The template is used to default the process's events (the template also controls numerous business rules, for example, when it will be canceled, how it will be canceled, etc). Refer to [How To Change Overdue Events](#) for a description of how you can override these events.
- Enter the overdue object(s) in the **Collecting On** grid. You must define at least one object.
- Save the overdue process.

How To Change Overdue Events

When an overdue process is first created, it has one or more overdue events. The events are the activities that will be performed to persuade the customer to pay the outstanding debt.

The number and type of events that are created when an overdue process is initiated are defined on the overdue process's overdue process template. The following points describe how to add / change / delete events on an overdue process if the defaulted events are not satisfactory.

- Use **Control Central** to choose the account with the overdue process whose events need to be changed.
- After the account is populated on Control Central, choose the **Overdue Process** option on the account context menu to transfer to the overdue process transaction in update mode for the account. Note, an account's Active overdue processes can be selected from the [Alerts zone](#).
- To add a new event, transfer to the [Overdue Process - Events](#) tab and press the + button in the **Overdue Events** scroll. At this point, the event has not been added to the database; rather, it just exists in memory. Before you add the event to the database, you must specify the following information:
 - Choose an **Event Sequence** so that the new event will be positioned properly in respect of the other events.
 - Choose a **Status** of Pending.
 - Choose the desired **Overdue Event Type**.
- If the activation of the new event is dependent on the successful completion of earlier events, turn on **Dep on Other Event** and then:
 - specify the sequences of the dependent events in **Event Dependencies** and
 - specify the how many days after the completion of the last dependent event that the new event should be triggered.

- If the activation of the new event is NOT dependent on the successful completion of earlier events, turn off **Dep on Other Event** and use **Trigger Date** to define the date on which the event should be activated (i.e., completed).
- To delete an existing event, click on the event in the tree on [Overdue Process - Main](#). This will transfer you to the **Events** tab where you can click the - button to remove the event. At this point, the event has not been removed from the database; rather, it's been removed in memory.
- To change an existing event, click on the event in the tree on [Overdue Process - Main](#). This will transfer you to the **Events** tab where you can make the desired changes.
- After all desired changes have been made, save the overdue process.

How To Cancel An Overdue Process

The system will cancel an overdue process when the [cancel criteria defined on the overdue process are satisfied](#). The following points describe how to manually cancel an overdue process.

- Use **Control Central** to choose the account with the overdue process to be cancelled.
- After the account is populated on Control Central, choose the **Overdue Process** option on the account context menu to transfer to the overdue process transaction in update mode for the account. A list of all overdue processes associated with the account appears. If only one overdue process exists, it is automatically selected for you. Note, an account's Active overdue processes can be selected from the [Alerts zone](#).
- On the **Main** tab, click Cancel and answer any prompts.

Cut Process Maintenance

A cut process contains the activities to stop a service agreement (in the hopes that lack of service will inspire the customer to pay). It should be noted that a separate cut process is created for each service agreement. The topics in this section describe the pages on which cut processes are maintained.

FASTPATH:

Refer to [The Big Picture Of Cut Processes](#) for background information.

Cut Process - Main

The Main page contains core cut process information. Open this page using **Menu > Credit & Collections > Cut Process > Search**.

Description of Page

NOTE:

Refer to [How To Perform Common Cut Process Functions](#) for more instructions describing how to use this page.

Cut Process contains a concatenation of important information about the process. **Cut ProcessID** is the system-assigned unique identifier of the process. These values only appear after the cut process is added to the database.

NOTE:

Summary information may be overridden. Refer to [Cut Process Information Is Overridable](#) for how your implementation can override the summary information that appears throughout the system.

Overdue Process and **Overdue Event** define overdue event that created the process. Refer to [Cut Processes Exist Under An Overdue Process](#) for more information.

Service Agreement identifies the service agreement being cut.

Premise identifies the service agreement's characteristic premise (if any).

NOTE:

Multiple cut processes may be linked to an overdue process / event. It's important to be aware that it's possible for multiple, active cut processes to be linked to the overdue event. You can see all cut processes associated with an overdue process on the tree of [Overdue Process - Main](#). The [Alert zone](#) will contain a summary of the account's cut processes.

Status defines the state of the cut process. The following values may exist:

- Active, Events Pending. Cut processes are initially created in this state. A cut process remains in this state until there are no Pending or Waiting events.
- Inactive, Canceled by User. A cut process will exist in this state when it's been manually canceled by a user. Navigate to the overdue process's **Log** tab to see when this happened and who did it.
- Inactive, Canceled by System. A cut process will exist in this state when it's been canceled by the system (typically because the overdue obligations on the overdue process were satisfied). Navigate to the **Log** tab to see when this happened.
- Inactive, Completed. A cut process will exist in this state when the system completes its last event. Navigate to the overdue process's **Log** tab to see when this happened.

The **Cancel** button appears if the cut process is Active, Events Pending and the process's **Cut Process Template** has a Cancel Logic plug-in. Click this button to [cancel the process](#).

The **Trigger Events** button appears if the cut process is Active, Events Pending. Click this button to activate all pending events that are [ready for activation](#).

NOTE:

If you can't wait for the Overdue / Cut Event Manager to run. The [Overdue / Cut Event Manager](#) is a background process that activates events on their trigger date. If you don't want to wait for this process to run, you can click the **Trigger Events** button to activate the process's events (that are ready for activation).

Cut Process Template defines the template that was used to [create the cut process's events](#). You can override these events on the **Events** page. This field is unprotected when the process is Active and all events are in either the Pending or Canceled states.

NOTE:

Changing the template. If you change the template, the system will delete the events and replace them with the new template's events.

Start Date/Time defines the start date/time of the cut process. This field is protected after the cut process is saved on the database. This field is used to derive the trigger date of some cut events when the process is first created. If you need to subsequently change the trigger date on the events, navigate to the **Events** tab and change the dates manually. Alternatively, you can perform the following "trick":

- Change the **Cut Process Template** to something (anything). Doing this causes the **Start Date/Time** to become unprotected.
 - Specify the base date of the cut events in the newly unprotected **Start Date/Time**.
-

- Change the **Cut Process Template** back to the desired value. When you change the template, the system removes the events and creates new ones using the **Start Date/Time**.

Inactive Date/Time is the date and time that the cut process became Inactive. This field is hidden if the process is Active. You can see more details about when and how the inactivation occurred by navigating to the overdue process's [Log](#) tab.

Enter any **Comments** about the cut process. This field is protected when the cut process is Inactive .

The [tree](#) at the bottom of the page shows a variety of information about the cut process including its events. You can click on hyperlinked tree nodes to navigate to the page on which the related object is maintained.

Cut Process - Events

This page contains the activities that are performed to cut the service agreement. Open this page using **Menu > Credit & Collection > Cut Process > Search** and navigate to the **Events** page.

Description of Page

NOTE:

Refer to [How To Perform Common Cut Process Functions](#) for more instructions describing how to use this page.

Refer to the first tab for a description of **Cut Process** and **Cut Process ID**.

The **Cut Events** scroll contains the process's cut events. Refer to [Cut Processes Are Created From Templates](#) for information about how the system defaults a process's events from its template.

- Note, all information in the scroll is protected if the event's Status is Complete or Canceled.
- **Event Sequence** is the unique identifier of the event.
- **Status** defines the [state of the event](#).
- The **Cancel** button appears if the event is Pending or Waiting, and the event's **Cut Event Type** has a Cancel Logic plugin. Click this button to cancel the event.
- The **Cut Event Type** defines the event's activity (e.g., Email sent, a To Do entry is generated, a letter is sent).
- The remaining fields work in unison:
 - If **Dependent on Other Events** is turned on, the event can only be triggered after the events specified in the **Event Dependencies** grid are all Complete or Canceled. You use the **Days After** field to define when this event is activated. For example, if you enter 5, this event will be activated 5 days after all of the dependent events are completed / cancelled. If you enter 0 (zero), this event will be activated immediately after the dependent events are completed / cancelled. Refer to [Calendar vs Work Days](#) for a descriptions of how days are counted.

If all dependent events are already Completed or Canceled , you cannot specify **Days After**. Rather, you must enter the desired activation date in the **Trigger Date** field.

- If **Dependent on Other Events** is turned off, enter the desired activation date in the **Trigger Date** field. If this field is off, the **Days After** field and the **Event Dependencies** grid are hidden.

NOTE:

If you can't wait for the Overdue / Cut Event Manager to run. The [Overdue / Cut Event Manager](#) is a background process that activates events on their trigger date. If you don't want to wait for this process to run, you can click the **Trigger Events** button on the **Main** tab to activate the process's events (that are ready for activation).

How To Perform Common Cut Process Functions

The topics in this section describe how to perform common cut process maintenance functions. Refer to [The Big Picture Of Cut Processing](#) for high-level information about cut processing.

How To Create A Cut Process

Cut processes are created when an overdue event is activated. You cannot create an ad hoc cut process.

How To Change Cut Events

When a cut process is first created, it has one or more cut events. The events are the activities that will be performed to persuade the customer to pay the outstanding debt.

The number and type of events that are created when a cut process is initiated are defined on the cut process's cut process template. The following points describe how to add / change / delete events on a cut process if the defaulted events are not satisfactory.

- Use **Control Central** to choose the account with the cut process whose events need to be changed.
- After the account is populated on Control Central, choose the **Cut Process** option on the account or service agreement context menus to transfer to the cut process transaction in update mode. Note, an account's Active cut processes can be selected from the [Credit and Collections zone](#).
- To add a new event, transfer to the [Cut Process - Events](#) tab and press the + button in the **Cut Events** scroll. At this point, the event has not been added to the database; rather, it just exists in memory. Before you add the event to the database, you must specify the following information:
 - Choose an **Event Sequence** so that the new event will be positioned properly in respect of the other events.
 - Choose a **Status** of Pending.
 - Choose the desired **Cut Event Type**.
- If the activation of the new event is dependent on the successful completion of earlier events, turn on **Dep on Other Event** and then:
 - specify the sequences of the dependent events in **Event Dependencies** and
 - specify the how many days after the completion of the last dependent event that the new event should be triggered.
- If the activation of the new event is NOT dependent on the successful completion of earlier events, turn off **Dep on Other Event** and use **Trigger Date** to define the date on which the event should be activated (i.e., completed).
- To delete an existing event, click on the event in the tree on [Cut Process - Main](#). This will transfer you to the **Events** tab where you can click the - button to remove the event. At this point, the event has not been removed from the database; rather, it's been removed in memory.
- To change an existing event, click on the event in the tree on [Cut Process - Main](#). This will transfer you to the **Events** tab where you can make the desired changes.
- After all desired changes have been made, save the cut process.

How To Cancel A Cut Process

The system will cancel a cut process when the [cancel criteria defined on the overdue process are satisfied](#). The following points describe how to manually cancel a cut process.

- Use **Control Central** to choose the account with the cut process to be cancelled.
- After the account is populated on Control Central, choose the **Cut Process** option on the account or service agreement context menu to transfer to the cut process transaction in update mode for the account. A list of all cut processes associated with the account appears. If only one cut process exists, it is automatically selected for you. Note, an account's Active cut processes can be selected from the [Credit and Collections zone](#).
- On the **Main** tab, click Cancel and answer any prompts.

Payment Arrangement for Bills

A payment arrangement is an agreement with a customer to payoff severely overdue debt in installments. Bills sent to customers with payment arrangements contain charges for both their current services and their payment arrangement installment amount.

Organizations that practice [open-item accounting](#) who collect on overdue bills may allow customers to pay off their overdue bills in installments by setting up a payment arrangement for one or more bills. This transaction is used to maintain bill-oriented payment arrangements.

FASTPATH:

Refer to [Bill-Oriented Payment Arrangements](#) for background information.

Open this page using **Menu > Credit & Collection > Payment Arrangement for Bills > Search** page.

Description of Page

The **SA** (service agreement) **Info** is a concatenation of important details about the payment arrangement service agreement (PA SA). The **SAID** is the unique identifier of the PA SA. These values only appear after the PA SA exists on the database.

The **Current Balance** that appears beneath **SA Info** contains the PA SA's current balance. When you initially set up a PA SA this balance will be zero. It is only non-zero if the customer has not paid a billed installment.

Payoff Balance beneath **SA Info** contains the PA SA's payoff balance. The payoff balance is the total amount to be paid off over the PA SA's life. It is only non-zero after delinquent funds have been transferred to the PA SA. This balance is only displayed when it differs from the **Current Balance**.

FASTPATH:

Refer to [Current Amount versus Payoff Amount](#) for more information.

Account ID is the account associated with the PA SA.

The occurrences of **Current** and **Payoff Balance** beneath **Account** are the account's respective balances. These values are displayed to help you confirm exactly how much the customer currently owes versus how much they will have to payoff over time (remember, after you transfer funds to a payment arrangement, the amount transferred is reduced from the account's current balance).

The **Unpaid Bills** grid contains a row for each of the account's unpaid bills.

Adjacent to each Unpaid Bill is its **Unpaid Amount** and a check box used to select the bill. Every selected bill's unpaid amount will be transferred to the PA SA when you click the **Create** button.

WARNING:

The system automatically indicates that all unpaid debt should be transferred to the payment arrangement. It does this by checking each bill by default.

Total Candidates is the sum of ALL unpaid bills (not just the selected bills).

New Payoff Balance contains the PA SA's payoff balance. This is the total amount of debt that will be paid off over the lifetime of the PA SA. This value equals the current payoff balance on the PA SA plus all selected debt from the **Candidate SAs** scroll.

The next fields work in unison.

- If you want to define the number of future bills that the customer has to payoff the selected unpaid amount, enter the number of **Installments**. When you tab out of the field, the system sets the **Arrange Amount** equal to **New Payoff Balance / Installments**.

NOTE:

Arrange Amount may not add up. The **Arrange Amount** is rounded up so that if you multiply the number of installments by the calculated installment amount, the result will be greater than the PA SA's payoff amount. Don't worry - only the actual dollar amount of the PA SA's total debt will be billed by the system. The last installment will be slightly lower than the other installments.

- If you want to define the amount charged on future bills to payoff the unpaid amount, enter the **Arrange Amount**. For example, if the customer agrees to pay off their delinquent debt by paying an additional \$50 on each bill, you'd enter "50" in this field. Note - If you enter a dollar amount in this field and tab out, the system will calculate the number of installments and display the number in the **Installments** field.

Define the **CISDivision** and **SA Type** of the payment arrangement service agreement.

NOTE:

Payment arrangement SA types. There is a field on SA type called [Special Role](#). Only those SA types with a role of Payment Arrangement may be selected.

Clicking the **Create** (or **Change**) button causes the system to perform the following:

- It creates / updates a payment arrangement service agreement (PA SA). It sets the installment amount on this service agreement equal to the installment amount specified on the page.
- It transfers unpaid debt from the selected bills to the PA SA. The adjustment type used to transfer these funds is defined on the PA SA's SA type.
- It links the "transfer from" adjustments to the unpaid financial transactions on the bills. This will cause the unpaid FT's to be linked to Balanced match events. This means that any Active Overdue Processes for the bills should Inactivate (i.e., cancel) because the bills will no longer be consider unpaid. Refer to [How Are Overdue Processes Cancelled](#) for more information..
- It reduces the current balance on the PA SA by the amount of debt transferred to the PA SA. Why? Because when delinquent debt is transferred to the PA SA, its current balance increases. Because current balance contains the amount the customer currently owes, this balance must be reduced because the customer is going to pay off the debt in installments (and therefore they don't currently owe anything). The adjustment type used to transfer these funds is defined on the PA SA's SA type.

Clicking **Break** causes the PA SA to become broken. Please refer to the note below for what transpires when a PA is broken.

NOTE:

Break logic is in a plug-in. Please be aware that the logic that is executed when a payment arrangement is broken exists in a plug-in algorithm (plugged-in on the account's [Collection Class Overdue Rules](#)). The base package algorithm

performs many functions (refer to [Breaking A Bill Oriented Payment Arrangement](#) for the details). The bottom line is that when a PA SA is broken, the originating bills will have their debt reinstated and this will again be subject to the [Overdue Monitor](#). Because this logic is in a plug-in, you can develop alternative logic and plug it in if the base package logic is not satisfactory.

Clicking **Cancel** causes the PA SA to become canceled. Cancellation should be used when you want to "logically delete" a PA SA because it shouldn't have been created.

The logic described above for breaking a payment arrangement is executed when a user cancels a payment arrangement; the only difference is that the PA SA is marked with a different characteristic type / value than when it is broken.

How To Set Up A Payment Arrangement

To set up a new payment arrangement:

- Open [Payment Arrangement for Bills](#) in add mode.
- Select the **Account** in question.
- Select the debt to be transferred to the payment arrangement (by turning on/off the checkboxes adjacent to the **Unpaid Bills**).
- Enter the number of **Installments** or the **Arrange Amount**.
- Define the **CIS Division** and **SA Type** of the new payment arrangement service agreement.
- Click the **Create** button.

How To Add Additional Debt To A Payment Arrangement

To transfer additional debt to an existing payment arrangement:

- Open [Payment Arrangement for Bills](#) in update mode.
- Select the existing payment arrangement in the search.
- Select the debt to be transferred to the payment arrangement (by turning on/off the checkboxes adjacent to the **Unpaid Bills** amounts).
- Enter the number of **Installments** or the **Arrange Amount**.
- Click the **Change** button.

NOTE:

After transfer. After transferring the funds to the payment arrangement service agreement, confirm the account's payoff and current balances make sense (the payoff balance is the total amount of debt that the account will eventually have to payoff, the current balance is how much they currently owe. The account's payoff and current balances are displayed in the page's second section. If you do not understand the difference between payoff balance and current balance, refer to [Current Amount versus Payoff Amount](#).

How To Break A Payment Arrangement

You would break a payment arrangement when a customer doesn't make the agreed payments. Typically, your overdue processes will break a payment arrangement behind-the-scenes if a customer doesn't pay. Refer to [Breaking A Bill Oriented Payment Arrangement](#) for information about how the system monitors payment arrangements.

If you want to manually break a payment arrangement,

- Open [Payment Arrangement for Bills](#) in update mode.
- Select the existing payment arrangement in the search.
- Click the **Break** button.

How To Cancel A Payment Arrangement

You would cancel a payment arrangement if you made a mistake and never intended to set up the payment arrangement in the first place. To cancel a payment arrangement

- Open [Payment Arrangement for Bills](#) in update mode.
- Select the existing payment arrangement in the search.
- Click the **Cancel** button.

Rebate Claims

The Rebate Claims feature allows you to search, view, and maintain rebate claims submitted as part of a conservation program.

FASTPATH:

For more information about conservation programs, see [Conservation Programs](#).

Rebate Claim Query Portal

You use the Rebate Claim Query Portal to search for rebate claims. Use the following procedure to search for rebate claims:

- Select **Menu > Customer Information > Rebate Claim > Search** to open the Rebate Claim Query portal.
- Enter search criteria in the Rebate Claim Search zone and click **Refresh**. You can search by:
 - Customer Name
 - Account ID
 - Conservation Program
 - Start and End Dates
- A list of rebate claims matching the search criteria appears, displaying the following for each:
 - Claim Date
 - Rebate Claim (Status, Claim Date, Conservation Program, and Total Amount)
 - Account (Name, Customer Class, Current Balance, and Account ID)
 - Total Rebate Amount

- To view a rebate claim, click the **Rebate Claim** link. The selected rebate claim opens in the Rebate Claim portal.

Rebate Claim Portal

You use the Rebate Claim portal to view, edit, and maintain rebate claims. To add a rebate claim, open **Menu > Customer Information > Rebate Claim > Search**.

The topics in this section describe the base-package zones that appear on the Rebate Claim portal.

Rebate Claim Zone

You use the Rebate Claim zone to view the details of rebate claims. The Rebate Claim zone opens when you first create a new rebate claim, or when you select a rebate claim on the Rebate Claim Search zone. The Rebate Claim zone displays the following information about the selected rebate claim:

- **Basic Information:** information about the claim, including:
 - Conservation Program
 - Status (Pending, Issue Detected, Approval in Progress, Receipt Verification, Complete, or Canceled)
 - Rebate Claim number
 - Claim Date
 - Total Rebate Amount
- **Customer Details:** details about the customer who submitted the claim, including:
 - Person
 - Account
 - Premise
 - Mailing Address
- **Contact Details:** contact information for customer who submitted the claim, including:
 - Name
 - Phone Number
 - Fax Number
 - Email Address
- **Premise Information:** information about the physical premise of the customer who submitted the claim, including:
 - Premise Property Type
 - Residential Property Type
 - Building Vintage
- **Payment Release Authorization Details:** details about the person to whom the rebate payment should be made, including:
 - Authorized By
 - Authorization Date
 - Payee Name
 - Phone Number

- Mailing Address
- Issue Details: issues related to the rebate claim, including manually submitted issues as well as those detected through the Verify action.
- Approval Details: details related to users assigned to approve the rebate claim, including:
 - Current Approver
- Reject Details: details related to why a claim was rejected, including:
 - Reject Reason
 - Date Rejected
 - Rejected By

To view a different rebate claim, select the rebate claim from the **Select a Rebate Claim** drop- down list and click **Go**.

Rebate Claim Status

Rebate claims are assigned a status to indicate the current state of the claim within the system. Valid statuses include:

- **Pending** indicates the claim is pending. This is the initial state of a rebate claim when first created.
- **Issue Detected** indicates that one or more issues have been detected with the claim. Issues can include those manually created as well as issues detected through the Verify action.
- **Approval in Progress** indicates the claim is awaiting approval.
- **Receipt Verification** indicates that receipts associated with the rebate claim's claim lines need verification.
- **Complete** indicates the claim was approved and is complete.
- **Rejected** indicates the claim was rejected.
- **Canceled** indicates the claim has been canceled.

Rebate Claim Actions

You can perform a number of actions on a rebate claim, including:

- **Edit:** Used to edit the details of the rebate claim.
- **Verify:** Used to verify the supplied details of the rebate claim, and change its status to either Approval in Progress (if the claim passes the verification) or Issue Detected (if any issues are detected). This helps ensure the rebate claim has been properly set up.
- **Approve:** Used to approve a submitted rebate claim, and change its status to Complete or Receipt Verification (if receipts had not been previously verified).
- **Reject:** Used to reject a submitted rebate claim, and change its status to Complete.
- **Issue Detected:** Used to note an issue related to the rebate claim, and change its status to Issue Detected.
- **Cancel:** Cancels a rebate claim, changing its status to Canceled.

The actions available are based on the current status of the rebate claim. The table below summarizes the actions available at each status.

Status	Valid Action
Pending	Edit, Verify, Issue Detected, Cancel

Issue Detected	Edit, Verify, Cancel
Approval in Progress	Approve, Reject, Issue Detected
Receipt Verification	Issue Detected
Completed	None
Rejected	Issue Detected
Canceled	None

Editing Rebate Claims

Use the following procedure to edit a rebate claim:

- Click **Edit**.
- Edit the details of the rebate claim as needed.
- Click **Save**.

Verifying Rebate Claims

To verify a rebate claim, click **Verify**.

Approving Rebate Claims

To approve a rebate claim, click **Approve**.

Rejecting Rebate Claims

Use the following procedure to reject a rebate claim:

- Click **Reject**.
- Select the **Reject Reason** on the Reject Rebate Claim dialog.
- Click **OK**. To close the dialog without rejecting the claim, click **Cancel**.

Noting Issues Related to a Rebate Claim

Use the following procedure to note an issue related to a rebate claim:

- Click **Issue Detected**.
- Enter details about the issue in the Comments field of the Issue Comments dialog.
- Click **OK**. To close the dialog without saving the comment, click **Cancel**.

Canceling Rebate Claims

Use the following procedure to cancel a rebate claim:

- Click **Cancel**.
- Select the **Cancel Reason** on the Cancel Rebate Claim dialog.
- Click **OK**. To close the dialog without cancelling the rebate claim, click **Cancel**.

Adding Rebate Claims

You can also add rebate claims from the Rebate Claim Query portal. Use the following procedure to add a rebate claim:

- Select **Menu > Customer Information > Rebate Claim > Add**, or click **Add** on the title bar of the Rebate Claim Search zone. The user is navigated to Control Central to select the customer filling the rebate claim. Click **Continue** once the correct account is in context.
- Select the Conservation Program associated with the rebate claim and click **OK**.
- Complete the Rebate Claim details, including:
 - Claim Date for the rebate claim
 - Customer Details
 - Contact Details
 - Premise Information
 - Payment Release Authorization Details
- Click **Save**. The rebate claim is displayed on the Rebate Claim portal.
- Edit the claim as needed in the Rebate Claim zone.
- Add claim lines to the claim using the Rebate Claim Line zone.

Rebate Claim Line Zone

You use the Rebate Claim Line zone to add, view, and edit rebate claim lines associated with a rebate claim. A rebate claim can have one or more claim lines, one for each item for which a rebate is requested. For example, if a customer purchases new energy efficient appliances (such as a washing machine and dryer), the rebate claim they submit would have a rebate claim line for each appliance. The Rebate Claim Line zone displays the following details for each claim line:

- Rebate Definition
- Manufacturer/Model
- Rebate Amount
- Icons to Edit, Delete, and Verify claim lines

Adding Rebate Claim Lines

Use the following procedure to add a rebate claim line to a rebate claim:

- Click **Add Rebate Claim Line** in the title bar of the Rebate Claim Line zone.
- Select the **Service Agreement** associated with the claim line from the dropdown list.
- Select the **Rebate Definition** for the claim line from the dropdown list. This list is filtered based on the Conservation Program associated with the rebate claim.
- Select the **Manufacturer/Model** for the claim line from the dropdown list. This list is filtered by the Rebate Definition selected.
- Enter the **Install Date** for the claim line.
- Enter the **Number of Units** being claimed.
- Click **Save**. To return to the Rebate Claim Line zone without adding the claim line, click **Cancel**.

Deleting Rebate Claim Lines

Use the following procedure to delete a rebate claim line from a rebate claim:

- Click the delete icon for the claim line you wish to delete.
- Click **OK** on the Confirm Delete dialog. To close the dialog without deleting the claim line, click **Cancel**.

NOTE:

You can delete a rebate claim line only when the rebate claim is in Pending status.

Editing Rebate Claim Lines

Use the following procedure to edit an existing rebate claim line on a rebate claim:

- Click the edit icon for the claim line you wish to edit.
- Edit the details of the claim line as appropriate.
- If you are revising the data based on updated information, check the **Data Revised** checkbox and select the reason for the revision from the **Data Revised Reason** dropdown list. The **Original Data Details** section displays the data originally entered for the claim line.
- If the claim line contained bad data, check the **Bad Line** checkbox and select the reason for the revision from the **Bad Line Reason** dropdown list. The **Original Data Details** section displays the data originally entered for the claim line.
- Click **Save**. To return to the Rebate Claim Line zone without changing the claim line, click **Cancel**.

NOTE:

You can edit a rebate claim line only when the rebate claim is in Pending status. In addition, you cannot edit a rebate claim line after it has been verified.

Verifying Rebate Claim Lines

Use the following procedure to verify a rebate claim line on a rebate claim:

- Click the **Verify** button for the claim line you wish to verify.
- Verify that the details of the claim line match the submitted receipts.
- Click **Verify**. To return to the Rebate Claim Line zone without adding the claim line, click **Cancel**.

NOTE:

You cannot edit a rebate claim line after it has been verified.

Rebate Claim Log Zone

This is a standard [log zone](#). You use the Rebate Claim Log zone to view logging details associated with a rebate claim.

Adding Rebate Claim Log Entries

Use the following procedure to add a rebate claim log entry:

- Click **Add Log Entry** in the title bar of the Rebate Claim Log zone.
- Enter the log entry details in the Add Rebate Claim User Log dialog.
- Click **OK**. To close the dialog without saving the log entry, click **Cancel**.

Communications

Device Events

About Device Events

Device events are developments that have taken place relative to a device, and can include power outages, power restorations, tampering alerts, command completions, among others.

Attributes used to define device events include the following:

- **Device Event Date/Time:** the date and time of the event. This date/time is flexible in its interpretation. For single events it is the moment the event took place. For events that are paired, like a power up and a power down, it will represent the start of the event when received with the first of the pair and the end of the event when received with the second of the pair. For an event that includes the duration, where the device event end date/time is also supplied, this date/time represents the start date/time.
- **Device Event End Date/Time:** the end date and time of events with durations. This will only be populated if the device event date/time is also populated.
- In addition, device events also reference details specific to the head-end system that sent the event, including the following:
 - **Sender:** the head-end system (defined as a service provider in Oracle Utilities Smart Grid Gateway) from which the event was sent.
 - **External Sender ID:** the external ID for the head-end system that sent the event.
 - **External Event Name:** the external, head-end-specific name for the event. This name is translated into a "standard" event name within Oracle Utilities Smart Grid Gateway.
 - **External Source Identifier:** an identifier for the source of the event.

Standard Event Names

When the system is loading a device event, it first determines which head-end system sent it, and then determines which device produced it. The system then maps the device event name sent by the head-end system to a standard event name that corresponds to the event. Standard event names are beneficial because the event names sent by head-end systems vary, even when the events are essentially the same. What one head-end system calls "Primary Power Down," another system may call "Last Gasp." Creating a standard event name, such as "Power Outage - Device," makes it easier to send the device events to an external system such as Oracle Utilities Network Management System. In this way, the external systems that receive the events do not need to be configured to accept all of the possible names for a single type of event.

Refer to [Understanding Device Event Types](#) for additional information about how the device events are mapped using standard event names.

Processing Device Events

Device Events received from external systems are processed through two major stages:

- **Device Event Seeder:** This is the common interface point that receives all device event information and performs critical validations and conversions. During this process the device event seeder identifies the appropriate specific device event business object for further processing. The choice is made based on the originating external system and the type of event being received. For example, a device event for a "Last Gasp" would result in the paired event first device event being selected.
- If for some reason the device event seeder encounters an error an instance of the device event eeder will be created to manage the resolution of that error.
- **Specific Device Event:** Each specific device event has the appropriate logic for the type of event that has been received. A tamper event might create a service issue monitor while a "Last Gasp" might create an outage activity.

Device Event Seeder Processing

The device event seeder receives device event data in a common structure, however, the content of the data (identifiers, date/times, etc) can vary depending on the system and the particular device that generated it. To accurately translate the external content to values understood by the system the device event seeder leverages the configuration of the service provider (aka head end or external system) and the device.

The service provider specifies the following inputs into device event seeder processing:

- **Identifier Types:** Each device event must identify the device the event has been generated from. The system supports a multitude of identifiers for the device. The service provider configuration specifies which identifier type is used for the device which enables the device event seeder to search for the correct destination for the device event. For example, a service provider might indicate that devices are identified by a serial number.
- **Date/Time Format:** The service provider configuration will identify whether the date/times that were sent included specific time zone designations. This allows the system to accurately handle any time zone conversions that may be necessary.
- **Processing Methods:** A service provider has the following processing methods that are used in the evaluation of the device event:
 - Device Event Mapping - Maps a given external device event name to a standard event name. That standard event name is eventually used to identify the appropriate device event for specific processing.
 - Time Zone Translation - Identifies the extendable lookup to be used in mapping the service provider specific time zone to the interval time zone.

The device specifies the following inputs into IMD Seeder processing:

- **Incoming Data Shift:** This value is either specified directly on the device or can be defaulted via fallback on the device type. It identifies whether the incoming date/time information has is "Shifted" meaning it has been adjusted for Daylight Savings Time (DST) when in effect, or it is "Not Shifted" which means it will never be adjusted for DST. This plays an important role in the date/time processing since all incoming device event date/times will be stored without an adjustment for DST.

With these inputs the device event seeder is able to translate the external identifiers into the appropriate identifiers to tie the device event to the originating device in the system..

Device Event Seeder Critical Validations

For device events to continue on to specific device event processing they must pass the critical validations:

- The device must be identified.
- The device event must have an event date/time.

If either of the critical validations fails the device event processing will be halted and an instance of the device event seeder will be created

Note: There is special logic that exists for handling the situation where either the device event date/time or the device event end date/time falls on the duplicate hour that occurs when a time zone transitions out of daylight savings time.

Device Event Seeder Time Zone Translation and Conversion

To provide the most accurate tracking of device events all device event data is stored in a single time zone without an adjustment for Daylight Savings Time (DST). As utilities can have multiple head end systems that each send date/time information in different ways and some utilities operate in multiple time zones the device event seeder contains functionality to convert incoming date/times from a source time zone into the time zone of Oracle Utilities Meter Data Management (as indicated by the base time zone)

There are three components to identifying the source time zone of the incoming device event:

- **Service Provider IMD Import Date/Time Format:** When the device event date/times are sent in a format that identifies the time zone for each date/time the date/times will be delivered to the device event seeder already converted.
- **Incoming Data Shift:** This indicates whether the date/times will be adjusted for DST while it is in effect. A value of "Always in Local Time" indicates that the date/times are adjusted for DST. A value of "Always in Standard Time" indicates that the date/times are not adjusted for DST
- **Time Zone:** The time zone of the incoming data is identified using the follow order of precedence:
 1. The time zone as indicated by the device event data
 2. The service point time zone
 3. The device configuration time zone
 4. The base time zone

Once the time zone and the data shift of the incoming date/times is identified all date/times will be converted from that time zone and shift into the base time zone in standard time.

Specific Device Event Processing

Types of Device Events

Standard

Momentary device events, such as a tamper alert, are processed using the standard device event. These device events do not provide any special processing.

Paired Device Events

Device events with a duration are defined using paired event device events: paired event first and paired event last. With the first of the pair representing the start of the event, and the last of the pair representing the end of the event. Events of this type can be configured to create or complete activities that represent the event. For example, a "Last Gasp" event might create an outage activity that is completed when "Power Restoration" event is received.

When pairs of events arrive in rapid succession (such as a last gasp followed quickly by a power restoration), these "paired event" business objects are designed to prevent them from being sent to subscribing applications.

Communication Response

The communication response is a special type of event used for head end systems that respond to smart meter commands with device events. When received these events create a communication in that will initiate the completion of the originating smart meter command.

Refer to [About Communication In](#) for more information on a communication in.

Sending Device Events to Subscribing Systems

When device events are received, they are typically passed onto to another subscribing system, such as Oracle Utilities Meter Data Management, a customer information system (such as Oracle Utilities Customer Care and Billing), an outage system (such as Oracle Utilities Network Management System), or some other application.

The means of sending device event information to subscribing system is defined in the "How to Send Device Event Related Information" processing method for the service provider representing the subscribing system. Device event information can be sent via outbound communication business object, outbound communication, or batch process.

The method for sending device events to subscribing systems (business object, outbound message, or batch process) can be defined for each device event category, and can be overridden for individual device event types (including the ability to exclude specific device event types within a category). In addition, a default event processing method can be also be configured that applies when methods of transmission aren't specified at the individual category level.

The "Subscribe to Device Event" business service is used to process device event subscription requests, and allow external applications to manage the categories of events they receive.

Refer to [About Device Event Notification Suppressions](#) for more information on a suppression device event notifications.

Creating Service Issue Monitors and Service Investigative Orders

Device events can be configured to create service issue monitors and service investigative orders. The service issue monitor type to create is defined on the device event type. When a device event is received, an Enter algorithm on the device event's Processed state creates the service issue monitor, based on the Service Issue Monitor Type specified for the device event type.

Refer to [Understanding Service Task Types](#) for more information on configuring service issue monitor types.

Device Event Prioritization

By default, device events are created and/or received into the system in an initial state is "Pending" and are transitioned to subsequent states via the batch processing. This batch processing can be skipped by setting the Execution Method flag on the device event to "Real Time" (DIRT), in which case an Enter algorithm transitions the device event to the next state in its lifecycle immediately. This feature can be used to prioritize processing of certain types of device events.

The Execution Method flag can be set in in unsolicited device events sent from the head-end system, or can be inserted during Oracle Utilities Smart Grid Gateway Adapter processing.

Oracle Utilities Smart Grid Gateway Adapters set this flag to "Real Time" on all device events created as the result of smart meter commands.

Activities

About Activities

Activities cover a range of functional process within the system from smart meter commands, synchronization of consumption between related measuring components, service order management activities, and statistics and aggregations.

The table below provides the full list of activity type categories supported and a brief description of how they are used:

Activity Type Category	Activities of this type category are used to
Bulk Activity	Initiate a smart meter command for a group of meters using Oracle Utilities Smart Grid Gateway
Command Request	Initiate a smart meter command for an individual meter using Oracle Utilities Smart Grid Gateway
Consumption Sync	Trigger related measuring component estimation synchronization
Device Event Activity	Represent a device event. These are used when viewing usage and events with the Oracle Utilities Meter Data Management 360 Degree View.
Dimension Scanner	Trigger dimension scanning when aggregating usage, statistics, and other data.
Error Activity	Represent errors in activity processing.
Extract Request	Retrieve usage and device events from a head-end system using Oracle Utilities Smart Grid Gateway
Field Activity	Initiate field work via a message to an external field work system. Activities of this type are most often created by a request orchestration activity.
Meter Read Download Activity	Download a list of meters to be read.
Multi Device Command Request	Initiate a smart meter command for multiple meters (for head-end systems that support multi-device commands) using Oracle Utilities Smart Grid Gateway
Non-Dispatchable Activity	Represent steps or stages in a larger process in which the system is waiting for a resolution from another system. Examples include "Wait for Measurement" or "Wait for Scheduled Read."
Orchestration Maintenance	Update or cancel an active service order activity.
Payload Statistics	Calculate processing statistics for usage and device event import processing
Request Orchestration	Orchestrate the steps necessary to fulfill a service request, based on the current state of the service point related to the request.
Suppression	Suppress sending of device events to subscribing systems (such as Oracle Utilities Network Management System)
Usage Transaction Correction Processor	Trigger correction processing for usage transactions when corrected usage is received that would impact an existing usage transaction

Maintaining Activities

You use the **Activity** portal to view and maintain activities.

Refer to [About Activities](#) for additional functional information.

You can access the portal by selecting **Main, Communication, Activity**. You are brought to a query portal with options for searching. Once your record has been selected you are brought to the maintenance portal to view and maintain the selected record.

NOTE: When creating new activities using this portal, if the **Restrict Division** setting in the **Control by Division** section in the MDM Master Configuration is set to "Yes", only activity types with a Division (or Divisions) associated with the user on the **User Miscellaneous Information** zone on the **Miscellaneous** tab of the **User** portal will be available.

This portal includes the following zones:

- **Activity:** defines the basic attributes of the activity
- **Field Activity Attachments:** lists attachments related to the activity (displayed only if the current activity is a field activity)
- **Activity Hierarchy:** a tree that displays the activity and related activities (including field activities and smart meter commands), inbound and outbound communications, and completion events
- **Activity Related Completion Event:** lists completion events (if any) related to the activity

Manually Completing Service Order Field Activities

Service order field activities in the "Communication in Progress" state can be manually completed or canceled by clicking **Complete** in the **Record Actions** section of the **Activity** zone. This opens the **Field Activity Manual Completion** page where the user can enter appropriate details to manually complete the field activity (such as completion information, service point information, device information, and so on). When submitted, this page creates an inbound communication and transitions the field activity to the next state as appropriate.

Note: Implementations can define custom service scripts for each field task type in the **Manual FA Completion Controls** section on the Field Task Type extendable lookup to customize the sections displayed on the **Field Activity Manual Completion** page.

Communications

About Communication Out

These transactions are typically created from an activity and are tasked with sending a message to an external system. They follow one of two communication patterns:

- **Two-way:** these messages are sent to the external system without an expectation of an immediate response, or a response is received but it is only an acknowledgement of a successful receipt of the message. The true response to the message is expected to be received in a process detached from the communication out. For the full lifecycle of the communication to be complete a communication in must be received.
- **One-way:** these messages are sent to the external system and responded to in full within a single transaction. No communication in will be received.

The format of the message sent to the external system is typically driven by a processing method for that external system and the transportation method is controlled by the external system's message options.

If an error is encountered sending the message to the external system the communication out can perform automated retry of the messages for a configurable rate of retry and number of retry attempts.

For one-way communications the communication out will be responsible for creating the completion event.

Once the message has been communicated and a response received the outbound communication will update the initiating activity with the result.

NOTE:

Refer to the following topics for additional information on communications functionality:

- [Understanding Processing Methods](#) for additional information on how processing methods are configured.
 - See [About Completion Events](#) for details on completion events.
 - See [External Systems](#) in the Oracle Utilities Application Framework *Administrative User Guide* for additional information on configuring communication between your system and external systems.
-

About Communication In

These transactions represent a message sent from an external system and are received in two situations:

- In response to a communication that had been sent to the external system. This is the most common usage of the communication in.
- An unsolicited message received from an external system such as a real time event. Note: this is not a common pattern.
- Upon receipt the communication in will link itself to the communication out that initiated it. The response message will then be validated to ensure that it is technically and functionally correct.
- For many smart meter commands and field activities executed by service order management the communication in is responsible for creating the appropriate completion events. For example, if the response was for the On Demand Read smart meter command a completion event will be created that will generate the appropriate initial measurement data.
- Similar to the communication out a communication in that encounters an error can perform an automated retry with a configurable rate of retry and number of retry attempts.

Maintaining Communications

The Communication portal is used to maintain communication in and communication out records.

Refer to [About Communication Out](#) and [About Communication In](#) for additional functional information.

You can access the portal from the **Main > Communication > Communication**. You are brought to a query portal with options for searching. Once your record has been selected you are brought to the maintenance portal to view and maintain the selected record.

This portal includes the following zones:

- **Communication**: defines the basic attributes of the Communication
- **Communication Hierarchy**: a tree that displays the communication and related activities (including field activities and smart meter commands), inbound and outbound communications, and completion events.

Completion Events

About Completion Events

Completion events are used to implement the outcome of an activity. They are created by either the communication out (for one-way communication) or the communication in (for two-way communication). Completion events are executed by the activity orchestrating the communication with the external system.

Some examples of the tasks a completion event will perform are:

- Commissioning, decommissioning, connecting, disconnecting a smart meter
- Installing or Removing a meter or item

- Creating initial measurement data
- Updating a device or service point

Maintaining Completion Events

The Completion Event portal is used to maintain completion events.

Refer to [About Completion Events](#) additional functional information.

You can access the portal from the **Main > Communication > Completion Event**. You are brought to a query portal with options for searching. Once your record has been selected you are brought to the maintenance portal to view and maintain the selected record.

This portal includes the following zones:

- **Completion Event**: defines the basic attributes of the Completion Event
- **Completion Event Related Objects**: displays data related to the completion event such as a device, service point, or initial measurement.

NotificationSuppressions

About Device Event Notification Suppressions

When a device event is processed by the system it can be sent to one or many external applications interested in being notified about the event. A prime example of this is the Outage Management System subscribing to any device events related to a meter either losing power or regaining power.

There are situations, such as a field worker performing maintenance on a meter or on a node that impacts many meters, that will result in a large amount of device events being created, processed, and distributed to subscribers.

Device event notification suppressions provides a way for a subscribing system, in anticipation of scheduled maintenance, to suppress notification of certain device events (power down, power up, tamper, etc) from one or more meters.

Maintaining Notification Suppressions

The **Activity** portal is used to maintain notification suppressions records.

Refer to [About Device Event Notification Suppressions](#) for additional functional information.

You can access the portal from the **Main > Communication > Notification Suppression**. You are brought to a query portal with options for searching. Once your record has been selected you are brought to the maintenance portal to view and maintain the selected record.

This portal includes the following zones:

- **Activity**: defines the basic attributes of a notification suppression activity

Integrations

Business Flags

About Business Flags

Business flags provide a view into the status of a service point across applications (e.g. Oracle Utilities Meter Data Management, Oracle Utilities Analytics Insights, Oracle Utilities Customer Care and Billing). Business flags are currently available in two forms:

- **Service Point Business Flags:** are often informational in nature but also allow for manual investigation to be taken.
- **Service Point Monitor Business Flags:** are seen as symptomatic of an issue that needs to be investigated. These business flags feed into a service issue monitor and may result in a service investigative order being created.

For additional details see [About Business Flags](#) in the Oracle Utilities Application Framework *Administrative User Guide*.

Business Flag Allowed Actions

Allowed actions are implemented presented to the user as selectable options that will guide the user through a particular method of investigating or resolving the business flag. The following actions are supported:

- **Create Field Activity:** This will initiate a field activity associated to the business flag's service point. The type of field task will be selected by the user. Note: this option requires Oracle Utilities Service Order Management.
- **Request Customer Notification:** This will initiate a message to the appropriate external system (e.g. Oracle Utilities Customer Care and Billing) that will identify a notification to be sent to the customer. The type of communication will be determined by the notification type selected by the user.

Note: not all business flags support allowed actions and not all business flags that support allowed actions support all allowed actions.

Maintaining Business Flags

Information for this functionality is available in the [Business Flags](#) section in the Oracle Utilities Application Framework *Administrative User Guide*.

Oracle Utilities Analytics Insights

Using the Meter Insights Investigation Viewer

The Meter Insights and Investigations functionality leverages the Oracle Utilities Analytics Insights business flag integration to support receipt of revenue protection events (referred to as "insights") from Oracle Utilities Analytics Insights for research and investigation using Oracle Utilities Meter Data Management (or Oracle Utilities Meter Solution Cloud Service). Revenue protection insights sent from Oracle Utilities Analytics Insights for investigation are events that suggest potential theft or loss of revenue such as unexpected consumption from an inactive meter, evidence of meter tampering, discovery of an improperly installed meter (such as a meter installed upside down or in reverse), and so on. Insights received from Oracle Utilities Analytics Insights create business flags, which in turn create related Meter Insight Investigation service tasks (referred to as "investigations"). Business users can use the **Meter Insights Investigations Viewer** portal to search, view, and investigate these investigations. This portal is intended to provide as much investigative information as possible so as to allow the user to complete as much work as possible without leaving the portal.

Searching

Use the following procedure to search for investigations:

1. Navigate to the portal by selecting **Main**, then **Insights**, then **Meter Insights Investigation Viewer**.

By default the **Investigations** zone displays search results for unassigned records and records assigned to the current user.

2. To search by specific search criteria or display the search criteria and filters, click the **Show Filters** link or icon. The **Investigations** zone expands to display the available search filters, including:
 - Business Flag Type
 - Address (including City and Postal Code)
 - Average Daily Usage
 - Priority
 - Service Type
 - Service Point Type
 - Assigned to User ID
 - Flags to include Unassigned records, and investigations with current active field activities.

3. Enter your search criteria and click **Search**.

The **Investigations** zone displays a default set of data about each investigation. To select the information to display for each, click the **Display** link or icon, select or deselect the data you wish to view or hide, and click **Display**.

Viewing Service Issue Monitors and Consumption

To view additional information about an investigation, click the **Expand Section** icon in the far left column. The section expands to display:

- Comments
- Service Point Information
- Field Work Information
- A list of insights (business flags) related to the investigation
- Consumption (a section similar to the **Final Values Overlay** zone in the **360 Degree View** portal)

To view additional information about the investigation, service point, or field activity, click the icon at the end of its information string. A new browser window will open displaying the **Service Task**, **Service Point** tab of the **360 Degree View** portal or **Activity** portal (respectively). This allows the user to investigate the issue in more detail as needed without having to navigate away from the **Meter Insights Investigations Viewer** portal.

To expand the **Consumption** section, click the **Expand Section - Consumption** icon on the far right side of the **Consumption** section heading. The section expands to display the following:

- **Parameters:** The default parameters used to display consumption for the service point. This includes **Measuring Component**, **Value Identifier Type**, **Start Date/Time**, **End Date/Time**, **Final Values Overlay Profile**, and **Event Bar Profile**. These values are based on the **Consumption Data Source** parameters on the investigation's **Investigation Type** (Service Task Type). The measuring component and value identifier type is based on service point type, interval/scalar flag, and UOM/TOU/SQI combination, and the date range is based on the start and end dates of the investigation and the **Days Before to Graph** and **Days After to Graph** parameters.
- **Values to Graph:** A list of measuring components to graph, including measuring components defined in the current **Final Values Overlay Profile**, as well as other measuring components selected by the user.

- **Measurement Data:** A graph and tabular display of the consumption and values to graph, and event bars based on the current **Event Bar Profile**.

To change the displayed consumption, adjust the **Parameters** and **Values to Graph** and click **Load** (in the **Parameters** section).

Working With Investigations

Users can also add comments, assign a recipient for To Do entries, and change the status of investigations from this portal.

- To add or edit a comment, click the **Edit** icon in the second column from the left. The **Edit** icon is replaced by a checkmark icon and an "X" icon, and a **Comments** box opens. Enter or edit the comment text and click the checkmark icon. To delete a comment, click the "X" icon.

Comments are saved on the Investigation, and can be viewed from the **Log** tab on the **Service Task** portal.

- To assign a recipient for To Do entries, click the **Edit** icon in the second column from the left. The **Edit** icon is replaced by a checkmark icon and an "X" icon, and the **Assigned To** column displays a drop-down list. Select the user to which To Do entries should be assigned, and click the checkmark icon.
- To change the status of the investigation, click the icon in the **Action** column. A popup menu will open displaying available options including:
 - **Initiate Field Work:** Select this to create a field activity to investigate the issue from the field (this transitions the investigation to the Waiting for Field Work state).
 - **Issue Resolved:** Select this if the issue has been resolved (this transitions the investigation to the Issue Resolved state).
 - **No Issue:** Select this if there is no issue (this transitions the investigation to the No Issue state).
 - **Inconclusive:** Select this if/when the investigation is inconclusive (this transitions the investigation to the Inconclusive state).
 - **Discarded:** Select this to discard issue (this transitions the investigation to the Discarded state).

See [Meter Insights and Investigation Processing](#) in the *Administrative User Guide* for more information about what happens when the investigation enters one of these states.

Aggregations

Standard Aggregations

About Aggregations

Aggregations are measurements that represent a summarization of other measurements from a set of devices, items, and/or measuring components. For example, an aggregation may be based on the sum of the electric consumption of all residential customers in a particular postal code within the utility's service territory. The group of related measuring components for which measurements are summarized are referred to as constituent measuring components.

Every type of aggregation has one or more dimensions. For example, an aggregation might be defined with three dimensions as follows:

- Substation
- Feeder
- Transformer

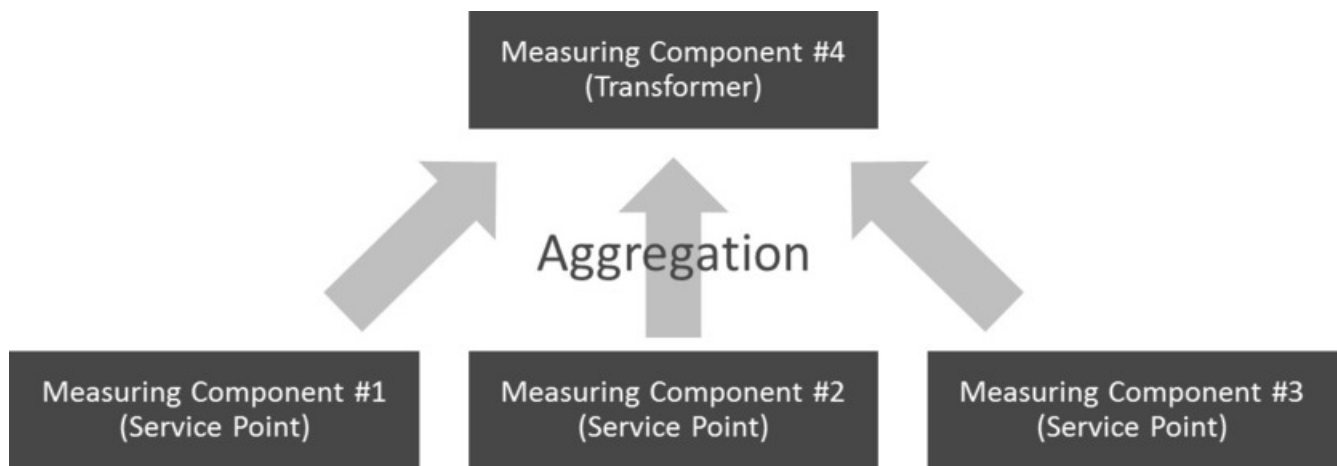

Aggregations are defined by aggregator measuring components. A separate aggregator measuring component should be defined for every distinct combination of dimensions for a given type of aggregation. For example, the transformer aggregation described above would require an aggregator measuring component for every distinct combination of substation / feeder / transformer found among the electric Service Points.

Aggregations can also be aggregated. For example, the aggregator measuring components for each substation / feeder / transformer combination can in turn be used to aggregate consumption at each substation / feeder combination. In this case, a distinct aggregator measuring component would be defined for each unique substation / feeder combination. Likewise, the aggregator measuring components for each substation / feeder combination could be used to aggregate consumption at each substation, in which case, distinct aggregator measuring components would be defined for every unique substation. Finally, the aggregator measuring components for each substation can be used to aggregate total consumption for all substations, with an aggregator measuring component defined to represent the entire service area.

Aggregation Calculations

The system periodically aggregates consumption via batch process, using a deferred monitor on the aggregator measuring components. In addition, users can re-aggregate data in real-time if they don't wish to wait for the batch process, or if the original aggregation needs to be re-calculated due to incorrect data. Users can also create ad hoc aggregations "on the fly" and these will persist in the database in the same manner as other aggregations.

Understanding Aggregation Periods

The start and end dates and times for aggregation calculations are based on the following:

- Aggregation Horizon
- Aggregation Lag
- Aggregation Cut Off Time

Whenever aggregation is performed for an aggregator measuring component, consumption is aggregated for every day in its "Aggregation Horizon." The "Aggregation Horizon" is the number of days during which there's a potential change in measurement data for one or more of the measuring components associated an aggregator measuring component.

Aggregation calculations typically lag behind the current date by a few days to give the system time to upload and perform validations and create final measurements. The amount of lag time is referred to as the "Aggregation Lag" and is the number of days between the date on which aggregation calculations are performed and the end date of the aggregation period. This defines the time period between the aggregation calculation date and the end of the aggregation horizon that serves to allow all measurements to arrive. This together with the Aggregation Horizon is used to determine the start and end dates of an aggregation period. For example, with an Aggregation Horizon of 5 and an Aggregation Lag of 2, aggregation calculations performed on January 9 would be for an aggregation period of January 3 through January 7. The next day (January 10), the aggregation period would shift to January 4 through January 8.

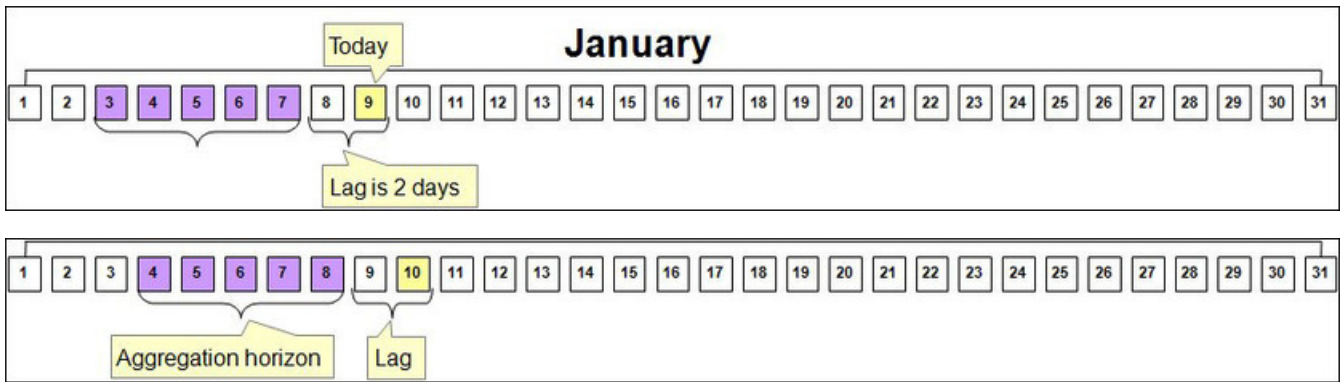

Aggregation is always performed through a given "through time" (such as 12:00 AM) rather than through the actual time of the aggregation calculation. This time is referred to as the "Aggregation Cut Off Time." For example, the stop time for aggregation calculations with an Aggregation Lag of 2, and an Aggregation Cut Off Time of 10:00 PM will always be 10:00 PM 2 days prior to the date on which the calculations are performed. In the above examples, aggregations performed on January 9 would have an end date/time of 10:00 PM on January 7, and aggregations performed on January 10 would have an end date/time of 10:00 PM on January 8.

Aggregation and Re-Aggregation

The use of the aggregation horizon means that aggregated totals for some days will be re-aggregated until those days are no longer covered by the aggregation horizon. For example, with an aggregation horizon of 5 days and an aggregation lag of 2 days, on the night of January 9 the aggregation period would be January 3 through January 7 (as in the above example).

On the night of January 10, the horizon will shift 1 day (to January 4 through January 8, again as above). This means the following:

- The totals for January 3 calculated on January 9 will be untouched (January 3 now falls outside the aggregation horizon)
- The totals for January 4 through January 7 will be re-derived because corrections may have occurred (and they still fall within the aggregation horizon)
- The totals for January 8 will be calculated for the first time (because it now is within the aggregation horizon).

Manually Read Meters and Aggregation Lag

Aggregations that include manually read meters often have much longer aggregation lags than those for automatically read meters. This allows more time for manual meter readings to be imported into the system for use in aggregations.

For example, suppose a situation where manual meter reads arrive approximately 1 month after the date of the reading. In this case, it wouldn't be until a meter read upload on February 7 that the last manual reads including consumption from January 6 will exist. Since we don't want to perform aggregations for January 6 until there's a decent chance that all consumption for that date exists, an aggregation lag of 32 days ensures that the data for January 6 is in the system when the aggregation is performed on February 7.

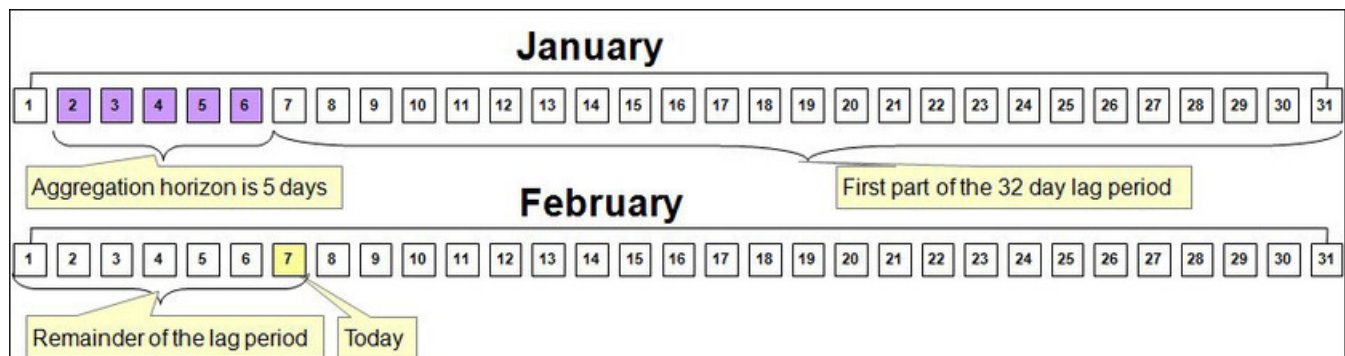

When An Aggregator Measuring Component Contains Both Manual and AMI Measuring Components

The previous section suggests that if an aggregator measuring component contains both manually read and AMI measuring components, the aggregator measuring component should have a long lag time rather than the short time shown in the earlier example.

While this is one possible approach, an alternative approach could allow users to see timely aggregations of the AMI channels and only lag the manual channels. To do this they could configure the system as follows:

- Create an aggregator measuring component that only aggregates manual measuring component types (horizon: 5 days, lag: 31 days)
- Create a separate aggregator measuring component that only aggregates interval measuring component type: 5 days types (horizon: 5 days, lag: 2 days)
- Create a third aggregator measuring component that aggregates the above aggregator measuring component types (horizon: 5 days, lag 31 days)

Expanding The Aggregation Horizon Periodically

Even with a 30-ish day aggregation lag, it's possible for an account with several months of estimated consumption to have its consumption "invalidated" when real readings arrive whose dial readings are less than the estimated readings (or when major retroactive data change takes place). Another similar situation is when a user manually corrects consumption after the aggregation horizon has moved forward.

To address situations like these, the use of ad-hoc aggregations with a user-specified aggregation horizon supports the notion of periodically (such as once a month or once a week) aggregating with a long aggregation horizon (up to 90 days) to catch as many retroactive changes as possible.

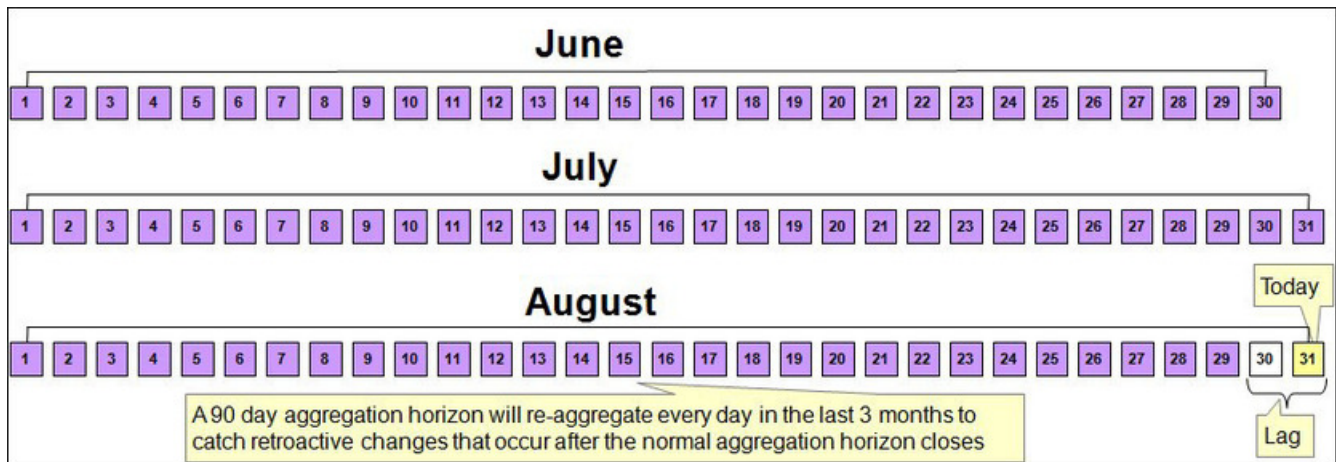

A Note About Using Non-Effective Dated Dimensions

Be aware that whenever aggregation takes place, the system uses master data that exists as of that date. For example, if an aggregation is performed using non effective-dated master data attributes (for example, aggregating by measuring component type) and a measuring component's type is changed, all days in the aggregation horizon will reflect the change regardless of when the user makes the change, because the measuring component type relationship is not effective-dated.

The impact of this depends on the nature of the change:

- If the master data was wrong, this provides a way to re-aggregate the data to accurately reflect the master data.
- If the change occurred effective as of a given date (but there's no effective dated attribute), this can result in incorrect aggregation values.

Because of this, it is recommended that where possible dimensions used in aggregations be effective-dated. For information on configuration, reference the related section for [Aggregations](#) in the Administration Guide.

Creating Aggregators

There are two ways in which aggregator measuring components are created:

- **Automatically:** The system will periodically create new aggregator measuring components when new "dimensional values" are detected. For example, if a new substation is added to the system, a new aggregator measuring component will be created for the substation.
- **Manually:** An end-user can create an aggregator measuring component at their discretion

Automatic Creation of Aggregator Measuring Components

The system automatically creates aggregator measuring components when it detects new instances of the dimension(s) being aggregated. This activity is referred to as dimension scanning. For example, if the system is configured to aggregate individual substations, a user will NOT have to manually set up an aggregator measuring component when a new substation is referenced on a service point. Rather, the system will create the new aggregator when it detects a substation on a service point that doesn't have an aggregator measuring component.

Similarly, if is configured to aggregate distinct combinations of rate class (on usage subscription type) and postal code (on service point), the system will create an aggregator measuring component when it detects new combinations of rate class and postal code.

The periodic monitoring to ensure sufficient aggregation measuring components exist is implemented via monitoring algorithms on a related activity business object that references a corresponding measuring component type. This means that there must be a separate activity type / activity combination for every type of aggregation performed. These monitor algorithms include:

- A Monitor algorithm on the Active state that simply transitions the activity to the transitory Scan state. Users can manually transition the activity to the Scan state by clicking the "Scan" button on the activity.
- An Enter algorithm on the Scan state finds the distinct combinations of dimensional values for this type of aggregation and checks that an aggregator measuring component that references the activity's aggregator measuring component type exists for every instance and creates new aggregator measuring components as appropriate. The algorithm also populates the dimensional values on the new measuring components (mapped to searchable characteristics), and sets the Consumption Aggregated Through Date/Time field on the new aggregator measuring components to the current date and the Aggregation Cut Off Time on the aggregator measuring component type.

Hard-Wiring Service Types for Aggregations

If the dimensions used for aggregation do not include at least one service type-specific dimension (for example, in the case of aggregating by postal code only) AND the aggregation should not commingle measurements of different service types, it's important to:

- Declare the specific service type for the aggregation on the dimension scanner activity instance
- Declare the desired service type-specific measuring component types on the aggregator measuring component type

For example, if an electric and gas implementation aggregates consumption by postal code, they will need 2 activities: one will reference the Electric service type and the desired aggregator measuring component type, the other will reference the Gas service type and its aggregator measuring component type. The aggregator measuring components will have two dimensional attributes: postal code and service type.

Manual Creation Of Aggregator Measuring Components

Users can also create aggregator measuring component manually. This is useful when an ad hoc aggregation for an ad hoc time period is required, or when there is no activity that automatically creates instances of a given combination of dimensions. To do this, the user simply clicks the "Add" link on the Aggregator Search zone title bar. The BPA script:

- Prompts the user to define the type of aggregation (this will present a list of measuring component types whose measuring component category is aggregator)
- Prompts the user to define the dimensional value(s), the desired aggregation time, and if this aggregation should be performed indefinitely or if it is a "one time"

Base Product Aggregators

A number of standard aggregation processes are delivered as part of the base product. These provide a means of aggregating measurement data by postal code and service type for both physical meters and items.

Aggregator Name	Description
Aggregator - Postal and Service Type	Aggregates measurement quantities for constituent measuring components from physical meter based on postal code and service type dimensions.
Item Aggregator - Postal and Service Type	Aggregates measurement quantities for constituent measuring component from items based on postal code and service type dimensions.

Aggregators Used With Analytics

Other aggregators shown below are delivered for use by Oracle Utilities Analytics and Oracle Utilities Analytics Visualization (OUAV). These aggregate measurement data (including quantities and counts) for constituent measuring components based on the following dimensions: Postal, City, Head-End, Device Type, Usage Calculation Group, Market and Service Provider, and Service Type.

Aggregator Name	Description
Measurement Measured Quantity Aggregator OUAV Subject Area: Meter - Aggregated Measurement Quantity	Aggregates measurement quantities and distributes the constituents' measurements across Value Identifiers based on condition codes.
Measurement Quality Count Aggregator OUAV Subject Area: Meter - Aggregated Measurement Count	Aggregates measurement counts and distributes the constituents' counts across Value Identifiers based on condition codes.
Measurement Timeliness Count Aggregator OUAV Subject Area: Meter - Aggregated Timeliness Count	Aggregates measurement counts that arrived on time or are late.
Measurement Timeliness Quantity Aggregator OUAV Subject Area: Meter - Aggregated Timeliness Quantity	Aggregates measurement quantities that arrived on time or are late.

See the [Oracle Utilities Analytics Visualization User Guide](#) for more information about the OUAV Subject Areas.

Maintaining Aggregations

This portal is used to display and maintain Aggregations.

Refer to [About Aggregations](#) for additional functional information.

You can access the portal from the **Main > Totals and Trends > Consumption Statistics**. You are brought to a query portal with options for searching. Once your record has been selected you are brought to the maintenance portal to view and maintain the selected record.

The following zones may appear as part of the portal's **Main** tab page:

- **Measuring Component**: defines the basic attributes of the aggregator measuring component.
- **Measuring Component Attributes**: displays attributes that describe the dimensions and criteria for the aggregation measuring component (applies to dynamic aggregation measuring components only)
- **Measurements — Interval**: displays aggregated measurement data for the selected aggregator measuring component.
- **Interval - Audit View**: allows users to view an interval measurement curve for a given period overlaid with the count of audit records for each individual measurement.
- **Final Values Overlay**: displays final measurements for a measuring component, and provides the ability to overlay the graphed data with final measurements from other measuring components.
- **Time of Use Overlay**: displays an overlay of the TOU periods on a final interval measurement along with totalized TOU consumption based on a user-defined time period and TOU map
- **Related Measuring Component Sets**: lists measuring components sets of which the aggregator measuring component is a member (applies to dynamic aggregation measuring components only)
- **Usage Subscriptions Directly Linked to MC**: lists usage subscriptions that are directly linked to current measuring component

A few functions are available in many of these zones that allow you to interact with the measurement data. For more information of these functions refer to the [Applying Measurement Functions](#) section.

Dynamic Aggregation

Dynamic Aggregation Overview

Standard aggregation processing uses specific algorithms configured to work with a specified set of dimensions. For example, the base package Service Type and Postal aggregation uses specific algorithms for dimension scanning and finding constituent measuring components. In contrast, dynamic aggregation uses dynamic queries for the dimension scanning, find constituents, and aggregation processes.

Dynamic aggregation can be used for analysis (to view aggregated data to understand load demand, for instance) as well as settlement processing performed by Oracle Utilities Market Settlements Management.

Dynamic aggregation results can be viewed using Oracle Utilities Analytics Visualization. See [Viewing Dynamic Aggregation Results Using Oracle Utilities Analytics Visualization](#) and the [Oracle Utilities Analytics Visualization User Guide](#) for more information.

Understanding Dynamic Aggregation Execution

This section provides an overview of how dynamic aggregation processing is executed, including descriptions of the different types of dynamic aggregation processing and the different types of data that can be aggregated.

Dynamic Aggregation Execution: Aggregation Groups and Aggregation Group Runs

Aggregation processing is managed via aggregation groups. [Aggregation Groups](#) outline the sequence of aggregations that must occur for a given aggregation process. Each aggregation group includes a set of [Measuring Component Sets](#), each of which has one or more related [Aggregation Measuring Components](#).

When processing is initiated for an aggregation group, the system creates an Aggregation Group Run record to track the status and progress of the aggregation processing. This record is used to manage the aggregation process for each group and track which Measuring Component Sets should be executed next and when the aggregation is complete.

The following steps outlines the aggregation process:

1. The Dimension Scan and Aggregation monitor batch control (D1-DSAEM) initiates processing for all Aggregation Groups. This should be scheduled at least once per day. This monitor process runs all monitor algorithms on each aggregation group. The base package aggregation group has two monitor algorithms:
 - Aggregation Group Run Maintenance (D1-AGRM)
2. The Aggregation Group Run Maintenance algorithm verifies if the Aggregation Group is ready to aggregate by looking at the processing timetable defined for the aggregation group and the last scheduled execution. If it is time for the next aggregation then the algorithm creates a pending Aggregation Group Run which will then be used to track the status of the Measuring Component Sets for the aggregation.
3. At the completion of the Dimension Scanner and Aggregation monitor batch process, the Submit Dimension Scanner Batch (D1-SUBDIMSCN) post-processing algorithm searches for any Aggregation Group Run entries that are in progress where the next Measuring Component Set is not manual. If at least one is found then it will initiate the Aggregation Group Dimension Scanner batch process (D1-AGDS).
4. The Aggregation Group Dimension Scanner batch process identifies the next Measuring Component Set for each Aggregation Group Run that is in progress. If that next Measuring Component Set is not manual then it will retrieve each Aggregation Measuring Component for the Measuring Component Set and execute the monitor algorithms for that Aggregation Measuring Component. These include an aggregation algorithm (specific to the type of data to be aggregated such as interval, billed quantities, etc.) and in some cases a value derivation algorithm.
5. For each Aggregation Measuring Component that is monitored by the Aggregation Group Dimension Scanner batch process, the aggregation process:
 - a. Executes the appropriate Find Constituents algorithm to find the list of constituents that are to be aggregated
 - b. Extracts the data for those constituents that should be aggregated
 - c. Executes the appropriate aggregation algorithm against that data and store the results
 - d. Executes validation algorithms if applicable
 - e. Executes value derivation algorithms if applicable
6. The Aggregate Next Measuring Component Set (D1-AGGNXMCS) post-processing algorithm on the Aggregation Group Dimension Scanner batch process updates the Aggregation Group Run the batch information for each Measuring Component Set that was aggregated, and requests the Dimension Scan and Aggregation monitor batch process to run again.
7. This again executes the monitor algorithms for all the Aggregation Groups which will do one of several things:
 - If the Aggregation Group Run is in progress and the next Measuring Component Set is Automatic then nothing will happen.
 - If the Aggregation Group Run is in progress and the next Measuring Component Set is Manual it will create a To Do.
 - If the Aggregation Group Run does not have a next Measuring Component Set, it will set the Aggregation Group Run to Complete

NOTE: The Dimension Scanner algorithm will be executed again but since there will not be a pending Aggregation Group Run it will not do anything.

8. Once all Measuring Component Sets are complete the Aggregation Group Run Maintenance algorithm marks the Aggregation Group Run as complete.

Aggregation Scheduling

Refer to [Understanding Aggregation Periods](#) for basics about aggregation periods.

Aggregation Scheduling for Aggregation Groups can be based on either a Defined Lag, or a Processing Timetable.

- **Defined Lag** scheduling uses the following parameters:
 - **Aggregation Cut Off Time:** The end time for aggregation calculations performed for Aggregation Measuring Components for Measuring Component Sets associated with the Aggregation Group. This is used to ensure a consistent end time for aggregation periods. This is especially useful when aggregating other aggregations.
 - **Aggregation Lag:** The number of days between the date on which aggregation calculations are performed and the end date of the aggregation period. This defines the time period between the aggregation calculation date and the aggregation horizon that serves to allow all measurements to arrive. This together with the Aggregation Horizon is used to determine the start and end dates of an aggregation period. For example, with an Aggregation Horizon of 5 and an Aggregation Lag of 2, aggregation calculations performed on January 9 would be for an aggregation period of January 3 through January 7. The next day (January 10), the aggregation period would shift to January 4 through January 8.
 - **Aggregation Horizon:** The number of days in the aggregation period for Aggregation Measuring Components for Measuring Component Sets associated with the Aggregation Group. This reflects the time period during which there's a potential change in measurement data for one or more of the measuring components associated with Aggregation Measuring Components. This together with the Aggregation Lag is used to determine the start and end dates of an aggregation period.
- **Processing Timetable** scheduling uses a Processing Timetable Type to drive aggregation schedule.

With dynamic aggregation, the aggregation period is consistent for all members of an Aggregation Group when an aggregation is performed. This is despite the fact that there may be differences between Measuring Component Sets and even Measuring Components within an Measuring Component Set as to how far the data has been aggregated through. In addition, individual Aggregation Measuring Components all use the same aggregation period when aggregation is performed.

Dynamic Aggregation Processing

This section provides additional details around the specific types of processing used with dynamic aggregation.

Similar to standard aggregation, dynamic aggregation processing comprises three primary types of processes:

- **Dimension Scanning:** a process that searches for unique combinations of dimensions that are not yet represented by an Aggregation Measuring Component.
- **Find Constituents:** a process that finds all source data to be aggregated for a given Aggregation Measuring Component, based on the Aggregation Measuring Component's dimensions.
- **Aggregation:** a process that aggregates source data that corresponds to the Aggregation Measuring Component's dimensions.

Dynamic aggregation processing is driven by the following types of administrative data:

- **Data Sources** define the source of data to be aggregated, such as measurement data from usage subscriptions linked to a service point, badged or unbadged items, or other sources of data.
- **Aggregation Measuring Component Types** define the most important properties of aggregation measuring components used to store aggregated data.
- **Aggregation Groups** define the ordering of a series of related aggregations and the schedule of aggregation.
- **Measuring Component Sets** define the dimensions and criteria by which aggregation will be performed.

Refer to [Dynamic Aggregation Configuration Overview](#) for more information about configuration of this data.

Dynamic SQL

Dynamic aggregation uses dynamic SQL queries to perform dimension scanning, find constituents, and aggregation processing. These dynamic queries are based on configuration of:

- [Data Sources](#)
- [Aggregation Measuring Component Types](#)
- [Measuring Component Sets](#)

The Source of Dynamic SQL

Data sources provide template SQL that is used as the basis for dynamic queries. This template SQL is extended by additional SQL generated from the data source configuration as well as configuration defined for measuring component sets, measuring components, and measuring component types that reference the data source. The ways in which the template SQL is extended is based on the type of process:

- **Dimension Scanning:** The data source template SQL is extended by the criteria, dimensions, and individually managed items configured on the measuring component sets being processed.
- **Find Constituents:** The data source template SQL is extended by attributes defined on the aggregation measuring components being processed.
- **Aggregation:** The data source template SQL is extended by the value identifiers defined on the measuring component type of the aggregation measuring components being processed.

Dimension Scanning

The dimension scanning process analyzes master data to identify unique dimension combinations and create an aggregation measuring component for each. Several objects play a role in this process:

- The Aggregation Group holds the monitor algorithm that performs the scanning
- The Data Source defines the template SQL for identifying dimensions
- Measuring Component Sets define the dimensions and criteria for identifying the dimension combinations

See [Dynamic SQL](#) for more about the role of data sources and measuring component sets in generating dynamic SQL queries for dimension scanning.

This process is executed when aggregation is initiated for an Aggregation Group. This process should be run on a frequent basis (daily or more frequent) and should be executed prior to aggregation processing being run. Each time it is executed the dimension scanning process takes the following high level steps:

1. Identifies all Measuring Component Sets for the Aggregation Group that are not imported from an external source
2. Identifies all yet to be represented dimension combinations
3. Creates an Aggregation Measuring Component based on the Measuring Component Set's Measuring Component Type for each dimension combination identified in step 2.
4. Adds Attributes for each Aggregation Measuring Component created to describe the dimensions and criteria for that Measuring Component
5. Adds an entry in the Measuring Component Set participants table for each Aggregation Measuring Component created

This processing is performed by a monitor algorithm (Aggregation Group Dimension Scanner: D1-AGDS) on the Finalized status of the Aggregation Group business object.

Find Constituents

The Find Constituents process finds all source data to be aggregated for a given aggregation measuring component, based on the Aggregation Measuring Component's dimensions. The queries used for this process are based on data source template SQL extended by attributes defined on the Aggregation Measuring Components being processed.

The Find Constituents process is initiated by the aggregation algorithm on the Aggregation Measuring Component (each type of Aggregation Measuring Component — interval, item, billed quantities — has its own aggregation algorithm), and is performed by algorithms defined for the Find Constituents system event on the Aggregation Measuring Component business object.

This process differs slightly when finding constituents for interval and scalar measurements stored on measuring components, item data, and billed quantities.

Measuring Components

The Find Constituents process for measuring components uses the Find Constituents for Dynamic Aggregation (D1-FINDCONST) algorithm which retrieves data based on the following:

- Attributes on the Aggregation Measuring Component based on the Measuring Component Set configuration
- Measuring Component Types on the Data Source

Measuring component constituents are inserted into a global temporary table (GTT1) with the following information:

- Measuring Component ID
- Horizon Start Date/Time
- Horizon End Date/Time
- Time Zone

NOTE: The aggregation period for each is adjusted by the source Measuring Component's installation history.

Items

The Find Constituents process for items uses the Find Constituents for Items (D1-FICONITEM) algorithm which retrieves data based on the following:

- Attributes on the Measuring Component based on the Measuring Component Set configuration
- Item Types / Service Point Types on the Data Source (for badged vs. unbadged items, respectively)

Item constituents are inserted into a global temporary table (GTT3) with the following information:

- Maintenance Object (Device or Service Point)
- Device Type: Item Type
- Item Count
- Horizon Start Date/Time
- Horizon End Date/Time
- Time Zone

NOTE: The aggregation period for each is adjusted by the source Item's installation history.

Billed Quantities

The Find Constituents process for billed quantities uses the Find Constituents for Billing Data (D1-FINDCONSB) algorithm which retrieves data based on the following:

- Attributes on the Aggregation Measuring Component based on the Measuring Component Set configuration
- Usage Subscription Types on the Data Source

Billed quantity constituents are inserted into a global temporary table (GTT5) with the following information:

- Usage Subscription ID
- Usage ID
- Horizon Start Date/Time
- Horizon End Date/Time
- Time Zone

NOTE: The aggregation period for each is adjusted by the source Usage Subscription's installation history.

Aggregation Calculation

The aggregation calculations process aggregates source data that correspond to the Aggregation Measuring Component's dimensions. The queries used for this process are based on data source template SQL extended by the value identifiers defined on the measuring component type of the Aggregation Measuring Components being processed.

The aggregation calculation process is initiated by Aggregation by MC Set Monitor batch process (D1-AMCS), and is performed by monitor algorithms defined on the Active state of the Aggregation Measuring Component business object. The algorithms used by each type of Aggregation Measuring Component are as follows:

Aggregation Measuring Component Business Object	Aggregation Algorithm
Dynamic Aggregator - Billed Quantities (D1-AggBilledServiceQuantities)	Aggregate Billed Service Quantities (D1_AGGBSQ)
Dynamic Aggregator - Composite (D1-AggregatorComposite)	Aggregate Interval Measurements (D1_AGGINT)
Dynamic Aggregator - Customer Quantities (D1-AggregatorCustomerQuantity)	Aggregate Customer Specific Quantities (D1_AGGCSQ)
Dynamic Aggregator - Interval (D1-AggregatorInterval)	Aggregate Interval Measurements (D1_AGGINT)
Dynamic Aggregator - Items (D1-AggregatorItems)	Aggregate Item Data (D1_AGGITEM)
Dynamic Aggregator - Scalar (D1-AggregatorScalar)	Aggregate Scalar (D1_AGGSCLR)

See [Types of Aggregation](#) for more information about aggregation calculations for each type.

Other Calculations

In addition to basic aggregation processing, other calculations can be performed on aggregated measurements as needed. For instance, a common step in aggregating data for use in market settlements is applying a loss factor to aggregated data to reflect system losses (line loss, etc.) between generation-level quantities and end consumption quantities.

These types of calculations can be performed by value derivation algorithms. These are algorithms based on the Derive Aggregated Quantity Using a Formula (D1-DERAGGQTY) algorithm type which apply a configured formula to aggregated measurement values. For instance, to apply a loss factor, an algorithm can retrieve effective-dated factor values for a loss factor and multiply each aggregated measurement value by the appropriate factor value.

The Execute Aggregation Value Derivation (D1-EAGGVALD) algorithm on Aggregation Measuring Components executes any value derivation algorithms specified for Value Identifiers on the Aggregation Measuring Component Type.

Foundation and Composite Aggregation

Dynamic aggregation supports two “levels” of aggregation. Aggregating source data, from measuring components, items, or billed quantities is referred to as “Foundation” aggregation. Aggregation of aggregated data is known as “Composite” aggregation. Composite aggregation provides the ability to aggregate data from a set of other aggregations.

The diagram below illustrates a simple example of the relationship between foundation and composite measuring component sets. Each of the three foundation measuring component sets has a number of aggregation measuring component participants that aggregate data based on a set of dimensions and a particular supplier and rate class. Those in turn are participants in the composite measuring component set that aggregates based on the supplier (including data for all rate classes).

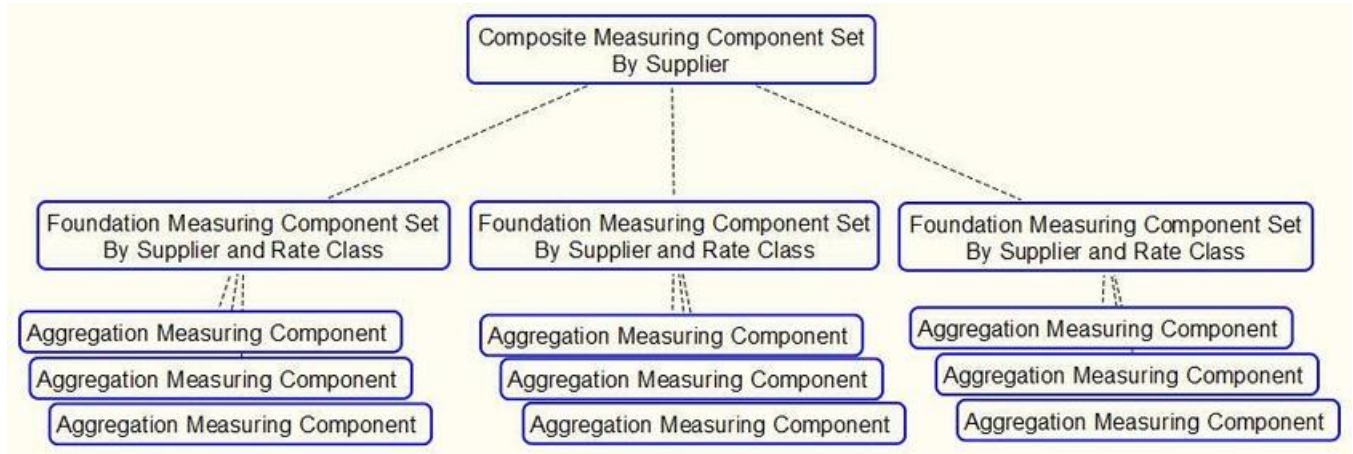

A common scenario where composite aggregation would be used is to consolidate data across several foundation aggregation measuring component sets that pulled data from a set of data sources ordered by precedence such that the best data was sourced when available and when not the aggregations fell back to a lesser quality data source:

- Foundation: Interval measurements from usage subscriptions and / or service points
- Foundation: Scalar measurement from usage subscriptions and / or service points
- Foundation: Interval measurements from estimations (backcasted using actual weather)
- Composite: Aggregation by supplier

In this example the goal of the first aggregation would be to retrieve as much interval data as possible where that interval data covered the entire period being settled for. The second aggregation would take scalar data for those instances where interval data was not available and apply a profile to produce the appropriate intervals. The third aggregation would fill in any remaining gaps that were not covered by interval or scalar data with estimations based various forecasting models.

At the completion of those first three aggregations there would be the full resolution of data for the customer base. However, the values would be spread out across many aggregation measuring components tied to those measuring component sets. This is where the composite aggregation functionality comes into play. The composite aggregation measuring component would reference the first three foundation aggregations and sum together the data from each aggregation into a single instance that represents the total usage for the period being settled.

Let’s look at a slightly more involved example. The diagram below illustrates a set of foundation aggregations based on:

- Rate Class
- Strata
- Procurement Class

This shows how the physical measuring component data (designated by Customer A, Customer B, etc.) will be aggregated into separate aggregation measuring components based on source of data (interval or scalar). Then it shows how those aggregations are then aggregated to produce a total number that represents all 3 aggregation sources merged together.



Types of Aggregations

This section describes the processing used by different types of aggregations, including:

- Aggregating Measurement Data (Interval and Scalar)
- Aggregating Item Data
- Aggregating Billed Service Quantities
- Aggregating Aggregated Data (Composite Aggregation)

Aggregating Measurement Data

Aggregating measurement data involves identifying constituent measuring components for an Aggregation Measuring Component, identifying the measurement data that falls within the aggregation period, and aggregating that data. The process varies slightly between interval and scalar measuring components.

Interval Measuring Components

Aggregation of interval measurements is handled by the Aggregate Interval Measurements (D1_AGGINT) algorithm. The algorithm performs the following steps:

- It calls the Find Constituents for Dynamic Aggregation (D1-FINDCONST) algorithm and populates the GTT1 global temporary table (see [Find Constituents](#) for more details about this process).
- It deletes any constituents from the GTT1 table that do not have 100% coverage for the dates in the aggregation period.
- For each remaining constituent in GTT1, the algorithm inserts its measurements for the aggregation period into the GTT2 global temporary table. If the SPI and UOM are different from that of the Aggregation Measuring Component, the measurements are converted to a common SPI using Axis Conversion.
- It performs aggregation calculations on the measurement data in the GTT2 table, using data source template SQL, extended by the value identifiers defined on the measuring component type of the Aggregation Measuring Component.
- It either inserts or updates the results to the appropriate measurement table (the standard Measurement table, or the Aggregation Measurement table)
- If there is no data for any dates in the aggregation period and previously aggregated measurements exist, those measurements are deleted to indicate the absence of data.
- It updates the **Most Recent Measurement Date/Time** and **Latest Measurement Date/Time** values on the Aggregation Measuring Component.

Scalar Measuring Components

Aggregation of scalar measurements is handled by the Aggregate Scalar Measurements (D1_AGGSCAL) algorithm. The algorithm performs the following steps:

- It calls the Find Constituents for Dynamic Aggregation (D1-FINDCONST) algorithm and populates the GTT1 global temporary table (see [Find Constituents](#) for more details about this process).
- It deletes any constituents from the GTT1 table that do not have 100% coverage for the dates in the aggregation period.
- For each remaining constituent in GTT1, the algorithm inserts its measurements for the aggregation period into the GTT2 global temporary table. If the UOM is different from that of the Aggregation Measuring Component, the measurement is converted to a common UOM before being inserted into GTT1.
- It performs aggregation calculations on the measurement data in the GTT2 table, using data source template SQL, extended by the value identifiers defined on the measuring component type of the Aggregation Measuring Component.
- It applies a profile to the aggregated scalar values to create interval measurements with the same SPI as the Aggregation Measuring Component.
- It either inserts or updates the results to the appropriate measurement table (the standard Measurement table, or the Aggregation Measurement table)
- If there is no data for any dates in the aggregation period and previously aggregated measurements exist, those measurements are deleted to indicate the absence of data.
- It updates the **Most Recent Measurement Date/Time** and **Latest Measurement Date/Time** values on the Aggregation Measuring Component.

Aggregating Item Data

Aggregating item data involves identifying constituent items for an Aggregation Measuring Component, calculate item measurement data for the aggregation period, and aggregating that data.

Aggregation of interval measurements is handled by the Aggregate Item Data (D1_AGGITEM) algorithm. The algorithm performs the following steps:

- It calls the Find Constituents for Items (D1-FICONITEM) algorithm and populates the GTT3 global temporary table with groups of device types (for badged items) and/or service point types (for unbadged items) (see [Find Constituents](#) for more details about this process).
- It deletes any constituents from the GTT3 table that do not have 100% coverage for the dates in the aggregation period.
- For each remaining constituent in GTT3, the algorithm calculates measurements for the aggregation period and inserts them into the GTT4 global temporary table by applying the item counts for each group to the item interval (profile) data. If the SPI and UOM are different from that of the Aggregation Measuring Component, the measurements are converted to a common SPI using Axis Conversion.
- It performs aggregation calculations on the measurement data in the GTT4 table, using data source template SQL, extended by the value identifiers defined on the measuring component type of the Aggregation Measuring Component.
- It either inserts or updates the results to the appropriate measurement table (the standard Measurement table, or the Aggregation Measurement table)
- If there is no data for any dates in the aggregation period and previously aggregated measurements exist, those measurements are deleted to indicate the absence of data.
- It updates the **Most Recent Measurement Date/Time** and **Latest Measurement Date/Time** values on the Aggregation Measuring Component.

Aggregating Billed Quantities

Aggregating billed service quantities involves identifying constituent usage transactions for an Aggregation Measuring Component, retrieving the service quantity data that falls within the aggregation period, and aggregating that data.

Aggregation of billed quantities is handled by the Aggregate Billed Service Quantities (D1_AGGBSQ) algorithm. The algorithm performs the following steps:

- It calls the Find Constituents for Billing Data (D1-FINDCONSB) algorithm and populates the GTT5 global temporary table (see [Find Constituents](#) for more details about this process).
- It deletes any constituents from the GTT5 table that do not have 100% coverage for the dates in the aggregation period.
- For each remaining constituent in GTT5, the algorithm retrieves billing data for the aggregation period (based on the service quantity configuration on the data source) and inserts it into the GTT6 global temporary table. If the UOM is different from that of the Aggregation Measuring Component, the service quantities are converted to a common UOM.
- It performs aggregation calculations on the measurement data in the GTT6 table, using data source template SQL, extended by the value identifiers defined on the measuring component type of the Aggregation Measuring Component.
- It applies a profile to the aggregated values to create interval measurements with the same SPI as the Aggregation Measuring Component.
- It either inserts or updates the results to the appropriate measurement table (the standard Measurement table, or the Aggregation Measurement table)
- If there is no data for any dates in the aggregation period and previously aggregated measurements exist, those measurements are deleted to indicate the absence of data.
- It updates the **Most Recent Measurement Date/Time** and **Latest Measurement Date/Time** values on the Aggregation Measuring Component.

Aggregating Aggregated Data

Aggregating aggregated data, also known as composite aggregation, involves identifying constituent aggregation measuring components for a composite Aggregation Measuring Component, identifying the measurement data that falls within the aggregation period, and aggregating that data.

Composite aggregation is very similar to aggregating interval measurement data, and uses the Aggregate Interval Measurements (D1_AGGINT) Find Constituents for Dynamic Aggregation (D1-FINDCONST) algorithm.

Aggregation Measuring Components

About Aggregation Measuring Components

Aggregation Measuring Components are measuring components used to store aggregated data. Aggregation measuring components do not use initial measurements. Aggregated measurements are stored in the Measurement or Aggregation Measurement table (based on the Measurement Business Object defined for the aggregation measuring component's type).

Aggregation Measuring Components are defined by the following:

- **Initiating Measuring Component Set:** The measuring component set that triggered creation of the aggregation measuring component via the Dimension Scanning process (see [Dimension Scanning](#) for more information).
- **Processing Information:** Details of aggregation processing for the aggregation measuring component, including the date and time through which aggregation has been performed.
- **VEE Groups:** The VEE groups used when performing validation, editing, and estimation for the aggregation measuring component.
- **Measuring Component Attributes:** Attributes that describe the dimensions and criteria for the aggregation measuring component (identified by the Dimension Scanning process)

The base package includes the following aggregation measuring component business objects for use with dynamic aggregation:

- **Aggregator Interval (D1–AggregatorInterval):** Used to aggregate interval measurements from interval measuring components
- **Aggregator Scalar (D1–AggregatorScalar):** Used to aggregate scalar measurements from scalar measuring components
- **Aggregator Items Measuring Component (D1–AggregatorItems):** Used to aggregate item data
- **Aggregator Billed Service Quantities (D1–AggBilledServiceQuantities):** Used to aggregate billed service quantities from usage transactions
- **Aggregator Customer Quantities (D1–AggregatorCustomerQuantity):** Used to aggregate specific types of customer quantities such as Peak Load Contribution (PLC) and usage factors
- **Aggregator Composite (D1–AggregatorComposite):** Used to aggregate aggregated data from aggregation measuring components (composite aggregation)

These business objects define the Find Constituents and Aggregation algorithms used for aggregation calculations.

Maintaining Aggregation Measuring Components

You use the **Totals and Trends View** portal to maintain aggregation measuring components.

Refer to [About Aggregation Measuring Components](#) for additional information.

You can access this portal by selecting an aggregation measuring component from the **Measuring Component Set Participants** zone in the **Measuring Component Set** portal. Once your record has been selected you are brought to the maintenance portal to view and maintain the selected record.

This portal includes the following zones:

- **Measuring Component:** This zone displays the basic attributes of the aggregation measuring component
- **Measuring Component Attributes:** This zone displays attributes that describe the dimensions and criteria for the aggregation measuring component
- **Related Measuring Component Sets:** This zone displays the measuring component sets related to the aggregation measuring component
- **Final Values Overlay:** This zone graphs final measurements for a measuring component, and provides the ability to overlay the graphed data with final measurements from other measuring components. The zone also permits overlaying data from the same measuring component for different time periods, as well as data from measuring components that measuring different quantities, such as temperature.
- **Interval - Audit View:** This zone allows users to view an interval measurement curve for a given period overlaid with the count of audit records for each individual measurement. It also allows users to magnify a portion of the curve and see how the measurements looked at different points in time.
- **Measurements - Interval:** This zone displays measurement details for the aggregation measuring component
- **Usage Subscriptions Directly Linked to MC:** This zone displays usage subscriptions that are directly linked to the aggregation measuring component
- **Time of Use Overlay:** This zone displays an overlay of the TOU periods on measurement data along with totalized TOU consumption based on a user-defined time period and TOU map

Master Data Sync

The synchronization of master data into Oracle Utilities Meter Data Management is covered in detail in the [Integrations](#) section of the *Oracle Utilities Meter Solution Administrative User Guide*.

Outage Storm Mode

About Outage Storm Mode

Unfortunately, utilities and their customers are often subject to natural disasters that cause disruptions to AMI networks. These outage events can be related to hurricanes, tornadoes, ice storms, earthquakes, tsunamis, etc. During these severe outages, AMI systems do not always provide outage and restoration events from the devices. Without these outage and restoration events, Oracle Utilities Meter Data Management processes could estimate measurements that would be billed by the CIS. This will lead to unhappy customers, potentially bad press, and lots of manual cleanup work after the fact.

While this is a problem for major outage events, this can also occur with smaller outages (smaller blackouts, planned outages, etc.). This can potentially become an issue anytime the AMI network has a significant number of devices failing to communicate.

This module includes outage processing to improve estimation accuracy during major outages. The system will automatically stop estimations when the number of meter readings coming is less than a user defined tolerance. This tolerance is based on a significant drop in the read percentage for all devices in a similar postal code, service type, and Head End. Estimations will automatically resume when the device returns to normal operation. This can occur through a number

of actions: read percentage for the surrounding area returns to normal, regular data is received from the device, or a power restoration device event is received from the device.

Oracle Utilities Meter Data Management also includes the ability to manually override "storm mode". This override will allow estimations to resume even if the outage hasn't been fully resolved. This will be useful if network fixes take too long and the utility has decided that customers should be billed on an estimate after a few days pass.

NOTE: For information on configuration, reference the related section for [Outage Storm Mode](#) in the Administration Guide.

The diagram below illustrates the primary flow for Outage Storm Mode processing. The steps include:

1. The **Dimension Scanner** batch (D1-ADS) monitors the **Meter Communication Tracking Dimension Scanner** business object. New Aggregator Measuring Components will be created for every applicable Service Type, Postal Code, and Head End in the system.
2. The **Aggregation Monitor** batch (D2-AGG) runs to execute the logic for the **Meter Communication Tracking Aggregator** Measuring Component. This logic will aggregate all meters for the defined Service Type, Postal Code, and Head End. Once the read percentage is found for that day then a measurement will be created for the Aggregator Measuring Component.
3. The **Widespread Outage** batch (D2-WSO) runs to determine if any of the "Meter Communication Tracking Aggregator" Measuring Components have dropped below the defined threshold on the MDM Master Configuration. If it has dropped enough, then an **Estimation Suppression** Activity is created for each of the affected Service Points and the "Meter Communication Tracking Aggregator" Measuring Component is set to an "Active Outage" indicator.
4. If the **Smart Meter Monitor** batch (D1-SMMTR) runs to generate estimates while an Estimation Suppression Activity is active for a Service Point, then the Service Point will either be skipped for estimation or will have zero consumption filled for all data with a condition code of "No Read - Outage Fill".
5. There are a number of methods available to resume normal operation and close out the Estimation Suppression Activity. These include the following:
 - a. The read percentage reaches a "normal level" again as defined in the MDM Master Configuration. This will be detected by the **Widespread Outage** batch (D2-WSO).
 - b. When non-estimated data is received from a device, this will close out an open Estimation Suppression Activity.
 - c. If the **Standard Event Name** Extendable Lookup is configured with the End Estimation Suppression algorithm (D2-EN-ESTSUP), then any Power Up event this is configured for will close out an open Estimation Suppression Activity.
 - d. Estimation Suppression Activities can also be closed manually by a user by navigating to the Activity, using the "Edit" button", and add an End Date.
6. The **Estimation Suppression Monitor** batch (D2-ESTSU) runs for all Estimation Suppression Activities to determine if the related "Meter Communication Tracking Aggregator" Measuring Component is no longer in a state of "Active Outage". If the widespread outage has ended, then the Estimation Suppression activity will be set with an end date.
7. The next time the **Smart Meter Monitor** batch (D1-SMMTR) runs it will generate estimated data as normally configured.

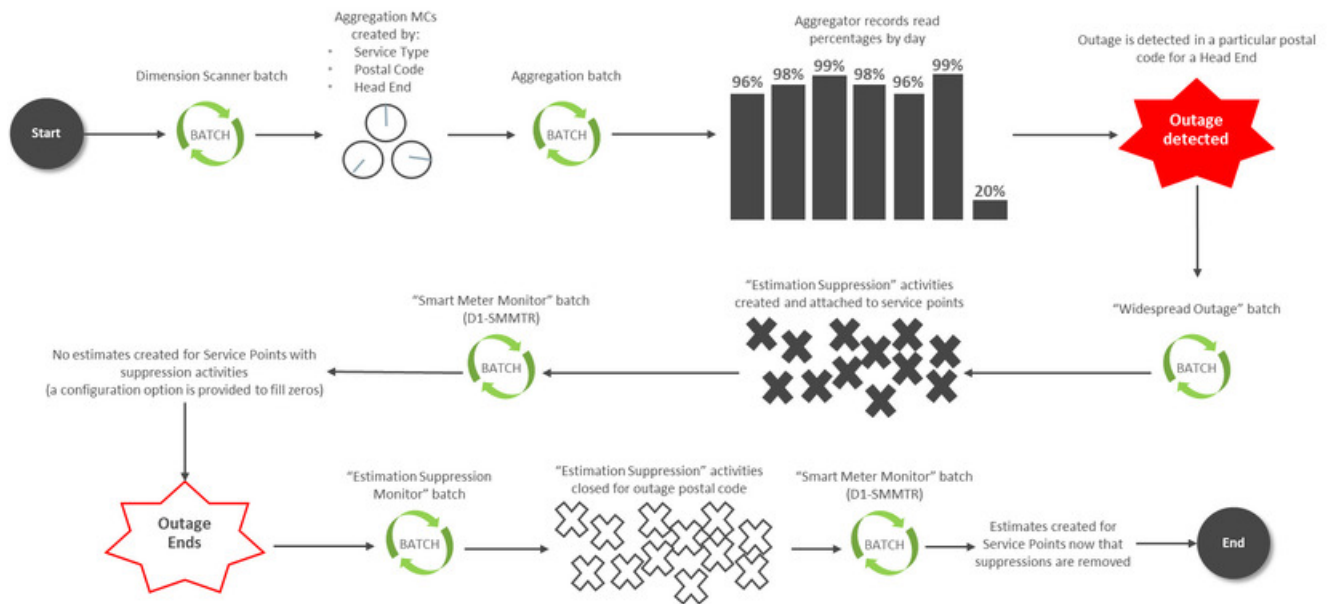

In order to determine if an area is experiencing a widespread outage, the median read percentage of prior days is used as the basis for comparison. The median was chosen instead of the average to help reduce the impact of outlier values. This is illustrated in the example below.

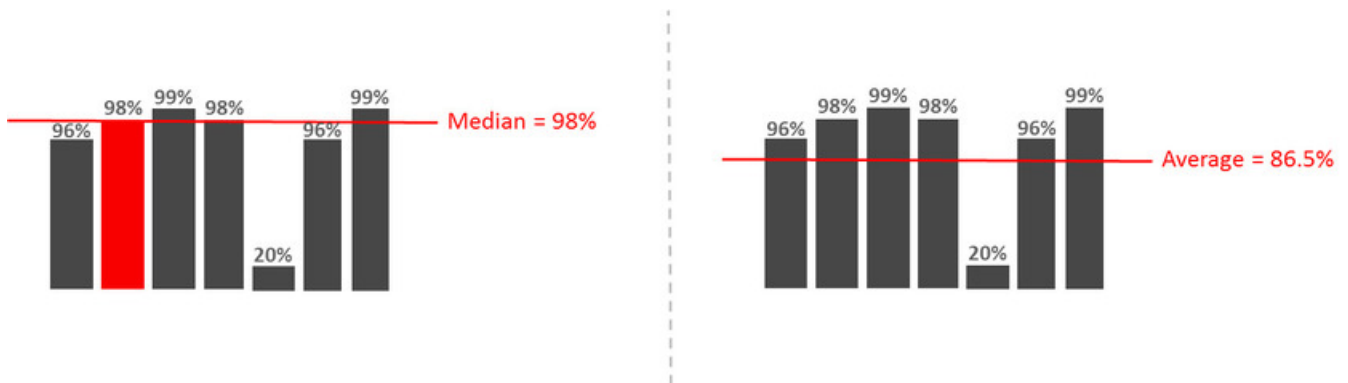

Reviewing Widespread Outages

Anytime a **Meter Communication Tracking Aggregator** Measuring Component is marked with an indicator of "Active Outage", a To Do will be generated for user review. The base To Do Type for this is "Widespread Outage" (D2-WSOTD). This To Do is meant to serve as a warning to users that one of the areas in the service territory is experiencing a widespread outage.

If there is a desire to continue processing as normal and not have estimation suppressed, then you can override the Meter Communication Tracking Aggregator by hitting the "Force Complete Outage" button while reviewing the To Do. This will mark the Widespread Outage Indicator as "User Override" and will allow estimation to continue normally.

Dashboards

About Dashboards

Dashboards provide a broad view of numerous metrics used with Oracle Utilities Customer To Meter. The data presented on each dashboard is tailored to provide operational as well as analytical information for management. On some graphs, drill down options are provided to retrieve more detailed information about the metrics provided.

For information on configuration, reference the related section for [Defining Dashboard Options](#) in the *Oracle Utilities Customer To Meter Administrative User Guide*.

Using the Customer Operational Dashboard

This portal is used to display the Customer Operational Dashboard.

You can access the portal from the **Main > Dashboards > Customer Operational Dashboard**. Once you've selected this menu option, you're immediately brought to the initial tab of the dashboard.

The **Billing** tab displays the following zones:

- **Billing Trend:** displays bill completion counts and billed amounts by date.
- **Bill Print Trend:** displays bill print counts by date.
- **Open Bill Issues Trend:** displays open bill issue counts by date.

The **Payment** tab displays the following zones:

- **Payment Trend - All Sources:** displays payment counts and payment amounts from all sources.
- **Payment Trend - Upload:** displays upload payment counts and payment amounts.

The **To Do** tab displays the following zones:

- **To Do Completion By User:** displays To Do completion counts by user.
- **To Do Work Time By User:** displays average To Do work time by user.

The **Batch Performance** tab shows a series of zones related to any defined Performance Targets for batches. More information on Performance Targets can be found in the Framework guide.

Refer to [About Dashboards](#) for additional functional information. For information on configuration, refer to the related section for [Configuring the Customer Operational Dashboard](#) in the *Oracle Utilities Customer To Meter Administrative User Guide*.

Refer to each zone's embedded help for more information.

Using the Meter Operational Dashboard

This portal is used to display the Meter Operational Dashboard.

You can access the portal by selecting **Main , Dashboards, Meter Operational Dashboard**. Once you've selected this menu option, you're immediately brought to the initial tab of the dashboard.

The **Meter Operational Dashboard** contains three tabs:

- [Operations](#)
- [Batch Performance](#)
- [Meter Health Check](#)

Using the Operations Tab

The **Operations** tab displays the following zones:

- **IMD Loading Trend**: displays the count of initial measurement data that's loaded each day by Head End system.
- **Device Event Loading Trend**: displays the count of device event data that's loaded each day by Head End system.
- **Incomplete IMDs by Status**: displays a set of counts for initial measurement data by status.
- **Incomplete IMDs Trend**: displays a set of counts for initial measurement data for each day by status
- **VEE To Dos by Exception Type**: displays a set of counts for VEE Exceptions by Exception Type that also still have a To Do that's incomplete.
- **VEE To Dos Trend**: displays a set of counts for VEE Exceptions by Exception Type for each day that also still have a To Do that's incomplete.
- **Usage Transactions by Status**: displays a set of counts for usage transactions by status.
- **Usage Transactions Trend**: displays a set of counts for usage transactions for each day by status.
- **Usage Transaction To Dos by Exception**: displays a set of counts for Usage Transaction Exceptions by Exception Type that also still have a To Do that's incomplete.
- **Usage Transaction To Dos Trend**: displays a set of counts for Usage Transaction Exceptions by Exception Type for each day that also still have a To Do that's incomplete.

Click **Configure** to navigate to the MDM Operational Dashboard Configuration master configuration. See [Configuring the Meter Operational Dashboard](#) in the *Administrative User Guide* for information regarding configuration of the dashboard.

Filtering by Division

Data displayed in the zones on the **Operations** tab (except the **IMD Loading Trend** and **Device Event Loading Trend** zones) can be filtered by Division. To enable filtering by Division set the **Restrict Division** setting in the **Control by Division** section in the MDM Master Configuration to "Yes". If this is set to "No" the zones display data for all divisions.

When filtering is enabled, the **Division** drop-down list allows the user to select the Division for which they wish to view data. Available divisions are based on the divisions assigned to the user in the **User Miscellaneous Information** zone on the **Miscellaneous** tab of the **User** portal. The division marked "Use As Primary" is the default.

Using the Batch Performance Tab

The **Batch Performance** tab shows a series of zones related to any defined batch-based Performance Targets

Click **Configure** to navigate to the **Performance Target** portal. See [Measuring Performance](#) in the *Administrative User Guide* for information.

Using the Meter Health Check Tab

The **Meter Health Check** tab includes a set of zones displaying data related to initial measurement processing and quality. These include:

- [IMD Processing Trend](#)
- [IMD Processing Detail](#)
- [IMD Quality Trend](#)
- [IMD Quality Detail](#)

Click **Configure** to navigate to the Meter Health Check Dashboard Configuration master configuration. See [Configuring the Meter Health Check Dashboard](#) in the *Administrative User Guide* for information regarding configuration of the dashboard.

IMD Processing Trend

The **IMD Processing Trend** zone displays the number of initial measurements and calculated numbers of constituent measurements for each day in the selected time period. The x-axis displays individual dates during the selected period. The left y-axis shows the average and maximum number of measurements per initial measurement. The right y-axis shows the number of initial measurements. The graph shows the following:

- **IMD Records:** The number of initial measurements processed on each day in the selected time period.
- **Average Measurements:** The average number of measurement values (for example, individual interval values) per initial measurement on each day in the selected time period. This is calculated by dividing the number of measurements in all of the initial measurements on the day in question by the number of initial measurements on the day in question. The number of measurements is based on the Start Date/Time, End Date/Time, and the interval size of each initial measurement.
- **Maximum Measurements:** The maximum number of measurement values (for example, individual interval values) per initial measurement on each day in the selected time period. This is calculated by dividing the largest number of measurements in all of the initial measurements on the day in question by the number of initial measurements on the day in question. The number of measurements is based on the Start Date/Time, End Date/Time, and the interval size of each initial measurement.

You can filter the data displayed using the following controls:

- **Period View:** Specifies the range of data displayed. Options include Thirty Days, Seven Days, Three Days, or One Day. The default is "Seven Days".
- **Interval/Scalar:** Specifies whether the graph should display only interval initial measurements, scalar initial measurements, or both. The default is "Show All".
- **Business Object:** Specifies the initial measurement business object(s) related to the initial measurements displayed in the graph. The default is "Show All".
- **Status:** Specifies the status (Pending, VEE Ready, Exception, Error, Finalized, and so on) of the initial measurements displayed in the graph. The default is "Show All".
- **Data Source:** Specifies the data source (if any) of the initial measurements displayed in the graph. The default is "Show All".

Click on the labels on the legend below the graph to hide/show specific metrics.

This zone displays data from statistics snapshots based on the IMD Processing Snapshot - Hourly (D1-IMDProcessingHourly) business object. The **Snapshot Date/Time** drop-down list (in the lower right corner of the zone) lists all currently available snapshots based on this business object. Filtering options are based on data available in the snapshot. For example, if all of the initial measurements processed for a specific snapshot are all interval initial measurements, the "scalar" option wouldn't appear in the **Interval/Scalar** drop-down list.

Other metrics, including File Count (the number of payload files processed) and Total Measurements, Average Age, and Maximum Age can be viewed from the statistics snapshot.

Click **Capture** (next to **Snapshot Date/Time** in the lower right corner of the zone) to navigate to the **Statistics Control** portal where you can view a list of snapshots for the statistics control, view details of a specific snapshot, and create a new snapshot if needed.

IMD Processing Detail

The **IMD Processing Detail** zone displays details from the most recent snapshot based on the IMD Processing Snapshot - Hourly (D1-IMDProcessingHourly) business object. By default this zone displays a tabular view of the data from the

snapshot, with each row in the table representing a unique combination of business object, interval/scalar flag, and status. This table includes the following:

- **Date Time:** The date and time on which the initial measurements captured in the row were processed
- **Business Object:** The business object of the initial measurements captured in the row
- **Interval/Scalar:** A flag designating if the data captured in the row is interval (D1IN) or scalar (DISC)
- **Status:** The status of the initial measurements captured in the row
- **Description:** A description of the initial measurements captured in the row
- **IMD Records:** The number of initial measurements processed for the unique combination of business object, interval/scalar, and status captured in the row
- **Average Measurements:** The average number of measurements (Total Measurements divided by IMD Records) per initial measurement captured in the row
- **Maximum Measurements:** The maximum number of measurements per initial measurement captured in the row
- **Total Measurements:** The total number of measurements values in the initial measurements captured in the row

To view a bar chart version of this data, click the **Bar** icon (to the upper right of the table).

IMD Quality Trend

The **IMD Quality Trend** zone displays the number of Validation, Editing, and Estimation (VEE) exceptions and calculated numbers of measurements for each day in the selected time period. The x-axis displays individual dates during the selected period. The left y-axis shows the average and maximum number of measurements per initial measurement. The right y-axis shows the number of VEE exceptions. The graph shows the following:

- **VEE Exceptions:** The number of VEE exceptions processed on each day in the selected time period.
- **Average Measurements:** The average number of measurement values (for example, individual interval values) per initial measurement on each day in the selected time period. This is calculated by dividing the number of measurements in all of the initial measurements on the day in question by the number of initial measurements on the day in question. The number of measurements is based on the Start Date/Time, End Date/Time, and the interval size of each initial measurement.
- **Maximum Measurements:** The maximum number of measurement values (for example, individual interval values) per initial measurement on each day in the selected time period. This is calculated by dividing the largest number of measurements in all of the initial measurements on the day in question by the number of initial measurements on the day in question. The number of measurements is based on the Start Date/Time, End Date/Time, and the interval size of each initial measurement.

You can filter the data displayed using the following controls:

- **Period View:** Specifies the range of data displayed. Options include Thirty Days, Seven Days, Three Days, or One Day. The default is "Seven Days".
- **Interval/Scalar:** Specifies whether the graph should display data for only interval initial measurements, scalar initial measurements, or both. The default is "Show All".
- **Business Object:** Specifies the initial measurement business object(s) related to the data displayed in the graph. The default is "Show All".
- **Exception Type:** Specifies the exception type (Insufficient Input Data, Device Identifier Discrepancy, and so on) of the VEE exceptions displayed in the graph. The default is "Show All".
- **Data Source:** Specifies the data source (if any) of the data displayed in the graph. The default is "Show All".

Click on the labels on the legend below the graph to hide/show specific metrics.

This zone displays data from statistics snapshots based on the IMD Quality Snapshot - Hourly (D1-IMDQualityHourly) business object. The **Snapshot Date/Time** drop-down list (in the lower right corner of the zone) lists all currently available snapshots based on this business object. Filtering options are based on data available in the snapshot. For example, if all

of the VEE exceptions processed for a specific snapshot are all based on interval initial measurements, the "scalar" option wouldn't appear in the **Interval/Scalar** drop-down list.

Other metrics, including File Count (the number of payload files processed) and Total Measurements, Average Age, and Maximum Age can be viewed from the statistics snapshot.

Click **Capture** (next to **Snapshot Date/Time** in the lower right corner of the zone) to navigate to the **Statistics Control** portal where you can view a list of snapshots for the statistics control, view details of a specific snapshot, and create a new snapshot if needed.

IMD Quality Details

The **IMD Quality Detail** zone displays details from the most recent snapshot based on the IMD Quality Snapshot - Hourly (D1-IMDQualityHourly) business object. By default this zone displays a tabular view of the data from the snapshot, with each row in the table representing a unique combination of business object, interval/scalar flag, and status. This table includes the following:

- **Date Time:** The date and time on which the VEE exceptions captured in the row were processed
- **Business Object:** The business object of the initial measurements on which the VEE exceptions captured in the row are based
- **Interval /Scalar:** A flag designating if the VEE exceptions captured in the row are based on interval (D1IN) or scalar (D1SC) initial measurements
- **Exception Type:** The exception type of the VEE exceptions captured in the row
- **Description:** A description of the VEE exception type captured in the row
- **VEE Exceptions:** The number of VEE exceptions processed for the unique combination of business object, interval/scalar, and exception type captured in the row
- **Average Measurements:** The average number of measurements (Total Measurements divided by VEE Exceptions) per initial measurement on which the VEE exceptions captured in the row are based
- **Maximum Measurements:** The maximum number of measurements per initial measurement on which the VEE exceptions captured in the row are based
- **Total Measurements:** The total number of measurements values in the initial measurements on which the VEE exceptions captured in the row are based

To view a bar chart version of this data, click the **Bar** icon (to the upper right of the table).

Using the Service Order Operational Dashboard

This portal is used to display the Service Order Operational Dashboard.

You can access the portal from the **Main > Dashboards > Service Order Operational Dashboard**. Once you've selected this menu option, you're immediately brought to the initial tab of the dashboard.

The following zones may appear as part of the portal's **Main** tab page:

- **In-Flight Activities By Type:** shows the distribution of in-flight Activities (in progress or in error) by Activity Type.
- **In-Flight Activity Trend:** shows the number of activities that are in-flight on a given day.
- **In-Flight Activities with Issues:** presents a bar chart that indicates the number of activities with issues.
- **In-Flight Activity Status Distribution:** presents a pie chart that displays the distribution of statuses of in-flight activities.
- **Efficiency Trend for In-Flight Activities:** presents a stacked bar chart that displays the distribution of in-flight activity processing efficiency relative to configurable tolerance.

- **Service Order To Do Summary:** this zone uses horizontal bars to highlight the relative number of open To Dos for a set of To Do Types related to Service Order Management.

Refer to [About Dashboards](#) for additional functional information. For information on configuration, refer to the related section for [Configuring the Service Order Operational Dashboard](#) in the Administrative User's Guide.

Using the Service Order Trends Dashboard

This portal is used to display the Service Order Operational Dashboard.

You can access the portal from the **Main > Dashboards > Service Order Trends Dashboard**. Once you've selected this menu option, you're immediately brought to the initial tab of the dashboard.

The following zones may appear as part of the portal's **Main** tab page:

- **Orchestration Issues Trend:** contains a stacked bar chart showing issues by category and Activity Type.
- **Issue Distribution Over Time:** contains a pie chart showing the distribution of activity issues over a range of days.
- **Activity Success Trend:** shows successful activities over a range of days.
- **Activity Creation Trend:** shows activities created over a range of days.
- **Activity Completion Efficiency Over Time:** shows the efficiency of activity completion over a range of days.

Refer to [About Dashboards](#) for additional functional information. For information on configuration, refer to the related section for [Configuring the Service Order Trends Dashboard](#) in the Administration Guide.

Totals and Trends

Processing Statistics

About Processing Statistics

Upload statistics (or upload stats) are statistics related to the uploading of initial measurement data and device events sent from a head-end system.

Upload statistics are defined as activities in Oracle Utilities Smart Grid Gateway.

There are three types of upload statistics activities:

Payload Statistics: Contains statistics related to a specific payload (file) containing one or more initial measurements or device events. Payload Statistics activities contain:

- Basic information about the payload (head-end system, file name, and status)
- Middleware statistics including specifics about the file, the total number of initial measurements or device events processed, the number of initial measurement or device events errors, and total processing time
- Initial measurement statistics including the number of initial measurements processed
- Device event statistics including the number of device events processed

Payload Error Notification: Contains details concerning processing errors encountered in an individual payload (file) containing one or more initial measurements or device events. Payload Error Notification activities are related to Payload Statistics activities.

Payload Summary: Contains processing summary statistics for an individual payload (file) containing one or more initial measurements or device events. Payload Summary activities are related to Payload Statistics activities, and are used to update related payload statistics upon the completion of payload processing.

Upload statistics activities are created during processing of payload files as follows:

- When processing begins for a payload, a Payload Statistics activity is created to record the process.
- If an error occurs during processing, a Payload Error Notification activity is created.
- When payload processing is complete, a Payload Summary activity is created, which in turn, updates the Payload Statistics activity with details concerning the processing of the payload, including (the start and end time of the processing, the total processing time, the number of initial measurements or device events processed, and the number of initial measurement or device event errors (if any)).

About Head-End System Processing Statistics

Head-end system processing statistics are summarized processing statistics for payloads received from a given head-end system.

As Oracle Utilities Smart Grid Gateway processes payloads containing initial measurements or device events, statistics for each payload are captured in Payload Statistics activities. Over time, payload statistics for each head-end system are summarized to allow administrators to view statistics summary for the head-end system.

Head-end system processing statistics are stored as aggregated measurements for aggregator measuring components. A separate aggregator measuring component must be set up for each head-end system for which processing statistics will be aggregated.

Consumption Statistics

Please refer to the [About Aggregation](#) section for information on consumption statistics.

Time Zone Support

Daylight Savings Time Support

This section describes how the Oracle Utilities Service and Measurement Data Foundation and its related products support Daylight Saving Time (DST).

All date/times in the system are displayed adjusted for daylight savings time (when in effect). However, not all date/times in the system are stored in daylight savings time:

- Stored in Standard (not adjusted for DST): data that is highly sensitive to DST shifts are stored in standard time without any shifts, this means they have a consistent 24 hour day each day all year and avoid issues that arise from a skipped hour when transitioning to DST and a duplicate hour when transitioning out of DST. For example: initial measurement data, final measurements, device events, TOU map data.
- These date/times are adjusted for daylight savings time prior to being displayed to a user.
- Stored in Legal (adjusted for DST): data that is not as sensitive to DST time shifts are stored in legal time. For example, device configurations, service points, installation events, usage subscriptions, usage transactions.

Adjusting Date/times Upon Receipt

The two largest sources of imported data to the system can be sent in a mixture of date/time formats some in legal time some in standard time:

- Initial Measurement Data
- Device Events

Since both sets of data are sent by head end systems and each head end system handles date/times differently, potentially even differing by device, the interface must be extremely flexible in how it handles date/times. In order to ensure data is accurately stored and processed the system must know how a given meter sends date/time information. This is defined on the device through the Incoming Data Shift field:

- Always in Standard Time: No special handling is required.
- Always in Legal Time: All date/times for the initial measurement data or device event will be converted from legal time into standard time.
- In circumstances where a date/time is received in legal time and it falls on the duplicate hour that occurs when DST ends special logic will be executed to identify whether that hour is the first (still in DST) or second (no longer in DST) of the duplicate hours. If for some reason it cannot be identified which hour it is the transaction will go into error.

Daylight Savings Time Interval Conversion Examples

The following examples show how data received legal time will be shifted into standard time for an interval meter that is read on an hourly basis.

Daylight Savings not in Effect

Date/Time Received in Legal	Date/Time Stored in Standard
01/14/2010 12:00AM	01/14/2010 12:00AM
01/14/2010 1:00AM	01/14/2010 1:00AM
01/14/2010 2:00AM	01/14/2010 2:00AM
01/14/2010 3:00AM	01/14/2010 3:00AM
01/14/2010 4:00AM	01/14/2010 4:00AM
01/14/2010 5:00AM	01/14/2010 5:00AM

Daylight Savings Starts (Spring Forward) - No 2AM interval

Date/Time Received in Legal	Date/Time Stored in Standard
03/14/2010 12:00AM	03/14/2010 12:00AM
03/14/2010 1:00AM	03/14/2010 1:00AM
03/14/2010 3:00AM	03/14/2010 2:00AM
03/14/2010 4:00AM	03/14/2010 3:00AM
03/14/2010 5:00AM	03/14/2010 4:00AM
03/14/2010 6:00AM	03/14/2010 5:00AM

Daylight Savings in Effect

Date/Time Received in Legal	Date/Time Stored in Standard
06/14/2010 12:00AM	06/13/2010 11:00PM

06/14/2010 1:00AM	06/14/2010 12:00AM
06/14/2010 2:00AM	06/14/2010 1:00AM
06/14/2010 3:00AM	06/14/2010 2:00AM
06/14/2010 4:00AM	06/14/2010 3:00AM
06/14/2010 5:00AM	06/14/2010 4:00AM

Daylight Savings Ends (Fallback) - Duplicate 1AM

Date/Time Received in Legal	Date/Time Stored in Standard
11/7/2010 12:00AM	11/6/2010 11:00PM
11/7/2010 1:00AM	11/7/2010 12:00AM
11/7/2010 1:00AM	11/7/2010 100AM
11/7/2010 2:00AM	11/7/2010 2:00AM
11/7/2010 3:00AM	11/7/2010 3:00AM
11/7/2010 4:00AM	11/7/2010 4:00AM

Daylight Savings Impact on Periodic Estimation

In periodic estimation both the interval and scalar versions can be impacted by daylight savings time:

- Interval periodic estimation using the "Predictable Cut-off" method.
- All scalar periodic estimation

Refer to [About Periodic Estimation](#) for more information about the impact of Daylight Savings Time on periodic estimation.

Multiple Time Zone Support

Some utilities have operations in more than a single time zone. When operating in multiple time zones, Oracle Utilities Meter Data Management and Smart Grid Gateway provide the following high level functionality:

- The ability to receive data in any time zone and convert it to the common time zone used by Oracle Utilities Meter Data Management (as defined by the base time zone)
- The ability to display functional date/times in the time zone of a given device, service point, usage subscription
- The ability to define what time zone a measuring component, device configuration, service point, or usage subscription resides in
- The ability to aggregate data across time zones into a single time zone or without respect to a time zone (see Aggregations on page E-17 for more information).
- The ability to export data to an external system with the appropriate time zone information to enable the external system to consume data from different service points in different time zones

By default, the system assumes only a single time zone is supported. To enable support for multiple time zones it requires that adding the appropriate entry to the general system configuration feature configuration.

Refer to [Configuring Feature Configurations](#) for additional on the feature configuration options available.

Date/Time Storage and Display

All date/times in the system are stored in the base time zone. Date/times are stored in either standard time or legal time and this determination is made based on the type of data (e.g. measurements are in standard but installation event date/times are in legal).

All date/times are displayed in legal time. Those date/times that are key functional date/times related to a device, service point, or usage subscription will be displayed in the legal time of the time zone the device resides in.

Refer to the [Glossary of Terms](#) for a more detailed definition of Standard and Legal time.

Time Zone Hierarchy and Maintenance

A time zone can be defined at many points within the device to usage subscription hierarchy. This enables the time zone to be accurately portrayed based on the installation status of that device (e.g. not installed, installed but not billed, billed). At each stage of the hierarchy the time zones must match.

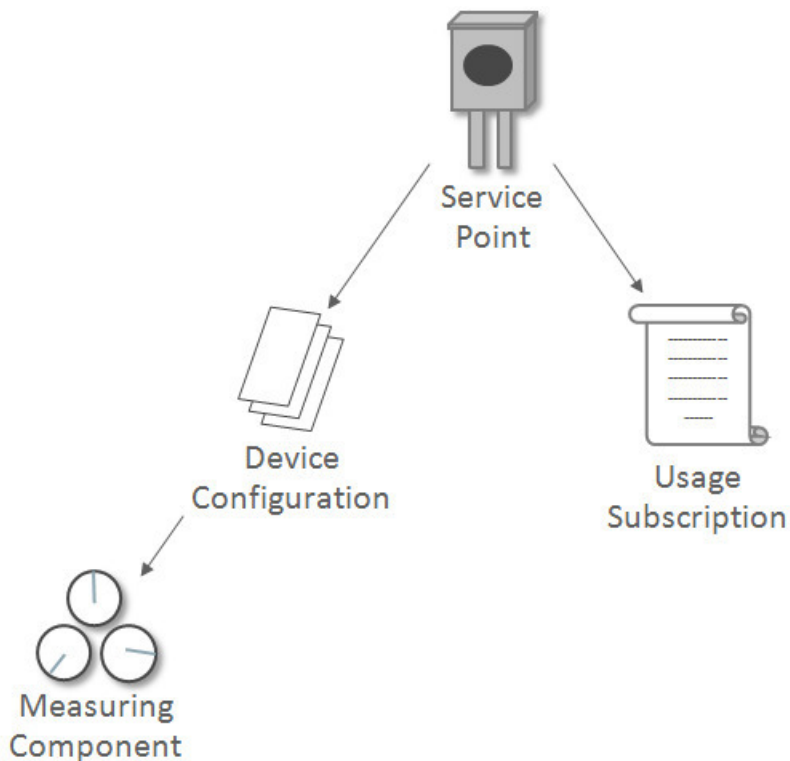

Once the hierarchy has been established no one portion of that hierarchy can be changed to a time zone that differs from the other levels of the hierarchy. In order to change the time zone for an established device to usage subscription hierarchy the change must be done to the service point. Once the service point time zone has been changed the system will cascade that change to all other levels of the hierarchy.

If a device has been installed at a service point in order for it to be moved to a different service point in a different time zone. It will require that a new device configuration be created for time zone of the new service point since a device configuration cannot be associated to two different service points each with a different time zone from the device configuration.

Note: If the time zone for a device that has existing measurements has been changed there will be no automatic adjustments made to the underlying measurement data. If the measurement data must be changed it will require manual intervention.

Note: Although measuring component has time zone it is not populated on physical devices that are installed at service points. This time zone is used for standalone measuring components.

Impacts on Aggregations

In aggregation there are two use cases for how data should be aggregated for service points that exist in differing time zones:

- **Absolute Time:** If a time zone is provided on the measuring component or measuring component type, then the aggregation horizon date/times will be used across service points of differing time zones. For example the 4/1/2010 12AM interval in US/Pacific would be combined with the 4/1/2010 3AM interval in US/Eastern. Since all date/times are stored in the base time zone there is no need to do time zone conversions.
- **Local Time:** If no time zone is specified, consumption is aggregated by converting the aggregation horizon to the appropriate time zone for each service point. For example the 4/1/2010 12AM interval in US/Pacific would be combined with the 4/1/2010 12AM interval in US/Eastern.

Aggregation Measuring Components in general do not have any time zone related dependencies with other master configuration objects. However, when an aggregator is listed as a direct channel measuring component on a usage subscription it share the same time zone as the Usage Subscription.

Impacts on TOU Map Generation

The date and times defined on a [Time of Use Mapping Templates](#) (TOU) do not have a time zone associated to them and will be interpreted based on the time zone of the TOU map type of the specific TOU Map being processed. This allows for a single definition of a TOU schedule that can be applied across many different time zones.

During the generation of the TOU map data for a given TOU map template the date/times will be converted from the time zone of the TOU map to the time zone defined in the base time zone defined on the [installation options - framework](#). For example, if 1/1/2010 5:00PM was considered to be "On Peak" and the system time zone was UTC -08:00 and the TOU map time zone was UTC -05:00 then the TOU map data entry would be written as 1/1/2010 2:00PM.

Impacts on Factors

Factor effective dates do not have a time zone associated to them and are assumed to be in the local time zone of the data being validated. For example a factor effective 4/1/2010 12:00AM would be considered to be effective 4/1/2010 12:00AM UTC -08:00 and 4/1/2010 12:00AM UTC -05:00 based on the time zones of the respective meters. This allows a single factor to apply to many time zones and behave uniformly.

Impacts on Holidays

Holiday effective dates do not have a time zone associated to them and are assumed to be in the local time zone of the data being validated. For example a holiday on 12/25/2010 would be considered to be effective beginning 12/25/2010 12:00AM UTC -08:00 and 12/25/2010 12:00AM UTC -05:00 based on the time zones of the respective meters.

Impacts on Periodic Estimation

Refer to [About Periodic Estimation](#) for more information about the impact of Daylight Savings Time on periodic estimation.

Impacts on Initial Measurement Creation Online

When creating initial measurements online from the 360 Degree View portals, initial measurements are created as appropriate for measuring components with time zones other than the base time zone.

For example, if you copy measurements from a measuring component in one time zone to a measuring component in a different time zone, the measurements are being moved in absolute time (i.e. the 3:00 PM in UTC -08:00 would be changed 6:00PM in UTC -05:00).

Impacts on Items

The consumption for "badged" and "unbadged" items is driven by configuration on the device type service quantity and the multi-item section of the service point:

- **Device Type Service Quantity:** the effective date of the service quantity does not have a time zone and is assumed to be in the local time zone of the service point it is associated to (whether through a install event for "badged" items or by being directly configured on the service point). For example an effective date time of 1/1/2010 5:00PM would be considered to be effective beginning 1/1/2010 5:00PM UTC -08:00 and 1/1/2010 5:00PM UTC -05:00 based on the time zones of the respective meters
- **Service Point Multi-Item:** the start date time and end date time of the multi-item list are stored in legal time of the base time zone and displayed in the legal time of the service point's time zone.

Service Issue Monitors

About Service Issue Monitors

Service Issue Monitors are service tasks that analyze service points to determine if service is needed. If service is determined to be needed, the Service Issue Monitor creates a Service Investigative Order.

Device events, VEE exceptions, failed smart meter commands, and other events can trigger the creation of a service issue monitor (the type of service issue monitor created is based on the Service Issue Monitor Type specified on the device event type, exception type, or activity type). Once created, service issue monitors analyze the service point where the device associated with the device event, VEE exception, or failed command, based on evaluation criteria specified on the service issue monitor's type. If the criteria are met (in other words, if a specified number of command failures, device events, or VEE exceptions are found for the service point), the service issue monitor creates a service investigative order.

Service Issue Monitor Creation

This section provides an overview of the process that takes place when service issue monitors are created.

NOTE: The process outlined below has been simplified for illustrative purposes, and does not reference every step performed in this process.

1. One (or more) of the following takes place:
 - A device event or reader remark is received, whose type specifies a Service Issues Monitor Type
 - A VEE exception whose type specifies a Service Issues Monitor Type is generated during VEE processing
 - A usage transaction exception generated during usage calculation
 - A smart meter command fails whose type specifies a Service Issues Monitor Type
 - A business flag is received whose type specifies a Service Issue Monitor Type
2. The object received in item (1) creates a service issue monitor based on the referenced Service Issue Monitor Type
3. The service issue monitors analyzes the service point based on the Discard Rules and Evaluation Criteria defined on the service issue monitor's type to determine if a service investigative order should be created or if the service issue monitor should be discarded.

The "Discard Rules" on the service issue monitor's type are evaluated to determine if the new service issue monitor should be discarded (new service issue monitors are always discarded when created if an existing service investigative order initiated by a service issue monitor of the same type exists for the service point.)

If the service issue monitor type was configured to require approval, the service issue monitor generates a To Do to notify the appropriate individuals that approval is necessary.

If the service issue monitor is approved or if no approval was necessary the service investigative order will be continue.

4. The service issue monitor then executes the evaluation criteria defined on the service issue monitor's type. If those criteria are met the Service Investigative Order activity is created. If the criteria are not met the service issue monitor is discarded.
5. If the service issue monitor has completion criteria defined the service issue monitor will wait for the service investigative order to complete. Once complete the the service issue monitor will execute the completion criteria to evaluate if the service investigative order achieved the desired results.

If either there were no completion criteria or they were satisfied the service issue monitor will complete.

If the completion criteria were not satisfied the service issue monitor enter an inconclusive investigation state from which manual intervention will be required.

About Service Investigative Orders

Service investigative orders are activities created by a service issue monitor when a specified set of events have occurred at a service point. The type of activity created by the service issue monitor is defined on the service issue monitor's type.

Service issue monitors are often configured to create field activities that are in turn sent to an external field work system.

Oracle Utilities Rate Cloud Service

Overview

Oracle Utilities Rate Cloud Service provides access to the rate calculation functionality of Oracle Utilities Customer Cloud Service. This includes the ability to configure and test rate calculations via the user interface, as well as the ability to trigger the rate calculation process from an external system.

This section describes the functionality provided with Oracle Utilities Rate Cloud Service.

Note: Oracle Utilities Rate Cloud Service supports rate calculation for traditional scalar or volume-based billing quantities only. It does not include capabilities for generating billing determinants from interval data input.

Setting Up Rates with Oracle Utilities Rate Cloud Service

Oracle Utilities Rate Cloud Service provides access to pages, portals, and zones used to create and maintain rates and rate configuration data, including:

- Bill Factors
- Bill Factor Values
- Calculation Groups
- Calculation Line Category Types
- Calculation Rules
- Rate Schedules

Refer to the [Rates](#) chapter of the *Business User Guide* for detailed information about setting up the above types of configuration data. Note: Some fields and options used with the above types of configuration data are not applicable when using Oracle Utilities Rate Cloud Service when compared to using Oracle Utilities Customer Cloud Service.

Using Rate Check with Oracle Utilities Rate Cloud Service

In addition to rate configuration functionality, Oracle Utilities Rate Cloud Service includes access to the Rate Check feature, which allows users to test their rates.

When using Rate Check, service quantities and characteristic types/values must be provided by the user and entered via the user interface. Oracle Utilities Rate Cloud Service does not support the use of the Rate Check feature based on service agreements, bill segments, or service points.

Refer to the [Rate Check](#) section in the **Rates** chapter of the *Business User Guide* for more information about using the Rate Check feature.

Oracle Utilities Billing Cloud Service

Overview

Oracle Utilities Billing Cloud Service provides access to the billing functionality of Oracle Utilities Customer to Meter, which is the foundational component of Oracle Utilities Customer Cloud Service. This includes the ability to manage customer information, load validated measurement data, calculate billing determinants, configure and test rate calculations, calculate billing charges, aggregate billing related data.

Oracle Utilities Billing Cloud Service is intended for customers who

- May not require a full customer information system implementation
- Customers whose legacy customer information system does not support specific billing capabilities that they may now require such as net-metered billing, billing for electric vehicle charging events, advanced billing for specific customer segments (commercial or industrial), and so on.

This section describes the functionality provided with Oracle Utilities Billing Cloud Service.

Billing Cloud Service Functional Areas

This page outlines the functional areas available with Oracle Utilities Billing Cloud Service. The menus provided with Oracle Utilities Billing Cloud Service display only those menu items that correspond to capabilities that are available with the cloud service.

NOTE: Not all fields and field values available in Oracle Utilities Customer to Meter associated with these menu items are used with Oracle Utilities Billing Cloud Service.

The functional areas listed below are organized based on the main **Menu**.

- 360 Search
- Communication
- Control Central
- Customer Information
- Dashboards
- Data Synchronization
- Device

- Device Installation
- Financial
- Financial Query
- Initial Measurement Data
- Initial Measurement Snapshot
- Market Transaction Management
- Process Flow
- Rates
- Service Task
- To Do
- Total and Trends
- Umbrella Agreement Management
- Usage
- My Preferences
- Tools
- Integration

Refer to specific chapter and sections in the *Business User Guide* for more information about working with these above listed functional areas.

Settlement

Understanding Market Settlement

Market settlement is the process of reconciling the difference between a supplier's energy purchases and its customer's usage. Suppliers purchase energy via bilateral contracts and day-ahead market transactions. Any differences between these purchases and supplier customer usage must be determined by the market and charged or credited at real time prices. The supplier's customer usage is not directly determined by the market, but by numerous other market participants that track customer supplier enrollments, aggregate customer usage to the supplier, and submit supplier's usage schedule to the market. This process is called load settlement, and is the primary purpose of Oracle Utilities Market Settlements Management.

The market participant responsible for load settlement can differ per market. For example, load settlement for a large portion of the Texas market is performed by an Independent System Operator (ISO) known as the Electric Reliability Council of Texas (ERCOT), whereas in the PJM market (encompassing Pennsylvania, New Jersey, and Maryland) load settlement is the responsibility of the Electric Distribution Company (EDC). While there are significant differences between markets in how load settlement is preformed, the high-level process steps are basically the same.

Load settlement starts with the bottom up aggregation of actual load or estimated load for individual customer accounts or service points. Distribution and transmission losses are added in to calculate an unreconciled load amount. The market determines the total generation supplied to a zone and the difference with the unreconciled load is referred to as Unaccounted for Energy (UFE). The UFE is then allocated to suppliers on a load ratio share basis.

The load settlement process is typically performed multiple times. The “preliminary” load settlement is done soon after the Operational Day and is often based on estimated load. The “final” load settlement is done around 60 days after the Operational Day, so that actual data has been received and customer bills issued.

About Market Settlement Processing

Market settlement is the process of deriving billing determinants to be used in supplier billing based on the results of a data aggregation processes.

The load settlement process also involves calculating imbalances. An imbalance is the difference between two load shapes representing different estimates of the same period, typically a scheduled load shape and an actual load shape. Imbalances are typically used when money has changed hands based on an estimate that has been improved or finalized by the settlement process. Because the second estimate has more accurate data, the allocations performed by the first process have to be modified.

Imbalance shapes can be further divided by applying bands and TOU components. Bands are error tolerances around zero that allow for differential pricing of the imbalance curve by how well or poorly the scheduled estimate matched the actual usage. Time of Use periods are often defined, allowing a higher penalty for faulty forecasting during higher-priced, on-peak periods. Whether an imbalance calculation is performed and how it is performed varies greatly from market to market.

The following sections provide details regarding some of the specific processing used in settlement processing.

Importing Data

In addition to customer-level data such as meter readings or billed service quantities (which are used aggregation), settlement processing also involves other data that must be available to the application. For example:

- UFE calculations use both aggregated data and overall system, or zonal, load data
- Estimations and forecasting often use weather data
- Settlement billing requires pricing data

Data of these types can be imported into the system from external sources via a number of ways:

- For external sources that send data on a regular basis, data can be imported in a manner similar to how measurement data is received head end systems. See [Processing Initial Measurement Data](#) in this guide and [Data Import - Message Driven Bean Configuration](#) in the *Oracle Utilities Meter Solution Administrative User Guide* for more information.
- For external systems that send data upon request, data can be requested via measuring component data requests. Requests of this type can be either scheduled or performed manually. See [Requesting Measurement Data](#) in this guide for more information.
- For external systems that make data available for use but don't support sending the data directly, data can be imported manually in a comma separated values (CSV) format. See [Uploading Measurement Data](#) in this guide for more information.

Forecasting and Estimating Usage

Some settlement processes, such as initial settlement, often have to be performed before actual usage has been received or calculated for service points participating in the settlement market. In these cases, usage must be estimated, and in some cases, forecasted before aggregation and other settlement calculations can happen. A forecast is the term used when estimating usage data for future dates based on historical or profile data. Backcasting is the term used for estimating data for dates in the past. These can also be based on historical and/or profile data.

Two specific methods used for forecasting and backcasting include:

- **Profile Estimation:** This method uses profile data that represents typical usage for the service point to estimate usage. In some cases, profile data can also be adjusted based on scalar usage for the same service point.
- **Proxy Day Estimation:** This process compares data between measuring components to identify an historical day that most closely matches the date for which data is needed and uses data from that historical day to estimate usage

Aggregating Data

Aggregation involves summing real or assigned (profiled or deemed) interval data to a user-defined aggregation level for further processing. Aggregation may occur at a variety of levels for a variety of reasons, including reporting requirements and applying losses and other factors at an aggregated level up to the market participation level. Aggregation is typically used to build ground-up estimates of load for energy market participants for forecasting, scheduling, and settlement.

Aggregation is performed using the [Dynamic Aggregation](#) feature of the Oracle Utilities Meter Solution.

Aggregation Levels

Because aggregation involves summing up interval data to a specified level for processing, it's important to understand what is meant by the term "aggregation level" Put simply, an aggregation level is any point along the distribution chain to which entities below that point are summed. For instance, if you were going to sum up all the accounts that are related to a specific bus, that bus would be an aggregation level. Similarly, if you were going to aggregate all the energy used by all the accounts for a given Energy Service Provider (ESP), that ESP would be an aggregation level. In general, aggregation is usually performed at a level below you on the distribution chain from generators to end users.

The entities and/or market participants that serve as aggregation levels are specific to the particular area and market in which your utility is operating, but can include the following:

Energy Service Providers (ESP)

Energy Service Providers (ESPs) sell power to customers. They may generate it and/or buy it from other sources. ESPs are also referred to as Retail Energy Providers (REPs) or simply suppliers.

Distribution Companies (DisCo)

A distribution company is responsible for the delivery of power to all customers in its service territory (Jurisdiction), regardless of who the customers have selected as their suppliers. The DisCo owns and operates the distribution lines that bring electricity into homes and businesses, and is responsible for metering, billing, and service calls. However, a DisCo may or may not be affiliated with a customer's power supplier. Distribution companies are also referred to as Operating Companies, Utility Distribution Companies (UDCs), or Local Distribution Companies (LDCs).

Schedule/Service Coordinators (SC)

Schedule Coordinators (or Service Coordinators) are responsible for creating schedules of energy usage that represent the estimated usage for a future time period (most often one day) for a given segment of the market. Schedules are most often based on results generated during the load profiling process, but can also be based on historical usage information and other data.

Independent System Operators (ISO)

An Independent System Operator (ISO) is a non-profit corporation that manages the regional power grid to coordinate the generation and transmission of energy. Its goal is to guarantee a safe and reliable power supply, and to ensure that all suppliers get nondiscriminatory access to the transmission system (while the ISO controls the power grid, commercial entities still own it). In the U.S. market, ISOs are regulated by the Federal Energy Regulatory Commission (FERC).

The various aggregation levels used in settlement processing are defined by [Aggregation Groups](#), [Measuring Component Sets](#), and [Aggregation Measuring Components](#).

Aggregation Dimensions

In addition to aggregating data by aggregation levels, it is useful to be able to aggregate by other factors, such as customer class, voltage class, or loss class. These and other factors are referred as dimensions and are referenced on [measuring component sets](#). Some common aggregation dimensions are described below. Note that these are provided as examples of common aggregation dimensions only.

Specific markets may require aggregation dimensions other than those listed here.

Customer Class

A customer class represents a ‘type’ of customer or account. Three common customer classes include residential, commercial, and industrial, but others are also prevalent. In addition, there may be multiple types of residential, commercial, or industrial classes, representing distinct types of accounts within each of those broad categories. For instance, residential customers might be divided into apartments, condominiums, and houses.

Voltage Class

A voltage class represents a group of customers or accounts based on the type of voltage used by the end users in that group. Voltage classes differ by market and region, but some common voltage classes include Transmission, Primary, and Secondary. Aggregating by voltage class is often performed for reporting purposes, to track usage of a given voltage type within the system.

Loss Class

A loss class represents a group of customers or accounts based on the type of loss (transmission loss, distribution loss, etc.) associated with those accounts. Loss is often related to voltage levels, and so correlations between loss classes and voltage classes are common. Aggregation by loss class is used when calculating losses in the overall settlement process, and allows different loss calculation algorithms to be used with different loss classes, as appropriate.

Rate Class

A rate class represents a group of customers or accounts based on pricing. Rate classes can be based on a number of characteristics, including usage, territory, or even voltage type.

These and other dimensions are typically defined as attributes or characteristics of usage subscriptions, service points, devices, or measuring components.

Applying Losses

Markets typically operate using generation-level determinants, meaning that the individual metered entity data must be adjusted for system losses in order to compare the market participant load to the system load, market participant schedules, etc. Loss calculations can vary from simple to complex, ranging from an annual percentage by rate class or voltage level, to seasonal or time of use loss factors, to hourly dynamic loss factor calculations based on system conditions. Loss factors can be applied at the metered level or any aggregation level, as needed. In addition, losses can be applied to generators in markets where generation losses are calculated and used.

Applying losses to aggregated data is performed via value derivation algorithms. These are algorithms which apply a configured formula to aggregated measurement values. For instance, to apply a loss factor, an algorithm can retrieve effective-dated factor values for a loss factor and multiply each aggregated measurement value by the appropriate factor value. Value derivation algorithms can retrieve values from all types of factors, including multi-variable factors defined for settlement units. See [Aggregation Calculation — Other Calculations](#) for more information about how losses can be applied during data aggregation.

Unaccounted for Energy (UFE) Calculations

Unaccounted for Energy (UFE) is calculated by comparing the known system load to the sum of all market participant estimates from the estimation, aggregation, and loss adjustment processes. Because the market participant estimates will never perfectly match the system load, these estimates are fine-tuned by allocating a portion of the total UFE to each

estimate. Allocation methods differ, but in general each market participant is allocated a portion of the system UFE for each hour based on the ratio of that particular estimate's load in that hour to the total of all estimated loads in that hour. This process forces the total of all estimates to match the system load. Some markets use different UFE allocation methods, including differential allocation of UFE to interval metered loads apart from profiled loads, and adjusting the profile methodologies to minimize UFE where possible.

UFE calculations are performed as part of the settlement calculation process, and can be performed using the [Measuring Component Set Calculation Rule](#) settlement calculation rule defined in a [Bulk Settlement Calculation Group](#) executed via the Measuring Component Set Calculation (D1-MCSCA) batch process.

For smaller markets, UFE calculations can be performed using a chained sequence of [Array Math](#) and [Vector and Service Quantity Math](#) settlement calculation rules. At a basic level, this sequence looks like this:

1. Sum the market participant load from aggregation results (using Array Math)
2. Subtract the market participant load from the system load to derive the total UFE for the calculation period (using Vector and Service Quantity Math)
3. Allocate the total UFE to the various market participants as appropriate (using Array Math)

NOTE: The results of UFE calculations are also used in other settlement calculations. These three steps represent part of a larger set of calculations.

Allocating Load via Market Products, Awards, and Contracts

Distribution companies operating in deregulated markets are often designated as the Provider of Last Resort (POLR) for customers that either have not selected a supplier or have been dropped by a supplier. If allowed by legal and market rules, the distribution company can elect to outsource the responsibility of supplying POLR load to qualified wholesalers.

The POLR consumers will still, either directly or indirectly, receive bills for distribution services from and pay the distribution company, but the wholesaler takes responsibility for procuring and serving the POLR load, for which they receive payments from the distribution company.

A simple example of the POLR allocation process might involve the following steps:

1. Subtract all other suppliers from the zonal load to get the remaining POLR load.
2. Allow for the distribution company to separate out any owned generation.
3. Divide POLR load amongst awarded wholesale contracts.

Details of these transactions would be sent to the market operator by contract ID.

These awards of POLR load can be defined in the application by [Market Products](#) (which belong to a [Market Product Set](#)), [Market Awards](#), and [Market Contracts](#).

To elaborate on the example above, a market product set might the following set of market products:

- A product and award to carve out load from the POLR load for one or more suppliers. This would be a “Fixed Profile” award.
- A product and award to carve out a percentage of the remaining POLR load for owned generation. This would be a “Percentage” award.
- A product and awards that distribute the remaining POLR into various bundles of tranches (chunks of load) to wholesalers. These would be “Tranche” awards.

The following diagram illustrates the way in which this distribution would work.

Example of energy load being split between awards

POLR Load: 1,000 MWh
Remaining Load: 1,000 MWh

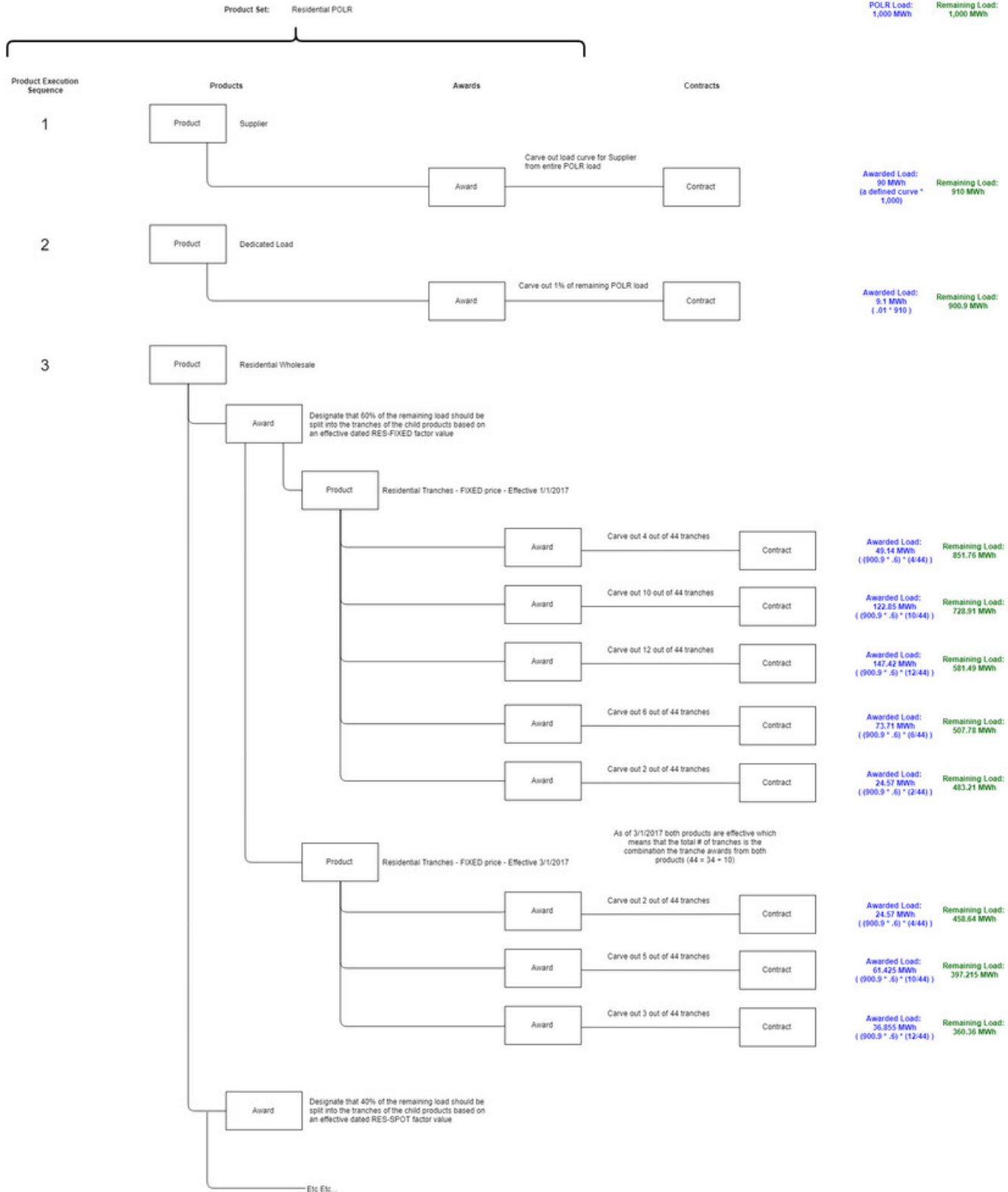

The [Market Award Allocation](#) settlement calculation rule is used to perform the allocation of load the designated market products and awards. This rule is part of a larger settlement calculation process, using settlement quantities (the POLR load) calculated by other rules (such as [Array Math](#) and [Vector and Service Quantity Math](#)). The Market Award Allocation rule allocates those quantities to the products within a specified [Market Product Set](#), and saves the results for export to the appropriate market participants.

Viewing Settlement Calculation Results

You can view settlement calculation results using the Cube Viewer feature of the Oracle Utilities Application Framework. See [Creating Cube Views](#) in the *Oracle Utilities Application Framework Administrative User Guide* for information about configuring cube views.

Viewing and Managing Settlement Processes

You can use the Process Flows feature of the Oracle Utilities Application Framework to create, view, and manage settlement processes. See [Process Flows](#) in the *Oracle Utilities Application Framework Administrative User Guide* for information about configuring cube views.

Settlement Data Snapshots

Settlement data snapshots capture data as of a specific point in time for use in aggregation and settlement calculations. For instance, data snapshots can capture data such as:

- The state of a settlement account (a Settlement Item) as of the last time something about the account changed
- The state of a settlement account as of the last time the account was billed
- Metered measurement data used for initial settlement
- Billed measurement data used for final settlement

There are two general categories of settlement data snapshots:

- Attribute Data Snapshots
- Measurement Data Snapshots

Attribute Values

About Attribute Values

Attribute values represent an instance of an attribute group's values, captured as part of an attribute data snapshot for a settlement item. An individual attribute values record is created for each unique combination of values that exists for the attributes defined in the attribute group.

Attribute values records are created when attribute data snapshots are created or updated for a settlement item.

Attribute values are defined by:

- **Attribute Group:** The attribute group that defines the attributes captured by the attribute values record
- **Division:** The division to which the settlement item captured by the attribute values record belongs
- **Market:** The market in which the settlement item captured by the attribute values record participants.

- **Market Participant:** The market participant associated with the settlement item captured by the attribute values record
- **Rate Class :** The rate class code for the settlement item captured by the attribute values record.
- **Status:** The status of the attribute values record
- **Values:** The specific values captured in the attribute values record, defined by the record's attribute group

Maintaining Attribute Values

You use the **Attribute Value** portal to view and maintain attribute values records.

Refer to [About Attribute Values](#) for additional functional information.

You can access the portal by selecting **Main**, then **Customer Information**, then **Attribute Values**. You are brought to a query portal with options for searching. Once your record has been selected you are brought to the maintenance portal to view and maintain the selected record.

The following zones may appear as part of the portal's **Main** tab page:

- **Attribute Values:** This zone displays the attribute values record.

Attribute Data Snapshots

About Attribute Data Snapshots

Attribute data snapshots are used to capture account data for a settlement item as of a specific point in time, such as the last time an attribute on the account changed or the last time it was billed.

Attribute data snapshots are defined by:

- **Attribute Data Snapshot Type:** The attribute data snapshot type for this snapshot.
- **Division:** The division to which the settlement account captured by the attribute data snapshot belongs.
- **Attribute Value:** The attribute value record that contains attribute values for the attribute data snapshot
- **Status:** The status of the attribute data snapshot
- **Market:** The market in which the settlement account captured by the attribute data snapshot participants.
- **Settlement Item:** The parent settlement item for the attribute data snapshot.
- **Transaction ID:** The transaction ID for the transaction which triggered creation of the data snapshot (such as a usage subscription or account).
- **Start Effective Date/Time:** The start date/time for period represented by the data snapshot.
- **Stop Effective Date/Time:** The stop date/time for period represented by the data snapshot.
- **Time Zone:** The time zone of the settlement account captured by the attribute data snapshot
- **Identifiers:** The specific identifier types and values for the attribute data snapshot's settlement item

Creating Attribute Data Snapshots

Attribute data snapshots are created via batch processing. Attribute data snapshots are typically generated daily (or on some other regular schedule) via the Capture Attribute Data Snapshot (D1-CADS) batch control. This batch process invokes the Capture Attribute Data Snapshot (D1-CAPADS) monitor algorithm on the Active state of the Settlement Item business object.

Attribute data snapshots are created for each change in one of the attributes that has been configured on the Attribute Data Snapshot Type and Attribute Group. The snapshot captures the value of all of the attributes at the time of that change. For

example, for Attribute Data Snapshot Type configured to track Market Participant, Rate Class, and a Characteristic, if the Characteristic value were updated with a new more recently effective value then a snapshot would be created that would capture all 3 fields values (the Market Participant, Rate Class, and new Characteristic value)..

The type of attribute data snapshot(s) created are defined on the the Settlement Item's Settlement Item Type.

Maintaining Attribute Data Snapshots

You use the **Attribute Data Snapshot** portal to view and maintain attribute data snapshots.

Refer to [About Attribute Data Snapshots](#) for additional functional information.

You can access the portal by selecting **Main**, then **Customer Information**, then **Attribute Data Snapshot**. You are brought to a query portal with options for searching. Once your record has been selected you are brought to the maintenance portal to view and maintain the selected record.

The following zones may appear as part of the portal's **Main** tab page:

- **Attribute Data Snapshot:** This zone displays the attribute data snapshot.

Measurement Data Snapshots

About Measurement Data Snapshots

Measurement data snapshots are used to capture measurement data for settlement accounts as of a specific point in time, such as the when the data was used for initial settlement or when the account was billed.

Measurement data snapshots can be created either as part of Meter Data Management usage transaction processing or batch processing. See [Creating Measurement Data Snapshots](#) for more information.

There are two main types of measurement data snapshots: Interval and Scalar.

Interval Measurement Data Snapshots

Interval measurement data snapshots are defined by:

- **Measurement Data Snapshot Type:** The measurement data snapshot type for this snapshot
- **Usage Subscription:** The usage subscription associated with the measurement data captured by the measurement data snapshot
- **Service Point ID:** The service point associated with the measurement data captured by the measurement data snapshot
- **Measuring Component ID:** The measuring component from which the measurement data captured by the measurement data snapshot originated
- **Transaction ID:** The transaction ID for the transaction which triggered creation of the data snapshot (such as an initial measurement, usage transaction, or bill)
- **Start Date/Time:** The start date/time for period represented by the data snapshot
- **Stop Date/Time:** The stop date/time for period represented by the data snapshot
- **Start Date Local :** The start date/time for period represented by the data snapshot represented in local time (if different), used in aggregation processing
- **Missing Interval:** A flag that indicates if the measurement data snapshot contains missing interval
- **Irregular Data:** A flag that indicates if the measurement data snapshot contains irregular data

- **Values:** The interval values for the measurement data captured by the measurement data snapshot. See below for more information about interval measurement data snapshot values.

Interval Measurement Data Snapshot Values

The UOM, TOU, and SQI used to identify measurement values are defined on the measurement data snapshot's type.

Interval measurement data snapshots can contain up to 100 interval values. The interval size of the intervals captured on the data snapshot is defined on the measurement data snapshot's type. The table below lists the maximum duration of snapshots for different common interval sizes (rounded down and based on 96 intervals).

Interval Size	Maximum Measurement Snapshot Duration (rounded down)
01:00:00 (1 hour intervals)	4 days
00:30:00 (30 minute intervals)	2 days
00:15:00 (15 minute intervals)	1 day
00:05:00 (5 minute intervals)	8 hours

Scalar Measurement Data Snapshots

Scalar measurement data snapshots are defined by:

- **Measurement Data Snapshot Type:** The measurement data snapshot type for this snapshot
- **Usage Subscription:** The usage subscription associated with the measurement data captured by the measurement data snapshot
- **Service Point ID:** The service point associated with the measurement data captured by the measurement data snapshot
- **Measuring Component ID:** The measuring component from which the measurement data captured by the measurement data snapshot originated
- **Transaction ID:** The transaction ID for the transaction which triggered creation of the data snapshot (such as an initial measurement, usage transaction, or bill)
- **Start Date/Time:** The start date/time for the period represented by the data snapshot
- **Stop Date/Time:** The stop date/time for the period represented by the data snapshot
- **Start Date Local :** The start date/time for period represented by the data snapshot represented in local time (if different), used in aggregation processing
- **Stop Date Local :** The stop date/time for period represented by the data snapshot represented in local time (if different), used in aggregation processing
- **Irregular Data:** A flag that indicates if the measurement data snapshot contains irregular data
- **Last Updated:** The date and time on which the measurement data snapshot was last updated
- **Unit of Measure:** The unit of measurement (UOM) for the measurement data captured by the measurement data snapshot
- **Time of Use:** The time of use (TOU) for the measurement data captured by the measurement data snapshot
- **Service Quantity Identifier:** The service quantity identifier (SQI) for the measurement data captured by the measurement data snapshot
- **Value:** The scalar value for the measurement data captured by the measurement data snapshot

Creating Measurement Data Snapshots

Measurement data snapshots can be created either via batch extract processing or as part of usage transaction processing. Batch extract processing is typically run daily (or on some other regular basis) and is used primarily for initial settlement calculations. Usage transaction processing is most often used to create "final" or "billed" measurements used with final settlement calculations.

Both approaches support creation of measurement data snapshots for use with implementations in which Meter Data Management and Market Settlements Management are installed in separate application environments, or in a single application environment.

Batch Extract Processing

As noted above, batch extract processing is typically run daily (or on some other regular basis). Measurement data snapshot creation via batch extract processing is based on configuration of two types of objects:

- Consumption Extract Types
- Batch Controls

There are three types of batch extract processing based on the type of measurement data: interval measurements, scalar measurements, and items. The table below outlines the consumption extract type business objects and batch controls used for each type of data.

Data Type	Consumption Extract Type Business Object	Batch Control
Interval	US Extract Intervals to MDS (D1-ConsExtractTypeInterval)	Extract US Intervals to Measurement Data Snapshots (D1-EUSIM)
Scalar	US Extract Item to MDS (D1-ConsExtractTypeItem)	Extract US Item Consumption to Measurement Data Snapshots (D1-EUITM)
Items	US Extract to Scalar Measurement Snapshot (D1-ConsExtractTypeScalar)	Extract US Scalar Reads to Measurement Data Snapshots (D1-EUSSR)

The following sections provide additional details about the consumption extract types and batch controls used for measurement data snapshot creation.

Consumption Extract Types

Consumption extract types define several parameters used by the measurement data snapshot extract process. As outlined in the table above, there is a separate consumption extract type business object for each type of data.

See [Understanding Consumption Extract Types](#) for general information about consumption extract types.

Measurement data snapshot consumption extract types are defined by the following:

- **Extraction Through Date/Time:** The date and time through which extract requests for this extract type have been processed
- **Extraction Cutoff Time:** The time at which extract requests of this extract type are cutoff
- **Extraction Parameters:** Parameters used in extraction processing, including:
 - **Subscription Type:** The type of subscription (Settlements or CIS) for which extracts of this type are processed.
 - **Request Type:** The request type associated with the extraction type.
 - **Frequency:** The frequency at which extract requests of this extract type are processed. Frequency options include Adhoc and Automated Daily.

- **Measurement Data Snapshot Type:** The [measurement data snapshot type](#) used to create measurement data snapshots based on this extract type. The UOM of the snapshots must be compatible with at least one of the UOMs in the list of **Usage Subscription Types**. In addition, type's UOM / SPI combinations must be compatible with at least one of the UOM / SPI combination listed in the **Usage Subscription Types** list. Used with Scalar and Item consumption extracts only.
- **Extraction Batch Control:** The batch control used to extract the measurement data to measurement data snapshots, based on the type of data to extract and the consumption extract type.

Data Type	Batch Control
Interval	Extract US Intervals to Measurement Data Snapshots (D1-EUSIM)
Scalar	Extract US Item Consumption to Measurement Data Snapshots (D1-EUITM)
Items	Extract US Scalar Reads to Measurement Data Snapshots (D1-EUSSR)

- **Extract To Different Usage Subscription:** A flag that designates whether or not the measurement data snapshot should be extracted to a different usage subscription such as one used by Market Settlements Management. Options include:
 - **No:** The extract will reference the usage subscription for which usage calculations are being processed. This option is used when Meter Data Management and Market Settlements Management are installed in different application environments. In this case, the extract can be exported from Meter Data Management for subsequent import into Market Settlements Management.
 - **Yes:** The extract will reference a different usage subscription such as one used by Market Settlements Management. This option is used when Meter Data Management and Market Settlements Management are installed in the same application environment. In this case, the measurement data snapshot is "exported" within the system to the Settlement Item, where it can be used in data aggregation processing. When this option is selected, the **Source Identifier Type** and **Target Identifier Type** fields must be configured to define how the system will determine the correct settlement usage subscription to use.
- **Irregular Data Flag Mapping:** Ranges of condition codes used to flag data as "irregular". The value of the **Irregular Data Flag** (based on the IRREGULAR_DATA_FLG lookup) is used to flag data that falls within each range configured. A blank **Irregular Flag** value denotes that the condition range is considered to be "Regular".
- **Usage Subscription Types:** One or more usage subscription types from which the consumption can be extracted and stored into measurement data snapshots
- **Measurement Data Snapshot Types:** One more [measurement data snapshot types](#) used to create measurement data snapshots based on this extract type. The UOM of these snapshots must be compatible with at least one of the UOMs in the list of **Usage Subscription Types**. There must be at least one Measurement Data Snapshot type defined in this list for each UOM / SPI combination listed in the **Usage Subscription Types** list. Used with Interval consumption extracts only.

Consumption Extract Batch Controls

Consumption extract batch controls define the consumption extract type and date range used for the measurement data snapshot creation process. As outlined in the table above, there is a separate consumption extract batch control for each type of data.

All three batch controls use the same parameters:

- **Consumption Extract Type:** The consumption extract type for which the batch will be executed. The consumption extract type business object should align with data type of the batch control (interval, scalar, or item).
- **Start Date/Time:** The start of the period that will be extracted
- **End Date/Time:** The end of the period that will be extracted

Each batch control uses a distinct pair of algorithms to select the records to process (Select Records) and to create the measurement data snapshots (Process Records). The table below outlines the algorithms used with each batch control.

Batch Control	Select Records Algorithm	Process Records Algorithm
Extract US Intervals to Measurement Data Snapshots (D1–EUSIM)	Select Interval Snapshots for CET and Date/Range (D1-CETISSERC)	Create Measurement Data Snapshot Interval (D1-CETISPRRC)
Extract US Item Consumption to Measurement Data Snapshots (D1–EUITM)	Select Scalar Snapshots for CET and Date/Range for Item (D1-CETITEMSR)	Create Measurement Data Snapshot Scalar with Item Consumption (D1-CETITEMPR)
Extract US Scalar Reads to Measurement Data Snapshots (D1–EUSSR)	Select Scalar Snapshots for Consumption Extract Type and Date/Range (D1-CETSCSPSR)	Process Measurement Data Snapshot Scalar Records (D1-CETSCSPPR)

Usage Transaction Processing

Measurement data snapshots can be creating during usage transaction processing through configuration of the Daily Scalar Calculation Rule, Get Interval, Get Item Counts and Consumption, and Get Scalar Details usage calculation rules. When these are configured properly, the usage calculation process calculates service quantities and extracts measurement data for snapshots. See [Understanding Usage Calculation Rules](#) for more information about configuring usage rules to create measurement data snapshots.

Initial Measurement Snapshots

When measurement data snapshots are created via usage transaction processing as a result of a request for billing determinants from a billing system (including the billing functionality in Customer To Meter), initial measurement snapshots are created to “hold” the snapshots while the “Used on Bill” flag on the usage transaction is set to “No”. When the “Used on Bill” flag is updated the “Yes”, the measurement data snapshot is created from the initial measurement snapshot. See

[About Initial Measurement Snapshots](#) for more information.

Maintaining Measurement Data Snapshots

You use the **Settlement Item** portal to view and maintain measurement data snapshots.

Refer to [About Measurement Data Snapshots](#) for additional functional information.

Initial Measurement Snapshots

About Initial Measurement Snapshots

Initial measurement snapshots are used to hold measurement data snapshots until they are ready to be processed. Examples of initial measurement snapshots include:

- Measurement data snapshots created as part of usage transaction processing, but where the usage transaction’s “Used on Bill” flag is set to “No”.
- Imported measurement data snapshots that encounter an error of some sort during import, such as if the Usage Subscription or Settlement Item for the snapshot can’t be found.

Initial measurement snapshots are defined by:

- **Usage Subscription:** The usage subscription related to the initial measurement snapshot (if applicable)

- **Settlement Item:** The settlement related to the initial measurement snapshot (if applicable)
- **Usage Transaction ID:** The usage transaction related to the initial measurement snapshot
- **Status:** The current status of the initial measurement snapshot
- **Transaction ID:** The transaction ID of a related transaction, such as a bill.

Initial measurement snapshots in error can also include the following information:

- **Current Error Message:** An message explaining the error that resulted in the creation of the initial measurement snapshot
- **External System:** The external system that sent the measurement data snapshot
- **Measurement Data Snapshot Type:** The measurement data snapshot's type
- **Service Point ID:** The service point associated with the initial measurement snapshot, if applicable
- **Measuring Component ID:** The measuring component associated with the initial measurement snapshot, if applicable
- **File Name:** The file name for the import file used to create the measurement data snapshot
- **Start Date/Time:** The start date and time for the initial measurement snapshot
- **End Date/Time:** The end date and time for the initial measurement snapshot (applies to scalar snapshots only)

Initial Measurement Snapshot Business Objects

The system includes the following initial measurement snapshot business objects:

- **Initial Measurement Snapshot Export to US (D1-InitMsrmtSnapExporttoUS):** Used for snapshot data during the time period when billing determinants have been sent to the billing system but the billing system has not yet confirmed that they have been used on a finalized bill (the "Used on Bill" flag is set to "No"). This is used when the data is being staged under the Usage Subscription for eventual export to the Settlement Item.
- **Initial Measurement Snapshot Export to SI (D1-InitMsrmtSnapExporttoSI):** Used for snapshot data during the time period when billing determinants have been sent to the billing system but the billing system has not yet confirmed that they have been used on a finalized bill (the "Used on Bill" flag is set to "No"). This is used when the data is being created directly underneath the Settlement Item.
- **Initial Measurement Snapshot Import (D1-InitMsrmtSnapImport):** Used to captures the details of an imported measurement data snapshot that has encountered an error during processing.

Maintaining Initial Measurement Snapshots

You use the **Initial Measurement Snapshot** portal to view and maintain initial measurement snapshots.

Refer to [About Initial Measurement Snapshots](#) for additional functional information.

You can access the portal by selecting **Menu**, then **Initial Measurement Snapshot**. You are brought to a query portal with options for searching. You can search by:

- Initial Measurement Snapshot From
- Initial Measurement Snapshot To
- Show Initial Measurement Snapshot in Error

The following zones may appear as part of the portal's **Main** tab page:

- **Initial Measurement Snapshot:** This zone displays the selected initial measurement snapshot.

Interval Snapshot Mapping

About Interval Snapshot Mapping

Interval snapshot mappings are used to map intervals to a particular point in the day, and are used in the snapshot creation process to align a particular interval with the column it belongs to.

The Interval Snapshot Mapping (D1-IntervalSnapMapping) business service is used to create Interval Snapshot Mapping entries based on the installation time zone. This service takes Seconds Per Interval, Start Date/Time, and End Date/Time as inputs.

Maintaining Interval Snapshot Mapping

You use the **Interval Snapshot Mapping** portal to view and maintain Interval Snapshot Mapping entries.

Refer to [About Interval Snapshot Mapping](#) for additional functional information.

You can access the portal by selecting **Main**, then **Settlement**, then **Interval Snapshot Mapping**. You are brought to a query portal with options for searching. You can search by:

- Seconds Per Interval
- Date/Time From
- Date/Time To

The search results include all of the mapping entries that match the provided Seconds Per Interval (if provided) and that fall within the specified date range (if provided).

Creating Interval Snapshot Mapping Entries

The Interval Snapshot Mapping (D1-IntervalSnapMapping) business service is used to create Interval Snapshot Mapping entries based on the installation time zone. This service can be invoked from the **Interval Snapshot Mapping** portal.

To create new Interval Snapshot Mapping entries, either select **Main**, then **Settlement**, then **Interval Snapshot Mapping**, and then **Add**, or click **Add** in the **Interval Snapshot Mapping** portal. The **Create Interval Snapshot Mapping Entries** page opens.

Enter parameters to specify the mapping entries to create, including:

- Seconds Per Interval
- Date/Time From
- Date/Time To

Click **OK**.

Enter appropriate parameters in the search portal to view the new entries.

Settlement Calculations

About Settlement Calculations

Oracle Utilities Market Settlements Management can calculate and publish settlement results calculated from aggregated data to market participants on an ongoing basis. Settlement calculations derive a settlement transaction's service quantities using the aggregated measurement associated with one or more market participants.

Before settlement results can be calculated, you must first create a [Settlement Subscription](#). The settlement subscription defines the external system to which the data should be sent as well as the settlement calculation groups that will be used for

calculation. The settlement calculation rules defined for the settlement calculation groups are responsible for performing the specific calculations, validations, or estimations for settlement results.

Settlement service quantities are derived from aggregated measurement data the calculation period.

The results of all calculations performed by settlement subscriptions are stored as a [Settlement Transaction](#).

The settlement calculation process has a number of different objects that are detailed below that allow for configurability and flexibility in how the process executes.

Settlement Calculation Groups

Settlement calculation groups are collections of settlement calculation rules that are used to calculate service quantities for market participants. During the settlement transaction process, the system executes the settlement calculation rules defined in the settlement calculation group referenced on the settlement subscription. The rules within a settlement calculation group are defined in a specific sequence, allowing control over the order in which the rules are executed.

For information on configuration, reference the related section for [Configuring Settlement Calculation Groups](#) in the Administrative User Guide.

Settlement Calculation Rules

The specific calculation processing performed on a settlement transaction is defined in individual settlement calculation rules, each performing a specific set of targeted logic. The base product contains many settlement calculation rules you can use in your implementation, but you can also create your own custom settlement calculation rules. Many settlement calculation rules are identical to usage calculation rules used by Oracle Utilities Meter Data Management

For a list of validation settlement calculation rules, reference the [About Usage Validations](#) section. For a list of estimation usage calculation rules, reference the [About Usage Estimations](#) section. For a list of all other usage calculation rules that handle calculation of bill determinants, reference the [Inventory of Other Usage Calculation Rules](#) section.

For information on configuration, reference the related section for [Configuring Settlement Calculation Rules](#) in the Administrative User Guide.

Settlement Transaction Exceptions

Each settlement calculation rule defines an exception type and severity that specify how exceptions are tracked by the system. When a settlement transaction fails some part of a settlement calculation rule, an exception of the type specified for the failed settlement calculation rule is created. A single settlement transaction can have multiple exceptions, one (or more) for each rule that failed. This allows users to see all of the problems detected during the settlement calculation process.

There are three levels of severity for settlement transaction exceptions:

- **Information:** Used to highlight minor issues, but not sufficient to cause the settlement transaction to be put into a failure state. Exceptions of this category can be used to report on the frequency of interesting, but not fatal issues
- **Issues:** Used to report a problem that will prevent the settlement transaction from being exported. Multiple "issue exceptions" can be created during settlement transaction processing. If at least one issue exists after all rules have been applied, the settlement transaction is transitioned to a failure state requiring review and approval.
- **Terminate:** Used to report a severe issue that will cause the settlement calculation process to stop and the settlement transaction to be transitioned immediately to a failure state requiring review and approval. Only one terminate exception can be issued (as the first one causes calculation processing to stop on for a settlement transaction). This should be used for cases where manual override / approval isn't accurate. For example, a "Curve Not Continuous" error that says the interval data doesn't cover the full settlement period should always be set to Terminate as an Exception Severity.

Note that exceptions are not deleted when a settlement transaction is adjusted or corrected. After any issues are corrected or the settlement transaction is overridden (or manually completed), the exceptions persist in a closed state for reporting purposes.

In addition to exceptions, settlement processing can also trigger the creation of To Do Entries related to issues. If Issue or terminate exceptions exist for an initial measurement, a To Do Entry is created when the settlement transaction is

transitioned to the Exception state. The To Do Type and default To Do Role of this To Do Entry are defined on the Enter system event for the Exception state of the business object used to define the settlement transaction.

To Do Entries created in this way can be routed to different roles depending on the exception's message category and number (using the To Do Type's Message Overrides tab).

For information on configuration, reference the related section for [Configuring Usage Transaction Exception Types](#) in the Administration Guide.

Settlement Calculation Rule Eligibility Criteria

Settlement calculation rule eligibility criteria are user-definable conditions that could cause a given settlement calculation rule to be applied or skipped. This can involve the evaluation of some attribute of the settlement subscription or something else entirely. A settlement calculation rule can have multiple eligibility criteria for determining if the rule should be applied or skipped, based on a user-defined sequence. Eligibility criteria for settlement calculation rules works in the same manner as eligibility criteria for usage calculation rules used by Oracle Utilities Meter Data Management.

For information on configuration, reference the related section for [Configuring Usage Calculation Rules](#) in the Administrative User Guide.

Settlement Subscriptions

About Settlement Subscriptions

Settlement subscriptions track the ongoing need to calculate a set of data, often aggregated load, for the purpose of settling a market and send the results to a recipient.

Settlement subscriptions must reference the following:

- **Recipient:** The identity of the subscribing system. In other words, you must set up a recipient for any system that subscribes to settlement calculations.
- **Settlement Calculation Groups:** The calculation groups used to perform settlement calculations for settlement transactions based on this settlement subscription. Settlement calculation groups can be configured in a specific sequence of execution. In addition, each group can be configured to require approval before the calculation execution proceeds to the next calculation group.

Settlement subscriptions can also reference the following:

- **Factor Overrides:** One or more factors can be used as override values when performing calculations
- **Measuring Components:** One or more measuring components directly linked to the settlement subscription. These are most often aggregation measuring components, but can also include profile measuring components.
- **Measuring Component Sets:** One or more measuring component sets directly linked to the settlement subscription.

Maintaining Settlement Subscriptions

You use the portal **Settlement Subscription** portal to view and maintain settlement subscriptions.

Refer to [About Settlement Subscriptions](#) for additional functional information.

You can access the portal from the **Main > Settlement > Settlement Subscription**. You are brought to a query portal with options for searching. Once your record has been selected you are brought to the maintenance portal to view and maintain the selected record.

The following zones may appear as part of the portal's **Main** tab page:

- **Settlement Subscription:** This zone displays basic information about the settlement subscription, including factor overrides, settlement calculation groups, measuring components and measuring component sets.
- **Settlement Transaction:** This zone displays a list of settlement transactions for the settlement subscription.

Settlement Transactions

About Settlement Transactions

Settlement transactions are records of calculations for a settlement subscription. All of the service quantities calculated are stored as part of the settlement transaction.

Settlement Calculation Group Determination

The first step in settlement calculation is to determine the settlement calculation group holding the rules set used in calculating or validating the calculations. There are two ways of configuring the settlement calculation group to use in the processing. It may be specified on the settlement subscription during its creation with an effective and expiration date. If there are no settlement calculation groups in effect for the settlement transaction, the **Fallback Settlement Calculation Group** specified in the settlement subscription type will be used.

Calculation Period

Settlement transaction requests must specify the date range for the settlement transaction. This date range is referred to as the calculation period for the settlement transaction.

Date Breaks

Date breaks are used to break up a settlement period into sub-periods based on the dates on which changes took place for market participants. One approach to this situation would be for the system to create settlement transactions (where each has the desired date range). Another approach is for the system to create single settlement transaction with date breaks that define the date ranges before and after the change.

If a settlement transaction has date break(s), the settlement calculation engine segregates the usage into multiple calculation periods based on the date breaks. If there are no date breaks in the settlement transaction, a single calculation period is created for the entire calculation period.

Service Quantities

Every settlement period created for a settlement transaction contains one or more service quantities. Service quantities are calculated by the settlement calculation group's rules specified for the settlement subscription from which the settlement transaction is created. For example, a settlement transaction might have quantities calculated by a single rule that applies a TOU map to aggregated kWh .

Each service quantity lists details about that quantity, including a UOM (or TOU or SQI as appropriate) and a quantity. In addition, each service quantity also references the source (measuring component) of the quantities (for audit purposes).

Quality Assessment

The [Get Interval Data](#), [Get Scalar Details](#), and [Get Time of Use Mapped Usage](#) calculation rules include a "Perform Measurement Quality Assessment" option that indicates (yes or no) if the measurement conditions of the measurements used when calculating usage should be evaluated and included in the resulting settlement transaction and outbound message. When enabled (set to "Yes"), the calculation rule algorithm evaluates the condition codes of the measurements used in the calculation to determine if they fall within a "Regular" range of conditions (this range is defined by the "Bottom Regular Condition Range" and "Top Regular Condition Range" algorithm parameters). The result of this assessment is displayed in the "Data Quality Assessment" column in the Calculation Periods section which indicates if the service quantity is based on

"regular" or "non-regular" data. (If the "Perform Measurement Quality Assessment" option is disabled, the "Data Quality Assessment" column displays "No Assessment Done"). In addition, the "Source Measurement Quality List" column contains XML that contains a list of measurements aggregated by condition/quality.

Validations

As settlement transactions are created and move through their various states, several validations are performed to ensure proper processing. These include:

- Validating the business object used to create the settlement transaction
- Validating the start and end dates for the settlement transaction
- Validating the settlement transaction's service quantities
- Validating the existing settlement transactions for the same calculation period
- Validating whether or not the settlement transaction can be deleted

Settlement Transaction Communication

Upon completion of calculations (or approval of calculations if the approval is required), settlement transaction results can be exported and sent to market participants. This is done via an outbound communication created by the Create Settlement Transaction Outbound Communication algorithm. This communication is responsible for deriving and gathering the appropriate data to send to the market participant and creating and sending an outbound message.

There are two many ways in which settlement transactions are sent:

- **Contract:** Sending by contract involves sending the results of a settlement transaction to a recipient (such as an ISO) using an identifier from the market contract.
- **Identifier:** Sending by identifier involves sending the results of a settlement transaction to a recipient using an identifier from the market participant.

Communication Types

The type of outbound communication created is based on the **Outbound Communication Type** defined on the settlement transaction's settlement subscription type. Communication types define the following about settlement transaction outbound communications:

- **Communication Flow:** The direction of communications based on this type (outbound or inbound).
- **Suppress Zeros:** Designates whether or not data should be sent for a service quantity of 0.
- **Message Generation Method:** Specifies if messages be sent as a single message to the market or broken down to one message per Identifier/Contract.
- **External Communication Type:** Defines whether the communication type is "Settlement by Contract" or "Settlement by Identifier".
- **Export Data Identification:** Defines combinations of UOM/TOU/SQI that represent the final outcome of the settlement transaction to be passed to the market
- **Reconciliation:** Defines the appropriate identifier or contract to include in the data sent to the market participant:
 - **Contract Reconciliation:** defines the appropriate identifier for the market contract associated with the service quantity. Used when sending data by contract.
 - **Identifier Reconciliation:** Defines the characteristic type for the market participant used to retrieve the appropriate identifier. Used when sending data by identifier.
- **Exception Handling:** Defines how exceptions are handled, including To Do Type and Role, Retry Frequency, and the maximum number of times the system will retry to process the communication

Retrieving Service Quantities

Once created, the outbound communication retrieves a list of service quantities for the settlement transaction and inserts the details into the Settlement Transaction Details list. The specifics of how this is done is based on whether the settlement transaction is sent by contract or by identifier.

Send Settlement Transaction By Contract

Sending data by contract uses outbound communications based on the Send Settlement Transaction by Contract business object. The Retrieve Settlement Transaction SQs Contract algorithm retrieves the list of service quantities that match the UOM/TOU/SQI combination defined on the communication type, and for each service quantity found that has a market contract it will retrieve the identifier for that contract and populate the appropriate details into the Settlement Transaction Details list. The algorithm processes the entire service quantity result set even if it cannot find an identifier for a given contract. This way a user can see all identifier resolution errors at once (instead of needing to fix them one by one to see the next error).

Send Settlement Transaction By Identifier

Sending data by identifier uses outbound communications based on the Send Settlement Transaction by Identifier business object. The Retrieve Settlement Transaction SQs for Identifier algorithm extracts the market participant from the attributes associated to the service quantity's measuring component. The measuring components that will be associated to the service quantity in this instance will be aggregation measuring components that hold a list of dimensions that includes a market participant. The algorithm then retrieves the list of service quantities that match the UOM/TOU/SQI combination defined on the communication type and for each service quantity found that has a measuring component, it retrieves the measuring component's market participant and then retrieve the identifier for that market participant and populate the appropriate details into the Settlement Transaction Details list. The algorithm processes the entire service quantity result set even if it cannot find a market participant or an identifier for a given market participant. This way a user can see all identifier resolution errors at once (instead of needing to fix them one by one to see the next error).

Sending Settlement Transactions to Market Participants

After the outbound communication has retrieved the appropriate service quantities, the outbound message creates an outbound message to the market participant (defined as the **Recipient** on the settlement transaction's settlement subscription or settlement subscription type).

The Send Settlement Transaction Details algorithm creates one more outbound messages based on the outbound message type defined for the market participant's Settlement Transaction Notification processing method (see below for more details).

- If the **Message Generation Method** on the communication type is set to "One Comprehensive Message" the outbound communication creates a single outbound message that contains all the service quantities retrieved.
- If the **Message Generation Method** on the communication type is set to "Multiple Messages Based on Data" the outbound communication creates a separate outbound message for each of the service quantities retrieved.

Configuring Market Participants for Settlement Transaction Communication

To support sending settlement transactions to market participants, the following processing method must be defined for the market participants to which settlement transactions are sent:

Processing Role	Processing Method
Settlement Transaction Notification	How to Send Settlement Subscription Related Information Used to send a settlement transaction outbound message to a market participant.

Processing Role

Processing Method

Default Outbound Message Type: The default outbound message type to create for outbound message sent to market participants. The base package does not include an outbound message business object for this. This must be created based on the requirements of each implementation and market participant.

If appropriate, override outbound message types can be defined for specific settlement subscription types.

In addition, the following objects must be configured to send data requests:

- External System
- Outbound Message Type
- Message Sender

Maintaining Settlement Transactions

You use the portal **Settlement Transaction** portal to view and maintain a settlement transactions.

Refer to [About Settlement Transactions](#) for additional functional information.

You can access the portal from the **Main > Settlement > Settlement Transaction**. You are brought to a query portal with options for searching. Once your record has been selected you are brought to the maintenance portal to view and maintain the selected record.

The following zones may appear as part of the portal's **Main** tab page:

- **Settlement Transaction:** This zone displays basic information about the settlement transaction, including processing information and settlement calculation groups.
- **Outbound Communication:** This zone displays a list of outbound communications sent for the settlement transaction.
- **Calculated Data Overview:** This zone displays an overview of calculated data related to the settlement transaction.
- **Calculated Data Details:** This zone provides ability to query the detailed service quantity interval data for the settlement transaction.

A number of important actions are available for a settlement transaction depending on its status:

Action	Allowed Statuses	Details
Approve	Approval In Progress Issue Detected (only when the exceptions are marked to require approval)	Allows a user to bypass any exception or failure message for the settlement transaction and attempt to send it to the requesting system.
Calculate	Approval In Progress Pending	Allows a user to trigger settlement calculations.
Discard	Approval In Progress Export Error Issue Detected	Allows a user to discard the settlement transaction.
Export	Export Error	Allows a user to transition the settlement transaction to the Export status and send the settlement transaction to the recipients.
Export Manually	Export Error	Allows a user to manually export the settlement transaction send it to the recipients.

Override Exception	Issue Detected	Allows a user to override an exception and transition the settlement transaction to the Override Exception state.
Re-Calculate	Issue Detected	Reruns the entire process of calculation along with any validations (all settlement calculation rules) for the settlement transaction.
Supersede	Completed	Allows a user to indicate that the settlement transaction was corrected after being sent. Sets the status of the settlement transaction to Superseded.

Settlement Items

About Settlement Items

Settlement items represent end customer accounts. These are market participants for which settlement calculations are performed, and generally correspond to the market participants which subscribe to settlement calculation results via settlement subscriptions.

Settlement items are defined by the following:

- **Settlement Item Type:** The Settlement Item Type for the settlement item, which defines the business object to use to create the settlement item, the business object to use to capture billed usage for a settlement item (via Settlement Account Billed Usage), and valid service point types.
- **Division:** The division to which the settlement item belongs
- **Access Group:** The access group to which the settlement item belongs (used to limit access to records)
- **Status:** The status of the settlement item
- **Start Date/End Date:** The date range during which the settlement item is active.
- **Main Contact:** The main contact for the settlement item.
- **Time Zone:** The time zone in which the settlement item is active.
- **Measuring Components:** One or more measuring components directly linked to the settlement item. These are most often aggregation measuring components, but can also include profile measuring components.
- **Rate Class:** One or more effective-dated rate classes for the settlement item.

Maintaining Settlement Items

You use the portal **Settlement Item** portal to view and maintain a settlement items.

Refer to [About Settlement Items](#) for additional functional information.

You can access the portal by selecting **Main**, then **Settlement**, then **Settlement Item**. You are brought to a query portal with options for searching. Once your record has been selected you are brought to the maintenance portal to view and maintain the selected record.

The following zones may appear as part of the portal's **Main** tab page:

- **Settlement Item:** This zone displays basic information about the settlement item, including related service points and measuring components.
- **Settlement Item Quantities:** This zone displays a list of settlement item quantities. See [About Settlement Item Quantities](#) for more information. To add a new quantity, for the settlement item, click **Add** in the zone title bar.

- **Settlement Item Market Participants:** This zone displays a list of settlement item market participants for the settlement item, via a [Settlement Item Market Participant](#). To add a new market participant for the settlement item, click **Add** in the zone title bar.
- **Characteristics:** This zone displays a list of characteristics related to the settlement item.
- **Identifiers:** This zone displays a list of identifiers used with the settlement item.
- **Attribute Data Snapshots:** This zone displays a list of attribute data snapshots created for the settlement item.
- **Interval Measurements:** This zone displays a list of interval measurement data snapshots associated with the settlement item. To add a new interval measurement data snapshot for the settlement item, click **Add** in the zone title bar.
- **Scalar Measurements:** This zone displays a list of scalar measurement data snapshots associated with the settlement item. To add a new scalar measurement data snapshot for the settlement item, click **Add** in the zone title bar.

Settlement Item Quantities

About Settlement Item Quantities

Settlement item quantities are quantities that are stored at the settlement item level. These quantities are calculated at irregular frequencies (such as annually or quarterly) and thus do not make sense as a measured quantity on a device and measuring component. For example, in some deregulated markets the Peak Load Contribution could be stored here and effective dated over time to represent the changing contribution of a given settlement item to the market wide coincidence peaks.

Settlement item quantities are defined by the following:

- **Settlement Item:** The settlement item for which the quantities were calculated
- **Settlement Item Quantity Type:** The Settlement Item Quantity Type used for the record
- **Start Date / End Date:** The date range for the calculated quantity
- **Settlement Item Quantities:** Calculated quantities based on **Settlement Item Quantity Identifiers** configured on the Settlement Item Quantity Type (see [Understanding Settlement Item Quantity Types](#) for more information)

NOTE: There cannot be more than one Settlement Item Quantity for the same Settlement Item and Settlement Item Quantity Type, for the same time period (defined by the Start Date and End Date parameters).

Maintaining Settlement Item Quantities

You use the **Settlement Item Quantity** portal to view and maintain settlement item quantities.

Refer to [About Settlement Item Quantities](#) for additional functional information.

You can access the portal by selecting **Main**, then **Settlement**, then **Settlement Item Quantity**. You are brought to a query portal with options for searching. Once your record has been selected you are brought to the maintenance portal to view and maintain the selected record.

The following zones may appear as part of the portal's **Main** tab page:

- **Settlement Item Quantity:** This zone displays the basic attributes of the settlement item quantity

Settlement Billed Usage

About Settlement Billed Usage

Settlement billed usage represents billed usage for a settlement item. Settlement billed usage is calculated via settlement calculations performed for the settlement subscription associated with the settlement item. Settlement billed usage typically corresponds to settlement transactions.

Settlement billed usage records are defined by the following:

- **Settlement Item:** The settlement item for which the billed usage was calculated
- **Start Date/Time:** The date and time of the start of the billing period for the billed usage
- **End Date/Time:** The date and time of the end of the billing period for the billed usage
- **Billed Usage Periods:** one or more billed usage periods for the current settlement billed usage. A billed usage period is a period of time for which usage is calculated, including details calculated for each billed usage period such as UOM/TOU/SQI and quantities

Maintaining Settlement Billed Usage

You use the portal **Settlement Billed Usage** portal to view and maintain settlement billed usage.

Refer to [About Settlement Billed Usage](#) for additional functional information.

You can access the portal from the **Main > Settlement > Settlement Billed Usage**. You are brought to a query portal with options for searching. Once your record has been selected you are brought to the maintenance portal to view and maintain the selected record.

The following zones may appear as part of the portal's **Main** tab page:

- **Settlement Billed Usage:** This zone displays basic information about the settlement billed usage, including billed usage periods.

Settlement Item Market Participants

About Settlement Item Market Participants

Settlement item market participants connects a Market, Market Participant and Settlement Item together over a specified date range. Settlement item market participants can be created either via the **Settlement Item Market Participant** portal, or by adding a market participant to a settlement item via the **Settlement Item** portal.

Settlement item market participants are defined by the following:

- **Settlement Item:** The settlement item for which this settlement item market participant was created.
- **Market Relationship Type:** The market relationship (Distributor, Supplier, etc.) of the market participant and its role within a market.
- **Start Date/Time:** The start date/time for when the record is applicable.
- **End Date/Time:** The end date/time for when the record is applicable.
- **External ID:** An ID for the market participant used by external systems.
- **Market Participant:** The market participant associated with the **Settlement Item**, including an optional ID used by the market participant to uniquely identify the settlement item.

Maintaining Settlement Item Market Participants

You use the **Settlement Item Market Participant** portal to display and maintain settlement item market participants.

Refer to [About Settlement Item Market Participants](#) for additional functional information.

You can access the portal by selecting **Main**, then **Settlement**, then **Settlement Item Market Participant**. You are brought to a query portal with options for searching. Once your record has been selected you are brought to the maintenance portal to view and maintain the selected record.

The following zones may appear as part of the portal's **Main** tab page:

- **Settlement Item Market Participant:** This zone displays the basic attributes of the settlement item market participant.
- **Sub Settlement Items:** This zone lists settlement items for the settlement item market participant.

Market Allocations

Market Contracts

About Market Contracts

Market contract are agreements with the market operator (such as an Independent System Operator, or ISO) related to how settlement calculation results are sent to the market. Market contracts are related to a specific market, have a seller and buyer, as well as a date range for when they are effective.

Market contracts are defined by the following:

- **Market Contract Type:** The [Market Contract Type](#) for the contract. This defines the market in which the contract is in effect and the business object used to create the contract.
- **Contract :** A unique code for the contract, often provided by an external system
- **Start Date / End Date:** The date range during which the contract is in effect
- **Seller:** The market participant that serves as the Seller for the contract.
- **Buyer:** The market participant that serves as the Buyer for the contract.

Maintaining Market Contracts

You use the **Market Contract** portal to view and maintain market contracts.

Refer to [About Market Contracts](#) for additional functional information.

You can access the portal from the **Main > Market > Market Contract**. You are brought to a query portal with options for searching. Once your record has been selected you are brought to the maintenance portal to view and maintain the selected record.

The following zones may appear as part of the portal's **Main** tab page:

- **Market Contract:** This zone displays basic information about the market contract.
- **Related Market Awards:** This zone displays a list of market awards related to the market contract.

Market Awards

About Market Awards

Market awards are used to allocate load to various market participants.

Market awards are defined by the following:

- **Market Product:** The [Market Product](#) associated with the award
- **Award Class:** The type of award. The base package supports three award classes: Tranche Awards, Percentage Awards, and Fixed Profile Awards.
 - **Tranche Awards:** Tranches are used to handle a whole number division of load. For example, an agreement may be reached that the Provider of Last Resort (POLR) load for a zone should be broken into 64 tranches, or exactly 64 chunks of load that can be purchased. In this example, the load could be broken up in the following manner: Contract #1234 buys 12 tranches, Contract #1235 buys 1 tranche, and Contract #1236 buys 51 tranches (each of these three would be a market award) A factor can be used to define different tranche quantities over time for the same market award.
 - **Percentage Awards:** Percentage Awards allocate a percentage of the remaining load. A factor can be used to define a different percentage over time for the same market award.
 - **Fixed Profile Awards:** Fixed Profile Awards leverage a profile measuring component to designate an amount that must be allocated from the overall load to this market award. A factor can be used to define different profiles over time for the same market award.
- **Start Date / End Date:** The date range for the market award
- **Award Details:** Details of the award, including the source (Static Value or Factor) and quantity (either a fixed value or factor value)
- **Characteristics:** Characteristics for the award, if appropriate

Maintaining Market Awards

You use the **Market Award** portal to view and maintain market awards based on [Market Products](#) with a **Product Class** of “Contract Fulfillment”.

Refer to [About Market Awards](#) for additional functional information.

You can access the portal from the **Main > Market > Market Award**. You are brought to a query portal with options for searching. Once your record has been selected you are brought to the maintenance portal to view and maintain the selected record.

The following zones may appear as part of the portal's **Main** tab page:

- **Market Award:** This zone displays basic information about the market award, including **Award Details**, related market **Contracts**, and **Characteristics**.

Maintaining Market Allocations

You use the **Market Allocation** portal to view and maintain market awards based on [Market Products](#) with a **Product Class** of “Parent Allocation”.

Refer to [About Market Awards](#) for additional functional information.

You can access the portal by selecting **Main**, then **Market**, then **Market Award**. You are brought to a query portal with options for searching. Once your record has been selected you are brought to the **Market Allocation** portal to view and maintain the selected record.

The following zones may appear as part of the portal's **Main** tab page:

- **Market Allocation:** This zone displays basic information about the market award, including **Award Details**, and **Characteristics**.

Market Products

About Market Products

Market products are used to allocate market awards to market participants. Market products are referenced by the [Market Award Allocation](#) settlement calculation rule via a parent Market Product Set. Market products of class "Parent Allocation" can have child products. This allows definition of hierarchies of market products and related awards,

Market products are defined by the following:

- **Market Product Set:** The [Market Product Set](#) to which the Market Product is associated.
- **Market Product Type:** The [Market Product Type](#) for the market product. This defines the business object used to create the market product and its market awards. For formula-based products, the market product type also defines the formula used to calculate award allocation.
- **Product Code:** A unique code for the product, often provided by an external system
- **Product Class:** The type of product. The base package supports two product classes: Parent Allocation or Contract Fulfillment:
 - **Parent Allocation:** Indicates that the market product is a parent level product that divides out a certain allocation of the total amount to be then divided further amongst child products.
 - **Contract Fulfillment:** Indicates that the market product ties to an "end result" award that can then be tied to a Market Contract
- **Execution Sequence:** Defines the sequence in which the market product will be executed within its parent Market Product Set
- **Awards:** One or more [Market Awards](#) associated with the market product. These define how load and procurement are allocated when the market product is processed by the [Market Award Allocation](#) settlement calculation rule.

Maintaining Market Products

You use the **Market Product** portal to view and maintain market products.

Refer to [About Market Products](#) for additional functional information.

You can access the portal from the **Main > Market > Market Product**. You are brought to a query portal with options for searching. Once your record has been selected you are brought to the maintenance portal to view and maintain the selected record.

The following zones may appear as part of the portal's **Main** tab page:

- **Market Product:** This zone displays basic information about the market product.
- **Awards:** This zone displays a list of market awards related to the market product.

Data Access Restrictions

Using Data Access Restrictions

The focus for multi-jurisdiction support in Oracle Utilities Meter Data Management is on restricting access to the user interface. This occurs through defining different Access Groups by operating company which then marks the Service Point with the access capabilities. The Service Point has a field named **Access Group** which allows you to define specific access to the Service Point.

If Access Group is set on the Service Point, then the user interface search screens within Oracle Utilities Meter Data Management will only allow users that are assigned to the proper Access Role to be able to access that Service Point.

For additional information see [Defining Access Groups](#).

Defaulting Access Groups on Service Points

If there is a desire to set a default Access Group by jurisdiction, then this can be accomplished on configuration for [Markets](#). When defining a Market there is an option to add a **Default Access Group**. This value will be used to mark any newly created Service Point with the same Access Group value defined on the related Market.

Example Scenarios

Below are some examples of how Data Access Restrictions can be implemented:

Example 1: Split Access by Market - an example utility "ABC Energy" that has 3 operating companies.

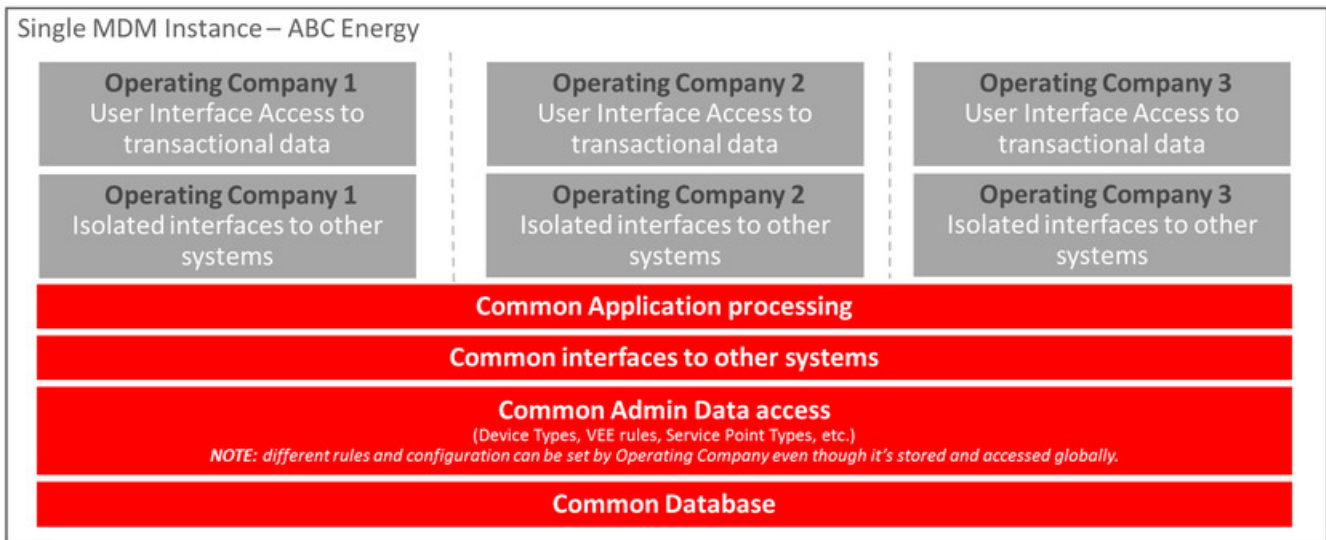

Example 2: Isolating Important Customers - an example utility "XYZ Energy" that has 2 operating companies but would also like to isolate access to Large commercial customers for one of the companies.

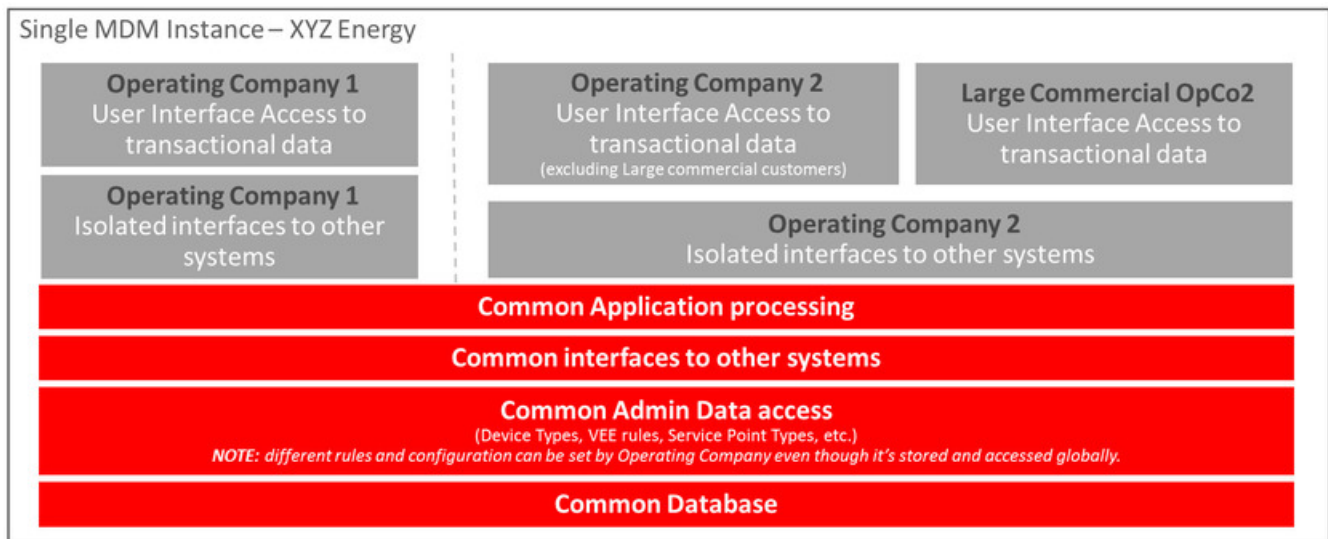

To Do Processing

There are numerous events that trigger the creation of email-like messages describing work that requires human attention. For example, if a bill segment has an error, a message is created to highlight such. We refer to each message as a **To Do Entry**. In this section, we describe how to view, manage and work To Do entries.

FASTPATH: We recommend familiarizing yourself with the topics described in [The Big Picture of To Do Lists](#) to fully appreciate how To Do entries are managed by the system.

Understanding To Do Processing

The topics in this section provide background information on To Do processing functionality.

To Do Role

Each To Do entry is assigned a specific To Do Role. The role defines the users who may work on the entry. The permissible roles that may be assigned to a To Do entry are defined on the entry's To Do type. One or more users within a role may be designated as a supervisor, who is allowed to assign To Do entries to other people. Supervisors are determined through application security access.

Refer to [To Do Entries Reference A Role](#) to learn more about role assignment.

After an entry is created, its role may be changed to any role defined as valid for the entry's To Do type. Manual changes of a To Do entry's role are recorded on the [To Do entry log](#).

To Do Priority

A To Do entry is associated with a priority level representing its processing order compared to other entries. Refer to [The Priority Of A To Do Entry](#) for more information on how an entry's priority is initially assigned and how it may be automatically updated by the system.

A user may manually override a To Do entry's priority at any time. Once overridden, automatic recalculation of the priority is no longer performed so as not to override the value explicitly set by the user. Manual overrides of a To Do entry's priority are recorded on the [To Do entry log](#).

NOTE: Only users that are currently assigned to a **Being Worked On** To Do entry or ones that are valid for the role of an **Open** To Do entry may manually change the priority.

Work Distribution

This topic goes over the various possible actions a user can take to adjust what role or what user is associated with a To Do entry while it is in a non-complete state.

Adjusting the Role

A To Do entry must always reference a role. When a To Do entry are created in the **Open** state and is associated with a [role](#). The following points highlight ways to adjust the role associated with a To Do entry.

- A user viewing a record on the [To Do Entry](#) page may use the Forward or Send Back action to change the role.
- A supervisor using the [To Do Search](#) page may assign a user not linked to the current role. In this case, the system will update the role to one valid for the assignee.

Assigning a To Do to a User

There are several ways to assign a To Do entry to a user (causing its status to transition to **Being Worked On**):

- The [To Do Management](#) portal provides many filters and viewing options to review To Do entries for a give To Do Type. In addition, it displays a rich amount of detail for the resulting To Do entries, helping users to make decisions. Users may use this page to assign work to themselves and supervisors may use this to assign work to others.
- A supervisor can use the [Supervisor Functions](#) pages to review, assign and reassign To Dos to users.
- A user viewing an entry on the [To Do Entry](#) page may use the Forward to a User or the Send Back action to assign the entry to a different.
- A user may use the [To Do list](#) pages to review and assign To Dos to themselves.
- All of the above assignment functions may also be performed using the [To Do Search](#) page.

The system can also be configured to dynamically assign the highest priority work to users on demand whenever they are available for fixing errors.

NOTE: Assignment on demand is in a plug-in. You can customize the next assignment plug-in on the [installation options](#) to follow your organization's work distribution rules. The product provides an algorithm out of the box (**F1-NEXT-TDNS**) that can assign work solely based on priority. Another algorithm (**F1-NEXT-TDSK**) may be used to only consider To Do entries the user has the proper [skills](#) to resolve. Your implementation may provide a different algorithm based on your own business rules.

One of the main benefits of the assignment on demand approach is that work is allocated real-time based on most current information such as skills, priority, user availability, etc. This also means that work remains unassigned until a user is actually going to work on it making it available to any qualified user.

Assignment "on demand" is possible from the [Current To Do](#) zone on the Dashboard portal. Refer to this zone to learn about all the functions it provides.

Reopening / Unassigning a To Do

It is possible to transition a To Do entry from **Being Worked On** back to **Open**.

- A user viewing a record assigned to them on the [To Do Entry](#) page may use the Forward to a role action to move the entry back to **Open**.

- The **Unassign** button on the [To Do Management](#) portal or the **Reopen** button on the [To Do Search](#) page causes the To Do entry to go back to **Open**.

A User's Current To Do

When you are actively working on a specific To Do entry, there are tools to make this To Do the one that is displayed in the [Current To Do](#) dashboard zone. The act of making a To Do entry your current To Do, also navigates you to the related object (or if the To Do type is configured to launch a script, the script is launched).

If your organization's practice is to assign work to users up front, then a typical approach is that you would start by reviewing a list of entries assigned to you using one of the base pages and drill down on an entry in the list to start working on it. In some pages, there is a way for you to enable a list of To Do Entries that you can work through without needing to return to the query page to get the next entry.

The following points highlight the available base pages and their supported functionality.:

- [To Do Management](#) allows you to use filters to view a list of entries assigned to you or open. (If you plan to work on a To Do entry that is open, you should first assign it to yourself. No action automatically assigns it.) Click the Work List icon in the Action column to populate the [Work List](#) zone in the dashboard with the results of the search. Click the **Work** button to choose the To Do entry you wish to start with. This drills you into the related object and populates the Current To Do zone with this To Do. Use the entries in the Work List zone to subsequently work on other To Do entries.
- [To Do List](#) allows you to start working on a To Do by clicking the entry's message description link. If the To Do entry is Open, this action will assign it to you automatically. Any other To Do entries that were in that results list on that page become an internal work list and the **Previous** button and **Next** button are enabled in the Current To Do zone to work through that list.
- [To Do Search](#) allows you to start working on a To Do by clicking the entry's message description link. (If you plan to work on a To Do entry that is open, you should first assign it to yourself. No action automatically assigns it.) Any other To Do entries that were in that results list on that page become an internal work list and the **Previous** button and **Next** button are enabled in the Current To Do zone to work through that list.

Before working on a new To Do, if the problem is resolved, use the actions in the Current To Do zone to mark the entry [Complete](#).

Additionally, users may have the option to click on the **Assign me a To Do** button on the Current To Do dashboard zone to request their next task. The returned To Do entry automatically becomes the user's **Current** To Do. This does not enable any work list functionality.

To Do Characteristics

Characteristics are used to associated related information to a To Do entry. Refer to [Linking Additional Information](#) to a To Do Entry for more information.

Several pages in the system allow you to view a To Do entry's characteristic values and / or search for To Do entries by their characteristics.

- The [To Do Management](#) portal includes up to five filters to search for To Do entries by a characteristic value. In addition, the search results display all the current characteristics as name / value pairs.
- The [To Do Entry](#) includes a zone to display any existing characteristics. In addition, if a user is allowed to modify a To Do Entry, the edit dialogue allows a user to add or change characteristics. Note that for manual [To Do types](#), the valid characteristic types are driven by the To Do type. For automated To Do types, if valid To Do characteristic types are configured on the To Do type, only those are available. Otherwise, any valid To Do characteristic type may be linked.
- The [To Do Search](#) allows includes a single characteristic type / value filter.

Related To Do Entries

A user working on a To Do may want to know of other To Dos that may be related to the same problem. If they can be worked by the same user they may get resolved faster. It seems almost impossible to programmatically determine whether two To Dos really stem from the same problem. The user should therefore be presented with a list of potentially related To Dos from which they can select the truly relevant ones.

A To Do entry is considered potentially related to a given To Do if they reference a common entity via a characteristic. For example, if a given To Do references a certain account then any To Do referencing that same account is considered related to it.

NOTE: The common entity is any characteristic value linked to the To Do entry where the characteristic type is a **Foreign Key** and the main table of the foreign key is classified as a **Master** or **Transaction** table.

There are various places where the user is informed as to whether or not the current To Do Entry is related to other To Do Entries.

- To Do entry maintenance displays in insight indicating the number of related To Do Entries for the current To Do. In addition, a Related To Do Entries zone shows information about each related To Do.
- The [Current To Do](#) dashboard zone includes related To Do information and actions.
- The [To Do Management](#) query includes a count of related To Do entries.
- The [To Do Search](#) page supports a **Related To Do filter** that lists all related To Do entries for a given entry.

Complete A To Do

After you finish working on an entry, you can mark it as **Complete**. At this point, you may want to review potentially [related](#) To Do entries and complete those that have been addressed by resolving the problem associated with the current entry.

When you complete a To Do, a [log entry](#) is created that indicates when the To Do was completed and by whom.

There are multiple ways in which you can complete a To Do.

- The [To Do Management](#) page provides many filters in addition to To Do Type. One or more entries may be completed in this page.
- Use the [To Do Entry](#) page to complete a single To Do Entry. The user may also choose to add comments when completing a To Do on this page.
- The [To Do List](#) page allows you to complete one or more selected entries of a specific To Do Type.
- The [To Do Search](#) page allows you to search for To Do entries using various search criteria and complete selected ones.
- You may also use the [Current To Do](#) zone to complete the current entry you are working on and/or all [related](#) entries assigned to you.

NOTE: It is possible for the system to automatically mark an entry as **Complete**. Refer to [The Lifecycle Of A To Do Entry](#) for more information.

Log Entry Events

Any user may add a **User Details** log entry to any To Do at any time (even after it's completed). Refer to [To Do Entry](#) page for more information.

The [To Do Management](#) portal also allows users to add a **User Details** log entry to one or more selected entries.

In addition, there are several log entries created automatically by the system. The following table contains the list of all possible log events.

Event	Log Type	To Do Entry Status	Content of Details	Content of Assigned To (on To Do entry and To Do Log)	Log User ID	Contents of Sent By (on To Do entry)
A To Do is created (by the system or by a user)	Created	Open			ID of user who created the To Do	
A To Do is created (by the system or by a user) in Being Worked On status	Created	Being Worked On		User ID of user who was assigned this To Do	ID of user who created the To Do	Creating user's ID
A To Do is completed (by the system or by a user)	Completed	Complete			ID of user who completed the To Do	
A user takes an open To Do	Assigned	Being Worked On	Selected by user	Assigned To User ID	Assigned To User ID	ID of user who assigned the To Do
A supervisor assigns a To Do to a user (also happens if they reassign)	Assigned	Being Worked On	Assigned to user	Assigned To User ID	ID of user who assigned the To Do	ID of user who assigned the To Do
A user forwards an entry to a user	Forwarded	Being Worked On	<i>Log details entered by user</i>	Forwarded To User ID	ID of user who forwarded the To Do	ID of user who forwarded the To Do
A user forwards an entry to a role	Forwarded	Open	Forwarded to role <i>Role Description (Role ID) + Log details entered by user</i>		ID of user who forwarded the To Do	ID of user who forwarded the To Do
A user sends back a To Do	Sent back	Being Worked On	<i>Log details entered by user</i>	Sent Back To User ID	ID of user who sent back the To Do	ID of user who sent back the To Do
A user adds a log entry	User Details	Status remains the same	<i>Log details entered by user</i>		ID of user who added the entry	
A user manually overrides priority	Override Priority	Status remains the same	Priority changed from <i>old value</i> to <i>new value</i>	Assigned To User ID	ID of user who made the change	
Priority is updated by a calculate priority algorithm	Calculated Priority	Status remains the same	Priority changed from <i>old value</i> to <i>new value</i>		ID of user that added or updated the To Do or the user associated with the Recalculate Priority batch job.	

Managing To Do Entries

This section describes the various pages available to view and work on To Do entries.

To Do Management

The To Do Management portal provides a multi-query zone that includes a search for To Do entries using To Do Type and other To Do information. Users may search for entries using multiple criteria and perform common actions, such as assignment and completion, on selected entries.

It is intended to be used by both supervisors and non-supervisor To Do users. Supervisors are identified by their security access to the portal.

Use **Menu > To Do > To Do Management** to navigate to the portal.

To Do Information Search

This zone allows you to search for non-closed To Do entries using various attributes of the entries, and to perform actions on selected ones.

NOTE: Results are restricted by role. For supervisors, this search returns To Do entries that meet the search criteria and are in a role of which the supervisor is a member. For non supervisors, the search returns open To Do entries that meet the search criteria and are in a role of which the user is a member or entries currently assigned to the user. Refer to [To Do Entries Reference A Role](#) for more information about roles.

The following sections describe the features of this zone.

Search Filters

The following table describes each of the different filters supported by this zone.

Search Filter	Description
To Do Type	Use this filter to restrict the search to To Do entries of a specific type. Only To Do Types where the user is a member of at least one valid role for the type will be available for selection.
To Do Entry Status	Use this filter to restrict the search to To Do entries with a status of Open or Being Worked On . Note that the underlying query excludes completed To Do entries.
Days Old	On the To Do Management portal, this option is represented by a pair of filter fields. Use these filters to restrict the search to To Do entries whose age falls within a given range in days. For example, entering values of 2 - 5 will restrict the search to entries that are greater than or equal to two days old and less than or equal to five days old. On the To Do Dashboard portal, this option lists the To Do Summary age ranges as set up for the user. Select a specific age range to restrict the search to To Do entries whose age falls within the given range in days.
Assign To User	Use this filter to restrict the search to To Do entries assigned to a particular user. This filter only appears if the current user has To Do supervisor access.
Priority	Use this filter to restrict the search to To Do entries with a specific priority.
Key Value	Use this filter to restrict the search to To Do entries with a sort key value containing the entered value.
Message	Use this filter to restrict the search to To Do entries with a specific message. This filter appears after the To Do Type filter has been

Search Filter	Description
Characteristic	<p>populated and shows a list of the message texts from all non closed To Do entries of the selected To Do Type.</p> <p>Use these filters to restrict the search to To Do entries with a specific Characteristic Type and value. Up to five characteristic type and value pairs may be entered. For manual To Do types, the list of characteristic types will be restricted to the characteristic types defined for the To Do Type. For automated To Do Types, if valid To Do characteristic types are configured for the To Do type, only those are shown; otherwise, all valid characteristic types for the To Do Entry entity are shown.</p>

The system shows the total number of To Do entries displayed and the total number that satisfy your search criteria immediately below the set of results.

NOTE: For performance reasons, the search zone is configured to restrict the number of rows retrieved by the query. The 'Total Records' number will indicate whether there are more To Do entries that meet the criteria than can be displayed.

Search Results

The zone will display all To Do entries that meet the search criteria, up to the limit defined as a parameter to the zone. The following columns are displayed initially:

- The Action column includes the button Work. Click this button to drill into the page on which the entry's respective object is displayed. If the To Do type has been configured to associate a script with this To Do entry's message number, then instead of being taken to the respective page, the associated script is launched. Refer to [Working On A To Do Entry](#) for more information.

NOTE: Current To Do. Drilling into an entry from this page sets it to be the user's current To Do. Refer to [A User's Current To Do](#) for more information.

CAUTION: Automatic Assignment! When you click the Work button for an open entry, the system changes the status of the entry to **Being Worked On** and assigns it to you.

NOTE: Work List. This column has a Work List icon. Clicking this icon populates the [Work List](#) dashboard zone with the results. Clicking on entries in the Work List zone performs all the logic described here when clicking the Work button for one entry. It will drill into the related object or launch a script, if configured. It will make this To Do the 'current' To Do and will assign it to you if it is **Open**.

- Entries are sorted by their **Priority**. Highest in priority are listed first.
- **Days Old** is the number of days since the To Do entry was created by the system. Entries are sorted from youngest to oldest within priority.
- **Status** is the current status of the To Do entry.
- **Assign To User** is the user currently assigned to the To Do entry.
- **Message** is the message associated with the To Do entry.
- **Related** displays a count of entries that are potentially related to the current entry based on having the same foreign key characteristic values. Click the hyperlink to navigate to the [To Do Search](#) page with the current entry as the Related To Do Filter value.

- **Note** displays a Comment icon  if there are either comments or a log entry of type **Forwarded**, **Sent Back** or **User Details** on the To Do Entry. Click the icon to open a pop-up window which displays the To Do entry information, message, comments and logs.
- **Characteristics** displays the characteristic types and values for the entry as a concatenated string.
- **Related Entity** displays the information for the object related to this entry. The information string allows you to navigate to the page on which the entry's respective object is displayed.
- **To Do ID** is the system generated key of the entry. Click the hyperlink to navigate to the [To Do Entry](#) page to view or maintain the current entry.

Click the **Column Configuration** icon  in the zone header to show the [Column Configuration Area](#) in which additional columns can be added to the results. The additional columns include the following:

- **Create Date/Time** contains the date and time the To Do entry was created by the system.
- **Key 1 to Key 5** contain the first five sort key values for the entry.
- **To Do Role** displays the description of the role for the To Do entry.

Actions

The zone provides the ability to perform certain actions on one or more selected To Do Entries.

Click the check box in the results list heading to select all entries displayed in the grid or click the box in a row to select a specific entry. The following actions are available:

- Use the **Update** button to open a pop-up window in which you can update the priority and/or add a **User Details** [log entry](#) to the selected To Do entries.
- Use the **Assign** button to assign a user to the selected To Do entries. Supervisors will be presented with a pop-up window in which they can choose the assignee from a list of users who are members of at least one role for the To Do Type. The user search includes information about the number of To Do entries already assigned to each user. For users without supervisor access, the current user is assumed to be the assignee and the window is not displayed. Note that the system does not allow a non supervisor to assign themselves a To Do that is being worked on by another user.
- Use the **Unassign** button to reopen the selected To Do entries and remove the assignee. Note that the system does not allow non supervisors to reopen a To Do that is being worked on by another user.
- Use the **Complete** button to [complete](#) the selected To Do entries. Both supervisors and non supervisors may complete any To Do entry, including those assigned to other users.

To Do Supervisor Functions

This section describes several To Do transactions that aid supervisors in the monitoring and assignment of To Do entries.

Supervisor To Do Summary

This Supervisor To Do Summary page summarizes To Do entries by To Do Type. Only entries that are **Open** (i.e., not assigned to a specific user) or **Being Worked On** are summarized.

NOTE: Only To Do entries that are assigned to a role to which you belong are summarized on this page. Refer to [To Do Entries Reference A Role](#) for more information.

Use **Menu > To Do > Supervisor To Do Summary** to open this page.

Description of Page

This page summarizes all To Do entries that are **Open** or **Being Worked On**.

- **To Do Type** contains the description of the To Do type.
- **Priority** provides a total count of To Do entries of a given type by priority. For each distinct priority the description includes the priority value followed by the corresponding number of entries. If all entries are of the same priority no additional count is displayed.
- **Total** contains the total of **Open** and **Being Worked On** entries. The hyperlink navigates to the [Supervisor To Do Assignment](#) transaction, setting it to display all **Open** and **Being Worked On** entries for the given To Do Type.
- **Open** contains the number of To Do Entries whose status is **Open**. The hyperlink navigates to the [Supervisor To Do Assignment](#) transaction, setting it to display all **Open** entries for the given To Do Type.
- **Being Worked On** contains the number of To Do entries whose status is **Being Worked On**. The hyperlink navigates to the [Supervisor To Do Assignment](#) transaction, setting it to display all **Being Worked On** entries for the given To Do Type.

The "age bars" that appear to the right of the totals highlight the age of the To Do entries. The colors red, yellow and green are used to highlight the relative number of old, middle-aged and new To Do entries. The age associated with each of these colors is [user-configurable](#).

Supervisor User Summary

The Supervisor User Summary page summarizes To Do entries by the user who is assigned to work on the entries. Only entries that are **Being Worked On** are summarized.

NOTE: Only To Do entries that are assigned to a role to which you belong are summarized on this page. Refer to [To Do Entries Reference A Role](#) for more information.

Use **Menu > To Do > Supervisor User Summary** to open this page.

Description of Page

This page contains a grid that displays all assigned To Do entries by User ID and To Do type. It indicates how many To Do entries of the displayed Type are assigned to the user (Assigned this Type) and how many To Do entries in total are assigned to the user (Assigned Total).

Clicking the hyperlinks transfer you to the [Supervisor To Do Assignment](#) transaction. On this transaction, you can assign / reassign To Do entries to a specific user. The difference is that clicking the To Do Type hyperlink causes only **Open** entries to be displayed on the Assignment transaction. Clicking the count in the Assigned this Type column causes **Being Worked On** entries assigned to the displayed user to be shown.

Supervisor To Do Assignment

This page lists To Do entries of a given type and allows a supervisor to assign / reassign them to a designated user.

NOTE: Refer to the [To Do Management](#) portal for a page that provides many more filters to narrow down the results. In addition, it provides more data in the results and allows the user to adjust the priority of To Do entries.

Use **Menu > To Do > Supervisor To Do Assignment** to open this page.

Description of Page

This page contains **Open** or **Being Worked On** To Do entries of a given type. These entries can be assigned to a specified user one-by-one or several at a time. The following points describe this functionality:

- You can select a different **To Do Type** by typing in a value or pressing the search button in the upper right corner. An **Info** description of the To Do type appears on the left.

- You can change the list of entries displayed according to their status. Select the **Filter by** status to be All (blank), **Open**, or **Being Worked On**.
- For **Being Worked On** entries, you may also **Filter by User** to limit the search to a specific user assigned to the To Do entries.
- If you want to re-sort the entries by a different value, click the search button adjacent to **Extra Information**. Each row's respective sort value is displayed in the **Extra Information** column.

NOTE: Extra Information. Each To Do list's default **Extra Information** is defined on the list's [To Do Type](#). Also note that each To Do list's available **Extra Information** differs.

- Click the **Select All** button to select all entries displayed in the grid. Click the **Clear All** to remove the selections in the grid.
- Use the checkbox if you want to assign specific entries.
- Entries are further sorted by their **Priority**. Highest in priority are listed first.
- **Create Date/Time** contains the date and time the To Do entry was created by the system. Click the Create Date/Time hyperlink to navigate to the To Do page where additional information is visible and where additional actions are possible.
- Click the number of **Related** entries hyperlink to navigate to the [To Do Search](#) query to list potentially related entries to the current entry.
- **Worked By** shows the user currently assigned to the To Do entry.
- **To Do Entry Status** is the current status of the To Do entry.
- **Message** contains a description of the To Do entry. Use the message description hyperlink to drill into the page on which the entry's respective object is displayed. If the To Do type has been configured to associate a script with this To Do entry's message number, then instead of being taken to the respective page, the associated script is launched. Refer to [Working On A To Do Entry](#) for more information.
- You can assign entries to a user:
 - Enter a user ID or search for a user using the **Assign To User** field. You can only select a user that is associated with a role that is associated with this **To Do Type**. Note that the current number of assignments is displayed adjacent.
 - Select one or more entries to assign to this user and click the **Assign** button. The entries' status becomes **Being Worked On**.

To Do List Functions

This section describes To Do pages that aid users in the assignment and working of entries in To Do lists.

To Do Summary

This page summarizes To Do entries that meet the following qualifications:

- The entry is **Open** and you belong to the entry's To Do role. Refer to [To Do Entries Reference A Role](#) for more information about roles.
- The entry is **Being Worked On** and you are the user to which it is assigned.

Use **Menu > To Do > To Do Summary** to open this page.

Keyboard Shortcut	Alternate Shortcut
Alt+X	Alt+Shift+X

NOTE: Refer to [Shortcut Key Summary](#) for information about the alternate shortcut.

FASTPATH: Refer to [The Big Picture of To Do Lists](#) for an overview of To Do functionality.

Description of Page

This page is dedicated to a grid that summarizes the To Do entries on which you can work. The following information is displayed:

- **To Do Type** contains the description of the To Do type.
- **Priority** provides a total count of To Do entries of a given type by priority. For each distinct priority the description includes the priority value followed by the corresponding number of entries. If all entries are of the same priority no additional count is displayed.
- **Total** contains the total of **Open** and **Assigned to You** entries. The hyperlink navigates to the [To Do List](#) transaction, setting it to display all **Open** and **Being Worked On** entries assigned to you for the given To Do Type.
- **Open** contains the number of To Do Entries whose status is **Open**. The hyperlink navigates to the [To Do List](#) transaction, setting it to display all **Open** entries for the given To Do Type.
- **Assigned to You** contains the number of To Do entries that are assigned to you whose status is **Being Worked On**. The hyperlink navigates to the [Supervisor To Do Assignment](#) transaction, setting it to display all **Being Worked On** entries for the given To Do Type.

The "age bars" that appear to the right of the totals highlight the age of the To Do entries. The colors red, yellow and green are used to highlight the relative number of old, middle-aged and new To Do entries. The age associated with each of these colors is [user-configurable](#).

To Do List

This page lists To Do entries of a given type that are either **Open** (e.g., not assigned to a specific user) or are assigned to you.

NOTE: Refer to the [To Do Management](#) portal for a page that provides many more filters to narrow down the results. In addition, it provides more data in the results and allows the user to adjust the priority of To Do entries.

NOTE: Restricted by role. Only those entries assigned to a role to which you belong may be seen on this page. Refer to [To Do Entries Reference A Role](#) for more information.

FASTPATH: We recommend familiarizing yourself with the topics described in [The Big Picture of To Do Lists](#) to fully appreciate how To Do entries are managed by the system.

Use **Menu > To Do > To Do List** to open this page.

Description of Page

This page contains a grid that summarizes the To Do entries of a given type on which you can work.

The **Info** section contains a concatenation of the **To Do Type**'s description and the user's name.

The area beneath **Info** provides you with options that control which To Do entries appear and the order in which they are displayed. The following points describe the various options:

- Use **Sort By** to define how you want the To Do entries sorted. The following options are available:
 - **Assigned Date - On or After.** This option sorts the To Do entries in chronological order (based on the date the entry was assigned to you) starting from the input **Date**. If you choose this option, the system assumes you want to start



from the earliest To Do entry. If you want to start from a date other than the earliest To Do entry, enter the desired **Date** and click the adjacent search button.

- **Assigned Date - On or Before.** This option sorts the To Do entries in reverse chronological order (based on the date the entry was assigned to you) starting from the input **Date**. If you choose this option, the system assumes you want to start from the today's date. If you want to start from a date other than today's date, enter the desired **Date** and click the adjacent search button.
- **Create Date - On or After.** This option sorts the To Do entries in chronological order (based on the date the entry was created) starting from the input **Date**. If you choose this option, the system assumes you want to start from the earliest To Do entry. If you want to start from a date other than the earliest To Do entry, enter the desired **Date** and click the adjacent search button.
- **Create Date - On or Before.** This option sorts the To Do entries in reverse chronological order (based on the date the entry was created) starting from the input **Date**. If you choose this option, the system assumes you want to start from the today's date. If you want to start from a date other than today's date, enter the desired **Date** and click the adjacent search button.
- **Extra Information.** This option sorts the To Do entries by the value of the **Extra Info**.
- Use **Extra Info** to choose data related to the To Do Entry that should be used to sort the To Do entries. This information is displayed in each entry's **Extra Information** column.

NOTE: Extra Info. Each To Do types's available **Extra Info** is defined on the [To Do Type Sort Keys](#). Also note that each To Do type's available **Extra Info** differs based on the configuration of the To Do Type.

- Use **Filter by** to restrict the To Do entries based on their status. The following options are available:
 - **All.** This option shows all entries that are **Open** or **Being Worked On**.
 - **Being Worked On.** This option shows all entries that are **Being Worked On** (and assigned to you).
 - **Open.** This option shows all entries that are **Open**.

The grid that follows contains the To Do entries that match your criteria. The following information appears:

- Click the **Select All** button to select all entries displayed in the grid. Click the **Clear All** button to remove the selections in the grid.
- Use the checkbox if you want to mark specific entries as **Completed** or **Being Worked On** using the **Complete** or **Assign** buttons at the bottom.
- - A Comment icon  appears if there are comments on the To Do item and a Log Entry icon  appears if there is a log entry of type **Forwarded**, **Sent Back** or **User Details** on the To Do item. This column appears if at least one To Do has either comments or a special log entry.
- Entries are further sorted by their **Priority**. Highest in priority are listed first.
- **Create Date/Time** contains the date and time the To Do entry was created by the system.
- Click the Create Date/Time hyperlink or either of the special icons to navigate to the [To Do entry](#) page.
- Click the number of **Related** entries hyperlink to navigate to the [To Do Search](#) query to list potentially related entries to the current entry.
- **Assigned Date/Time** contains the date and time the To Do entry was assigned to a user. This field is only populated on entries that are **Being Worked On**. If a user assigned the To Do entry, the user ID and name of the user who assigned the To Do entry are displayed beneath the Date/Time.
- **Message** contains a description of the To Do entry. Use the message description hyperlink to drill into the page on which the entry's respective object is displayed. If the To Do type has been configured to associate a script with this To Do entry's message number, then instead of being taken to the respective page, the associated script is launched. Refer to [Working On A To Do Entry](#) for more information.

NOTE: Current To Do. Drilling into an entry from this page sets it to be the user's current To Do. Refer to [A User's Current To Do](#) for more information on how to efficiently scroll through additional entries in your current work list.

CAUTION: Automatic Assignment! When you drill into an entry using the message description hyperlink from this page, the system changes the status of the entry to **Being Worked On** and assigns it to you.

- **To Do Entry Status** is the current status of the To Do entry.
- **Extra Information** contains the data for the entry that corresponds to the Extra Info chosen in the sort options above.
- **To Do ID** contains the unique identifier of the To Do entry.
- If you want to mark one or more entries as **Being Worked On**, check the desired entries and then click the **Assign** button.
- If you want to mark one or more entries as **Completed**, check the desired entries and then click the **Complete** button. Completed entries do not appear on the To Do list (but they are retained on the database for audit purposes).

To Do Entry

Refer to [Understanding To Do Processing](#) for detailed explanations about many To Do entry features.

To view a To Do entry. Use **Menu > To Do > To Do Entry > Search** . You are brought to a query portal with options for searching for a To Do Entry. Note that some query options limit the results. Refer to the inline help for more information.

NOTE: Restricted by role. Any user may change Comments for any To Do Entry. In addition, any user may add user Log details. However, for all other changes and actions, you may only change To Do entries that are assigned to you or ones that are **Open** and assigned to a role to which you belong. Refer to [To Do Entries Reference A Role](#) for more information about roles.

Once a To Do Entry has been selected, you are brought to the maintenance portal to view and maintain the selected record.

The inline help provides information about several fields. The following points highlight information about some of the fields that may be visible.

If the To Do entry has non-complete [related entries](#) an insight appears indicating the number of related entries. In addition, details about the related entries are shown in the Related To Do Entries zone.

If the To Do entry was **Created By** a background process, information about that background process appears with a link allowing the user to drill into the batch run, if desired. Refer to [To Dos Created for Object-Specific Error Conditions](#) for more information.

If the To Do type is configured to [To Do Entries May Be Routed Out Of The System](#), the **Extract Info** appears. If the extract process is pending, the information indicates that. Otherwise, if it has run, information about the background process appears with a link allowing the user to drill into the batch run, if desired.

The **Characteristics** collection shows existing characteristics. This collection is maintained using the Edit action for users that are allowed to update this To Do entry. Refer to [To Do Entry Characteristics](#) for more information.

Actions

This page has two special actions.

- Use the **Forward** to assign a To Do to another user or role. When a To Do is forwarded, a log entry indicates who forwarded the To Do, to whom it was forwarded, and the specified reason. The dialogue prompts for whether to send to a User or a Role. The search for User includes information about the number of To Do entries already assigned to this user. When choosing a User, confirm the correct Role. The Details provided are captured in the log entry.
- **Send Back** is only applicable if the **Sent By** user is populated. When a To Do is sent back, a log entry is created that indicates when the To Do was sent back and by whom. If the To Do is **Open**, this dialogue allows you to send it back

to a different role. If the To Do is assigned to you, the dialogue allows you to re-assign the To Do to the person who assigned it to you. The Details provided are captured in the log entry.

Related To Do Entries

If the To Do has [related To Do entries](#), this zone appears with information about the related entries. Use this **Edit** hyperlink to navigate to the [To Do Search](#) query to perform actions on the related entries.

Adding a Manual To Do Entry

If your system is configured with [manual To Do types](#), you can add a To Do entry online.

Open the **Menu > To Do > To Do Entry > Add**.

You are prompted for a **To Do Type**. Only To Do types that are set up for manual usage appear in the list.

The default **To Do Type Priority** is displayed adjacent. Use **Override Priority** to override the default [priority](#) assigned by the system.

Type a **Subject** for your To Do entry. Depending on how the To Do type is set up, the subject may appear as the message in the To Do entry and To Do lists.

Enter a **Comment** to provide a longer description of and more details about the To Do entry.

Send To indicates whether the new To Do will be assigned to a **Role** (the default) or **User**.

The **Role** indicates the role to which this To Do entry will be assigned. Only users of the specified role will be able to view and work on the To Do entry. The role is defaulted from the To Do type. If you want to assign the To Do to a different role, change the specified role. You can only assign the To Do entry to one of the roles specified on the To Do type.

User appears if **Send To** is set to **User**. Use this option if you want to assign the To Do to a specific user. The user must be a member of the selected role.

If the [To Do type](#) defines valid characteristic types, the **Characteristics** collection is visible. If any of the characteristic types are flagged as Default on the To Do type, the characteristic type with its default value (if applicable) are displayed.

To Do Search

This page allows you to search for To Do entries using various search criteria, and perform various actions on selected ones. This page includes completed To Do entries in its search results, when applicable with respect to the filter criteria.

Use **Menu > To Do > To Do Search** to open this page.

NOTE: Refer to the [To Do Management](#) portal for a page that provides many more filters to narrow down the results. In addition, it provides more data in the results and allows the user to adjust the priority of To Do entries.

NOTE: No restriction by role. This page returns all To Do entries that meet the search criteria, regardless of the To Do entry's role. Using the search, a user may drill into the details of a To Do entry even if the To Do is not assigned to the user. Refer to [To Do Entries Reference A Role](#) for more information about roles.

The top half of the page is where you enter the criteria used to search for To Do entries.

CAUTION: Try to be as specific as possible when entering search criteria. Why? Because entering open-ended search criteria may have a severe impact on response times.



The following table describes each of the different search filters.

Search Filter	Description
Related To Do	<p>If you're searching for potentially related entries for a given To Do entry, choose Specific To Do for the Related To Do Filter. Enter the To Do ID.</p> <p>A filter value of Not Applicable defaults.</p>
To Do Type	<p>If you're searching for a To Do entry and you know the value of a To Do Type linked to the To Do entry, choose Specific To Do Type for the To Do Type Filter. Enter the To Do Type.</p> <p>A filter value of All defaults.</p>
Char Type	<p>If you're searching for a To Do entry and you know the value of a characteristic linked to the To Do entry, choose Specific Char Type for the Char Type Filter. Enter the Characteristic Type and Characteristic Value.</p> <p>A filter value of Not Applicable defaults.</p> <p>Only characteristic types that include a characteristic entity of To Do Entry and that have been marked to allow searching by characteristic value are available.</p>
User	<p>Use this search method if you know the Created By User, Assigned To User or Completed By User for the To Do entry. Enter the appropriate User Id.</p> <p>A filter value of Not Applicable defaults.</p>
Date Range	<p>Use this field if you're searching for a To Do entry and know the Date Created or Date Completed.</p> <p>A filter value of Date Created defaults. The Start Date/Time defaults to the current date, 12:00AM and the End Date/Time defaults to the current date, 11:59PM.</p> <p>If you enter a Date Range Filter of All, the system ignores this search method.</p>
Status	<p>Use this search method to restrict the search to To Do entries with a specific status value. You may search for To Do entries in the status of Open, Being Worked On or Completed. You may also perform a combination search for To Do entries that have a status value of either Open or Being Worked On.</p> <p>A filter value of All defaults.</p>

NOTE: The system allows any combination of values. The system does not try to validate your search combinations, even if they do not make sense. For example, if you enter a **User Filter** value of **Completed By User** and a **Status Filter** value of **Open**, you will not get an error. In this case, the system will find no records that match your criteria (because To Do entries that are Open do not have a Completed By User).

The system shows the total number of To Do entries that satisfy your search results immediately below the grid.

The first group of To Do entries is displayed in the grid at the bottom of the page.

- Click the **Select All** button to select all entries displayed in the grid. Click the **Clear All** to remove the selections in the grid.
- Use the checkbox if you want to perform actions (see below) on specific entries. Only **Open** or **Being Worked On** entries may be selected.
- A Comment icon  appears if there are comments on the To Do item and a Log Entry icon  appears if there is a log entry of type **Forwarded**, **Sent Back** or **User Details** on the To Do item. This column appears if at least one To Do item has either comments or a special log entry. Use either icon to navigate to the To Do entry page.
- Entries are sorted by their **Priority**. Highest in priority are listed first.
- **Create Date/Time** contains the date and time the To Do entry was created by the system. Use the hyperlink to navigate to the To Do entry page.
- Click the number of **Related** entries hyperlink to redisplay this page listing potentially related entries to the current entry.

- **Last Assigned Date/Time** contains the date and time the To Do entry was most recently assigned to a user, if applicable, along with the Assigned To user.
- **Message** contains a description of the To Do entry. If the To Do entry is in the status of **Open** or **Being Worked On**, the message description allows you to drill into the page on which the entry's respective object is displayed. If the To Do type has been configured to associate a script with this To Do entry's message number, then instead of being taken to the respective page, the associated script is launched. Refer to [Working On A To Do Entry](#) for more information.

NOTE: Current To Do. Drilling into the page by clicking the Message hyperlink does not automatically assign **Open** To Do entries to the user (as the To Do List page does when clicking on the Message). But it does treat this as the user's current to do, enabling the functionality in the Current To Do dashboard zone. Refer to [A User's Current To Do](#) for more information.

- **Status** contains the current status of the To Do entry.
- **Completion Date/Time** contains the date and time the To Do entry was completed and the user who completed the entry, if applicable.
- **To Do Type** contains a description of the To Do type for the To Do entry.

Actions

- Use the **Assign** button to assign or reassign the selected entries to a user. Enter a user ID or search for a user using the **Assign To User** field. By default this field is populated with the current user's ID. Note that the user's current number of assignments is displayed adjacent. Upon successful processing, the selected entries are assigned to the specified user and the status of **Open** entries becomes **Being Worked On**. Additionally, a corresponding [log entry](#) is added to each To Do.

NOTE: You may only assign To Do entries to yourself or to someone else if you are a valid user in the To Do entry's current role.

NOTE: Only users with **Supervisor Assignment** access rights may reassign entries that are not currently assigned to them.

- Use the **Reopen** button to unassign the selected entries from their users. Upon successful processing, the selected entries become **Open** and a corresponding [log entry](#) is added to each To Do.

NOTE: Only users with **Supervisor Assignment** access rights may unassign entries that are not currently assigned to them and the user must be a valid user in the To Do entry's current role.

- Use the **Complete** button to [complete](#) the selected entries.

To Do Dashboard

This portal provides a high level summary of open and being worked on To Do entries by various criteria. It is intended to be used by both supervisors and non-supervisor To Do users. An implementation may introduce additional zones to this portal as needed.

NOTE: Results are restricted by role. For supervisors, the charts consider To Do entries that are in a role of which the supervisor is a member. For non supervisors, the charts consider open To Do entries that are in a role of which the user is a member or entries currently assigned to the user. Refer to [To Do Entries Reference A Role](#) for more information about roles.

Use **Menu > To Do > To Do Dashboard** to navigate to the portal.

The following zones may appear as part of the portal's **Main** tab page

- **To Do Entries By Role.** This zone summarizes To Do entries by their currently assigned role.
- **To Do Entries By Status.** This zone summarizes To Do entries by their current status.
- **To Do Entries By Priority.** This zone summarizes To Do entries by their priority.
- **To Do Entries By Age.** This zone summarizes To Do entries by age based on age ranges defined for the current user.
- **To Do Entries By Type.** This zone summarizes To Do entries by their to do type.

Selecting a specific slice of data on any of these zones broadcasts its value to the other zones on the portal allowing them to filter their data accordingly. Use the **Reset** action on each zone to reset the filter set by this zone.

The following zone appears as part of the portal's **Details** tab page

- **To Do Details** This zone lists To Do entries that match various criteria and allows the user to work and manage the list.

To Do Details

This zone allows you to search for non-closed To Do entries using various attributes of the entries, and to perform actions on selected ones.

NOTE: Results are restricted by role. For supervisors, this search returns To Do entries that meet the search criteria and are in a role of which the supervisor is a member. For non supervisors, the search returns open To Do entries that meet the search criteria and are in a role of which the user is a member or entries currently assigned to the user. Refer to [To Do Entries Reference A Role](#) for more information about roles.

The following sections describe the features of this zone.

Search Filters

The following table describes each of the different filters supported by this zone.

Search Filter	Description
To Do Type	Use this filter to restrict the search to To Do entries of a specific type. Only To Do Types where the user is a member of at least one valid role for the type will be available for selection.
To Do Entry Status	Use this filter to restrict the search to To Do entries with a status of Open or Being Worked On . Note that the underlying query excludes completed To Do entries.
Days Old	<p>On the To Do Management portal, this option is represented by a pair of filter fields. Use these filters to restrict the search to To Do entries whose age falls within a given range in days. For example, entering values of 2 - 5 will restrict the search to entries that are greater than or equal to two days old and less than or equal to five days old.</p> <p>On the To Do Dashboard portal, this option lists the To Do Summary age ranges as set up for the user. Select a specific age range to restrict the search to To Do entries whose age falls within the given range in days.</p>
Assign To User	Use this filter to restrict the search to To Do entries assigned to a particular user. This filter only appears if the current user has To Do supervisor access.
Priority	Use this filter to restrict the search to To Do entries with a specific priority.

Search Filter	Description
Key Value	Use this filter to restrict the search to To Do entries with a sort key value containing the entered value.
Message	Use this filter to restrict the search to To Do entries with a specific message. This filter appears after the To Do Type filter has been populated and shows a list of the message texts from all non closed To Do entries of the selected To Do Type.
Characteristic	Use these filters to restrict the search to To Do entries with a specific Characteristic Type and value. Up to five characteristic type and value pairs may be entered. For manual To Do types, the list of characteristic types will be restricted to the characteristic types defined for the To Do Type. For automated To Do Types, if valid To Do characteristic types are configured for the To Do type, only those are shown; otherwise, all valid characteristic types for the To Do Entry entity are shown.

The system shows the total number of To Do entries displayed and the total number that satisfy your search criteria immediately below the set of results.

NOTE: For performance reasons, the search zone is configured to restrict the number of rows retrieved by the query. The 'Total Records' number will indicate whether there are more To Do entries that meet the criteria than can be displayed.

Search Results

The zone will display all To Do entries that meet the search criteria, up to the limit defined as a parameter to the zone. The following columns are displayed initially:

- The Action column includes the button Work. Click this button to drill into the page on which the entry's respective object is displayed. If the To Do type has been configured to associate a script with this To Do entry's message number, then instead of being taken to the respective page, the associated script is launched. Refer to [Working On A To Do Entry](#) for more information.

NOTE: Current To Do. Drilling into an entry from this page sets it to be the user's current To Do. Refer to [A User's Current To Do](#) for more information.

CAUTION: Automatic Assignment! When you click the Work button for an open entry, the system changes the status of the entry to **Being Worked On** and assigns it to you.

NOTE: Work List. This column has a Work List icon. Clicking this icon populates the [Work List](#) dashboard zone with the results. Clicking on entries in the Work List zone performs all the logic described here when clicking the Work button for one entry. It will drill into the related object or launch a script, if configured. It will make this To Do the 'current' To Do and will assign it to you if it is **Open**.

- Entries are sorted by their **Priority**. Highest in priority are listed first.
- **Days Old** is the number of days since the To Do entry was created by the system. Entries are sorted from youngest to oldest within priority.
- **Status** is the current status of the To Do entry.
- **Assign To User** is the user currently assigned to the To Do entry.
- **Message** is the message associated with the To Do entry.

- **Related** displays a count of entries that are potentially related to the current entry based on having the same foreign key characteristic values. Click the hyperlink to navigate to the [To Do Search](#) page with the current entry as the Related To Do Filter value.
- **Note** displays a Comment icon  if there are either comments or a log entry of type **Forwarded**, **Sent Back** or **User Details** on the To Do Entry. Click the icon to open a pop-up window which displays the To Do entry information, message, comments and logs.
- **Characteristics** displays the characteristic types and values for the entry as a concatenated string.
- **Related Entity** displays the information for the object related to this entry. The information string allows you to navigate to the page on which the entry's respective object is displayed.
- **To Do ID** is the system generated key of the entry. Click the hyperlink to navigate to the [To Do Entry](#) page to view or maintain the current entry.

Click the **Column Configuration** icon  in the zone header to show the [Column Configuration Area](#) in which additional columns can be added to the results. The additional columns include the following:

- **Create Date/Time** contains the date and time the To Do entry was created by the system.
- **Key 1 to Key 5** contain the first five sort key values for the entry.
- **To Do Role** displays the description of the role for the To Do entry.

Actions

The zone provides the ability to perform certain actions on one or more selected To Do Entries.

Click the check box in the results list heading to select all entries displayed in the grid or click the box in a row to select a specific entry. The following actions are available:

- Use the **Update** button to open a pop-up window in which you can update the priority and/or add a **User Details** log entry to the selected To Do entries.
- Use the **Assign** button to assign a user to the selected To Do entries. Supervisors will be presented with a pop-up window in which they can choose the assignee from a list of users who are members of at least one role for the To Do Type. The user search includes information about the number of To Do entries already assigned to each user. For users without supervisor access, the current user is assumed to be the assignee and the window is not displayed. Note that the system does not allow a non supervisor to assign themselves a To Do that is being worked on by another user.
- Use the **Unassign** button to reopen the selected To Do entries and remove the assignee. Note that the system does not allow non supervisors to reopen a To Do that is being worked on by another user.
- Use the **Complete** button to [complete](#) the selected To Do entries. Both supervisors and non supervisors may complete any To Do entry, including those assigned to other users.

Reports

About Reports

Reports include operational reports related to device events, validation exceptions, and other operational data. Reports can also be based on devices, measuring components, Service Points, service providers, and other data.

Oracle Utilities Meter Data Management reports are implemented using Oracle Business Intelligence Publisher (BI Publisher), and are administered via Oracle Business Intelligence Publisher and the Report functionality of the Oracle Utilities Application Framework.

Refer to the [Oracle Business Intelligence Publisher documentation](#) for more information about installing Oracle Business Intelligence Publisher and [creating and defining reports](#). For additional details on how reports are defined and administered see [Reporting and Monitoring Tools](#) in the Oracle Utilities Application Framework *Administrative User Guide*.

Running Oracle Utilities Meter Data Management Reports

This portal is used to submit a new instance of a Report.

Refer to [About Reports](#) for additional functional information.

You can access the portal from the **Main > Tools > Report Submission**.

First, the appropriate Report code must be selected. The Reports provided out-of-the-box are:

- **Device Events Report:** this report generates a pie graph depicting the percentage of Device Events for each Device Event Type for the specific search criteria.
- **Device VEE Exceptions Report:** this report generates a pie graph depicting the percentage of VEE Exception for Exception Type and Market for the specific search criteria.

Next, enter the parameter values for the report as appropriate and submit the report.

Oracle Utilities Customer to Meter

Administrative User Guide

Release 2.9.0.1.1

F76345-01

April 2023

Also used with:

- Oracle Utilities Customer Cloud Service 23A
- Oracle Utilities Billing Cloud Service 23A
- Oracle Utilities Rate Cloud Service 23A

Oracle Utilities Customer to Meter Administrative User Guide

Release 2.9.0.1.1

F76345-01

April 2023

Documentation build: 3.23.2023 12:15:36 [X1_1679591736000]

Copyright © 2023, Oracle and/or its affiliates. All rights reserved.

This software and related documentation are provided under a license agreement containing restrictions on use and disclosure and are protected by intellectual property laws. Except as expressly permitted in your license agreement or allowed by law, you may not use, copy, reproduce, translate, broadcast, modify, license, transmit, distribute, exhibit, perform, publish, or display any part, in any form, or by any means. Reverse engineering, disassembly, or decompilation of this software, unless required by law for interoperability, is prohibited.

The information contained herein is subject to change without notice and is not warranted to be error-free. If you find any errors, please report them to us in writing.

If this is software or related documentation that is delivered to the U.S. Government or anyone licensing it on behalf of the U.S. Government, then the following notice is applicable:

U.S. GOVERNMENT END USERS: Oracle programs, including any operating system, integrated software, any programs installed on the hardware, and/or documentation, delivered to U.S. Government end users are "commercial computer software" pursuant to the applicable Federal Acquisition Regulation and agency-specific supplemental regulations. As such, use, duplication, disclosure, modification, and adaptation of the programs, including any operating system, integrated software, any programs installed on the hardware, and/or documentation, shall be subject to license terms and license restrictions applicable to the programs. No other rights are granted to the U.S. Government.

This software or hardware is developed for general use in a variety of information management applications. It is not developed or intended for use in any inherently dangerous applications, including applications that may create a risk of personal injury. If you use this software or hardware in dangerous applications, then you shall be responsible to take all appropriate fail-safe, backup, redundancy, and other measures to ensure its safe use. Oracle Corporation and its affiliates disclaim any liability for any damages caused by use of this software or hardware in dangerous applications.

Oracle and Java are registered trademarks of Oracle and/or its affiliates. Other names may be trademarks of their respective owners. Intel and Intel Xeon are trademarks or registered trademarks of Intel Corporation. All SPARC trademarks are used under license and are trademarks or registered trademarks of SPARC International, Inc. AMD, Opteron, the AMD logo, and the AMD Opteron logo are trademarks or registered trademarks of Advanced Micro Devices. UNIX is a registered trademark of The Open Group.

This software or hardware and documentation may provide access to or information about content, products, and services from third parties. Oracle Corporation and its affiliates are not responsible for and expressly disclaim all warranties of any kind with respect to third-party content, products, and services unless otherwise set forth in an applicable agreement between you and Oracle. Oracle Corporation and its affiliates will not be responsible for any loss, costs, or damages incurred due to your access to or use of third-party content, products, or services, except as set forth in an applicable agreement between you and Oracle.

Contents

Administrative User Guides.....	25
Framework Administrative User Guide.....	25
General Options.....	25
Defining Installation Options.....	25
Installation Options - Main.....	25
Installation Options - Messages.....	26
Installation Options - Algorithms.....	27
Installation Options - Accessible Modules.....	28
Installation Options - Installed Products.....	28
Support For Different Languages.....	29
User Language.....	29
Customer Language.....	30
Defining Languages.....	30
Defining Countries.....	31
Country - Main.....	31
Country - States.....	32
Defining Currency Codes.....	32
Defining Time Zones.....	32
Designing Time Zones.....	33
Setting Up Time Zones.....	34
Setting Up Seasonal Time Shift.....	35
Defining Geographic Types.....	35
Defining Work Calendar.....	35
Defining Display Profiles.....	36
Additional Hijri Date Configuration.....	38
Defining Phone Types.....	38
Defining Feature Configurations.....	38
Feature Configuration - Main.....	38
Feature Configuration - Messages.....	39
Defining Master Configurations.....	39
Security & User Options.....	40
Application Security.....	40
Understanding Application Security.....	41
Defining Application Services.....	45
Defining Security Types.....	45
Defining User Groups.....	46
Defining Users.....	47
Application Security Query.....	47
Row Security.....	48
Defining Access Groups.....	48
Defining Data Access Roles.....	48
Data Privacy.....	49
Encryption and Masking.....	50
The Approach to Implementing Object Erasure.....	56
Data Redaction on Export.....	59
Defining Redaction Rules.....	61
Obfuscation Configuration.....	61
Cryptography Keys.....	61
Understanding Key Rings.....	62
Defining Key Rings.....	63
User Interface Tools.....	64
Understanding Portals and Zones.....	64
Setting Up Portals and Zones.....	67
Defining Zone Types.....	67
Defining Zones.....	68
Defining Context-Sensitive Zones.....	100
Defining Portals.....	100
Defining Menu Options.....	101

Defining Navigation Keys.....	102
Navigation Key Types.....	102
Navigation Key vs. Navigation Option.....	102
The Flexibility of Navigation Keys.....	103
Linking to External Locations.....	103
Overriding Navigation Keys.....	103
Maintaining Navigation Keys.....	103
Defining Navigation Options.....	104
Navigation Option - Main.....	105
Navigation Option - Tree.....	107
Understanding System Messages.....	107
Defining System Messages.....	107
Understanding Unified Search.....	108
Trees.....	110
Defining Trees.....	113
Contextual Insights.....	113
Insight Types.....	113
Insight Groups.....	116
Color Configuration.....	117
Defining Colors.....	117
Color Options.....	117
Defining Display Icons.....	117
Custom Look and Feel Options.....	118
User Interface.....	118
UI Map Help.....	118
Database Options.....	118
Understanding The Data Model.....	119
Fields.....	119
Tables.....	121
Maintenance Objects.....	124
Defining Valid Values.....	126
Characteristic Types.....	127
Foreign Key References.....	129
Defining Tables.....	131
Defining Fields.....	131
Defining Maintenance Objects.....	132
Maintenance Object - Main.....	132
Maintenance Object - Options.....	133
Maintenance Object - Algorithms.....	133
Maintenance Object - Maintenance Object Tree.....	135
Defining Lookups.....	135
Defining Extendable Lookups.....	136
Extendable Lookup Advanced Topics.....	136
Defining Characteristic Types.....	138
Defining Foreign Key References.....	138
Audit Trails.....	139
Captured Information.....	139
How Auditing Works.....	140
The Audit Trail File.....	140
How To Enable Auditing.....	140
Audit Queries.....	141
Bundling.....	143
About Bundling.....	143
Configuring Maintenance Objects for Bundling.....	144
Working with Bundles.....	146
Revision Control.....	148
About Revision Control.....	148
Working with the Revision Control Zones.....	149
Working with the Revision Control Portal.....	151
Information Lifecycle Management	153
The Approach to Implementing Information Lifecycle Management.....	153
Enabling ILM for Supported Maintenance Objects.....	155
Ongoing ILM Tasks.....	156
Archived Foreign Keys.....	156

Configuration Tools.....	157
Business Objects.....	157
The Big Picture of Business Objects.....	157
Defining Business Objects.....	172
Advanced BO Tips and Techniques.....	178
Defining Status Reasons.....	180
Data Areas.....	180
Defining Data Areas.....	181
Business Services.....	182
Service Program.....	182
Defining Business Services.....	182
User Interface (UI) Maps.....	187
Defining UI Maps.....	189
Ensuring Unique Element IDs for UI Maps.....	258
Process Flows.....	259
Understanding Process Flows.....	259
Designing Process Flows.....	261
Defining Process Flow Types.....	263
Action Method.....	263
Defining Action Methods.....	265
Algorithms.....	265
The Big Picture Of Algorithms.....	265
Defining Algorithm Types.....	268
Defining Algorithms.....	269
Advanced Algorithm Tips.....	270
Script Options.....	270
The Big Picture Of Scripts.....	270
The Big Picture Of BPA Scripts.....	271
The Big Picture Of Server-Based Scripts.....	277
Maintaining Scripts.....	282
Merging Scripts.....	327
Maintaining Functions.....	330
Maintaining Managed Content.....	332
Defining Entity Tags.....	333
Advanced Schema Topics.....	333
Schema Nodes and Attributes.....	333
UI Hint Syntax.....	355
Schema Designer.....	363
Schema Viewer.....	365
Business Event Log.....	365
Miscellaneous Topics.....	365
Javadocs Viewer.....	366
Module Configuration.....	366
Global Context Overview.....	367
System Data Naming Convention.....	367
Accessibility Considerations.....	368
Referencing URIs.....	369
Caching Overview.....	371
Expression Parser.....	373
Debug Mode.....	375
Prepare Issue Details.....	376
System Override Date.....	377
Additional Search Options.....	377
Extensions Dashboard.....	377
To Do Lists.....	377
The Big Picture of To Do Lists.....	378
To Do Entries Reference A To Do Type.....	378
To Do Entries Reference A Role.....	378
The Lifecycle Of A To Do Entry.....	379
How Are To Do Entries Created?.....	380
Refining a To Do Entry's Details at Creation Time.....	383
The Priority Of A To Do Entry.....	385
Working On A To Do Entry.....	386
Monitoring A To Do Entry.....	386

To Do Entries Have Logs.....	386
Implementing Additional To Do Entry Business Rules.....	387
To Do Entries May Be Routed Out Of The System.....	387
To Do Information May Be Formatted By An Algorithm.....	387
Periodically Purging To Do Entries.....	387
Setting Up To Do Options.....	387
Installation Options.....	388
Messages.....	388
Feature Configuration.....	388
Defining To Do Roles.....	389
Defining To Do Types.....	389
Implementing The To Do Entries.....	393
Background Processes.....	394
Understanding Background Processes.....	394
Background Processing Overview.....	394
Parallel Background Processes.....	395
Parameters Supplied To Background Processes.....	396
Processing Errors.....	401
Error Post-Processing Logic.....	402
Post-Processing Logic.....	402
Timed Batch Processes.....	403
Monitor Background Processes.....	403
Plug-in Driven Background Processes.....	404
How to Re-extract Information.....	417
How to Submit Batch Jobs.....	417
How to Track Batch Jobs.....	417
How to Restart Failed Jobs and Processes.....	418
Assessing Level of Service.....	418
Defining Batch Controls.....	418
Batch Control - Algorithms.....	421
Defining File Integration Types.....	422
On-Line Batch Submission.....	422
Batch Submission Creates a Batch Run.....	422
Jobs Submitted in the Background.....	422
Email Notification.....	423
Running Multi-Threaded Processes.....	423
Batch Jobs May End in Error.....	423
Submitting Jobs in the Future.....	424
Lifecycle of a Batch Job Submission.....	424
Granting Access To Batch Submission.....	424
Batch Job Submission - Main.....	425
Tracking Batch Processes.....	427
Batch Run Tree.....	427
Batch Day Tracking.....	428
The Big Picture of Requests.....	430
Request Type Defines Parameters.....	430
Previewing and Submitting a Request	431
To Do Summary Email.....	431
Defining a New Request.....	431
Setting Up Request Types.....	432
Maintaining Requests.....	432
Attachments.....	432
Attachment Overview.....	432
Configuring Your System for Attachments.....	434
Maintaining Attachments.....	435
Adding Attachments.....	435
Monitoring and Analytics.....	436
Reporting Tool Integration.....	436
The Big Picture Of Reports.....	436
Configuring The System To Enable Reports.....	438
Sample Reports Supplied with the Product.....	440
How To Define A New Report.....	440
Service Health Check.....	444
Health Check Configuration.....	445

Viewing Health Check Results.....	445
Introducing Health Check Conditions.....	445
Measuring Performance.....	446
Understanding Performance Targets.....	446
Setting Up Performance Target Configuration.....	449
Maintaining Performance Targets.....	449
Capturing Statistics.....	450
Understanding Statistics.....	450
Configuring Your System for Statistics.....	450
Creating Cube Views.....	451
Understanding Cube Viewer.....	451
Configuring Cube Types.....	456
Product Use Metrics.....	457
External Messages.....	457
Incoming Messages.....	457
Inbound Web Services.....	458
Guaranteed Delivery.....	474
Outgoing Messages.....	474
Outbound Messages.....	475
Web Service Adapters.....	490
Sending Email.....	492
Web Service Category.....	493
Defining Web Service Categories.....	493
JMS Message Browser.....	493
Oracle Integration Cloud Catalog.....	494
Web Service Catalog Configuration.....	494
XAI Documentation Note.....	495
Integrations.....	495
Creating Application Links in External Applications.....	495
LDAP Integration.....	497
LDAP Integration Overview.....	497
Configuring LDAP Integration.....	498
Oracle Identity Manager Integration.....	501
User Redirection.....	503
Batch Scheduler Integration.....	504
Data Synchronization.....	504
Understanding Data Synchronization.....	504
Maintaining Sync Requests.....	508
Operational Analytics.....	508
Understanding Operational Analytics.....	508
Calendar and Time Dimensions.....	510
Maintaining Bucket Configurations.....	510
Defining Analytics Options.....	511
Defining Analytics Tables.....	511
Defining Analytics Attribute Mapping.....	512
Analytics Integration.....	513
Understanding Analytics Integration.....	513
Business Flags.....	514
Understanding Business Flags.....	514
Setting Up Business Flag Configuration.....	518
Maintaining Business Flags.....	519
Market Transaction Management.....	519
Understanding Market Transaction Management.....	519
Configuring Market Transaction Management.....	519
Defining Market Configurations.....	520
Defining Market Message Types.....	520
Defining Market Process Types.....	520
Maintaining Market Transactions.....	520
Maintaining Market Processes.....	520
Maintaining Market Process Events.....	521
Maintaining Market Messages.....	521
Content Migration Assistant (CMA).....	522
Understanding CMA.....	522
Types of Migrations.....	523

Migrating Configuration Data.....	524
Migrating Business Data.....	525
Data with System Generated Primary Keys.....	527
Importing Data that References a User	528
Additional Considerations.....	529
Versions and CMA.....	530
CMA Configuration.....	531
Master Configuration - Migration Assistant.....	531
Migration Plans.....	531
Defining a Migration Request.....	534
Identifying Tables to Exclude From Migrations.....	535
Configuring Custom Objects for Migration.....	536
The CMA Execution Process.....	537
Exporting a Migration.....	537
Importing and Applying a Migration.....	539
Running Batch Jobs.....	558
CMA Reference.....	559
Framework-Provided Migration Configuration.....	559
Facts.....	561
Fact Is A Generic Entity.....	561
Fact's Business Object Controls Everything.....	561
Fact Supports A Log.....	562
Conversion.....	562
Understanding The Conversion Process.....	562
Conversion Entities.....	564
Conversion Steps.....	564
A Note About Keys.....	570
Multiple Owners In A Single Database.....	570
Conversion Entity Dashboard.....	572
Data Export.....	572
Understanding Data Export.....	572
Generalized Data Export.....	572
Specialized Data Export.....	578
Defining Data Export Control.....	579
Generalized Export Dashboard.....	579
Customer to Meter Administrative User Guide.....	580
Customer to Meter Overview.....	580
Customer to Meter Overview.....	580
Best Practices.....	581
Performance Recommendations.....	581
Referencing Master Data by Identifiers.....	586
Recommendations for Creating an On-Premises Production Environment.....	587
Additional Resources.....	587
How to Get Support.....	587
Knowledge Base Articles.....	588
Support Hot Topic Emails.....	588
Embedded Help.....	589
Leveraging Demonstration Data.....	589
Customer User Groups.....	589
Customer To Meter Configuration.....	589
Cross Product Configuration Master Configuration.....	590
Customer to Meter Consolidated Maintenance and Data Mapping.....	591
Merged Maintenance.....	591
Customer To Meter Master Data Synchronization.....	592
Lookup Value Mapping.....	600
Data Audit Maintenance.....	601
Transactional Data Mapping.....	602
Customer To Meter Table Setup Sequence.....	610
Customer Care and Billing Control Table Setup Sequence.....	610
Meter Data Management Configuration Setup Sequence.....	625
Operational Device Management Table Setup Sequence.....	628
Understanding Online / Batch Loaders.....	630
Customer To Meter Batch Processing.....	632
Batch Process Dependencies.....	633

Defining General Options.....	640
Defining Installation Options.....	640
Installation Options - Main.....	640
Installation Options - Person.....	642
Installation Options - Account.....	642
Installation Options - Billing.....	643
Installation Options - C&C.....	644
Installation Options - Financial Transaction.....	645
Installation Options Framework - Algorithms.....	645
Defining Customer Languages.....	650
Defining Accounting Calendars.....	651
Defining General Ledger Divisions.....	651
Defining Banks & Bank Accounts.....	652
Bank - Main.....	652
Bank - Bank Account.....	652
Defining Issuing Centers.....	653
Actions.....	653
Issuing Center List.....	653
Issuing Center.....	653
Issuing Center Log.....	654
Defining Service Tasks Options.....	654
About Service Tasks.....	654
About Service Task Types.....	654
Defining Service Task Types.....	654
Base Package Service Task Types.....	655
Defining Customer Questions.....	657
System-Wide Options.....	658
Installation Options - Framework.....	658
Configuring Installation Options - Framework.....	658
Feature Configurations.....	659
Configuring Feature Configurations.....	659
Time Zones.....	660
Configuring Time Zones.....	660
Configuring Multi-time Zone Support.....	660
Defining Financial Transaction Options.....	661
The Financial Big Picture.....	661
Bills, Payments & Adjustments.....	661
Bill Details.....	662
Payment Details.....	663
Adjustment Details.....	664
Current Amount versus Payoff Amount.....	665
Financial Transactions Created Between Bills.....	668
Financial Transactions And Aged Debt.....	670
Preventing SA Balances And The GL From Being Impacted Until Bill Completion.....	670
Forcing The Freeze Date To Be Used As The Accounting Date.....	672
How Late Payment Charges Get Calculated.....	673
Service Agreement Type Controls Everything.....	674
Understanding CIS Divisions.....	675
Setting Up CIS Divisions.....	678
Setting Up Revenue Classes.....	678
Setting Up Distribution Codes.....	679
Setting Up Billable Charge Templates.....	680
Designing and Defining Bill Segment Types.....	682
Designing and Defining Deposit Classes.....	687
Setting Up Payment Segment Types.....	692
Designing And Defining Adjustment Types.....	693
Designing and Defining Budget Plans.....	705
The Financial Impact Of Budget Plans.....	705
What Do Budget Plans Do?.....	706
Designing Your Budget Plans.....	706
Setting Up Budget Plans.....	707
Tender Management.....	708
Setting Up Tender Types.....	708
Setting Up Tender Sources.....	709

Automatic Payment Options.....	711
Setting Up Auto Pay Route Types.....	712
Setting Up Auto Pay Source Codes.....	712
SEPA Payments.....	713
Web Debit Account Validation.....	715
One-Time Payment Options.....	718
Third Party Payment Processing Options.....	718
Define Service Task Types.....	719
Define Auto Pay Sources and Auto Pay Route Types.....	719
Define Tender Cancel Reason.....	719
Third Party Processing DateTime.....	719
Third Party Payment Processing Master Configuration.....	720
Payment Advices.....	720
What Is A Payment Advice?.....	720
Payment Advice vs. Direct Debit.....	720
Setting Up The System To Enable Payment Advices.....	721
Credit Card Payments.....	721
Configuring the System for Tender Authorization.....	721
Non CIS Payments.....	722
Setting Up Payment Templates.....	723
Alternate Currency Payments.....	723
What Is An Alternate Currency Payment?.....	723
Configuring the System for Alternate Currency Payments.....	724
Payment Event Distribution.....	724
Making Payments Using Distribution Rules.....	725
Setting Up The System To Use Distribution Rules.....	725
Cancel Reasons.....	727
Setting Up Bill (Segment) Cancellation Reasons.....	727
Setting Up Payment Cancellation Reasons.....	727
Setting Up Adjustment Cancellation Reasons.....	728
Miscellaneous Financial Controls.....	728
A/P Check Request.....	728
Billable Charge Line Type.....	729
Payables Cash Accounting.....	729
Accrual versus Cash Accounting Example.....	729
Distribution Code Controls Cash Accounting For A GL Account.....	730
Bill Segments and Cash Accounting.....	731
Payment Segments and Cash Accounting.....	731
Write Down Adjustment.....	741
Write-Offs.....	741
Deferred Accrual Accounting.....	742
Deferred Accrual Accounting Examples.....	742
Payment Cancellations and Deferred Accrual Accounting.....	745
Open Item Accounting.....	745
Open-Item Versus Balance-Forward Accounting.....	746
Accounting Method Defined On Your Customer Classes.....	747
Match Events.....	747
Disputing Items.....	752
Pay Plans.....	753
Over Payments.....	754
Setting Up The System To Enable Open Item Accounting.....	755
Setting Up Match Types.....	757
Setting Up Match Event Cancellation Reasons.....	757
Fund Accounting.....	757
Fund Accounting Overview.....	758
Accounting Method Is Defined On The Installation Options.....	761
Fund Controls Fund-Balancing Entries.....	761
Building Fund-Balancing GL Details.....	762
Setting Up The System To Enable Fund Accounting.....	763
Bill Taxation Threshold.....	764
Taxation Threshold Examples.....	764
Billing and Taxation Thresholds.....	766
Setting Up The System For Bill Taxation Thresholds.....	767
Other Financial Transaction Topics.....	769

The Source Of GL Accounts On Financial Transactions.....	769
Defining Customer Options.....	770
Customer Overview.....	771
A Simple Example Of Two Customers.....	771
Persons.....	771
Accounts.....	772
Service Agreements.....	773
Setting Up Person Options.....	774
Person Identifiers.....	774
Setting Up Contact Routings.....	775
Setting Up Person Contact Status.....	776
Setting Up Person Contact Type Algorithms.....	776
Setting Up Person Contact Types.....	776
Choosing to Use Person Contact or Person Phone.....	776
Person Contact Status Can Be Controlled By A Process.....	777
Maintaining Person Contact via Person Phone.....	778
Setting Up Statement Construct Options.....	779
Setting Up Statement Route Types.....	780
Setting Up Account Options.....	780
Setting Up Account Management Groups.....	780
Setting Up Account Relationship Codes.....	781
Setting Up Alert Types.....	781
Setting Up Bill Messages.....	781
Setting Up Bill Route Types.....	782
Setting Up Bill Cycles.....	782
Setting Up Customer Classes.....	782
Setting Up Collection Classes.....	789
Setting Up Customer Information Options.....	789
Setting Up Customer Contact Options.....	789
Setting Up Customer Contact Classes.....	789
Setting Up Customer Contact Types.....	790
Setting Up Notification Preference Options.....	791
Notification Preferences Overview.....	791
Setting Up Notification Event Types.....	791
Template-Based vs. Message-Based Notification Types.....	791
Push vs. Subscription Notification Types.....	792
Parent vs. Individual Push Notification Types.....	792
Delivery Type.....	792
Enabling Opt-In for a Delivery Type.....	793
Some Notification Types Use Service Task.....	793
Designing Notification Types.....	794
Setting Up Notification Type Algorithms.....	795
Setting Up Delivery Types.....	796
Setting Up Notification Types.....	796
Setting Up the Outbound Message Type.....	796
Setting Up the Message Sender.....	796
Setting Up the External System and Configure the Messages.....	797
Setting Up Notification Preferences Master Configuration.....	797
Other Edge Application Notification.....	797
Setting Up Service Agreement Options.....	797
Setting Up Standard Industry Codes (SIC).....	797
Setting Up Tax Exempt Types.....	797
Setting Up Contract Quantity Types.....	798
SA Type Controls Everything.....	798
Financial Controls.....	798
Setting Up Order Options.....	798
Setting Up Column References.....	798
Setting Up Order Cancellation Reasons.....	799
Setting Up Order Hold Reasons.....	799
Setting Up Order Feature Configurations.....	799
Setting Up Program Management Options.....	800
Designing Initiative Eligibility Criteria.....	800
Designing Related Object Criteria.....	801
Setting Up Lead Event Types.....	803

Overriding Initiative Sign Up Options.....	803
Program Management Master Configuration.....	804
Setting Up Letter Templates.....	804
Setting Up Customer Service Request Types.....	804
Setting Up Consumer Contract Request Types.....	805
Setting Up Start, Stop and Transfer Request Types.....	805
Questions and Response Processing.....	809
Defining Customer 360 Options.....	814
Setting Up The System To Enable Customer 360.....	814
Defining Service Order Options.....	815
Service Orders.....	815
SOM Options Overview.....	815
Understanding Service Order Management.....	815
Supported Service Order Processes.....	816
Defining Disconnect Locations.....	819
Defining Field Activity Profiles and Types.....	819
How Does A Field Activity Type Profile Get Used?.....	820
Designing Field Activity Type Profiles.....	820
Designing Field Activity Types.....	821
Setting Up Field Activity Types.....	821
Field Activity Type - Main.....	821
Field Activity Type - FA Characteristics.....	822
Field Activity Type - FA Completion Control.....	822
Field Activity Type - SP Type Review.....	822
Setting Up Field Activity Type Profiles.....	823
Field Activity Type Profile - Main.....	823
Field Activity Type Profile - Template.....	823
Field Activity Requests Initiated To Start Service.....	824
Field Activity Requests Initiated To Stop Service.....	824
Field Activity Requests Initiated For Back-to-Back Service.....	824
Field Activity Requests Initiated To Cut Service Due To Non-Payment.....	825
Field Activity Requests Initiated To Place A Disconnect Warning At A Service Point.....	825
Field Activity Requests Initiated To Reconnect Service At A Service Point.....	825
Field Activity Requests Initiated To Reread A Meter At A Service Point.....	825
Defining A Profile's Valid Field Activity Types.....	825
Setting Up Fieldwork Cancellation Reasons.....	826
Setting Up Field Activity Remarks.....	826
Setting Up Outage Call Types.....	827
Outage Call Type List.....	827
Outage Call Type.....	827
Setting Up Service Call Communication Types.....	827
Setting Up Service Categories.....	828
Setting Up Service Codes.....	828
Service Order Management External Applications.....	828
Service Order Activities.....	829
Understanding Service Order Activities.....	829
Service Order Activity Processing.....	830
Service Order Activity Algorithm Types.....	833
Understanding Service Order Field Activity Types.....	839
Configuring Service Order Activity Types.....	839
Service Order Field Activities.....	840
Understanding Service Order Field Activities.....	840
How Do Service Order Field Activities Work?.....	841
Service Order Field Activity Processing.....	842
Service Order Field Activity Communication.....	846
Unrelated Pickup Orders.....	850
Setting Up Service Order Field Activity Types.....	850
Understanding Service Order Field Activity Types.....	850
Configuring Service Order Field Activity Types.....	851
Configuring Service Order Field Activity Reschedule Reasons.....	852
Field Task Types.....	852
Understanding Field Task Types.....	852
Configuring Field Task Types.....	853
Defining Credit & Collections Options.....	854

The Big Picture Of Credit & Collections.....	854
Collection Criteria vs. Severance Criteria vs. Write Off Criteria.....	854
The C&C Monitors.....	857
The Big Picture Of Collection Processes.....	859
The Big Picture Of Collection Events.....	866
The Big Picture Of Severance Process Cancellation.....	869
The Big Picture Of Severance Events.....	871
The Big Picture Of Write Off Processing.....	875
The Big Picture Of Write-off Events.....	882
Calendar vs. Work Days.....	885
The Big Picture Of Payment Arrangements and Pay Plans.....	886
Creating Collection, Severance & Write-Off Procedures.....	900
Designing Your Collection Procedures.....	900
Setting Up Collection Procedures.....	906
Designing Your Severance Procedures.....	911
Designing Your Reconnection Procedures.....	914
Setting Up Severance Procedures.....	915
Designing Your Write-Off Procedures.....	918
Setting Up Write-Off Procedures.....	921
Setting Up Feature Configuration.....	926
How To.....	926
How To Nominate A Single Service To Sever (Rather Than Sever Everything That's In Arrears).....	926
Defining Asset Options.....	928
Asset Activity Types.....	928
Understanding Asset Activity Types.....	928
Defining Asset Activity Types.....	928
Asset Completion Event Types.....	928
Understanding Asset Completion Event Types.....	929
Defining Asset Completion Event Types.....	929
Asset Inbound Communication Types.....	929
Understanding Asset Inbound Communication Types.....	930
Defining Asset Inbound Communication Types.....	930
Asset Types.....	930
Understanding Asset Types.....	930
Defining Asset Types.....	931
Service History Questions.....	931
Understanding Service History Questions.....	931
Defining Service History Questions.....	932
Service History Types.....	932
Understanding Service History Types.....	932
Defining Service History Types.....	933
Configuration Types.....	933
Understanding Configuration Types.....	933
Defining Configuration Types.....	934
Configurations.....	934
Understanding Configurations.....	934
Defining Configurations.....	935
Configuration Reports.....	935
Understanding Configuration Reports.....	935
Defining Configuration Reports.....	936
Defining Location Options.....	936
Asset Location Types.....	936
Understanding Asset Location Types.....	936
Defining Asset Location Types.....	937
Organization Types.....	937
Understanding Organization Types.....	937
Defining Organization Types.....	937
Organizations.....	937
Understanding Organizations.....	937
Defining Organizations.....	938
Out of Service Location Types.....	938
Understanding Out of Service Location Types.....	938
Defining Out of Service Location Types.....	938
Out of Service Locations.....	939

Understanding Out of Service Locations.....	939
Defining Out of Service Locations.....	939
Defining Device Options.....	939
Command Sets.....	939
Understanding Command Sets.....	940
Configuring Command Sets.....	940
Head End Systems.....	940
Understanding Head End Systems.....	940
Understanding Processing Methods.....	941
Understanding SGG Adapter Configuration.....	942
Configuring Head End Systems.....	943
Measuring Component Types.....	944
Understanding Measuring Component Types.....	944
Configuring Measuring Component Types.....	948
Measuring Component Comparison Types.....	948
Understanding Measuring Component Comparison Types.....	948
Configuring Measuring Component Comparison Types.....	949
Device Configuration Types.....	949
Understanding Device Configuration Types.....	949
Configuring Device Configuration Types.....	950
Device Types.....	950
Understanding Device Types.....	950
Configuring Device Types.....	952
Defining Device Installation Options.....	952
Service Point Types.....	952
Understanding Service Point Types.....	952
Configuring Service Point Types.....	953
Service Point Quantity Types.....	953
Understanding Service Point Quantity Types.....	953
Configuring Service Point Quantity Types.....	953
Divisions.....	954
Understanding Divisions.....	954
Measurement Cycles.....	954
Understanding Measurement Cycles.....	954
Configuring Measurement Cycles.....	954
Measurement Cycle and Bill Determinants.....	955
Measurement Cycle Schedules.....	955
Understanding Measurement Cycle Schedules.....	955
Configuring Measurement Cycle Schedules.....	956
Setting Up Metered Premise Options.....	956
Setting Up Meter Read Instructions.....	956
Setting Up Meter Read Warnings.....	956
Configuring Cross Installed Meter Processing.....	956
Setting Up Consumption Estimation Parameters.....	958
Defining General Options.....	959
Units of Measure.....	959
Understanding Units of Measure.....	959
Configuring Units of Measure.....	959
Service Quantity Identifiers.....	959
Understanding Service Quantity Identifiers.....	960
Configuring Service Quantity Identifiers.....	960
Time of Use.....	960
Understanding Time of Use.....	960
Configuring Time of Use.....	960
Service Types.....	960
Understanding Service Types.....	961
Configuring Service Types.....	961
Factors.....	961
Understanding Factors.....	961
Configuring Factors.....	961
Processing Timetable Types.....	962
Understanding Processing Timetable Types.....	962
Configuring Processing Timetable Types.....	962
Initial Measurement Data.....	963

Configuring the Initial Measurement Algorithms.....	963
Configuring Measurement Logging.....	964
Removing Unwanted Initial Measurements.....	964
Defining Validation, Editing, and Estimation (VEE) Options.....	967
Exception Types.....	967
Understanding Exception Types.....	967
Configuring Exception Types.....	968
VEE Groups.....	968
Understanding VEE Groups.....	968
Configuring VEE Groups.....	968
VEE Rules.....	969
Understanding VEE Rules.....	969
Configuring VEE Rules.....	969
Measuring Component Statistics.....	997
Understanding Measuring Component Statistics.....	997
Configuring Measuring Component Statistics.....	998
Defining Usage Options.....	999
The Big Picture of Usage Requests.....	999
Requesting Bill Determinants.....	999
Usage Request Lifecycle.....	1000
Summary Billed Accounts and Usage Requests.....	1000
Corrected Read Notifications.....	1001
Configuring The System For Usage Request Integration.....	1001
Start and End Times for Billing.....	1001
The Big Picture of Time of Use Mapping and Pricing.....	1002
Mapping to Time of Use (TOU) Periods.....	1002
Grouping of TOU Codes for TOU Mapping.....	1003
Time of Use (TOU) Mapping and Pricing.....	1004
Designing Your Time of Use (TOU) Mapping and Pricing Options.....	1005
Setting Up Time of Use (TOU) Mapping and Pricing Control Tables.....	1007
Usage Subscription Types.....	1009
Understanding Usage Subscription Types.....	1009
Configuring Usage Subscription Types.....	1009
Integrating Usage Transactions.....	1009
Requesting Usage Transactions from External Systems.....	1009
Processing and Sending Usage Transactions to External Systems.....	1010
Generating Usage Transactions in Oracle Utilities Meter Data Management.....	1011
Usage Transaction Exception Types.....	1011
Understanding Usage Transaction Exception Types.....	1011
Configuring Usage Transaction Exception Types.....	1011
Usage Calculation Groups.....	1012
Understanding Usage Calculation Groups.....	1012
Configuring Usage Calculation Groups.....	1012
Usage Calculation Rules.....	1012
Understanding Usage Calculation Rules.....	1012
Configuring Usage Calculation Rules.....	1014
Detailed Configuration Examples.....	1033
Usage Calculation Types.....	1034
Understanding Usage Calculation Types.....	1034
Configuring Usage Calculation Types.....	1034
Usage Subscription Quantity Types.....	1035
Understanding Usage Subscription Quantity Types.....	1035
Configuring Usage Subscription Quantity Types.....	1035
Dynamic Option Types.....	1035
Understanding Dynamic Option Types.....	1035
Configuring Dynamic Option Types.....	1036
Bill Cycle.....	1036
Understanding Bill Cycle.....	1036
Configuring Bill Cycle.....	1036
Defining Time of Use Mapping Options.....	1036
Time of Use Groups.....	1036
Understanding Time of Use Groups.....	1037
Configuring Time of Use Groups.....	1037
Time of Use Map Templates.....	1037

Understanding Time of Use Map Templates.....	1037
Configuring Time of Use Map Templates.....	1038
Time of Use Map Types.....	1038
Understanding Time of Use Map Types.....	1038
Configuring Time of Use Map Types.....	1039
Defining Premise and Service Point Options.....	1040
An Illustration Of A Premise.....	1040
Setting Up Premise Options.....	1041
Defining Premise Types.....	1041
Implementing Address Validation	1042
Setting Up Generic Service Point Options.....	1042
Setting Up Service Point Types.....	1042
Setting Up Premise & Service Point Postal Defaults.....	1043
Postal Defaults - Main.....	1043
Postal Defaults - Service Default.....	1044
Designing SP Types.....	1044
Service Segmentation.....	1044
Device Segmentation.....	1045
SA Type Segmentation.....	1045
Defining Bill and Measurement Cycles.....	1045
Defining Bill and Measurement Cycles.....	1046
The Big Picture of Bill Cycles, Measurement Cycles, and Bill Periods.....	1046
Bill Cycles.....	1050
Designing Bill Periods.....	1053
Setting Up Bill Cycles.....	1054
Setting Up Service Cycles And Measurement Cycle Schedules.....	1055
Setting Up Measurement Cycle Schedules.....	1055
Setting Up Bill Periods.....	1056
Defining Statement Cycles.....	1056
The Big Picture Of Statement Cycles.....	1056
Setting Up Statement Cycles.....	1057
Defining Service Agreement Type (SA Types).....	1058
Designing SA Types For Service Agreements With Service Points.....	1058
CIS Division Segmentation.....	1058
Service Segmentation.....	1058
Receivable Segmentation.....	1059
Revenue Segmentation.....	1059
Rate Segmentation.....	1060
Service Point (SP) Type Segmentation.....	1061
Company Usage Segmentation.....	1062
Debt Class Segmentation.....	1063
Budget Billing Segmentation.....	1064
Designing SA Types For SAs Without Service Points.....	1065
Overpayment Segmentation.....	1065
Write Off Segmentation.....	1066
Connection Charge Segmentation.....	1067
Charitable Contribution Segmentation.....	1068
Payment Arrangement Segmentation.....	1069
Merchandise Segmentation - Installment Billing.....	1070
Deposit Segmentation - Installment Billing.....	1070
Billable Charge Segmentation.....	1071
Over/Under Cash Drawer Segmentation.....	1073
Payment Upload Error Segmentation.....	1073
CIAC Segmentation.....	1074
Loan Segmentation.....	1075
Non-Billed Budget Segmentation.....	1075
Designing SA Type For Other Segmentations.....	1075
Cash Distribution Segmentation.....	1076
Adjustment Profile Segmentation.....	1076
Late Payment Charge Segmentation.....	1076
Debt Classification Segmentation.....	1076
Allow Estimates Segmentation.....	1076
Severance Criteria Segmentation.....	1077
Deposit Class Segmentation.....	1077

Sub SA Types.....	1077
Financial Settlement SA Types.....	1078
Usage Request SA Types.....	1078
Initial Consumption Period Considerations.....	1078
Processing Sequence Considerations.....	1080
Designing Prepayment Billing Options.....	1080
SA Types And The Financial Design.....	1082
Setting Up SA Types.....	1083
SA Type - Main Information.....	1083
SA Type - Detail.....	1085
SA Type - Billing.....	1088
SA Type - Rate.....	1092
SA Type - SP Type.....	1093
SA Type - Adjustment Profiles.....	1094
SA Type - C&C.....	1094
SA Type - Billable Charge Template.....	1095
SA Type - Characteristics.....	1096
SA Type - Algorithms.....	1096
SA Type - Billable Charge Overrides.....	1103
SA Type - Contract Option Type.....	1104
SA Type - NBB Recommendation Rule.....	1104
Setting Up Start Options.....	1104
Start Option Merge.....	1111
Defining SA Relationship Options.....	1113
The Big Picture of SA Relationships and Service Providers.....	1114
Persons and Service Providers.....	1114
Service Providers Are Linked To Service Agreements.....	1115
Service Providers May Change Over Time.....	1116
How To Set Up SA Relationships On A Customer's Service Agreement.....	1117
When Your Company Is A Service Provider.....	1117
Service Providers Have To Communicate About Customers.....	1119
Relationships Between Service Providers.....	1119
A Service Agreement Can Have Many Types Of Relationships.....	1120
Billing Relationships.....	1122
Consumption Relationships.....	1138
Deposits Issues.....	1141
Credit and Collection Issues.....	1142
An Object-Oriented Perspective Of Service Providers.....	1144
How Do You Communicate With Service Providers?.....	1144
Off Cycle Switch.....	1145
Designing Your SA Relationship Types and Service Providers.....	1146
Designing SA Relationship Types.....	1146
Designing Service Providers.....	1147
Designing Your SA Types And Start Options For Sub SAs.....	1153
Reference Send Consumption Algorithm On Master SA Types.....	1155
Reference TBFU Algorithm On Master SA Types.....	1155
Designing SA Types For Service Provider Financial Settlements.....	1155
Setting Up SA Relationship Information.....	1156
Setting Up SA Relationship Types.....	1156
Setting Up Service Providers.....	1156
Setting Up SA Types and Start Options For Sub SAs.....	1157
Setting Up SA Types For Financial Settlements.....	1157
Update Master SA Types With FT Freeze and Bill Completion Algorithms.....	1157
Setting Up SA Relationships For SA Types.....	1157
Setting Up Market SA Relationship Options.....	1157
Negotiated Terms.....	1158
Examples Of Special Discounts.....	1158
Setting Up The System To Enable Negotiated Terms.....	1160
Defining Service Credit Options.....	1161
The Big Picture Of Service Credits.....	1162
Service Credit Membership.....	1162
Designing Your Service Credit Options.....	1165
Designing Your Membership Types.....	1165
Designing Your Service Credit Event Types.....	1167

How Are Service Credit Events Created?.....	1170
Setting Up Service Credit Options.....	1171
Setting Up Credit Units.....	1171
Setting Up SC Membership Inactive Reasons.....	1172
Setting Up Service Credit Membership Types.....	1172
Setting Up Service Credit Event Types.....	1174
Service Credit Examples.....	1174
Defining Control Tables for a Refundable Fee.....	1175
Defining Control Tables for a Nonrefundable Fee.....	1176
Defining an SA Type for Miscellaneous Transactions.....	1176
Using Campaigns/Packages to Set Up Membership.....	1177
Defining Another Person for Your Account.....	1179
Service Credits Earned When Starting Service.....	1182
Service Credits Earned Through Billing.....	1182
Service Credits Redeemed Through Billing.....	1183
Designing Your Rate Options for Capital Credits.....	1183
Partial Retirement.....	1186
Interface Membership Information to a Third Party.....	1186
Defining Loan Options.....	1187
The Terms Of A Loan Are Stored On A Service Agreement.....	1187
Payoff Balance and Current Balance for Loans.....	1188
Booking The Principal Amount Using An Adjustment.....	1188
Loan Amortization Schedule Calculation.....	1189
Billing For Loans And Interest Calculation.....	1189
Paying What Is Owed.....	1191
Overpayments On Loans.....	1192
Adjusting Loan Amounts.....	1194
Writing Off Loans.....	1195
Distribution Codes for Loans.....	1196
Setting Up The System To Enable Loans.....	1197
Distribution Code.....	1197
Adjustment Types.....	1197
Adjustment Type Profile.....	1197
Algorithms.....	1198
Bill Factor.....	1198
Customer Class.....	1198
Bill Segment Type.....	1198
Frequency.....	1198
Bill Period.....	1199
Bill Cycle Schedule.....	1199
Collection, Severance and Write Off Processes.....	1199
SA Type.....	1199
Start Options.....	1201
Defining Non-Billed Budget Options.....	1201
What Is A Non-Billed Budget?.....	1201
The Financial Impact Of Non-Billed Budgets.....	1202
Current Amount For SAs Covered By A Non-Billed Budget.....	1202
Scheduled And Actual Payments On The Non-Billed Budget.....	1203
Overpayments for Non-Billed Budgets.....	1203
Underpayments For Non-Billed Budgets.....	1205
Billing For SAs Covered By The Non-Billed Budget.....	1205
Distributing Non-Billed Budget Credit.....	1207
Stopping an SA Covered By a Non-Billed Budget.....	1208
Financial Transactions For Unmonitored Non-Billed Budgets.....	1209
Distributing Payments for Unmonitored Non-Billed Budgets.....	1209
Transferring Credit from Unmonitored Non-Billed Budgets.....	1210
Designing Non-Billed Budgets.....	1210
Making SAs Eligible For Non-Billed Budgets.....	1210
Designing Recommendation Rules.....	1211
Non-Billed Budget Recommendation Rule.....	1217
Setting Up The System To Enable Non-Billed Budgets.....	1218
NBB Distribution Codes.....	1218
NBB Adjustment Types.....	1218
NBB Adjustment Type Profiles.....	1219

NBB Characteristic Types.....	1219
NBB Customer Contact Class And Types.....	1219
NBB Algorithms.....	1220
NBB Debt Class And Collection Process.....	1221
SA Types for SAs Covered by NBBs.....	1221
NBB Recommendation Rules.....	1221
Non-Billed Budget SA Types.....	1221
NBB Background Processes.....	1223
Defining Quotation Options.....	1223
Setting Up SA Types For Quotes.....	1223
Enabling The Automatic Generation Of Billing Scenarios.....	1224
Enabling The Generation Of Simulated Bill Segments.....	1224
Enabling The Creation Of A Real SA When A Quote Detail Is Accepted.....	1224
Setting Up Quote Route Types.....	1224
Setting Up Terms and Conditions.....	1225
Setting Up Decline Reasons.....	1225
Setting Up Customer Classes For Quotes.....	1225
Defining Case Management Options.....	1226
The Big Picture Of Cases.....	1226
Case Type Controls Everything.....	1226
Scripts and Cases.....	1233
To Do's and Cases.....	1234
Examples of Case Types.....	1236
Setting Up Case Management Options.....	1245
Installation Options.....	1245
Setting Up Application Services.....	1246
Setting Up Scripts.....	1246
Setting Up To Do Types.....	1246
Setting Up Characteristic Types.....	1247
Setting Up Case Types.....	1247
Defining Umbrella Agreement Options.....	1251
The Big Picture Of Umbrella Agreements.....	1252
Renewable Umbrella Agreements.....	1252
Terms Of Service Covered Entities.....	1252
Overriding Rate Terms.....	1253
Setting Up Umbrella Agreement Options.....	1255
Configure SA Types for Umbrella Agreements.....	1255
Configure Bill Factors for Umbrella Agreements.....	1255
Configure A Campaign To Link An SA To A Terms Of Service.....	1255
Setting Up Umbrella Agreement Types.....	1256
Setting Up Terms Of Service Types.....	1257
Setting Up Terms of Service Cancel Reasons.....	1258
Umbrella Agreements Configuration Examples.....	1258
Linking A Service Agreement To A TOS Through Orders.....	1258
Reports Addendum.....	1259
Configuring the System to Invoke Oracle BI Publisher Enterprise Real-Time.....	1259
Specify Reporting Tool Options.....	1259
Reporting Tool Algorithm.....	1259
Interface with Oracle BI Publisher Enterprise Batch Scheduler.....	1260
Configuring the System for Batch Bill Print.....	1260
Configure Oracle BI Publisher for Batch Bill Print.....	1260
Configure Oracle Utilities Customer Care and Billing for Batch Bill Print.....	1260
Description of Sample Reports.....	1261
Active Severance Processes - CI_ACSVPR.....	1261
Bill Print in BI Publisher - CI_BILLPR.....	1261
Billed Revenues by Rate - CI_BILREV.....	1269
Case Statistics By Case Type - CI_CSESTS.....	1269
Case Statistics for a Given Status - CI_CSESGS.....	1270
Collection Summary - CI_CLLSUM.....	1271
Customer Contacts by Type - CI_CUSTCN.....	1271
Customers with Life-Support / Sensitive-Load - CI_PMLSSL.....	1272
GL Accounting Summary - CI_GLACSM.....	1272
Letter Print - BI Publisher Sample Welcome Letters - CI_LTRGN_ENG REPORT.....	1273
Open Cases By Type - CI_CSEOPN.....	1274

Payments Balance - CI_PMTBAL.....	1275
Receivables Aging - CI_RCVAGA.....	1275
Tax Payables Analysis - CI_TXPYBL.....	1276
To Do Entries - CI_TDENTR.....	1276
Umbrella Agreement Summary - CI_UASUMM.....	1277
Unbilled Revenues - CI_UBLREV.....	1278
Defining Overdue Processing Options.....	1279
Case Study - Collecting On Overdue Bills.....	1280
Monitoring Overdue Bills.....	1280
Cutting Service Agreements.....	1282
How Does The Overdue Monitor Work?.....	1284
Different Overdue Rules For Different Customers.....	1284
Overdue Rules Are Embodied In Algorithms.....	1285
When Is An Account Monitored?.....	1285
Collection Class Defines If And How Accounts Are Monitored.....	1285
The Big Picture Of Overdue Processes.....	1286
How Are Overdue Processes Created?.....	1286
The Components Of An Overdue Process.....	1286
Experimenting With Alternative Overdue Process Templates.....	1287
Overdue Process Information Is Overridable.....	1288
Original and Unpaid Amounts.....	1288
Overdue Processes Are Highlighted Elsewhere.....	1288
How Are Overdue Processes Cancelled?.....	1289
Overdue Processes Are Created From Templates.....	1289
The Big Picture Of Overdue Events.....	1290
The Big Picture Of Cut Processes.....	1293
Cut Events Are Like Overdue Events.....	1295
Write Offs Are Implemented Using Overdue Events.....	1296
Calendar vs. Work Days.....	1296
Bill-Oriented Collection - Advanced Topics.....	1296
Miscellaneous Bill-Oriented Collection Topics.....	1296
Writing Off Bills.....	1298
Bill-Oriented Payment Arrangements.....	1301
Creating Overdue and Cut Procedures.....	1304
Designing Your Overdue Procedures.....	1304
Set Up Tasks.....	1310
Setting Up Overdue Processing.....	1314
Defining Prepaid Metering Options.....	1319
The Big Picture of Prepaid Metering.....	1320
How Does Prepaid Metering Work?.....	1320
Debit Meter vs. Credit Meter.....	1320
Prepaid Metering Transactions Result in Adjustments.....	1320
Interfacing Prepaid Transactions.....	1320
Prepaid Transactions Can Go Into Suspense.....	1321
Setting Up The System To Enable Prepaid Metering.....	1321
Meter Types.....	1321
Characteristic Types.....	1321
Algorithms.....	1322
Rate.....	1323
Adjustment Types.....	1324
Adjustment Type Profiles.....	1324
Service Agreement Types.....	1324
Bill Cycle.....	1324
Vendor Information.....	1325
Defining Conservation Program Options.....	1325
The Big Picture of Conservation Programs.....	1325
Conservation Program Maintenance Object.....	1325
Conservation Program Rebate Definition Maintenance Object.....	1326
Rebate Claim Maintenance Object.....	1326
Rebate Claim Line Maintenance Object.....	1326
GL Accounting Example.....	1327
Setting Up Conservation Programs.....	1327
Conservation Program List Zone.....	1327
Conservation Program Zone.....	1328

Rebate Definition Zone.....	1330
Rebate Claim Statistics Zone.....	1332
Defining Open Market Options.....	1332
Markets.....	1332
Understanding Market.....	1332
Configuring Market.....	1333
Market Participants.....	1333
Understanding Market Participants.....	1333
Configuring Market Participants.....	1333
Defining Consumer Contract Options.....	1334
Understanding Consumer Contracts.....	1334
Understanding Consumer Contract Milestones.....	1334
Understanding Consumer Products.....	1335
Understanding Consumer Product Eligibility Criteria.....	1335
Understanding Consumer Product Versions.....	1336
Understanding Consumer Product Rules.....	1336
Understanding Consumer Product Components.....	1337
Understanding Consumer Product Component Eligibility Criteria.....	1337
Understanding Consumer Contract Rules.....	1337
Configuring Consumer Contract Type.....	1338
Configuring Consumer Contract Milestone Type.....	1338
Configuring Consumer Product.....	1339
Configuring Consumer Product Version.....	1339
Configuring Consumer Product Rule.....	1339
Configuring Consumer Product Component.....	1339
Configuring Consumer Contract Rule.....	1340
Configuration.....	1340
Configuring Zones.....	1340
Configuring Timeline Zones.....	1340
Content Migration Assistant (CMA) Addendum.....	1341
Base Package Migration Plans.....	1341
Base Package Migration Request.....	1342
Wholesale and Piecemeal Migrations.....	1342
Processing Notes for Specific Objects.....	1343
To Do Lists Addendum.....	1343
Assigning A To Do Role.....	1343
Background Processes Addendum.....	1344
How To Set Up A New Extract Processes.....	1344
Choosing Which Records Are Selected.....	1345
The Big Picture of Sample & Submit.....	1346
Security Addendum.....	1349
Implementing Account Security.....	1349
Masking Sensitive Data.....	1357
Encrypting Sensitive Data.....	1357
Data Privacy Addendum.....	1359
Defining Converted COBOL Program Options.....	1364
Converted COBOL Program - Main.....	1364
Advanced Search Options.....	1364
Integration.....	1365
CTI-IVR Integration.....	1365
CTI-IVR Integration Configuration.....	1365
Launching The System From an External Application.....	1365
Receiving the Next Caller in the Queue.....	1365
Initiating an External Call.....	1366
Analytics Integration Overview.....	1367
Analytics Configuration.....	1367
Self-Service Integration.....	1369
About Self-Service Tasks.....	1369
Setting Up Self-Service Task Configuration.....	1370
Maintaining Self-Service Tasks.....	1370
Configuring Rate Compare Usage Adjustment Profiles.....	1370
Defining DataConnect Options.....	1375
DataConnect Data Extracts.....	1375
Customer and Premise Data Extracts.....	1376

Billing Data Extracts.....	1381
Consumption Data Extracts.....	1384
Extract Flat File Formats.....	1387
Business Flags.....	1399
Understanding Business Flags.....	1399
Business Flag Available Actions.....	1400
Business Flag Can Prevent Bills from Freezing.....	1401
Field Activities Can Determine Business Flag Confidence.....	1401
Configuring Business Flags.....	1401
Business Flags Can Require Analysis.....	1401
Configuring Business Flag Integration.....	1402
A Field Activity Can Determine Business Flag Confidence.....	1403
Business Flags Can Create Alerts.....	1403
Customer Relationship Management Integration.....	1403
About Customer Relationship Requests.....	1403
Setting Up Customer Relationship Request Configuration.....	1404
Maintaining Customer Relationship Requests.....	1404
RightNow Knowledge Integration.....	1405
Displaying Frequently Asked Questions.....	1405
RightNow Knowledge Integration Configuration.....	1405
External Applications.....	1405
Understanding External Applications.....	1405
Configuring External Applications.....	1406
Initiating Smart Meter Commands from an External Application.....	1406
Configuring Master Data Synchronization.....	1410
Oracle Utilities Operational Device Management.....	1410
Overview.....	1410
Configuring Master Data Synchronization.....	1410
Oracle Utilities Analytics Insights.....	1412
Business Flag Integration.....	1412
Meter Insights and Investigations.....	1412
Usage and Event Integration.....	1416
Oracle Utilities Analytics Visualization.....	1418
Timeliness and Quality Aggregations Overview.....	1418
Consumption Analytics Aggregations Overview.....	1423
Oracle Utilities Network Management System.....	1430
Outage Care Integration.....	1430
The Big Picture of Outage Care Integration.....	1431
Customer Information Integration.....	1431
Interfacing Outage Calls.....	1431
Outage Inquiry.....	1432
Setting Up The System To Enable Outage Integration.....	1432
Asset Management System Integration.....	1436
Interfacing Service Calls.....	1436
Setting Up The System To Enable Asset Management System Integration.....	1437
Message Formats.....	1438
Data Import - Message Driven Bean Configuration.....	1438
Overview.....	1438
JMS Configuration.....	1438
Message Driven Bean Configuration.....	1439
Notification Queue Configuration.....	1440
Creating Application Links in External Applications.....	1441
Defining Communications Options.....	1442
Device Event Types.....	1442
Understanding Device Event Types.....	1442
Configuring Device Event Types.....	1444
Activity Types.....	1444
Understanding Activity Types.....	1445
Configuring Activity Types.....	1447
Configuring Service Order Management Activity Types.....	1448
Communication Types.....	1448
Understanding Communication Types.....	1449
Configuring Communication Types.....	1449
Service Task Types.....	1449

Understanding Service Task Types.....	1449
Configuring Service Task Types.....	1450
Data Extracts.....	1450
Configurable Consumption Extracts.....	1450
Maintenance Object Data Export.....	1455
Enabling Maintenance Objects for Generalized Data Export.....	1455
Measurement Data Export.....	1456
Initial Measurement Data Header Export.....	1461
Consumption Extract Type.....	1465
Understanding Consumption Extract Type.....	1466
Configuring Consumption Extract Type.....	1466
Analytics Configuration.....	1466
Aggregation.....	1467
Standard Aggregation.....	1467
Configuring an Out-of-the-box Aggregation.....	1467
Understanding an Example Out-of-the-box Aggregation.....	1467
Creating a New Custom Aggregation.....	1468
Dynamic Aggregation.....	1469
Dynamic Aggregation Configuration Overview.....	1469
Aggregation Master Configuration.....	1469
Data Sources.....	1469
Dynamic Aggregation Measuring Component Types.....	1471
Aggregation Groups.....	1472
Measuring Component Sets.....	1473
Configuration Step-by-Step.....	1475
Extending Dynamic Aggregation.....	1476
Consumption Synchronization.....	1477
Configuring Consumption Synchronization.....	1477
Defining Dashboard Options.....	1481
Configuring the Customer Operational Dashboard.....	1481
Configuring the Meter Operational Dashboard.....	1482
Configuring the Meter Health Check Dashboard.....	1487
Configuring the Service Order Management Dashboards.....	1488
Configuring the Product Use Metrics Dashboard.....	1494
Measurement Reprocessing.....	1496
Configuring Measurement Reprocessing.....	1496
Information Lifecycle Management (ILM).....	1497
Understanding Information Lifecycle Management (ILM).....	1497
Configuring Information Lifecycle Management (ILM).....	1503
Outage Storm Mode.....	1505
Configuring Outage Storm Mode.....	1505
Detailed Examples of Outage Storm Mode.....	1506
Running Initial Periodic Estimation.....	1508
Overview.....	1508
Avoiding Long Execution Time.....	1509
Overview of Options and Start of Estimation Horizon.....	1509
Testing Periodic Estimation on Small Data Sets.....	1511
Testing Periodic Estimation on Large Data Sets.....	1513
Defining Oracle Utilities Rate Cloud Service Options.....	1513
Oracle Utilities Rate Cloud Service Admin Data.....	1514
Creating Oracle Utilities Rate Cloud Service Users.....	1514
Initiating Calculations from an External System.....	1514
Defining Oracle Utilities Billing Cloud Service Options.....	1515
Oracle Utilities Billing Cloud Service Admin Data.....	1515
Creating Oracle Utilities Billing Cloud Service Users.....	1516
Smart Grid Gateway Adapters.....	1516
Smart Grid Gateway Adapter Middleware Implementations.....	1517
Configuring Smart Grid Gateway Adapters.....	1517
Using Smart Grid Gateway Middleware Test Harnesses.....	1635
Creating a Custom Adapter for Smart Grid Gateway.....	1646
Smart Grid Gateway Adapter Native Implementations.....	1721
Payload Processing.....	1721
Smart Meter Commands.....	1756
Master Configurations.....	1812

Native Implementation Configuration Checklists.....	1814
Defining Settlement Options.....	1816
Settlement Configuration Overview.....	1816
Settlement Subscription Types.....	1816
Understanding Settlement Subscription Types.....	1816
Configuring Settlement Subscription Types.....	1817
Settlement Transaction Exception Types.....	1817
Understanding Settlement Transaction Exception Types.....	1817
Configuring Settlement Transaction Exception Types.....	1817
Settlement Units.....	1818
Understanding Settlement Units.....	1818
Configuring Settlement Units.....	1818
Settlement Data Snapshot Types.....	1819
Attribute Groups.....	1819
Attribute Data Snapshot Types.....	1820
Measurement Data Snapshot Types.....	1820
Settlement Calculations.....	1821
Settlement Calculation Groups.....	1821
Settlement Calculation Rules.....	1822
Settlement Item Types.....	1826
Understanding Settlement Item Types.....	1826
Configuring Settlement Item Types.....	1826
Settlement Item Quantity Types.....	1827
Understanding Settlement Item Quantity Types.....	1827
Configuring Settlement Item Quantity Types.....	1827
Market Contract Types.....	1827
Understanding Market Contract Types.....	1827
Configuring Market Contract Types.....	1827
Market Products.....	1828
Market Product Sets.....	1828
Market Product Types.....	1828
Settlement Module Configuration.....	1829

Chapter 1

Administrative User Guides

Framework Administrative User Guide

The topics in this section describe how to administer the Oracle Utilities Application Framework.

General Options

This section describes control tables that are used throughout your product.

Defining Installation Options

The topics in this section describe the various installation options that control various aspects of the system.

Installation Options - Main

Select **Admin > General > Installation Options - Framework** to define system wide installation options.

Description of Page

The **Environment ID** is a unique universal identifier of this instance of the system. When the system is installed, the environment id is populated with a six digit random number. While it is highly unlikely that multiple installs of the system at a given implementation would have the same environment ID, it is the obligation of the implementers to ensure that the environment ID is unique across all installed product environments.

System Owner will be **Customer Modification**.

The **Admin Menu Order** controls how the various control tables are grouped on Admin.

- If you choose **Functional**, each control table appears under a menu item that corresponds with its functional area. Note, the [menu](#) that is used when this option is chosen is the one identified with a menu type of **Admin**.

- If you choose **Alphabetical**, each control table appears under a menu item that corresponds with its first letter, using a Roman alphabet. For example, the Language control table will appear under the L menu item entry.

NOTE: The **Alphabetical** option only supports the Roman alphabet. For languages that do not use the Roman alphabet, the recommendation is to configure the system for the **Functional** setting.

CAUTION: In order to improve response times, installation options are cached the first time they are used after a web server is started. If you change the Admin Menu Order and you don't want to wait for the cache to rebuild, you must clear the cached information so it will be immediately rebuilt using current information. Refer to [Caching Overview](#) for information on how to clear the system login cache (this is the cache in which installation options are stored).

The **Language** should be set to the primary language used by the installation. Note that if multiple languages are supported, each user may define their preferred language.

The **Currency Code** is the default currency code for transactions in the product.

If your product supports effective dated characteristics on any of its objects, define the date to be used as the **Characteristic Default Date** on objects without an implicit start date. The date you enter in this field will default when new characteristics are added to these objects (and the default date can be overridden by the user).

Active Owner displays the owner of newly added system data (system data is data like algorithm types, zones, To Do types, etc.). This will be **Customer Modification** unless you are working within a development region.

Country and **Time Zone** represent the default country and time zone that should be used throughout the application.

CAUTION: In most implementations, the time zone defined here matches the database time zone. However, if there is some reason that the database time zone does not match the installation time zone, an implementation may configure a setting in the properties file to automatically convert data from the database time zone to the time zone defined here when displaying dates. Note that when this property setting is defined, changes to the installation time zone will require the server and the thread pool workers to be restarted in order for the changes to take effect.

Turn on **Seasonal Time Shift** if your company requires seasonal time shift information to be defined. Note that this is currently only applicable to Oracle Customer Care and Billing > Interval Billing functionality.

Installation Options - Messages

Select **Admin > General > Installation Options - Framework** and the **Messages** tab to review or enter messages that will appear throughout the application when a given event occurs.

The **Message** collection contains messages that are used in various parts of the system. For each message, define the **Installation Message Type** and **Installation Message Text**. The following table describes the **Message Types** provided by the framework product and how they are used in the system. Your specific product may have introduced addition message types.

Message Type	How The Message Is Used
Company Title for Reports	This message appears as a title line on the sample reports provided with the system. Generally it is your company name. It is only used if you have installed reporting functionality and are using the sample reports (or have designed your reports to use this message).
Domain Name	The text entered for this message type is meant to identify the environment and can be used for logic where it is useful to indicate the environment for a user. For example, the email sent when a background process finishes includes this information, if populated.

Installation Options - Algorithms

Select **Admin > General > Installation Options - Framework** and the **Algorithms** tab to review or enter the algorithms that should be evoked when a given event occurs.

The grid contains **Algorithms** that control important functions in the system. You must define the following for each algorithm:

- Specify the **System Event** with which the algorithm is associated (see the table that follows for a description of all possible events).
- Specify the **Sequence Number** and **Algorithm** for each system event. You can set the **Sequence Number** to 10 unless you have a **System Event** that has multiple **Algorithms**. In this case, you need to tell the system the **Sequence** in which they should execute.

CAUTION: These algorithms are typically significant processes. The absence of an algorithm might prevent the system from operating correctly.

The following table describes each **System Event**.

System Event	Optional / Required	Description
Validate Email Attachment	Optional	Algorithms of this type are used to validate the attachments for size and total count while sending attachments using the Email service. Refer to Sending Email for more information
Address Geocoding	Optional	Algorithms of this type use Oracle Locator to retrieve latitude and longitude coordinates using address information.
Attachment Malware Scan	Optional	Algorithms of this type are invoked when adding attachment content. The algorithm receives the attachment ID and is expected to use a malware scanning tool to verify the contents of the attachment. Only one algorithm is allowed. Refer to Enabling Malware Scan for more information.
Global Context	Optional	Algorithms of this type are called whenever the value of one of the global context fields is changed. Algorithms of this type are responsible for populating other global context values based on the new value of the field that was changed. Refer to Global Context Overview for more information.
Guaranteed Delivery	Optional	Algorithms of this type may be called by processes that receive incoming messages that should 'guarantee delivery'. Refer to Guaranteed Delivery for more information. The business service F1-GuaranteedDelivery may be used to invoke this plug-in spot.
Ldap Import	Optional	Algorithms of this type are called for operations on users, groups, and group memberships after they have been processed.
Ldap Import Preprocess	Optional	Algorithms of this type are called to preprocess data retrieved from LDAP.
Next To Do Assignment	Optional	This type of algorithm is used to find the next To Do entry a user should work on. It is called from the Current To Do dashboard zone when the user ask for the next assignment.

System Event	Optional / Required	Description
Reporting Tool	Optional	If your installation has integrated with a third party reporting tool, you may wish to allow your users to submit reports on-line using report submission or to review report history online. This algorithm is used by the two on-line reporting pages to properly invoke the reporting tool from within the system.
SMS Receive	Optional	This type of algorithm is used to provide SMS receive service. Only one algorithm of this type should be plugged in.
SMS Send	Optional	This type of algorithm is used to provide SMS send service. If your installation uses the base algorithm that uses BPEL, you will need to create a feature configuration with the SMS Send Configuration feature type to define your Oracle BPEL server and service call details. If your installation has integrated with a third-party SMS service, you may want to override this algorithm type with your own implementation. Only one algorithm of this type should be plugged in.
To Do Information	Optional	We use the term To Do information to describe the basic information that appears throughout the system to describe a To Do entry . Plug an algorithm into this spot to override the system default "To Do information".
To Do Pre-creation	Optional	These types of algorithms are called when a To Do entry is being added. Refer to Refining a To Do Entry's Details at Creation Time for more information.

Installation Options - Accessible Modules

Select **Admin > General > Installation Options - Framework** and the **Accessible Modules** tab to view the list of accessible modules.

Description of Page

This page displays the full list of the application's function modules. A **Turned Off** indication appears adjacent to a module that is not accessible based on your system's module configuration setup.

FASTPATH: Refer to [Module Configuration](#) for more information on function modules and how to turn off modules that are not applicable to your organization.

Installation Options - Installed Products

Select **Admin > General > Installation Options - Framework** and the **Installed Products** tab to view a read only summary of the products that are installed in the application version that you are logged into.

Description of Page

The **Product Name** indicates the name of the "products" that are installed. The collection should include **Framework**, an entry for your specific product and an entry for **Customer Release**.

Release ID shows the current release of the application that is installed. This field is used by the system to ensure that the software that executes on your application server is consistent with the release level of the database.

The **Release ID Suffix**, **Build Number** and **Patch Number** further describe the details of your specific product release.

NOTE: If you have developed implementation-specific transactions, you can populate the release ID, release ID suffix, build number and patch number for the **Customer Release** entry to define the latest version of implementation-specific logic that has been applied to this environment. The framework provides a script (**F1CustRelM**) to allow these fields to be updated manually. In addition, the **F1-InstallationOptions** inbound web service provides operations to view and update those fields via a REST call. Alternatively, your implementation team may populate these fields as part of their upgrade scripts.

The **Product Status** is used to indicate if a product installed by default in the version you are logged into is **Active** or **Inactive**.

The **Display** column indicates the product whose name and release information should be displayed in the title bar. Only one product sets this value to **Yes**.

Owner indicates if this entry is owned by the base package or by your implementation (**Customer Modification**).

Product Type indicates if the product is a Parallel Application. A parallel application is one that is independent of, and does not conflict with, other parallel applications. Multiple parallel applications can be installed in the same database and application server.

NOTE: About Information. The information on this tab is used to populate the information displayed in the [About](#) window for your product.

Support For Different Languages

User Language

The language English (with the locale en-US) is provided by the system and all system metadata are delivered with an English description or label. The system provides support for defining other languages and supports multiple languages in a single environment. System users can use the system in their preferred language, as long as a translation into that language has been provided. A user sees the system in the language defined on their [user record](#). If enabled, users can use the [Switch Language](#) zone to switch to another supported language real time.

Supporting a New Language

Normally, setting up the system for another language (besides the delivered English language entry) is an implementation issue, not an administrative setup issue. However, there are several online administrative features that are used to set up a new language, and these are described here.

- 1. Define a language code and indicate that it is enabled.** For details on this procedure, see [Defining Languages](#).
- 2. Install or confirm the existence of a language pack.** For an on-premise installation, if the product supplies a language pack with translations for the system metadata descriptions, follow the instructions for downloading the language pack and installing it into your environment. For a cloud installation, if the product supplies a language pack for a given language, no additional step is needed here. The language pack is already installed.
- 3. Copy descriptions of all language-enabled tables from an existing translation (e.g., English).** The copied values act as placeholders while the strings are translated into the new language. It is necessary to do this as a first step in order to create records using the new language code created in the previous step. Language-based descriptions can be copied using a supplied batch process, **F1-LANG**. The batch copies all English labels in the system.

The batch process will also update the new language rows with the translated metadata descriptions from the language pack, if installed.

4. **Translate additional content.** Translatable descriptions and labels for implementation data may be updated / entered in the application. First the user record must be updated to reference the new language. This may be done in one of the following ways:

- a. Switch to the new language using the [Switch Language](#) zone.
- b. If that zone is not available, navigate to the user page, assign the new language code to your User ID, sign out, and sign back in again.

Any online functions that you access will use your new language code. You can change the language code for all users who plan to use/modify the new language.

NOTE: The language pack updates all language entries for base owned system data. If your implementation updates base owned labels and descriptions after applying a language pack, they will be overwritten the next time an updated language pack is applied. Note that most user facing labels and messages support defining an Override Label or Override Description. This information is not updated by the base product and should be utilized if your implementation desires a specific label or description.

Managing Multiple Languages

Once a non-English language has been set up, there are several points to note when adding or updating records that include translatable strings.

- When a new record is added through the user interface or through a REST service call or any other means that goes through the standard maintenance service, the system automatically generates entries for each supported language and copies the text of the entered description to all the generated languages.
- When the translatable string for a record is updated, only the user's language row is updated. The system does not ripple the change to other supported language entries (because it could be overriding a valid translation).
- When your system is upgraded to a new version, the new version typically includes new system data. The upgrade only includes the English language rows. Implementers should run the **F1-LANG** batch program to generate language rows for the your supported languages for this new data. If a new translation pack for your supported language is available at the time of upgrade, then running this process also applies the translated strings. (As mentioned above, for on-premise installations, you need to download and install the language pack before this step). If the language pack is not available at the time of upgrade, then the batch program should be run again when the language pack has been installed.
- New translatable objects may also be included in a patch / hot fix. In this situation, the **F1-LANG** batch program should be run after installing the patch in order to ensure there are language rows for your supported languages. Updated language packs are only provided for full release upgrades and not for hot fixes. So implementations may need to temporarily supply translations for the new strings until you update to the next release with the next updated translation pack.

Customer Language

Your specific product may also support capturing the language of a customer. Such that correspondence sent from the product may be produced in a language set on a customer record. Refer to your specific product's documentation for more information about additional language support.

Defining Languages

Your product may support multiple languages. For example, the field labels, input text, and even outputs and reports can be configured to appear in a localized language. A language code for every potential language exists in the system to supply this information in various languages.

Select **Admin > General > Language** to define a language.

This is a standard [All-in-One portal](#).

When **Language Enable** is checked, the system adds a row for this language whenever a row is added in another language. For example, if you add a new currency code, the system will create language specific record for each language that has been enabled. You would only enable multiple languages if you have users who work in multiple languages. Languages that are configured as enabled, appear in the [Switch Language](#) dashboard zone.

NOTE: For on premise applications, the login page displays all the languages that are enabled, allowing the user to toggle the login instructions in that language. The list of enabled languages is captured on the server at startup time. If a new language is enabled, contact your server administrator to refresh the server in order to see the new language displayed in the login page.

The following two fields control how the contents of grids and search results are sorted by the Java virtual machine (JVM) on your web server:

- The **Locale** is a string containing three portions:
 - ISO language code (lower case, required)
 - ISO country code (upper case, optional)
 - Variant (optional).
- Hyphens separate the various portions, and multiple variants are possible. The specific JVM in use by your particular hardware/OS configuration constrains the available **Locales**. Validating the **Locale** against the JVM is outside the scope of this transaction. This means you are responsible for choosing valid **Locales**.

The following are examples of valid locales:

Locale	Comments
en-US	American English
en-AU	Australian English
pt-BR	Brazilian Portuguese
fr-FR-EURO	European French
ja-JP	Japanese

In addition, the Java collation API can take a **Collator Strength** parameter. This parameter controls whether, for example, upper and lower-case characters are considered equivalent, or how accented characters are sorted. Valid values for collator strength are **PRIMARY**, **SECONDARY**, **TERTIARY**, and **IDENTICAL**. If you leave this field blank, Java will use its default value for the language. We'd like to stress that the impact of each value depends on the language.

Please see <https://docs.oracle.com/javase/7/docs/api/java/text/Collator.html> for more information about the collator strength for your language.

Display Order indicates if this language is written **Left to Right** or **Right to Left**.

Note that all administrative control tables and system metadata that contain language-specific columns (e.g., a description) reference a language code. In addition, other tables may reference the language as a specific column. For example, on the User record you indicate the preferred language of the user.

Defining Countries

The topics in this section describe how to maintain countries.

Country - Main

To add or review Country definitions choose **Admin > General > Country**.

The **Main** page is used to customize the fields and field descriptions that will be displayed everywhere addresses are used in the system. This ensures that the all addresses conform to the customary address format and conventions of the particular country you have defined.

Description of Page

Enter a unique **Country** and **Description** for the country.

The address fields that appear in the **Main** page are localization options that are used to customize address formats so that they conform to address requirements around the world. By indicating that an address field is **Optional**, you make that field available everywhere addresses for this country are used in the system. You can enter your own descriptions for the labels. These labels will appear wherever addresses are maintained in the system.

NOTE: Your specific product may also add the ability to mark an address field as **Required**. If that is available, then the product is also supplying appropriate validation in all places where a user defines an address.

NOTE: For any country where the **State** is enabled, the valid states for the country must be entered on the **Country - State** tab. When entering address constituents on a record that captures this detail, the value for State is verified against the data in the State table. For any country where there is a component of the address that represents a "state" but your implementation does not want to populate the valid states for that country, choose a different field such as County for this constituent (and define an appropriate label). When entering address constituents on a record that captures this detail, no validation is done for the County column.

Country - States

To maintain the states located in a country, choose **Admin > Country > Search** and navigate to the **State** page.

Description of Page

For any country where you have enabled the State switch, use the **State** collection to define the valid states in the **Country**.

- Enter the standard postal abbreviation for the **State** or province.
- Enter a **Description** for this state or province.

Defining Currency Codes

The currency page allows you to define display options related to currency codes that are used by your system. Use **Admin > General > Currency** to define the currency codes in which financial information is denominated.

This is a standard [All-in-One portal](#).

Most attributes are self explanatory.

NOTE: Please contact your specific product to verify whether it supports a currency with more than 2 **Decimals**.

The **External Reference** may be used to define a currency whose currency code is more than three characters. To support that type of currency, define a currency code that uniquely identifies the currency in the system and use the external reference to define the currency code recognized by external products. Note that your specific integration with an external system where financial information is included may need to be adjusted to use the external reference instead of the system's currency code. Refer to the specific documentation for your integrations to confirm.

Defining Time Zones

The following topics describe how to design and set up time zones.

Designing Time Zones

The Time Zone entity is used to define all the time zones where your customers may operate. Each time zone should define an appropriate Time Zone Name. This is a reference to an external source that defines time zones, their relationship to Greenwich Mean Time, whether the time zone follows any shifting for summer / winter time (daylight savings time) and when this shift occurs.

The following sections describe concepts and configuration topics related to managing time zones.

NOTE: Oracle Utilities Customer Care and Billing - Interval Billing applications customers should consult the topic *Time Issues* (search the Help index for "time issues") for specific information relating to that product's interval billing time related functionality.

The Base Time Zone

When designing your time zones, the first thing to determine is the base time zone. You may choose the time zone where the company's main office resides. Once this is done you can link the time zone code to the installation option as the base time zone. Refer to [Installation Options - Main](#) for more information.

NOTE: An attribute in the system properties file may be configured to indicate that the DB session time zone should be synchronized with the value defined on the Installation Options. Refer to the *Server Administration Guide* for more information.

If your company does business beyond your main office's time zone, define the other time zones where you may have customers or other systems with which you exchange data. At this point, your specific product may include configuration tables to capture default time zones, for example based on a postal code or geographic location.

Standard vs. Legal Time

The term **Legal Time** refers to the actual clock time as may be impacted by daylight saving (also called 'local time'). This time line has a gap hour on entry to the daylight saving period and a duplicate hour on exit from it.

The term **Standard Time** refers to a time line without any daylight saving shifts applied to it. This virtual time line has no gap hour on entry to the daylight saving period nor a duplicate hour on exit, i.e. it is continuous and non-ambiguous. As a general rule, it is recommended that all time sensitive data is stored in the standard time of the base time zone as defined on the installation options. This will prevent any confusion when analyzing data and will ensure that your algorithms do not have to perform any time zone or daylight saving shifting of data that may be stored in different time zones.

Depending on your specific product, entities may have their date/time information stored in either of the following options:

- Standard time of the base time zone (also called 'physical time').
- Standard time of another time zone related to the entity's geographical location (also called 'logical time').
- Legal time of the base time zone.

The metadata definition of a [table](#) specifies whether any of its date/time fields are stored in standard time or not. While typically all date/time fields of a table that supports standard time would be stored in the same way the system allows each [field](#) to specify its own option. The metadata definition of such field specifies whether it is base time zone standard time (**Physical Standard Time**), standard time of some other time zone associated with the entity (**Legal Standard Time**) or stored in base time zone legal time (**Referenced Time Zone**).

Storage vs. Display

Regardless of the time zone option used for storing the data in standard time, all date/time information is entered and displayed on the user interface in the legal time of its respective time zone. If a field is defined to be stored in the standard time of the base or other time zone, the user interface is designed to accept the data in the legal time of the respective time

zone and shift it to the standard time of the same time zone before saving the data and performs the reverse shift from standard time back to legal time before displaying the data to the user.

It is important to understand that time zone and daylight saving time conversions to and from standard time are performed behind the scenes as part of the user interface layer. Once data reaches the server it is already in its storage time option. The user should not be aware of these time conversions.

Time shifting between standard and legal times does not happen automatically. When dealing with fields stored in standard time, their data entry and display need to explicitly include time shifting features as part of their user interface and zone configuration.

Date / Time Schema Elements

When defining date / time fields in a business object schema, schema attributes can be used to define whether or not data should be stored in standard time for the base time zone or if it should be stored in the standard time of another time zone (related to the data).

By default data stored in standard time is displayed in the corresponding time zone's legal time. Additional schema attributes can be used to indicate if the display of the time should be shifted to the legal time of a different time zone. For example, if the data is stored in the base time zone but the data is related to a different time zone, the data will be shown in the time zone appropriate for the data (including the appropriate seasonal adjustment). Refer to [Schema Nodes and Attributes- Standard Time Considerations](#) for more information.

Exchanging Date / Time Information With External Systems

Date/time information should be exchanged between systems in standard XSD format as it includes a reference to the time zone of the specified time as an offset from Coordinated Universal Time (UTC). The system automatically converts date/time elements in an inbound message from XSD to internal format and vice versa for an outbound message. The latter is controlled by an explicit date/time format setting on the External System record for the outbound message type.

The offset is determined as followed and it is based on the time zone associated with the element as explicitly defined by the respective inbound or outbound schema:

- Elements defined as stored in the standard time of the base or other time zone would always have the same offset throughout the year as this time line is never shifted for daylight saving. The offset would be the standard offset of that time zone from UTC, i.e. not during daylight saving time.
- Elements stored in the legal time of the base time zone would have the standard offset of the base time zone when the date/time value is outside the daylight saving period and the shifted offset when it is inside that period of time.

User Time Zone

If your company does business in multiple time zones, the user record of each user may reference the time zone of their location. This time zone provides additional information about the location of the user and as such may be used by specific business rules that involve time zone settings.

NOTE: The time zone defined on the user record is not used to automatically display date/time information in the user's time zone. By default, the system displays date/time fields that are stored in standard time in the legal time of their respective time zone and not the user's time zone.

Setting Up Time Zones

Refer to [Designing Time Zones](#) for background information about defining time zones.

Open this page using **Admin > General > Time Zone > Search** .

This is a standard [All-in-One](#) portal.

Refer to the embedded help text for more information on the Time Zone attributes.

Setting Up Seasonal Time Shift

NOTE: The information in this topic applies only to Oracle Utilities Customer Care and Billing - Interval Billing applications.

Open **Admin > General > Seasonal Time Shift > Search** to define the seasonal time shift schedule.

Description of Page

Enter a unique **Seasonal Time Shift** code and **Description** for the seasonal time shift.

The Collection defines the **Effective Date/Time** (in standard time) that a time zone may shift in and out of standard time. If time is changed from standard time on the effective date/time, enter the **Shift in Minutes** that the time changes from standard time (usually **60**). If the time is changed back to standard time on the effective date/time, enter a **Shift in Minutes** of **0**.

Defining Geographic Types

If your company uses geographic coordinates for dispatching or geographic information system integration, you need to setup a geographic (coordinate) type for each type of geographic coordinate you capture on your premises and/or service points (geographic coordinates can be defined on both premises and service points).

NOTE: Product specific. There is no framework functionality that uses this information. Refer to your specific product documentation to verify how this table is used in your specific product. In addition, you can determine if this object is a foreign key on any tables specific to your product. Navigate to the Table page in the application, search for and select the Geographic Type table and use the Relationships tab to view this information.

To define geographic types, open **Admin > Geographic > Geographic Type**.

This is a standard [All-in-One portal](#).

The **Validation Format Algorithm**, if specified, is used to validate that the geographic location entered on the premise and/or service point for the geographic type is in the format as defined in the algorithm. If you require validation, you must set up this [algorithm](#) in the system.

Defining Work Calendar

This portal is used to view and maintain information about a work calendar. Work calendars are used to ensure system-calculated dates fall on a workday.

You can access the portal from **Admin > General > Work Calendar**. You are brought to a query portal with options for searching for a specific calendar. Once a calendar has been selected you are brought to the maintenance portal to view and maintain the selected record.

The following zones will appear as part of the portal's **Main** tab page

- **Work Calendar.** This zone provides information about the selected calendar.
- **Work Calendar Holidays.** This zone lists the holidays observed by your organization for this calendar. Use the zone actions to add, maintain or duplicate a work holiday entry.

Defining Display Profiles

When you set up your users, you reference a display profile. A user's display profile controls how dates, times, and numbers are displayed. Choose **Admin > General > Display Profile > Search** to maintain display profiles.

Description of Page

Enter a unique **Display Profile** and **Description** to identify the profile.

Enter a **Date Format**. This affects how users view dates and how entered dates are parsed. The following table highlights standard supported date mnemonics and what is displayed at runtime.

Mnemonic	Comments
dd	Day of the month.
d	Day of the month, suppressing the leading 0.
MM	Month number.
M	Month number, suppressing the leading 0.
yyyy	The 4-digit year.
yy	The 2-digit year.
y	Allows entry in either 2 or 4-digit form and is displayed in 2-digit form.

Other characters are displayed as entered. Typically, these other characters should be separators, such as "-", ".", or "/". Separators are optional; a blank space cannot be used.

Examples:

Configuration Format	Sample Output
MM-dd-yyyy	04-09-2001
d/M/yyyy	9/4/2001
yy.MM.dd	01.04.09
MM-dd-y	04-09-01 - In this case you could also enter the date as 04-09-2001

NOTE: For centuries, the default pivot for 2-digit years is **80**. Entry of a 2-digit year greater than or equal to **80** results in the year being interpreted as 19xx. Entry of a 2-digit year less than **80** results in the year being interpreted as 20xx.

In addition, the following date localization functionality is supported. Note that in every case, the date is stored in the database using the Gregorian format. The settings below result in a conversion of the date for the user interface.

- **Hijri Dates**

Entering **iiii** for the year is interpreted as a year entered and displayed in Hijri format. For example, the Gregorian date 2014-05-30 may be entered / displayed as 1435/07/30 for a user whose display profile date format is **iiii/MM/dd**. Note that this functionality relies on date mapping to be defined in the Hijri to Gregorian Date Mapping [master configuration](#) entry. Refer to [Additional Hijri Date Configuration](#) for more information.

- **Taiwanese Dates**

Entering **tttt** for the year is interpreted as a year entered and displayed in Taiwanese format where year 1911 is considered year 0000. For example, if the Gregorian date is 01-01-2005, it is displayed as 01-01-0094 for a user whose display profile date format is **dd-mm-tttt**.

- **Japanese Dates**

There are two options available for configuring Japanese Era date support. The setting **Gyy** for the year is interpreted as a year entered and displayed using an English character for the era followed by the era number. The letter 'T' is used for dates that fall within the *Taisho* era. The letter 'S' is used for dates that fall within the *Showa* era. The letter 'H' is used for dates that fall within the *Heisei* era. The letter 'R' is used for dates that fall within the *Reiwa* era. For example, for a user whose display profile date format is **Gyy/mm/dd** the Gregorian date 2008/01/01 is shown as **H20/01/01**; the

Gregorian date 1986/03/15 is shown as **S61/03/15**. The setting **GGGGyy** is interpreted as a year entered and displayed using Japanese characters for the era followed by the era number.

Japanese date limitations are as follows:

- The years 1912 through the current date are supported.
- Any functionality that displays Month and Year does not support Japanese Era dates. These dates are shown in Gregorian format.
- Graphs that display dates do not support the **GGGGyy** format.

Enter a **Time Format**. The following table highlights standard supported date mnemonics.

Mnemonic	Comments
hh	The hour 1-12.
h	The hour 1-12, suppressing the leading 0.
HH	The hour 0-23.
H	The hour 0-23, suppressing the leading 0.
KK	The hour 0-11.
K	The hour 0-11, suppressing the leading 0.
kk	The hour 1-24.
k	The hour 1-24, suppressing the leading 0.
mm	Minutes.
m	Minutes, suppressing the leading 0.
ss	Seconds.
s	Seconds, suppressing the leading 0.
a	Indicates to include am or pm . This is only needed for 12 hour formats, not 24 hour formats. (hh , h , KK , K). If an am or pm is not entered, it defaults to am .

Examples:

Configuration Format	Sample Output
hh:mma	09:34PM (can be entered as 09:34p)
hh:mm:ss	21:34:00
h:m:s	9:34:0

There are several options for displaying Numbers.

Decimal Symbol defines the separator between the integer and decimal parts of a number. Valid values are "." (a period) or "," (a comma).

Group Symbol defines the means to separate groups of bigger numbers. Valid values are as follows:

- A comma (","). Large numbers group by threes separated by a comma, for example 1,000,000.
- A period ("."). Large numbers group by threes separated by a period, for example 1.000.000.
- **None**. Large numbers do not have any separator, for example 1000000.
- **South Asian**. This option uses a comma for its separator but will group large numbers as follows: the first comma is used for the thousands separation and numbers over 9,999 are grouped with 2 units, for example 10,00,000.
- **Space**. Large numbers group by threes separated by a space, for example 1 000 000.

Negative Format defines how negative values are displayed. Valid values are **-9.9**, **(9.9)**, or **9.9-**.

Currency values can have a different **Negative Format** from other numbers. Valid values are **-S9.9**, **(S9.9)**, or **S9.9-**, where the "S" represents the currency symbol.

Additional Hijri Date Configuration

For implementations that wish to support displaying dates according to the Hijri calendar, besides appropriate configuration in the [Display Profile](#), the mapping between the Hijri dates and the Gregorian dates must be entered. This mapping is defined in the [Hijri to Gregorian Date Mappingmaster configuration](#) record.

The mapping record contains a collection of entries for each year in the Islamic calendar.

For each year, clicking the Expand Zone icon shows the mapping collection with the first date of each month of the Hijri calendar. The corresponding date in the Gregorian calendar should be entered for each row.

Defining Phone Types

Phone types define the format for entering and displaying phone numbers.

To add or review phone types, choose **Admin > General > Phone Type**.

This is a standard [All-in-One portal](#).

The **Phone Number Format Algorithm** for each phone type controls the format for entry and display of phone numbers.

Use **Phone Type Flag** is used to identify phone types that may have specific functionality associated with it. For example if your product had support for sending a facsimile transmittal, identify the phone type that captures a **Fax** number.

Defining Feature Configurations

Some system features are configured by populating options on a "feature configuration". Because various options throughout the system may be controlled by settings in feature configuration, this section does not document all the disparate possible options. The topics below simply describe how to use this transaction in a generic way.

For information about specific features:

- Refer to the detailed description of each option type.
- Use the index in the online help and search for 'feature configuration' to find any specific topics describing feature options in the administration guide.

You can create options to control features that you develop for your implementation. To do this:

- Review the lookup values for the lookup field **EXT_SYS_TYP_FLG**. If your new option can be logically categorized within an existing feature type, note the lookup value. If your new option warrants a new feature type, add a lookup value to this lookup field.
- Define the feature's option types. If you have identified an existing feature type to add the options to, find the lookup with the name **xxxx_OPT_TYP_FLG** where **xxxx** is the lookup value of **EXT_SYS_TYP_FLG** noted above. If you decided to create a new feature type (by adding a new lookup value to the **EXT_SYS_TYP_FLG** lookup, you must create a new lookup with the name **xxxx_OPT_TYP_FLG** where **xxxx** is the new value you defined above.
- Flush all caches.

Feature Configuration - Main

To define your feature configuration, open **Admin > General > Feature Configuration**.

Use the **Feature Configuration Query** portal to search for an existing feature configuration. Once a feature configuration is selected, you are brought to the maintenance portal to view and maintain the selected record.

Description of Page

Enter an easily recognizable **Feature Name** code.

Indicate the **Feature Type** for this configuration. For example, if you were setting up the options for the external messages, you'd select **External Messages**.

NOTE: You can add new Feature Types. Refer to the description of the page above for how you can add Feature Types to control features developed for your implementation.

NOTE: Multiple Feature Configurations for a Feature Type. Some Feature Types allow multiple feature configurations. The administration documentation for each feature will tell you when this is possible.

The **Options** grid allows you to configure the feature. To do this, select the **Option Type** and define its **Value**. Set the **Sequence** to **1** unless the option may have more than value. **Detailed Description** may display additional information on the option type.

NOTE: Each option is documented elsewhere. The administration documentation for each feature describes its options and whether an option supports multiple values. Use the index to look for 'feature configuration' to find the various types of feature options.

NOTE: You can add new options to base-package features. Your implementation may want to add additional options to one of the base-package's feature types. For example, your implementation may have plug-in driven logic that would benefit from a new option. To do this, display the lookup field that holds the desired feature's options. The lookup field's name is **xxxx_OPT_TYP_FLG** where **xxxx** is the identifier of the feature on the **EXT_SYS_TYP_FLG** lookup value. For example, to add new batch scheduler options, display the lookup field **BS_OPT_TYP_FLG**.

Feature Configuration - Messages

If the feature exists to interface with an external system, you can use this page to define the mapping between error and warning codes in the external system and our system.

Open this page using **Admin > General > Feature Configuration** and navigate to the **Messages** tab.

Description of Page

For each message that may be received from an external system, define the **Feature Message Category** and **Feature Message Code** to identify the message.

A corresponding message must be defined in the [system message](#) tables. For each message identify the **Message Category** and **Message Number**. For each new message, the Message Category defaults to **90000** (because an implementation's messages should be added into this category or greater so as to avoid collisions during upgrades).

Defining Master Configurations

A master configuration is an object that enables an implementation to define configuration for features in the system. It is an alternative to using feature configuration for defining options. A master configuration is defined using a business object. Only one master configuration may exist for a given business object.

Overview / Initial Setup

The product provides one or more master configuration that may be used for configuration. Some examples of base master configuration business objects are as follows

- **Hijri to Gregorian Date Mapping.** This allows an implementation that uses Hijri dates to define the mapping between those dates and Gregorian dates.

- **ILM Configuration.** For implementations that use Information Lifecycle Management, the ILM configuration record defines some parameters used by the process.
- **Migration Assistant Configuration.** For implementations that use the content migration assistant (CMA), the configuration record defines some parameters used by the process.

For a list of all the master configuration records provided by the product, navigate to the master configuration page in the application. To find help topics related to functionality controlled by the master configuration records, use the keyword 'master configuration' in the index.

Implementations may configure the business objects to limit the ones that are visible to users if desired.

- If the master configuration does not apply to your implementation, navigate to the business object for this master configuration and update the Instance Control to **Do not allow new instances**. This ensures that the business object will not be visible to any user for the implementation.
- If a given master configuration record is only relevant for certain users in the system, application security may be used to limit the records visible by a given user. By default the base delivered business objects typically reference the Master Configuration MO application service. This may be overridden to link custom application services to the master configuration BOs to provide more granular security. Users will only see the master configurations that they have security for.

Configuration

To set up a master configuration, open **Admin > General > Master Configuration**.

The topics in this section describe the base-package zones that appear on the Master Configuration portal.

Master Configuration

The Master Configuration List zone lists every category of master configuration.

The following functions are available:

- If a master configuration record exists for a given master configuration business object, the broadcast icon may be used to view details information about the adjacent master configuration. In addition, an edit icon is visible to allow a user to update the record.
- If a master configuration record does not exist for a given master configuration business object, the add icon is visible to allow a user to define the record.

Master Configuration Details

The Master Configuration Details zone contains display-only information about a master configuration.

This zone appears when a master configuration has been broadcast from the Master Configuration zone.

Please see the zone's help text for information about this zone's fields.

Security & User Options

The contents of this section describe how to maintain a user's access rights.

Application Security

The system restricts access to various components of the application using application services. The following sections provide more information about this mechanism.

Understanding Application Security

The contents of this section provide background information about application security.

Application Security

The system restricts access to transactions or explicit services using an [application service](#). The following points highlight what may be secured.

- The following points highlight security related to viewing and modifying individual records in the system:
 - All [maintenance objects](#) define an application service that includes the basic actions available, typically **Add**, **Change**, **Delete**, and **Inquire**. The base product supplies an application service for every maintenance object. Note that the application service for the maintenance object is defined on its related [service program](#).
 - For maintenance objects whose user interface page is not portal-based, the application service also controls whether the menu entry appears. If a user doesn't have access to the maintenance object's application service, the menu item that corresponds with the application service will not be visible.
 - For portal based user interfaces, each main (stand-alone) [portal](#) defines an explicit application service with the access mode **Inquire**, allowing the user interface to be secured independently of the underlying object security. If a user doesn't have access to the portal's application service, the menu item that corresponds with the application service will not be visible. The base product supplies an application service for every portal that is accessible from the menu. Note that the application service for the portal is defined on its related [service program](#), which is derived via its navigation option and navigation key.
 - [Menu items](#) may define an application service / access mode. Typically the security supplied for portals and maintenance objects provides enough granularity to suppress menu items that a user does not have access to. Linking an explicit application service / access mode will further suppress the menu item under one of the following scenarios:
 - Suppress a menu item if the underlying application security for the transaction does not provide enough fine grained control. For example, imagine your implementation creates a special BPA script to add a To Do Entry and would like users to use the special BPA rather than the base supplied Add dialogue for To Do Entry. The underlying security settings for To Do Entry should grant Add access to these users given that the special BPA will still add a record. To suppress the base Add dialogue, link a special application service and access mode for the base supplied menu item for To Do Entry Add. Then define a menu entry for the new special BPA for adding.
 - Suppress the add option if a user does not have add security for the object. By default the product does not suppress the add function if a user does not have add access to the object. Rather, the user is prevented from adding the record at the back-end. If your implementation would like to suppress the menu option, link the object's application service and the Add access mode to the Add menu item.

NOTE: The base product does not typically provide menu items with application services configured. Implementations may add this configuration if one of the above scenarios exist.

- [Zones](#) define an application service.
 - For zones linked to a portal, if a user doesn't have access to the zone's application service, the zone will not be visible on the portal. In most cases the zone is delivered with the same application service as its portal. In special cases, such as the zones on the Dashboard, the product supplies separate application services for each zone allowing implementations to determine at a more granular level which users should have access to which zones.
 - For query zones that are configured on a multi-query zone, if a user doesn't have access to the zone's application service, the zone will not be visible in the dropdown on the multi-query zone. In most cases all zones in a multi-query zone define the same application service as the multi-query zone. The product may supply a special

application service for one or more zones in a multi-query zone if the functionality is special to certain markets or jurisdictions and not applicable to all implementations.

- For zones that are used by business services to perform SQL queries, the product supplies a default application service. Security for these zones is not checked by the product as they are used for internal purposes.
- For portal based pages, individual elements may be shown or hidden based on security using the **oraHasSecurity** function in a UI map's HTML or in UI Hints in a schema. Refer to [Check User's Security Access](#) for more information.
- **Business objects** define an application service. If the business object defines a lifecycle, the application service must include access modes that correspond to each state. In addition, the standard maintenance object access modes of **Add, Change, Delete** and **Inquire** are included. The base product business objects are supplied with appropriate application services. In addition, implementations may override the configured application service if desired.
- **Batch controls** define an application service which provides the ability to secure submission of individual batch processes. The application service must include an access mode of **Execute**. The base product batch controls are supplied with appropriate application services. These services will typically have an ID that matches the batch control ID.
- **Report Definition** records define an application service. The application service must include an access mode of **Submit / View Report**.
- The following objects are securable but are typically executed via internal processes. The security is provided to ensure that any access to the objects from an external source is secured.
 - **BPA scripts** may define an application service with the access mode **Execute**. The base BPA scripts are typically not configured with any application service. An implementation may define one. Note that as mentioned above, a menu item may also be configured with an application service and access mode. This allows for a BPA that is invoked via a menu entry to be secured in more than one way.
 - **Business Services** and **Service Scripts** define an application service with the access mode **Execute**. This is needed for services that may be executed from an external system, for example via an inbound web service. Base business services and service scripts that are linked to an inbound web service are configured with special application service. All other business services and service scripts are delivered with a default application service, which may be overridden by an implementation.
 - Scripts may also check security within an Edit Data step type if there is some functionality that should or should not execute based on a user's security access. The Edit Data step would include a call to the business service **F1-CheckApplicationSecurity**
 - **Service Programs** define an application service. As mentioned above, for Portals and Maintenance Objects, their application service is taken from the related service program. In base, specific application services are released for each of these types of service programs. All other service programs are typically delivered with a default application service, which may be overridden by an implementation. Note that for service programs linked to a Business Service, the application service on the business service takes precedence when invoking the business service.

Users are granted access to application services via [user groups](#). For example, you may create a user group called Senior Management and give it access to senior manager-oriented pages and portals.

- When you grant a user group access to an application service with multiple access modes, you must also define the access modes that are allowed. Often the access modes correspond to an action on a user interface. For example, you may indicate a given user group has **inquire**-only access to an application service, whereas another user group has **add, change, cancel** and **complete** access to the same service. Refer to [action level security](#) for more information.
- If the application service has [field level security](#) enabled, you must also define the user group's security level for each secured field on the transaction.
- And finally, you link individual [users](#) to the user groups to which they belong. When you link a user to a user group, this user inherits all of the user group's access rights.

Action Level Security

When you grant a user group access to an [application service](#), you must indicate the actions to which they have access.

- For application services that only query the database, there is a single action to which you must provide access - this is called **Inquire**.
- For application services that can modify the database, you must define the actions that the user may perform. At a minimum, most maintenance transactions support **Add**, **Change**, and **Inquire** actions. Additional actions are available depending on the application service's functions.

CAUTION: Important! If an application service supports actions that modify the database other than **Add**, **Change**, and **Delete**; you must provide the user with **Change** access in addition to the other access rights. Consider a transaction that supports special actions in addition to **Add**, **Change**, and **Inquire** (e.g., **Freeze**, **Complete**, **Cancel**). If you want to give a user access to any of these special actions, you must also give the user access to the **Inquire** and **Change** actions.

Field Level Security

Sometimes transaction and action security is not sufficient. There are situations where you may need to restrict access based on the values of data. For example, in Oracle Utilities Customer Care and Billing you might want to prevent certain users from completing a bill for more than \$10,000. This is referred to as "field level security".

Field level security can be complex and idiosyncratic. Implementing field level security always requires some programming by your implementation group. This programming involves the introduction of the specific field-level logic into the respective application service(s). The recommendation is to use a business object validation algorithm for checking field level security.

NOTE:

The check for field level security must exist in validation logic to ensure that data is not added or updated if it does not pass the field level security rules.

It is not straight forward to implement user interface changes related to field level security, such as protecting elements under certain conditions. This is because overriding the base product delivered user interface to check for implementation specific conditions is not always supported, depending on how the user interface is built, or requires a full duplication of product artifacts, which is not recommended.

The definition of a user's access rights is performed using the same transactions used to define transaction / action level security. This is achieved as follows:

- Create a [security type](#) for each type of field-level security.
- Define the various access levels for each security type. For example, assume you have some users who can complete bills for less than \$300, and other users who can complete bills for less than \$1,000, and still other users who can complete bills for any value. In this scenario, you'd need 3 access levels on this security type:
 - Level 1 (lowest): May authorize bills <= \$300
 - Level 2 (medium): May authorize bills <= \$1,000
 - Level 3 (highest): May authorize all bills
- Link this security type to each [application service](#) where this type of field level security is implemented. This linkage is performed on the [security type](#) transaction.
- Defining each [user group's](#) access level for each security type (this is done for each application service on which the security type is applicable).

NOTE:

Highest value grants highest security. The system expects the highest authorization level value to represent highest security level. Moreover, authorization level is an alphanumeric field so care should be taken to ensure that it's set up correctly.

The Base Package Controls One User, One User Group, And Many Application Services

When the system is initially installed, the following information is delivered:

- Application services for all secured transactions, maintenance objects, business objects, business services, scripts and zones in the base package.
- A user identified by the user id **SYSUSER**.
- A user group identified by the user group code **ALL_SERVICES**. This user group is associated with all supported application services delivered with the base product. This user group is given access to all access modes for all application services (i.e., all actions on all transactions).
- The user **SYSUSER** is linked to the **ALL_SERVICES** user group. This means that this user has access to all transactions and all actions.

You cannot change or remove the information delivered for **ALL_SERVICES**. This information is owned by the base package. It is provided so that an "initial user" has access to the entire system and can setup user groups and users as per your organization's business requirements. It is not recommended to provide your own users with access to the **ALL_SERVICES** user group. Rather, create user groups that are appropriate for the organization's business requirements and define user access to these user groups. If you introduce new transactions, configure them for the appropriate custom user groups.

In addition, **SYSUSER** is provided to allow for an initial user to define appropriate users in your implementation. Once proper administrative users have been defined, it is recommended that **SYSUSER** is updated to set the User Enable setting to Disabled.

When you receive an upgrade:

- New application services are delivered for the new transactions, business objects, zones introduced in the release. The release notes highlights the additions / changes.
- Existing application services are updated with changes in their access modes (e.g., if a new action is added to a transaction, its application service is updated accordingly).
- The **ALL_SERVICES** user group is updated so it can access the new / changed application services.
- Implementations should review the release notes and determine which user groups created for your implementation should be updated with the additions, if applicable.

Importing Security Configuration from an External Source

The product provides support for importing security information from an external source:

- If your organization uses Lightweight Directory Access Protocol (LDAP), you can import your existing LDAP users and groups into the system. Once imported, all user and group functions are available. You can import a user group, or a single user. You can resynchronize your LDAP users and groups at any time.

FASTPATH: For more information refer to [LDAP Integration](#).

- The system provides an integration with Oracle Identity Manager. When a user is created in the identity manager product, its information can automatically be interfaced to the product. Once the user is successfully created in the system, all functions are available.

FASTPATH: For more information refer to [Oracle Identity Manager Integration](#).

Defining Application Services

Please refer to [Application Security](#) for a description of how application services are used when you grant user groups access rights to transactions. Refer to [Action Level Security](#) for more information about the significance of an application service's access modes.

You can access the portal using **Admin > Security > Application Service**. You are brought to a query portal with options for searching for a specific application service. Once a record has been selected you are brought to the maintenance portal to view and maintain the selected record.

NOTE: When introducing a new record, carefully consider its naming convention. Refer to [System Data Naming Convention](#) for more information.

The following zones may appear as part of the portal's **Main** tab page

- The **Application Service** zone provides the information about the application service and its access modes.
- The **Secured Objects** zone displays the object (or objects) that are secured by this application service. Refer to [Application Security](#) for details about the types of objects that may be secured.

The **Application Security** tab includes zones to view and manage which user groups have access to the application service and which ones do not have access. The following zone may appear as part of this tab page:

- The **User Groups Linked** zone lists the user groups that currently have a link to the application service. Note that expired links are included when the zone is first displayed. Use the zone filters to exclude expired links and to limit the user groups shown by user ID, user group ID, and user group description.
- The **User Groups not Linked** zone lists the user groups that do not have a link to the application service. Use the zone filters to limit the user groups shown by user ID, user group ID, and user group description.

Defining Security Types

Security types are used to define the types of [field level security](#).

NOTE: Programming is required. You cannot have field level security without introducing programming code. Refer to [Field Level Security](#) for more information on how security types are used to define field level security.

Security Type - Main

Select **Admin > Security > Security Type** to define your security types.

Description of Page

Enter a unique **Security Type** and **Description**.

Use the **Authorization Level** grid to define the different authorization levels recognized for this security type. Enter an **Authorization Level Number** and its **Description**.

NOTE: Programming is required. Note that the values that you enter are not interpreted by the system itself, but by the user exit code used to implement the special security. Check with the developer of the user exit logic for the correct values. Refer to [Field Level Security](#) for more information on how security types are used to define field level security.

Use the **Application Services** grid to define the application service(s) to which this security type is applicable. If this application service is already associated with user groups, you must update each user group to define their respective security level. This is performed on the User Group portal.

Defining User Groups

A user group is a group of users who have the same degree of security access. Think of a user group as a "role"; associated with a role are:

- The users who play this role
- The application services to which the role's users have access (along with the actions they can execute for each service and their field level security authorization levels).

Refer to [Action Level Security](#) and [Field Level Security](#) for more information about access modes and security types.

CAUTION: Important! If an application service supports actions that modify the database other than **Add**, **Change**, and **Delete**; you must provide the user with **Change** access in addition to the other access rights. Consider a transaction that supports actions in addition to **Add**, **Change**, and **Inquire** (e.g., **Freeze**, **Complete**, **Cancel**). If you want to give a user access to any of these additional actions, you must also give the user access to the **Inquire** and **Change** actions.

This portal allows a security administrator to view and manage information about a user group.

You can access the portal from the **Admin Menu > Security > User Group**. You are brought to a query portal with options for searching for a specific user group. Once a user group has been selected you are brought to the maintenance portal to view and maintain the selected record.

CAUTION: Application services may not be changed or removed from the **ALL_SERVICES** user group. Refer to [The Base Package Controls One User, One User Group, And Many Application Services](#) for an explanation.

The following zones may appear as part of the portal's **Main** tab page

- **User Group.** This zone provides information about the selected user group.
- **Application Services.** This zone lists application services linked to the selected user group. You may use this zone to edit the information for an specific application service or use mass actions to remove selected services or update their effective date.
- **Add Application Services.** You may use this zone to add application services to the selected user group.

The following zones may appear as part of the portal's **Users** tab page

- **Users.** This zone lists users linked to the selected user group. You may use mass actions to remove selected users or update their effective date.
- **Add Users.** You may use this zone to add users to the selected user group.

The following zones may appear as part of the portal's **Service Manager** tab page

- **Application Service / Access Modes.** This zone lists application service and access mode combinations currently linked to the selected user group. You may use mass action to remove a selected set of records.
- **Add Application Service / Access Modes.** You may use this zone to add application service access mode records.
- **Security Type Authorization.** This zone maintains field level security for application services included in the selected user group.

The following zone may appear as part of the portal's **Secured Components** tab page

- **Application Components.** This zone allows you to review various types of application components secured by the selected user group. The query is similar to the [Application Security Query](#) restricted to the current user group.

Defining Users

The user maintenance transaction is used to define a user's user groups, data access roles, portal preferences, default values, and To Do roles. To access the user maintenance transaction, select **Admin > Security > User**.

The user maintenance transaction is the same transaction invoked when the user launches [Preferences](#) from the user menu or shortcut key.

Application Security Query

This portal allows a security administrator to review application security configurations across users, user groups and the various types of application components they secure.

While application security is configured at the granular level of an application service and its access modes, it is more intuitive to review access rights to top level broader components:

- **Menu line.** Several application services may be related to a single menu line and impact the ability to properly leverage various aspects of its functionality:
 - The application service of the transaction page or portal, which also controls the visibility of the menu line or its 'search' part when the line is composed of 'add' and 'search' items.
 - The application services associated with any zones on that portal.
 - The application service of the underlying maintenance object when applicable, which also controls the 'add' item of the menu line.
 - The application services of business objects for the underlying maintenance object.
 - The application services of portals used to maintain these business objects.
 - The application services of related portals.
 - The application services of related maintenance objects, their business objects and portals.
 - and more

You may review the list of application services associated with a menu line on the **Application Security** tab on the **Menu** portal.

- **Dashboard Zone.** This is a regular or context sensitive zone that the user has access to on the Dashboard area.
- **System.** This is a Toolbar or other system wide option a user is allowed to use.
- **Batch Control.** This is a batch process a user is allowed to submit.
- **Report Definition.** This is a report a user is allowed to submit.
- **Web Service.** This is a web service a user is allowed to invoke.
- **Miscellaneous.** This is a special service that a user is allowed to invoke.
- **Internal.** This is an internal item that is secured by default but is assumed to be called in a context that does not require security check.
- **Unclassified.** Some application services may not be related to any type of application component and as such remain unclassified. For example, there are situations where previously released services are enhanced to be associated with dedicated application service in a later release. In this situation the services may retain their original or even custom application service and the new application services may appear as not associated with any component.

Refer to [Application Security](#) for details about the types of objects that may be secured.

Open this page using **Admin > Security > Application Security Query**.

Row Security

Some products allow you to limit a user's access to specific rows. For example, in Oracle Utilities Customer Care and Billing, row level security prevents users without appropriate rights from accessing specific accounts.

A combination of framework configuration and configuration in your edge product is required for row level security. The following points describe the configuration:

- For each record that should be secured, associate it with an **Access Group**. Note that if your edge product supports row level security, that product is providing a link between the secure-able record and Access Group. Your access groups may be granular and only referenced by one secured record or they may be more broad and be referenced by multiple secured records that require the same type of security restriction.
- To define which users have access to the secured records, you define a **Data Access Role**. For each data access role, define which Access Groups the role has security clearance for. An access group may be linked to one or more data access roles. In addition, define the **Users** that have access rights to these secured records. When you grant a data access role rights to an access group, you are giving all users in the data access role rights to all secured records in all the referenced access groups. A user may belong to many data access roles.

If your edge product supports row level security, it will include logic in the appropriate areas of the system to limit the secured rows that a user may view or maintain based on this configuration. For example, in Oracle Utilities Customer Care and Billing, throughout the system users are only able to view and maintain information about an account and any of its detail if the user is in a Data Access Role for the account's Access Group (or the account is not linked to an Access Group).

FASTPATH: Refer to your product's documentation for more information on row level security, if applicable.

Defining Access Groups

Refer to [The Big Picture of Row Security](#) for a description of how access groups are used to restrict access to specific objects.

Access groups control which groups of users (referred to as Data Access Roles) have rights to accounts (or other objects) associated with the access group. You can access the portal using **Admin > Security > Access Group**. You are brought to a query portal with options for searching for a specific access group. Once a record has been selected you are brought to the maintenance portal to view and maintain the selected record.

The **Access Mode** zone provides the information about the access group and its data access roles.

- The **Data Access Role** collection defines the data access roles whose users have access to the access group's secured objects. Keep in mind that when you add a **Data Access Role** to an **Access Group**, you are granting all users who belong to this role access to all of the objects linked to the access group.

NOTE: You can also use [Data Access Role - Access Group](#) to maintain a data access role's access groups.

- The **To Do Role Assignment** collection may be used to route To Do Entries of a given To Do Type to a specific To Do Role if the objects related to the To Do Entry are associated with the access group. Refer to [Adjusting the To Do Role](#) for more information.

Defining Data Access Roles

FASTPATH: Refer to [The Big Picture of Row Security](#) for a description of how access groups are use to restrict access to specific objects.

The data access role transaction is used to define two things:

- The users who belong to the data access role.
- The access groups whose accounts (or other objects) may be accessed by these users.

Data Access Role - Main

Select **Admin > Security > Data Access Role** to define the users who belong to a data access role.

Description of Page

Enter a unique **Data Access Role** code and **Description** for the data access role.

The scroll area contains the **Users** who belong to this role. A user's data access roles play a part in determining the accounts (or other objects) whose data they can access.

To add additional users to this data access role, press the add button and specify the following:

- Enter the **User ID**. Keep in mind that when you add a **User** to a **Data Access Role**, you are granting this user access to all of the accounts (or other objects) linked to the data access role's access groups.
- Use **Expiration Date** to define when the user's membership in this data access role expires.

NOTE: Also maintained on the user page. You can also use [User - Access Security](#) to maintain a user's membership in data access roles.

Data Access Role - Access Group

Select **Admin > Security > Data Access Role** and navigate to the **Access Groups** tab to define the access groups whose accounts (or other objects) may be accessed by the users in this data access role.

Description of Page

Use the **Access Group** collection to define the access groups whose objects can be accessed by this role's users. Keep in mind that when you add an **Access Group** to a **Data Access Role**, you are granting all users who belong to this role access to all of the accounts (or other objects) linked to the access groups.

NOTE: You can also use [Access Group - Main](#) to maintain an access group's data access roles.

Data Privacy

Personally Identifiable Information (PII) is any information that identifies or could be used in combination with other information to identify an individual. Many countries have data privacy laws governing the use of such information. A key aspect of these laws is an organization's obligation to erase personal information when there is no compelling reason to retain it. This obligation can be fulfilled either by deleting data or altering the data in such a way that it is no longer possible to associate the data with the individual.

Organizations are likely to have other legal obligations that impact how long they retain personal data. For example, there could be financial audit requirements that oblige the organization to retain relevant information for a fixed number of years after termination of a contract.

Object Erasure is designed to address right to erasure issues, with a combination of configuration and processes that may be extended to implement the appropriate policies for the PII within your data.

Encryption and Masking

"Encryption" refers to encrypting data stored in the database using an encryption key. There are two different types of encryption described in the sections below. System encryption refers to columns in the system identified by the product to use encryption. Application encryption refers to the ability for an implementation to configure fields and elements that should be encrypted in the database.

"Masking" refers to overwriting all or part of an un-encrypted field value with a masking character. For example, perhaps only the last 4 digits of a tax ID number are visible with the other digits changed to an asterisk. The system provides support for masking fields on the user interface that may be stored as plain text in the database. In addition, there are cases where encrypted fields are shown to the user interface using masked values rather than the encrypted value.

The following sections provide more information about each feature.

System Encryption

The system automatically encrypts certain fields captured in various option tables or context tables. This is mainly used for passwords. For example, passwords captured in Message Sender context or password

In addition, batch control supports configuring a security option for parameters that capture sensitive information, such as a password. Refer to [Defining Batch Controls](#) for more information.

It is also possible to enable system encryption using the characteristic type **F1-PWD**. However, the maintenance object must include specific code to enable system encryption for characteristics of this type. In Oracle Utilities Application Framework, the only maintenance object that supports this is extendable lookup. Refer to [Extendable Lookup Advanced Topics](#) for more information.

User Interface Masking

The functionality described in this section is used to take data that is stored in plain text in the database and mask the value before it is presented to a user (or an external system). This feature includes the ability to allow some users to view the data unmasked using security configuration. The system allows different masking rules to be applied to different fields. For example, a credit card number can be masked differently than a social security number.

The following topics describe how to mask field values.

Identify the Data to be Masked

Identify the data that is stored as plain text, but should be masked for display to users. For example, imagine that you have identified that Credit Card Numbers and a person's federal ID number (for example, in the United States, the Social Security Number or SSN). Each field identified may be displayed and maintained in different user interfaces throughout the system, but the masking rules for a given field are probably uniform regardless of where the data is displayed.

Primary keys cannot be masked. A field defined as a unique identifier of a row cannot be configured for masking. Masking a field that is part of the primary key causes a problem when attempting to update the record. This restriction also applies to elements that are part of a "list" in an XML column on a maintenance object. One or more elements in the list must be defined as a primary identifier of the list. Be sure that primary key elements in the list are not ones that require masking.

List members that contain different "types". Consider a page with a list that contains a person's identification numbers. You can set up the system so that a person's social security number has different masking rules than their drivers license number. If your implementation has this type of requirement, the list of masked fields should contain an entry for each masking rule.

For each field, if there are some users that may see the data unmasked on one or more of the user interfaces, then security configuration is required. If the value of a field should be masked for all users across all pages in the application, then the security configuration is not needed.

Security Configuration

Define a [security type](#) for each field with two authorization levels:

- **1** - Can only see the element masked
- **2** - Can only see the element unmasked

Link all of the security types to an [application service](#) of your choosing. We recommend linking every masking-oriented security type to a single application service (e.g., **CM_MASK**) as it makes granting access easier.

For each security type, identify which users can see its data unmasked and which users can only see its data masked. If the masked and unmasked users fit into existing user groups, no additional user groups are necessary. Otherwise, create new user groups for the masked and unmasked users.

After the user groups for each security type are defined, link each user group to the application service defined above. When a user group is linked to the application service, you will define the authorization level for each security type linked to the application service. If a user group's users should see the security type's field values unmasked, set the authorization level to 2; otherwise set it to 1.

NOTE: Flush the cache. Remember that any time you change access rights you should [flush the security cache](#) (by entering flushAll.jsp on the URL of the application) if you want the change to take effect immediately.

Configure a Masking Algorithm

A data masking algorithm (using the algorithm entity value of **Feature Configuration - Data Masking**) must be created for each combination of masking rules and security type. These algorithms determine if a user has the rights to view a given field unmasked, and, if not, how the field should be masked.

The base package provides the algorithm type **F1-MASK** whose parameters are designed to handle most masking needs. If certain users may see the data unmasked, parameters capture the application service, security type and authorization level defined above used to evaluate this. In addition, parameters allow you to configure how much of the data to mask, what masking character to use. Refer to the algorithm type description for more information.

Determine How the Fields are Displayed

The masking configuration differs based on how a field is retrieved for access to the user interface. So for the masking of one “logical” field (like a person’s SSN), there may be multiple configuration entries required to cover all the access methods. Review each user interface where a given field is displayed and create the following categories:

- The field is an element that is retrieved by invoking a business object, a business service, or a service script
- The field is displayed on a fixed maintenance page (and is therefore retrieved by invoking a page service)
- The field is displayed on a fixed search page (and is therefore retrieved by invoking a search service)
- The field is stored as an ad hoc characteristic

Create a Feature Configuration for Each Masked Element

Create a feature configuration with a Feature Type of **Data Masking**. An option entry with option type of **Field Masking** is needed for every combination of field to mask and the method used to display the data. The value will contain mnemonics that reference the appropriate data masking algorithm along with configuration that differs depending on how the field is retrieved for display as described below.

Schema Based Object Field Masking

For data that is accessed via a schema-based object call and displayed in a UI map, the field to be masked must reference a meta-data field name in its schema definition: **field="fld_name", alg="algorithm name"**

If the element references an mdField in the schema, that is the field used to identify the masking rule. If there is no mdField reference but only a mapField reference, that is the field used to identify the masking rule. For example, if you want to mask a credit card number, let's assume that field is defined in the schema is the following:

```
<creditCard mdField="CCNBR" mapField="EXT_ACCT_ID"/>
```

In this case, the option value should be **field="CCNBR", alg="algorithm name"**. An option value of **field="EXT_ACCT_ID", alg="algorithm name"** would not result in masking.

A "where" clause may also be specified. This is useful for data that resides in a list where only data of a certain type needs to be masked: **field="fld_name", alg="algorithm name", where="fld_name='value'"**

For example, person can have a collection of IDs and only IDs of type 'SSN' (social security number) should be masked. If the person data including its collection of person IDs is displayed on a UI map via a business object call, let's assume the collection is defined in the following way:

```
<personIds type="list" mapChild=CI_PER_ID">  
  <isPrimaryId mapField="PRIM_SW"/>  
  <idType mapField="ID_TYPE_CD"/>  
  <personIdNumber mapField="PER_ID_NBR"/>  
</personIds>
```

The option value may look like this: **field="PER_ID_NBR", alg="algorithm name", where="ID_TYPE_CD='SSN'"**

Please note the following important points for schema based masking:

- **Limitation of 'where' field** Although the main use of a 'where' clause for schema oriented elements is to mask certain elements in a list based on a 'type', it is also possible to mask a single field in the schema based on the value of another field. For example, imagine that a customer submits a registration form that defines an ID type and ID value. Although this data is not in a list, the implementation may still want to only mask the ID value if the ID type is "SSN". The framework is only able to mask an element in the schema based on a 'where' clause if the element in the 'where' clause is a "sibling" in the schema.
 - If the element to be masked is in a list, the element in the 'where' clause must be in the same list.
 - If an element to be masked maps to a real column in a table, the element in the 'where' clause must also map to a real column in the table.
 - If an element to be masked maps to an XML column in the table as a single element, the element in the 'where' clause must map to the same XML column as a single element.
- **Multiple feature option entries for the same field.** It's possible that different schemas in the system have a similar type of data that may be masked based on different conditions. For example, imagine that an implementation has different schemas that captured or referenced person identifiers in different ways:
 - One schema captures a single person ID without any corresponding "type" record and it should always be masked using Algorithm CM_SSN_MASK:

```
<personSSN mapXML=BO_DATA_AREA mdField=PER_ID_NBR/>
```

- One schema captures a person ID and a corresponding ID Type and it should be masked with Algorithm CM_SSN_MASK if the type is "SSN" and masked with algorithm CM_FEIN_MASK if the type is "FEIN".

```
<personIdType mapXML=BO_DATA_AREA mdField=ID_TYPE_CD/>  
<personId mapXML=BO_DATA_AREA mdField=PER_ID_NBR/>
```

- One schema captures a person ID and a corresponding ID Type and it has the same masking rules as the previous schema, but a different field name is used for the ID Type code. (This scenario could happen if for example a different label is desired for ID Type on the user interface for this schema.)

```
<personIdType mapXML=BO_DATA_AREA mdField=CM_ID_TYPE/>
```

```
<personId mapXML=BO_DATA_AREA mdField=PER_ID_NBR/>
```

For this scenario, the feature options may look like this:

1. **field="PER_ID_NBR", alg="CM_SSN_MASK"**
2. **field="PER_ID_NBR", alg="CM_SSN_MASK", where="ID_TYPE_CD='SSN'"**
3. **field="PER_ID_NBR", alg="CM_FEIN_MASK", where="ID_TYPE_CD='FEIN'"**
4. **field="PER_ID_NBR", alg="CM_SSN_MASK", where="CM_ID_TYPE='SSN'"**
5. **field="PER_ID_NBR", alg="CM_FEIN_MASK", where="CM_ID_TYPE='FEIN'"**

For each schema, the system will first find whether the element applies to any masking option. It will find 5 masking options for the field PER_ID_NBR. Then it will determine if any sibling elements match the 'where' clause.

- If more than one sibling element matches a 'where' clause, a runtime error is issued. For example if a schema has an element that references "mdField=ID_TYPE_CD" and an element that references "mdField=CM_ID_TYPE", this is an error. Additionally, if multiple elements reference mdField=ID_TYPE_CD", this is an error.
- If one and only one sibling element matches a 'where' clause, the value of the element is compared to the values defined in the 'where' clause. If it finds a match on the value, the appropriate masking algorithm is applied. If no match is found (for example, the Person ID Type is "LICENSE") the element is displayed as is.
- If no sibling element matches a 'where' clause and a feature option exists with no 'where' clause (option 1 above), then the masking algorithm of the option with no 'where' clause is applied.
- **Changing the value in the 'where' clause.** If your implementation has some users that are allowed to change records where some data is masked based on a condition, it is recommended to design the user interface to reset the masked value when the value in the 'where' clause changes. For example, if a user is prevented from viewing a person's social security number, but the user is allowed to make updates to the person's record, changing the value of the Person ID Type should reset the Person ID Number. This would ensure that the user does not 'unmask' the social security number by simply changing the ID Type.

Records Maintained Using Page Maintenance

For data that is accessed via a page maintenance service call, indicate the table name and the field name where the data resides: **table="table_name", field="fld_name", alg="algorithm name"**

For example if the Person record and its collection of identifiers are displayed and maintained using page maintenance, the option value should be **table="CI_PER_ID", field="PER_ID_NBR", alg="algorithm name"**

A "where" clause may also be specified: **table="table_name", field="fld_name", where="fld_name='value'", alg="algorithm name"**

This is useful for data that resides in a child table where only data of a certain type needs to be masked. For the person ID example, **table="CI_PER_ID", field="PER_ID_NBR", alg="algorithm name", where="ID_TYPE_CD='SSN'"**

Characteristic Data

For data that is stored as a characteristic, simply indicate the characteristic type: **CHAR_TYPE_CD='char type', alg="algorithm name"**

This needs to be defined only once regardless of which characteristic entity the char type may reside on. Note that only ad-hoc characteristics are supported.

Masking Fields in Explorer Zones or Info Strings

In explorer zones data is often retrieved using SQL directly from the database. No masking is applied automatically in this case. If there is data in the explorer zone results that should be masked, the masking must be applied by calling a business service.

Similarly, an MO Info algorithm may not use BO interaction to get data. It may access data using SQL for efficiency purposes. No masking is applied when retrieving data via SQL. To apply masking to a string prior to including it in an info string, the masking must be applied by calling a business service.

The system supplies two business services to be called to determine if masking rules apply for a specific field.

- **F1-TableFieldMask.** Mask a Table field. This business service receives a table name, field name and one or more field values. If masking applies it returns the masked value.
- **F1-SchemaFieldMask.** Mask a Schema field. This business service receives a schema name and type, XPath and field value. If masking applies it returns the masked value.

Search Service Results

For data that is displayed on a 'fixed' search page, it is retrieved via a search service call. Indicate the search name and the appropriate field to mask along with the masking algorithm. For example: **search="SearchServiceName", field="PER_ID_NBR", where="ID_TYPE_CD='SSN'", alg="algorithm name"**

To find the name of the search service, launch the search in question, right click in the filter area and choose **Inspect**. Search for "serviceName". The service name is listed there. To find the field name to mask, search for "Widget Info". There should be two results found, one for the filter area and one for the results area. This results area has the text "SEARCH_RESULTS" as prefix for each field. The field names are the ones after the x\$. Do not reference the x\$ when defining the field name. Note, the "where" statement can only apply to fields that are also part of the search results.

Additional Masking Information

The following points provide additional information to assist in your masking configuration:

- If the demonstration database includes a **Data Masking** feature configuration, review the settings because it will probably contain masking rules that will match your own.
- On data input pages, a user might be able to enter or change masked data, such as a bank account number, but not be able to subsequently see what they added or changed.
- External systems can request information by performing a service call via a web service. Please keep in mind that some web service requests require data to be masked and some do not. For example, a request from an external system to synchronize person information needs the person's social security number unmasked; whereas a request from a web self service application to retrieve the same person information for display purposes needs the person's social security number masked. To implement this type of requirement, different users must be associated with each of the requests and these users must belong to separate user groups with different access rights.
- If a maintenance object (MO) contains a field that holds an XML document and a service call invokes the MO's service program directly, the system will mask individual XML elements in the field if a **Determine BO** algorithm has been plugged into the [maintenance object](#) and the element(s) in the respective BO schema have been secured as described above.

Application Encryption

The functionality described in this section allows implementations to configure fields to encrypt when storing it in the database. This functionality is mutually exclusive from the User Interface Masking functionality described in the previous section. This feature supports encrypting specific elements stored within a CLOB or XML column.

The following points highlight the features of the encryption functionality:

- The encryption key is defined using a keystore, which must be set up in order to use this functionality. For details about setting up the keystore in the system, see the Installation Guide.
- When a field is configured to be encrypted, the encrypted data is stored in a special encryption field that is not the source field (the one exposed to the user on the user interface). The source field captures the data as masked. Because a special field is required to support encryption, the product must provide support for that field to be encrypted.

- For encrypted data that must allow searching, the system supports capturing a hash value in a special field. The product must provide support for this functionality. Besides providing a special field to capture the hash value, base search functionality for that data must also cater for this configuration.
- The system supports encrypting data that is captured as an element within an XML field. If the XML field is provided in a schema owned by the product, then the product must provide specific support for the capture of the encrypted data.

The following sections provide additional information about the support for encryption provided by the framework. Refer to the security chapter of the administration guide for your particular product for more information.

Encrypting and Masking the Data

When a product enables encrypting for a given type of data, a special encryption field should be created to capture the encrypted value. Because encrypting is optional, the source field (the one exposed to the user) should not be this special encrypted field. If encryption is configured, the system will internally populate the encrypted field. The source field will be populated with asterisks by default. That way the masked data is what is shown to the user on page rather than the encrypted value.

The following points highlight how the system behaves when encryption is configured and when it is not. Assume as an example, the field is a credit card number. The user views and populates a field with the field name `CC_NBR`. The table also has a second field `ENCR_CC_NBR`. A user populates the credit card number:

- If encryption is not configured, `CC_NBR` will be updated with the entered credit card number and `ENCR_CC_NBR` will be empty. Note that in this case, an implementation may choose to configure [user interface masking](#).
- If encryption is configured, `CC_NBR` will be updated with ‘*****’ and `ENCR_CC_NBR` will contain the encrypted value. The asterisks for the standard field will fill the full field size up to 50 characters.

If for some reason the standard masking using all asterisks is not desired, the system supports supplying an explicit masking algorithm using the same Feature Configuration - Data Masking plug-in spot used for [User Interface Masking](#).

WARNING: Unlike user interface masking, the masking of encrypted fields is not driven by security. The data stored in the source field for all encrypted data should be masked. Be sure not to configure security authorization logic in algorithms used for this type of masking.

Feature Option Configuration

Create a feature configuration with a Feature Type of **Encryption**. For each source field you are encrypting, enter an option with option type of **Field Encryption**. The value will contain mnemonics that reference the appropriate encryption key alias defined in the keystore along with configuration related to the field and its table location. Unlike the user interface data masking, the configuration for data encryption is related to how the data is stored rather than how it is displayed. In addition, each entry may define an explicit masking algorithm to override the default and if supported, may also define a hash field and hash alias.

For data that is stored in a specific column on a table, an explicit field to capture the encrypted value must exist. Indicate the table name, source field name and encrypted field name along with the alias: **table='table_name', field='fld_name', encryptedField='encr_fld_name', alias='alias key'**

A "where" clause may also be specified when data resides in a child table and only data of a certain type needs to be encrypted.

Example, **table='CI_PER_ID', field='PER_ID_NBR', encryptedField='ENCR_PER_ID_NBR', alias='key alias', where='ID_TYPE_CD='SSN''**

For data that is stored in an XML column in a record, the source field to be encrypted must reference a meta-data field name in its schema definition along with the element that captures the encrypted data and the alias: **field='field_name', encryptedField='encr_field_name', alias='key alias'**

The syntax for adding a reference to a masking algorithm is **maskAlg='algorithm name'** .

The syntax for adding configuration for capturing a hash value for searching purposes is **hashAlias='hashAliasKey' hashField='HASH_FLD_NAME'**.

The following is an example of configuration that uses all the possible options (specific masking algorithm, where clause and hash field support):

```
table='CI_PER_ID', field='PER_ID_NBR', alias='aliasKey', encryptedField='ENCR_PER_ID_NBR',  
hashAlias='hashAliasKey' hashField='HASH_PER_ID_NBR', where='ID_TYPE_CD=SSN', maskAlg='CM-  
PERIDMASK'
```

Searching by an Encrypted Value

If the product supports a hashed value for an encrypted field for searching purposes, the following points highlight explorer zone configuration for this purpose

- The user filter value should reference the source field and should include an additional **encrypt=** mnemonic. For example

```
type=STRING  
label=PER_ID_NBR  
encrypt=[CI_PER_ID, PER_ID_NBR, ID_TYPE_CD, F1]
```

Refer to [User Filters](#) for more information.

- The SQL should include the hashed value in the WHERE clause. Note that because encryption is optional, a product zone that includes searching by a field eligible for encryption will include finding a match for the filter in the source field (as plain text) or in the hashed field. For example:

```
WHERE  
[(F2) (ID.PER_ID_NBR = :F2 OR ID.HASH_PER_ID_NBR = :F2)]
```

Customizing Encryption Algorithm

Although the encryption algorithm to use with a given key can be gleaned from the key in the keystore, there is sometimes extra information associated with an algorithm that might need to be used to encrypt or decrypt data.

The system provides a feature configuration option for the **Encryption** feature type using the option type **Algorithm Info** that can be used to adjust the behavior of the encryption.

- You can modify the default mode and padding of the encryption algorithm.
- If a key will be used to digitally sign anything, the signing algorithm can also be specified for the key.

For details about the syntax, refer to the feature option type's detailed description.

The Approach to Implementing Object Erasure

This section describes the product approach to implementing object erasure for its maintenance objects (MOs).

NOTE: The approach outlined is intended for managing erasure of master data objects. The assumption is that Information Lifecycle Management will be used for archiving any related transactional data.

Various events in the system may signal the need to erase data at some future date. For example, closing an account may indicate the need to erase both the account and person data once there is no longer a need to maintain related financial details. There may also be events that re-establish the business relationship with a person and signal that data marked for erasure should now be retained.

The Object Erasure Schedule is used to capture key details of objects with data that needs to be erased. Records in the schedule are monitored periodically to determine if the date for erasure has been reached and if so, execute the erasure logic. The system will create and maintain records in the schedule when specific events occur for an MO that is marked for erasure.

The system provides the ability to mark an MO as eligible for erasure via a number of MO configuration entries. Included in these is an option that defines the business object for the MO's erasure schedule records. In addition to defining the erasure record elements, this BO defines the monitoring process and the specific erasure logic for the MO.

The following sections provide more information about configuring and managing object erasure.

Configuring a Maintenance Object for Erasure

There are three types of maintenance object configuration entries that define how to manage erasure:

- An option to define the business object for erasure schedule records.
- An option to define the period between the date on which the need for erasure is detected and the date on which erasure should occur. The common logic provided by the system to add or update erasure records uses this option to determine the erasure date.
- One or more entries in the MO algorithm collection for the algorithms that determine whether a record should be scheduled for erasure, according to the current state of the record, and create or update the erasure schedule entries.

Some MOs that would commonly be regarded as eligible for erasure will be installed with a base Erasure BO already configured. The expectation is that the corresponding Erasure Period option and the algorithm for the Manage Erasure Schedule plug-in spot will be set up by your implementation with the appropriate entries for your organization's business rules.

NOTE: The presence of an Erasure Period option is the signal to the system that your implementation has enabled an object for erasure.

It may not be necessary for all master data objects that contain personally identifiable information to manage their own erasure schedule. For example, the event which triggers erasure for a person record may also trigger the creation of erasure schedule entries for the person's other master data records. In this case, only the person maintenance object will need to be configured with a Manage Erasure algorithm (or algorithms). Refer to your product specific documentation for more information on the recommended approaches for your product's master data objects.

Manage Erasure Schedule Algorithm

Algorithms of this type are responsible for determining a record's erasure status and creating or maintaining an entry in the Object Erasure Schedule for the record. They are triggered when certain events occur in the system for maintenance objects that are eligible for erasure. Multiple algorithms can be configured for the plug-in spot.

Depending on the determination made by the algorithm (or algorithms), a number of different actions may need to be taken. For example:

- A new schedule record may need to be added
- An existing schedule record may need to be updated with a new erasure date
- A pending record may need to be discarded if erasure is no longer applicable
- A discarded record may need to be reactivated if erasure now applies again

The base business service **F1-ManageErasureSchedule** performs the common logic to handle the possible actions and is recommended for use by these types of algorithms. The service can also optionally create a log entry for information purposes. Refer to the description of the business service for full details.

In certain circumstances, if one record is scheduled for erasure, other related records may need to be evaluated. The base business service **F1-ManageErasureScheduleDriver** performs the logic to execute an MO's Manage Erasure Schedule algorithms. It can be used to manage any related records from within another algorithm.

This type of algorithm is plugged into the [Maintenance Object — Algorithm](#) collection.

Your product may supply algorithms to manage the schedule for base MOs that are regarded as eligible for erasure. If your organization has special business rules that are evaluated to determine the erasure schedule for an MO, a custom algorithm can be created and applied by the implementation team.

Monitoring the Schedule and Performing Erasure

The erasure schedule is managed using the lifecycle of the erasure record's business object. A deferred monitor process is used to periodically check for records that are due for erasure and transition them from the 'pending erasure' state to the 'erased' state. An enter plug in on the 'erased' state is responsible for performing the erasure logic.

The system provides a 'root' business object for the object erasure schedule (**F1-ErasureScheduleRoot**) which defines the lifecycle that erasure schedule business objects should follow. The system also provides a monitor process (**F1-OESMN**) which is configured on the 'pending erasure' state of the 'root' business object. This process is configured to monitor object erasure schedule records whose erasure date is on or before the batch business date.

Maintenance objects that are eligible for erasure should be configured with an erasure schedule business object that uses the 'root' business object as its parent. The algorithm that performs the erasure processing applicable to that maintenance object must be plugged in on the 'erased' state of the 'child' business object.

The system provides an erasure schedule business object (**F1-ErasureScheduleCommon**) which is designed to erase an object by deleting the main record and any child records. Your product may supply additional erasure schedule business objects for certain use cases. Refer to your product specific documentation for more information.

Erasing User Information By Obfuscation

Some implementations consider the base User object to have personally identifiable information. Erasing user information by deleting the records is not advisable as it can cause referential integrity problems. The recommended approach is to obfuscate the data instead.

The system provides a user erasure business object (**F1-ErasureScheduleUser**) which is designed to support obfuscating a user's identifiable information by removing it or replacing it with a non-identifiable value if the field is required.

If the User maintenance object is configured to be eligible for erasure in your implementation, the manage erasure schedule algorithm for the record will be invoked whenever the **Enable** flag is changed for a record on the User maintenance page. The system provides a base algorithm (**F1-OBJERSUSR**) specifically for the User MO. This algorithm will add an entry to the object erasure schedule if the user record is disabled or deactivate an existing erasure schedule record if a disabled user record is enabled again.

Viewing an Object's Erasure Status

The system provides a portal for viewing and editing an erasure schedule record. The portal is accessed from the **Object Erasure Schedule** dashboard zone. This is a context sensitive zone which only appears when accessing a record for a maintenance object that is configured to be eligible for erasure. It displays the information for the erasure schedule entry for the record in context, if applicable.

To add the zone to an eligible maintenance object:

- Navigate to [Context Sensitive Zone](#) and search for the navigation key for the maintenance object.
- Add the Object Erasure Schedule zone **F1-OBJERSRSCD** to that navigation key.

Viewing Erasure Configuration

The Erasure Configuration [All-in-One portal](#) provides the ability to view the maintenance objects that are marked as eligible for erasure and maintain their erasure configuration entries in a single place.

To view a list of the eligible MOs, open **Admin > Security > Erasure Configuration**.

Press the edit icon to open a window in which the configuration values for that row can be changed.

Refer to [The Approach to Implementing Object Erasure](#) for an overview of object erasure configuration.

Archiving the Object Erasure Schedule

The system provides the ability to archive older records in the object erasure schedule using Information Lifecycle Management. The object erasure schedule maintenance object is configured with a base ILM eligibility algorithm and an ILM crawler batch control.

The base object erasure schedule BO is configured to set the ILM archive switch when an erasure schedule record enters a final state and to reset it if the record becomes active again.

Refer to [The Approach to Implementing Information Lifecycle Management](#) for more information on archiving functionality.

Data Redaction on Export

Personal identifiable information (PII) requires special handling when exported out of the application and written to files. Information that is encrypted at the database level remain encrypted and therefore protected when exported. With respect to non-encrypted information, the need to obfuscate it for added protection depends on how the exported data is intended to be used. If the exported information is part of an integration flow with an external system then the data should remain unchanged. However, when exporting data from a production environment for testing purposes sensitive information should be anonymized before they can be imported to a lower environment.

The following are key aspects of this functionality:

- Redaction rules define how specific fields should be redacted when exported.
- When redaction rules exist, data redaction is performed by default by specific export tools. In absence of redaction rules, data is exported in its original form.
- Redaction rules are customer specific and may only be relevant to environments that contain sensitive data. As such, they are not released with the base product. Review your data redaction requirements and configure appropriate rules in relevant environments.
- Certain users may be allowed to export data in a non-redacted form based on application security.

The following sections provide additional information about this topic.

Redaction Rules Are Customer Specific

Redaction rules identify which fields should be redacted and how they should be anonymized. The list of fields to redact and the function to use to manipulate their values are customer specific and therefore are not released with the base product. A sample set of rules are provided as accelerator data for reference only.

It is important that you review your data redaction requirements and configure rules that reflect your business needs.

Redaction By Default

Processes that support data redaction on export do so by default when redaction rules exists. When rules are not defined, data is exported as is. Note that for this reason it is unnecessary to define such rules in lower environments that do not contain sensitive information.

Specific Export Tools Only

Data redaction is supported by the following export tools only:

- **Content Migration Assistant (CMA).** Depending on application security, a user may indicate on a specific data set export request that data should be exported in its original form.
- **General Data Export (GDE) batch processes.** A batch parameter may be used to explicitly request that data is exported in its original form. This option is also protected by application security and enforced at batch submission time.

NOTE: This type of process establishes a single export stream that may be sent to multiple targets. Review these integrations to ensure they do not have conflicting data redaction requirements and set the batch parameter accordingly.

Different Types of Redaction Rules

Sensitive information may reside in various types of storage fields which impact the way they are identified for redaction. You may define rules that target fields on specific tables or provide a more global rules that applies to all references of a specific field.

The application supports the following types of reduction rules:

- **Physical Field.** This type of rule applies to a value residing in a field on a specific table. An optional filter expression may be provided when only records of a certain type needs to be redacted.
- **XML Storage.** This type of rule applies a value associated with the specified field name that resides within an XML storage field on a specific table. This option also supports a filter expression.
- **Reference Field.** This type of rule applies to a value residing anywhere and associated with the specified field name. It does not include fields referenced in XML storage fields.

Redaction Function

A redaction function defines the format by which a value is anonymized. The type of function used depends on the field's data type. For example, to anonymize a numeric field the redaction function should only use numeric values etc.

Refer to the **Redaction Function** extendable lookup for a list of available functions. The base product provides a sample of common functions but the list may be extended by your organization as needed.

Fields May Contain Sensitive Information

The field definition record includes an indication as to whether the field may contained sensitive information or not. Note that the indication does not imply that the field is actually used to capture such data but rather that it can potentially be used this way. Use this indication to review fields that may need to be associated with a redaction rule.

Exporting Non-Redacted Data Requires Security Rights

By default, the aforementioned export tools redact data by default based on existing redaction rules. There are situations where certain users may be allowed to export data in its original form, i.e. request to not apply the redaction rules.

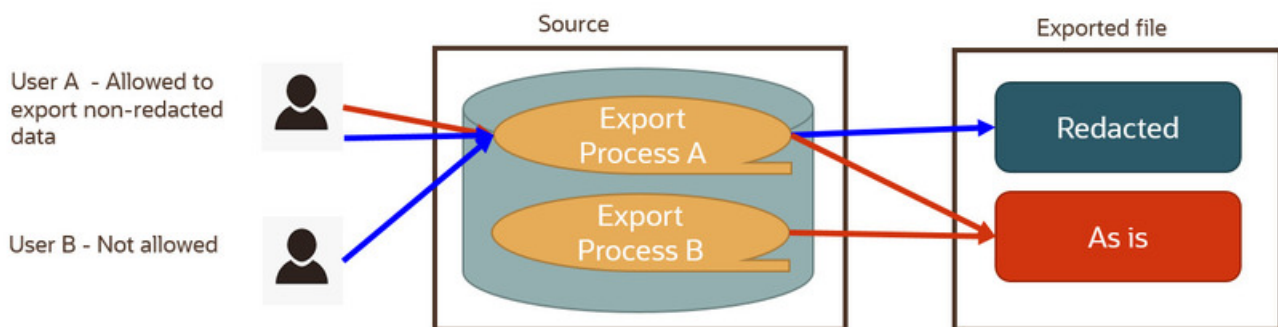

The following points briefly describe the above illustration:

- Some processes always export data as is, i.e. the target consumer needs the raw data. This is irrespective of the user requesting the export.
- Some processes perform data redaction by default and may offer an option for exporting data as is. The option to export data in its original form is secured by application security.

- In this example, process A supports data redaction by default with an option to export non-redacted data. User A has the right to export the data redacted (default) or explicitly request to export it in its original form. User B does not have the right to do so hence their export content is redacted by default.

The option to export data in its original form is associated with the **Do Not Apply Redaction Rules** access mode associated with the following relevant application services:

- For CMA, the additional access mode is associated with the migration data set export's application service. When granted, the user may select the special non-redacted export option when they create the export data set request.
- For GDE batch processes, the access mode is associated with their application service and is tied to the **Do Not Apply Redaction Rules** batch parameter they support. Only users with the proper application security can submit these batches using the special batch parameter option

Defining Redaction Rules

This portal is used to view and maintain rules that define how specific fields that containing personal information should be redacted when exported out of the application. For example, an e-mail address may be redacted by replacing some or all characters with '*'.

Refer to [Data Redaction on Export](#) for more information.

You can access the portal from the **Admin Menu > Security > Redaction Rule**. You are brought to a query portal with options for searching for a specific redaction rule. Once a redaction rule has been selected you are brought to the maintenance portal to view and maintain the selected record.

The following zones may appear as part of the portal's **Main** tab page

- **Redaction Rule.** This zone provides information about the selected rule.

Obfuscation Configuration

This portal is used to view and maintain all configuration options related to personal information obfuscation. It includes all masking, encryption and data redaction rules.

You can access the portal from the **Admin Menu > Security > Obfuscation Configuration**.

Refer to [Encryption and Masking](#) for more information.

The following zones may appear as part of the portal's **Main** tab page

- **Redaction Rules.** This zone lists all redaction rules. You may add a new rule from this zone.
- **Masking.** This zone lists masking options. You may navigate to the masking related feature configuration to review and edit these options.
- **Encryption.** This zone lists encryption options. You may navigate to the encryption related feature configuration to review and edit these options.
- **Review Fields for Redaction Rules.** This zone lists fields that may contain personal identifiable information and are not associated with a redaction rule. Review these fields and add redaction rules when applicable.

Cryptography Keys

Often when communicating information with an external system, cryptography keys are used to exchange encrypted information or confirm that the two communicating parties recognize each other and the information being provided.

The following sections include information about the functionality provided to support this type of security.

Understanding Key Rings

Cryptography keys may be used to provide a signature or credentials to a request so that the system recognizes that the request comes from a trusted party. Keys may also be used to encrypt or decrypt files shared between two parties.

The Key Ring object is provided to reference the keys that are used over time for a given business use case. Only one key or key pair may be active at any given time.

The following sections include information about the functionality provided to support different key ring classes for particular use cases.

RSA Signature Keys

RSA signature key pairs are used in the following cases:

- Certain processes in the system may need to write files to or read files from Oracle Cloud Object Storage. Cloud object storage has its own method for encrypting files, and products using the framework application do not need to define additional configuration for that. However, when communicating with cloud object storage, the application is required to provide a signature key.

Refer to [External File Storage](#) for more information about configuring the system to connect to cloud object storage.

- Customers may need the ability to authorize a customer service representative (CSR) to view the customer's account information in a customer facing portal. A signature key is required to support secure communication with the endpoint.

Refer to [User Redirection](#) for more information about configuring the system to enable this type of redirection.

The product provides an RSA Signature Key Pair business object that supports the following functions:

- Generating a key pair, public and private. The private key is stored in an appropriate "secret store" and the public key is available to copy and share with a third party.
- Viewing the public key, allowing a user to copy it to register it with cloud object storage.
- Activating the new key pair (to be done after registering the new public key).
- Inactivating an expired key.
- Key rotation. For increased security, a new key pair should be generated periodically.
- Deactivating all keys for the key ring.

OAuth Keys

The system provides support for sending messages secured by OAuth authentication. To deliver the message, the application is required to provide a client ID and secret. The OAuth secret is sensitive data and needs to be stored securely in the application. The Message Sender configuration provides the ability to store the client ID and an encrypted secret directly in the sender context. Alternatively, the sender context can refer to a key ring that stores those details. Using a key ring allows users to apply new secrets over time without having to update the affected message sender configurations.

Refer to [Message Sender - Context](#) for more information about configuring a message sender for OAuth security.

The product provides an OAuth Keys business object that supports the following functions:

- Defining the external system related to the key ring
- Adding a client ID and secret key. The secret key is stored in an appropriate "secret store".
- Key rotation. For increased security, a new secret key may be entered periodically. The new key automatically becomes the active key.

File Encryption and Signing Keys

For security, files exchanged with third parties may be encrypted, digitally signed or both. This requires the sender and recipient to maintain public/private key pairs and share public keys. The product supports the maintenance and generation of public and private keys in a format suitable for encryption using PGP standards.

The following sections provide additional information about encryption keys.

Encryption Key Pairs

Internal encryption key pairs are used in the following cases:

- Creating a digital signature for an extract file. The signature is encrypted with the private key of the key pair and decrypted by the recipient using the shared public key .
- Decrypting an import file. The expectation is that the sender has encrypted the file data using a temporary key. The temporary key is encrypted using the shared public key and decrypted using the private key.

The product provides an Encryption Key Pair business object that supports the following functions:

- Generating a key pair, public and private. The private key is stored in an appropriate "secret store" and the public key is available to copy and share with a third party. Both keys are in formats suitable for PGP encryption.
- Viewing the public key, allowing a user to copy it to register it with third parties.
- Activating the new key pair (to be done after sharing the new public key).
- Inactivating an expired key.
- Key rotation. For increased security, a new key pair should be generated periodically.
- Deactivating all keys for the key ring.

Public Encryption Keys

External public encryption keys are used in the following cases:

- Verifying the signature of an imported file. The signature is decrypted using the public key provided by the sender.
- Encrypting an extract file. The batch file adapters create a temporary key which is used to encrypt the file data. The temporary key is encrypted using the public key provided by the recipient

The product provides a Public Encryption Key business object that supports the following functions:

- Defining the external system and reference ID related to the key ring.
- Adding a public key to the key ring. The product expects the public key to be in a format suitable for PGP encryption.
- Viewing the public key.
- Inactivating an expired key.
- Key rotation. When new public keys are provided by the external system, the previously active key is set to expiring status. It may be manually inactivated after all messages using that key have been processed.
- Deactivating all keys for the key ring.

Defining Key Rings

Refer to [Understanding Key Rings](#) for an overview of key ring functionality.

To maintain the key rings applicable to your product or implementation, open **Admin > Security > Key Ring**.

This is an [All-in-One portal](#) and includes the standard List and display zones for a key ring.

The information captured on the key ring depends on the business objects supported by your product or implementation. Refer to the embedded help text for more information.

Key Zones

The key zones provide information about the keys that are associated with the key ring. The zones displayed and the available actions depend on the type of key. Refer to embedded help for more information.

Key Rotation

For internal keys, it is recommended to practice key rotation and generate new keys periodically. New key pairs are generated in the **Pending** state. The user should register the public key of the new key pair with the associated third party. Once that is done, the new key should be activated.

For external keys, new public keys are added in the **Active** state. The previously active key is set to **Expiring** and may be inactivated when no further processing needs to refer to it.

User Interface Tools

This section describes tools that impact many aspects of the user interface.

Understanding Portals and Zones

A portal is a page that is comprised of one or more information zones. The base product pages are built using either a fixed page metaphor or using portals and zones.

There are three broad classes of portals:

- **Standalone.** Standalone portals are separate pages where the main tab of the page is built using a portal. These pages are opened using any of the standard methods (e.g., by selecting a menu item, by selecting a favorite link, etc.). Additional tabs for a stand-alone portal may be included using tab page portals.
- **Tab Page.** These types of portals cannot be attached to a menu. They simply define the zones for a tab on a standalone portal.
- **Dashboard.** The dashboard portal is a special portal that appears in the [Dashboard Area](#) on the user's desktop. Its zones contain tools and information that exist on the user's desktop regardless of the transaction. There is only one dashboard portal. This portal and several zones are delivered as part of the base-package. Your implementation can add additional zones to this portal. Please contact customer support if you need to add zones to the dashboard portal.

The contents of this section describe general information about portals and zones.

Portal Page Structure

A portal page has a main tab and may have additional tabs. The page is constructed by first creating a **Standalone** portal, which is also the main portal, followed by creating a **Tab Page** portal for each additional tab and linking it to the main portal. Content is organized on each tab using independent zones.

The entire page is secured by the single application service associated with the main portal.

Portals Are Made Up of Zones

A portal is a page that contains one or more zones, and each zone contains data of some sort. All zones reference a **Zone Type**. The zone type controls the behavior of the zone and the parameters available to configure the zone.

Not All Zones Make Up Portals

Zones may or may not be associated with a portal. The following describes additional uses of zones:

- A data explorer type of zone may implement a search for an entity on an input user interface map. These zones may be referenced on a FK reference record or directly referenced on a UI map.
- A data explorer type of zone may implement a Business Service. The latter may be used for an internal process or used to build a user interface dropdown.
- A zone may be defined as a **Context Sensitive Zone** that appears on the Dashboard when a specific page or portal is in context. This type of zone is not linked to the Dashboard portal but associated with the context page or portal's navigation key.

Configuring Zones for a Portal

The portal includes configuration of how the zones should appear on the portal by default. This includes the following options, all of which may be overridden by an implementation.

- The order in which the zone should appear. An implementation may configure an override sequence to change the order zones on a base delivered portal.
- Whether the zone is visible on the portal. Zones delivered in the base product should be configured to be visible. But an implementation may override this if desired.
- Whether the zone should display initially collapsed or not. A zone's data is only retrieved when it is expanded. As such, a zone may be configured to be initially collapsed when the data is not needed very often. A user can expand the zone when the information is required. Implementations may change the collapsed setting of a base product portal / zone. Refer to [Zones May Appear Initially Collapsed When a Page Opens](#) for more information.

Flexible Layout Control

By default a zone spans the full width of the portal's display area but can be configured in a number of ways using the layout control features on the portal.

These features allow portal designers to have finer-grained control over how zones are laid out, and enables them to achieve a better user experience and a more optimal layout that reduces unused space.

The following highlight key layout control options:

- In addition to the standard half and full width options, 1/4, 3/4, 1/3 and 2/3 width options are also available.
- Better handling of zones that are dynamically hidden by a visibility script. When a zone becomes invisible its space may be reclaimed by a next zone as long as it is of same width or smaller.
- A zone may define the beginning of a new row. This indication allows for a more fixed layout that is not impacted by hidden zones. The new row indication may establish a layout of one, two or three zones displayed vertically.
- Support the following zone height options:
 - **Content (Unlimited Height)** lets the height be determined by content.
 - **Content (Limited Height)** lets the height be determined by content up to a specified maximum limit. This option may be used to achieve a more consistent portal layout, especially when a zone is rendered on long or small devices.
 - **Fixed Height** sets the zone at a specific height regardless of content.
This option too may be used to achieve a more consistent portal layout.
- When a height option is not explicitly selected, zone height is unlimited and determined by content. However, for a data explorer zone, the results grid area itself (not the entire zone) is limited by the zone parameter "height of report" (which has a default value of 50%).

User Preferences

A **Standalone** portal includes configuration to indicate whether or not the portal should appear on a user's portal preferences. The portal will not appear on the user's portal preferences if the **Show on Portal Preferences** setting is set to No. Note that an implementation may change this value for a product delivered portal. This setting is typically enabled for

a portal that provides disparate information where not all zones are applicable to all users or where users may wish to adjust the order of the zones. An example of a portal enabled for portal preferences is the Dashboard portal.

The user can override zone oriented configuration for the portal:

- Which zones appear on that portal
- The order in which the zones appear
- Whether the zones should be initially collapsed when the portal opens.
- The refresh seconds. This is applicable to zones displaying data that changes often.

An implementation can optionally configure the system to define portal preferences on one or more "template" users. When a template user is linked to a "real" user, the real user's preferences are inherited from the "template" user and the "real" user cannot change their preferences. Some implementations opt to work this way to enforce a standard look and feel for users in the same business area.

Refer to [User — Portal Preferences](#) for more information about how users configure their zones.

Removing Zones From Portal

You cannot remove a base product zone from a base product portal. An implementation may override the **Display** setting to prevent a zone from displaying on the portal. In addition, you cannot remove a zone if a user has enabled it on their portal preferences. To remove a zone from the portal list, first make sure that no user has it enabled in their portal preferences.

Granting Access to A Portal

An [application service](#) is associated with each portal. A user must be granted access rights to the respective application service in order to see a portal.

When you add a new **Standalone** portal, the system automatically creates its application service behind the scenes and displays it as part of the portal definition. You'll need to use this application service to grant access to the portal. **Tab Page** portals do not have separate security access. If a user has access to the main stand-alone portal, then the user will have security access to all its tabs.

Please note the following in respect of how application security impacts a user's portals:

- A user's [Portal Preferences](#) page only shows the portals configured to show on user preferences and where they have security access.
- The system's menus only show portals to which a user has security access.
- Users can set up favorite links to all portals, but they must have security rights to the portal's application service in order to invoke the favorite link.

Granting Access to Zones

An [application service](#) is associated with each zone. A user must be granted access rights to the respective application service in order to see a zone on a portal. Refer to [The Big Picture Of Application Security](#) for information about granting users access rights to an application service.

Please note the following with respect to zone application security:

- For most base product portals, all the zones for all the portals reference the same application service that is used to grant access to the portal. In other words, if the user has access to the page, then the user has access to all the zones on all portals for the page. There may be exceptions to this rule for certain portals.
- For a base product multi-query zones, typically the individual query zones and the multi-query zone reference the same application service that is used to grant access to the main (standalone) portal for the page. However, there may be individual query zones provided with a unique application service. This may occur when the query option is unusual and not applicable to all users or even to all implementations. If a user does not have security access to an individual query zone, that option will not be available in the dropdown.

- For base product portals that are configured to show on portal preferences, it is common that the portal contains different types of zones that may be applicable to different types of users. Typically these types of portals will deliver a unique application service for each zone so that an implementation may configure which user groups are allowed to view each zone. For these types of portals, please note the following:
 - A user's [Portal Preferences](#) page contains a row for a zone regardless of whether the user has access rights to the zone. Because of this, the system displays an indication of the user's access rights to each zone.
 - If a user's access rights to a zone are revoked, the zone will be suppressed when the user navigates to the respective portal.
 - Revoking a user's access rights does not change the user's [portal preferences](#) (i.e., a user can indicate they want to see a zone even if they don't have access to the zone - such a zone just won't appear when the respective portal appears).

Putting Portals on Menus

When you add a new **Standalone** portal, the system automatically creates its navigation option behind the scenes and displays it as part of the portal definition. You'll need to use this navigation option to add the portal to a menu or to allow any other type of navigation method to the portal.

To add a portal to a menu, you must add a [menu item](#) to the desired menu and reference the portal's navigation option on the new menu item. A portal's navigation option can appear on any number of menu items (i.e., you can create several menu items that reference the same portal).

Your users can set up their preferences to include the portal's navigation option on their [Favorite Links](#). This way, they can easily navigate to the portal without going through menus.

Portal Options

Various portal features are controlled by configuration options, such as the ability to include additional applicable actions on the portal's actions bar or the ability to include the standard information description of the maintained entity as part of the portal's title.

NOTE: You can add new option types. Your implementation may want to add additional portal option types. To do that, add your new values to the customizable lookup field **PORTAL_OPT_FLG**.

Setting Up Portals and Zones

The topics in this section describe how to set up portals and zones. Please refer to [The Big Picture of Portals and Zones](#) for background information.

Defining Zone Types

A Zone Types represents a particular type of zone with a specific behavior. For example, a data explorer zone type is used to select data using a specific SQL statement and display the data based on parameter configuration. The zone type defines the Java Class that controls the behavior of the zone and defines the parameters that the Java Class supports. The base product supports many zone types used to build the portal / zone user interface. Implementations may introduce their own zone types.

NOTE: It is not very common for an implementation to introduce their own zone types.

Select **Admin > System > Zone Type** to maintain zone types.

Description of Page

Specify an easily recognizable **Zone Type** code and **Description**. Use the **Detailed Description** to describe in detail what the zone type does.

CAUTION: When adding new zone types, carefully consider its naming convention. Refer to [System Data Naming Convention](#) for more information.

Owner indicates if this zone type is owned by the base product or by your implementation (**Customer Modification**). The system sets the owner to **Customer Modification** when you add a zone type. This information is display-only.

Java Class Name is the Java class responsible for building the zone using the parameters defined below.

Two types of parameters are specified when defining a zone type:

- Parameter values that have a **Usage of Zone** are defined on the zones and control the functionality of each zone governed by the zone type. A **Usage** value of **Zone - Override Allowed** indicates that an implementation may override the parameter value for a base zone.
- Parameter values that have a **Usage of Zone Type** are defined directly on the zone type and control how the zone type operates (e.g., the name of the XSL template, the name of the application service). A **Usage** value of **Zone Type - Override Allowed** indicates that an implementation may override the parameter value for a base zone type.

The following points describe the fields that are defined for each parameter:

- **Sequence** defines the relative position of the parameter.
- **Parameter Name** is the name of the parameter.
- **Description** is a short description that allows you to easily identify the purpose of the parameter.
- **Comments** contain information that you must know about the parameter or its implementation. For parameters with a usage of **Zone** or **Zone - Override Allowed**, this information is visible to the user when viewing or defining this parameter for a zone of this type.
- **Usage** indicates whether the parameter value is defined in a **Zone** of this type or in the **Zone Type**. **Zone - Override Allowed** and **Zone Type - Override Allowed** indicate that override values for the parameters defined in a base zone or base zone type can be entered.
- **Required** is checked to indicate that a zone must define a value for the parameter. It is not checked if a value for the parameter is optional. This field is protected if the **Usage** is **Zone Type** or **Zone Type - Override Allowed**.
- **Parameter Value** is used to define the value of zone type parameters. This field is protected if the **Usage** is **Zone** or **Zone - Override Allowed**.
- **Owner** indicates if this parameter is owned by the base product or by your implementation (**Customer Modification**). The system sets the owner to **Customer Modification** when you add a parameter. This information is display-only.

Zone Type Parameter Comments

For the product owned zone type parameters, the parameter's detailed description provides the detail needed for properly configuring the parameter. For the Action parameters (IMPLEMENTOR_ACTION_n), the parameter description is abbreviated. Additional detail about configuring this parameter may be found in the [Zone Action Parameter](#) detailed information. The same details apply.

Defining Zones

This portal is used to view and maintain the configuration of a zone. Implementations may define custom zones or override the descriptions and some parameter values for base product zones.

You can access the portal from the **Admin Menu > System > Zone**. You are brought to a query portal with options for searching for a specific zone. Once a zone record has been selected you are brought to the maintenance portal to view and maintain the selected record.

NOTE: When introducing a new record, carefully consider its naming convention. Refer to [System Data Naming Convention](#) for more information.

Refer to [Understanding Portals and Zones](#) for more information.

The following zones may appear as part of the portal's **Main** tab page

- **Zone.** This zone provides general information about the selected zone.
- **Query Options.** This zone maintains the list of query options for a Multi-Query zone. The zone is only visible for Multi-Query zones.
- **Filters.** This zone maintains various zone parameters that handle filtering options for a data explorer zone. The zone is only visible for data explorer zones.
- **General Parameters.** This zone maintains various general purpose zone parameters for a data explorer zone.
- **SQLs.** This zone maintains individual SQLs and their related parameters. The zone is only visible for data explorer zones.
- **SQL Configuration.** This zone maintains all the zone parameters related to a specific data explorer SQL. The zone is only visible when a specific SQL is broadcast from the **SQLs** zone.

The following zones may appear as part of the portal's **References** tab page

- **Zone References.** This zone list various configuration entities referencing the current zone.

Overriding Parameter Values

Implementation teams may override the value of selected types of base provided zone parameters. The override parameter value field for base owned zone parameters is only enabled when the related zone type parameter usage is **Zone - Override Allowed**.

For multi-query zones, you may use the override parameter value to add custom query options to a base product owned zone.

Overriding Zone Parameters

Implementations may override the value of a base owned zone parameter only if the zone type definition allows such override. The override parameter value is enabled for a specific base owned parameter when the related zone type parameter usage is set to **Zone - Override Allowed**.

You may use the override parameter capability to provide alternative or additional custom query options for a base owned multi-query zone.

Zone Parameter Details

For most zone parameters, the embedded help for the parameter provides the detailed information needed for configuring the parameter values. For some parameters with very detailed descriptions, the embedded help is abbreviated and more detail is provided here.

Zone Visibility Service Script

All zones support a visibility script that is used to determine if the zone should be displayed to the user or not based on conditions. The script may receive input parameters and is expected to return a Boolean value indicating if the zone should be displayed or not. The embedded help for the **Zone Visibility Service Script** parameter provides details related to the syntax.

The following table highlights some service scripts provided by the product that may be used if applicable to your zone's requirements. This is not an exhaustive list of visibility scripts. There may be others that are specific to a given zone.

Script Code	Description	Comments
F1-ShldShwZn	Zone Visibility - Display Zone in Portal	This script simply returns a value of 'true' and is used when the zone should always appear.
F1-CondShwZn	Zone Visibility - Display Zone in Portal Conditionally	This is used when the condition for showing the zone is based on the population of a context value. This is commonly used when one zone in the portal should only appear after a broadcast of a record from another zone in the portal. For an example of a zone the uses this visibility script, refer to F1-BSFTYPE .
F1-RwCtShwZn	Zone Visibility - Based on Row Count	This is used when the condition for showing the zone is based on the existence of one or more rows that can be determined using SQL. This script accepts a zone code, user filters 1 through 25 and hidden filters 1 through 10. The script returns an indication of 'true' if at least one row count is returned by the zone. To use this visibility script, a specific data explorer zone must be developed for the specific use case. For an example of a zone the uses this visibility script, refer to F1-MIGREQEL .

SQL Statement

Data explorer zones are used to select data to display using one or more SQL statements. The SQL parameters are applicable to the following zone types

- Info Data Explorer - Single SQL (**F1-DE-SINGLE**). The parameter has the description **SQL Statement**.
- Info Data Explorer - Multiple SQLs (**F1-DE**). The parameters follow the description pattern of **SQL Statement x**.
- Query Data Explorer - Multiple SQLs (**F1-DE-QUERY**). The parameters follow the description pattern of **SQL Statement x**.

NOTE: If your implementation has been configured to restrict the functions that may be used when defining an SQL then an error is issued at runtime if there are functions found that are not in the allowlist. The allowlist may be viewed using the **View SQL function allowlist** link in the Tips zone on the zone maintenance page.

NOTE: Zone SQL should take care not to use the following reserved keywords for the table alias. (For example, the table alias in this SQL is 'XX': SELECT 'X' FROM W1_ACTIVITY_TYPE XX.)

Keyword

AT

The following table provides a list of SQL substituted keywords that may be used in the SQL Statement parameters in explorer zones. At execution time, the system determines the database and substitutes the keyword with the database specific syntax:

Keyword	Description	Examples
@toCharacter()	Converts the input to Character data type.	select @toCharacter(batch_cd) as batchCode from ci_batch_ctrl
@toDate()	Converts the input to Date data type.	select @toDate(last_update_dttm) as lastUpdateDate from ci_batch_ctrl

Keyword	Description	Examples
@toNumber()	Converts the input to Number data type.	select @toNumber (next_batch_nbr) from ci_batch_ctrl
@currentDate	Fetches the current date. CAUTION: The Oracle functions SYSDATE and CURRENT_DATE should not be used because they do not properly cater for adjusting dates from the database time zone to the installation time zone, if needed.	select batch_cd, @currentDate as today from ci_batch_ctrl
@currentTimestamp	Fetches the current date / time. CAUTION: The Oracle functions SYSTIMESTAMP and CURRENT_TIMESTAMP should not be used because they do not properly cater for adjusting the date / time from the database time zone to the installation time zone, if needed.	select batch_cd from ci_batch_ctrl where last_update_dttm > @currentTimestamp
@concat	Combines the result list of two or more columns.	select batch_cd @concat next_batch_nbr concatNbr from ci_batch_ctrl
@substr(string, start)	String is the input String that you are trying to get a substring of. Start is the position of the character for the output results.	select batch_cd batchCode from ci_batch_ctrl Result: TESTCD select @substr (batch_cd,3) batchCode from ci_batch_ctrl Result: STCD
@substr(string, start, end)	String is the input String that you are trying to get a substring of. Start is the position of the character for the output results. End is the number of characters required in the output from starting position.	Select batch_cd batchCode from ci_batch_ctrl Result: TESTCD select @substr (batch_cd,3,2) batchCode from ci_batch_ctrl Result: ST
@trim	Trims the white spaces of the output on both sides.	select @trim (batch_cd) as batchCode from ci_batch_ctrl
The following syntax is related to 'fuzzy' searching. It is only applicable if Oracle DB Text is enabled and a context text index has been created. Refer to Advanced Search Options for more information.		
@fuzzy(string, score, numresult, 'weight')	String is the input value for the search. Score is the degree of 'fuzziness'. Valid values are between 1 - 80. The higher the number the more precise the search. Default is 60. Numresults is the number of variations to consider for the string. Valid values are between 1 and 5000. Default is 100. Indicate 'weight' to signal that the results are returned in order of weight. Leave this setting off to indicate that the results are returned in order of score.	Set score to 70, number results to 6, and specify weight. select user_id, last_name from sc_user where contains(last_name, @fuzzy(:F1,70, 6, 'weight')) > 0
@fuzzy(string)	This returns a string result from the fuzzy expansion operation where the default value of 60 is assumed for the score and the default value of 100 is assumed for the numresult .	To use default values: select user_id, last_name from sc_user where contains(last_name, @fuzzy(:F1))> 0
@fuzzy(string, score)	This returns a string result from the fuzzy expansion operation with the score specified and the default value of 100 for the numresult .	Set score to 70. select user_id, last_name from sc_user where contains(last_name, @fuzzy(:F1,70)) > 0
@fuzzy(string, score, numresult)	This returns a string result from the fuzzy expansion operation with the similarity score and the numresults specified.	Set score to 70, number results to 6. select user_id, last_name from sc_user where contains(last_name, @fuzzy(:F1,70, 6)) > 0

Column Parameters

Data explorer zones are used to select data to display using one or more SQL statements. For each SQL statement, the zone may configure up to 20 Columns that contain the formatting definition for displaying the output data.

These parameters are applicable to the zone types

- Info Data Explorer - Single SQL (**F1-DE-SINGLE**). The parameters follow the description pattern of **Column x**.
- Info Data Explorer - Multiple SQLs (**F1-DE**). For this zone type, all SQLs are executed and the zone displays a union of all the results. The parameters follow the description pattern of **Column x for SQL y**. There are some mnemonics that do not make sense to differ within rows of the same column. For example, the column label. For these mnemonics, only the value in SQL 1 is considered for that column. The table below indicates which mnemonics follow this rule.
- Query Data Explorer - Multiple SQLs (**F1-DE-QUERY**). For this zone type, only one SQL is executed. The **SQL y Condition** parameter may be used to control this. The system will execute the first SQL whose condition is satisfied (or with no condition populated). The parameters follow the description pattern of **Column x for SQL y**.

The following sections describe the various types of mnemonics.

Contents

- [Source Mnemonics](#)
- [Formatting Mnemonics](#)
- [Click Mnemonics](#)
- [Common Use Cases](#)

Source Mnemonics

This table describe the mnemonics that control how the data in a column is derived.

Mnemonic	Description	Valid Values	Comments
source=	Defines how the column's value is derived.	SQLCOL	Indicates that the source of the column's value comes from a column in the SQL statement. This type of column must also reference the sqlcol= mnemonic.
BO			Indicates that the source of the column's value comes from a business object . This type of column must also reference the bo= , input= and output= mnemonics to define how to interact with the business object.
BS			Indicates that the source of the column's value comes from a business service . This type of column must also reference the bs= , input= and output= mnemonics to define how to interact with the business service.
SS			Indicates that the source of the column's value comes from a service script . This type of column must also reference the ss= , input= and output= mnemonics to define how to interact with the service script.

Mnemonic	Description	Valid Values	Comments
FORMULA			Indicates that the source of this column's value is calculated using a formula. This type of column must also reference the formula= mnemonic.
SETFUNC			Indicates that the source of this column's value is calculated using a superset of values from the rows in the SQL statement. This type of column must also reference the setfunc= mnemonic.
ICON			Indicates that the source of this column's value is a display icon reference (meaning that an icon will be displayed in the column). This type of column must also reference the icon= mnemonic to define the icon reference. NOTE: When using this source mnemonic, the formatting mnemonic type= is not applicable.
FKREF			Indicates that the source of this column's value is an FK reference (meaning that the FK reference's context menu and information string will be displayed in the column and will be enabled for navigation). This type of column must also reference the fkref= and input= mnemonics to define how the FK reference is called. NOTE: When using this source mnemonic, the formatting mnemonic type= is not applicable. NOTE: To show a foreign key's information but not enable navigation, refer to Common Use Cases for the recommended technique.
SPECIFIED			Indicates that the source of this column's value is specified by concatenating literals and other column values. This type of column must also reference the spec= mnemonic.
MSG			Indicates that the source of this column is a message from the message table (along with any

Mnemonic	Description	Valid Values	Comments
			substitution variables). This type of column must also reference the msg= mnemonic.
sqlcol=	Defines the column in the SQL statement when source=SQLCOL .	COLUMN_NAME	Enter the name of a column that is retrieved in the SELECT statement. Note that if the select statement uses an alias for a column, then the alias should be referenced here.
		x	Where x is an integer value that references a column by its relative position in the SELECT statement. For example, sqlcol=3 would display the 3rd column in the SELECT statement).
bo=	Defines the business object to invoke when source=BO . This mnemonic must be used in conjunction with the input= and output= mnemonics to define how information is sent to / received from the business object.	'Business Object Code'	
bs=	Defines the business service to invoke when source=BS . This mnemonic must be used in conjunction with the input= and output= mnemonics to define how information is sent to/received from the business service.	'Business Service Code'	
ss=	Defines the service script to invoke when source=SS . This mnemonic must be used in conjunction with the input= and output= mnemonics to define how information is sent to / received from the service script.	'Service Script Code'	
fkref=	Defines the FK reference used to retrieve the column's information when source=FKREF . This mnemonic must be used in conjunction with the input= mnemonic to define how information is sent to the FK reference to build the information.	Cx	This means FK reference code is defined in an earlier column. For example, define C1 if column 1 defines the FK reference value.
		COLUMN_NAME	This means the FK reference was retrieved by the SELECT statement. The value should match the name defined in the SELECT clause.
		'FK Reference Code'	This means the FK Reference is defined directly. For example 'F1-ROLE'.
formula=	Defines the formula to use when source=FORMULA . Examples:	The formula can contain numeric constants, operators and column references.	For column references, use the format Cx where x represents the column number.

Mnemonic	Description	Valid Values	Comments
	<ul style="list-style-type: none"> • formula=C1*.90/C2 • formula=(C1/C2)*100 		Refer to Expression Parser for information about the functions supported.
setfunc=	Defines the function to apply to the rows of a given column when source=SETFUNC .	function(Cx)	<p>Where Cx represents a column whose rows should have the function applied and the function is one of the following:</p> <ul style="list-style-type: none"> • MAX. This derives the maximum value of all rows in the column. • MIN. This derives the minimum value of all rows in the column. • TOT. This derives the sum (total value) of all rows in the column. • ACC. This derives the cumulative total of all rows up to an including the current row.
input=	<p>This is used to define one or more input fields and values passed to business objects, business services, service scripts, and FK references.</p> <p>The syntax is as follows: [ELEMENT_NAME=ELEMENT_REF ELEMENT_NAME=ELEMENT_REF ...]</p> <p>In other words, the list of input values is surrounded by square brackets separated by a space. Each passed value first defines the ELEMENT_NAME, which is the name of the element / field in the target. ELEMENT_REF is the value passed in. The next column indicates the possible values for ELEMENT_REF.</p>	<p>Cx</p> <hr/> <p>COLUMN_NAME</p> <hr/> <p>'literal value'</p> <hr/> <p>userTimeZone</p> <hr/> <p>installationTimeZone</p>	<p>Where Cx represents the value of a previous column. If the value to pass is in the first column, reference C1.</p> <hr/> <p>This means the value to pass in was retrieved by the SELECT statement. The value should match the name defined in the SELECT clause.</p> <hr/> <p>This means a literal value within the single quotes should be passed in.</p> <hr/> <p>This means the current user's time zone should be passed in. This is typically used with the business service F1-ShiftDateTime to convert data in the storage time zone to the user's time zone for display.</p> <hr/> <p>This means the installation time zone should be passed in. This is typically used with the business service F1-ShiftDateTime to convert data in the storage time zone to the installation time zone for display.</p>
		<p>Examples:</p> <ul style="list-style-type: none"> • input=[USER_ID=C1] • input=[USER_ID=USER_ID] • input=[input/targetTimeZone=userTimeZone] 	
output=	This is used to define the name of the element retrieved from the business object, business service or service script used to populate this column.	elementName	Example: output=personInfo

Mnemonic	Description	Valid Values	Comments
pagingkey=	<p>This mnemonic is only applicable when the Enable Paging parameter has been configured. It indicates that this column is one of the keys used by the SQL statement to orchestrate paging through results. This mnemonic can only be specified when the source=SQLCOL.</p> <p>FASTPATH: Refer to Pagination Configuration for more information.</p>	<p>Y</p> <p>N</p>	<p>This is the default, meaning that you don't need to indicate pagingkey=N at all to indicate that the column is not one of the paging keys.</p>

NOTE: If multiple columns are configured with the same source BO, BS or SS and the same input data, the system caches the output from the first call and reuses the results for subsequent columns.

Formatting Mnemonics

This table describe the mnemonics that control how a column is formatted.

NOTE: For the **F1-DE** zone type, zone displays the union of all the different SQLs.

Mnemonic	Description	Valid Values	Comments
type=	<p>Defines how the column's value is formatted.</p> <p>NOTE: Icon and Foreign Key columns. The source=source mnemonic may be used to indicate a column should be derived from an icon reference or a foreign key (FK) reference. If you use either of these sources, the type= mnemonic is not relevant as either an icon or a context menu / info string will appear in the column.</p>	<p>STRING</p> <hr/> <p>DATE</p> <hr/> <p>TIME</p> <hr/> <p>DATE/TIME</p> <hr/> <p>MONEY</p> <hr/> <p>NUMBER</p>	<p>Columns of this type capture a string. This is the default value.</p> <hr/> <p>Columns of this type capture a date and will be displayed using the user's display profile.</p> <hr/> <p>Columns of this type capture a time (in database format) and will be displayed using the user's display profile.</p> <hr/> <p>Columns of this type capture a date and time (in database format) and will be displayed using the user's display profile.</p> <hr/> <p>Columns of this type capture a monetary field. This type of column may also reference the cur= mnemonic. If the cur mnemonic is not specified, the currency code on the installation record is used.</p> <hr/> <p>Columns of this type capture a numeric field. This type of column may also reference the dec= mnemonic.</p>
label=	<p>Defines the column's override label. The label appears in the column's heading and in the zone's drag and drop area.</p>	<p>FIELD_NAME</p> <hr/> <p>'text'</p>	<p>Enter a valid field name whose label should be used for the column label. This should always be the option used if multiple languages are needed.</p> <hr/> <p>Defines the text directly.</p>

Mnemonic	Description	Valid Values	Comments
	<p>If this mnemonic is not defined, the system uses the column's default label. The source of a column's default label differs depending on the column's source. Note that some sources don't have a default value and omitting this mnemonic will result in a blank label.</p> <p>NOTE: In the case of the zone type Info Data Explorer - Multiple SQLs (F1-DE), the system will use the column definitions in SQL 1 to define the labels.</p>		
cur=	<p>Defines the currency code applied when type=MONEY if the installation record's currency should not be used.</p>	Cx	This means currency code value is defined in an earlier column. For example, define C1 if column 1 defines the currency code.
		COLUMN_NAME	This means the currency code was retrieved by the SELECT statement. The value should match the name defined in the SELECT clause.
		'Currency Code'	This means the currency code is defined directly. For example 'USD'.
dec=	<p>Defines the number of decimal places when type=NUMBER.</p> <p>It is optional. If provided it should be an integer. If not provided, the number of decimals will default to the number of decimal places defined on the currency code specified on the installation record.</p>	nR	<p>Where n is the number of decimal places to show. Suffixing the number of decimal places with R means that the system should round up / down. Simply specifying n (without an R) means that decimal places should be truncated. For example, entering dec=4 will display 4 decimal places and truncate the remainder.</p> <p>NOTE: Formatting only. This mnemonic is only used for formatting, it does not impact the precision used for subsequent calculations. For example, if a column retrieved from the database contains 6 significant digits and dec=0, the column will be shown with no decimal places (truncated), however any references to the column in subsequent calculations will use 6 decimal places. For example, if the column is referenced in a formula or set function, all 6 decimal places will be used.</p>

Mnemonic	Description	Valid Values	Comments
char=	<p>This mnemonic applies special character(s) to the column's value.</p>	'x[]x'	<p>Where x references the literal value to display and [] defines the relative position of the characters (before or after the value).</p> <p>You need only include the [] if you want to position characters in front of the value. For example, char='%' will place a percent sign after the value. If you want to position the word 'minutes' before a value, enter char='minutes []'. If you want to output a value like BUDGET \$123.12 (YTD), enter char='BUDGET [] (YTD)'.</p>
suppress=	<p>This is used to indicate a column should not be displayed.</p> <p>A column would be suppressed if it's only defined for use by subsequent columns, for example, if there is a formula that derives a column using two other columns. In this scenario, the columns referenced in the formula can be suppressed.</p> <p>NOTE: In the case of the zone type Info Data Explorer - Multiple SQLs (F1-DE), the system will apply the settings for the column definitions in SQL 1 to all subsequent SQLs.</p>	<p>true</p> <hr/> <p>false</p>	<p>This is the default, meaning that you don't need to indicate suppress=false at all to indicate that the field should be shown.</p>
suppressSearch=	<p>This is used to indicate a column should not be displayed when the zone is invoked in search mode only.</p> <p>NOTE: In the case of the zone type Info Data Explorer - Multiple SQLs (F1-DE), the system will apply the settings for the column definitions in SQL 1 to all subsequent SQLs.</p>	<p>true</p> <hr/> <p>false</p>	<p>This is the default, meaning that you don't need to indicate suppressSearch=false at all to indicate that the field should be shown.</p>
suppressExport=	<p>This is used to indicate a column should not be downloaded to Excel.</p> <p>NOTE: In the case of the zone type Info Data Explorer - Multiple SQLs (F1-DE), the system will apply the settings for the column definitions in SQL 1 to all subsequent SQLs.</p>	<p>true</p> <hr/> <p>false</p>	<p>This is the default, meaning that you don't need to indicate suppressExport=false at all to indicate that the field should be included in a download.</p>

Mnemonic	Description	Valid Values	Comments
width=	This is used to override the width of a column (number of pixels). The default value is the maximum width of any cell in the column.	n	<p>Where n is a number between 0 and 999.</p> <p>NOTE: If there is no available breaking point in the data, the column will be longer than the specified number of pixels.</p> <p>The length of the column's label (which appears in the column's heading) may also make the width wider than specified.</p> <p>In the case of the zone type Info Data Explorer - Multiple SQLs (F1-DE), the system will set the width based on the column definitions in SQL 1.</p>
color=	This is used to override the column's text color.	A valid HTML "named" color	<p>For example color=yellow.</p> <p>NOTE: Refer to Color Contrast for information about the use of the HTML color 'red' and its impact on accessibility.</p>
		A valid RGB color model combination	<p>For example color=#E0292F or color=#CCCCCC. Note that the # is required.</p>
bgcolor=	This is used to override the column's background color.	A valid HTML "named" color	Similar to the color= mnemonic.
		A valid RGB color model combination	Similar to the color= mnemonic.
order=	Defines the column's default sort order.	ASC	<p>Indicates that the order is ascending. This is the default meaning that it is not necessary to indicate order=ASC.</p>
		DESC	Indicates that the order is descending.
rowHeader=	Designates the column as a row header for accessibility purposes.	true	<p>By default, the first data column of the data explorer results is identified as the row header, for accessibility tools. If the data in the first column does not uniquely identify the row, use this mnemonic to explicitly mark a different column or multiple columns as the row header.</p> <p>NOTE: In the case of the zone type Info Data Explorer - Multiple SQLs (F1-DE), the system will look only at the columns in SQL 1 that have this mnemonic defined and apply it to all results for those columns.</p>

Click Mnemonics

This table describe the mnemonics that define whether a column value may be clicked and if so, what should happen.

Mnemonic	Description	Valid Values	Comments
navopt=	<p>Defines the navigation option that references the target transaction or script when the user clicks a column.</p> <p>Note, this mnemonic should be used in conjunction with the context= mnemonic to define what information is sent to the navigation option's target transaction.</p> <p>This mnemonic is ignored if source=FKREF because the FK reference code defines the hyperlink's destination.</p>	Cx	This means navigation option code is defined in an earlier column. For example, define C1 if column 1 defines the navigation option.
		COLUMN_NAME	This means the navigation option was retrieved by the SELECT statement. The value should match the name defined in the SELECT clause.
		'Navigation Option Code'	Example: navopt=MAIN_PORTAL This means the navigation option code is defined directly. For example navopt='userMaint' .
context=	<p>This is used to define one or more context fields and values passed to the target navigation option to go along with the navopt= mnemonic.</p> <p>The syntax is as follows: [FIELD_NAME=FIELD_REF FIELD_NAME=FIELD_REF ...]</p> <p>In other words, the list of input values is surrounded by square brackets separated by a space. Each passed value first defines the FIELD_NAME, which is the name of the context field in the navigation option. FIELD_REF is the value passed in. The next column indicates the possible values for FIELD_REF.</p>	Cx	Where Cx represents the value of a previous column. For example, if the value to pass is in the first column, reference C1 .
		COLUMN_NAME	This means the value to pass in was retrieved by the SELECT statement. The value should match the name defined in the SELECT clause.
		'literal value'	This means a literal value within the single quotes should be passed in.
bpa=	<p>Indicates that a BPA script should be executed with the user clicks the column and indicates the BPA to execute.</p> <p>Note, this mnemonic should be used in conjunction with the tempstorage= mnemonic to define the temporary storage values that will be initiated when the script is executed.</p> <p>This mnemonic is ignored if source=FKREF because the FK reference code defines the hyperlink's destination.</p>	Cx	Indicates that the BPA script is defined in a previous column.
		COLUMN_NAME	This means the BPA script to execute was retrieved by the SELECT statement. The value should match the name defined in the SELECT clause.
		'BPA Script Code'	This means that the BPA script to execute is defined directly.
tempstorage=	This is used to define how temporary storage variables are initiated when the bpa= mnemonic is used.	Cx	Where Cx represents the value of a previous column. For example, if the

Mnemonic	Description	Valid Values	Comments
	<p>The syntax is as follows: [FIELD_NAME=FIELD_REF FIELD_NAME=FIELD_REF ...]</p> <p>In other words, the list of input values is surrounded by square brackets separated by a space. Each passed value first defines the FIELD_NAME, which is the name of the field in temporary storage. FIELD_REF is the value passed in. The next column indicates the possible values for FIELD_REF.</p>	<p>COLUMN_NAME</p> <p>'literal value'</p>	<p>value to pass is in the first column, reference C1.</p> <p>This means the value to pass in was retrieved by the SELECT statement. The value should match the name defined in the SELECT clause.</p> <p>This means a literal value within the single quotes should be passed in.</p>
list=	<p>This is used to enable work list capability for this column.</p> <p>You may optionally populate the listdesc= mnemonic to override the text that will be placed in the worklist zone.</p>	true	<p>Setting list=true will cause the work list icon to appear in the column's header. If a user clicks the column, it will populate all the rows in the output into the work list zone.</p> <p>NOTE: In the case of the zone type Info Data Explorer - Multiple SQLs (F1-DE), the output may be showing a union of the results of multiple SQL statements. In this case, if some of the SQL statements configure a given column with list=true, but not all, only the data in the cells for the statements that configure this mnemonic are put into the work list when the user clicks the icon. Also note that when determining which columns should have the worklist icon when building the zone, the system only looks at the configuration for the columns in SQL 1.</p>
listdesc=	This is an optional mnemonic when using the list= mnemonic. It can be used to override the text that is placed in the work list zone.	Cx	Where Cx represents the value of a previous column. For example, if the text to use is in the first column, reference C1 .
listbroadcast=	Indicates that the broadcast information for the column is also to be made available in the work list zone. This means that the work list can be used to broadcast information to a portal in the same manner as a data explorer.	true	Use this setting to turn on the feature.

Common Use Cases

This section provides some common configuration that can be copied and pasted for newly created zones.

Use Case	Code Snippet
<p>Displaying the description of a lookup value that has been retrieved in the SQL statement. The business service checks for an override label.</p>	<pre>source=BS bs='F1-GetLookupDescription' label=FLD_NAME input=[fieldName='FLD_NAME' fieldValue=FLD_NAME] output=description</pre>
<p>Display a foreign key with its information but suppressing the navigation. (This is useful when you have a foreign key that is additional information in a zone but would cause confusion to enable navigation. To display foreign key reference with its information and enabled for navigation, use the source of FKREF as described above.)</p> <p>The first example assumes that you know the FK Reference. The second example uses a business service that receives the maintenance object as input.</p>	<pre>source=BS bs='F1-GetForeignKeyReference' input=[input/fkReference=FK_REF_CD input/fkValue1=BUS_OBJ_CD] output=output/infoDescription label=DESCR</pre> <hr/> <pre>source=BS bs='F1-GetFKReferenceDetails' input=[input/maintenanceObject='F1-EXT LKUP' input/pkValue1=BUS_OBJ_CD input/pkValue2=C1] output=output/infoDescription label=DESCR</pre>
<p>Display a foreign key, including a corresponding navigation link, for generic objects that may or may not have a foreign key reference. If the FK reference exists, its information is shown, otherwise not.</p> <p>Standard foreign key services assume all rows have foreign key details. The service script F1FKInfoOpt provides the same foreign key details but does not error when foreign key details do not exist. To build the foreign key description and link, the script needs to be used twice; one column gets the navigation details and another gets the description. The latter references the navigation details column and invokes a BPA script to perform the dynamic navigation.</p>	<pre>This column gets the navigation details: source=SS ss='F1FKInfoOpt' input=[input/fkReference=C9 input/fkValue1=C6 input/fkValue2=C7] output=output/navigationOption suppress=true</pre> <p>This column constructs the foreign key description and link:</p> <pre>source=SS ss='F1FKInfoOpt' input=[input/fkReference=C9 input/fkValue1=C6 input/fkValue2=C7] output=output/infoDescription label=F1_APPSEC_COMP_DESCR bpa='F1AsecNav' tempstorage=[navopt=C15 pkField1=C10 pkValue1=C6 pkField2=C11 pkValue2=C7] list=true</pre>

Zone Action

Most zone types provided by the product allow for one or more Zone Actions to be defined to appear in the zone header. An action can appear as a hyperlink, icon or button. The action can also be provided as an HTML string.

NOTE: Zone types also include parameters for actions defined at the zone type level using IMPLEMENTOR_ACTION_n (Action n) parameters. These are rarely used by the product zone types. The actions defined here override any actions defined on the zone type (if present). The details below apply to the zone type level actions as well.

A zone action is defined using the following mnemonics:

Mnemonic	Description	Valid Values	Comments
type=	This mnemonic defines the appearance of the action in the zone header.	LINK	Indicates that the action is shown as a textual hyperlink.
		ICON	Indicates that the action is shown as a graphical icon.
		BUTTON	Indicates that the action is shown as an HTML button.
		ASIS	Indicates that the parameter will provide the HTML to be used for the action.
action=	This mnemonic defines the action to take when the link/icon/button is clicked. This is ignored when the type=ASIS.	NAVIGATION	Indicates that the action is navigation to a page.
		SCRIPT	Indicates that the action is to run a BPA script.
navopt=	Defines the navigation option to use when the action=NAVIGATION .	'NAV_OPT_CD'	Enter a reference to a valid navigation option in single quotes.
bpa=	Defines the script to run when the action=SCRIPT .	'SCRIPT_CD'	Enter a reference to a valid BPA script in single quotes.
icon=	Indicates the icon to use when type=ICON .	DISP_ICON_CD	Enter a reference to a valid display icon.
		'path'	Enter an explicit path to the icon, for example 'images/gotoZone.gif'.
asis=	This is required when the type=ASIS . This provides the ability to precisely define the HTML you wish to have included in the header. All valid HTML is permitted including the use of "ora" css classes and JavaScript functions.	['HTML']	
label=	By default, the label or tooltip will come from the navigation option or BPA script description. Use this mnemonic to override that label.	FIELD_NAME	Enter a valid field name whose label should be used. This should always be the option used if multiple languages are needed.
		'text'	Enter the text directly in single quotes.
context=[target1=source1 target2=source2]	This is used to pass context data when navigating to a page or executing a BPA script. The mnemonic supports passing multiple values. In each case the target context field or BPA script	FIELD_NAME	Indicates that the value should be taken from the field with this name from portal context, global context or the page data model. The mnemonic sourceLoc is used for defining the source.

Mnemonic	Description	Valid Values	Comments
	variable is defined first followed by an equal sign, followed by source data defined using one of the valid values defined in the next column. One or more values may be defined. Each context value is defined separated by spaces. The whole set of context values should be surrounded by square brackets.	xpath 'constant'	Indicates that the value should be taken from a schema field, represented by the Xpath, displayed in this zone. This is valid when the zone is displaying a UI Map. Indicates that the value defined in single quotes should be passed.
sourceLoc=	This mnemonic defines the source of the FIELD_NAME's value in the context mnemonic. If this mnemonic is left blank, the default behavior is as follows: - The portal context is checked. - If no portal context value is found, the global context is checked. - If neither value is available, the field is ignored.	G P D	Indicates that the field's value is retrieved from the global context. Indicates that the field's value is retrieved from the portal context. Indicates that the field's value is retrieved from the page data model.
class=	Use this mnemonic to override the look and feel of the link / icon / button using a different CSS style.	'className1' 'className2'	Enter one or more classes in single quotes. Multiple class names may be provided.
style=	Use this mnemonic to override the look and feel of the action element using the indicated css style.	Standard style= format.	All allowed css style definitions may be used.

Examples:

- **type=BUTTON action=SCRIPT bpa='F1-SET-USER' context=[USER_ID=USER_ID] label=UPDATE_LBL**
- **type=LINK action=NAVIGATION navopt='gotoUser' context=[USER_ID=path(schema/userId)]**
- **type=ASIS asis=['Search']**

NOTE: If the zone type has actions defined and there is a desire to simply remove the zone type actions, the Zone Action can be set with the following configuration: **type=ASIS asis=[]**

User Filters

Data explorer zones include the ability to define User filters to allow a user to enter data to restrict the zone's rows and / or columns. The filters may be defined individually using User Filter parameters 1–25. Alternatively, a UI map may be defined for capturing filters. In this case, the map's input fields must be associated with the zone's filters by specifying the **xpath=** mnemonic on the respective User Filter parameters.

These parameters are applicable to the zone types

- Info Data Explorer - Multiple SQLs (**F1–DE**)
- Query Data Explorer - Multiple SQLs (**F1–DE-QUERY**)
- Info Data Explorer - Single SQL (**F1–DE-SINGLE**)

A user filter is defined using the following mnemonics:

Mnemonic	Description	Valid Values	Comments
name=	This mnemonic is used if the zone's filter should be pre-populated with a value from global context, portal context or broadcast from another zone.	MD Field Name	
datasource=	<p>This mnemonic defines the source of the filter's pre-populated value defined in the name mnemonic.</p> <p>If this mnemonic is left blank, the default behavior is as follows:</p> <ul style="list-style-type: none"> - If the field has been broadcast from another zone, the broadcast value is used. - If no value is broadcast, the portal context is checked to determine if this field exists (if so, its value is taken). - If still no value, the global context is checked. - If still no value, no default value is shown. 	<p>G</p> <hr/> <p>P</p> <hr/> <p>D</p>	<p>Indicates that the zone should look for the filter value in global context.</p> <hr/> <p>Indicates that the zone should look for the filter value in portal context.</p> <hr/> <p>Indicates that the zone should look for the filter value in the page data model.</p>
type=	Defines the visual metaphor used to capture the filter values.	<p>DATE</p> <hr/> <p>DATE/TIME</p> <hr/> <p>STRING</p> <hr/> <p>MONEY</p> <hr/> <p>NUMBER</p> <hr/> <p>LOOKUP</p> <hr/> <p>TABLE</p> <hr/> <p>CHARTYPE</p> <hr/> <p>ASIS</p>	<p>Filters of this type capture a date.</p> <hr/> <p>Filters of this type capture a date and time.</p> <hr/> <p>Filters of this type capture a string</p> <hr/> <p>Filters of this type capture a monetary field. This type of filter must also reference the cur mnemonic.</p> <hr/> <p>Filters of this type capture a numeric field. This type of filter may also reference the decimals mnemonic.</p> <hr/> <p>Filters of this type capture a lookup value. This type of filter must also reference the lookup mnemonic.</p> <hr/> <p>Filters of this type capture an administrative table's value (code and description). This type of filter must also reference the table mnemonic.</p> <hr/> <p>Filters of this type capture predefined characteristic values for a characteristic type (code and description). This type of filter must also reference the chartype mnemonic.</p> <hr/> <p>Filters of this type capture a list of values to be referenced within an 'IN' clause within the SQL statement.</p>
label=	Defines the filter's label that appears in the zone's description bar and in the input area.	MD Field Name	Enter a valid field name whose label should be used for the filter label. This should always be the option used if multiple languages are needed.
		'text'	Defines the text directly.
cur=	Defines the currency code applied when type=MONEY .	Currency Code	Enter a reference to a valid currency code.
dec=	Defines the number of decimal places when type=NUMBER .	Valid number	It is optional. If provided it should be an integer. If not provided, the number of decimals will default to the number of decimal places defined on the currency code specified on the installation record.

Mnemonic	Description	Valid Values	Comments
lookup=	Defines the lookup flag whose values appear when type=LOOKUP .	Lookup Field Name	Enter a reference to a valid lookup field name.
table=	Defines the admin table whose values appear when type=TABLE .	Table Name	Enter a reference to a valid control table name.
chartype=	Defines the characteristic type code whose values appear when type=CHARTYPE .	Char Type code	Enter a reference to a valid characteristic type code.
xpath=	This mnemonic is used in conjunction with a Filter Area UI Map. For each filter, you must specify the XPath to the corresponding UI map schema element.	XPath	The type= mnemonic must also be appropriate for the map's input field, otherwise the query's SQL could fail.
likeable=	This mnemonic defines if a likeable search is performed on the entered value when type=STRING .	S	The query will add % to the suffix of the filter value.
		P	The query will add % to the prefix of the filter value.
		PS	The query will add % to the prefix and suffix of the filter value.
divide=	The mnemonic controls if a divider line appears above and/or below the filter. Note, you can specify this parameter twice if you want divider lines placed above and below a filter, e.g., divide=above divide=below .	above	This results in a divider line placed above the filter.
		below	This results in a divider line placed below the filter.
searchField=	This mnemonic controls the initial population of the filter when the zone is launched as a search from a UI map.	MD Field Name	Enter the field name that exactly matches the searchField name specified in the oraSearchField HTML element in the UI map.
encrypt=	This mnemonic defines if the user filter is encrypted and needs to be searched by hashed value.	[TBL_NAME,FLD_NAME,WHERE_FLD,WHERE_VALUE] NOTE: The field name referenced here should be the source value of the field. However, the SQL should use the hashed value in its filter.	A valid table name and field name are required. The WHERE_FLD and WHERE_VALUE are optional, but if entered, both are required. Use this to only encrypt the field if another field has a certain value. The following is an example. encrypt=[CI_PERSON,PER_ID_NBR,ID_TYPE_NBR,'SSN'] . The WHERE_VALUE may also reference another filter. The following is an example. encrypt=[CI_PERSON,PER_ID_NBR,ID_TYPE_NBR,F1] .

Examples:

- **label=F1_NBR_DAYS type=NUMBER**
- **label=F1_SHOW_ALL_REQ_FLG type=LOOKUP lookup=F1_SHOW_ALL_REQ_FLG**
- Filter value where a Filter UI Map is defined and Description is one of the filters. **type=STRING xpath=description likeable=S**
 - **type=STRING label=DESCR likeable=S divide=below**
 - **label=REQ_TYPE_CD type=TABLE table=F1_REQ_TYPE**

Hidden Filters

Data explorer zones include the ability to define Hidden filters to restrict the rows and / or columns that appear in the zone. The following are the potential sources of a hidden filter's value:

- The global area contains the fields whose values are maintained in [global context](#).
- The portal area contains the fields describing the object currently displayed in a portal.
- Other zones on a portal can broadcast information to the portal area, which can then in turn be used by the zone as a hidden filter.

These parameters are applicable to the zone types

- Info Data Explorer - Multiple SQLs (**F1-DE**)
- Query Data Explorer - Multiple SQLs (**F1-DE-QUERY**)
- Info Data Explorer - Single SQL (**F1-DE-SINGLE**)

A hidden filter is defined using the following mnemonics:

Mnemonic	Description	Valid Values	Comments
name=	This mnemonic defines the name of the field that needs to be broadcast from other zones or populated in the portal context	FIELD_NAME	
datasource=	This mnemonic defines the source of the hidden filter's value. If this mnemonic is left blank, the default behavior is as follows: - If the field has been broadcast from another zone, the broadcast value is used. - If no value is broadcast, the portal context is checked to determine if this field exists (if so, its value is taken). - If still no value, the global context is checked. - If still no value, the zone appears as per the poprule mnemonic.	G P D	Indicates that the zone should look for the filter value in global context. Indicates that the zone should look for the filter value in portal context. Indicates that the zone should look for the filter value in the page data model.
poprule=	This mnemonic controls what happens if the hidden filter is not present.	R O	Indicates that a value for the filter is required. The zone will be set to the "empty state" and the "please broadcast" message will appear in the zone. This is the default value. Indicates that the value is optional. If no value is required, the zone is still built without that value.
type=	Defines the visual metaphor used to capture the filter values.	DATE DATE/TIME STRING MONEY NUMBER LOOKUP TABLE	Filters of this type capture a date. Filters of this type capture a date and time. Filters of this type capture a string Filters of this type capture a monetary field. This type of filter must also reference the cur mnemonic. Filters of this type capture a numeric field. This type of filter may also reference the decimals mnemonic. Filters of this type capture a lookup value. This type of filter must also reference the lookup mnemonic. Filters of this type capture an administrative table's value (code and description). This type of filter

Mnemonic	Description	Valid Values	Comments
			must also reference the table mnemonic.
		CHARTYPE	Filters of this type capture predefined characteristic values for a characteristic type (code and description). This type of filter must also reference the chartype mnemonic.
		ASIS	Filters of this type capture a list of values to be referenced within an 'IN' clause within the SQL statement.
label=	Defines the filter's label that appears in the zone's description bar.	FIELD_NAME	Enter a valid field name whose label should be used. This should always be the option used if multiple languages are needed.
		'text'	Defines the text directly.
cur=	Defines the currency code applied when type=MONEY .	CURRENCY_CD	Enter a reference to a valid currency code.
dec=	Defines the number of decimal places when type=NUMBER .	N	It is optional. If provided it should be an integer. If not provided, the number of decimals will default to the number of decimal places defined on the currency code specified on the installation record.
lookup=	Defines the lookup flag whose values appear when type=LOOKUP .	LOOKUP_FIELD_NAME	Enter a reference to a valid lookup field name.
table=	Defines the admin table whose values appear when type=TABLE .	TABLE_NAME	Enter a reference to a valid admin table name.
chartype=	Defines the characteristic type code whose values appear when type=CHARTYPE .	CHAR_TYPE_CD	Enter a reference to a valid characteristic type code.
searchField=	This mnemonic controls the initial population of the filter when the zone is launched as a search from a UI map.	FIELD_NAME	Enter the field name that exactly matches the searchField name specified in the oraSearchField html element in the UI map.

Multi-Select Action

This parameter defines an action to be included in the action area for multi-selection processing. Note that a multi-selection action can only be used if the Multi Select parameter has been set to YES, which causes a checkbox to appear on each row displayed. The action defined here will trigger against all rows selected by the user via the checkbox.

These parameters are applicable to the zone types

- Info Data Explorer - Multiple SQLs (**F1-DE**)
- Query Data Explorer - Multiple SQLs (**F1-DE-QUERY**)
- Info Data Explorer - Single SQL (**F1-DE-SINGLE**)

A multi select action has the following mnemonics:

Mnemonic	Description	Valid Values	Comments
script=	This mnemonic defines the script to be invoked when the action is clicked. This is required.	SCR_CD	Enter a reference to a valid BPA script or Service Script.

Mnemonic	Description	Valid Values	Comments
type=	This mnemonic defines how the action should be rendered.	BUTTON	The action is rendered as a button. This is the default.
		LINK	The action is rendered as hypertext.
		ICON	The action is rendered as a graphic icon. For this option, the icon mnemonic is required.
icon=	This mnemonic defines the icon to display when type=ICON .	DISPLAY_ICON_CD	Enter a reference to a valid display icon code.
refresh=	This mnemonic indicates how and if a refresh should occur after the script completes.	NO	Indicates that no refresh is performed. This is the default.
		ZONE	Indicates that a refresh of the zone is performed.
		PORTAL	Indicates that a refresh of the entire portal is performed.
label=	By default, the button label, link text or icon tooltip will come from the script description. Use this mnemonic to override that label.	FIELD_NAME	Enter a valid field name whose label should be used. This should always be the option used if multiple languages are needed.
		'text'	Enter the text directly in single quotes.
list=	When executing the script, the framework builds an XML list containing information from each row selected. This list must be defined in the script's schema and referenced in this mnemonic.	listElementName	Enter a valid list element name from the script schema.
context=[elementName1=rowData1 elementName2=rowData2]	This mnemonic is used to populate the list with the appropriate information from each selected row. The mnemonic supports passing multiple values. In each case the element in the schema list is defined first followed by an equal sign, followed by information about the data used to populate the element defined using one of the valid values defined in the next column. One or more values may be defined. Each context value is defined separated by spaces. The whole set of context values	Cx	Indicates that the element should be populated with a value in the referenced column parameter.
		Px	Indicates that the element should be populated with a value in the referenced post processing parameter.
		COLUMN_NAME	Indicates that the element should be populated with a value from a column in the SQL statement.
		'constant'	Indicates that the value defined in single quotes should be passed.

Mnemonic	Description	Valid Values	Comments
	<p>should be surrounded by square brackets.</p> <p>Example of a schema:</p> <pre><schema> <accountInfo type="list"> <accountId/> <name/> <amount/> <process/> </accountInfo> </schema></pre> <p>Example of list and context mnemonics.</p> <p>list=accountInfo</p> <p>context=[accountId=ACCT_ ID name=C2 amount=P3 process='O']</p>		
class=	Use this mnemonic to override the look and feel of the action using a different CSS style.	'className1' 'className2'	Enter one or more classes in single quotes to be appended to the standard class(es). Multiple class names may be provided.
style=	Use this mnemonic to override the look and feel of the action element using the indicated css style.	Standard style= format.	All allowed css style definitions may be used.

Data Explorer Graph Configuration

For some data explorer zones, it is more effective to display the results in a graphical form such as a pie or line chart. Visualization option parameters enable the graph configuration to be integrated with the data explorer zone that retrieves the data.

The visualization option parameters support three options:

- **Grid** - displays the data in a standard data explorer grid
- **Chart** - displays the data in the form of a chart
- **Map** - provides the ability to invoke a UI Map to display the data

Up to five visualization option parameters may be specified. One of the options must be the standard grid, allowing for a maximum of four graphical options. The zone will display icons corresponding to the visualization types to allow you to switch between the various views. These icons are presented in the same order as they are defined in the parameter list.

NOTE: If the only display option is a standard grid, it is not necessary to specify the grid as a visualization parameter.

Visualization option parameters are provided on the Info Data Explorer - Single SQL (**F1-DE-SINGLE**) and Info Data Explorer - Multiple SQLs (**F1-DE**) zone types.

Visualization Option Parameter Configuration

Mnemonics are used to define the attributes for an option type within the parameter value.

For a **grid**, the mnemonic is 'optiontype=GRID'. No other mnemonics are required.

For a **map**, the mnemonics are 'optiontype=MAP map=MAP_CD schemaPath=xpath', where 'MAP_CD' is the ID of the UI Map and 'xpath' is the schema path of the UI Map. In most use cases the schema elements will match the result set from

the data explorer, in which case no schemaPath mnemonic is needed. If the UI Map schema has additional elements present, the schemaPath attribute will define the group node that the data explorer information will be copied into.

For a **chart**, the option type mnemonics is 'optiontype=CHART'. This is followed by the appropriate chart configuration attributes, which are described in the section below.

Chart Configuration

The following attributes are used to configure a graphical representation of a set of data.

The '**oraChart:**' attribute defines the type of graph to display and its general configuration. The set of configuration parameters available for this attribute are as follows:

Parameter	Values	Description
type:	pie stacked cluster line area combo	Defines the type of chart to display. Required
showLegend:	true false	Defines if the chart should have a legend displayed. Optional (default is true)
legendPosition:	left right bottom top	Defines where the legend should appear. Optional (default is right) Setting position to left or right will automatically render it vertically. Setting position to top or bottom will automatically render it horizontally.
legendBorder:	true false	Defines if the legend should display with a border around it. Optional (default is false)
depth:	true false	A value of true indicates a 3 dimensional depth for the chart. Optional (default false , which is a 2 dimensional chart)
animate:	true false	A value of true indicates that the graph should animate when displayed. Optional (default is true). When using large data sets, consider disabling animation.
dataCursor:	on off	A value of on enables hovering anywhere in the graph. Optional (default is off). It is not applicable to pie charts.
orientation:	horizontal	Defines the chart orientation. This only applies to bar, line, area, combo charts.

Parameter	Values	Description
		E.g., oraChart="type:cluster; orientation:horizontal" , defines horizontal cluster chart. Optional (default is vertical).

The **oraChartSeries** attribute defines the source information for the graph. Most charts support 5 of these attributes, with the following mnemonics:

- **oraChartSeries1**
- **oraChartSeries2**
- **oraChartSeries3**
- **oraChartSeries4**
- **oraChartSeries5**

Stacked charts support an unlimited number of series by continuing to add attributes **oraChartSeries6** and above, but beware of performance implications and memory limits when using an excessively high number of series. All attributes are identical in format and accept the same parameters, as described below.

NOTE: All the charts require **oraChartSeries1**. Stacked, Cluster and Line charts may optionally include the additional series attributes (for multiple bars/lines).

If you define multiple series, then data must be provided for all series defined. The data amounts can be 0 (zero) but they have to be present in order for the chart to display correctly.

The set of configuration parameters available for the **oraChartSeriesN** attribute are:

Parameter	Values	Description
list:	XPath value	Defines the XPath to the list in the XML that contains the data to chart. Required only for HTML definitions in UI Maps. Data explorer values are derived from the columns for the zone.
amount:	Cn Pn XPath value	Defines the element containing the amount to chart. For data explorers, this will be a SQL or post-processing column identifier. For HTML definitions, the XPath of the element must be specified. Required
xaxis:	Cn Pn XPath value	Defines the element containing the x-axis data. For data explorers, this will be a SQL or post-processing column identifier. For HTML definitions, the XPath of the element is specified. Required for Stacked, Cluster, Line, Area and Combo charts.
xaxisFormat:	date dateTime time localDate	Defines the x-axis data format. If it is date , dateTime or time then the value is presented in the format as defined on the user's display profile.

Parameter	Values	Description
	string	In case of localDate or string the data is displayed as is with no special formatting. Optional (Default is date).
label:	Text value	Defines the label for the amount being charted. Either this setting or labelPath: must be defined.
labelPath:	Cn Pn XPath value	Defines the element that provides the label for the amount being charted. For data explorers, this will be a SQL or post-processing column identifier. For HTML definitions, the XPath of the element must be specified. Either this setting or label: must be defined.
currency:	A valid Currency code	Defines the currency code for the amount being charted. Optional.
currencyPath:	Cn Pn XPath value	Defines the element that provides the currency code for the amount being charted. For data explorers, this will be a SQL or post-processing column identifier. For HTML definitions, the XPath of the element must be specified. Optional.
hoverText:	Text value	Defines the hover text for the chart element. Optional (A default hover text is always available.) Ignored if hoverTextPath: is defined. The following substitution variables are available. <ul style="list-style-type: none"> • \$label This will be replaced with the label text as determined by the label: or labelPath: setting. • \$amount This will be replaced with the amount text as specified by the amount: setting. • \$axis This will be replaced with the x-axis text. • \$% This will be replaced by the percentage "slice" of the pie or bar. • \$newline This will force a line break. If the hover text defined contains any of the above values, they will be replaced by the equivalent text prior to being displayed. Example: "hoverText : \$label \$newline \$amount "

Parameter	Values	Description
hoverTextPath:	Cn Pn XPath value	<p>Defines the element that provides the hover text for the chart element. For data explorers, this will be a SQL or post-processing column identifier. For HTML definitions, the XPath of the element must be specified.</p> <p>The hover text in the element can utilize all the substitution functionality described above in the hoverText: description.</p> <p>Optional.</p>
type:	bar line area	<p>This attribute is used for the combo chart type only. It defines how each series on the combo chart should be presented.</p> <p>The following example defines a combo chart where one series is rendered as bars and another one as area.</p> <pre>oraChart="type:combo;" oraChartSeries1="xaxis:C3; label:C2; amount:C1;type:bar" oraChartSeries2="xaxis:C3; label:C2; amount:C1;type:area"</pre>
navOpt:	A valid Navigation Option code.	<p>Defines a navigation option to be activated when the chart element is clicked.</p> <p>Optional.</p>
navOptPath:	Cn Pn XPath value	<p>Defines the element that provides the navigation option to be activated when the chart element is clicked. For data explorers, this will be a SQL or post-processing column identifier. For HTML definitions, the XPath of the element must be specified.</p> <p>Optional</p> <p>Note that both navOpt: and navOptPath: may be configured. The navOptPath: navigation option is processed first. If a value is found it is used, otherwise the value in the navOpt: setting is used. This means that the chart definition can include a default navigation option and a navigation option present in the data will override it.</p>
key:	Cn Pn XPath value	<p>Defines the element that contains the key field data to be used in a navigation option. For data explorers, this will be a SQL or post-processing column identifier. For HTML definitions, the XPath of the element must be specified.</p> <p>This is required if either navOpt: or navOptPath: is defined.</p> <p>NOTE: Only one key field can be configured for a navigation option.</p>

Parameter	Values	Description
script:	A BPA script name	<p>Defines a BPA script to be activated when the chart element is clicked.</p> <p>Optional</p> <p>When a script is executed, all the elements from the chart data will be made available to the script as temporary variables.</p>
scriptPath:	Cn Pn XPath value	<p>Defines the element that provides the BPA script to be activated when the chart element is clicked. For data explorers, this will be a SQL or post-processing column identifier. For HTML definitions, the XPath of the element must be specified.</p> <p>Optional</p> <p>Note that both script: and scriptPath: can be configured. The scriptPath: script option is processed first. If a value is found it is used, otherwise the value in the script: setting is used. This means the chart definition can include a default script and a script present in the data will override it.</p>
color:	HTML Color code / RGB value	<p>Optional (default colors applied)</p> <p>Defines the color for the series. The format is a valid HTML color code, e.g. green or blue. All valid color names are defined in this link: http://www.w3schools.com/html/html_colornames.asp.</p> <p>Alternatively an RGB format may be used. (00FF00 is green and 0000FF is blue)</p> <p>NOTE: Refer to Color Contrast for information about the use of the HTML color 'red' and its impact on accessibility.</p>
colorPath:	Cn Pn XPath value	<p>Defines the element containing a color for the series. For data explorers, this will be a SQL or post-processing column identifier. For HTML definitions, the XPath of the element must be specified.</p> <p>The valid formats as described in the color: setting apply.</p> <p>Optional (default colors applied)</p>
pieColors:	HTML color code / RGB values	<p>Defines the colors for the pie series. Any number of HTML color codes or RGB color values can be specified, separated by spaces.</p> <p>Examples:</p> <pre>pieColors: green blue pieColors: 00FF00 0000FF</pre>

Parameter	Values	Description
		Optional (default colors are applied if the series exceeds the values specified)

The **oraChartBroadcast**: attribute provides the ability to broadcast a value from a chart to the portal context. An unlimited number of fields can be broadcast, configured as name/value pairs; for example: `oraChartBroadcast="FIELD_NAME1:C1;FIELD_NAME2:C2;"` where `FIELD_NAMEn` is the name of the portal context field to be broadcast and `Cn` (or `Pn`) is the element that contains the data value to be broadcast. Broadcast is triggered by clicking on a corresponding section of the chart.

For HTML definitions in UI Maps, the syntax is `oraChartBroadcast="FIELD_NAME1:xpath1;FIELD_NAME2:xpath2;"` where 'xpath_n' is the element in the list schema that contains the data value to be broadcast.

Zone Configuration Examples

Zone with a simple pie chart

In this example, the zone SQL summarizes To Do entries by Role. The column definitions are:

- C1 - role description
- C2 - count of To Do entries by role
- C3 - role ID

Visualization Option 1

This option shows To Do entries by Role as a pie chart. The role ID will be broadcast to the portal when the corresponding section of the pie chart is clicked.

```
optiontype=CHART
oraChart="type:pie;"
oraChartSeries1="labelPath:C1; amount:C2;hoverText:$label$newline$amount;"
oraChartBroadcast="ROLE_ID:C3"
```

Zone with two chart types

In this example, the zone SQL summarizes To Do entries by Priority and also calculates separate counts by To Do status within priority. The column definitions are:

- C1 - priority description
- C2 - count of To Do entries by priority
- C3 - priority flag value
- C4 - count of Open To Dos by priority
- C5 - count of Being Worked On To Dos by priority
- C6 - Label for the Open To Dos bar in the cluster chart
- C7 - Label for the Being Worked On To Dos bar in the cluster chart

Visualization Option 1

This option shows To Do entries by Priority as a pie chart. The priority value will be broadcast to the portal when the corresponding section of the pie chart is clicked.

```
optiontype=CHART
oraChart="type:pie; legendBorder:true;"
oraChartSeries1="labelPath:C1; amount:C2;hoverText:$label$newline$amount;"
oraChartBroadcast="TD_PRIORITY_FLG:C3"
```

Visualization Option 2

This option shows To Do entries by Priority as a cluster chart with two data series, one for Open To Dos and another for Being Worked On To Dos . The corresponding priority value will be broadcast to the portal when clicking either the Open or Being Worked on bar of the cluster chart.

```
optiontype=CHART oraChart="type:cluster; showLegend:true;"
oraChartSeries1="axis:C1; axisFormat:string; labelPath:C6; amount:C4;hoverText:$label$newline
$amount;"
oraChartSeries2="axis:C1; axisFormat:string; labelPath:C7; amount:C5;hoverText:$label$newline
$amount;"
oraChartBroadcast="TD_PRIORITY_FLG:C3"
```

Pagination Configuration

The various data explorer zones in the product support the ability to configure pagination so that a user can 'page through' a large set of results using "previous" and "next" buttons or links.

There are several zone parameters that are impacted when attempting to configure this functionality. The following steps highlight the configuration.

- The **Enable Pagination** parameter must be configured to define the basic setup for pagination for the zone. This parameter defines whether the "previous" and "next" actions are defined as buttons, links or icons and indicates the location of the actions. It also allows an indication as to whether the additional rows are simply appended, rather than shown in a new "page". Refer to the parameter's embedded help for information about the specific syntax.
- It is recommended that the zone is configured with record count and page information by properly configuring the **Record Count Display** parameter. Refer to the parameter's embedded help for information about the specific syntax.
- Configure the **Number of Rows to Retrieve for SQL** parameter to define the number of records displayed per page. If this parameter is not specified the value in the **Number of Rows to Display** parameter is used.
- Configure the key that will be used for paging so that the system can keep track of the 'page break'. The data must be sorted by the paging key; as a result, the decision for identifying the paging key must take into account the design for the zone and the data being displayed. In addition, the paging key must be unique to ensure that the page breaks occur correctly. See below for configuration examples.
 - The **SQL Statement** must include additional clauses **PAGENEXT** and **PAGEPREV** based on the paging key. In addition, as mentioned above, the paging key must be used in the ORDER BY clause.
 - The **SQL Column** parameters must define the paging key mnemonic to be used in conjunction with the SQL statement paging clauses.
 - It is recommended to configure the **SQL Display Column** parameter to show the data in the same order as the ORDER BY clause.

The following zone types support this capability:

- Info Data Explorer - Single SQL (**F1-DE-SINGLE**).
- Info Data Explorer - Multiple SQLs (**F1-DE**). Note that zones of this type support a union of the results of all the SQL statements. As a result, pagination may only be enabled for zones of this type if a single SQL is used. The system is not able to keep track of the pagination across disparate SQL statements.
- Query Data Explorer - Multiple SQLs (**F1-DE-QUERY**).
- Multi Query Data Explorer (**F1-DE-MULQRY**). Zones of this type do not include configuration for SQL statements or column display. However, they do include configuration for the **Enable Pagination**. This parameter must be configured in order for pagination on the individual zones to work.

NOTE:

Zones used for a Business Service. Note that pagination is ignored when invoking a data explorer zone via a business service. In this scenario, the zone will return the first "chunk" of rows as defined by the Number of Rows parameters.

Zones with data visualization options. Pagination is not supported for zones that define visualization options to show data in a graphical form.

Examples

Simple Paging Key

In this example, the Extendable Lookup Value is defined as Column 1 (C1) and is marked as the paging key. This field is unique for the table and works well as a simple paging key.

```
SELECT A.F1_EXT_LOOKUP_VALUE, A.BUS_OBJ_CD
FROM
  F1_EXT_LOOKUP_VAL A,
  F1_EXT_LOOKUP_VAL_L B
WHERE
  A.BUS_OBJ_CD = :H1
  AND A.BUS_OBJ_CD = B.BUS_OBJ_CD
  AND A.F1_EXT_LOOKUP_VALUE = B.F1_EXT_LOOKUP_VALUE
  AND B.LANGUAGE_CD = :LANGUAGE
  [(F1) AND UPPER(A.F1_EXT_LOOKUP_VALUE) like UPPER(:F1)]
  [(F2) AND ((UPPER(B.DESCR_OVRD) like UPPER(:F2))
  OR (B.DESCR_OVRD = ' ' AND UPPER(B.DESCR) like UPPER(:F2)))]
  [(PAGENEXT) AND A.F1_EXT_LOOKUP_VALUE > :C1]
  [(PAGEPREV) AND A.F1_EXT_LOOKUP_VALUE < :C1]
ORDER BY A.F1_EXT_LOOKUP_VALUE
```

Complex Paging Key

Most queries however do not sort by a unique value. In this case, the paging key needs to be set based on the sorting of the query and should include a unique field, such as the primary key, as the last paging key. In this example, the query is showing results sorted by To Do Type, Role and User. All fields, including the To Do Entry ID (the primary key) are marked as paging keys.

```
SELECT TD_TYPE_CD, ROLE_ID, ASSIGNED_TO, ASSIGNED_DTTM, TD_PRIORITY_FLG, TD_ENTRY_ID
FROM CI_TD_ENTRY
WHERE
  ENTRY_STATUS_FLG IN ('O', 'W')
  [(F1) and TD_TYPE_CD = :F1]
  [(F2) AND ASSIGNED_TO = :F2]
  [(F3) AND ROLE_ID = :F3]
  [(PAGENEXT) and ((TD_TYPE_CD>:C1) or (TD_TYPE_CD=:C1 and ROLE_ID>:C2) or (TD_TYPE_CD=:C1 and ROLE_ID=:C2
  and ASSIGNED_TO>:C3) or (TD_TYPE_CD=:C1 and ROLE_ID=:C2 and ASSIGNED_TO=:C3 AND TD_ENTRY_ID>:C4))]
  [(PAGEPREV) and ((TD_TYPE_CD<:C1) or (TD_TYPE_CD=:C1 and ROLE_ID<:C2) or (TD_TYPE_CD=:C1 and ROLE_ID=:C2
  and ASSIGNED_TO<:C3) or (TD_TYPE_CD=:C1 and ROLE_ID=:C2 and ASSIGNED_TO=:C3 AND TD_ENTRY_ID<:C4))]
ORDER BY TD_TYPE_CD, ROLE_ID, ASSIGNED_TO, TD_ENTRY_ID
```

Use Data Explorer for Derived Data

There are times when a design warrants displaying data in a data explorer zone that is not accessible via SQL. For example, perhaps the data is from another system and it requires a web service call. The [JMS Message Browser](#) is another example.

The product provides functionality in the data explorer that allows you to call a script after the user filters are populated but before the SQL is executed. The script can retrieve the data as appropriate, store the data in table format so that the SQL can retrieve the data from the table.

The following points provide more detail:

- Create a service script that retrieves the data as needed. This script should store the retrieved data in a temporary table.
 - The product provides a table that may be used. It is called F1_GENERIC_GTT (Generic Global Temporary Table). There is a business service — Create Global Temporary Table Records (**F1-InsertGTTRecords**) that the service script may call to insert the records.

- Note that if the data is accessed via a web service call, it may be appropriate to execute the web service in a separate session using the business service F1-ExecuteScriptInNewSession to trap errors that may be issued by the web service call and provide a better error.
- In the data explorer zone use this service script in the zone's pre-processing script parameter. If any user or hidden filters should be passed into the script, the parameter supports mnemonics for this purpose. Refer to the parameter's embedded help for the supported syntax.
- The SQL for the data explorer should access the temporary table that was populated by the service script.

Configuring Timeline Zones

This topic highlights information related to configuring a [timeline zone](#). The zone type is **F1-TIMELINE**. A timeline zone contains one or more "lines" where each line shows when significant events have occurred. The output of each line is driven by an algorithm configured on a timeline zone. Each algorithm is responsible for retrieving a single type of data. For example, one algorithm may retrieve bills for an account in a given time period whereas another algorithm may retrieve payments for that account for the same time period.

The algorithms to configure for a timeline zone use the **Zone - Timeline** plug-in spot. Please note the following details about the behavior for algorithms for this plug-in spot.

- The timeline algorithm receives all the global context values currently populated. In addition, it receives a start and end date from the zone, based on the time period chosen by the user, along with the maximum number of events that can be reasonably displayed for the chosen time period. The algorithm should use this information to retrieve data for a given type of transaction related to one or more of the input context values for the provided time period.
- For each event found, the algorithm returns information about the event along with many options that assist the user in getting more detail about each event or acting on an event.
 - Event date
 - Primary key of the record (key / value pairs)
 - FK Reference. With this information, the timeline zone will display the appropriate info string to display in the zone's info area when clicking on the event. In addition, the FK reference identifies the appropriate navigation option to use when a user clicks the info string hypertext to view the record on its maintenance page.
 - Background Color and Text Color to use for the event. (Obsolete). This information is no longer used by the timeline zone and will be ignored.
 - Icon use for the event. (Obsolete). This information is no longer used by the timeline zone and will be ignored.
 - [BPA script](#) to launch when a user clicks on an event. (Optional). The algorithm may return one or more BPA scripts that a user may launch to act on an event. For example, for an event that has a status of **Error**, perhaps a BPA is provided to walk a user through resolving the error.

When a script is initiated from a timeline, the system puts the prime key of the event into a field in the page data model. The name of the field is the column name(s) of the event's prime key. For example, when a script associated with a payment event is kicked off, the system populates a field called PAY_ID with the prime-key of the selected payment.

Note that your specific edge application may supply algorithm types for a timeline zone as part of the base product. Although algorithm types may be provided, typically the product does not deliver algorithms because the parameters for the algorithms are driven by a particular implementation's business rules and preferences. As a result, the product will also not deliver pre-configured timeline zones. Please refer to your edge application's documentation for more information about what timeline algorithm types are delivered, if any and recommendations for configuration.

Defining Context-Sensitive Zones

A context-sensitive zone allows you to associate a zone with a specific user-interface transaction. A context-sensitive zone appears at the top of the Dashboard when a user accesses a page for which the zone is specified as the context. For example, when viewing a business object, additional zones are visible that are specific to the business object page.

CAUTION: Make sure that the zone is appropriate for the transaction on which you are specifying it. For example, if your zone requires a business object ID as one of its keys, it should not be displayed on the To Do entry transaction.

Select **Admin > Context Sensitive Zone** to maintain context-sensitive zones.

Description of Page

The **Navigation Key** is a unique identifier of a tab page within the system. **Owner** indicates if this navigation key is owned by the base product or by your implementation (**Customer Modification**).

CAUTION: Important! When introducing a new context sensitive zone, carefully consider its naming convention. Refer to [System Data Naming Convention](#) for more information.

The grid contains the list of context-sensitive zones and the sequence in which they appear in the dashboard for the selected navigation key. The grid contains the following fields:

- **Zone** is the name of the zone to display in the Dashboard.
- **Sequence** is the sequence in which the zone is displayed (if multiple context-sensitive zones are defined).
- **Owner** indicates if this context sensitive zone is owned by the base product or by your implementation (**Customer Modification**).

Where Used

A context-sensitive zone displays at the top of the Dashboard whenever a user accesses the transaction for with the zone is specified.

Defining Portals

This portal is used to view and maintain the configuration of portals. An implementation may define their own portals or may override some of the settings for base product provided portals.

You can access the portal from the **Admin Menu > System > Portal**. You are brought to a query portal with options for searching for a specific record. Once a portal record has been selected you are brought to the maintenance portal to view and maintain the selected record.

NOTE: When introducing a new record, carefully consider its naming convention. Refer to [System Data Naming Convention](#) for more information.

Refer to [Understanding Portals and Zones](#) for more information.

The following zones may appear as part of the portal's **Main** tab page

- **Portal.** This zone provides information about the selected portal definition.
- **Options.** This zone lists various configuration options for the selected portal record.
- **Tabs.** This zone lists other tab portals if any are configured for a standalone portal. This zone is only visible when such tabs exist for the current standalone portal.
- **Context Sensitive Zones.** This zone lists context sensitive zones that appear on the dashboard when this portal is displayed . This zone is only visible when such zones exist for the current standalone portal.

Defining Menu Options

This portal is used to define / change any menu in the system. You can access the portal from the **Admin Menu > System > Menu**. You are brought to a query portal with options for searching for a specific menu. Once a menu has been selected you are brought to the maintenance portal to view and maintain the selected record.

CAUTION: Updating menus requires technical knowledge of the system. This is an implementation and delivery issue and should not be attempted if you do not have previous experience with menus.

NOTE: Security and menus. Refer to [Application Security](#) for a discussion of how application security can prevent menu items (or an entire menu) from appearing.

NOTE: Module configuration and menus. Your [module configuration](#) can prevent menu items (or an entire menu) from appearing.

The following zones may appear as part of the portal's **Main** tab page:

- **Menu.** This zone provides information about the selected menu.
- **Menu Lines.** This zone lists the menu's lines and supports actions to add, edit and delete lines. You may also broadcast a line to review more information about its items configuration.
- **Menu Line Items.** This zone lists item information for a selected menu line.

Application security information for the menu can be reviewed and managed from the **Application Security** tab. The following zones may appear as part of this tab page:

- **Menu Lines.** This zone lists the menu's lines. Broadcast a line to review its application security information.
- **Menu Line Security.** This zone lists application services related to the selected menu line. You may use this zone to review and configure security access for the selected menu line and a specific user group.
- **Menu Line Security Details.** This zone lists the entities secured by a selected application service.

The following zone may appear as part of the portal's **References** tab page:

- **Menu References.** This zone lists entities that reference the selected menu.

The following sections provides more information.

Menu Types

The following types of menus are supported:

- **Admin** is one of the menus that appears in the Application Toolbar. It is a special type of menu because [admin menu](#) items can be grouped alphabetically or by functional group. Refer to the description of Admin Menu Order on [Installation Options - Framework](#) for more information about admin menu options.
- **Main** is another menu that appears in the Application Toolbar that is simply titled [Menu](#).
- **Submenu** defines a menu group that appears when an Application Toolbar menu is selected. for the Admin menu, this is only visible when it's organized functionally.
- **Context** refers to a [context menu](#).
- **Page Action Menu** defines buttons that appear in the [Page Title Area](#).
- **User Menu** refers to the menu items that appear on the [user menu](#); for example, User Preferences.

Extending Product Owned Menus

An implementation may choose to add custom menu lines along with its menu item (or items) to a base product owned menu.

Overriding Menu Lines Sequence

An implementation may override the sequence of a base product owned menu line. Also note that the sequence is defined on the menu line language table, allowing for different orders to be used for different languages (or to let the menu be sorted alphabetically in one language and in a specified order in a different one).

Menu Information is Cached

Use the **Flush Menu** button to flush the cached menu items so you can see any modified or newly created menus. Refer to [Caching Overview](#) for more information.

Defining Navigation Keys

Each location to which a user can navigate (e.g., transactions, tab pages, tab menus, online help links, etc.) is identified by a navigation key. A navigation key is a logical identifier for a URL.

Navigation Key Types

There are three types of navigation keys:

- **System navigation keys** define locations where the target for the navigation is a transaction or portal within the system. The navigation keys define the program component that identifies the page to navigate to.
- **External navigation keys** define a URL that identifies the target location. External URLs can be specified as relative to the product web server or fully qualified. External navigation keys always launch in a new instance of a browser window. Examples of external navigation keys include application viewer links and URLs to external systems.
- **Help navigation keys** define a online help topic that identifies the specific page within the online help to launch. Help navigation keys may be related to a program component when the help is related to a specific page in system.

Navigation Key vs. Navigation Option

The system has two entities that work in conjunction with each other to specify how navigation works:

- **Navigation Key** defines a unique location to which a user can navigate. For example, each page in the system has a unique navigation key. Navigation keys can also define locations that are "outside" of the system. For example, you can create a navigation key that references an external URL. Think of a navigation key as defining "where to go".
- **Navigation Option** defines how a page is opened when a user wants to navigate someplace. For example, you might have a navigation key that identifies a specific page. This navigation key can then be referenced on two navigation options; the first navigation option may allow users to navigate to the page with no context included, while the second navigates to the page with context data provided to automatically display information related to that context.
- Please note that a wide variety of options can be defined on a navigation option. In addition to defining if data is passed to the page, it could also define search options. In addition, there are some navigation options that do not reference a navigation key but rather refer to a BPA script that should be launched.

The Flexibility of Navigation Keys

Navigation keys provide a great deal of functionality to your users. Use navigation keys to:

- Allow users to navigate to new pages or search programs
- Allow users to transfer to an external system or web page. After setting up this data, your users may be able to access this external URL from a menu, a context menu, their favorite links, etc. Refer to [Linking to External Locations](#) for more information.

Refer to the Tool Suite Guide for more information on developing program components.

NOTE: Replacing Base-Package Pages or Searches. If your new page or search has been designed to replace a module in the base-package, the navigation key must indicate that it is [overriding an existing navigation key](#).

Linking to External Locations

If you want to include links to external systems or locations from within the system, you need to:

- Define a [navigation key](#) that specifies the URL of the location. For example, define an external navigation key that as a URL of <http://www.oracle.com/>.
- Define a [navigation option](#) that specifies from where in the system a user can go to your external location. For example, define a navigation option with a usage of **Favorites** or with a usage of **Menu**. Your navigation option points to the navigation key you defined above.
- Add your navigation option to the appropriate location within the system. For example, have users add the navigation option to their [Favorite Links](#) or add the navigation option as an item on a [menu](#).

Overriding Navigation Keys

Your implementation may choose to design a program component (e.g., a maintenance transaction or search page) to replace a component provided by the system. When doing this, the new navigation key must indicate that it is overriding the system navigation key. As a result, any menu entry or navigation options that reference this overridden navigation key automatically navigates to the custom component.

For example, if you have a custom On-line Batch Submission page and would like users to use this page rather than the one provided by the system, setting up an override navigation key ensures that if a user chooses to navigate to the On-line Batch Submission from Menu or a context menu, the user is brought to the custom On-line Batch Submission page.

To create an override navigation key, you need to:

- Define a [navigation key](#) using an appropriate [naming convention](#).
- If the Navigation Key Type of the navigation key being overridden is **External**, specify a Navigation Key Type of **Override (Other)** and define the appropriate URL Component.
- If the Navigation Key Type of navigation key being overridden is **System**, specify a Navigation Key Type of **Override (System)** and populate the Program Component ID with your custom program component ID.
- Specify the navigation key that you are overriding in the **Overridden Navigation Key** field.

Refer to the Tool Suite Guide for more information about developing your own program components.

Maintaining Navigation Keys

Select **Admin > System > Navigation Key** to maintain navigation keys.

Use the **Navigation Key Query** portal to search for an existing navigation key. Once a navigation key is selected, you are brought to the maintenance portal to view and maintain the selected record.

CAUTION: Important! When introducing a new navigation key, carefully consider its naming convention. Refer to [System Data Naming Convention](#) for more information.

Description of Page

The **Navigation Key** is a unique name of the navigation key for internal use.

Owner indicates if this navigation key is owned by the base product or by your implementation (**Customer Modification**). This information is display-only.

Navigation Key Type includes the following possible values:

- **External** indicates that the location is specified in the **URL Component** field.
- **Help** indicates that the navigation key is used to launch online help where the specific help topic is defined in the **URL Component** field.
- **Override (Other)** indicates that the navigation key overrides another navigation key of type **External** or **Help**. For this option, the name of the navigation key being overridden is populated in the **Overridden Navigation Key** field.
- **Override (System)** indicates that the navigation key overrides a system navigation key. For this option, the name of the navigation key being overridden is populated in the **Overridden Navigation Key** field.
- **System** indicates that the navigation key refers to a transaction in the system identified by its program component.

FASTPATH: Refer to [Navigation Key Types](#) for more information about navigation key types.

FASTPATH: Refer to [Overriding Navigation Keys](#) for more information about settings required to override a system navigation key.

Program Component ID is the name of the program component identified by the key (for system navigation keys). The program component ID can also be used to specify the transaction with which an online help link is associated.

Overridden Navigation Key is the name of the navigation key that the current navigation key is overriding (if **Override (Other)** or **Override (System)** is selected for the **Navigation Key Type**). Refer to [Overriding Navigation Keys](#) for more information.

URL Component is the specific URL or portion of the URL for the navigation key (external and help navigation keys only). The URL can be relative to the product web server or fully qualified.

Open Window Options allows you to specify options (e.g., width and height) for opening a browser window for an external navigation key. (External navigation keys always launch in a new browser window.) You can use any valid features available in the `Window.open()` JavaScript method. The string should be formatted the same way that it would be for the features argument (e.g., **height=600,width=800,resizeable=yes,scrollbars=yes,toolbar=no**). Refer to a JavaScript reference book for a complete list of available features.

Application Service is the application service that is used to secure access to transactions associated with **External** navigation keys. If a user has access to the specified application service, the user can navigate to the URL defined on the navigation key. Refer to [The Big Picture of Application Security](#) for more information.

The grid displays menu items that reference the navigation key (actually, it shows menu items that reference navigation options that, in turn, reference the navigation key).

Defining Navigation Options

Every time a user navigates to a transaction, the system retrieves a navigation option to determine which transaction should open. For example:

- A navigation option is associated with every menu item. When a user selects a menu item, the system retrieves the related navigation option to determine which transaction to open.
- A navigation option is associated with every [favorite link](#). When a user selects a favorite link, the system retrieves the related navigation option to determine which transaction to open.
- A navigation option is associated with every node in the various trees. When a user clicks a node in a tree, the system retrieves the related navigation option to determine which transaction to open.
- Etc.

Many navigation options are shipped with the base product and cannot be modified as these options support core functionality. As part of your implementation, you may add additional navigation options to support your specific business processes.

Navigation options may also be used to launch a BPA script.

The topics in this section describe how to maintain navigation options.

CAUTION: In order to improve response times, navigation options are cached the first time they are used after a web server is started. If you change a navigation option and you don't want to wait for the cache to rebuild, you must clear the cached information so it will be immediately rebuilt using current information. A special button has been provided on the Main tab of the navigation option transaction that performs this function. Please refer to [Caching Overview](#) for information on the various caches.

Navigation Option - Main

Select **Admin > System > Navigation Option** to maintain a navigation option.

Use the **Navigation Option Query** portal to search for an existing navigation option. Once a navigation option is selected, you are brought to the maintenance portal to view and maintain the selected record.

Description of Page

Enter a unique **Navigation Option** code and **Description**.

CAUTION: When introducing a new navigation option, carefully consider its naming convention. Refer to [System Data Naming Convention](#) for more information.

The **Flush System Login Info** button is used to flush the cached navigation options so you can use any modified navigation options. Refer to [Caching Overview](#) for more information.

Owner indicates if this navigation option is owned by the base product or by your implementation (**Customer Modification**). This field is display-only. The system sets the owner to **Customer Modification** when you add a navigation option.

NOTE: You may not change navigation options that are owned by the base product.

Use **Navigation Option Type** to define if the navigation option navigates to a **Transaction**, launches a **BPA Script** or opens an **Attachment**.

NOTE: The **Attachment** option type is only applicable to navigation options that are used to launch a file attached to a record in the Attachment maintenance object.

For navigation option types of **script**, indicate the **Script** to launch. You can use the **Context Fields** at the bottom of the page if you want to transfer the contents of specific fields to temporary storage variables available to the script. The script engine creates temporary storage variables with names that match the Context Field names.

For navigation option types of **transaction**, define the **Target Transaction** (navigation key) and optionally a specific **Tab Page** (also a navigation key) if a specific tab on the transaction (other than the Main tab) should be opened when navigating to that transaction.

NOTE: Finding transaction navigation keys. When populating the **Target Transaction** and **Tab Page** you are populating an appropriate navigation key. Because the system has a large number of transactions, we recommend using the "%" metaphor when you search for the transaction identifier. For example, if you want to find the currency maintenance transaction, enter "%currency" in the search criteria.

The additional information depends on whether the target transaction is a fixed page or a portal-based page:

- For portal-based pages:
 - **Navigation Mode** is not applicable and should just be set to **Add Mode**.
 - If navigating to a query portal, by default the query portal will open with the default search option defined. If the navigation should open a different search option, define the **Multi-Query Zone** for that query portal and indicate the **Sub-Query Zone** to open by default. Note that for this configuration, it is common to define **Context Fields** to pre-populate search criteria in the target query zone. When using this configuration, be sure that the target query zone's [user filters](#) are defined to populate data from context.
- For fixed pages:
 - **Navigation Mode** indicates if the **Target Transaction** should be opened in **Add Mode** or **Change Mode**.
 - **Add Mode** should be used if the option is used to navigate to a transaction ready to add a new object. You can use the **Context Fields** at the bottom of the page if you want to transfer the contents of specific fields to the transaction when it opens.
 - **Change Mode** is only applicable for fixed pages and should be used if the option is used to navigate to a transaction ready to update an object. You have two ways to define the object to be changed:
 - Define the name of the fields that make up the unique identifier of the object in the **Context Fields** (and make sure to turn on **Key Field** for each such field).
 - Define the **Search Transaction** (navigation key) if you want to open a search window to retrieve an object before the target transaction opens. Select the appropriate **Search Type** to define which search method should be used. The options in the drop down correspond with the sections in the search (where **Main** is the first section, **Alternate** is the 2nd section, **Alternate 2** is the 3rd section, etc.). You should execute the search window in order to determine what each section does.

When you select a **Search Type**, define appropriate **Context Fields** so that the system will try to pre-populate the search transaction with these field values when the search first opens. Keep in mind that if a search is populated with field values the search is automatically triggered and, if only one object is found that matches the search criteria, it is selected and the search window closes.
 - **Search Group** is only visible if the **Development Tools** module is [not turned off](#). It is used to define the correlation between fields on the search page and the tab page. You can view a tab page's **Search Groups** by viewing the HTML source and scanning for **allFieldPairs**.

The **Go To Tooltip** is used to specify the label associated with the tool tip that appears when hovering over a **Go To** object. Refer to the **Usage** grid below.

The **Usage** grid defines the objects on which this navigation option is used:

- Choose **Favorites** if the navigation option can be used as a [favorite link](#).
- Choose **Menus** if the navigation option can be used as a user's [home page](#) or as a menu or context menu item.
- Choose **Script** if the navigation option can be used in a [script](#).
- Choose **Foreign Key** if the navigation option can be used as a [foreign key reference](#).

- Choose **Go To** if the navigation option can be used as a "go to" destination ("go to" destinations are used on Go To buttons, tree nodes, and hyperlinks).
- If your product supports marketing campaigns, you can choose **Campaign** if the navigation option can be used as a "post completion" transaction on a campaign. For more information refer to that product's documentation for campaigns.

The **Context Fields** grid contains the names of the fields whose contents will be passed to the **Target Transaction** or **Script** or used to launch an **Attachment**. The system retrieves the values of these fields from the "current" page and transfers them to the target transaction or to the script's temporary storage. Turn on **Key Field** for each context field that makes up the unique identifier when navigating to a transaction in **Change Mode**.

NOTE: For an **Attachment**, the grid should contain the Attachment ID.

NOTE: Navigating from a Menu. The standard followed for many base main **menu** navigation options for fixed transactions is that navigation options launched from the Menu dropdown are configured with no context.

Navigation Option - Tree

This page contains a tree that shows how a navigation option is used. Select **Admin > System > Navigation Option** and navigate to the **Tree** tab to view this page.

Description of Page

The tree shows every menu item, favorite link, and tree node that references the navigation option. This information is provided to make you aware of the ramifications of changing a navigation option.

Understanding System Messages

All error, warning and informational messages that are displayed in the system are maintained on the message table. Every message is identified by a combination of two fields:

- **Message category number.** Think of a message category as a library of messages related to a given functional area. For example, there is a message category for billing messages and another one for payment messages.
- **Message number.** A unique number identifies each message within a category.

Every message has two components: a brief text message and a long description.

NOTE: You cannot change the product's text. If the message is "owned" by the product, you cannot change the product's message or detailed description. If you want your users to see a different message or detailed description other than that supplied by the product, enter your desired verbiage in the corresponding override fields (and flush the [cache](#)).

Defining System Messages

This portal is used to search for message categories and messages that appear throughout the system. An implementation may introduce messages used in custom processes or may choose to override the text for messages delivered by the product.

You can access the portal from the **Admin Menu > System > Message**. You are brought to a query portal with options for searching for a specific message category or a message. Once a record has been selected you are brought to the maintenance portal to view and maintain the selected record.

Refer to [Understanding System Messages](#) for more information.

Defining Message Categories

This portal is used to view and maintain a message category and its messages.

CAUTION: Message category 80000 or greater must be used to define new messages introduced for a specific implementation of the system. Changes to other Message Text will be overwritten when you next upgrade. If you want to make a change to a Message, drill down on the message and populate the Override Message Text. Note that even for message categories 80000 and higher, message numbers lower than 1000 are reserved for common base product messages.

You can access the portal from the **Admin Menu > System > Message**. You are brought to a query portal with options for searching for a specific message category or a specific message. Once a message category has been selected you are brought to the maintenance portal to view and maintain the selected record.

Refer to [Understanding System Messages](#) for more information.

The following zones may appear as part of the portal's **Main** tab page

- **Message Category.** This zone provides information about the selected message category.
- **Messages.** This zone lists and maintains messages for the selected category.

Defining Messages

This portal is used to view and maintain a specific message. An implementation may introduce messages used in custom processes or may choose to override the text for messages delivered by the product.

CAUTION: Message category 80000 or greater must be used to define new messages introduced for a specific implementation of the system. Changes to other Message Text will be overwritten when you next upgrade. If you want to make a change to a Message, drill down on the message and populate the Override Message Text. Note that even for message categories 80000 and higher, message numbers lower than 1000 are reserved for common base product messages.

You can access the portal from the **Admin Menu > System > Message**. You are brought to a query portal with options for searching for a specific message category or a specific message. Once a message has been selected you are brought to the maintenance portal to view and maintain the selected record.

Refer to [Understanding System Messages](#) for more information.

The following zones may appear as part of the portal's **Main** tab page

- **Message.** This zone provides information about the selected message.

Understanding Unified Search

Depending on your product, the toolbar search box may support a product specific search for business entities in addition to the standard search for menu items. For example, the search may support a query of business entities by their name, address, contact details etc. The unified search feature is a simplified version of your product's main search, that allows the user to lookup up records using free form search text or hint codes. For more complex queries, the user may navigate to the corresponding advanced search portal.

The configuration of a unified search option includes the following items:

- A **search service script** that implements the data query and defines the supported **filters**. The application service associated with this script is used to secure the unified search option.

- **Search filter rules** and **hints** for the supported filters. These rules are used to parse the text entered by the user to determine whether it qualifies as a valid filter value.
- The **advanced search** portal to use for more complex queries.

The unified search box interacts with a unified search option implementation as follows:

- As the user types free form text in the search box, the application uses the **search filter rules** and **hints** to parse the entered text and translate it to corresponding query filters.
- The **search service script** is then called to query for entities that match these filters and present the results.
- Selecting a result record navigates to the corresponding portal.
- Selecting the **Advanced Search** link in the search box navigates to the general query portal associated with the unified search option.

If a unified search option is not enabled for your product or the user does not have security access to it then the search box may only be used for searching the menu.

The following sections describe various aspects related to the configuration of a unified search option.

The Search Script Controls Everything

A unified search is implemented as a single service script that controls the following:

- **Filters.** The script determines which filters are supported and how they are applied to return results efficiently. Each filter name must be a valid **Field** record.
- **Results.** The script returns a list of business entities that matches the query filters provided by the user, along with the navigation information needed to drill in to a selected record in the list.
- **Application security.** Only users that have access to the script's application service may use the unified search associated with the search script.
- **Override Advance Search.** The script may override the advanced search portal configured for the search option.

When the search box component initializes, the script is called once in **Prepare Search Details** mode to return the list of supported filter names. In this mode the script does not perform any query.

As the user types in text in the search box, the search box component analyzes the entered text to derive query filters and calls the search script in **Perform Search** mode to return matching results.

The search box component is designed to support any type of unified search implementation and as such, the interaction between the user interface component and the search script is generic. Filters are defined as name / value pairs and results for each matched entity includes details like primary, secondary and tertiary description lines, along with a line that describes the matching text for entry.

NOTE: If your organization needs to implement a custom unified search script, it is strongly recommended that you follow the base product's implementation of such scripts as a reference.

Filter Rules and Hints

A unified search is designed to support a predefined set of filters for querying data. For example, searching customers by their address, name, identifiers; or searching locations by address or name etc. Each filter is uniquely identified by a **Field** name as declared by the search service script.

As the user types in free text in the search box, the application applies parsing rules to determine whether the text may be used as the value of one or more filters supported by the unified search. For example, if the user types in the text "ave", parsing rules may determine that it can be used to filter results by a person's name or address but not their email address.

Each parsing rule, defined in the **Search Filter Rule**[extendable lookup](#), associates a filter's field name with a regular expression. Multiple filter rules defined for the same filter name are processed in execution order sequence and it is enough for one rule to return a match for the search text to be used as the value for the specific filter.

Alternatively, the user may use an explicit hint code to identify the filter they would like to use followed by the filter value. For example, an address filter may be associated with the hint "ad:" allowing the user to enter "ad: main" to look up records by address.

Each hint, defined in the **Search Filter Hint** extendable lookup, associates a filter's field name with a hint code.

Note that filter rules and hints are defined for a specific filter name and not a specific unified search option. The same parsing rules may be shared across searches using the same filter names. For example the parsing rule to identify an "email" filter or the "ad:" hint for an address filter are the same regardless of how these are used by a search query. These rules are automatically associated with any unified search option that uses the same filter names.

NOTE: You may customize the parsing rules and hints associated with a filter by inactivating the base product's extendable lookup records and introducing custom rules that match your business requirements.

Which Unified Search Option is Used?

Each unified search option is defined in the **Unified Search** extendable lookup, referencing the option's search service script and its corresponding advanced search portal. The unified search option is only enabled to users that have access to the search script's application service. When more than one unified search option is configured and enabled for a user, the application chooses the option with the highest sequence as the default option, allowing users to switch to other options they have access to.

Customizing Unified Search

You may customize the parsing rules and hints associated with base product search filters by inactivating the base product's extendable lookup records and introducing custom rules that match your business requirements.

If you need to support a search for different business entities and filters, you need to implement a custom unified search. The configuration of a unified search option involves the following high level steps:

- Design and implement a search script that supports a predefined set of filters and returns the topmost set of matching results while taking into account performance considerations.
- Design hints and filter rules as needed for each of the supported filters. Review existing hints and filter rules associated with same filter names when applicable.
- Register each hint, if any in the **Search Filter Hint** extendable lookup.
- Register each filter rule, if any in the **Search Filter Rule** extendable lookup.
- Register the search script in the **Unified Search** extendable lookup.

Trees

Many edge products and implementations make extensive use of UI tree structures to display hierarchical relationships between records in the system. The framework provides an objects to define a tree structure and the rules on how to populate the nodes in the tree, and processes to interpret the configuration and dynamically render the tree display.

The topics in this section provide information about what is supplied in the framework. Your product may supply UI components with ready built trees for common use cases. Refer to your product documentation for more information.

Common Attributes of Trees

Your organization may have many portals and zones showing data in a hierarchical tree. Most trees in the system follow a similar pattern:

- Trees have a number of levels. There may be different types of tree nodes present in any given level; for instance a list of algorithm types for a script, followed by a list of script steps. Icons may be displayed to further identify the node's object type.

- The most common node types reference an entity within the system such as a schema, script, data area and so on. These nodes usually display the information string from the entity's FK reference and provide the ability to navigate to the entity. They may also allow the node context to be broadcast to other zones in the portal.
- In addition to the ability to navigate to the associated entity, many node types provide a context menu with further navigation paths.
- Some nodes are simply informational and are used to group a set of child nodes below a type or category. For example, the business object Options tree groups the option value nodes below summary nodes that describe the option type.

Each tree defines the nodes that make up the tree and the parent/child relationship between those nodes. A tree node defines which of the common attributes are applicable to the node and the algorithms responsible for retrieving the node data and, optionally, determining the node information to be displayed.

Populate Node Algorithm

A tree node displays a combination of the attributes listed above, typically for an object in context. For a root node, the object will normally be derived from a global or portal context value, such as the current script. For each lower level node, the context is derived from the context fields of its parent row; for instance, algorithms for a specific algorithm type.

The key responsibility of the populate node algorithm is to receive the tree code, node name and the parent context value (or values), determine if there is data that should be shown for this node, and return the a list of the context fields and values applicable to each row in the node. The following highlights additional optional information that may be returned by the algorithm:

- Entity information. If the node is related to a specific entity, the maintenance object code and primary key values may be returned. These are used for determining default information for the node, including navigation details.
- A display icon value. This is used to override the icon defined on the tree node and/or the default icon for the entity as defined on the maintenance object or business object.
- An information string. This may be used to override the default information string for an entity or to display stand-alone text such as a summary or description of the child nodes to follow.

NOTE: The populate node algorithm is responsible for returning all the context values required to populate its child nodes. For an informational or summary node, this may require including the node's parent context fields in its own context. For example, in the script tree, the summary node describing the number of steps is followed by a list of steps for the script. The summary node populate node algorithm needs to include the script code passed in as parent context in its output context list, in order for the steps to be correctly retrieved.

Information Override Algorithm

The information override algorithm has two main purposes:

- Providing alternative information text for a tree node when the information provided isn't suitable for your implementation.
- Retrieving contextual insights related to the tree node entity, to be included in the node's information text. Only badge insight types are currently supported.

The override information algorithm receives the tree code, node name, maintenance object and prime key values for the node. The following highlights the information that may be returned by the algorithm:

- A display icon value.
- An information string. This will be used to override the default information string in the node's formatted string.
- Full node text. This will be used as the full text for the display, overriding the formatting defined on the node.
- A list of badge insight types and their context.

NOTE: If the information override algorithm returns insight types for the entity, it is also responsible for returning all the context values required for those insight types. Refer to [Contextual Insights](#) for more information.

Preparing a Node for Display

The following section highlights key steps in fetching a node's data and formatting it for display.

Determining Node Content

The following steps are performed to retrieve the components making up the tree node display:

- The Populate Node algorithm is called to determine all instance nodes for the tree node along with their related details.
- The Information Override algorithm is called for each node instance to allow for optional override of presentation related details.

The node display contents are determined as follows:

- The icon is determined from the following sources, in order: tree node definition, override information algorithm value, populate node algorithm value, maintenance object / business object default value.
- Broadcast usage is determined by the setting on the tree node definition.
- The information string is determined from the following sources, in order: override information algorithm value, populate node value, maintenance object / business object information algorithm. If the string is derived from the MO/BO algorithm, the short information text is used when available else the standard information is used.
- Context menu usage is determined by the settings on the tree node definition.
- The system supports a different style for header rows, including a larger font. Header style usage is determined by the setting on the tree definition and is only applicable if the node is a root node with only one instance.

Node Text Format

The text for nodes referencing a system entity commonly includes some combination of a label, the entity key and an information string. The node configuration provides a label field and a substitution format string field which may be used to define the node text format. The format string defines which of the three components should be included in the text, the order of those components and any surrounding text and HTML markups. For example, a format string of '%label - %key - %info' will result in a node text like the example below:

▶  Algorithm Type - F1_PROSTINFO - Process Flow Information

If the format string is blank, the default text will include '%info' only. If an override information algorithm is configured that returns the full node text, the text is presented without further formatting.

Auto Expansion

If the tree node definition indicates that the node should be expanded, the system will automatically fetch and display the data for its child node. This processing continues until there are no further child nodes marked for expansion.

Base Delivered Trees

Trees are system data and your product may already deliver several trees out of the box. You may choose to customize a base delivered tree in the following ways:

- You may add your own nodes to an existing tree definition.
- You may override the information string for a node by supplying your own **Information Override** algorithm. If a base override algorithm is configured on the node, your custom algorithm should be plugged in at a higher sequence number, to take precedence over the base algorithm.

Rendering a Tree

To render a tree on the UI, you would include the ou-tree web component in a UI map that references the tree definition.

NOTE: Refer to [Include a Web Component](#) for more information.

Defining Trees

This portal is used to view and maintain information about a tree definition. Trees are commonly used to display hierarchical relationships between objects in the system. Refer to [Trees](#) for background information about defining trees.

You can access the portal from **Admin > System > Tree**. You are brought to a query portal with options for searching for a specific tree definition. Once a tree has been selected you are brought to the maintenance portal to view and maintain the selected record.

The following zones will appear as part of the portal's **Main** tab page

- **Tree.** This zone provides information about the selected tree.
- **Tree Nodes.** This zone lists the nodes for this tree in hierarchical order. Use the zone actions to add or maintain a node in the tree.
- **Tree Node.** This zone displays the details for a tree node. It is only visible if a tree node name has been broadcast from the Tree Nodes zone.

Contextual Insights

Contextual Insights provide a powerful way to surface focused intelligence and alerts to users in the context of the core screens for any applications built on Oracle Utilities Application Framework. There are multiple options for the visual patterns when surfacing Contextual Insights and the actions that can be performed by users are easily configurable as well. The subsequent topics provide detail about the Insight Type and Insight Group objects that are used to configure the information that may then be displayed in appropriate screens.

Insight Types

The insight type object contains all the detailed configuration for displaying one or more alerts / important information for a record in context. The following sections provide more information about all the configuration managed by the insight type.

Insight Algorithm

Each insight type is used to display some information, typically related to an object in context. It is the responsibility of the insight type algorithm to receive the context value (or values), determine if there is information that should be shown for this context, return the text to display.

The following highlights additional optional information that may be returned by the algorithm:

- A secondary message. This is only applicable to some visual structures where more than one line of information may be displayed.
- A severity value. This is used to override the visual display configuration if different emphasis should be used for different severity values. Refer to [Override Configuration](#) for more information.
- Entity information. If the insight is related to a specific entity, the maintenance object code and primary key values may be returned. This is useful if the insight type configures a BPA or user action algorithms that may perform logic for this entity.
- Navigation and User Action information. This is only applicable to visual structures that support user actions. The algorithm must return the list of all the actions that should be made visible on the insight. If the action includes navigation, the algorithm should return the navigation option and navigation context key and value pairs. Additionally, there is configuration for each action that must be defined. Refer to [User Actions](#) for more information.

Each algorithm can return multiple insights, if applicable. For example, if the insight is about To Do entries related to the object being displayed, you could design your insight algorithm to return a single insight summarizing all the To Do related information. Or you could choose to return separate insights based on To Do information so that you provide more granular information and customize actions or navigation based on the different conditions. For example, if there are To Do Entries that the current user may perform actions on and others that current user cannot update, the algorithm could return two separate insights: one with actions and one without.

NOTE: Preview mode. The insight type maintenance page includes an Insight Preview section that shows the output from the insight algorithm when invoked with an insight mode of "Preview". Every algorithm should include logic that returns appropriate text when called in this mode so that something is displayed in that section.

Visual Structures

Each insight type defines a visual structure which dictates what kind of information may be shown. The system has some fixed layout expectations for each visual structure type. The insight type configuration is used to provide the source for the possible layout.

NOTE: All the insights use color options as part of their configuration. Refer to [Color Option](#) for more information.

Badge Insight

The simplest visual structure is the badge. It is used to display a single line of quick text with a solid background (for visibility) that is meant to alert the user to important summary information or attributes.

A blue rounded rectangular badge with the text "3 Related To Dos" in white.

Inline Insight

The inline insight defines an icon and a single message. This is meant to be more descriptive than a badge. For this type of insight, a default light background is used so the recommendation is to select a color option for both the text and the icon that has only a foreground color defined or has a light background color.

An inline insight consisting of a small icon of a calendar with a checkmark, followed by the text "3 Related To Dos" in a light green color.

List Insight

The list insight are intended to exist in a list of insights for the object. It defines an icon and can support two lines of text. In addition, this type of insight supports buttons or user actions. Refer to [User Actions](#) for more information. Note that for a list insight, if there is one valid action or 2 valid actions, the action buttons are shown. If there are three or more valid actions, one action is shown and then an 'Other Actions' button is visible. Clicking this shows the other available actions.

Note that the background color for the insight is used as the color for the full insight snippet. The text and the icon are shown on this background. The icon's background color is ignored.

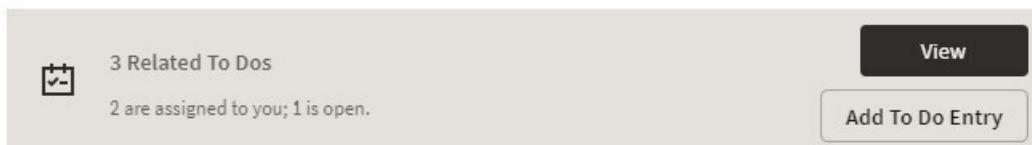

Card

The card insight is the most information rich, with up to two lines of text, [user actions](#), a large icon to call attention and header text. The header text is chosen from a dropdown list of valid options. The product provides out of the box header text of "Information", "Warning" and "Error". Implementations may add additional values to this using the lookup field `HEADER_CAT_FLG`.

Please note the following about the treatment of the various components of the card insight:

- The header text is rendered like a badge insight.

- For the message text displayed in the card, the background color is ignored so a color option with no background color or a light background color should be chosen.
- For the icon, the background color is used to create a square area for display and the icon is rendered in the foreground color.

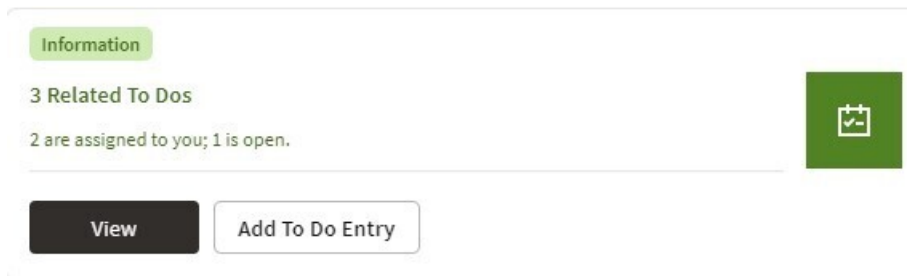

Override Configuration

Each insight supports default visual setting for the various components of the insight. This includes the color option for the applicable components along with icons and header text, where applicable. In each case, override visual settings may be defined for a given severity number.

For example imagine the algorithm for a badge insight that returns a message with the count of related To Do entries uses a different color option if there are more than 10 related records. To do this, the algorithm can return a severity number and then the configuration user can define the override color option for this severity number.



User Actions

The list and card insights support the definition of user actions that may be presented as buttons when displaying the insight. The actions may do one or more of the following:

- Perform algorithm logic. One or more user action algorithms may be associated with an action button. This should be used to perform server logic that does not require any user interaction. For example, you can provide an action to update the status of a record related to the insight. These algorithms are configured on the Insight Type.
- Navigate to another page. For this type of action, the insight algorithm must provide the navigation context and the navigation option to launch when clicking the button. It's possible to configure navigation and configure user action algorithms. In that case the algorithms are run first and then the navigation occurs.
- Launch a BPA. This is used if there is user interaction needed to perform additional logic and / or if there is conditional navigation such that the logic is needed before navigating. It's possible to configure a BPA and configure user action algorithms. In that case the algorithms are run first and then the BPA is launched. If the insight algorithm also provides navigation for this action, it is ignored in favor of the BPA. The BPA is configured on the Insight Type.

The list of valid actions to display at run time must be returned by the insight algorithm. This allows for the algorithm to have control over which actions to display, in case there are some actions that are conditional. In addition, each possible button requires configuration related to what text should display and the style of the button.

Button Text

The button text to display is chosen from a button text lookup. The lookup name is **INSIGHT_ACT_FLD_FLG**. Implementations may add additional values to this lookup to include new button text. In addition, if you would like to change button text on any product delivered button, you can override the lookup value description.

Action Class

Each action button defines an action class. Any action configured with the action class value of **Positive** value is shown first and is styled differently for emphasis. Other action class values are for information purposes.

Base Delivered Insight Types

Insight types are system data and your product may already deliver several insight types out of the box. You may choose to include one or more insight types in an [Insight Group](#).

Rendering an Insight

To render an insight for an insight type, you would include the ou-insights web component in a UI map that references this insight type. This is how the Insight Preview section of the insight type maintenance page renders the preview.

NOTE: Refer to [Include a Web Component](#) for more information.

Defining Insight Types

The insight type entity is used to define the configuration of a specific type of alert to display extra information related to one or more records in context. Refer to [Insight Types](#) for a detailed description of the supported functionality.

To view or maintain insight types, open **Admin > General > Insight Type**.

This is a standard [All-in-One portal](#).

The information captured on the insight type depends on the record's business object. Refer to the embedded help text for more information.

Related Insight Groups

If there are any insight groups that reference this insight type, the **Related Insight Groups** zone displays the linked insight groups.

Insight Groups

An insight group may be used to include several [insight types](#) together onto a single map. When defining an insight group, you configure the visual structures that the insight group should include. Only insight types for the configured visual structure are available.

Insight Class

Each insight group must reference a unique insight class. The insight class is defined using a lookup. The lookup field is **INSIGHT_CLASS_FLG**. Your product may already deliver base values for insight class. To display insights in a user interface your UI map would include the ou-insights web component. This component includes syntax to reference an insight class and the logic will find the insight group for that class and render all the insight types linked to that group.

Because the insight class is used as the reference in the web component rather than the insight group, it allows your product to supply base logic to show insight group information in a base delivered user interface. The base logic defines an insight class in base and references it on a base UI map. Your implementation can then define the insight group for this insight class and choose the insight types that should be rendered in that map. Refer to your specific product documentation to find out if there are any base delivered insight classes.

If your implementation identifies a new use case where one or more insight types should be displayed, once the insight types are configured, do the following:

- Define a new Insight Class lookup value.
- Define an Insight Group that references this insight class and configure the appropriate insight types.
- Include the appropriate [web component](#) in the map for your user interface where you wish to display this information.

Defining Insight Groups

The insight group entity allows implementations to define multiple related insight types that should be displayed together in a given user interface map or zone. Refer to [Insight Groups](#) for an overview of insight group configuration and functionality.

To view or maintain insight groups, open **Admin > General > Insight Group**.

This is a standard [All-in-One portal](#).

The information captured on the insight group depends on the record's business object. Refer to the embedded help text for more information.

Related Insight Types

The **Related Insight Types** zone displays all the insight types that are currently linked to the group. The Edit link in the zone header allows you to add or remove insight types. Only insight types that reference one of the **Valid Visual Structures** may be selected.

Color Configuration

The topics in this section describe some options for configuring colors to be used in displaying information in the user interface.

Defining Colors

The system provides the [extendable lookup](#) Color (**F1-Color**) to define valid colors to be used in the system. The base colors provided are ones related to the standard color palette used in Oracle products.

At this time, zones and UI maps that define specific colors do not support any syntax to reference a color extendable lookup. In the meantime, colors applied at the zone or map level can still reference HTML colors or reference hex codes directly.

Color Options

The color option entity is used to define a combination of colors to be used in user interface components. The system provides a standard set of color options used for contextual insights.

To view or maintain color options, open **Admin > System > Color Option**.

This is a standard [All-in-One portal](#).

The information captured on the color option depends on the record's business object. Refer to the embedded help text for more information.

Defining Display Icons

Icons are used to assist users in identifying different types of objects or instructions. A limited number of control tables allow administrative users to select an icon when they are configuring the system. Select **Admin > System > Display Icon** to maintain the population of icons available for selection. You are brought to a query portal with options for searching for a specific display icon. Once a display icon has been selected, you are brought to the maintenance portal to view and maintain the selected record.

The latest standard is to use Scalable Vector Graphic (SVG) icons. For these types of icons, the Icon Type is **Variable (SVG)**. The product also supports icons in the .gif or .png format. For these types of icons, the Icon Type defines a pixel size.

URL describes where the icon is located (folder) and the icon name (file name).

Note that there is a standard folder structure for delivered assets such as images. The structure is **{DefaultWebApp}/
{owner}/assets/images|svgs/**

- {Owner} - this is the owner of the icon. The **/cm** folder is used for custom icons.
- svgs - all images that are of type svg are in this folder.
- images - all files that have a file suffix of jpg, gif, png or other types of image formats are in this folder.

When using the above folder structure, then the URL only needs to contain the icon name (file name). The correct full URL is determined automatically at runtime. Images can optionally be placed in other folders under the DefaultWebApp. However, this is not recommended but if used, the URL must contain the full path to the icon (e.g. **/cm/assets/newImages/myIcon.gif**)

Custom Look and Feel Options

The default look and feel of the application can be customized via feature configuration and cascading style sheets. The base product is provided with a **Custom Look And Feel Feature Configuration** type. You may want to set up a feature configuration of this type to define style sheet and UI Map help options.

User Interface

The base product allows for the conditional inclusion of custom style sheets into the system style set. Custom styles may override any style provided by the base product. The style sheet may also include new styles for use in customer zone definitions. Use the **Style Sheet** option on the **Custom Look And Feel Feature Configuration** to define your custom style sheet.

NOTE: Some styles cannot change if they are part of the HTML code.

CAUTION: Implementers must ensure that the customized user interface is stable and scalable. Changing font, alignment padding, border size, and other user interface parameters may cause presentation problems, like scrollbars appearing or disappearing, cursors not working as expected, and unanticipated look and feel alterations of some layouts.

UI Map Help

A **tool tip** can be used to display additional help information to the user. This applies to section elements as well as individual elements on a map zone or UI Map. Refer to the tips context sensitive zone associated with the UI Map page for more information. The **Custom Look And Feel Feature Configuration** provides options to control the following:

- Whether UI Map Help functionality is turned on or off. By default it is turned on.
- Override the default help image with a custom image
- The location of the help image, either before or after the element.

FASTPATH: Refer to the feature configuration for a detailed description of each option.

Database Options

This section describes a variety of database tools that are supplied with the your product.

Understanding The Data Model

The application uses meta-data to describe its data model, from plain description of its tables and fields to more complex hierarchies of maintenance objects.

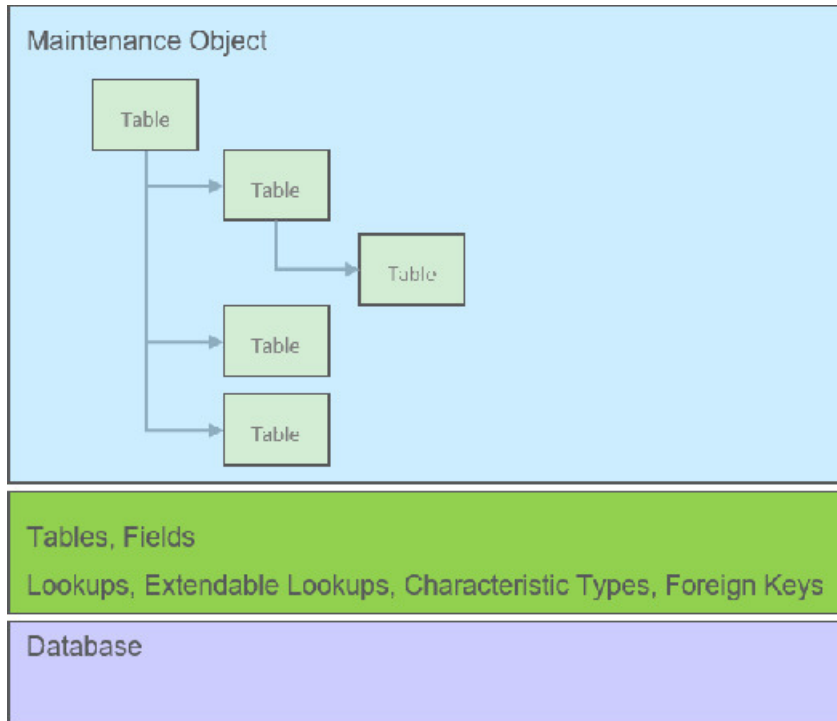

The following points briefly outline key aspects of application's data model as illustrated in this diagram:

- Table and Field records describe all the tables maintained by the application.
- Valid values for certain fields are defined using corresponding Lookup and Extendable Lookup records.
- Characteristic types may be defined to support an extension of a maintenance object via its characteristics table.
- Maintenance Objects define the physical structure of an entity. Business objects further refine maintenance objects to describe business entities. Refer to [The Big Picture of Business Objects](#) for more information.
- Foreign Key References define ways for searching and navigating to the maintenance portal of an entity.

The following sections further discusses concepts and guidelines related to the data model.

Fields

A Field definition describes the metadata needed by the application to support the capture and display of a piece of information. Fields may correspond to physical columns on database tables or represent any type of element used for calculation or presentation purposes.

The definition includes the following key details:

- Whether the field refers to a physical column on a database table or used as a work field.
- The type of data the field holds.
- The label to use when the field is presented.
- The help text to display when the user clicks on the help icon seeking additional information about this field.

- and more

The following sections further discuss concepts and guidelines related to defining fields.

Physical vs. Work Fields

A Field definition record exists for every physical column on a database table that is used by the application. Refer to [Understanding Tables](#) for more information.

A Field that does not represent a physical column on a database table is considered as work field and needs to be marked as such. Work fields are typically used as labels as well as describe internal elements used in business rules.

Data Type Information

The type of data captured by a field is defined using the following attributes:

- **Data Type** indicates the basic type of value the field holds. Valid values are **Character**, **Character Large Object**, **Date**, **DateTime**, **Number**, **Time**, **Varchar2** and **XML Type**.
- **Extended Data Type** is used to further define the type of data for certain data types. Valid values are **Currency Source**, **Day of Month**, **Duration**, **Money**, **Month of Year**, **Flag**, **Switch** and **URI**.
- **Precision** defines the length of the field. In the case of variable length fields, it is the maximum length possible. For number fields that include decimal values, the precision includes the decimal values.
- **Scale** is only applicable for number fields. It indicates the number of decimal places supported by the field.
- **Sign** is only applicable for numbers. It indicates if the data may contain positive or negative numbers.

Data Type Inheritance

A Field can be defined to inherit its data type attributes from the definition of another field. The field to inherit the attributes from is referenced as the **Base Field**. When using a base field reference, the data type attributes are defined once, on the base field, and all the fields inheriting their data type information from it are kept consistent with that definition as it may change over time. Any change of a field's data type attributes is automatically reflected on all the fields that reference it as their base field.

Data type information may either be specified directly on the field itself or by referencing a base field. The system does not support a way to partially override the base field's data type information.

It is recommended to leverage data type inheritance whenever possible, especially when the reason for creating a new field is to provide an alternate label for the original field in a certain context. In that situation the new field should reference the original field as its base field and provide the new labels and help text as needed.

Labels and Help Text

For fields that appear on a user interface, the description acts as a label to be used for presentation purposes. As per the product's multi-language support, a field is associated with a label for each of the languages enabled in the system.

A field's help text may be used to provide the user with additional information on how the field is used. When populated for a field that is visible on a user interface that supports display of embedded help, a help icon appears for the field, presenting the help text to the user when clicked.

Overriding Labels and Help Text

The label and help text provided for a product owned field may be overridden by your organization using the corresponding override fields.

The field's label and help text can be overridden for a specific table by populating the corresponding override information as part of the table / field definition. However, this override is not used in portal based user interfaces. It is only applicable if the field is displayed on fixed page user interfaces. For fixed pages, if the override label at the table / field level takes precedence over the override at the field level.

Alternate Labels

There are contexts where a separate label may be needed for the "date" and "time" parts of a date/time field. Such an example is when the field is used by the operational analytics product. For example, for a "Completion Date/Time" field you may provide the context label "Creation Date" for the **Date** context and "Creation Time" for the **Time** context. These context labels are optional.

In the same way, date fields, time fields and date/time fields may be associated with a **Date and Time Base** context label, which is a label without a reference to the word "Date", "Time" or "Date / Time". For example, for a "Completion Date/Time" field, the date and time base label may be "Completion". This label that can be used in combination with date or time attributes such as day, month, year, hours, minutes etc.

Overrides labels are available for these additional context labels.

Tables

A Table definition describes the metadata needed by the application to work with and access a database table or view.

The definition includes the following key details:

- The table's description in the application.
- The list of [fields](#) defined on the table and any foreign key constraints they establish with other tables.
- The table's prime key and how it is generated.
- Whether the table holds administrative, master or transactional data.
- Whether the table is released with product owned system data rows or not.
- The table's role in the conversion process.
- How should table content be upgraded.
- and more

The following sections further discusses concepts and guidelines related to defining tables.

System Tables

Tables released with rows that are owned by the base product are referred to as system tables. These tables include the **Owner** (OWNER_FLG) field to capture the owner of each row.

Refer to [System Data](#) for more information about naming conventions and standards around row record ownership.

The **Upgrade** setting on the table definition record controls what happens to the rows in a table when the system is upgraded to a new release. The most common setting allows customer owned rows to be merged with rows owned by the base product. Other settings may keep the content of the table as is, i.e. rows are not touched by the upgrade, or fully refresh the content of the table with base product rows.

Some fields on certain system owned tables are explicitly marked to allow customization. This means implementation are allowed to change these specific fields for a base owned record. Changes to the field value of one of these types of fields by an implementation are maintained when upgrading to a new version of the product.

Designated Table Roles

Some tables are designed to support the following application roles:

- **Key Tables**
 - A key table holds a copy of a table's prime key only and is only applicable to tables with system generated keys.
 - Tables with a system generated keys reference their Key Table as part of their Table definition record.

- Records in the key table remain in the system even when the related entity is archived, preventing the same key from being allocated to a new record. Retaining the key allows the system to keep the integrity of any references that may still exist to the archived entity.
- **Language Tables**
 - To support multi-language implementations, all labels and descriptions that are presented to a user are kept in a designated language table where a row exists for each enabled language.
 - The product is released with the English content provided in the various language tables. An additional row is added to these tables for each enabled language along with the translated content for that language. Refer to [Support For Different Languages](#) for more information.
 - Tables associated with language sensitive fields reference their corresponding Language Table as part of their Table definition record.
- **Characteristics Tables**
 - Many entities in the system support one or more Characteristics tables, which are used to capture additional fields for the object that are not already supported by the entity's provided attributes.
 - A Characteristics table is designed to capture characteristics applicable to its specific entity only. The entity associated with a Characteristics table is referenced on the Table's definition record.
 - Refer to [Setting Up Characteristic Types & Values](#) for more information.
- **Entity Log Tables**
 - Many entities in the system support the ability to capture lifecycle and other important business events on a designated log table.
 - A log table captures the event details in the form of an application message and stores any parameters for the message in a child log parameters table. All log and log parameters tables follow a predefined structure allowing them to be consistently and efficiently implemented.
 - Typically log tables do not participate in the conversion process.

Table Constraints

Foreign key relationships between tables are not enforced at the database level but rather at the application level, providing the application more flexibility around data manipulation and referential integrity.

The following types of constraints may be defined on the Table's definition record:

- **Primary Key** represents the field or set of fields that represent the unique identifier of a record stored in a table.
- **Logical Key** represents an alternate unique identifier of a record based on a different set of fields than the Primary key.
- **Foreign Key** represents a field or set of fields that specifies identifying and non-identifying relationships to other tables in the application. A foreign key constraint references the primary key constraint of another table.
- **Conditional Foreign Key** represents rare relationships between tables where a single field (or set of fields) may reference multiple primary key constraints of other tables within the application as a foreign key.

The system leverages a table's foreign key constraints information to performs referential integrity validation when rows in this table are deleted. These validations can be disabled by checking off the **Enable Referential Integrity** field on the Table definition record.

Table Indexes

The indexes delivered by the base product for a given table are visible in the index metadata. In addition, table index information may be defined as part of the cloud services support for generation of custom tables in certain use cases. Refer to the section [Generating Custom Tables](#) below for more information.

Primary Key Type

A table's primary key may be of the following types:

- **User-defined** means the user specifies the key when a record is added. This type of key is typically used for configuration and administrative tables.
- **System-generated** means a program generates a random numeric key for the record when it is added.
 - This type of table is typically associated with a key table. Refer to the **Designated Table Roles** section for more information.
 - System generated keys may be fully random or partially inherited from a parent table's key for performance reasons. Refer to the **System Generated Keys** for more information.
- **Sequential** means a sequence number is incremented whenever a record is added to the table. The next number in the sequence determines the key value.
- **Database Native Sequential Key** means a unique number is assigned using a database sequence object.
- **Other** means some other business rule allocates the table's prime-key or the prime key is made of multiple parts.

System Generated Keys

In general, randomly generated numeric system keys are used to attempt to evenly distribute records across a full range of possible IDs. Batch programs that use multiple threads will typically divide the threads using ID ranges and evenly distributed keys will help spread out the work across these threads.

If a table using a system generated key is a child of another table, the child table's key may **inherit** a portion of the random number from its parent table's key. Key inheritance for child records further extends the performance benefit. When considering partitioning, the recommendation for DBAs is to range partition data based on the primary key so that different batch threads operate on different partitions which reduces contention for hot blocks. Ideally the number of batch threads will be an exact multiple of the number of partitions. Batch programs that insert child data (for example batch Billing creation) also benefit from this design especially when the child tables are partitioned in the same way. The parent is often the driver of the batch process. If this is multi-threaded, then each thread is processing a set of parent records in a given ID range and all child records are being inserted into the same ID range.

While most entities with system generated keys either use fully random keys or partially inherited keys from a single parent, entities may be designed to implement more specific key generation rules.

When key inheritance is used, the table definition of the child table defines the following information:

- The number of most significant digits from the parent record's primary key to use as the **prefix** for the child record's key value.
- The **parent key field name** to inherit the key from. This information is provided for display and documentation purposes only and is only provided when the inheritance rule implemented by the entity may be documented this way. Typically the child key value is inherited from a single parent key but in some cases the inheritance rule may be more complex. For example, different types of records in the same child table may inherit their key from different parent key fields. In this case, multiple parent field names may be listed to describe the various inheritance options. When the rule is too complex, this information may not be provided on the table definition record.

Conversion Options

The conversion process manages the process by which master and transaction legacy data, loaded into a staging schema, is validated and assigned new system generated keys before it is copied to the production schema. Refer to [Understanding The Conversion Process](#) for more information.

The tool classifies tables into the following roles:

- Administrative tables. These only exist in the production schema. Instead of a table, a view to the production table exists in the staging schema. These views are necessary to enforce foreign key references when data is validated in the staging schema
 - Convertible tables that retain their prime keys. Data conversion is supported for these tables and their prime key values remain unchanged.
 - Convertible tables that require a new system generated key to be assigned. Data conversion is supported for these tables and their prime key is reassigned by the system during conversion.
 - Not convertible tables. Assigning new system generated keys for a record and replacing all foreign key references it might have with the new key is a complicated process that may not be supported for all tables.
- . The **Data Conversion Role** setting on the table definition record controls if / how the table is used by conversion processing.

Date/Time Configuration

Fields capturing date/time information may be designed to store data in either local legal time or local standard time. Local legal time is captured as entered and displayed as captured in the database. It also assumes the date/time information refers to the time zone defined on the installation options. Refer to [Standard vs. Legal](#) for more information.

Generating Custom Tables

For cloud customers and for certain use cases, the product supports defining table metadata for custom tables and generating the related DDLs for that metadata in the database. For these custom tables, there is a Generation Status visible on the Table metadata that identifies where the Table is in the lifecycle for this supported feature. In addition, the index tab on the table portal is used to define custom indexes that are included in the DDL as part of this feature. If you are a cloud customer and would like more information, refer to the Cloud Services Implementation Guide.

Maintenance Objects

A maintenance object defines the configuration of a given “entity” in the system. It includes a primary table and any additional child tables that together capture the physical data for the entity. The application reads, adds, updates and deletes an entity as a single object by invoking its maintenance object service.

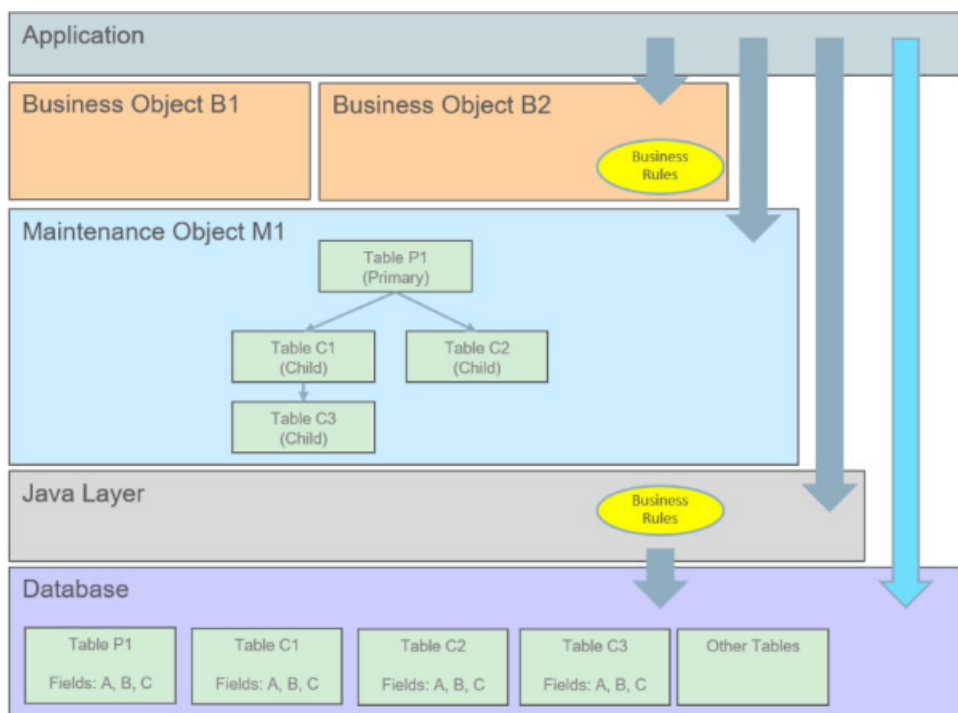

The following points briefly outline key aspects of application's interaction with maintenance objects as illustrated in this diagram:

- Database tables are maintained solely via the application's Java layer. Direct updates to a table via its Java class is not common and typically reserved to special processes.
- A maintenance object orchestrates the update to an entity's primary table and its child tables as a single object.
- A business object defines a logical representation of an entity, including all or a subset of the maintenance object's tables and fields.
- The more common way to maintain an entity is via its maintenance object, either directly or via one of its business objects. Most entities support the use of business objects and as such their maintenance is typically made via their business objects.
- Direct access to database tables is supported for query purposes only.

The following sections further discusses concepts and guidelines related to defining tables.

Maintaining An Entire Object

A maintenance object includes a single primary table and one or more child tables where each child table can further have nested child tables. The table structure of a maintenance object represents the scope of data that should be maintained together as a single object:

- When an object is added, data is added to each corresponding table.
- When an object is updated, data is updated in each corresponding table.
- When an object is read, data is retrieved from all the tables.
- When an object is deleted, data is deleted from all the tables.

Algorithms

Several algorithm plug-in spots are also defined on the maintenance object, allowing for business rules that govern all records for this maintenance object.

Options

The maintenance object includes options that define important information related to the maintenance object that may be accessed for logic throughout the system.

Maintenance Objects vs. Business Objects

A maintenance object defines the physical structure of an entity as stored in the database. Different business objects may be defined on top of a maintenance object to represent different types of such entity. A business object includes only the relevant information applicable to the specific type of entity as well as enforces business rules applicable only to that type.

When a maintenance object supports business object configuration, the system uses the **Determine Business Object** maintenance object algorithm to determine the identifying business object that controls a given entity's data structure and rules.

Refer to [The Big Picture of Business Objects](#) for more information.

Defining Valid Values

The product provides several options for defining valid values for a column on a table:

- Lookup
- Extendable Lookup
- Control Table

The following provides more information about the functionality of each of the options available for defining valid values for a column.

Lookup

The simplest mechanism for defining valid values for a column on a table is via the Lookup table. This is sometimes referred to as a “simple” lookup to distinguish it from an extendable lookup (described below). Using the lookup table, you can define valid values and their descriptions. When choosing a valid value that is defined by a lookup, a dropdown UI metaphor is used.

The following highlights functionality related to lookups:

- Lookups are associated with a **Field**. The field is defined as a character data type with an extended data type of **Flag**. The field's label serves as the description for the prompt to select the valid value.
- The lookup code is limited to four characters and must be all uppercase. If there is any functionality where a valid value in the application must match valid values in an external system, the lookup table may not be the appropriate choice.
- The lookup table does not support additional attributes to be defined for each value. This option is only appropriate when a simple code and description pair is needed.
- The product may also use Lookups to define valid values for functionality unrelated to a column on a table. For example, an algorithm plug-in spot may define an input parameter that supports one or more valid values. The plug-in spot may define the valid values using a lookup, allowing for a simple way to validate the value supplied when invoking the algorithm and to document the valid values.

FASTPATH: For more information, refer to [Defining Lookup Options](#).

Extendable Lookup

The extendable lookup provides a way of defining valid values for a column with additional capabilities that are not supported using the Lookup table. When choosing a valid value that is defined by an extendable lookup, a dropdown UI metaphor is used.

The following highlights functionality related to extendable lookups:

- Each Extendable Lookups is defined using a business object.
- A field should be defined for the extendable lookup code. The field defines the label for the lookup code and defines the size of the lookup code. The size is determined based on the business use case. In addition, there are standard fields included in all extendable lookups, including a description, detailed description and an override description (so that implementations can override the description of base delivered values).
- The extendable lookup may define additional information for each value if warranted by the business requirement. See [Additional Attributes](#) for technical information about additional attributes.

FASTPATH: For more information, refer to [Defining Extendable Lookups](#).

Control Table

There may be scenarios where a list of valid values warrants a standalone maintenance object, which is considered an administrative or control table object. When choosing a valid value that is defined by a control, either a dropdown UI metaphor or a search metaphor is used, depending on how it has been designed.

The following points highlight some reasons why this option may be chosen:

- The records require a lifecycle such that BO status is warranted.
- The additional attributes are sophisticated enough that they warrant their own column definition rather than relying on using CLOB or flattened characteristic. For example, if a list of information needs to be captured with several attributes in the list and the information in the list needs to be searchable.

In this situation, if a product has provided a control table for this type of functionality, it will be documented fully in the appropriate functional area. If an implementation determines that a custom control table is warranted, all the standard functionality for a maintenance object is required: database tables, maintenance object metadata, appropriate Java maintenance classes, portals, zones, etc. Refer to the Software Development Kit for more information. No further information is provided in this section for this option.

Characteristic Types

Many maintenance objects in the system support characteristics tables, which are used to capture additional fields for the object that are not already supported by the object's provided attributes. Each characteristic is associated with a characteristic type, which defines attributes of the field you wish to capture.

While each characteristic is stored in a separate row in the characteristic table, the user interface metaphor used to capture and display them differ based on the type of page that is used to maintain the object.

- For portal based pages, the business object drives the display and maintenance of the object. The display and maintenance of each characteristic is determined by the business object's user interface design. For these types of pages, it is recommended that characteristics are defined as flattened elements allowing the user interface to display the characteristic as if it is another field. Refer to [The Flattening Nodes and Attributes](#) for more information about flattening characteristics on a business object schema.
- There are some fixed pages in the system that do not support customization of the user interface. For these objects, the characteristics are displayed / maintained as a generic list.

The topics in this section describe various aspects of a characteristic type definition and usage.

Characteristic Value Types

Every characteristic referenced on an object references a characteristic type. The characteristic type controls the validity of the information entered by a user when they enter the characteristic's values. For example, if you have a characteristic type on user called "skill", the information you setup on this characteristic type controls the valid values that may be specified by a user when defining another user's skill.

When you setup a characteristic type, you must classify it as one of the following categories:

- **Predefined Value.** When you setup a characteristic of this type, you define the individual valid values that may be entered by a user. A good example of such a characteristic type would be one on User to define one or more predefined skills for that user. The valid values for this characteristic type would be defined in a discreet list.
- **Ad hoc Value.** Characteristics of this type do not have their valid values defined in a discreet list because the possible values are infinite. Good examples of such a characteristic type would be ones used to define a user's birth date or their mother's maiden name. Optionally, you can plug-in an algorithm on such a characteristic type to validate the value entered by the user. For example, you can plug-in an algorithm on a characteristic type to ensure the value entered is a date.
- **Foreign Key Value.** Characteristics of this type have their valid values defined in another table. For example perhaps you want to link a user to a table where User is not already a foreign key. Valid values for this type of characteristic would be defined on the user table. Before you can create a characteristic of this type, information about the table that contains the valid values must be defined on the [foreign key reference table](#).
- **File Location.** Characteristics of this type contain a URL. The URL can point to a file or any web site. Characteristics of this type might be useful to hold references to documentation / images associated with a given entity. For example, the image of a letter sent to you by one of your customers could be referenced as a file location characteristic on a customer contact entry. When such a characteristic is defined on an entity, a button can be used to open the URL in a separate browser window.

File location characteristic values must be entered in a "non-relative" format. For example, if you want to define a characteristic value of *www.msn.com*, enter the characteristic value as `http://www.msn.com`. If you omit the `http://` prefix, the system will suffix the characteristic value to the current URL in your browser and attempt to navigate to this location when the launch button is pressed. This may or may not be the desired result.

NOTE:

Due to browser security restrictions, opening URLs using the file protocol ("file://") from pages retrieved using http does not work. If the file protocol is used, the browser either does not return properly or an error is thrown (e.g., "Access Denied", which usually results from cross site scripting features added for security reasons). This issue has no known workaround. To comply with browser security standards, the recommendation is to move the target files to an FTP or HTTP server location to avoid protocols that are subject to browser security restrictions.

Also note that the functionality described in the topics for [Referencing URIs](#) do not apply to this value given that the browser is responsible for connecting to the URI and does not go via server logic.

For references to a file, the recommendation is to use the Attachment functionality to link a file to an object rather than a characteristic type of File Location. Refer to [Attachment Overview](#) for more information. The documentation related to file location remains for upgrade purposes.

Searching By Characteristic Values

For certain entities in the system that have characteristics, you may search for a record linked to a given characteristic value. The search may be done in one of the following ways:

- Some base searches provide an option to search for an object by entering Characteristic Type and Characteristic Value.
- Your implementation may define a customized search for an entity by a characteristic value for a specific characteristic type using a query data explorer.
- Your implementation may require a business service to find a record via a given characteristic value. For example, maybe an upload of user information attempts to find the user via an Employee ID, defined as a characteristic.

Not all entities that support characteristics support searching by characteristics. To confirm if a given characteristic table supports searching, verify that it includes the field **SRCH_CHAR_VAL**.

CAUTION: For ad-hoc characteristics, only the first 50 bytes are searchable. For foreign key characteristics, the search value is populated by concatenating the values of each foreign key column to a maximum of 50 bytes.

For the base searches that provide a generic option to search by characteristic type and value, you can restrict the characteristic types that can be used to search for an entity. For example, imagine you use a characteristic to define a "jurisdiction" associated with a To Do for reporting purposes. If your company operates within a very small number of jurisdictions, you wouldn't want to allow searching for a To Do by jurisdiction, as a large number of To Do entries would be returned.

A flag on the [characteristic type](#) allows an administrator to indicate if searching by this characteristic type is **allowed** or **not allowed**.

Data Typing an Ad-hoc Characteristic Value

An **Ad hoc Value** characteristic type may further restrict the data type of the captured value by referencing a Field. When populated, the system validates that the captured characteristic value complies with the data type definition of the referenced field.

Valid Characteristic Entities

Characteristics are stored in designated tables, each associated with a unique characteristic entity value referenced on the table definition record. A characteristic type record lists all the valid characteristic entities it is allowed to be captured on.

Customizing Base Owned Characteristic Types

Implementations may customize the following aspects of a base owned characteristic type:

- Extend the list of valid values for a base owned **Predefined Value** characteristic type to include additional custom values. Such extension is only supported if the characteristic type is defined with the **Custom** option turned on.
- Provide a custom algorithm to validate an **Ad hoc Value** characteristic type.
- Indicate whether characteristics of this type may be used in searches.
- Extend the list of entities associated with the characteristic type.

Foreign Key References

A Foreign Key Reference defines the necessary information needed to reference an entity in a certain table.

You need to set up this control table if you need to validate a foreign key value against a corresponding table. For example, if a schema element is associated with an FK Reference the system validates the element's value against the corresponding table. Refer to [Configuration Tools](#) to learn more about schema-based objects. Another example is characteristics whose valid values are defined in another table (i.e., you use "foreign key reference" characteristic types). Refer to [Characteristic Types](#) for a description of characteristics of this type.

A FK Reference is used not just for validation purposes. It also used to display the standard information description of the reference entity as well as provide navigation information to its maintenance transaction. Info descriptions appear throughout the UI, for example, whenever an account is displayed on a page, a description of the account appears. The product provides base product FK references for many of its entities as they are used for validation and display of elements in both fixed page user interfaces as well as portal based user interfaces.

An implementation may also see the need to define a foreign key reference. The following points describe what you should know before you can setup a foreign key reference for a table.

- The physical name of the table. Typically this is the primary table of a maintenance object.
- The program used by default to construct the referenced entity's info description.

- The transaction used to maintain the referenced entity. This is where the user navigates to when using the "go to" button or hyperlink associated with the entity.
- The name of the search page or zone used to look for a valid entity.

The topics in this section describe various aspects of a foreign key reference definition and usage.

Information Description Is Dynamically Derived

Typically a FK Reference is defined for a maintenance object's primary table. In this case the system dynamically derives the standard information associated with a specific referenced entity as follows:

- Attempt to determine the business object associated with the referenced entity. Refer to the [Determine BO](#) maintenance object algorithm system event for more information. If a business object has been determined, the system lets the business object's [Information](#) plug-in, if any, format the description.
- If a business object has not been determined or the business object has no such plug-in, the system lets the maintenance object's [information](#) plug-in, if any, format the description.
- If the maintenance object has no such plug-in, the system uses the info program specified on the FK Reference to format the information.

NOTE: Technical note. The class that returns the information displayed adjacent to the referenced entity is generated specifically for use as an info routine. Please speak to your support group if you need to generate such a class.

NOTE: Generic routine. The system provides a generic information routine that returns the description of control table objects from its associated language table. By "control table" we mean a table with an associated language table that contains a **DESCR** field. Refer to [Defining Table Options](#) for more information on tables and fields. The java class is `com.splwg.base.domain.common.foreignKeyReference.DescriptionRetriever`.

Navigation Information Is Dynamically Derived

Typically a FK Reference is defined for a maintenance object's primary table. In this case the system dynamically derives the actual transaction to navigate to for a given referenced entity as follows:

- Attempt to determine the business object associated with the referenced entity. Refer to the [Determine BO](#) maintenance object algorithm system event for more information. If a business object has been determined, use the maintenance portal defined as its **Portal Navigation Option** business object option.
- If a business object has not been determined or the business object defines no such option, the system uses the transaction specified on the FK Reference.

Search Options

The product provides two main metaphors for implementing a user interface. For input fields that are foreign keys, search options are dependent on the metaphor used by the page in question.

- A [portal based](#) user interface is a more flexible user interface where an implementation has more options for customizing the look and feel. The base product uses UI maps or automatic UI rendering to display input fields. Elements that are foreign keys may display a search icon if the FK reference defines a Search Zone.

NOTE: Defining search zones directly. It's possible for elements on a UI map to define a specific search zone directly in the HTML, rather than using the search zone defined on an FK reference. Refer to the UI map tips for more information on implementing searches using zones.

- A [fixed maintenance page](#) user interface is a page supplied by the base product where only minor enhancements, if any, can be introduced by implementations. The foreign key reference may be used in one of two ways.

- The based product may use an FK reference to define a base element on one of these pages. If a search is available for such elements, the FK reference's Search Navigation Key is used to implement the search.
- Entities that support characteristics typically include a generic characteristic collection UI metaphor on these types of pages. In this metaphor, a foreign key characteristic displays a search icon if the FK Reference has configured a Search Navigation Key.

NOTE: Not every FK reference provided with the product is configured with a search option. This may be the case if the base delivered pages use a dropdown for this foreign key rather than a search. In addition, base provided FK references that do provide a search may not be configured with both search options. It means that if linking this type of object as a characteristic, the search may not be available if the appropriate search is not configured.

Defining Tables

This portal is used to view and maintain information about an application table.

You can access the portal from the **Admin Menu > Database > Table**. You are brought to a query portal with options for searching for a specific table. Once a table has been selected you are brought to the maintenance portal to view and maintain the selected record.

Refer to [Tables](#) for more information.

The following zones may appear as part of the portal's **Main** tab page

- **Table.** This zone provides information about the selected table.
- **Fields.** This zone lists all fields of the selected table and provides various actions to maintain this information.

The following zones may appear as part of the portal's **Relationship** tab page

- **Entity Relationship Diagram.** This zone provides a visual representation of the table's relationship to other tables in the application's data model.

The following zones may appear as part of the portal's **Constraints** tab page

- **Table Constraints.** This zone lists the various key constraints defined for the selected table and provides various actions to maintain this information.
- **Referred By Constraints.** This zone lists all tables referring to the selected table via foreign key constraints.

Refer to [Tables](#) for more information.

The following zones may appear as part of the portal's **Indexes** tab page

- **Table Indexes.** This zone lists the indexes defined for the selected table and provides various actions to maintain this information.

Refer to [Tables](#) for more information.

Defining Fields

This portal is used to view and maintain information about a field. For product owned fields, you may use this portal to override the label of a field on the various pages in the system.

You can access the portal from the **Admin Menu > Database > Field**. You are brought to a query portal with options for searching for a specific field. Once a field has been selected you are brought to the maintenance portal to view and maintain the selected record.

NOTE: When introducing a new record, carefully consider its naming convention. Refer to [System Data Naming Convention](#) for more information.

Refer to [Fields](#) for more information.

The following zones may appear as part of the portal's **Main** tab page

- **Field.** This zone provides information about the selected field.
- **Tables Using Field.** This zone lists tables referencing the field. It is not visible for work fields.
- **Lookup Values.** This zone lists and maintains valid values for the selected lookup field. The zone is only visible when the selected field is a lookup field.

The following zone may appear as part of the portal's **References** tab page

- **Field References.** This zone list various configuration entities referencing the current field.

Defining Maintenance Objects

A maintenance object defines the configuration of a given “entity” in the system. It includes the definition of the tables that together capture the physical data for the entity. In addition, the maintenance object includes options that define important information related to the maintenance object that may be accessed for logic throughout the system. Several algorithm plug-in spots are also defined on the maintenance object, allowing for business rules that govern all records for this maintenance object.

Many maintenance objects in the system support the use of business objects to further define configuration and business rules for a given record. Refer to [Maintenance Objects](#) for more information.

Maintenance Object - Main

Navigate to **Admin > Database > Maintenance Object** to view information about a maintenance object.

Use the **Maintenance Object Query** portal to search for an existing maintenance object. Once a maintenance object is selected, you are brought to the maintenance portal to view and maintain the selected record.

Description of Page

Most maintenance objects are provided with the base package. An implementation can introduce custom maintenance objects when needed. Most fields may not be changed if owned by the base package.

Enter a unique **Maintenance Object** name and **Description**. **Owner** indicates if this business object is owned by the base package or by your implementation (**Customer Modification**).

IMPORTANT: If you introduce a new maintenance object, carefully consider its naming convention. Refer to [System Data Naming Convention](#) for more information.

Service Name is the name of the internal service associated with the maintenance object.

The grid displays the following for each table defined under the maintenance object:

- **Table** is the name of a given table maintained as part of the maintenance object.
- **Table Role** defines the table's place in the maintenance object hierarchy. Only one **Primary** table may be specified within a maintenance object, but the maintenance object may contain many **Child** tables.
- **Parent Constraint ID** specifies the [constraint](#) used to link the table to its parent table within the maintenance object table hierarchy.
- **Owner** indicates if this is owned by the base package or by your implementation (**Customer Modification**).

Maintenance Object - Options

Use this page to maintain a maintenance object's options. Open this page using **Admin > Database > Maintenance Object** and then navigate to the **Options** tab.

Description of Page

The options grid allows you to configure the maintenance object to support extensible options.

Select the **Option Type** drop-down to define its **Value**. **Detailed Description** may display additional information on the option type.

Set the **Sequence** to **1** unless the option can have more than one value.

Owner indicates if this is owned by the base package or by your implementation (**Customer Modification**).

NOTE: You can add new option types. Your implementation may want to add additional maintenance option types. For example, your implementation may have plug-in driven logic that would benefit from a new type of option. To do that, add your new values to the customizable lookup field **MAINT_OBJ_OPT_FLG**.

Maintenance Object - Algorithms

Use this page to maintain a maintenance object's algorithms. Open this page using **Admin > Database > Maintenance Object** and then navigate to the **Algorithms** tab.

Description of Page

The **Algorithms** grid contains algorithms that control important functions for instances of this maintenance object. You must define the following for each algorithm:

- Specify the **System Event** with which the algorithm is associated (see the table that follows for a description of all possible events).
- Specify the **Sequence Number** and **Algorithm** for each system event. You can set the **Sequence Number** to 10 unless you have a **System Event** that has multiple **Algorithms**. In this case, you need to tell the system the **Sequence** in which they should execute.
- If the algorithm is implemented as a script, a link to the **Script** is provided. Refer to [Plug-in Scripts](#) for more information.
- **Owner** indicates if this is owned by the base package or by your implementation (**Customer Modification**).

The following table describes each **System Event**.

System Event	Optional / Required	Description
Audit	Optional	Algorithms of this type are called to notify of any changes to the maintenance object's set of tables. These algorithms are invoked just before the commit at the end of a logical transaction. The system keeps track of what records are added or changed in the course of a transaction and all MO audit algorithms are executed in order of when each record was first added or updated.
Determine BO	Optional	Algorithm of this type is used to determine the Business Object associated with an instance of the maintenance object. It is necessary to plug in such an algorithm on a Maintenance Object to enable the business object rules functionality. The system invokes a single algorithm of this type. If more than one algorithm is plugged-in

System Event	Optional / Required	Description
ILM Eligibility	Optional	<p>the system invokes the one with the greatest sequence number.</p> <p>Algorithms of this type are used for maintenance objects that are enabled for object erasure for Information Lifecycle Management. They are used to review records that have reached the maximum retention days and evaluate if they are ready to be archived.</p> <p>The system invokes a single algorithm of this type. If more than one algorithm is plugged-in the system invokes the one with the greatest sequence number.</p>
Information	Optional	<p>We use the term "Maintenance Object Information" to describe the basic information that appears throughout the system to describe an instance of the maintenance object. The data that appears in this information description is constructed using this algorithm.</p> <p>The system invokes a single algorithm of this type. If more than one algorithm is plugged-in the system invokes the one with the greatest sequence number.</p>
Manage Erasure Schedule	Optional	<p>Algorithms of this type are used for maintenance objects that are enabled for object erasure, which is a measure to protect Data Privacy. They are triggered when certain system events occur for those objects. The algorithms are used to determine if the record needs to be scheduled for erasure and, if so, create or maintain an entry for the record in the Object Erasure Schedule.</p>
Revision Control	Optional	<p>An algorithm of this type is used to enforce revision control rules when an object is added, changed or deleted. The maintenance object service calls the plug-in once before the object is processed and once more after applying all business object rules. This allows revision rules to take place in proper revision timings.</p>
Transition	Optional	<p>The system calls algorithms of this type upon each successful state transition of a business object as well as when it is first created. These are typically used to record the transition on the maintenance object's log.</p> <p>Note that most base maintenance objects are already shipped with an automatic logging of state transitions. In this case you may use these algorithms to override the base logging functionality with your own. Refer to State Transitions are Audited for more information.</p>
Transition Error	Optional	<p>The system calls this type of algorithm when a state transition fails and the business object should be saved in its latest successful state. The algorithm is responsible for logging the transition error somewhere, typically on the maintenance object's log.</p> <p>Notice that in this case, the caller does NOT get an error back but rather the call ends successfully and the exception is recorded somewhere, as per the plug-in logic.</p> <p>The system invokes a single algorithm of this type. If more than one algorithm is plugged-in</p>

System Event	Optional / Required	Description
		the system invokes the one with the greatest sequence number.

NOTE: You can inactivate algorithms on Maintenance Objects. Your implementation may want to inactivate one or more algorithms plugged into the base maintenance object. To do that, go to the options grid on Maintenance Object - Options and add a new option, setting the option type to **Inactive Algorithm** and setting the option value to the algorithm code.

Maintenance Object - Maintenance Object Tree

You can navigate to the **Maintenance Object Tree** to see an overview of the tables and table relationships associated with the maintenance objects.

Description of Page

This page is dedicated to a [tree](#) that shows the maintenance object's tables as well as [business objects](#), if you have defined any. You can use this tree to both view high-level information about these objects and to transfer to the respective page in which an object is maintained.

Defining Lookups

Lookup fields may be used to define valid values for a column in a table or for other types of values like parameters to an algorithm. This portal is used to view and maintain information about a lookup field and its values. Note that all lookup information is also maintained as part of the corresponding Field portal.

You can access the portal from the **Admin Menu > Database > Lookup**. You are brought to a query portal with options for searching for a specific lookup field. Once a field has been selected you are brought to the maintenance portal to view and maintain the selected record.

FASTPATH: Refer to [Defining Valid Values](#) for some background information.

NOTE: When introducing a new record, carefully consider its naming convention. Refer to [System Data Naming Convention](#) for more information.

The following zones may appear as part of the portal's **Main** tab page

- **Lookup.** This zone provides information about the selected lookup field.
- **Lookup Values.** This zone lists and maintains valid values for the selected lookup field.

The base product provides many different lookup fields and their values as part of the product. The following points highlight some functionality related to base-package lookups.

- Fields that are owned by the product will typically provide base lookup values. Implementations are not permitted to remove base delivered lookup values. Implementations may be able to add custom values to base owned lookups. This is controlled with the Custom switch on lookup.
 - When the custom switch is unchecked, it means that there is functionality controlled by the base values and an implementation may not extend or customize this functionality. An example of this type of lookup is the Data Type field on the [Field](#) table. The system supports a distinct list of data types and an implementation may not add additional values.
 - When the custom switch is checked, it means that there is base functionality supplied for the base values but that an implementation can extend the functionality by supplying their own values. An example of this type of lookup is the Access Mode on [Application Service](#). The product provides many values for the access mode lookup, representing

various actions a user may perform. Implementations may add their own values to this lookup. Documentation should indicate when functionality may be extended and should highlight the lookup value that can be extended.

CAUTION: Important! If you introduce new lookup values, you must prefix the lookup value code with **X** or **Y**. If you do not do this, there is a possibility that a future release of the application could introduce a new lookup value with the name you allocated.

- There may be some scenarios where the product supplies a base field and base lookup field with no base lookup values supplied. This occurs when the product doesn't have any base functionality driven by the lookup values. Typically this type of lookup is for information or categorization purposes. The configuration guide for the functional area associated with the lookup should include a configuration step regarding defining values for this type of lookup.
- The description of base delivered values may be overridden by an implementation.

An implementation may also identify the need for defining a new lookup field with its values.

Defining Extendable Lookups

Extendable lookups are a way of defining valid values that are more sophisticated than simple lookups.

FASTPATH: Refer to [Defining Valid Values](#) for some background information.

The base product provides extendable lookups as part of the product. The following points highlight some functionality related to base-package extendable lookups.

- The base product may supply base extendable lookup values. Implementations are not permitted to remove base delivered extendable lookup values. It is also possible that implementations may be able to add custom values to base owned lookups. If an implementation is not permitted to add lookup values to the base extendable lookup, the extendable lookup's business object will include validation to prevent this. There is no equivalent of the Custom switch that is on the [lookup](#) field.
- There may be some scenarios where the product supplies a base extendable lookup with no base lookup values supplied. This occurs when the product doesn't have any base functionality driven by the extendable lookup values. The configuration guide for the functional area associated with the extendable lookup should include a configuration step regarding defining values for this type of extendable lookup.
- The description of base delivered values may be overridden by an implementation.

Open this page using **Admin > General > Extendable Lookup**.

You are brought to the **Extendable Lookup Query** where you need to search for the extendable lookup object (i.e., its business object).

Once you have found the appropriate extendable lookup, select the value and you are brought to a standard [All-in-One](#) portal that lists the existing lookup values for the extendable lookup. The standard actions for an All-in-One portal are available here.

Extendable Lookup Advanced Topics

This section provides some additional technical information about extendable lookup attributes

Defining Additional Attributes

The product provides a few different ways to define additional values for an extendable lookup. Some of the methods are only relevant for base delivered lookup values as they may impact whether or not an implementation can update the values.

The following table highlights the options available and some summary information about what the option provides.

Option	Brief Description	Extendable Lookup Value Searchable by this Attribute?	Base Delivered Value Modifiable?
Element mapped to BO_DATA_AREA	The element is mapped to a CLOB field that allows for base delivered values to be modified.	No	Yes
Element mapped to BASE_BO_DATA_AREA	The element is mapped to a CLOB field that does not allow for base delivered values to be modified.	No	No
Flattened characteristic	The element is defined using the flattened characteristic mechanism.	Yes	No

The following points highlight information from the table above:

- The decision of defining an additional attribute using a CLOB mapping or a flattened characteristic will depend on whether the functionality expects that the lookup value is known when the attribute is needed (in which case a CLOB mapping is appropriate) or if the functionality expects to determine the lookup value based on the attribute (in which case, a flattened characteristic is appropriate).
- When the base product defines an extendable lookup with additional attributes and intends to provide base extendable lookup values, it needs to determine whether or not implementations may update the additional attribute or not.
 - If no and the value is mapped to a CLOB, it will map the value to the BASE_BO_DATA_AREA column. This means that implementations will receive an owner mismatch error when attempting to change the value. In addition, upgrading to a new release will replace the value with the base value.
 - If yes and the value is mapped to a CLOB, it will map the value to the BO_DATA_AREA column. This means that implementations will be able to change the value for a base owned record. In addition, upgrading to a new release will not make any changes to the value.
 - For values mapped to a characteristic, the product does not support an implementation changing the value of a base delivered record. If the product would like to support an implementation overriding this type of value, the business object will need to be designed with a corresponding "override" element (also a flattened characteristic), similar to how the product supplies an Override Description field to support an implementation overriding the base product delivered description for a base value. This element will not be delivered with any value and will allow an implementation to populate that value.

NOTE: Note that in this situation, the product functionality that uses this value must cater for the override value.

- All of this detail is only relevant for base provided extendable lookup values. If an implementation adds custom values for a base supplied extendable lookup, all the additional attributes may be populated as appropriate.
- If an implementation defines a custom extendable lookup business object and wants to define an additional attribute using a CLOB, it doesn't matter which CLOB column is used. Both BO_DATA_AREA and BASE_BO_DATA_AREA provide the same functionality for custom business objects.

Capturing a Password

If an extendable lookup includes configuration of a password for some functionality, the system supports automatic encryption of the password value if the schema maps the password to a characteristic using the characteristic type **F1-PWD**.

Defining Characteristic Types

This portal is used to view and maintain characteristic types. An implementation may define their own characteristic types or override some of the settings for base product provided characteristic types.

You can access the portal from the **Admin Menu > General > Characteristic Type**. You are brought to a query portal with options for searching for a specific record. Once a characteristic type record has been selected you are brought to the maintenance portal to view and maintain the selected record.

NOTE: When introducing a new record, carefully consider its naming convention. Refer to [System Data Naming Convention](#) for more information.

Refer to [Characteristic Types](#) for more information.

The following zones may appear as part of the portal's **Main** tab page

- **Characteristic Type.** This zone provides information about the selected characteristic type.
- **Characteristic Values.** This zone is visible for pre-defined characteristic types and shows the existing values (if applicable) with action buttons. It also allows you to add new values. Note that you may only add values to a product owned characteristic type if the Custom switch is checked.

Defining Foreign Key References

The topics in this section describe the transaction that allows you to define foreign key references.

Refer to [Foreign Key References](#) for more information.

To setup a foreign key reference, open **Admin > Database > FK Reference**.

Use the **Foreign Key Reference Query** portal to search for an existing foreign key reference. Once a foreign key reference is selected, you are brought to the maintenance portal to view and maintain the selected record.

CAUTION: Important! If you introduce a new foreign key reference, carefully consider its naming convention. Refer to [System Data Naming Convention](#) for more information.

Description of Page

Enter an easily recognizable **FK** (foreign key) **Reference** code and **Description** for the record.

Enter the name of the **Table** whose primary key is referenced. After selecting a **Table**, the columns in the table's primary key are displayed adjacent to **Table PK Sequence**.

Use **Navigation Option** to define the page to which the user will be transferred when they press the go to button or hyperlink associated with the referenced entity. Refer to [Navigation Information Is Dynamically Derived](#) for more information on how this is used.

The **Info Program Type** indicates whether the default program that returns the standard information description is **Java** or **Java (Converted)**, meaning it was converted into Java.

NOTE: **Java (Converted)** program types are not applicable to all products.

Use **Info Program Name** to enter the Java class / program name.

Refer to [Information Description Is Dynamically Derived](#) for more information on the info program is used.

View the source. If the program is shipped with the base package, you can use the adjacent button to display the source code of this program in the [Javadoc](#) viewer.

Use **Context Menu Name** to specify the context menu that appears to the left of the value.

NOTE: Context Menu Name is not applicable to user interface elements displaying a generic collection using a foreign key characteristic type. It is only applicable for pages utilizing the foreign key compound element type for fixed page user interface and for data displayed in a portal based user interface where the foreign key reference is defined as an attribute for an element. Report parameters that reference foreign key characteristics are an example of a user interface where a context menu is not displayed even if the foreign key reference defines one.

Use **Search Zone** to define the search zone that opens when a user searches for valid values when the foreign key reference is configured as an input field on a portal based page. Refer to [Search Options](#) for more information.

Use **Search Navigation Key** to define the search page that will be opened when a user searches for valid values on a user interface that is a fixed page. Refer to [Search Options](#) for more information.

Use **Search Type** to define the default set of search criteria used by the **Search Navigation Key's** search page.

Use **Search Tooltip** to define a label that describes the **Search Navigation Key's** search page.

NOTE: Search Type and Search Tooltip. These attributes are only applicable to user interface elements utilizing the foreign key compound element type on fixed page user interfaces. Report parameters that reference foreign key characteristics are an example of a user interface where this information is not used even if the foreign key reference defines them.

Audit Trails

The topics in this section describe one way of auditing changes in the system. Note that this technique has limitations and may not be the best option for all situations.

- This functionality is configured at the table and field level. Many base maintenance objects use an XML or CLOB field to capture one or more elements using XML format, configured using a BO schema. This auditing technique is not able to capture changes to individual elements. It can only capture overall changes to the single field. The BO Audit plug-in is a better option for auditing changes to individual elements with the CLOB / XML field.
- The base table provided for supporting audits limits the field size of the before and after values to 254 bytes.
- Auditing is captured for each field. In some cases it is preferred to capture a before and after image for several fields at once. For example, if an address is changed, it's more user friendly to capture the before and after for the full address rather than the individual address components. The BO Audit plug-in allows for capturing a single audit record for multiple elements rather than granular changes for each element.

The subsequent topics highlight how to enable auditing for fields, and describe the auditing queries that you can use to view audit records.

Captured Information

When auditing is enabled for a field, the following information is recorded when the field is changed, added and/or deleted (depending on the actions that you are auditing for that field):

- User ID
- Date and time
- Table name
- Row's prime key value
- Field name
- Before image (blank when a row is added)

- After image (blank when a row is deleted)
- Row action (add, change, delete)

How Auditing Works

You enable auditing on a table in the table's meta-data by specifying the name of the table in which to insert the audit information (the audit table) and the name of the program responsible for inserting the data (the audit trail insert program). Then you define the fields you want to audit by turning on each field's audit switch in the table's field meta-data. You can audit fields for delete, insert and update actions.

Once auditing is enabled for fields in a table, the respective row maintenance program for the table assembles the list of changed fields and calls the audit trail insert program. If any of the changed fields are marked for audit, the audit program inserts audit rows into the audit table.

NOTE: Customizing Audit Information. You may want to maintain audit information other than what is described in [Captured Information](#) or you may want to maintain it in a different format. For example, you may want to maintain audit information for an entire row instead of a field. If so, your implementation team can use the base audit program and base audit tables as examples when creating your own audit trail insert program and audit table structures.

The Audit Trail File

Audit log records are inserted in the audit tables you define. The base product contains a single such table (called **CI_AUDIT**). However, the base audit insert program is designed to allow you to use multiple audit tables.

If you want to segregate audit information into multiple tables, you must create these tables. Use the following guidelines when creating new audit tables (that use the base delivered audit insert program):

- The new audit tables must look identical to the base table (**CI_AUDIT**).
- The new tables must be prefixed with **CM** (e.g., **CM_AUDIT_A**, **CM_AUDIT_B**, etc.). An appropriate java table name must be defined and an *_impl.java program for that java table name must be defined.
- The name of the new table must be referenced on the various tables whose changes should be logged in the new table.

NOTE: It's important to note if you use your own tables (as opposed to using the base package table called **CI_AUDIT**), the SQL used to insert and access audit trail records in the base delivered audit program is dynamic. Otherwise, if the base package's table is used, the SQL is static.

How To Enable Auditing

Enabling audits is a two-step process:

- First, you must turn on auditing for a table by specifying an audit table and an audit trail insert program.
- Second, you must specify the fields and actions to be audited for the table.

The following topics describe this process.

Turn On Auditing For a Table

In order to tell the system which fields to audit, you must know the name of the table on which the field is located. You must specify the audit table and the audit trail insert program for a table in the table's meta-data.

NOTE: Most of the system's table names are fairly intuitive. For example, the user table is called SC_USER, the navigation option table is called CI_NAV_OPT, etc. If you cannot find the table using the search facility on the [Table](#) portal, please contact customer support.

To enable auditing for a table:

- Navigate to the [Table](#) portal and find the table associated with the field(s) for which you want to capture audit information.
- Specify the name of the **Audit Table**.

NOTE: Specifying the Audit Table. You can use the audit table that comes supplied with the base package (**CI_AUDIT**) to audit multiple tables and fields. All the audit logs are combined in a single table (**CI_AUDIT**). However, you can also have a separate audit table for each audited table. Refer to [The Audit Trail File](#) for more information.

- Specify the name of the **Audit Program** . The product provides two programs. **com.splwg.base.domain.common.audit.DefaultTableAuditor** is a standard table audit program. In addition **com.splwg.base.domain.common.audit.ModifiedTableAuditor** is supplied as an alternative. This program does not audit inserts or deletes of empty string data.

CAUTION: By default, none of a table's fields are marked for audit. Even though you have enabled auditing for a table, you must still specify the fields and actions on those fields to be audited (see below).

Specify The Fields and Actions To Be Audited

The system only audits actions (insert, update and delete) made to fields that you want audited.

To specify the fields and actions to be audited:

- Navigate to the [Table](#) portal for a table on which you have enabled auditing.
- For each field you want to audit, specify the actions you want to audit by turning on the **Audit Delete**, **Audit Insert** and **Audit Update** switches as appropriate.

NOTE: You can also turn on the audit switches using the Field zone at the bottom of the [Table](#) portal.

CAUTION: Audit Program Caching! The audit program from the table meta-data is read into a program cache on the application server whenever the date changes or when the server starts. If you implement new auditing on a table, your audit trail does not become effective until this program cache is reloaded. In other words, new audits on tables where the audit program was not previously specified do not become effective until the next day (or the next restart of the application server). However, if you change the fields to be audited for a table where the audit program is already in the cache, your changes are effective immediately.

Audit Queries

There are two queries that can be used to access the audit information.

Audit Query by User

This transaction is used to view changes made by a user that are stored on a given [Audit Trail File](#).

CAUTION: The system only audits changes that you've told it to audit. Refer to [The Big Picture Of Audit Trails](#) for more information.

Navigate to this page by selecting **Admin > Database > Audit Query By User**.

Description of Page

To use this transaction:

- Enter the **User ID** of the user whose changes you wish to view.
- Enter the name of the table on which the audit trail information is stored in **Audit Table**. Refer to [The Audit Trail File](#) for more information about this field.

NOTE: Default Note. If only one audit table is used to store audit trail information, that table is defaulted.

- Specify a date and time range in **Created between** to restrict the records that result from the query.

NOTE: Default Note. The current date is defaulted.

- Click the search button to display all changes recorded on a specific audit table associated with a given user.

Information on this query is initially displayed in reverse chronological order.

The following information is displayed in the grid:

- **Row Creation Date** is the date and time that the change was made.
- **Audited Table Name** contains the name of the table whose contents were changed.
- **Primary Key** is the prime key of the row in the **Audited Table** whose contents were changed.
- **Audited Field Name** is the name of the field that was changed.
- **Audit Action** indicates whether the row action was **Add**, **Change** or **Delete**.
- **Field Value Before Update** contains the content of the field before the change. This column is blank if information was **Added**.
- **Field Value After Update** contains the content of the field after the change. This column is blank if information was **Deleted**.

Audit Query by Table / Field / Key

This transaction is used to view audited changes made to a given table.

CAUTION: The system only audits changes that you've told it to audit. Refer to [The Big Picture Of Audit Trails](#) for more information.

This transaction can be used in several different ways:

- You can view all audited changes to a table. To do this, enter the **Audited Table Name** and leave the other input fields blank.
- You can view all audited changes to a given row in a table (e.g., all changes made to a given user). To do this, enter the **Audited Table Name** and row's prime key (the row's prime key is entered in the field(s) beneath **Audited Field Name**).
- You can view all audited changes to a given field in a table (e.g., all changes made to all customers' rates). To do this, enter the **Audited Table Name** and the **Audited Field Name**.
- You can view all audited changes to a given field on a specific row. To do this, enter the **Audited Table Name**, the **Audited Field Name**, and row's prime key (the row's prime key is entered in the field(s) beneath **Audited Field Name**).

Navigate to this page by selecting **Admin > Database > Audit Query By Table/Field/Key**.

Description of Page

To use this transaction:

- Enter the name of the table whose changes you wish to view in **Audited Table Name**.
- If you wish to restrict the audit trail to changes made to a specific field, enter the **Audited Field Name**.
- If you wish to restrict the audit trail to changes made to a given row, enter the row's prime key (the row's prime key is entered in the field(s) beneath **Audited Field Name**). These fields are dynamic based on the **Audited Table Name**.
- Specify a date and time range in **Created between** to restrict the records that result from the query.

NOTE: The current date is defaulted.

- Click the search button to display all changes made to this data.

Information on this query is initially displayed in reverse chronological order by field.

The following information is displayed in the grid:

- **Create Date/Time** is the date / time that the change was made.
- **User Name** is the name of the person who changed the information.
- **Primary Key** is the prime key of the row in the **Audited Table** whose contents were changed.
- **Audited Field Name** is the name of the field that was changed.
- **Audit Action** indicates whether the row action was **Add**, **Change** or **Delete**.
- **Value Before Update** contains the content of the field before the change. This column is blank if information was **Added**.
- **Value After Update** contains the content of the field after the change. This column is blank if information was **Deleted**.

Bundling

The topics in this section describe the bundling features in the application.

About Bundling

Bundling is the process of grouping entities for export or import from one environment to another.

For example, you might export a set of business objects and service scripts from a development environment and import them into a QA environment for testing. The group of entities is referred to as a bundle. You create export bundles in the source environment; you create import bundles in the target environment.

Working with bundles involves the following tasks:

- Configuring entities for bundling if they are not preconfigured
- Creating an export bundle, which contains a list of entities to be exported from the source environment
- Creating an import bundle to import those entities to the target environment
- Applying the import bundle, which adds or updates the bundled entities to the target environment

Sequencing of Objects in a Bundle

Bundle entities are added or updated to the target environment in the sequence defined in the bundle

Typically, the sequence of entities does not matter. However, sequence is important in the following situations:

- Entities that are referenced as foreign keys should be at the top of the sequence, before the entities that reference them. Specify zones last, as they typically contain numerous foreign key references.
- When importing a business object, specify the business object first, then its plug-in scripts, then the algorithms that reference the scripts, and then the algorithm types that reference the algorithms.
- When importing a portal and its zones, specify the portal first and then its zones.
- When importing a multi-query zone, specify the referenced zones first and then the multi-query zone.
- Always specify algorithms types before algorithms.

You can specify the sequence when you define the export bundle or when you import the bundle to the target environment.

Recursive Key References

Recursive foreign keys result when one object has a foreign key reference to another object that in turn has a foreign key reference to the first object.

For example, a zone has foreign keys to its portals, which have foreign keys to their zones. If the objects you want to bundle have recursive relationships, you must create a 'bundling add' business object that has only the minimal number of elements needed to add the entity. A bundling add business object for a zone contains only the zone code and description, with no references to its portals. In the same way, a bundling add business object for a portal defines only its code and description.

When you apply the bundle, the system initially adds the maintenance object based on the elements defined in the bundling add business object. Before committing the bundle, the system updates the maintenance object with the complete set of elements based on its physical business object.

Note that use of the bundling add BO also benefits records that have optional foreign keys or foreign keys that are part of a child table. That way the person creating the bundle does not have to worry about the sequence of the records. For example, an FK Reference may optionally reference a zone for searching. If a new FK Reference and its search zone are bundled together to copy to another region, the bundling add BO for FK Reference (which doesn't include the Zone) ensures that the FK reference could be added before the zone without getting any validation errors.

Owner Flags on Bundled Entities

The owner flag of the entities in an import bundle must match the owner flag of the target environment.

If you need to import objects that your source environment does not own, you must replace the owner flag in the import bundle with the owner flag of the target environment.

Configuring Maintenance Objects for Bundling

Most base package meta-data objects are pre-configured to support bundling. All other objects must be manually configured.

If a base package maintenance object is pre-configured for bundling, the **Eligible For Bundling** option will be set to "Y" on the Options tab for the maintenance object.

To configure other objects for bundling, review the configuration tasks below and complete all those that apply:

Configuration Task	Scope of Task
Make maintenance objects eligible for bundling	All objects to be included in the bundle.
Add a foreign key reference	All objects to be included in the bundle.
Create a physical business object	All objects to be included in the bundle.

Configuration Task	Scope of Task
Create a bundling add business object	Only needed if there are objects with recursive or optional foreign key references .
Add the Current Bundle zone	Perform this step for any object where you want the Current Bundle zone to appear on the maintenance object's dashboard. This is not required by the bundling process.
Create a custom Entity Search zone and add it to the Bundle Export portal	Perform this step if you would like the object to be listed in the Entity Search zone in the Bundle Export portal. This is not required by the bundling process.

Making Maintenance Objects Eligible for Bundling

The "Eligible For Bundling" maintenance object option must be set to "Y" for all bundled objects. Go to the [Maintenance Object](#) page and search for the maintenance object. On the Options tab, add a new option with the type **Eligible For Bundling**. Set the value to "Y" and click **Save**. This configuration must be in both the source environment and the target environment.

Adding a Foreign Key Reference

Foreign key references are used for many purposes and most maintenance objects should have them anyway. Check the Maintenance Object options to see if there is an entry for the **Foreign Key Reference** option. If one is not configured, navigate to [FK Reference](#) and set up a foreign key reference for the primary table of the maintenance object. Configure that new FK reference on the maintenance object using an option.

Creating a Physical Business Object

If the maintenance object does not already have a Physical BO configured, one must be created to support using it in a bundle. Refer to [Creating a Physical Business Object](#) for more information.

Creating a Bundling Add Business Object

If the objects to be bundled have recursive foreign key references, optional foreign key references or child tables that include foreign key references, create a bundling add business object to avoid problems with referential integrity.

1. Navigate to [Business Object](#) and specify the maintenance object.
2. Click **Generate** in the **BO Schema** dashboard zone to generate a schema that looks like the physical structure of the maintenance object.
3. Remove all child tables and all elements that are not required.
4. Save the business object.
5. Navigate to [Maintenance Object](#) and search for the maintenance object you want to bundle.
6. On the **Option** tab, add a new option with the type **Bundling Add BO**. The value is the name of the bundling add business object you just created.

Adding the Current Bundle Zone

If you want the Current Bundle zone to appear on the maintenance object's dashboard, you must add the Current Bundle zone as a context-sensitive zone for the maintenance object.

1. Navigate to [Context Sensitive Zone](#) and search for the navigation key for the maintenance object.
2. Add the Current Bundle zone F1-BNDLCTXT, to that navigation key.

Adding a Customized Entity Search Query Zone to the Bundle Export Portal

If you want the maintenance object to be searchable in the Bundle Export portal in the Entity Search zone, you must first create an entity-specific query zone to search for the maintenance object. Then you must create a customized entity search

zone that references this new query zone. Finally, you must add the customized entity search zone to the Bundle Export portal.

Note that not all base product entities that are eligible for bundling have a search configured for this zone. There is a limit to the number of searches that may be listed here. The base product has provided searches for only the most common objects that are bundled.

Create an entity-specific query zone to search for the maintenance object:

1. Navigate to [Zone](#) and search for one of the base query zones, such as the Algorithm Search zone F1-BNALGS.
2. Click the **Duplicate** button in the record actions section.
3. Enter a name and description for the new zone.
4. Click **Save**.
5. Customize the details of the parameters for your maintenance object.

Create a customized entity search zone. This step only needs to be done once. If you already have a customized search zone in the Bundle Export portal, skip this step.

1. Navigate to [Zone](#) and search for the F1-BNDLENTQ Entity Search zone.
2. Duplicate this zone.
3. Remove any references to base query zones.

Add the new entity-specific query zone to the customized entity search zone:

1. Locate the customized entity search zone for your Bundle Export portal. This is the zone created in the previous step.
2. Add the name of the query zone you created in the first step to the list of Query Zones.

Add the customized entity search zone to the Bundle Export portal. This step needs to be done only once.

1. Navigate to [Portal](#) and search for the Bundle Export portal, F1BNDLEM.
2. In the zone list, add the entity search zone you created above. (Add the new zone after the base entity search zone).
3. Save the portal.

Working with Bundles

Use the Bundle Export portal to create an export bundle. The export bundle contains a list of entities to be exported from the source environment. When you are ready to import the objects, use the Bundle Import portal to import the objects to the target environment.

Creating Export Bundles

An export bundle contains a list of entities that can be imported into another environment.

To create an export bundle:

1. Log on to the source environment from which objects will be exported.
2. Select **Admin > Implementation Tools > Bundle Export > Add**.
3. Complete the fields in the Main section to define the bundle's basic properties.

NOTE: You can use the Entities section to add bundle entities now, or save the bundle and then add entities as described in step 5.

4. Click **Save** to exit the Edit dialog. The export bundle status is set to Pending.
5. While an export bundle is in Pending state, use any of the following methods to add entities to the bundle:
 - a) Use the **Entity Search** zone on the Bundle Export portal to search for entities and add them to the bundle. If an entity is already in the bundle, you can remove it.
 - b) To import entities from a .CSV file, click **Edit** on the Bundle Export portal, and then click **CSV File to Upload**. Specify the file name and location of the .CSV file containing the list of entities. Click **Submit** to upload the file, and then click **Save** to save the changes.
 - c) Use the **Current Bundle** zone in the dashboard of the entity you want to add. (All entities that are configured to support bundling display a Current Bundle zone). This zone displays a list of all pending export bundles to which you can add the entity.
 - d) When you check an entity into revision control, specify the export bundle on the **Revision Info** dialog.
6. When you have added all entities, click **Bundle** in the Bundle Actions zone on the Bundle Export portal. The export bundle state is set to Bundled and the Bundle Details zone displays the XML representation of every entity in the bundle.

NOTE: The owner flags of the entities in the bundle must match the owner flag of the bundle itself. If the owner flags do not match, the system displays a warning message. Click **OK** to continue or **Cancel** to abort the bundle. If you click OK, you will need to resolve the owner flag discrepancy before you import the bundle to the target environment.

7. Copy the XML from the **Bundle Detail** zone to the clipboard (or to a text file). You can now create an import bundle and apply it to the target environment.

NOTE: If you need to make additional changes to the bundle, you must change the bundle state by selecting the **Back to Pending** button in the **Bundle Actions** zone.

Creating and Applying Import Bundles

Import bundles define a group of entities to be added or updated in the target environment.

Before you create an import bundle, you must have already created an export bundle, added entities, and set the bundle's state to Bundled.

To create an import bundle and apply it to the target environment:

1. If you have not already copied the XML from the export bundle, do so now:
 - a) Select **Admin > Implementation Tools > Bundle Export** and search for the bundle.
 - b) Copy the XML from the **Bundle Detail** zone to the clipboard (or to a text file).
2. Log on to the target environment.
3. Select **Admin > Implementation Tools > Bundle Import > Add**.
4. In the **Bundle Actions** zone, click **Edit XML**.
5. Paste the contents of the clipboard (or text file if you created one) into the **Bundle Detail** zone.
6. Make any necessary changes to the XML and click **Save**. The status of the import bundle is set to Pending.

NOTE: Use caution when editing the XML to avoid validation errors.

7. To remove entities from the import bundle or change their sequence, click **Edit**. Enter your changes and click **Save** to exit the Edit dialog.
8. When you are ready to apply the bundle, click **Apply**. The import bundle state is set to Applied and the entities are added or updated in the target environment.

Editing Export Bundles

You can add or remove entities from an export bundle when it is in Pending state. You can also change the sequence of entities.

To edit to an export bundle that has already been bundled, you must change the bundle state by selecting the **Back to Pending** button on the Bundle Export portal.

To edit a pending export bundle:

1. Open the bundle in edit mode.
2. Click **Edit** on the Export Bundle portal.
3. Make any necessary changes on the edit dialog and then click **Save**.

Editing Import Bundles

You can remove entities from an import when it is in Pending state. You can also change the sequence of entities and edit the generated XML.

To edit a pending import bundle:

1. Open the bundle in edit mode.
2. To edit the XML snapshot, click **Edit XML**. Edit the XML code as needed, then click **Save**.

NOTE: Use caution when editing the XML to avoid validation errors.

3. To remove entities or change their sequence, click **Edit**. Make any necessary changes and click **Save**.

Revision Control

The topics in this section describe the revision control features in the application.

About Revision Control

Revision control is a tool provided for the development phase of a project to allow a user to check out an object that is being worked on. In addition, it captures the version of the maintenance object when users check in an update, maintaining a history of the changes to the object.

If revision control is enabled for an object you must check out the object to change it. While the object is checked out no one else can work on it. You can revert all changes made since checking out an object, reinstate an older version of an object, recover a deleted object, and force a check in of an object if someone else has it checked out.

NOTE: Revision control does not keep your work separate from the environment. Because the metadata for maintenance objects is in the central database, any changes you make to an object while it is checked out will be visible to others and may impact their work.

Many of the maintenance objects used as configuration tools are already configured for revision control, but it is turned off by default. For example, business objects, algorithms, data areas, UI maps, and scripts are pre-configured for revision control.

Turning On Revision Control

Revision control is turned off by default for maintenance objects that are configured for revision control.

To turn on revision control:

1. Add the base package **Checked Out** zone to the Dashboard portal.
 - a) Navigate to [Portal](#).
 - b) Search for the portal CI_DASHBOARD.
 - c) In the zone list for the **Dashboard** portal, add the zone F1-USRCHKOUT.
2. Set up application security.

For users to have access to revision control, they must belong to a user group that has access to the application service F1-OBJREVBOAS.
3. Add the revision control algorithm to the maintenance object that you want to have revision control.

This step must be repeated for each maintenance object that you want to have revision control.

 - a) Go to the [Maintenance Object](#) page and search for the maintenance object that you want to have revision control.
 - b) On the **Algorithms** tab of the maintenance object, add the revision control algorithm F1-REVCTL.

Configuring Maintenance Objects for Revision Control

Most configuration tool maintenance objects are pre-configured for revision control. You can configure other maintenance objects for revision control, as well.

To configure other objects for revision control:

1. Create a physical business object for the maintenance object. Refer to [Creating a Physical Business Object](#) for more information.
2. Add a foreign key reference to the maintenance object so that the standard information string is displayed. Foreign key references are used for many purposes and most maintenance objects should have them anyway. Check the Maintenance Object options to see if there is an entry for the **Foreign Key Reference** option. If one is not configured, navigate to [FK Reference](#) and set up a foreign key reference for the primary table of the maintenance object. Configure that new FK reference on the maintenance object using an option.
3. Add the **Revision Control** zone to the maintenance object.
 - a) Navigate to [Context Sensitive Zone](#) and search for the navigation key for the maintenance object.
 - b) Add the Revision Control zone, F1-OBJREVCTL, to that navigation key.
4. Add the revision control algorithm to the maintenance object.
 - a) Go to the [Maintenance Object](#) page and search for the maintenance object that you want to have revision control.
 - b) On the **Algorithms** tab of the maintenance object, add the revision control algorithm F1-REVCTL.

Working with the Revision Control Zones

You use two zones in the dashboard to work with revision controlled objects when revision control is turned on.

The **Revision Control** zone gives you several options for managing the revision of the currently displayed object. This zone also shows when the object was last revised and by whom. This information is linked to the **Revision Control Search** portal which lists all of the versions of the object.

Using the Revision Control zone you can:

- Check out an object in order to change it.
- Check in an object so others will be able to work on it.
- Revert the object back to where it was at the last checkout.
- Force a check in of an object that is checked out by someone else. You need special access rights to force a check in.
- Delete an object.

The **Checked Out** zone lists all of the objects that you currently have checked out. Clicking on an object listed in this zone will take you to the page for that object. The zone is collapsed if you have no objects checked out.

See [Revision Control Search](#) for more information about Check In, Force Check In, and Check Out one or more records simultaneously.

Checking Out an Object

You must check out a revision controlled object in order to change it.

An object must have revision control turned on before you can check it out.

NOTE: When you first create or update an object a dialog box informs you that the object is under revision control. You can select **OK** to check out the object and save your changes, or **Cancel** to stop the update.

1. Go to the object that you want to work on.
2. Select **Check Out** in the **Revision Control** dashboard zone.

Checking In an Object

You must check in a revision controlled object in order to create a new version of it. Checking in an object also allows others to check it out.

1. Select a link in the **Checked Out** dashboard zone to go to the object that you want to check in.
2. Select **Check In** in the **Revision Control** dashboard zone.
3. Provide details about the version:
 - In the **External References** field state the bug number, enhancement number, or a reason for the revision.
 - In the **Detailed Description** field provide additional details regarding the revision.
 - In the **Keep Checked Out** box specify if you want to keep the object checked out. If you keep the object checked out then your revision is a new version that you can restore later.
 - In the **Add To Bundle** box specify if the object belongs to a bundle.
4. Select **OK** to check in the object.

Reverting Changes

Reverting changes will undo any changes you made since you checked out an object.

To revert changes:

1. Go to the object that you want to revert.
2. Select **Revert** in the **Revision Control** dashboard zone.
3. In the confirmation dialog box select **OK** to confirm the action or **Cancel** to return to the object page.

Once reverted, the object can be checked out by another user.

Forcing a Check In or Restore

You can force a check in if an object is checked out by another user and that person is not available to check it in.

You must have proper access rights to force a check in or restore.

To force a check in or restore:

1. Go to the object that is checked out by another user.
2. Select **Force Check In** or **Force Restore** in the Revision Control zone.

The **Force Check In** option is the same as a regular check in. The **Force Restore** option checks in the object and restores it to the previously checked in version.

Deleting an Object

If revision control is turned on for an object, you must use the **Revision Control** zone to delete it.

The object must be checked in before it can be deleted.

To delete a revision controlled object:

1. Go to the object that you want to delete.
2. Select **Delete** in the **Revision Control** zone.
3. Provide details regarding the deletion.
4. Select **OK** to delete the object.

The system creates a revision record before the object is deleted so that the deleted object can be restored.

Restoring an Object

You can restore an older version of either a current object or a deleted object.

An object must be checked in before an older version can be restored.

To restore an object:

1. Go to the **Revision History** portal for the object.
If the object was deleted you must search for it by going to **Admin > Implementation Tools > Revision Control**.
2. Select the desired entity by clicking the hyperlink in the **Details** column.
3. Locate the row in the version history that has the version that you want to restore and click **Restore**.
4. In the confirmation dialog box select **OK** to confirm the action or **Cancel** to return to the object page.

Working with the Revision Control Portal

The **Revision Control** portal lists information about each version of a revision controlled object.

You can navigate to the **Revision Control** portal from either a link in the **Revision Control** dashboard zone or by going to **Revision Control** portal through **Admin**.

If you want to find the Revision History entry for an earlier version or deleted object, you must search for the object using the **Revision Control Search** portal. Once you select the desired entry, you can restore a previous version of the object clicking **Restore** in the row for the version that you want to restore. You can also see the details of each version by clicking the broadcast icon for that version.

See [Working with Revision Control Zones](#) for more information about tasks that can be performed through Revision Control.

Revision Control Search

The **Revision Control Search** portal allows users to search for entities that have a revision history. The **Search By** dropdown provides additional functionality so that users can search for revisions that are associated to theirs or other's user ID. Users can also **Check In**, **Force Check In**, or **Check Out** one or more entities through this portal.

Zone Options

- **Revision History Search** allows the user to query for revised entities based on a combination of criteria.
 - In the **User ID** field, enter the user ID that is associated with a revision.
 - In the **External Reference** field, enter an ID from an external system and is associated with a revision.
 - In the **Maintenance Object** dropdown menu, select the Maintenance Object that is associated with a revision. The options in this list are populated by the Maintenance Objects that are active to track revision.
 - In the **Key 1**, **Key 2**, **Key 3**, **Key 4**, **Key 5** fields, enter the primary identifier(s) for the revised entity. Typically, the entity only requires a single key, but some entities require more than one (for example, Oracle Utilities Customer Care and Billing SA Type require CIS Division and SA Type).
 - In the **Status** dropdown menu, select the entity status for your search.
- **Check In** allows the user to search for entities currently checked out to the logged in user ID and a combination of criteria. Once the search results are returned, the user has the option to select one or more entities and check them in.
 - In the **Maintenance Object** dropdown menu, select the Maintenance Object that is associated with a revision. The options in this list are populated by the Maintenance Objects that are active to track revision.
 - In the **Key** field, enter the primary identifier(s) for the revised entity.
- **Force Check In** allows the user to search for entities that are currently checked out by other user IDs (excluding the logged in user ID) based on a combination of criteria. Once the search results are returned, the user has the option to select one or more entities and check them in.
 - In the **Checked Out By User** field, enter the user ID that has the entity in a Checked Out status.
 - In the **Maintenance Object** dropdown menu, select the Maintenance Object that is associated with a revision. The options in this list are populated by the Maintenance Objects that are active to track revision.
 - In the **Key** field, enter the primary identifier(s) for the revised entity.
- **Check Out** allows the user to search for entities currently checked in user ID and a combination of criteria. Once the search results are returned, the user has the option to select one or more entities and check them out.
 - In the **Maintenance Object** dropdown menu, select the Maintenance Object that is associated with a revision. The options in this list are populated by the Maintenance Objects that are active to track revision.
 - In the **Key** field, enter the primary identifier(s) for the revised entity.

Please see [Working with Revision Control Zones](#) for more information about working with individual entities.

Information Lifecycle Management

Information Lifecycle Management (ILM) is designed to address data management issues, with a combination of processes and policies so that the appropriate solution can be applied to each phase of the data's lifecycle.

Data lifecycle typically refers to the fact that the most recent data is active in the system. As time progresses, the same data becomes old and unused. Older data becomes overhead to the application not only in terms of storage, but also in terms of performance. This older data's impact can be reduced by using advanced compression techniques, and can be put into slower and cheaper storage media. Depending on how often it's accessed, it can be removed from the system to make an overall savings of cost and performance. The target tables for ILM are transactional tables that have the potential to grow and become voluminous over time.

The Approach to Implementing Information Lifecycle Management

This section describes the product approach to implementing ILM for its maintenance objects (MOs).

NOTE: The term archiving is used to cover any of the possible steps an implementation may take in their data management strategy, including compression, moving to cheaper storage, and removing the data altogether.

Age is the starting point of the ILM product implementation for some of its high volume data. In general "old" records are considered eligible to be archived. In the product solution, maintenance objects (MOs) that are enabled for ILM have an ILM Date on the primary table and the date is typically set to the record's creation date. (An MO may have special business rules for setting this date, in which case, a different date may be used to set the initial ILM Date). For implementations that want to use ILM to manage the records in the MO, the ILM date is used for defining partitions for the primary table.

There are cases where a record's age is not the only factor in determining whether or not it is eligible to be archived. There may be some MOs where an old record is still 'in progress' or 'active' and should not be archived. There may be other MOs where certain records should never be archived. To evaluate archive eligibility using information other than the ILM Date, the ILM enabled MOs include an ILM Archive switch that is used to explicitly mark records that have been evaluated and should be archived. This allows DBAs to monitor partitions based on age and the value of this switch to evaluate data that may be ready to be archived.

Evaluating records to determine their archive eligibility should still occur on "old" records. The expectation is that a large percentage of the old records will be eligible for archiving. The small number that may be ineligible could be updated with a more recent ILM date. This may cause the records to move into a different partition and can delay any further evaluation of those records until more time has passed.

For each MO enabled for ILM, the product provides a batch process to review "old" records and an ILM eligibility algorithm that contains business logic to evaluate the record and mark it eligible for archiving or not. The following sections provide more information about the batch process and algorithm functionality.

Batch Processes

There are two main types of batch processes that manage data for ILM in the application: ILM Crawler Initiator and individual ILM Crawlers (one for each MO that is configured for ILM).

- **ILM Crawler Initiator: (F1-ILMIN)** - The ILM Crawler Initiator is a *driver* batch process that starts the individual ILM Crawler batch control as defined by the MO's options.

Restartable: In case of server failure, the ILM Crawler Initiator process can be restarted, which will also restart the ILM Crawler processes.

- **ILM Crawler:** Each maintenance object that is configured for ILM defines an ILM Crawler. These are *child* batch processes that can be started either by the ILM Crawler Initiator or by a standalone batch submission.

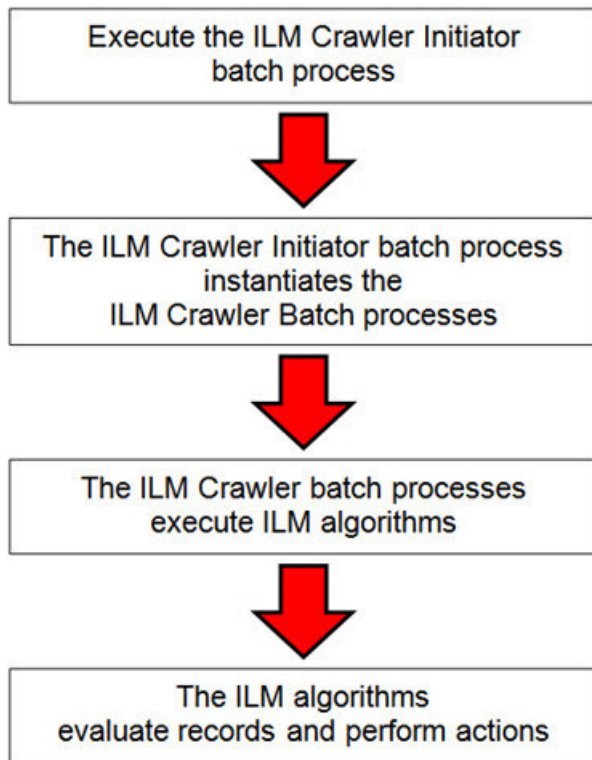

The ILM Crawler batch process selects records whose retention period has elapsed and invokes the MO's ILM eligibility algorithm to determine if the record is ready to be archived or not. The ILM eligibility algorithm is responsible for setting the record's ILM archive switch to 'Y' and updating the ILM date, if necessary.

The retention period defines the period that records are considered active. It spans the system date and cutoff date (calculated as system date - retention days).

The retention days of an MO is derived as follows:

- If the ILM Retention Days MO option is defined, that is used.
- Otherwise, the Default Retention Days from the ILM Master Configuration record is used.

An error is issued if no retention period is found.

The crawler calculates the cutoff date and selects all records whose ILM archive switch is 'N' and whose ILM date is prior to the cutoff date. Each record returned is subject to ILM eligibility.

If the Override Cutoff Date parameter is supplied, it will be used instead of the calculated cutoff date. An error is issued if the override cutoff date is later than the calculated cutoff date. This parameter is useful if an object has many years of historic data eligible for archiving. Setting this parameter allows for widening the retention period and therefore limiting the process to a shorter period for initial processing

NOTE: ILM Crawler batch processes are designed not to interfere with current online or batch processing. Because of this, these batch processes can run throughout the day.

NOTE: Before passing the cut-off date to the algorithm, the ILM crawler ensures that the number of days calculated (System Date – override cut-off date) is more than the retention period specified in the MO option or the Master Configuration. If the number of days calculated is **less than** the retention period specified on the MO option or the Master Configuration, then it throws an error.

Eligibility Algorithm

Algorithms are triggered by the ILM batch crawler for the maintenance object. The key responsibility of the ILM algorithm is to determine whether a record can be marked as ready to be archived or not. If a record is determined to be ready for archive, the algorithm should set the ILM Archive switch to Y. If not, the algorithm leaves the switch set to N and may decide to update the ILM Date to something more recent (like the System Date) to ensure that the record does not get evaluated again until the future.

This algorithm is plugged into the [Maintenance Object — Algorithm](#) collection.

Oracle Utilities Application Framework provides the algorithm **ILM Eligibility Based on Status (F1-ILMELIG)** to support the ILM batch crawler. Refer to the algorithm type description for details about how this algorithm works. If a maintenance object has special business rules that are evaluated to determine the eligibility for ILM, a custom algorithm can be created and applied by the implementation team.

Enabling ILM for Supported Maintenance Objects

In order to enable ILM for one or more maintenance objects, several steps are needed in both the configuration and in the database. This section describes some configuration enabled by default and some steps that must be taken in order to fully implement ILM.

There is some configuration enabled by default, but it won't be used unless ILM is fully configured. Each maintenance object that the product has configured for ILM has the following provided out of the box:

- **Special Table Columns:** Maintenance objects that support ILM include two specific columns: ILM Archive Switch (**ILM_ARCH_SW**) and ILM Date (**ILM_DT**).
- **Crawler Batch Process:** A "crawler" batch process is provided for each maintenance object that supports ILM and it is plugged into the MO as an option. Refer to [Batch Processes](#) for more information.
- **ILM Eligibility Algorithm:** Each maintenance object that is configured for ILM defines an [eligibility algorithm](#) that executes the logic to set the ILM Archive switch appropriately. This is plugged in to the MO algorithm collection.

If an implementation decides to implement ILM, there are steps that need to be followed, which are highlighted below.

Create the Master Configuration Record

The first step when enabling ILM is to create the **ILM Configuration**[master configuration](#) record.

The master configuration for ILM Configuration defines global parameters for all ILM eligible maintenance objects. For example, the Default Retention Period. In addition, your product may implement additional configuration. Refer to the embedded help for specific details about the information supported for your product's ILM configuration.

In addition, the user interface for this master configuration record displays summary information about all the maintenance objects that are configured to use ILM.

Confirm the Maintenance Objects to Enable

In viewing the list of maintenance objects that support ILM in the ILM master configuration page, your implementation may choose to enable ILM for only a subset of the supported maintenance objects. For example, some of the maintenance objects may not be relevant for your implementation. Or perhaps, the functionality provided by the maintenance object is used, but your implementation does not expect a high volume of data.

For each maintenance object that your implementation has confirmed for ILM, the following steps should be taken:

- Determine if the maintenance object should have a different default retention days than the system wide value defined on the master configuration. If so, use the MO option **ILM Retention Period in Days** to enter an override option for this maintenance object.

- Review the functionality of the ILM Eligibility algorithm provided by the product for this maintenance object. Each algorithm may support additional configuration based on business needs. If your organization has special business rules that aren't satisfied by the algorithm provided by the product, a custom algorithm may be provided to override the base algorithm.

For each maintenance object that your implementation does not want to enable for ILM, inactivate the eligibility algorithm. This will ensure that the ILM Crawler Initiator background process does not submit the crawler batch job for the maintenance object in question.

- Go to the [Maintenance Object - Algorithm](#) tab for each maintenance object and take note of the **ILM Eligibility** algorithm code.
- Go to the [Maintenance Object - Option](#) tab for the same maintenance object and add an option with an option type of **Inactivate Algorithm** and the value set to the ILM eligibility algorithm noted in the previous step.

Database Administrator Tasks

In order to implement ILM for each of the maintenance objects determined above, your database administrator must perform several steps in the database for the tables related to each MO. The following points are a summary of those steps. More detail can be found in the Information Lifecycle Management section of your product's *Database Administration Guide*.

- **Initializing ILM Date:** Your existing tables that are enabled for ILM may not have the ILM Date and ILM Archive switch initialized on all existing records. When choosing to enable ILM, a first step is to initialize this data based on recommendations provided in the DBA guide.
- **Referential Integrity:** The recommended partitioning strategy for child tables in a maintenance object is referential partitioning. In order to implement this, database referential integrity features must be enabled.
- **Partitioning:** This provides a way in which the data can segregate into multiple table partitions and will help in better management of the lifecycle of the data.

Schedule the ILM Crawler Initiator

The final step of enabling the system for ILM is to schedule the ILM crawler initiator **F1-ILMIN** regularly based on your implementation's need. It is recommended to only schedule this batch process once all the required database activities are complete.

Ongoing ILM Tasks

For an environment where ILM is enabled, besides the periodic execution of the ILM crawler batch processes to review and mark records, your database administrator has ongoing tasks.

The DBA reviews and maintains partitions and identifies partitions that may warrant some type of archiving step. The Information Lifecycle Management section of your product's *Database Administration Guide* provides more information for your DBA.

Archived Foreign Keys

If your DBA chooses to archive a partition, there may be records in the system that refer to one of the archived records as a foreign key.

When a user attempts to view a record using a hyperlink or drill down mechanism, if the implementation of the navigation uses FK Reference functionality, the system will first check if the record exists. If not, it will display a message to the user indicating that the record has been archived.

Configuration Tools

This section describes tools to facilitate detailed business configuration. The configuration tools allow you to extend both the front-end user interface as well as create and define specialized back-end services.

Business Objects

A [maintenance object](#) defines the physical tables that are used to capture all the possible details for an entity in the system. A business object is tool provided to further define business rules for a maintenance object.

This section provides an overview of business objects and describes how to maintain them.

The Big Picture of Business Objects

The topics in this section describe background topics relevant to business objects.

What Is A Business Object?

A business object (BO) is a powerful tool used throughout the system. For many maintenance objects, a BO is a key attribute of the record used to define the data it captures, its user interface behavior and its business rules. Some business objects support the definition of a lifecycle, capturing different states that a record may go through, allowing for different business rules to be executed along the way. This type of business object is considered the “identifying” or “governing” business object. We will see later that other types of BOs exist that are different from the “identifying” business object.

The use of business objects allows for extensibility and customization of product delivered maintenance objects. There are many options to adjust the behavior of base delivered business objects. In addition, implementations may introduce their own business objects if the base product delivered objects do not meet their business needs.

NOTE: Not all maintenance objects in the product support business objects as a “identifying” or “governing” tool. This is the standard going forward for new maintenance objects. However, there are some maintenance objects created before this became a standard.

A Business Object Has a Schema

A business object has elements. The elements are a logical view of fields and columns in one of the maintenance object’s tables. The structure of a business object is defined using an XML schema. The main purpose of the schema is to identify all the elements from the maintenance object that are included in the business object and map them to the corresponding maintenance object fields. Every element in the BO schema must be stored somewhere in the maintenance object. The BO may not define elements that are derived.

When defining elements for the primary table or the language table (for an administrative object) there is no need to define the name of the physical table in the schema. The system infers this information. The following is a snippet of a schema:

```
<schema>
  <migrationPlan mapField="MIGR_PLAN_CD" suppress="true" isPrimeKey="true"/>
  <bo mapField="BUS_OBJ_CD" fkRef="F1-BUSOB"/>
  <customizationOwner mapField="OWNER_FLG" suppress="input"/>
  <version mapField="VERSION" suppress="true"/>
  <description mapField="DESCR"/>
  <longDescription mapField="DESCRLONG"/>
  ...

```

Many maintenance objects have child table collections (e.g., a collection of names for a person, or a collection of persons on an account). Depending on the requirements, the business object may define the full collection such that the user will

maintain the information in a grid. However, the schema also supports “flattening” records in a child table so that they can be treated as if they were singular elements. The following are examples of each:

Example of a child table. This is a snippet of the Instructions collection on the migration plan business object. You can see that the list attribute defines the child table and all elements within it map to the appropriate column in that table.

```
<migrationPlanInstruction type="list" mapChild="F1_MIGR_PLAN_INSTR">
  <migrationPlan mapField="MIGR_PLAN_CD" suppress="true"/>
  <sequence mapField="PLAN_INSTR_SEQ" suppress="true"/>
  <instructionSequence mapField="INSTR_SEQ"/>
  <instructionType mapField="INSTR_TYPE_FLG"/>
  <parentInstructionSequence mapField="PARENT_INSTR_SEQ"/>
  <businessObject mapField="BUS_OBJ_CD" fkRef="F1-BOMO"/>
...

```

Example of a simple “flattened” field. The business object for Status Reason includes an element called Usage, which maps to a pre-defined characteristic of type **F1-SRUSG**. The “row” defines which child table is being flattened and the attributes of the row in that child that uniquely identify it.

```
<usage mdField="STATUS_RSN_USAGE" mapField="CHAR_VAL">
  <row mapChild="F1_BUS_OBJ_STATUS_RSN_CHAR">
    <CHAR_TYPE_CD is="F1-SRUSG"/>
    <SEQ_NUM is="1"/>
  </row>
</usage>

```

Example of a “flattened row”. This business object for Account includes a single row for the Person collection where only the “financially responsible, main” customer is defined. The “accountPerson” attribute defines one field from that row (the Person Id) and includes the ‘flattening’ criteria in the “row” information. In addition, a second field from that same row (“accountRelType”) is defined. Instead of having to repeat the flattening criteria, the “rowRef” attribute identifies the element that includes the flattening.

```
<accountPerson mapField="PER_ID">
  <row mapChild="CI_ACCT_PER">
    <MAIN_CUST_SW is="true"/>
    <FIN_RESP_SW default="true"/>
  </row>
</accountPerson>
<accountRelType mapField="ACCT_REL_TYPE_CD" rowRef="accountPerson" dataType="string"/>

```

Example of a “flattened list”. The business object for Tax Bill Type includes an list of valid algorithms for “bill completion”. The Sequence and the Algorithm are presented in a list. The list element identifies the child table and the ‘rowFilter’ identifies the information about the list that is common.

```
<taxBillCompletion type="list" mapChild="C1_TAX_BILL_TYPE_ALG">
  <rowFilter suppress="true" private="true">
    <TAX_BILL_TYPE_SEVT_FLG is="C1BC"/>
  </rowFilter>
  <sequence mapField="SEQ_NUM"/>
  <algorithm mapField="ALG_CD" fkRef="F1-ALG"/>
</taxBillCompletion>

```

In addition, many maintenance objects support an XML structure field within the entity. These fields may be of data type CLOB or XML. One or more business object elements may be mapped to the MO's XML structure field. These elements may be defined in different logical places in the business object schema based on what makes sense for the business rules. When updating the MO, the system builds a type of XML document that includes all the elements mapped to the XML structure and stores it in one column. The following is an example of elements mapped to an XML column:

```
<filePath mdField="F1_FILE_PATH" mapXML="MST_CONFIG_DATA" required="true"/>
<characterEncoding mdField="F1_CHAR_ENCODING" mapXML="MST_CONFIG_DATA"/>

```

NOTE: If the MO's XML structure field is of the data type XML, the database will allow searching for records based on that data, assuming appropriate indexes are defined. If the MO's XML structure field is of the data type CLOB, indexing or joining to elements in this column via an SQL statement is not typically supported. Note that most MOs are currently using the CLOB data type for the XML structure column, if provided.

Some business objects may have child tables that allow data to be stored in an XML structure field. The schema language supports defining elements from those fields in your schema as well.

Besides including information about the physical “mapping” of the element to its appropriate table / field location in the maintenance object, the schema supports additional syntax to provide the ability to define basic validation and data manipulation rules, including:

- Identifying the primary key of the record or the primary key of the a row in a list.
- Identifying which elements are required when adding or changing a record.
- Default values when no data is supplied on an Add.
- For elements that are lookup values, the lookup may be specified to validate that the value of the element is a valid lookup value.
- For elements that are foreign keys to another table, the FK Reference may be specified to validate the data.

The system will check the validity of the data based on the schema definition obviating the need for any special algorithm to check this validation.

In addition, the schema language may include some attributes that are used to auto-render the view of the record on the user interface, such as the **suppress** attribute. Refer to [BO Defines its User Interface](#) for more information.

NOTE: Refer to [Schema Syntax](#) for the complete list of the XML nodes and attributes available to you when you construct a schema.

A business object’s schema may include a subset of the fields and tables defined in the maintenance object. There are two reasons for this:

- The fields or tables may not be applicable to the type of record the business object is governing. For example, a field that is specific to gas may not be included on a Device business object that is specific to electric meters.
- The information is not maintained through the business object, but rather maintained separately. For example, many BO based maintenance objects include a Log table. The records in the log table are typically not included the BO because they are viewed and maintained separately from the business object.

A Business Object May Define Business Rules

A business object may define business rules that govern the behavior of entities of this type.

- Simple element-level validation is supported by schema attributes. Note that element-level validation is executed before any maintenance object processing. For more sophisticated rules you create **Validation** algorithms and associate them with your business object. BO validation algorithms are only executed after "core validation" held in the MO is passed.
- A **Pre-Processing** algorithm may be used to "massage" a business object's elements prior to any maintenance object processing. For example, although simple element-level defaulting is supported by schema attributes. you may use this type of algorithm to default element values that are more sophisticated.
- A **Post-Processing** algorithm may be used to perform additional steps such as creating a To Do Entry or add a log record as part of the business object logical transaction. These plug-ins are executed after all the validation rules are executed.
- An **Audit** algorithm may be used to audit changes made to entities of this type. Any time a business entity is added, changed or deleted, the system detects and summarizes the list of changes that took place in that transaction and hands it over to **Audit** plug-ins associated with the business object. These plug-ins are executed after all the post-processing rules are executed. It is the responsibility of such algorithms to log the changes if and where appropriate, for example as a log entry or an entry in an audit trail table or an entry in the [business event log](#)

By default all elements of the business object are subject to auditing. You can however mark certain elements to be excluded from the auditing process using the **noAudit** schema attribute. Marking an element as not auditable will prevent it from ever appearing as a changed element in the business object's audit plug-in spot. In addition, if the only elements

that changed in a BO are ones marked to not audit, the audit algorithm is not even called. Refer to [Schema Syntax](#) for more information on this attribute.

Refer to [Business Object - Algorithms](#) for more information on the various types of algorithms.

The system applies business object rules (schema based and algorithms) whenever a business object instance is added, changed or deleted. This is only possible when the call is made via the maintenance object service. For example, when made via business object interaction ("invoke BO"), the MO's maintenance page or inbound web services that reference the BO. In addition the system must be able to [determine the identifying business object](#) associated with the actual object being processed. If the business object cannot be determined for a maintenance object instance business object rules are not applied.

NOTE:

Pre-Processing is special. The pre-processing algorithm plug-in spot is unique in that it only applies during a BO interaction. It is executed prior to any maintenance object processing. It means that when performing add, change or delete via the maintenance object service, the pre-processing plug-in is not executed.

CAUTION: Direct entity updates bypass business rules! As mentioned above, it is the maintenance object service layer that applies business object rules. Processes that directly update entities not via the maintenance object service bypass any business object rules you may have configured.

FASTPATH: Refer to [BO Algorithm Execution Order](#) for a summary of when these algorithms are executed with respect to lifecycle algorithms.

The plug-in spots described above are available for all business objects and they are executed by the system when processing adds or updates to the business object. It is possible for a specific maintenance object to define a special plug-in spot for business objects of that MO. When this happens, the maintenance object identifies the special algorithm entity lookup value as an [MO option](#): **Valid BO System Event**, causing the BO Algorithm collection to include that system event in its list.

A Business Object Defines its User Interface

One of the responsibilities of an identifying business object is to define its user interface rules for viewing and maintenance of its record. The standard implementation for maintaining a business object is that a [maintenance portal](#) is used to display a record. This portal includes a "map" zone that displays the information about the business object. To add or make changes to a record, the user clicks a button that launches a maintenance BPA script which displays a maintenance "map".

The display and maintenance "maps" are driven by the business object. The BO may define a full [UI map](#) where all the information is displayed based on the map's HTML. Note that for a child BO, the maps may be [inherited](#) by a parent BO (or any BO "up the chain").

The standard going forward is to use schema definition and UI Hints to define user interface behavior so that a full UI map is not needed but rather the HTML is derived. The schema language includes some basic display attributes such as **label** and **suppress**. UI hints provide many additional tags and elements that allow dynamic generation of formatted UI Maps. For more complex behavior in the user interface, for example where javascript is needed, UI map fragments may be defined within the schema via UI hints. In this way only complex UI behavior warrants small snippets of javascript and HTML. However the rendering of standard fields can be dynamically rendered. UI map fragments also allow for derived fields to be included in the user interface.

A business object schema may include [data areas](#) for segments of its schema definition to allow for reusable components. In this case the data area would also include schema attributes and UI hints for the elements that it is including.

NOTE: Refer to [UI Hint Syntax](#) for detailed information about the supported syntax.

As mentioned in [Business Object Inheritance](#), schemas are not inherited on a child business object. As such, when using UI hints for automatic UI rendering, the child BO must define the full schema with all the definitions. A good business object hierarchy will be designed for reuse meaning that the child BO will include the parent BO schema or alternatively, the BO schemas will include reusable data areas.

Invoking A Business Object

We have talked about defining a business object. This section describes how business objects are used throughout the system to view, add and update records.

- Various parameters for zones that are used to display data in the system include support for retrieving data by referencing a business object. The zone code will "invoke" the BO, meaning that the record will be retrieved using the referenced BO.
- The system's [scripting](#) language includes a step type to "invoke BO". This allows for BPA scripts, service scripts and plug-in scripts to retrieve information and add or update records using BO interaction.
- [Inbound web services](#) may reference a business object in its operations collection. This allows external systems to add or update records in our product via web service interaction.

Often when configuring a zone or writing a script, the BO to use in the "invoke BO" statement should be the identifying BO of the record. As such, often the script will include steps prior to the "invoke BO" step to "[determine the identifying BO of the record](#)" and once the identifying BO is found, the script step will invoke that BO. Note that zones and inbound web services reference a BO directly. In each case, if the BO to use should be dynamic, then the zone / inbound web service should reference a service script that can perform the steps to identify the BO and then invoke that BO.

It should be noted however that the BO used in an "invoke BO" statement (or referenced in an inbound web service) **does not have to match** the identifying BO for the record. Here are some examples of where this may be true:

- A script may only require a subset of elements for a record and not the entire record. In this case, it is better for performance purposes to define a special BO (sometimes called a "lite" BO or a "mini" BO) that only defines the needed elements. When the system retrieves the data, it will only access the tables that are included in the BO's schema definition. In addition, if there are no elements that map to an XML structure field, the system will skip any parsing of that column. Similarly, if a script is **updating** a subset of elements on a record, it may be beneficial to use a "mini" BO to do the updates.

NOTE: Please note the following with respect to using a mini BO. This BO is only used for its schema. This type of BO would not define algorithms or a lifecycle. Because the BO is special, it often should not be able to be used as any record's identifying BO. To control that, these BOs are often configured to not allow new instances. Refer to [Determine the Identifying BO](#) for more information.

- The maintenance object to be added or updated in a script may not support business objects as "identifying BOs". For example, Batch Control maintenance object does not have an identifying BO. However, scripts may still wish to retrieve data (or make updates) to these types of records. An easy way to achieve that goal is to define a business object and use "invoke BO" to access the data.

NOTE: Not all maintenance objects support being maintained through a business object interaction. This is true in a small number of older objects where the underlying maintenance service includes additional functionality besides simply updating the database tables. These maintenance objects are identified via the [MO option](#) **BO Maintenance**, set to **N**.

- Some functionality may be trying to add or update records for a maintenance object in a 'physical' manner and do not want or need to use the object's identifying BO. Or the MO may not have an identifying BO. For example, revision control takes a snapshot of a record for audit purpose and to be able to restore a previous version. In this case, the system wants to capture a full "physical" view of the record. To do this, a special "physical" BO may be created that includes all (or most of) the columns and the child tables.

NOTE: Like the mini BO, the physical BO would not define algorithms or a lifecycle and should not be able to be used as any record's identifying BO. To control that, these BOs are often configured to not allow new instances. Refer to [Determine the Identifying BO](#) for more information.

NOTE: To reiterate, the BO referenced in the "invoke BO" statement or referenced in an inbound web service does not have to match the identifying BO and does not have to be configured to "allow new instances".

Determine the Identifying BO

As mentioned in other topics, the identifying BO is the business object that governs the business rules for a record. This is the business object that the record will be validated against when any additions or changes are made to the record as long as updates are made via the maintenance service. This includes using "invoke BO" for add or update, using inbound web service interaction and for access to the maintenance page service (via an old style fixed page or via a business service).

How does the system determine the identifying BO? An algorithm plugged into the maintenance object (the **Determine BO** plug-in spot) is responsible for this. If the maintenance object is not configured with an algorithm for this plug-in spot, or no BO is found by the algorithm, no BO business rules are applied.

Most maintenance objects in the system capture the record's identifying BO directly on the record. However, it is possible to define the identifying BO somewhere else. For example, there may be some maintenance objects that are master or transaction objects with an associated "type" object where the identifying BO is defined on its "type" object. Note that the standard Determine BO algorithm plugged into most maintenance objects (**F1-STD-DTMBO - Determine Standard Business Object**) checks for these two conditions.

There may also be cases where a single identifying BO is used for all BOs for a given MO. This may be an option used for some older maintenance object created prior to the business object functionality when implementations wish to introduce custom business rules that are common for all records of that MO. The product provides a base algorithm type (**F1-MOBO - Determine Specific Business Object**) that captures the BO as a parameter.

Base Business Objects

For each maintenance object (MO) that supports an "identifying" business object, the type of business object provided by the product depends on the functionality and expected use by implementations. The following are some common patterns.

- There are MOs where the product provides base BOs that implementations may use if applicable for their business rules. In addition, it is expected that implementation will define custom BOs to support their business needs. Good examples of this type of MO are any of the various "rule" MOs. For example, calculation rule in Oracle Utilities Customer Care and Billing or the usage rule in Oracle Utilities Meter Data Management. The product provides business objects for common rules but each implementation could have special rules that they need to implement and will need to create custom business objects.
- There are MOs where the product provides base BOs that supply common behavior for an object. Implementations may find that supplied the business objects match their business requirements and use the BOs as is. It is expected, however that for many implementations, their business rules will require additional elements to be captured or have special rules to apply. In this case the base business objects may be extended. This scenario may apply to 'master' data objects in various products such as the Device or Meter.
- There are MOs where the product may deliver a base BO that is not expected to satisfy most implementations because different jurisdictions or different implementations will typically have their own rules. In this case the base delivered BO can be used as a template or starting point for custom defined BOs. Some examples of this are Rebate Claim in Oracle Utilities Customer Care and Billing.
- There are MOs where the expectation is that every implementation will have different requirements for the type of data to capture and the product will not supply base BOs that can be used as the "identifying" BO. However, it may supply a "parent" BO that defines the lifecycle and many of the business rules that it expects all records to follow. In these

scenarios, the implementations will create "child" BOs that will serve as the "identifying" BOs and refer to the base "parent" BO for many of its rules through [inheritance](#). An example of this is the Activity in Oracle Utilities Mobile Workforce Management.

- There are some scenarios where the base product provides business objects and the expectation is that implementations will use the business objects as delivered with little or no customization. This is a case where the system used business objects to implement product functionality, not because there is an expectation that the implementers will extend the functionality, but because the business object model is the favored development tool even for the product. The objects delivered for Content Migration Assistant are an example.

NOTE: Not all maintenance objects in the product support business objects as a "identifying" or "governing" tool. This is the standard going forward for new maintenance objects. However, there are some maintenance objects created before this became a standard.

For all maintenance objects, the base product may provide additional BOs that are not meant to be "identifying" BOs, but instead are provided to support functionality to interact with the MO using the BO as a tool as described in [Invoking a BO](#).

- One or more "mini" or "lite" BOs may be supplied for a maintenance object. This may be found when the product has functionality to retrieve a subset of elements for the maintenance object via scripting or via a user interface.
- A "physical" BO may be supplied. This a BO that typically includes all tables and all fields of the maintenance object in there "physical" form. In other words, there is no "flattening" of child tables and any XML structure fields are defined as a single field. Physical BOs are used in system processing where the full record needs to be captured as is. Some functionality that uses a physical BO includes [bundling](#), [revision control](#) and the pre-compare algorithm for CMA to [adjust data prior to comparing](#). If there are any maintenance objects that do not have a base supplied physical BO, refer to [Creating a Physical Business Object](#) for steps on how to provide one.
- A "bundling add" BO may be supplied. Refer to [Recursive Key References](#) for more information as to why this type of BO may be supplied.

Business Object Inheritance

A business object may inherit business rules from another business object by referencing the latter as its parent. A child business object can also have children, and so on. A parent's rules automatically apply to all of its children (no compilation - it's immediate). A child business object can always introduce rules of its own but never remove or bypass an inherited rule.

The following is an illustration of multiple levels of business object inheritance.

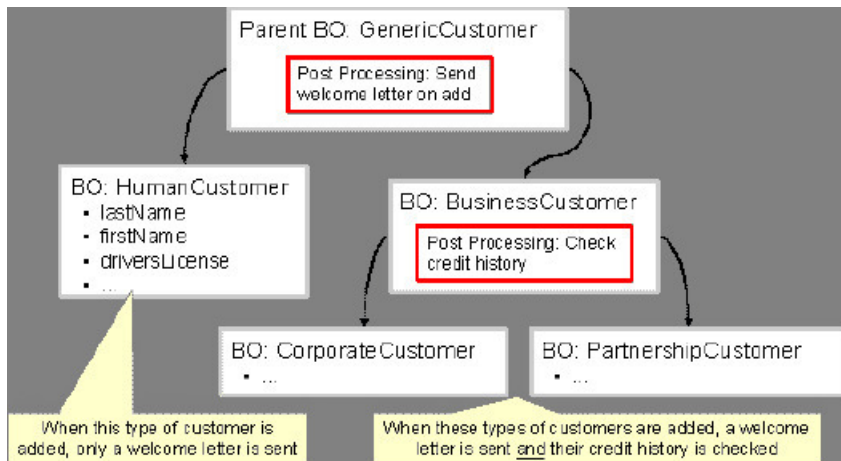

Notice how the "Business Customer" business object extends its parent rules to also enforce a credit history check on all types of customers associated with its child business objects.

Most types of business object system events allows for multiple algorithms to be executed. For example, you can have multiple **Validation** algorithms defined for a business object. For these, the system executes all algorithms at all levels in the inheritance chain starting from the highest-level parent business object moving on to lower levels.

Other types of system events allows for a single algorithm to be executed. For example, you can only have one **Information** algorithm to format the standard description of a business object instance. For these, the system executes the one at the level nearest to the business object currently being processed.

NOTE: The parent and its children must reference the same maintenance object.

NOTE: Data structures are not inherited. While you can declare schemas on parent business objects, their children will not inherit them. A good practice is to design child business object schemas to **include** their parent business object's schema.

NOTE: User interface maps are inherited. When determining if the business object has a UI map to use for UI rendering, the system looks for display and maintenance maps linked to the BO as options. If the identifying BO does not have maps defined, the system follows “up the chain” of inheritance until it finds a map to use. This allows for a child BO to be used to extend business rules of a parent BO but inherit its user interface behavior. Refer to [Business Object Defines its User Interface](#) for more information.

NOTE: Use Inheritance Wisely. While it is intellectually attractive to abstract behavior into parent BOs to avoid redundant logic and simplify maintenance, before doing this weigh the reuse benefits against the cost in transparency, as it is not easy to maintain a complex hierarchy of business objects.

Each Business Object Can Have A Different Lifecycle

Many maintenance objects have a status column that holds the business entity's current state within its lifecycle. Rules that govern lifecycle state transition (e.g., what is its initial state, when can it transition to another state, etc.) and the behavior associated with each state are referred to as lifecycle rules. Older Maintenance Objects, such as To Do Entry, have predefined lifecycles whose rules are governed by the base-package and cannot be changed. The lifecycle of newer Maintenance Objects exists in business object meta-data and as such considered softly defined. This allows you to have completely different lifecycle rules for business objects belonging to the same maintenance object.

Here are examples of two business objects with different lifecycles that belong to the same maintenance object.

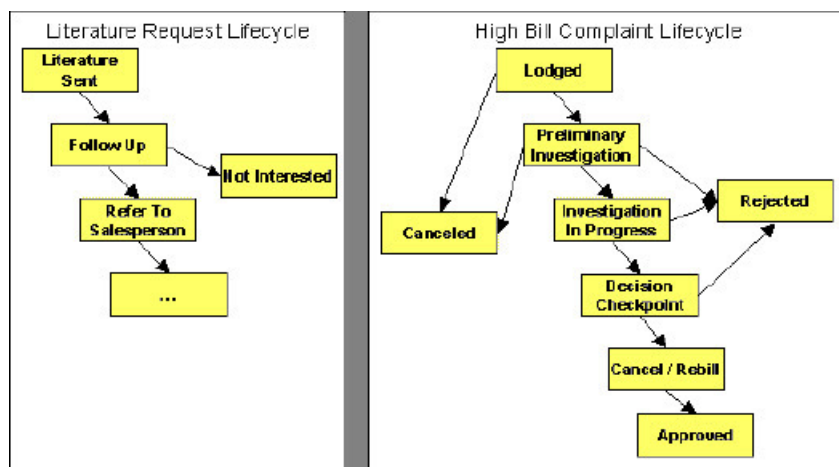

NOTE: A Maintenance Object supports soft lifecycle rules if it is defined with a **Status Field Maintenance Object** option.

The topics that follow describe important lifecycle oriented concepts.

Valid States versus State Transition Rules

The boxes in the above diagram show the potential valid states a business entity of the above business object can be in. The lines between the boxes indicate the state transition rules. These rules govern the states it can move to while in a given state. For example, the above diagram indicates a high bill complaint that's in the **Lodged** state can be either **Canceled** or moved into the **Preliminary Investigation** state.

When you set up a business object, you define both its valid states and the state transition rules.

One Initial State and Multiple Final States

When you set up lifecycle states, you must pick one as the initial state. The initial state is the state assigned to new entities associated with the business object. For example, the above high-bill complaint business object defines an initial state of **Lodged**, whereas the literature request one defines an initial state of **Literature Sent**.

You must also define which statuses are considered to be "final". Typically when an entity reaches a "final" state, its lifecycle is considered complete and no further processing is necessary.

NOTE: Allowing An Entity To Be "Reopened". You can set up your state transition rules to allow a business entity to be "reopened" (i.e., to be moved from a final state to a non-final state). Neither of the above examples allows this, but it is possible if you configure your business object accordingly.

State-Specific Business Rules

For each state in a business object's lifecycle, you can define the following types of business rules.

FASTPATH: Refer to [BO Algorithm Execution Order](#) for a summary of when these lifecycle algorithms are executed with respect to BO level algorithms.

Logic To Take Place When Entering A State

You can define algorithms that execute before a business entity enters a given state. For example, you could develop an algorithm that requires a cancellation reason before an entity is allowed to enter the **Canceled** state.

You can also incorporate state auto-transitioning logic within this type of algorithms. Refer to [auto-transition](#) for more information.

Also note that when a record is processed by the monitor batch program, by default the BO Post Processing, BO Audit and MO Audit algorithms are not executed. However, it is possible for an enter algorithm to indicate that the other algorithms should be executed by the batch process by setting the "force post processing" indicator to true.

Logic To Take Place When Exiting A State

You can define algorithms that execute when a business entity exists a given state. For example, you could develop an algorithm that clears out error messages when a given entity exits the **Error** state.

Also note that when a record is processed by the monitor batch program, by default the BO Post Processing, BO Audit and MO Audit algorithms are not executed. However, it is possible for an exit algorithm to indicate that the other algorithms should be executed by the batch process by setting the "force post processing" indicator to true.

Monitor Rules

You can define algorithms to monitor a business entity while it is in a given state. This type of logic is typically used to check if the conditions necessary to [transition](#) the entity to another state exist (and, if so, transition it). For example, transition an entity to the **Canceled** state if it's been in the **Error** state too long. Another common use is to perform ancillary work while an entity is in a given state. For example, update statistics held on the object while it's in the **Active** state.

Monitor algorithms are invoked when a business entity first enters a state and periodically after that in [batch](#). You have the option to defer the monitoring of a specific state until a specific monitoring batch job runs. You do so by associating the state with a specific monitoring process. In this case the system will only execute the monitoring rules of this state when that specific batch process runs. This is useful when processing one type of record typically creates another type of record. You may want the processing of the second set of records to be deferred to a later time.

A monitor algorithm can carry out any business logic. In addition it can optionally tell the system to do either of the following:

- Stop monitoring and transition to another state. The system will not call any further monitoring algorithm plugged in on the state and attempt to transition the entity to the requested new state.
- Stop monitoring. Same as above except that no transition takes place. You may want to use this option to prevent transitions while some condition is true.

If none of the above is requested the system keeps executing subsequent monitoring algorithms.

Also note that when a record is processed by the monitor batch program, by default the BO Post Processing, BO Audit and MO Audit algorithms are not executed. However, it is possible for a monitor algorithm to indicate that the other algorithms should be executed by the batch process by setting the “force post processing” indicator to true.

FASTPATH: Refer to [Business Object - Lifecycle](#) for more information on how to set up state-specific algorithms.

Inheriting Lifecycle

If a business object references a parent business object, it always [inherits](#) its lifecycle from the highest-level business object in the hierarchy. In other words, only the highest-level parent business object can define the lifecycle and the valid state transitions for each state. Child business objects, in all levels, may still extend the business rules for a given state by introducing their own state-specific algorithms.

The system executes all state-specific algorithms at all levels in the inheritance chain starting from the highest-level parent business object moving on to lower levels.

Auto-Transition

In a single transition from one state to another, the system first executes the **Exit** algorithms of the current state, transitions the entity to the new state, executes the **Enter** algorithms of the new state followed by its **Monitor** algorithms. At this point if a **Monitor** algorithm determines that the entity should be further automatically transitioned to another state the remaining monitoring algorithm defined for the current state are not executed and the system initiates yet another transition cycle.

Notice that an **Enter** algorithm can also tell the system to automatically transition the entity to another state. In this case the remaining **Enter** algorithm as well as all **Monitor** algorithms defined for the current state are not executed.

The following illustration provides an example of an auto-transition chain of events.

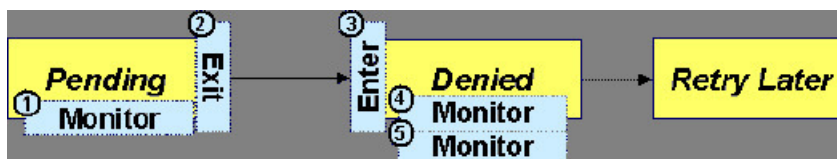

In this example a business entity is in a Pending state. While in that state a **Monitor** algorithm determines to auto-transition it to the Denied state. At this point the following takes place:

- No further **Monitor** algorithms of the Pending state are executed
- Pending state **Exit** algorithms are executed
- The system transitions the entity to the Denied state
- Denied state **Enter** algorithms are executed. No further auto-transition is requested.
- Denied state **Monitor** algorithms are executed. No further auto-transition is requested.

Keeping An Entity In Its Last Successful State

By default, any error encountered while transitioning a business entity from one state to another rolls back all changes leaving the entity in its original state.

When applicable, the Maintenance Object can be configured to always keep an entity in its last successful state rather than rolling all the way back to the original state. This practice is often referred to as "taking save-points". In case of an error, the entity is rolled back to the last successfully entered state and the error is logged on the [maintenance object's log](#). Notice that with this approach no error is returned to the calling process, the error is just logged.

The logic to properly log the error is in a **Transition ErrorMaintenance Object plug-in**. The system considers a maintenance object to practice "save-points" when such an algorithm is plugged into it.

Even if the maintenance object practices "save-points", in case of an error the system will not keep an entity in the last successfully entered state if that state is either marked as [transitory](#) or one of its **Enter** algorithms has determined that the entity should proceed to a next state. The system will roll back to the first previous state that does not match these conditions.

Monitoring Batch Processes

A monitor batch process may be used to transition a business object into its next state by executing the monitor algorithms associated with the current state of the entity. The use cases for performing the monitor logic in batch are as follows:

- The record may be waiting for something else to occur before transitioning. The monitor algorithm may be coded to determine if the condition is satisfied and initiate the transition then. For example perhaps when entering a state, a field activity is generated and the record should exit the state when the field activity is complete. The monitor algorithm can check the status of the field activity.
- Perhaps a record is added or updated manually and the next step in the BO lifecycle includes a large amount of processing such that the logic should occur in batch. In this case the BO status is configured with an explicit reference to a batch control (referred to as "deferred"), which indicates to the system that the monitor algorithms should not be performed automatically (but should be deferred to batch). Later when the batch process runs, it selects all the records to process to progress the records.

NOTE: When a status includes a deferred batch control, it may also be configured to allow a user to manually transition the record to the next state rather than waiting for batch. When a user manually transitions a record that includes monitor algorithms, those algorithms are not executed.

- Perhaps a record is added or updated in batch, but a subsequent step in the overall lifecycle should be processed later. This may be accomplished by ensuring that the batch control linked to the state to process later does not match the batch control that added or updated the record.
- Monitor processes may also be used to periodically perform some logic related to the record without actually transitioning the record.

Note that only the parent business object may refer to a deferred monitor batch process. However, any business object in the ["inheritance"](#) chain may be configured with monitor algorithms, which will all be executed.

The base package provides a periodic monitoring batch process for each maintenance object that supports a configurable BO lifecycle. The process periodically executes the monitoring algorithms associated with the current state of an entity, excluding states explicitly referencing a deferred monitoring batch process that is for a different batch control.

A deferred monitoring process selects records whose current state references this particular batch control as their monitor process. Deferred monitor process is only needed when an object has different use cases for monitoring the same type of records with different schedules. In this case only one periodic monitor batch should be configured. Other monitors should be configured to restrict by batch control so that there is no overlap in processing.

NOTE: MO option configuration. The maintenance object includes options to indicate the batch controls delivered for periodic and deferred monitor batch controls.

Your business rules will dictate the execution frequency of each monitoring process and the order in which they should be scheduled. Refer to [Monitor Background Processes](#) in the background process chapter for more information about the parameters supported for this type of batch process.

NOTE: Updates to the business object. When the monitor algorithms indicate that the business object should transition, the monitor batch processes are responsible for ensuring the business object is transitioned appropriately and that the appropriate exit, enter and monitor algorithms are executed. Please note that the business object is not updated using a call to the maintenance object service and therefore by default the [business rules](#) plugged in to the business object are not executed. However, it is possible for an Enter algorithm, Exit algorithm or Monitor algorithm to indicate that the other algorithms should be executed by the batch process. If the “force post processing” indicator is set to true, then the batch process invokes the BO Post Processing, BO Audit and MO Audit algorithms.

Transitory States

You can define a state as **Transitory** if you do not wish the business entity to ever exist in that particular state.

The following illustrates a lifecycle with a transitory Validate state.

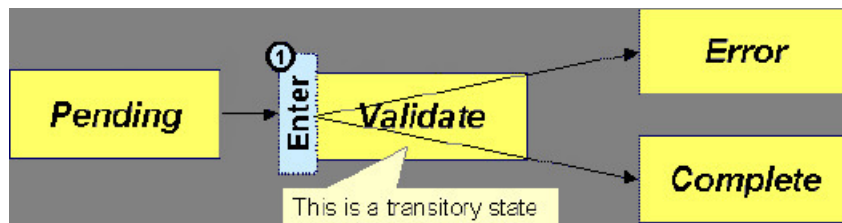

In this example, the business entity is saved still not validated in the Pending state. At some point, the user is ready to submit the entity for validation and transitions it into a transitory state Validate whose **Enter** rules contain the validation logic. The responsibility of the transitory state's **Enter** algorithms is to decide if the entity is valid or in error and then transitions it into the appropriate final state. In this scenario, you may not ever want the business entity to exist in the Validate state.

Let's also assume that the maintenance object in this example is practicing "[save-points](#)" and requires the entity to be kept in its last successful state. If an error were to occur during the transition from **Validate** to the next state, the system would roll back the entity back to Pending, and not Validate even though the entity has successfully entered the Validate state. Refer to the [Auto Transition](#) section for more information.

State Transitions Are Audited

Most Maintenance Objects that support soft lifecycle definition also have a log to hold significant events throughout a business entity's lifecycle. For example, log entries are created to record:

- When the business entity is created (and who created it)
- When its status changes (and who changed it)

- If a transition error occurred (and the error message)
- References to other objects created throughout the entity's lifecycle. For example, if a To Do entry is created as part of processing the entity, the To Do Entry is referenced in the log.
- Manual entries added by a user (think of these as "diary" entries)

When a business entity is first created and when it transitions into a new state the system calls **Transition** algorithm(s) plugged in on the [Maintenance Object](#) to record these events. If the maintenance object supports a log these events can be captured as log entries.

NOTE: Most base package maintenance objects supporting a log may already provide state transition logging as part of their core logic. In this case you only need to provide a **Transition** plug-in if you wish to override base logging logic with your own.

Required Elements Before Entering A State

You can define additional elements that are required before a business entity can enter a given state. For example, let's assume that a Cancel Reason must be defined before an object can enter the *Canceled* state. You do this by indicating that element as a **Required Element** [state-specific option](#) on the appropriate state on the business object.

Capturing a Reason for Entering a State

Some business objects support configuring certain states to allow or require a status reason when an object enters the state. The product provides a centralized status reason table that may be used to define the valid BO status reasons for various business objects and various states. The status reasons are defined using the [Status Reason](#) portal.

The following sections provide additional information about the BO status reason functionality.

Maintenance Object Must Support Status Reason

In order for a business object to use the centralized status reason table to define reasons, the maintenance object must first support the status reason. MOs that support status reason have the following characteristics:

- The primary table includes a column for Status Reason. This represents the status reason for the record's current status, if applicable.
- The log table includes a column for Status Reason. The standard logic for capturing a log record when entering a state also captures the status reason, if applicable. This allows a user to review the history of the changes in status and the status reason captured for a previous state transition, if applicable.
- The maintenance object option collection includes an option that defines the Status Reason field. This setting is a trigger for business objects of this MO to be able to configure states to allow or require status reason.

Business Object State Indicates if Reasons are Applicable

Once the MO is configured to support status reason, configuration on the business object is required to indicate the states where a reason is applicable. States may be configured to require status reasons, allow status reasons as optional or not allow status reasons. With this configuration, the framework will automatically get the list of valid reasons for a state that allows or requires them and then prompt the user for a status reason when a manual state transition occurs for that state. It also automatically triggers an error if the state requires a status reason and no reason is provided.

NOTE: The status reason configuration on the business object state is customizable. That means that for a product owned business object, an implementation may opt to change the delivered configuration.

Status reasons are defined for the parent (or "lifecycle") business object. All business objects in the hierarchy of the parent business object have the same valid reasons for their states.

The status reason code must be unique for the centralized status reason table. Business object and status are required fields, so it is not possible to share a common reason `code` (like “Not applicable”) across multiple business objects or states. If multiple BOs / states want to support a reason “Not applicable” then each must define a unique record for it. This point should be considered when planning for your status reasons.

Selectable vs. Not Selectable

When defining a status reason, you may indicate whether it’s **Selectable** or **Not Selectable**. When a manual transition is performed and a user is prompted for a status reason, only the **Selectable** reasons are presented. The **Not Selectable** reasons may be defined to support transitions that occur via algorithm processing.

NOTE: The Selectable setting is customizable. That means that if a product provides a base owned status reason for a business object state, an implementation may opt to change whether it is selectable or not. Careful consideration should be made before changing a base delivered status reason from **Not Selectable** to **Selectable** as this may affect base provided algorithm functionality that could be relying on the setting of **Not Selectable**.

Status Reason Business Object

The status reason maintenance object, as with many maintenance objects in the product, references a business object used to define attributes and behavior related to defining status reasons. The framework provides a business object for status reason (**F1-BOStatusReason**). For the business objects that have states that require a status reason (let’s call these “transactional BOs”), if there is some special logic required for defining the status reasons, it is possible to define a different status reason BO. In this situation, the override status reason BO to use for capturing status reasons should be defined as a BO option on the transactional BO using the **Status Reason Business Object** option type. If a transactional BO does not define any status reason BO option, then the **F1-BOStatusReason** is used when adding a status reason.

Defining a Usage

The base product status reason BO provides the ability to define a “usage” value. This is useful for algorithms that perform state transitions where a status reason is needed and where the algorithm is usable by more than one business object. In this case, the status reason to use cannot be provided as a parameter because each business object must define its own set of status reasons for each state. The Usage value can be used instead. Each business object can configure the status reason to use in the algorithm and set the appropriate usage value. The algorithm can reference the usage value and retrieve the correct status reason to use based on the record’s transactional BO.

The status reason business object provided with the framework product (**F1-BOStatusReason**) supports capturing a usage. The valid usage values are defined in the **Status Reason Usage** characteristic type.

Alternatives for Defining Reasons

There may be business objects in the system that capture reasons that are defined somewhere besides the BO status reason table. For example, some objects may have an explicit administrative table for status reasons. Some objects may use a Lookup or an Extendable Lookup to capture reasons. Refer to the business object description for information about how valid reasons are defined, if applicable.

If a business object supports a reason that is not related to a state transition (such as a creation reason), the BO status reason would not be used. One of the alternate methods for defining a reason, described above, would be used.

Opening UI Maps Before Entering A State

You can define a UI Map to capture additional elements before a business entity can enter a given state. You do this by configuring the **State Transition UI Map** [state-specific option](#) on the appropriate state on the business object.

There may be circumstances in which the status pre-processing logic can determine the value of the elements, in which case it is not necessary to invoke the map. The system provides a data area (**F1-StateTransitionCommon**) which contains a boolean element to indicate if the state transition map can be skipped. This data area can be included in your pre-processing

script to allow the element to be set according to your business logic. The base maintenance script (**F1-MainProc**) references this element to determine whether to open the state transition map.

BO Algorithm Execution Summary

This table highlights the processing steps that occur when adding or changing a record that is governed by a business object.

Invoke BO	
Event	Comments
BO Pre-processing algorithms executed	These algorithms are only executed when Invoke BO is used. The business object in the Invoke BO is the one whose rules are executed.
MO Processing	
Event	Comments
Determine if status has changed.	The system keeps a note of the new status value but initially proceeds with the old value.
MO Processing.	Standard MO processing, including MO validation is executed.
Determine BO algorithm executed.	The MO level algorithm is executed to determine the identifying BO .
BO Validation algorithms executed.	
State transition rules are performed if the status has changed.	BO Status Exit algorithms for the “old” status executed. Status updated to the new value. BO Status Enter algorithms for the “new” status executed. If no error — MO Transition algorithms are executed. FASTPATH: Refer to State Transitions are Audited for more information. If error and there are “save points” the MO Transition Error algorithms are executed. FASTPATH: Refer to Keeping An Entity In Its Last Successful State for more information. Otherwise, the error is reported.
BO Status Monitor algorithms are executed.	If the record transitions again, the prior step (State transition rule step) is repeated for the new transition.
BO Post-processing algorithms are executed.	
BO Audit algorithms are executed.	These algorithms are only executed if the system detects a change in elements that are not marked with “no audit”.

NOTE: To emphasize, the steps in the MO Processing table are only executed when the maintenance object service is invoked. Any add or update initiated by an “invoke BO” statement will invoke the MO service. This is also true for web service that invoke the business object. The [Monitor Batch Process](#) does not invoke the maintenance service. By default the monitor batch process only executes the monitor algorithms and the state transition rules (if the monitor algorithms indicate that a status change should occur). However, it is possible for an Enter algorithm, Exit algorithm or Monitor algorithm to indicate that the other algorithms should be executed by the batch process. If the “force post processing” indicator is set to true, then the batch process invokes the BO Post Processing, BO Audit and MO Audit algorithms.

NOTE: For records that do not have a status, the state transition rules and the monitor rules are not applicable.

Granting Access To Business Objects

Every business object must reference an [application service](#). When you link a business object to an application service, you are granting all users in the group access to its instances. You can prevent users from transitioning a business object into

specific states by correlating each business object status with each application service action (and then don't give the user group rights to the related action).

FASTPATH: Refer to [The Big Picture Of Application Security](#) for information about granting users access rights to an application service.

The system checks if a user has access rights each time the application is invoked to add, change, delete, read, or transition a business object. However, if a business object invokes another business object, we assume that access was controlled by the initial business object invocation and we do not check access for other business objects that it invokes. In other words, access rights are only checked for the initial business object invoked in a service call.

In order to apply business object security the system must be able to determine the business object associated with the actual object being processed. To do that the Maintenance Object itself has to have a **Determine BO** algorithm [plugged in](#). If this algorithm is not plugged in or it cannot determine the BO on the MO, the system will not invoke any BO rules. If the business object cannot be determined for a maintenance object instance, business object security is not checked. In this case the system checks the user's access rights using standard maintenance object security.

NOTE: Parent business objects are ignored. If a child business object exists, a user need only have access to the child business object's application service (not to every application service in the business object hierarchy).

Defining Business Objects

The topics in this section describe how to maintain business objects.

Note that several context sensitive dashboard zones appear on this page and are visible on all tabs.

- **Schema Tips.** This zone provides several links to launch help topics related to valid schema syntax and UI Hint syntax in one click.
- **View UI Rendering.** This zone provides buttons to view the automatic rendering of the Display map or Input map based on the attributes defined in the schema, including UI hints.
- **Generate Schema.** This zone includes a button that can be used to generate a “physical” schema based on the maintenance object definition. The element names are taken from the Java field name for each column. Once generated, adjust the schema as desired.
- **Create a BO Algorithm.** This zone includes a button to create a script based algorithm related to this business object. You are then prompted for information regarding the plug-in spot (BO or BO Status) and the system event, the name, description, etc. Once all the information is provided, the system creates an algorithm type, algorithm, links the algorithm to the business object, creates the script and brings you to the script step to start defining the logic for the plug-in script.
- **BOs Linked to the MO.** This zone displays other business objects for the same maintenance object as the BO currently displayed. You may drill into any of the other BOs by clicking its description.

Business Object - Main

Use this page to define basic information about a business object. Open this page using **Admin > System > Business Object**

Use the **Business Object Query** portal to search for an existing business object. Once a business object is selected, you are brought to the maintenance portal to view and maintain the selected record.

Description of Page

Enter a unique **Business Object** name and **Description**. Use the **Detailed Description** to describe the purpose of this business object in detail. **Owner** indicates if this business object is owned by the base package or by your implementation (**Customer Modification**).

CAUTION: Important! If you introduce a new business object, carefully consider its naming convention. Refer to [System Data Naming Convention](#) for more information.

Enter the **Maintenance Object** that is used to maintain objects of this type.

Enter a **Parent Business Object** from which to [inherit](#) business rules.

Lifecycle Business Object is only displayed for child business objects, i.e. those that reference a parent business object. It displays the highest-level business object in the inheritance hierarchy. Refer to [Inheriting Lifecycle](#) for more information.

Application Service is the application service that is used to provide security for the business object. Refer to [Granting Access To Business Objects](#) for more information. The application service on the child business object must have the same valid actions as the application service on the parent business object.

Use **Instance Control** to allow or prevent new entities from referencing the business object. Typically only the [identifying BOs](#) are marked to allow new instances.

Click the **View Schema** hyperlink to view the business object's expanded schema definition. Doing this opens the [schema viewer](#) window.

Click the **View XSD** hyperlink to view the business object's expanded schema definition in XSD format.

The options grid allows you to configure the business object to support extensible options. Select the **Option Type** dropdown to define its **Value**. **Detailed Description** may display additional information on the option type. Set the **Sequence** to **1** unless the option can have more than one value. **Owner** indicates if this option is owned by the base package or by your implementation (**Customer Modification**).

NOTE: You can add new options types. Your implementation may want to add additional option types. For example, your implementation may have plug-in driven logic that would benefit from a new option. To do that, add your new values to the customizable lookup field **BUS_OBJ_OPT_FLG**. If you add a new option type for a business option, you must update its maintenance object to declare this new option type. Otherwise, it won't appear on the option type dropdown. You do that by referencing the new option type as a **Valid BO Option Type**[maintenance object option](#).

Business Object - Schema

Use this page to maintain a business object's schema. Open this page using **Admin > System > Business Object** and then navigate to the **Schema** tab.

Description of Page

The contents of this section describe the zones that are available on this portal.

The **General Information** zone displays main attributes of the business object.

Click the **View Schema** hyperlink to view the business object's expanded schema definition. Doing this opens the [schema viewer](#) window.

Click the **View XSD** hyperlink to view the business object's expanded schema definition in XSD format.

The [Schema Designer](#) zone allows you to edit the business object's schema. The purpose of the schema is to describe the business object's properties and map them to corresponding maintenance object fields.

FASTPATH: Refer to [Schema Syntax](#) and [UI Hint syntax](#) for a complete list of the XML nodes and attributes available to you when you construct a schema. Also note that the **Schema Tips** zone in the dashboard provides links to launch these help topics directly.

NOTE: Generating a Schema A context sensitive "Generate Schema" zone is associated with this page. The zone provides a button that allows the user to generate a basic schema that includes all the fields for all the tables for the BO's maintenance object. Note that each maintenance object has an underlying service and it's possible that some of the child

tables in the maintenance object are not included in the service definition. If that is the case, a message is issued and the generated schema would need to be adjusted to remove that child table.

NOTE: View UI Rendering. A context sensitive "View UI Rendering" zone is associated with this page. The zone is useful for [business objects that define the user interface detail](#) using schema attributes and UI Hints. The buttons allow you to view the automatically rendered display and input maps.

The **Schema Usage Tree** zone summarizes all cross-references to this schema. These may be other schemas, scripts, and web services. For each type of referencing entity, the [tree](#) displays a summary node showing a total count of referencing items. The summary node appears if at least one referencing item exists. Expand the node to list the referencing items and use their description to navigate to their corresponding pages.

Business Object - Algorithms

Use this page to maintain a business object's algorithms. Open this page using **Admin > System > Business Object** and then navigate to the **Algorithms** tab.

Description of Page

The **Algorithms** grid contains algorithms that control important functions for entities defined by this business object. You must define the following for each algorithm:

- Specify the **System Event** with which the algorithm is associated (see the table that follows for a description of all possible events).
- Specify the **Sequence Number** and **Algorithm** for each system event. You can set the **Sequence Number** to 10 unless you have a **System Event** that has multiple **Algorithms**. In this case, you need to tell the system the **Sequence** in which they should execute.
- If the algorithm is implemented as a script, a link to the **Script** is provided. Refer to [Plug-In Scripts](#) for more information.
- **Owner** indicates if this is owned by the base package or by your implementation (**Customer Modification**).

The following table describes each **System Event**. Refer to [A Business Object May Define Business Rules](#) for more information about these system events.

System Event	Optional / Required	Description
Audit	Optional	<p>Algorithms of this type may be used to audit certain changes made to business object instances.</p> <p>The system hands over to the algorithms a summary of all the elements that were changed throughout a specific call to update an object. Excluded from this processing are elements explicitly marked on the schema as requiring no audit. For each element its original value before the change as well as its new value are provided.</p> <p>It is the responsibility of the algorithms to record corresponding audit information.</p> <p>The system invokes all algorithms of this type defined on the business object's inheritance hierarchy. Refer to Business Object inheritance for more information.</p>
Information	Optional	<p>We use the term "Business Object Information" to describe the basic information that appears throughout the system to describe an entity defined by the business object. The data that appears in this</p>

System Event	Optional / Required	Description
		<p>information description is constructed using this algorithm.</p> <p>The system invokes a single algorithm of this type. If more than one algorithm is plugged-in the system invokes the one with the greatest sequence number found on the business object closest to the current business object in the inheritance hierarchy. Refer to Business Object inheritance for more information.</p>
Post-Processing	Optional	<p>Algorithms of this type may be used to perform additional business logic after a business object instance has been processed.</p> <p>The system invokes all algorithms of this type defined on the business object's inheritance hierarchy. Refer to Business Object inheritance for more information.</p>
Pre-Processing	Optional	<p>Algorithms of this type further populates a request to maintain a business object instance right before it is processed.</p> <p>The system invokes all algorithms of this type defined on the business object's inheritance hierarchy. Refer to Business Object inheritance for more information.</p>
Validation	Optional	<p>Algorithms of this type may be used to validate a business object instance when added, updated or deleted.</p> <p>The system invokes all algorithms of this type defined on the business object's inheritance hierarchy. Refer to Business Object inheritance for more information.</p>

FASTPATH: Refer to [BO Algorithm Execution Summary](#) for more information about how these algorithms fit within the business object processing.

NOTE: Generate Algorithm. A context sensitive "Generate a BO Algorithm" zone is associated with this page. Refer to [Defining Business Objects](#) for more information about this zone.

NOTE: You can add new system events. Your implementation may want to add additional business object oriented system events. For example, your implementation may have plug-in driven logic that would benefit from a new system event. To do that, add your new values to the customizable lookup field **BO_SEVT_FLG**. If you add a new business object system event, you must update the maintenance object to declare this new system event. Otherwise, it won't appear on the system event dropdown. You do that by referencing the new system event as a **Valid BO System Event maintenance object option**.

NOTE: You can inactivate algorithms on base Business Objects. Your implementation may want to use a business object provided by the base product, but may want to inactivate one or more algorithms provided by the base business object. To do that, on the business object where this algorithm is referenced, go to the options grid on Business Object - Main and add a new option, setting the option type to **Inactive Algorithm** and setting the option value to the algorithm code.

Business Object - Lifecycle

Use this page to maintain a business object's lifecycle oriented business rules and options. Open this page using **Admin > System > Business Object** and then navigate to the **Lifecycle** tab.

Description of Page

The **Status** accordion contains an entry for every status in the object's [lifecycle](#). The entry appears differently for a child business object as it can only extend its inherited lifecycle by introducing algorithms and options of its own.

Use **Status** to define the unique identifier of the status. This is not the status's description, it is simply the unique identifier used by the system. Only the highest-level business object can define lifecycle statuses. For a child business object the inherited status description is displayed allowing navigation to the corresponding entry on the business object defining the lifecycle.

Use **Description** to define the label of the status. This field is hidden for a child business object.

Use **Access Mode** to define the action associated with this status. Refer to [Access Rights](#) for the details of how to use this field to restrict which users can transition a business entity into this state. This field is hidden for a child business object.

Enter a **Monitor Process** to defer the monitoring of entities in this state until the specific batch process runs. Refer to [Monitor Rules](#) for more information. This field is hidden for a child business object.

The **Status Reason** dropdown indicates if users should be prompted to provide a specific reason when the business object enters this state. This field appears only if the Status Reason Field is configured as an option on the business object's maintenance object. Valid values are blank, **Optional**, and **Required**. The default value is blank (users are not prompted to provide a status reason). See [Configuring Status Reasons](#) for more information about status reasons.

Use **Status Condition** to define if this status is an **Initial**, **Interim** or **Final** state. Refer to [One Initial State and Multiple Final States](#) for more information about how this field is used. This field is hidden for a child business object.

Use **Transitory State** to indicate whether a business entity should ever exist in this state. Only **Initial** or **Interim** states can have a transitory state value of **Yes**. Refer to [transitory states](#) for more information. This field is hidden for a child business object.

Use **Alert** to indicate that being in this state warrants an application alert. This may be used by custom logic to provide an alert to a user that entities exist in this state. This field is hidden for a child business object.

Use **Display Sequence** to define the relative order of this status for display purposes. For example when displayed on the status accordion and on the summary tab page. This field is hidden for a child business object.

Algorithms

The **Algorithms** grid contains algorithms that control important functions for a given status. You must define the following for each algorithm:

- Specify the **System Event** with which the algorithm is associated (see the table that follows for a description of all possible events).
- Specify the **Sequence Number** and **Algorithm** for each system event. You can set the **Sequence Number** to 10 unless you have a **System Event** that has multiple **Algorithms**. In this case, you need to tell the system the **Sequence** in which they should execute.
- If the algorithm is implemented as a script, a link to the **Script** is provided. Refer to [Plug-In Scripts](#) for more information.
- **Owner** indicates if this is owned by the base package or by your implementation (**Customer Modification**).

The following table describes each **System Event**.

System Event	Optional / Required	Description
Enter	Optional	Algorithms of this type apply business rules when a business object instance enters a given state. The system invokes all algorithms of this type defined on the business object's inheritance hierarchy. Refer to Business Object Inheritance for more information.
Exit	Optional	Algorithms of this type apply business rules when a business object instance exits a given state.

System Event	Optional / Required	Description
		The system invokes all algorithms of this type defined on the business object's inheritance hierarchy. Refer to Business Object Inheritance for more information.
Monitor	Optional	Algorithms of this type monitor a business object instance while in a given state. Typically these are used to auto-transition it to another state. The system invokes all algorithms of this type defined on the business object's inheritance hierarchy. Refer to Business Object Inheritance for more information.

FASTPATH: Refer to [BO Algorithm Execution Summary](#) for more information about how these algorithms fit within other business object algorithms.

NOTE: Generate Algorithm. A context sensitive "Generate a BO Algorithm" zone is associated with this page. Refer to [Defining Business Objects](#) for more information about this zone.

NOTE: You can inactivate status level algorithms on base Business Objects. Your implementation may want to use a business object provided by the base product, but may want to inactivate one or more of the status oriented algorithms provided by the base business object. To do that, on the business object and status where this algorithm is referenced, go to the options grid and add a new option, setting the option type to **Inactive Algorithm** and setting the option value to the algorithm code.

Next Statuses

Use the **Next Statuses** grid to define the valid statuses a business entity can transition into while it's in this state. This section is hidden for a child business object. Refer to [Valid States versus State Transition Rules](#) for more information. Please note the following about this grid:

- **Status** shows the statuses for the top-level business object, the **Status Code**, the **Lifecycle BO description**, and the **Status description** for each status.
- Use **Action Label** to indicate the verbiage to display on the button used to transition to this status.
- **Sequence** controls the relative order of one status compared to others for display purposes. This information may be used to control the order in which buttons are presented on a user interface.
- **Default** controls which next state (if any) is the default one. This information may be used by an **Enter** or **Monitor** algorithm to determine an auto-transition to the default state. It may also be used to also mark the associated button as the default one on a user interface.
- **Transition Condition** may be configured to identify a common transition path from the current state. By associating a given "next status" with a transition condition value, you can design your auto-transition rules to utilize those flag values without specifying a status particular to a given business object. Thus, similar logic may be used across a range of business objects to transition a business entity into, for example, the next **Ok** state for its current state. You'll need to add your values to the customizable lookup field **BO_TR_COND_FLG**.
- **Transition Role** controls whether only the **System** or both **System and User** have the ability to transition a business entity into a given "next status".
- When you initially set up a business object lifecycle, none of the statuses will reside on the database and therefore you can't use the search to define a "next status". We recommend working as follows to facilitate the definition of this information:
 - Leave the Next Statuses grid blank when you initially define a business object's statuses
 - After all statuses have been saved on the database, update each status to define its Next Statuses (this way, you can use the search to select the status).

Options

The options grid allows you to configure the business object status to support extensible options. Select the **Option Type** drop-down to define its **Value**. **Detailed Description** may display additional information on the option type. Set the **Sequence** to **1** unless the option can have more than one value. **Owner** indicates if this option is owned by the base package or by your implementation (**Customer Modification**).

NOTE: You can add new options types. Your implementation may want to add additional option types. For example, your implementation may have plug-in driven logic that would benefit from a new option. To do that, add your new values to the customizable lookup field **BO_OPT_FLG**. If you add a new option type for a status, you must update the business object's maintenance object to declare this new option type. Otherwise, it won't appear on the option type dropdown. You do that by referencing the new option type as a **Valid BO Status Option Type** [maintenance object option](#).

Business Object - Summary

This page summarizes business object information in a high level. Open this page using **Admin > System > Business Object > Search** and then navigate to the **Summary** tab.

Description of Page

The contents of this section describe the zones that are available on this portal.

The **General Information** zone displays main attributes of the business object.

Click the **View Schema** hyperlink to view the business object's expanded schema definition. Doing this opens the [schema viewer](#) window.

Click the **View XSD** hyperlink to view the business object's expanded schema definition in XSD format.

The **Business Object Hierarchy** zone displays in a tree view format the [hierarchy](#) of child business object associated with the current business object. It also shows the current business object's immediate parent business object.

For business objects with a lifecycle, the **Lifecycle Display** zone shows a graphical depiction of the lifecycle. Refer to the embedded help of that zone for more information.

The **Options** zone summarizes business object and state specific options throughout the [inheritance](#) chain.

The **Rules** zone summarizes business object and state specific rules throughout the [inheritance](#) chain.

Advanced BO Tips and Techniques

The topics in this section describe some advanced tips and techniques for configuring business objects.

Creating a Physical Business Object

The physical business object's schema represents the complete physical structure of the maintenance object, and includes elements for all fields in the maintenance object's tables. There are several processes in the system that may use a maintenance object's physical BO.

To create a physical business object for the maintenance object:

1. Navigate to [Business Object](#) and specify the maintenance object.
2. Click **Generate** in the **BO Schema** dashboard zone to generate a schema that looks like the physical structure of the maintenance object.
3. Save the physical business object.
4. Navigate to [Maintenance Object](#) and search for the maintenance object.

5. On the **Option** tab, add a new option with the type **Physical Business Object**. The value is the name of the physical business you just created.

Managing To Do Entries

The product provides several base algorithm types that may be used to manage To Do entries through status changes for a given record via BO lifecycle plug-ins.

Create To Do Entry

The product supplies a BO status Enter algorithm type **Generic To Do Creation (F1-TDCREATE)** that creates a To Do entry based on parameter configuration. Refer to the algorithm type description for more information about how it determines the To Do type or To Do role and how to populate the appropriate message text onto the To Do. This algorithm may be used in conjunction with the Retry Logic (below).

If your implementation has a business rule that requires a To Do entry to be created when entering a given BO status and the logic provided by the algorithm type meets the needs of the business rule, this algorithm type may be used. Create an algorithm for the algorithm type, populate the algorithm parameters according to the business rules and plug the new algorithm into the appropriate business object status as an Enter algorithm.

Retry Logic

The algorithm type **Retry for To Dos (F1-TODORETRY)** is supplied for a special use case. It is a BO status monitor plug-in and may be used for a state that is a type of ‘error’ or ‘waiting’ state. It relies on the To Do entry creation logic to set a Retry Frequency. The algorithm transitions to the originating state to retry the logic. The idea is that the condition that caused the record to enter the ‘error’ or ‘waiting’ state may be resolved after some period of time has passed, allowing the record to progress in its lifecycle. Refer to the algorithm type description for more information about its logic.

To use this functionality, create an algorithm for this algorithm type, populate the algorithm parameters according to the business rules and plug the new algorithm into the appropriate business object status as a Monitor algorithm. The state should also have an algorithm for the **Generic To Do Creation** algorithm type plugged in as an Enter algorithm (or something equivalent) that sets the appropriate Retry Frequency.

To Do Completion

It is common that one or more To Do entries associate with a given record should be completed when exiting a state (if it is not already completed). The system supplies the algorithm type **Generic To Do Completion (F1-TODOCOMPL)** that may be used for this purpose. Note that the algorithm type functionality is not tied to any To Do creation logic. It may be used for any use case where To Do entries should be completed on exiting a state. Refer to the algorithm type description for more information about its functionality and how to prevent certain To Do entries from being automatically completed.

To use this functionality, create an algorithm for this algorithm type, populate the algorithm parameters according to the business rules and plug the new algorithm into the appropriate business object status as an Exit algorithm.

Submitting a Batch Job

The product provides a base algorithm type that submits a batch job when entering a BO state. This functionality allows for “event driven” batch submission where the event is the lifecycle transition for a certain record.

The algorithm type is **Create Batch Job Submission Entry for Batch Control (F1-SCHEDJOB)**. The batch control code is a parameter for the algorithm. Refer to the algorithm type description for more information about its logic.

To use this functionality, create an algorithm for this algorithm type, populate the algorithm parameter with the batch control that should be submitted and plug the new algorithm into the appropriate business object status as an Enter algorithm.

Defining Status Reasons

Status Reasons are used to provide more information about why a business object transitioned to a given state. The status reason table provides a centralized place where status reasons can be defined across many different business objects and states.

NOTE: Refer to [Defining Reasons for Entering a State](#) for overview information.

If a business object has one or more states that are configured to capture a status reason, you may configure the valid reasons by navigating to the status reason portal using **Admin > System > Status Reason**.

The topics in this section describe the base-package zones that appear on the Status Reason portal.

Business Objects with Status Reason List

This zone displays the business objects that have one or more status values that allow status reasons to be defined.

Click the broadcast icon to open other zones that contain more information about the business object's status reasons.

Status Reasons

The **Status Reasons** zone contains a list of the existing status reasons for the broadcasted business object.

Data Areas

The data area has no business purpose other than to provide a common schema location for re-used schema structures. It exists solely to help eliminate redundant element declaration. For example, if you have multiple schemas that share a common structure, you can set up a stand-alone data area schema for the common elements and then include it in each of the other schemas.

Be aware that a stand-alone data area can hold elements that are mapped to true fields. For example, you might have 50 different types of field activities and all might share a common set of elements to identify where and when the activity should take place. It would be wise to declare the elements that are common for all in a stand-alone data area and then include it in the 50 field activity business objects.

It's strongly recommended that you take advantage of stand-alone data areas to avoid redundant data definition!

CAUTION: Dynamic inclusion! When the system renders a schema, all schemas included within it are expanded real-time. This means that any change you make to a data area will take effect immediately within all schemas it is referenced within.

NOTE:

Schema Tips. The data area page includes a special Schema Tips zone that provides a link to launch help topics related to the [Advanced Schema Topics](#) help in one click.

Data areas may be included in a business object that does not define a full UI map for display or input. Rather, it is using auto-rendering by defining UI attributes in its schema and via UI hints.

NOTE: View UI Rendering. A context sensitive "View UI Rendering" zone appears on this page. It may be used for a data area that is part of a business object that is using auto-rendering for the display and input maps. The buttons allow you to view the rendered UI for the segment of the schema that is defined by the data area.

Defining Data Areas

The topics in this section describe how to maintain Data Areas.

Data Area - Main

Use this page to define basic information about a data area. Open this page using **Admin > System > Data Area**.

Use the **Data Area Query** portal to search for an existing data area. Once a data area is selected, you are brought to the maintenance portal to view and maintain the selected record.

Description of Page

Enter a unique **Data Area** name and **Description**. Use the **Detailed Description** to describe what this data area defines in detail. **Owner** indicates if the data area is owned by the base package or by your implementation (**Customer Modification**).

CAUTION: Important! If you introduce a new data area, carefully consider its naming convention. Refer to [System Data Naming Convention](#) for more information.

Click the **View Schema** to view the data area's expanded schema definition. Doing this opens the [schema viewer](#) window.

Click the **View XSD** hyperlink to view the business object's expanded schema definition in XSD format.

To extend another data area, reference that data area in the **Extended Data Area** field. By extending a data area you can add additional elements to a base product data area.

Here's an example of an extended data area:

- The product releases with data area A, which contains elements a, b, and c.
- Your implementation creates data area CM-A, which contains element z, and references data area A as the extended data area.
- At run time, everywhere data area A is included it will contain elements a, b, c, and z.

Data Area - Schema

Use this page to maintain a Data Area's schema and to see where the data area is used in the system. Open this page using **Admin > System > Data Area** and then navigate to the **Schema** tab.

Description of Page

The contents of this section describe the zones that are available on this portal.

The **General Information** zone displays the main attributes of the data area.

The [Schema Designer](#) zone allows you to edit the data area's schema. The purpose of the schema is to describe the structure and elements of the data area.

FASTPATH: Refer to [Schema Syntax](#) and [UI Hint syntax](#) for a complete list of the XML nodes and attributes available to you when you construct a schema. Also note that the **Schema Tips** zone in the dashboard provides links to launch these help topics directly.

NOTE: View UI Rendering. A context sensitive "View UI Rendering" zone is associated with this page. The zone is useful for data areas that are to be included in [business objects that define the user interface detail](#) using schema attributes and UI Hints. The buttons allow you to view the automatically rendered display and input maps.

The **Schema Usage Tree** zone summarizes all cross-references to this schema. These may be other schemas, scripts, and web services. For each type of referencing entity, the [tree](#) displays a summary node showing a total count of referencing items. The summary node appears if at least one referencing item exists. Expand the node to list the referencing items and use their description to navigate to their corresponding pages.

Business Services

A business service is used to expose a back-end service so that it may be invoked by a script or a zone or a map to retrieve information or perform functions, depending on the related service.

As with the business object, the business service's interface to the internal service is defined using its schema. The schema maps the business service's elements to the corresponding elements in the internal service program's XML document. Just as a business object can simplify the schema of its maintenance object by only defining elements that it needs and “flattening” entries in a child collection to be defined as a singular element, a business service schema may simplify its service XML in a similar way.

FASTPATH: Refer to [Schema Syntax](#) for a complete list of the XML nodes and attributes available to you when you construct a schema.

[Inbound web services](#) and [scripts](#) support interaction with business services. You can also invoke a business service from a Java class.

Service Program

This transaction defines services available in the system. These include user interface services as well as stand-alone services that perform a specific function. A service may be referenced by a business service. Use this transaction to view existing service and introduce a new stand-alone service to be made available to a Business Service.

Select **Admin > System > Service Program** to maintain service programs.

Description of Page

Service Name is the unique identifier of the service.

CAUTION: Important! When adding new service programs, carefully consider its naming convention. Refer to [System Data Naming Convention](#) for more information.

Owner indicates if this service is owned by the base package or by your implementation (**Customer Modification**). The system sets the owner to **Customer Modification** when you add a service. This information is display-only.

Description describes the service.

Application Service is the application service that is used to provide [security](#) for the service. If the service is related to a maintenance object, the access modes for the application service should be the standard **Add**, **Change**, **Delete** and **Inquire**. For other services, the application service should have the **Execute** access mode.

Service Type indicates whether the service is a **Java Based Service** or a **Java (Converted) Service**. Note that services generated to support a portal in the system will not have a service type populated.

This **Program Component** grid shows the list of program user interface components associated with the service. For a stand-alone service, this list is typically not applicable.

Defining Business Services

The topics in this section describe how to maintain business services.

Note that several context sensitive dashboard zones appear on this page and are visible on all tabs.

- **Schema Tips.** This zone provides several links to launch help topics related to valid schema syntax.
- **Generate Schema.** This zone includes a button that can be used to generate the schema based on the XML of its related Service. Once generated, adjust the schema as desired.

Business Service - Main

Use this page to define basic information about a Business Service. Open this page using **Admin > System > Business Service**

Use the **Business Service Query** portal to search for an existing business service. Once a business service is selected, you are brought to the maintenance portal to view and maintain the selected record.

Description of Page

Enter a unique **Business Service** name and **Description**. Use the **Detailed Description** to describe the purpose of this business service in detail. **Owner** indicates if the business service is owned by the base package or by your implementation (**Customer Modification**).

CAUTION: Important! If you introduce a new business service, carefully consider its naming convention. Refer to [System Data Naming Convention](#) for more information.

Enter the internal **Service Name** being called when this business service is invoked.

Enter the **Application Service** that is used to provide security for the business service. The application service must have an Access Mode of Execute.

Click the **View Schema** to view the business service's expanded schema definition. Doing this opens the [schema viewer](#) window.

Click the **View XSD** hyperlink to view the business object's expanded schema definition in XSD format.

Business Service - Schema

Use this page to maintain a Business Service's schema and to see where the Business Service is used in the system. Open this page using **Admin > System > Business Service** and then navigate to the **Schema** tab.

Description of Page

The contents of this section describe the zones that are available on this portal.

The **General Information** zone displays main attributes of the business service.

The [Schema Designer](#) zone allows you to edit the business service's schema. The purpose of the schema is to map the business service's elements to the corresponding fields of the back-end service program it rides on.

NOTE: Generating a Schema A context sensitive "Generate Schema" zone is associated with this page. The zone provides a button that allows the user to generate a basic schema that includes all the elements that are found in the XML of the BS's service.

FASTPATH: Refer to [Schema Syntax](#) for a complete list of the XML nodes and attributes available to you when you construct a schema. Also note that the **Schema Tips** zone in the dashboard provides a link to launch this help topic directly.

The **Schema Usage Tree** zone summarizes all cross-references to this schema. These may be other schemas, scripts, and web services. For each type of referencing entity, the [tree](#) displays a summary node showing a total count of referencing items. The summary node appears if at least one referencing item exists. Expand the node to list the referencing items and use their description to navigate to their corresponding pages.

Useful Services and Business Services

The following section highlights some business services and services provided by the product that may be useful for implementations to use.

Data Explorer Service

The system provides a mechanism for performing an SQL select statement for use in scripting, Java plug-ins, or via a web service call. This is done by creating a zone using one of the data explorer zone types where the SQL is defined. Then, create a business service using the Data Explorer service (**FWLZDEXP**).

NOTE: There are numerous business services delivered with the base product that reference this service that may be used as a template.

The following points highlight how to create your own business service for this service. Note that typically a separate business service exists for each zone.

- Enter a **Business Service** code and a **Description**. It is recommended to define the business service code to match the zone code so that it's easier to manage which business service invokes which zone.
- Select the **Service Name**FWLZDEXP.
- On the **Schema** tab, under the *<schema>* node, enter mapping for the fields that are required for the Data Explorer service:
 - The **Zone** should be mapped into service field **ZONE_CD** . Define the zone code as the default value.
 - For every **user filter** defined on the zone, create a schema mapping into the service field **Fx_VALUE**, where "x" is the filter number (from the zone parameters).
 - For every **hidden filter** defined on the zone, create a mapping into the service field **Hx_VALUE**, where "x" is the filter number (from the zone parameters).
 - The search results are returned as a list by the data explorer service. Each column value is in the service field **COL_VALUE** with an appropriate sequence number (**SEQNO**). The results can be **flattened** based on sequence number allowing for a logical element name to be defined.
 - Another useful field is **ROW_CNT**, which provides the number of rows retrieved by your search.

The following is an example of the schema for a BS that receives a business object code and returns a list of status values and their descriptions that allow status reasons to be defined.

```
<schema>
  <zone mapField="ZONE_CD" default="F1-BOSTSLST" />
  <bo mapField="H1_VALUE" />>
  <rowCount mapField="ROW_CNT" />>
  <results type="list" mapList="DE">>
    <status dataType="string" mapField="COL_VALUE">
      <row mapList="DE_VAL">>
        <SEQNO is="1" />>
      </row>>
    </status>>
    <description dataType="string" mapField="COL_VALUE">
      <row mapList="DE_VAL">>
        <SEQNO is="2" />>
      </row>>
    </description>>
  </results>>
</schema>
```

Maintenance Object Log Service

Many maintenance objects support a log table that follows a pattern of column names and behavior. The system provides a service called Generic MO Log Service (**F1MOLOGP**) that may be used to perform common functions related to log entries:

- Read log entries. If you pass a certain MO, primary key and log sequence number, the service will return the details of that log entry. The product provides a generic business service that may be used for this purpose — Generic MO - Retrieve Log Details (**F1-ReadMOLog**). Alternatively, it is possible to create a business service for a given MO where the MO code is assigned to the MO element using the default syntax. This allows business functionality specific to that maintenance object to use the specific BS.
- Add log. The service may be used to add a log entry. If a user log is added, then the comments from the user are populated in the detailed description. System generated log entries typically supply a message category / message number along with other information such as the status, a specific log type and optionally a related object reference (via a characteristic). The product provides a generic business service that may be used for this purpose — Add Generic MO Log (**F1-AddMOLog**). Alternatively, it is possible to create a business service for a given MO where the MO code is assigned to the MO element using the default syntax. This allows business functionality specific to that maintenance object to use the specific BS.

Base Business Services

The following table highlights some business services provided by the product that may be useful for custom logic for an implementation.

CAUTION: This is not intended to be a complete reference of Business Services. Refer to the business service page to find all the supported business services.

Business Object Related Services

Business Service Name	Description
F1-AutoTransitionBO	Performs monitoring algorithms associated with the current state of a given business object instance (which may result in subsequent state transitioning).
F1-CompareBusinessObjectData	Compares two versions of a given business object instance.
F1-DetermineBo	Determines the business object of a given instance of a maintenance object by executing the MO's Determine BO logic.
F1-GetRequiredFieldsForBOState	Returns the required fields for a given business object status.
F1-RetrieveBOOption	Returns BO option values for a given BO and option type.
F1-RetrieveBOStatusOption	Returns BO option values for a given BO, status and option type.
F1-RetrieveBOStatusOption	Retrieves a list of BOs for a given MO that are accessible for the current user.
F1-RetrieveBoStatusDescription	Return the description of a given BO status.
F1-RetrieveBusinessObjectLabel	Return the label appropriate for a given path (e.g. element) within a BO schema.
F1-RetrieveNextStates	Return a list of next possible states based on the input of a MO and its prime key, or a BO and one of its statuses.

Email Related Services

Business Service Name	Description
F1-EmailService	Sends an email message in real time.
F1-RetrieveEmailAddress	Retrieves the email addresses of users belonging to a To Do Role.
F1-RetrieveEnvironmentURL	Retrieves the current environment URL information for the installation.

Tools for Maps and Scripting

Business Service Name	Description
F1-AddWarning	This business service may be used to log a warning by providing the message details. The system gathers all the warning and displays them to the user all at once.
F1-CheckOnlineConnection	Check if Connection is Online or Batch.
F1-CheckWarning	Used to check if any warnings have been accumulated. If warnings have been accumulated, any logic that cannot be rolled back (when the warnings are shown) should not be performed.
F1-DateMath	Performs various date and time math calculations. Refer to the BS description for more details.
F1-DateTimeFormattingService	Formats a given date / time based on the user's display profile settings.
F1-ExecuteScriptInNewSession	Executes a Service Script in a new processing session/transaction.
F1-GetFieldLabel	Retrieves the label for a given field.
F1-GetForeignKeyReference	Returns foreign key reference information for a given FK Reference and primary key, including info description, navigation option, and context menu.
F1-GetFKReferenceDetails	Returns foreign key reference information for a given MO and primary key, including FK reference code, info description, navigation option, search zone and context menu.
F1-GetLookupDescription	Returns lookup description for a lookup field value given the lookup field name.
F1-GetExtLookUpVal	Returns the list of values for a given extendable lookup BO.
F1-GetMonthInYearAbbreviation	Returns a 3-character month abbreviation for an input date in system format.
F1-NumberAmountFormatter	Formats a given amount or number based on the user's display profile settings. It also may receive input to adjust the scale and optionally apply currency settings.
F1-OutmsgDispatcher	Dispatches a real-time message giving the user the option of whether to persist the message on the database, and whether to trap errors that may take place during the call. Refer to Real Time Messages for more information.
F1-OutmsgMediator	Alternative to F1-OutmsgDispatcher and may be a better option if the sender does not require an outbound message record to be instantiated. Refer to Real Time Messages for more information.

Business Service Name	Description
F1-RethrowError	Issues an application error using the input message category / number / parameters.
F1-RetrieveMODescription	Retrieves the description for a maintenance object.
F1-ReturnMessage	Returns the expanded message given a message category, number, parameters, and parameter types.
F1-SavePointDispatcher	Allows for a service script to be executed where exceptions are trapped and the transaction is rolled back to a save point set before the service script execution.

User Related Services

Business Service Name	Comments
F1-CheckApplicationSecurity	Checks a user's security for a given application service / access mode
F1-CheckUserAuthorization	Determine whether a given user is authorized for access based on the input application service, security code, and authorization level.
F1-DeterminelfUserCanApproveTD	Determine if the current user can approve a given To Do.

User Interface (UI) Maps

The User Interface (UI) map holds HTML to be rendered within [portal zones](#) and [Business Process Assistant \(BPA\) scripts](#). UI maps allow your implementation to create input forms and output maps that closely match your customer's business practices. In other words, the UI Map is designed to facilitate the capture and display of your [business objects](#) and [business services](#).

The UI map is a repository for a single HTML document paired with an XML schema where the schema defines the data that the HTML document displays and/or modifies. The UI Map HTML gives you the ability to craft the display by any method that an html document can support, including JavaScript and full CSS functionality.

Configuration tool support for UI Maps hinges around the ability to inject and extract an XML document from the HTML. For more information on the specialized support for HTML and JavaScript functionality refer to [UI Map Attributes and Functions](#).

```

<html>
<head>
<title>Output Personal Information</title>
<link rel="stylesheet" type="text/css" href="cm_templates/cmStyles.css"/>
</head>
<body>

<table width="100%" border="0" cellpadding="2" style="margin-top:15px;" >

  <tr>
    <td/>
    <td/> <!-- locate the edit button on the bottom of the third column -->
    <td rowspan="99" style="vertical-align:bottom; margin-left:5px">
      <input type="button" value="edit" onClick="oraRunScript('HumanInfoU','personId');"/>
    </td>
  </tr>

  <tr>
    <td class="outputLabel">Name:</td>
    <td><span oraField="name" class="outputData"></span></td>
  </tr>
  <tr>
    <td class="outputLabel">Home Phone:</td>
    <td><span oraField="homePhone" class="outputData"></span></td>
  </tr>
  <tr>
    <td class="outputLabel">Business Phone:</td>
    <td><span oraField="businessPhone" class="outputData"></span></td>
  </tr>
  <tr>
    <td class="outputLabel">Cell Phone:</td>
    <td><span oraField="cellPhone" class="outputData"></span></td>
  </tr>
  <tr>
    <td class="outputLabel">FAX:</td>
    <td><span oraField="fax" class="outputData"></span></td>
  </tr>
  <tr>
    <td class="outputLabel">Social Security:</td>
    <td><span oraField="socialSecurity" class="outputData"></span></td>
  </tr>
  <tr>
    <td class="outputLabel">Drivers License:</td>
    <td><span oraField="driversLicense" class="outputData"></span></td>
  </tr>
  <tr>
    <td class="outputLabel">Email:</td>
    <td><span oraField="email" class="outputData"></span></td>
  </tr>

</table>

</body>

<xml>
<root>
  <name>Greer, Johan</name>
  <email>jurgen.greer@media.com</email>
  <socialSecurity>939-30-3939</socialSecurity>
  <driversLicense>C8392020</driversLicense>
  <homePhone>(838) 030-0303</homePhone>
  <cellPhone>(444) 444-4040</cellPhone>
  <businessPhone>(737) 393-3838</businessPhone>
  <fax>(373) 939-3939</fax>
  <personId>1239997654</personId>
</root>
</xml>
</html>

```

Figure 1: HTML to Display Customer Business Object

Name:	Greer, Johan
Home Phone:	(838) 030-0303
Business Phone:	(737) 393-3838
Cell Phone:	(444) 444-4040
FAX:	(373) 939-3939
Social Security:	939-30-3939
Drivers License:	C8392020
Email:	jurgen.greer@media.com
	<input type="button" value="edit"/>

Figure 2: Customer HTML Rendered (Output Data for Zone)

UI maps are typically crafted as output tables when used in conjunction with portal zones - please refer to [Map Zones](#) for more information. When referenced within [BPA scripts](#), UI maps are typically crafted as forms for the capture and update of data.

Edit Personal Information

[err](#)

Name: Greer, Johan
Last-name suffix, prefix first-name middle-name/initial

Home Phone: 838 - 030 - 0303

Business Phone: 737 - 393 - 3838

Cell Phone: 444 - 444 - 4040

FAX: 373 - 939 - 3939

Social Security: 939 - 30 - 3939

Drivers License: C8392020

Email: jürgen.greer@media.com

Figure 3: HTML Input Form Rendered (for BPA Script)

Portal zones can reference a UI map for the zone header. They may also utilize a UI map to define their filter area. This type of UI map is not a complete HTML document, but is instead configured as a UI Map "fragment".

NOTE: UI Map Tips. A context sensitive "UI Map Tips" zone is visible on the UI map maintenance page. This zone provides several links to launch help topics related to valid schema syntax and UI Hint syntax in one click.

NOTE: Editing HTML. You can use a variety of HTML editors to compose your HTML, which you can then cut, and paste into your UI map. In addition, the zone provides a complete list of the XML schema nodes and attributes available to you when you construct the map's data schema.

Defining UI Maps

The topics in this section describe how to maintain UI Maps.

UI Map - Main

Use this page to define basic information about a user interface (UI) Map. Open this page using **Admin > System > UI Map**

Use the **UI Map Query** portal to search for an existing UI Map. Once a map is selected, you are brought to the maintenance portal to view and maintain the selected record.

Description of Page

Enter a unique **Map** name. **Owner** indicates if the UI map is owned by the base package or by your implementation (**Customer Modification**).

CAUTION: Important! If you introduce a new UI map, carefully consider its naming convention. Refer to [System Data Naming Convention](#) for more information.

Use **UI Map Type** to indicate whether the map is a **Complete XHTML Document**, **Complete HTML Document**, **XHTML Fragment** or an **HTML Fragment**. The default value is **Complete XHTML Document**.

Enter a **Description**. Use the **Detailed Description** to describe how this map is used in detail.

Click on the **View Schema** to view the UI map's expanded schema definition. Doing this opens the [schema viewer](#) window.

Use the **Test UI Map** hyperlink to render your HTML in a test window.

NOTE: The **Test UI Map** hyperlink also exercises the proprietary functionality that binds an XML element with an HTML element so you can get immediate feedback on your HTML syntax.

UI Map - Schema

Use this page to maintain a UI Map's HTML and schema and to see where the UI Map is used in the system. Open this page using **Admin > System > UI Map** and then navigate to the **Schema** tab.

Description of Page

The contents of this section describe the zones that are available on this portal.

The **General Information** zone displays main attributes of the UI Map.

The **HTML Editor** zone allows you to edit the HTML document of the map.

NOTE: Refer to [UI Map Attributes and Functions](#) and [UI Map Standards](#) for more information about HTML definition syntax. These topics describe good ways to produce simple HTML, however, they are not an HTML reference. Note that you can use a variety of HTML editors to compose your HTML, which you can then cut and paste into your UI map.

NOTE: Providing Help. A [tool tip](#) can be used to display additional help information to the user. This applies to section elements as well as individual elements on a map. Refer to [UI Map Attributes and Functions](#) for more information on how to enable and provide UI map help.

The [Schema Designer](#) zone allows you to edit the data schema part of the map. The purpose of the schema is to describe the data elements being displayed by the map.

FASTPATH: Refer to [Schema Syntax](#) for a complete list of the XML nodes and attributes available to you when you construct a schema. Also note that the **UI Map Tips** zone in the dashboard provides a link to launch this help topic directly.

The **Schema Usage Tree** zone summarizes all cross-references to this schema. These may be other schemas, scripts, and web services. For each type of referencing entity, the [tree](#) displays a summary node showing a total count of referencing items. The summary node appears if at least one referencing item exists. Expand the node to list the referencing items and use their description to navigate to their corresponding pages.

UI Map Attributes and Functions

NOTE: This topic uses the term "field" to refer to both the generic concept of displaying and capturing data in a 'field' as well as referring to the meta-data object supplied in the product to define [Fields](#). When referring to the latter, the term "MD Field" (meta-data Field) is used and a hyperlink to the Field documentation is provided.

Contents

- [Bind XML to HTML](#)
- [Build a Dropdown List](#)
- [Format Input and Output Fields](#)
- [Display Labels](#)
- [Enable UI Map Help](#)
- [Search Using a Pop-Up Explorer Zone](#)
- [Display Errors](#)
- [Fire JavaScript for Browser Events](#)
- [Hide Elements](#)
- [Invoke Schema Based Services](#)
- [Refresh a Rendered Map or Portal Page](#)
- [Embed Framework Navigation](#)
- [Launch BPA Script](#)
- [Exit UI Map with Bound Values](#)
- [Include a Map Fragment](#)
- [Include a Web Component](#)
- [Show Schema Default on Add](#)
- [Configure a Chart](#)
- [Upload and Download a CSV File](#)
- [Construct Portal Zone Map Fragments](#)
- [Required JavaScript Libraries](#)
- [Detecting Unsaved Changes](#)
- [Hiding Portal Tabs](#)

Bind XML to HTML

Only two different attributes are required to bind a UI Map's XML to its HTML. Both of these attributes require an XML document embedded within the HTML, where the XML is bounded by <xml> nodes.

WARNING: You must embed a pair of <xml></xml> tags within your HTML document for binding to occur.

Linking a Field

Syntax	Values	Description
oraField=" "	Field element XPath	This attribute is used to link an HTML element directly with an XML element, where the XML element is defined within the UI Map's XML schema. The attribute can be used with any <i>rendering</i> HTML element, such as: , <div>, and <input>.

- HTML for input element:

```
<html>
<body>
<table>
  <tr>
    <td>Address:</td>
    <td><input type="text" oraField="address"/></td>
  </tr>
  <tr>
    <td>City:</td>
    <td><input type="text" oraField="city"/></td>
  </tr>
  <tr>
    <td>State:</td>
```

```

        <td><input type="text" oraField="state"/></td>
      </tr>
      <tr>
        <td>Zip:</td>
        <td><input type="text" oraField="zip"/></td>
      </tr>
    </table>
  </body>
</xml>
<root>
  <address>123 Main St</address>
  <city>Alameda</city>
  <state>CA</state>
  <zip>94770</zip>
</root>
</xml>
</html>

```

Rendered HTML

Address:

City:

State:

Zip:

- HTML for span and div elements:

```

<html>
<body>

<div oraField="address"></div>
<span oraField="city"></span>
<span>,</span>
<span oraField="state"></span>
<span oraField="zip"></span>
<span oraField="country"></span>

</body>
<xml>
  <root>
    <address>123 Main St</address>
    <city>Alameda</city>
    <state>CA</state>
    <zip>94770</zip>
  </root>
</xml>
</html>

```

HTML rendered:

123 Main St
Alameda, CA 94770

Linking a List

This attribute is used to link an HTML table with an XML list, where the XML list is defined within the UI Map's XML schema. The purpose of the element is to trigger the framework to replicate the table's HTML for each occurrence of the list.

Syntax	Values	Description
oraList=" "	List element XPath	This attribute is used to link an HTML table with an XML list, where the XML list is defined within the UI Map's XML schema. The purpose of the element is to trigger the

Syntax	Values	Description
		framework to replicate the table's HTML for each occurrence of the list.

NOTE: The oraField attributes embedded within the list must contain XPath navigation relative to the list. See below for an example.

```

<html>
<head><title>Bind xml list element</title></head>
<body>
<table oraList="payment">
  <thead>
    <tr>
      <th><span>Pay Date</span></th>
      <th><span>Amount</span></th>
    </tr>
  </thead>
  <tr>
    <td>
      <span oraField="date" oraType="date"></span>
    </td>
    <td align="right">
      <span oraField="amount" oraType="money"></span>
    </td>
  </tr>
</table>
</body>
<xml>
<root>
  <payment>
    <date>2008-01-01</date>
    <amount>44.28</amount>
  </payment>
  <payment>
    <date>2008-02-01</date>
    <amount>32.87</amount>
  </payment>
  <payment>
    <date>2008-03-01</date>
    <amount>21.76</amount>
  </payment>
</root>
</xml>
</html>

```

HTML rendered:

```

Pay Date Amount
01-01-2008 $44.28
02-01-2008 $32.87
03-01-2008 $21.76

```

Build a Dropdown List

The following attributes are provided to build an HTML 'select' element, also called a dropdown, based on various sources.

Source	Syntax	Values	Examples
Lookup	oraSelect="lookup: ;"	Lookup field	<pre> ... <td>House Type:</td> <td> <select oraField="houseType" oraSelect="lookup:HOUSE_TYPE;"> </select> </pre>

Source	Syntax	Values	Examples
			</td>
Extendable Lookup	oraSelect="lookupBO: ;"	BO code	<pre> ... <td>UI Device Display Type:</ td> <td> <select oraField="uiDeviceType" oraSelect="lookupBO: Fl- DeviceDisplayTypes;"></ select> </td> </pre>
Characteristic Type (pre-defined)	oraSelect="charType: ;"	Characteristic Type code	<pre> ... <td>Usage:</td> <td> <select oraField="statusReasonUsage" oraSelect="charType:Fl- SRUSG;"></select> </td> ... </pre>
Control Table	<p>oraSelect="table: ;"</p> <p>NOTE: This attribute only works with tables that follow the standard control table structure where there is a related language table that includes that includes the column DESCR as its description column. Use the Application Viewer data dictionary to identify tables that qualify for this functionality.</p> <p>WARNING: The oraSelect function will only work if less than 500 values are displayed.</p>	Table name	<pre> ... <td>Currency: </td> <td> <select oraField="currency" oraSelect="table:CI_CURRENCY_CD;" </select> </td> ... </pre>
Page Service	oraSelect="service: ;"	Page Service name	<pre> ... <td>Country:</td> <td> <select oraField="country" oraSelect="service:CIPTCNTW;" </select> </td> ... </pre>
Embedded List	<p>Used to build a select dropdown based on a list within the map's XML.</p> <p>oraSelect="valuePath: ;descPath: ;"</p>	<p>After the valuePath, indicate the XPath of the element that holds the values. After the descPath, indicate the XPath of the element that holds the descriptions.</p>	<pre> <html> <body> <table summary="" border="0" cellpadding="1" cellspacing="1"> <tr> <td>Select: </td> <td><select oraSelect= "valuePath:list/value; descPath:list/desc" oraField="target"></ select></td> </tr> </table> </body> <xml> <root> <target>10</target> <list> <value>10</value> <desc>Ten</desc> </list> </root> </xml> </pre>

Source	Syntax	Values	Examples
			<pre> </list> <list> <value>20</value> <desc>Twenty</ desc> </list> <list> <value>40</value> <desc>Forty</desc> </list> </root> </xml> </html> </pre>
Service Script	oraSelect="ss: ;"	Service Script code	See below for additional syntax needed when using this function.
Business Service	oraSelect="bs: ;"	Business Service code	See below for additional syntax needed when using this function.

When specifying a service script or a business service, extra mapping information is needed to pass data to and from the service.

Syntax	Values	Description
oraSelectIn=" ;"	serviceXPath:element;	Used to pass the value of another element into the service (mapping to the service's XPath).
	serviceXPath:'Literal';	Used to pass a constant or literal to the service (mapping to the service's XPath).
oraSelectOut="valuePath: ; descPath: "	See examples below	Used to indicate which element in the service's output holds the values and which one holds the descriptions.

Example using a business service:

```

...
<td>External System: </td>
<td>
  <select oraField="externalSystem"
    oraSelect="bs:F1-RetrieveExternalSystems"
    oraSelectIn="outboundMsgType:boGroup/parameters/outboundMsgType;"
    oraSelectOut="valuePath:results/externalSystem;
    descPath:results/description">
  </select>
</td>
...

```

This method for building dropdowns is often used when there is a dependency between elements and the list of valid values in a dropdown (for the child element) is based on another element in the map (the parent element). When the parent element is changed, it may be required to refresh the child element. This behavior can be implemented using the function called within an **onChange** event in the map. The syntax is **oraHandleDependentElements('dependent element');**. Multiple target elements (dependents) can be named.

The following example is related to the above business service example where the list of external systems is specific for a given outbound message type, which is passed in as input. The snippet below shows the configuration for the outbound message type element to trigger a refresh of the external system's dropdown list.

```

...
<div>
  <label oraLabel="boGroup/parameters/outboundMsgType"></label>
  <span>
    <select oraSelect="table:F1_OUTMSG_TYPE"
      oraField="boGroup/parameters/outboundMsgType"

```

```

        onChange="oraHandleDependentElements('boGroup/parameters/externalSystem');" >
        </select>
    </span>
</div>
...

```

Format Input and Output Fields

The following attributes are designed to apply data type formatting for input and output fields.

Automatic Formatting

Syntax

oraSchemaDataTypes="false"

This attribute is used to trigger automatic formatting in the rendered HTML document. The automated formatting will occur according to the data type attributes defined in the UI map's schema. For details on specific data type formatting, please refer to the oraType attribute descriptions below.

WARNING: The attribute **oraSchemaDataTypes="true"** will be automatically injected into the UI map's HTML! If you do not wish to apply the schema's data types to the rendered HTML then you must specify this attribute in the body node with a value of false. The attribute **<body oraSchemaDataTypes="false">** is required to avoid automatic formatting!

- UI Map schema:

```

<schema>
  <schemaDate dataType="date" />
  <schemaDateTime dataType="dateTime" />
  <schemaFKRef fkRef="CI_USER" />
  <schemaLookup dataType="lookup" lookup="ACCESS_MODE" />
  <schemaMoney dataType="money" />
  <schemaNumber dataType="number" />
  <schemaTime dataType="time" />
</schema>

```

- UI Map HTML:

```

<html>
<body oraSchemaDataTypes="true">
<table border="1" cellpadding="1" cellspacing="1">
  <tr><th>dataType</th><th>result type</th><th>input result</th><th> display-only result</th></tr>
  <tr>
    <td rowspan="2">date (from schema)</td>
    <td>raw</td>
    <td><input oraField="schemaDate" oraType="string" /></td>
    <td><span oraField="schemaDate" oraType="string"></span></td>
  </tr>
  <tr>
    <td>rendered</td>
    <td><input oraField="schemaDate"></td>
    <td><span oraField="schemaDate"></span></td>
  </tr>
  <tr>
    <td rowspan="2">dateTime (from schema)</td>
    <td>raw</td>
    <td><input oraField="schemaDateTime" oraType="string"></td>
    <td><span oraField="schemaDateTime" oraType="string"></span></td>
  </tr>
  <tr>
    <td>rendered</td>
    <td><input oraField="schemaDateTime"></td>

```

```

    <td><span oraField="schemaDateTime"></span></td>
</tr>

<tr>
  <td rowspan="2">fkRef (from schema)**</td>
  <td>raw</td>
  <td><input oraField="schemaFkRef" oraType="string"></td>
  <td><span oraField="schemaFkRef" oraType="string"></span></td>
</tr>
<tr>
  <td>rendered</td>
  <td><input oraField="schemaFkRef"></td>
  <td><span oraField="schemaFkRef"></span></td>
</tr>

<tr>
  <td rowspan="2">lookup (from schema)</td>
  <td>raw</td>
  <td><input oraField="schemaLookup" oraType="string"></td>
  <td><span oraField="schemaLookup" oraType="string"></span></td>
</tr>
<tr>
  <td>rendered</td>
  <td><input oraField="schemaLookup"></td>
  <td><span oraField="schemaLookup"></span></td>
</tr>

<tr>
  <td rowspan="2">money (from schema)</td>
  <td>raw</td>
  <td><input oraField="schemaMoney" oraType="string"></td>
  <td><span oraField="schemaMoney" oraType="string"></span></td>
</tr>
<tr>
  <td>rendered</td>
  <td><input oraField="schemaMoney"></td>
  <td><span oraField="schemaMoney"></span></td>
</tr>

<tr>
  <td rowspan="2">number (from schema)</td>
  <td>raw</td>
  <td><input oraField="schemaNumber" oraType="string"/></td>
  <td><span oraField="schemaNumber" oraType="string"></span></td>
</tr>
<tr>
  <td>rendered</td>
  <td><input oraField="schemaNumber"></td>
  <td><span oraField="schemaNumber"></span></td>
</tr>

<tr>
  <td rowspan="2">time (from schema)</td>
  <td>raw</td>
  <td><input oraField="schemaTime" oraType="string"></span></td>
  <td><span oraField="schemaTime" oraType="string"></span></td>
</tr>
<tr>
  <td>rendered</td>
  <td><input oraField="schemaTime"></td>
  <td><span oraField="schemaTime"></span></td>
</tr>
</table>

</body>
<xml>
<root>
  <schemaDate>2007-11-02</schemaDate>
  <schemaDateTime>2007-11-02-23.45.00</schemaDateTime>
  <schemaFkRef>USD</schemaFkRef>
  <schemaLookup>A</schemaLookup>

```

```

<schemaMoney>1000000</schemaMoney>
<schemaNumber>5661976.11548</schemaNumber>
<schemaTime>23.45.00</schemaTime>
</root>
</xml>
</html>

```

HTML rendered.

dataType	result type	input result		display-only result
date	raw	<input type="text" value="2007-11-02"/>		2007-11-02
	rendered	<input type="text" value="11-02-2007"/>		11-02-2007
dateTime	raw	<input type="text" value="2007-11-02-23.45.00"/>		2007-11-02-23.45.00
	rendered	<input type="text" value="11-02-2007"/>	<input type="text" value="11:45PM"/>	11-02-2007 11:45PM
fkRef	raw	<input type="text" value="SYSUSER"/>		SYSUSER
	rendered	<input type="text" value="SYSUSER"/>		SYSUSER
lookup	raw	<input type="text" value="A"/>		A
	rendered	<input type="text" value="Add"/>		Add
money	raw	<input type="text" value="1000000"/>		1000000
	rendered	<input type="text" value="\$1,000,000.00"/>		\$1,000,000.00
number	raw	<input type="text" value="5661976.11548"/>		5661976.11548
	rendered	<input type="text" value="5,661,976.11548"/>		5,661,976.11548
time	raw	<input type="text" value="23.45.00"/>		23.45.00
	rendered	<input type="text" value="11:45PM"/>		11:45PM

Date Formatting

This function is used to display a date according to the user's display profile. For input fields, the setting formats the data when the user tabs out of the field.

Syntax

oraType="date"

```

<html>
<body>
<table summary="" border="0" cellpadding="1" cellspacing="1">
  <tr>
    <td>Date: </td>
    <td><span oraField="date" oraType="date"></span></td>
  </tr>
  <tr>
    <td>Date: </td>
    <td><input oraField="date" oraType="date" /></td>
  </tr>
</table>
</body>
<xml>
<root>
  <date>2008-12-28</date>
</root>
</xml>
</html>

```

HTML rendered.

Date: 12-28-2008

Date:

Time Formatting

This function is used to display a time according to the user's display profile. For input fields, the setting formats the data when the user tabs out of the field.

Syntax

oraType="time"

```
<html>
<body>
<table summary="" border="0" cellpadding="1" cellspacing="1">
  <tr>
    <td>Time: </td>
    <td><span oraField="time" oraType="time"></span></td>
  </tr>
  <tr>
    <td>Time: </td>
    <td><input oraField="time" oraType="time" /></td>
  </tr>
</table>
</body>
<xml>
<root>
  <time>00.28.54.389</time>
</root>
</xml>
</html>
```

HTML rendered.

Time: 12:28AM

Time:

Date and Time Formatting

This function is used to display a timestamp according to the user's display profile. If this function is used for an input element, it is broken into two pieces, one for [date](#) and one for [time](#). Optionally, the time portion of the date time element can be suppressed using the attribute value 'time:suppress'.

Syntax

oraType="dateTime; time:suppress"

```
<html>
<body>
<table summary="" border="0" cellpadding="1" cellspacing="1">
  <tr>
    <td>Date time: </td>
    <td><span oraField="dateTime" oraType="dateTime"></span></td>
  </tr>
  <tr>
    <td>Date only: </td>
    <td><span oraField="dateTime" oraType="dateTime; time:suppress"></span></td>
  </tr>
  <tr>
    <td>Date time: </td>
    <td><input oraField="dateTime" oraType="dateTime" /></td>
  </tr>
</table>
```

```

<tr>
  <td>Date only: </td>
  <td><input oraField="dateTime" oraType="dateTime; time:suppress"/></td>
</tr>
</table>
</body>
</xml>
<root>
  <dateTime>2009-11-01-00.28.54</dateTime>
</root>
</xml>
</html>

```

HTML rendered.

Date time: 11-01-2009 12:28AM

Date only: 11-01-2009

Date time:

Date only:

Date / Time Formatting with Standard Time

This true function is used to render a date / time element according to the daylight savings time schedule of the 'base' time zone. The 'base' time zone is specified on the Installation table and represents the database time zone. For input elements with this setting, all time entered is assumed to correspond with the daylight savings time schedule of the base time zone. If a time is entered that cannot be unambiguously translated to standard time, then the user will be required to provide a time zone label to indicate whether daylight savings time, or standard time, has been entered.

Syntax

oraType="dateTime; stdTime:true;"

```

<html>
<body>
<table summary="" border="0" cellpadding="1" cellspacing="1">
  <tr>
    <td>Date time: </td>
    <td><span oraField="dateTime" oraType="dateTime; stdTime:true;"></span></td>
  </tr>
  <tr>
    <td>Date time: </td>
    <td><input oraField="dateTime" oraType="dateTime; stdTime:true;" /></td>
  </tr>
</table>
</body>
</xml>
<root>
  <dateTime>2009-11-01-00.28.54</dateTime>
</root>
</xml>
</html>

```

HTML rendered.

NOTE: The time zone label is displayed because 1:28 is ambiguous otherwise. Legally, November 1, 2009 1:28 AM occurs twice because daylight savings time (DST) is removed at 2:00 AM. With the stdTime function time zone labels are only displayed when required to clarify time overlaps.

Date time: 11-01-2009 01:28AM PDT

Date time:

HTML rendered for the following day.

Date time: 11-02-2009 12:28AM

Date time:

Date and Time Formatting with Time Zone Reference

Syntax	Valid Values	Description
<code>oraType="dateTime; stdTimeRef: ;"</code>	Reference an XPath after the colon.	This function is used to render a date / time element according to the daylight savings time schedule of a time zone whose XPath is referenced. Note that the time processed is assumed to have been stored in the standard time of the referenced time zone - so only daylight savings time shifting will execute - not time zone shifting.
<code>oraType="dateTime; displayRef: ;"</code>	Reference an XPath after the colon.	This function is similar to the <code>stdTimeRef</code> function, except that this function will execute time zone shifting in addition to daylight savings time shifting. To use <code>displayRef</code> correctly, only associate it with time zone elements that have been stored in the base time zone.

For input elements, all time entered is assumed to correspond with the daylight savings time schedule of the referenced time zone. If a time is entered that cannot be unambiguously translated to standard time, then the user will be required to provide a time zone label to indicate whether daylight savings time, or standard time, has been entered.

```
<html>
<body>
<table summary="" border="0" cellpadding="1" cellspacing="1">
  <tr>
    <td>Date time: </td>
    <td><span oraField="dateTime" oraType="dateTime; stdTimeRef:timeZone;"></span></td>
  </tr>
  <tr>
    <td>Date time: </td>
    <td><input oraField="dateTime" oraType="dateTime; stdTimeRef:timeZone;" /></td>
  </tr>
</table>
</body>
<xml>
<root>
  <timeZone>US-EAST</timeZone>
  <dateTime>2009-11-01-00.28.54</dateTime>
</root>
</xml>
</html>
```

HTML rendered.

NOTE: The time zone label is always displayed for a referenced time zone.

Date time: 11-01-2009 01:28AM EDT

Date time:

HTML rendered for the following day.

Date time: 11-02-2009 12:28AM EST

Date time:

Duration Formatting

Syntax

oraType="duration"

This function is used to display time duration. For an input element, the value entered by the user is translated from minutes to hour and minutes as appropriate. For example, an entered value of '90', is converted to '00:01:30' when tabbing out of the input field.

```
<html>
<body>
<table summary="" border="0" cellpadding="1" cellspacing="1">
  <tr>
    <td>Duration: </td>
    <td><span oraField="duration" oraType="duration"></span></td>
  </tr>
  <tr>
    <td>Duration: </td>
    <td><input oraField="duration" oraType="duration" /></td>
  </tr>
</table>
</body>
<xml>
<root>
  <duration>90</duration>
</root>
</xml>
</html>
```

HTML rendered.

Duration: 00:01:30

Duration:

Day in Month Formatting

Syntax

oraType="dayInMonth"

This function is used to display a concatenated day and month.

```
<html>
<body>
<table summary="" border="0" cellpadding="1" cellspacing="1">
  <tr>
    <td>Day In Month: </td>
    <td><span oraField="dayMonth" oraType="dayInMonth"></span></td>
  </tr>
  <tr>
    <td>Day In Month: </td>
    <td><input oraField="dayMonth" oraType="dayInMonth" /></td>
  </tr>
</table>
</body>
<xml>
<root>
  <dayMonth>0228</dayMonth>
</root>
</xml>
</html>
```

HTML rendered.

Day In Month: 02-28

Day In Month:

Month In Year Formatting

Syntax

oraType="monthInYear"

This function is used to display a concatenated month and year.

```
<html>
<body>
<table summary="" border="0" cellpadding="1" cellspacing="1">
  <tr>
    <td>Month In Year: </td>
    <td><span oraField="month" oraType="monthInYear"></span></td>
  </tr>
  <tr>
    <td>Month In Year: </td>
    <td><input oraField="month" oraType="monthInYear" /></td>
  </tr>
</table>
</body>
<xml>
<root>
  <month>200811</month>
</root>
</xml>
</html>
```

HTML rendered.

Month In Year: 11-2008

Month In Year:

Monetary Formatting

This function is used to display a number as a monetary amount. See the table for configuration options with respect to the currency. For input elements, an error is issued if a non-numeric value is entered.

Syntax	Description
oraType="money: "	Directly specify a currency code after the colon.
oraType="money;currencyRef: "	Reference an XPath (after the colon) for an element that references a currency code.
oraType="money"	If no currency or currency reference is specified, the installation currency is used.

NOTE: You must specify a pair of stylesheet references, `cisEnabled` and `cisDisabled`, in the map's header for right alignment. The stylesheet controls how the field will be rendered. If you want to alter the rendering you must override the `oraMoney` style.

```
<html>
<head>
  <link rel="stylesheet" type="text/css" href="cisDisabled.css" />
  <link rel="stylesheet" type="text/css" href="cisEnabled.css" />
</head>
<body>
<table summary="" border="1" cellpadding="1" cellspacing="1">
```

```

<tr>
  <td>Amount, currency specified:</td>
  <td><span oraType="money:EUR" oraField="totalAmt"></span></td>
</tr>
<tr>
  <td>Amount, default currency:</td>
  <td><span oraType="money" oraField="totalAmt"></span></td>
</tr>
<tr>
  <td>Amount, default input:</td>
  <td><input oraType="money" oraField="totalAmt" /></td>
</tr>
<tr>
  <td>Amount, currency reference:</td>
  <td><input oraType="money;currencyRef:cur" oraField="totalAmt" /></td>
</tr>
</table>
</body>
<xml>
<root>
  <totalAmt>50500.09</totalAmt>
  <cur>EUR</cur>
</root>
</xml>
</html>

```

HTML rendered

```

Amount, currency specified: €50500.09
Amount, default currency:  $50500.09
Amount, default input:    
Amount, currency reference: 

```

Number Formatting

This function is used to display a number or validate an input value. For input elements, the system will return an error if a non-numeric value is entered.

Syntax

oraType="number"

NOTE: You must specify a pair of stylesheet references, `cisEnabled` and `cisDisabled`, in the map's header for right alignment. The stylesheet controls how the field will be rendered. If you want to alter the rendering you must override the `oraNumber` style.

```

<html>
<head>
  <link rel="stylesheet" type="text/css" href="cisDisabled.css" />
  <link rel="stylesheet" type="text/css" href="cisEnabled.css" />
</head>
<body>
<table summary="" border="1" cellpadding="1" cellspacing="1">
  <tr>
    <td>Count:</td>
    <td><span oraType="number" oraField="count"></span></td>
  </tr>
  <tr>
    <td>Count, input:</td>
    <td><input oraType="number" oraField="count" /></td>
  </tr>
</table>
</body>
<xml>
<root>
  <count>989</count>

```

```
</root>
</xml>
</html>
```

HTML rendered.

Count: 989
Count, input:

FK Reference Formatting

By default, when an element with an **fkRef** oraType is displayed, an info string, context menu, navigation, and search are enabled (if the FK reference has been configured accordingly). Syntax is provided to allow you to selectively turn off any of these features.

Note that you can enable the foreign key hyperlink separately as well, refer to [Embed Framework Navigation](#) for more information. The various attributes used to control foreign key reference functionality are as follows. Note that in every case, the default value is **true**. A value of **false** should be used to disable the feature.

Syntax

oraType="fkRef:true|false; info:true|false; context:true|false; navigation:true|false; search:true|false"

- **fkRef.** A value of 'true' enables all of the following foreign key reference processing. Use a value of 'false' to disable automatic FK Reference processing.
- **info.** A value of 'true' renders an [information string](#) on the UI map, if applicable.
- **context.** A value of 'true' renders a context menu to appear before the foreign key reference element, if applicable.
- **navigation.** A value of 'true' causes the information string to be rendered as a hyperlink, if applicable. Clicking the hyperlink [navigates](#) to the appropriate page.
- **search.** A value of 'true' displays a search icon that launches the [search zone](#) if applicable.

NOTE: Foreign key navigation and context menu functionality is only available for UI maps presented in a portal zone. UI Maps presented during BPA script processing cannot support navigation options. Search functionality is only available for input HTML elements.

- UI Map schema:

```
<schema>
  <bo fkRef="F1-BOMO" />
</schema>
```

- UI Map HTML:

```
<html>
<body>
<table summary="" border="1" cellpadding="1" cellspacing="1">
  <tr>
    <td>Business Object</td>
    <td><span oraField="bo" oraType="fkRef:true; info:true; context:true; navigation:true;"></span></td>
  </tr>
</table>
</body>
</html>
<root>
  <bo>F1-COUNTRY</bo>
</root>
</xml>
```

```
</html>
```

- HTML rendered.

BUSINESS OBJECT

▼ Country

Lookup Formatting

This function is used to display the description of a lookup value.

Syntax	Valid Values
<code>oraType="lookup: "</code>	Lookup field name after the colon.

```
<html>
<body>
<table summary="" border="1" cellpadding="1" cellspacing="1">
  <tr>
    <td>Status:</td>
    <td><span oraField="status" oraType="lookup: BATCH_JOB_STAT_FLG"></span></td>
  </tr>
</table>
</body>
</html>
<xml>
<root>
  <status>PD</status>
</root>
</xml>
</html>
```

HTML rendered.

Status: Pending

Extendable Lookup Formatting

This function is used to display the description of an extendable lookup value.

Syntax	Valid Values
<code>oraType="lookupBO: "</code>	Business Object code name after the colon.

```
<html>
<body>
<table summary="" border="1" cellpadding="1" cellspacing="1">
  <tr>
    <td>Value:</td>
    <td><span oraField="status" oraType="lookupBO: Fl-DeviceDisplayTypes"></span></td>
  </tr>
</table>
</body>
</html>
<xml>
<root>
  <status>oraTablet</status>
</root>
</xml>
</html>
```

HTML rendered.

Value: Tablet size

Characteristic Type Formatting

This function is used to display the description of a predefined characteristic value.

Syntax	Valid Values
<code>oraType="charType: "</code>	Characteristic Type code after the colon.

```
<html>
<body>
<table summary="" border="1" cellpadding="1" cellspacing="1">
  <tr>
    <td>Skill:</td>
    <td><span oraType="charType:CM-SKILL" oraField="skill"></span></td>
  </tr>
</table>
</body>
</html>
<xml>
<root>
  <skill>10</skill>
</root>
</xml>
</html>
```

HTML rendered.

Skill: Quality assurance

Control Table Formatting

This function is used to display the description of a control table that has an associated language table.

Syntax	Valid Values
<code>oraType="table: "</code>	Table code after the colon.

```
<html>
<body>
<table summary="" border="1" cellpadding="1" cellspacing="1">
  <tr>
    <td>Currency:</td>
    <td><span oraType="table:CI_CURRENCY_CD" oraField="curr"></span></td>
  </tr>
</table>
</body>
</html>
<xml>
<root>
  <curr>USD</curr>
</root>
</xml>
</html>
```

HTML rendered.

Currency: United States Dollars

Add / Remove Grid Formatting

Syntax	Description
<code>oraType="addGridRow"</code>	The addGridRow function is used to build "insert row" dialog into the UI map.

Syntax**Description****oraType="deleteGridRow"**

The deleteGridRow function is used to build "delete row" dialog into the UI map.

- An 'add' image is displayed.
- Clicking the image inserts a new row in the grid.
- If the list is empty, by default, an empty grid row is automatically be added. This means that the user will always see at least one grid row when this attribute is used.
- A 'delete' image is displayed.
- Clicking the image removes the adjacent row from the grid.

NOTE: Because add and delete dialogs are relevant only inside a table, these attributes must be specified within a <td> element.

WARNING: These attributes are designed to work with the business object action of 'replace' rather than 'update'. Therefore, if the map contains a grid, the business object action of 'replace' must be used to update the business object. Refer to [BO Replace Action](#) for more information.

Example:

```
<html>
<head>
<title>Demonstrate Grid Add and Grid Delete OraTypes</title>
  <link rel="stylesheet" type="text/css" href="cisDisabled.css"/>
  <link rel="stylesheet" type="text/css" href="cisEnabled.css"/>
</head>
<body>
<table oraList="listEntry">
  <thead>
    <tr>
      <th/>
      <th/>
      <th><span>Date</span></th>
      <th><span>Amount</span></th>
    </tr>
  </thead>
  <tr>
    <td oraType="addGridRow"></td>
    <td oraType="deleteGridRow"></td>
    <td>
      <input oraField="date" oraType="date"></input>
    </td>
    <td align="right">
      <input oraField="amount" oraType="money"></input>
    </td>
  </tr>
</table>
</body>
<xml>
<root>
  <listEntry>
    <date>2008-01-01</date>
    <amount>44.28</amount>
  </listEntry>
  <listEntry>
    <date>2008-02-01</date>
    <amount>32.87</amount>
  </listEntry>
  <listEntry>
    <date>2008-03-01</date>
```

```

    <amount>21.76</amount>
  </listEntry>
</root>
</xml>
</html>

```

HTML rendered.

	DATE		AMOUNT
+ 	01-01-2008	 	\$44.28
+ 	02-01-2008	 	\$32.87
+ 	03-01-2008	 	\$21.76

Unformatted Elements

This function is used to display the contents of an element that contains 'raw' data as defined for the schema element being rendered.

Syntax

oraType="raw"

- UI Map schema:

```

<schema>
  <rawStuff type="raw"/>
</schema>

```

- UI Map HTML:

```

<html>
<head>
  <link rel="stylesheet" type="text/css" href="cisDisabled.css"/>
  <link rel="stylesheet" type="text/css" href="cisEnabled.css"/>
</head>
<body>
<table summary="" border="1" cellpadding="1" cellspacing="1">
  <tr>
    <td>Raw Stuff:</td>
    <td><span oraType="raw" oraField="rawStuff"></span></td>
  </tr>
</table>
</body>
<xml>
<root>
  <rawStuff>
    <ele1>text in element 1</ele1>
    <group1>
      <ele2>text inside element 2, group 1</ele2>
      <ele3>text inside element 3, group 1</ele3>
    </group1>
  </rawStuff>
</root>
</xml>
</html>

```

HTML rendered.

Raw Stuff:	<pre><ele1>text in element 1</ele1> <group1> <ele2>text inside element 2, group 1</ele2> <ele3>text inside element 3, group 1</ele3> </group1></pre>
------------	--

String Formatting

This function is used to display the contents of an element, as XML pretty-print, when the element contains escaped XML.

Syntax

`oraType="xmlString"`

NOTE: It is not required, but the pretty print of the rendered XML is enhanced if you specify a pair of stylesheet references, `cisEnabled` and `cisDisabled`, in the map's header.

Example:

```
<html>
<head>
  <link rel="stylesheet" type="text/css" href="cisDisabled.css"/>
  <link rel="stylesheet" type="text/css" href="cisEnabled.css"/>
</head>
<body>
<table summary="" border="1" cellpadding="1" cellspacing="1">
  <tr>
    <td>XML Stuff:</td>
    <td><span oraType="xmlString" oraField="xmlStuff"></span></td>
  </tr>
</table>
</body>
<xml>
<root>
  <xmlStuff>
    <ele1>text in element 1</ele1>
    <group1>
      <ele2>text inside element 2, group 1</ele2>
      <ele3>text inside element 3, group 1</ele3>
    </group1>
  </xmlStuff>
</root>
</xml>
</html>
```

HTML rendered.

XML Stuff:	<pre><ele1>text in element 1</ele1> <group1> <ele2>text inside element 2, group 1</ele2> <ele3>text inside element 3, group 1</ele3> </group1></pre>
------------	--

HTML rendered without `oraType="xmlString"`

XML Stuff:	<pre><ele1>text in element 1</ele1><group1><ele2>text inside element 2, group 1</ele2><ele3>text inside element 3, group 1</ele3></group1></pre>
------------	--

HTML Formatting

This function is used to display the contents of an element as HTML as opposed to plain text. An element defined as `oraType="fkref"` is automatically rendered as HTML.

Syntax

`oraType="html"`

WARNING:

To avoid execution of malicious HTML not all HTML tags are supported. The list of supported tags is defined in the "F1-HTMLWhiteList" managed content definition.

If unsupported HTML is detected the entire element is escaped and rendered as plain text. It is therefore recommended to properly escape any source string that contributes to the final HTML element if it is not expected to contain valid HTML. This way only the offending string is escaped and not the entire element.

If the HTML element is composed in scripting refer to the 'escape' function described in the [Edit Data Syntax](#) for more information. Use the `WebStringUtilities.asHTML` java API for escaping text composed in Java.

```
<html>
<head>
  <link rel="stylesheet" type="text/css" href="cisDisabled.css"/>
  <link rel="stylesheet" type="text/css" href="cisEnabled.css"/>
</head>
<body>
<table summary="" border="0" cellpadding="1" cellspacing="1">
  <tr>
    <td>Info :</td>
    <td><span oraType="html" oraField="info"></span></td>
  </tr>
</table>
</body>
<xml>
<root>
  <info><b>text in bold</b></info>
</root>
</xml>
</html>
```

HTML rendered.

Info : **text in bold**

HTML rendered without `oraType="html"`

Info : text in bold

Display Labels

Derive Label from an Element

This attribute is used to obtain a language sensitive label for a ``, `<td>`, or `<input>` HTML element.

Syntax

`oraLabel=" "`

Valid Values

XPath of an element in the UI map schema. The element must reference either the `mapField=`, `mdField=`, or `label=` attribute.

NOTE: You can also define a field directly in your HTML for label definition, refer to [Deriving Label from a Field](#) for more information.

NOTE: If the schema contains multiple attributes, the oraLabel attribute will pick the label to render according to the following hierarchy: The label attribute overrides the mdField attribute, which in turn will override the mapField attribute.

- UI Map schema:

```
<schema>
  <user mapField="USER_ID" />
  <info type="group" mapXML="CLOB">
    <city label="Metro Area" />
    <age mdField="AGE_LBL" />
  </info>
</schema>
```

- HTML:

```
<html>
<head><title oraMdLabel="BUS_LBL"></title></head>
<body>
<table>
  <tr>
    <td oraLabel="user"></td>
    <td><input oraField="user" /></td>
  </tr>
  <tr>
    <td oraLabel="info/city"></td>
    <td><input oraField="info/city" /></td>
  </tr>
  <tr>
    <td oraLabel="info/age"></td>
    <td><input oraField="info/age" /></td>
  </tr>
  <tr>
    <td />
    <td><input type="button" oraMdLabel="ACCEPT_LBL" /></td>
  </tr>
</table>
</body>
<xml>
<root>
  <user>RWINSTON</user>
  <info>
    <city>Alameda</city>
    <age>32</age>
  </info>
</root>
</xml>
</html>
```

HTML rendered:

User	<input type="text" value="RWINSTON"/>
Metro Area	<input type="text" value="Alameda"/>
Age	<input type="text" value="32"/>
	<input type="button" value="Accept"/>

Deriving Label from a Field

This attribute is used to obtain a language sensitive label for a , <td>, <input>, or <title> HTML element. The label text is derived from the field referenced.

Syntax**Valid Values**

oraMdLabel=" "MD Field code.

NOTE: You can also define labels derived from the map's schema definition, refer to [Derive Label from an Element](#) for more information.

- **HTML:**

```
<html>
<head><title oraMdLabel="Fl_DETAILS_LBL"></title></head>
<body>
<table>
  <tr>
    <td oraLabel="user"></td>
    <td><input oraField="user"/></td>
  </tr>
  <tr>
    <td oraLabel="info/city"></td>
    <td><input oraField="info/city"/></td>
  </tr>
  <tr>
    <td oraLabel="info/age"></td>
    <td><input oraField="info/age"/></td>
  </tr>
  <tr>
    <td/>
    <td><input type="button" oraMdLabel="ACCEPT_LBL"/></td>
  </tr>
</table>
</body>
<xml>
<root>
  <user>RWINSTON</user>
  <info>
    <city>Alameda</city>
    <age>32</age>
  </info>
</root>
</xml>
</html>
```

HTML rendered:

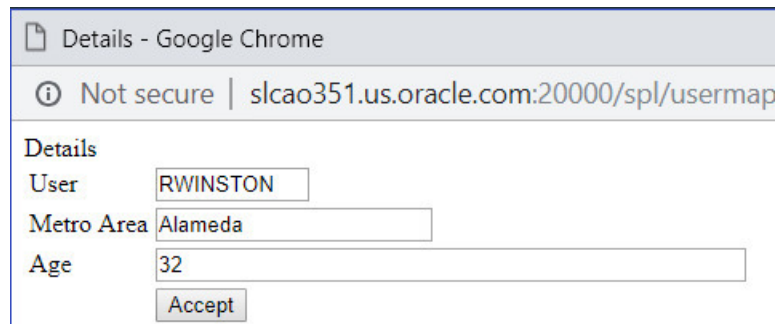

The screenshot shows a web browser window titled "Details - Google Chrome". The address bar displays "Not secure | slcao351.us.oracle.com:20000/spl/usermap". Below the address bar, there is a form titled "Details". The form contains three input fields: "User" with the value "RWINSTON", "Metro Area" with the value "Alameda", and "Age" with the value "32". Below these fields is an "Accept" button.

Enable UI Map Help

The [Display Labels](#) section describes ways to derive the label for an element using an underlying [MD Field](#). In addition, if the same MD field contains help text, the system will automatically generate a tool tip adjacent to the element label. Clicking the tool tip allows the user to view the help text.

It is possible to change the rendering of the tool tip. Refer to [Custom Look And Feel Options](#) for more information

Search Using a Pop-Up Explorer Zone

Search Option

This attribute is used to enable search zone functionality for input HTML elements.

Syntax	Valid Values
<code>oraSearch=" "</code>	Zone code.

NOTE: The `oraSearch` attribute is similar to the `oraType` attribute, because it will be 'automatically' included into HTML via the `oraSchemaDataTypes` attribute. This means that coding the `oraSearch` attribute into UI Map HTML is only required if a search zone has not been specified in the schema, or in the schema element's FK reference.

- Example of defining the search in the HTML. UI Map's Schema:

```
<schema>
  <uiMap/>
</schema>
```

UI Map's HTML

```
<html>
<body>
<table summary="" border="1" cellpadding="1" cellspacing="1">
  <tr>
    <td>UI Map with Search </td>
    <td><input oraField="uiMap" oraSearch="F1-UISRCH"></td>
  </tr>
</table>
</body>
</html>
<xml>
<root>
  <uiMap/>
</root>
</xml>
</html>
```

- Example of defining the search in the schema. UI Map's Schema:

```
<schema>
  <uiMap search="F1-UISRCH" />
</schema>
```

UI Map's HTML

```
<html>
<body>
<table summary="" border="1" cellpadding="1" cellspacing="1">
  <tr>
    <td>UI Map with Search </td>
    <td><input oraField="uiMap"></td>
  </tr>
</table>
</body>
</html>
<xml>
<root>
  <uiMap/>
</root>
</xml>
</html>
```

- Example where the FK reference defines the search zone. UI Map's Schema:

```
<schema>
  <uiMap fkRef="F1-UISRC" />
```

```
</schema>
```

UI Map's HTML

```
<html>
<body>
<table summary="" border="1" cellpadding="1" cellspacing="1">
  <tr>
    <td>UI Map with Search </td>
    <td><input oraField="uiMap"></td>
  </tr>
</table>
</body>
<xml>
<root>
  <uiMap/>
</root>
</xml>
</html>
```

In all cases, the HTML rendered is the same.



Initializing Search Fields

This optional attribute is used to initialize search zone filters. Multiple filters may be initialized. This attribute can only be used in conjunction with the oraSearch attribute.

Syntax	Valid Values	Field Value Options	Comments
<code>oraSearchField=""</code>	One or more pairs of field name and field value separated by colon. Each pair is separated by a semi-colon.	No value	If you do not specify a field value, then the value of the input element containing the oraSearchField attribute will be used.
<code>oraSearchField="fieldName:fieldValue: ..."</code>	The field name is used to identify the zone filter to initialize when the search is launched. The field name must match the value of the searchField mnemonic specified on a search zone user filter or hidden filter parameter.	XPath 'literal'	Indicate the XPath to the schema element that contains the value to use. Indicate a literal value to supply.

NOTE: If you do not specify an oraSearchField attribute and the schema element has a search enabled fkRef specified, the framework automatically builds an oraSearchField where the field name is equal to the FK reference's key (MD) [fields](#).

WARNING: The pop-up explorer zone can be invoked one of two ways: By clicking on the search button, or by hitting the enter key from the field to the left of the button. If you click on the button then no search field information will be passed to the zone. Search field information is only used to initialize zone filter values when enter is pressed.

Two filter values are initialized as shown in the following example:

```
<schema>
  <bo/>
  <uiMap/>
</schema>

<html>
<body>
```

```

<table summary="" border="1" cellpadding="1" cellspacing="1">
  <tr>
    <td>UI Map with Search </td>
    <td><input oraField="uiMap" oraSearch="F1-
UISRCH" oraSearchField="MAP_CD; BUS_OBJ_CD:bo;"></td>
  </tr>
</table>
</body>
<xml>
<root>
  <bo/>
  <uiMap/>
</root>
</xml>
</html>

```

Mapping Returned Search Fields

This optional attribute is used to direct values returned by the search zone. Multiple fields may be specified. This attribute can only be used in conjunction with the oraSearch attribute.

Syntax	Valid Values	Field Value Options	Comments
oraSearchOut=" "	One or more pairs of field name and field value separated by colon. Each pair is separated by a semi-colon.	No value	If you do not specify a field value, then the input element containing the oraSearchField attribute receives the returned value.
oraSearchOut="field name:xpath target; ..."	The field name is used to identify the search result returned from the query zone. The field name must match the ELEMENT_NAME mnemonic defined within the explorer zone's search results parameter.	XPath	Indicate the XPath to the schema element that should receive the returned value.

NOTE: If you do not specify an oraSearchOut attribute, the framework will build a default where the field name will be set equal to the oraSearchField's field name.

Two values are returned in the following example:

```

<schema>
  <bo/>
  <mo/>
</schema>

```

```

<html>
<body>
<table summary="" border="1" cellpadding="1" cellspacing="1">
  <tr>
    <td>BO Search </td>
    <td><input oraField="bo" oraSearch="Z1-BOSRCH" oraSearchOut="BUS_OBJ_CD; MO_CD:mo;"></td>
  </tr>
</table>
</body>
<xml>
<root>
  <bo/>
  <mo/>
</root>
</xml>
</html>

```

Display Errors

Display Error Variables

One of the following error variables may be displayed.

Syntax

`oraErrorVar="ERRMSG-TEXT"`

`oraErrorVar="ERRMSG-LONG"`

`oraErrorVar="ERRMSG-CATEGORY"`

`oraErrorVar="ERRMSG-NUMBER"`

```
...  
<table width="100%" cellpadding="12">  
  <tr class="oraErrorText">  
    <td>  
      <a href="" onclick="oraShowErrorAlert(); return false;">  
        <span class="oraErrorText" oraErrorVar="ERRMSG-TEXT"></span>  
      </a>  
    </td>  
  </tr>  
</table>  
...
```

HTML rendered



Last name required

User Id BOND007

First Name

Last Name

Highlight a Field in Error

NOTE: For more information on throwing an error, refer to the [Terminate Statement](#) in the Edit Data Syntax.

Syntax

`oraError="automate:true|false; prefix: "`

Comments

Specifying **automate:true** automatically enables highlighting of the element in error when issuing an error. Note that **true** is the default and doesn't need to be specified. Specify **automate:false** to turn off field highlighting.

The system uses a match on the element name referenced in the error to the element names in the UI map. If the elements in the schema are within an XPath that may not match what is referenced by the error, use **prefix:XPath** to specify that.

NOTE: A pair of stylesheet references, `cisEnabled` and `cisDisabled`, must be specified for reference of the `oraError` style. The stylesheet controls how the field in error will be rendered. If you want to alter the rendering you must override the `oraError` style.

The following HTML example shows that the elements in the map are defined within a group called **boGroup**. The element name returned by the error will not include this group so in order for the field highlighting to work properly the **prefix:** attribute must indicate the group name.

```
<html>
<head>
  <title>User Zone Input</title>
  <link rel="stylesheet" type="text/css" href="cisDisabled.css"/>
  <link rel="stylesheet" type="text/css" href="cisEnabled.css"/>
</head>
<body oraError="automate:true; prefix:boGroup">
<table width="100%" cellpadding="12">
  <tr class="oraErrorText">
    <td>
      <a href="" onclick="oraShowErrorAlert(); return false;">
        <span class="oraErrorText" oraErrorVar="ERRMSG-TEXT"></span>
      </a>
    </td>
  </tr>
</table>
<table width="100%" border="0" cellpadding="4">
  <tr style="padding-top:30px;">
    <td align="right" class="label">User Id</td>
    <td>
      <span oraField="boGroup/userId" class="normal"/>
    </td>
  </tr>
  <tr>
    <td align="right" class="label">First Name</td>
    <td>
      <input oraField="boGroup/firstName" class="normal"/>
    </td>
  </tr>
  <tr>
    <td align="right" class="label">Last Name</td>
    <td>
      <input oraField="boGroup/lastName" class="normal"/>
    </td>
  </tr>
</table>
</body>
<xml>
<root>
  <boGroup>
    <userId>BOND007</userId>
    <firstName>James</firstName>
    <lastName></lastName>
  </boGroup>
</root>
</xml>
</html>
```

HTML rendered, where the error element thrown is equal to 'lastName':

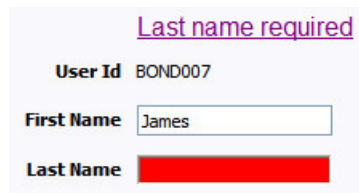

Overriding the Error Element Name

In the rare occasion where the element name returned by the error doesn't match the element name in the map, you can add an explicit attribute to indicate the error element name.

Syntax	Valid Values	Comments
<code>oraErrorElement=</code>	"element name"	The element name referenced here must exactly match the name of the error element assigned when the error was thrown. More than one HTML field can be referenced by the same error element name.

NOTE: A pair of stylesheet references, `cisEnabled` and `cisDisabled`, must be specified for reference of the `oraError` style. The stylesheet controls how the field in error will be rendered. If you want to alter the rendering you must override the `oraError` style.

This illustrates a scenario where the element name associated with the error differs from the element name on the map.

```
<html>
<head>
  <title>User Zone Input</title>
  <link rel="stylesheet" type="text/css" href="cisDisabled.css"/>
  <link rel="stylesheet" type="text/css" href="cisEnabled.css"/>
</head>
<body>
<table width="100%" cellpadding="12">
  <tr class="oraErrorText">
    <td>
      <a href="" onclick="oraShowErrorAlert(); return false;">
        <span class="oraErrorText" oraErrorVar="ERRMSG-TEXT"></span>
      </a>
    </td>
  </tr>
</table>
<table width="100%" border="0" cellpadding="4">
  <tr style="padding-top:30px;">
    <td align="right" class="label">User Id</td>
    <td>
      <span oraField="userId" class="normal"/>
    </td>
  </tr>
  <tr>
    <td align="right" class="label">First Name</td>
    <td>
      <input oraField="firstName" class="normal" oraErrorElement="firstName"/>
    </td>
  </tr>
  <tr>
    <td align="right" class="label">Last Name</td>
    <td>
      <input oraField="familyName" class="normal" oraErrorElement="lastName"/>
    </td>
  </tr>
</table>
</body>
<xml>
<root>
  <userId>BOND007</userId>
  <firstName>James</firstName>
  <familyName></familyName>
</root>
</xml>
</html>
```

HTML rendered.

Last name required

User Id BOND007

First Name

Last Name

Display Error Pop-Up

When the error text is displayed, this function may be used to pop-up the standard error dialog (which displays more information) when a user clicks the error message.

Syntax

oraShowErrorAlert(); return false;

```
<html>
<head>
  <link rel="stylesheet" type="text/css" href="cisDisabled.css"/>
  <link rel="stylesheet" type="text/css" href="cisEnabled.css"/>
</head>
<body>
<table width="100%" cellpadding="12">
  <tr class="oraErrorText">
    <td>
      <a href="" onclick="oraShowErrorAlert(); return false;">
        <span class="oraErrorText" oraErrorVar="ERRMSG-TEXT"></span>
      </a>
    </td>
  </tr>
</table>
<table>
  <tr>
    <td >Address:</td>
    <td><input type="text" oraField="address"/></td>
  </tr>
  <tr>
    <td>City:</td>
    <td><input type="text" oraField="city"/></td>
  </tr>
  <tr>
    <td>State:</td>
    <td><input type="text" oraField="state"/></td>
  </tr>
  <tr>
    <td>Zip:</td>
    <td><input type="text" oraField="zip"/></td>
  </tr>
  <tr>
    <td/>
    <td style="padding-top:15px;">
      <oraInclude map="F1-SaveCancelButton"/>
    </td>
  </tr>
</table>
</body>
<xml>
<root>
  <address>123 Main St</address>
  <city>Alameda</city>
  <state>CA</state>
  <zip>94770</zip>
</root>
</xml>
</html>
```

HTML rendered.

Address field missing

Address:

City:

State:

Zip:

Standard error pop-up dialog launched via click on error message:

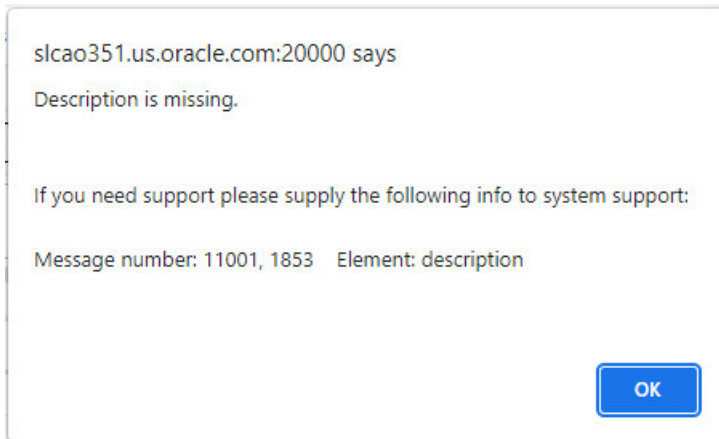

Fire JavaScript for Browser Events

Working with the JavaScript Framework

There are many JavaScript events that can be used within the HTML/Javascript environment. These include events such as onLoad, onBlur, onChange, etc. The UI Map Framework also makes use of some of these events. It is important that any UI Map you develop works with the framework in order to obtain consistent results (events may not always be executed in the same order at all times!).

WARNING:

The following describes the recommended approach for safely handling loading and processing field updates in your UI Maps.

If JavaScript is required within an XHTML UI Map or fragment, it will be necessary to bound it within a `![CDATA[]]` tag to ensure a valid XML document. Note that the tags themselves may need to be commented out to promote compatibility with older browsers. For example:

```
<script type="text/javascript">  
/*  */<br/><br/>//<br/>// javascript<br/>//<br/><br/>/* ]&gt; */<br/>&lt;/script&gt;</pre></div><div data-bbox="467 942 912 959" data-label="Page-Footer"><hr/><p>Oracle Utilities Customer to Meter Administrative User Guide • 221</p></div>
```

Element Change Event

Syntax	Valid Values
<code>oraChange=" "</code>	A JavaScript function.

At the time of UI Map load, if there is an event handler already attached to an HTML element, the framework removes it and attaches a combined event handler. The combined handler calls any **framework handler first** and then calls the other (custom) handlers.

WARNING: Note that the function must not be used to execute logic that will modify the associated field data value again - or an endless loop will occur.

In the following example the **oraInvokeBS** function is executed when the button is clicked.

```
<html>
  <head>
    <title>oraInvokeBS test</title>
  </head>
  <body>
    <table>
      <tr>
        <td>User Id:</td>
        <td>
          <input oraField= "xmlGroup/userId"/>
          <input type="button" value="Search" oraChange="oraInvokeBS('UserSearch', 'xmlGroup');"/>
        </td>
      </tr>
      <tr>
        <td/>
        <td>Search Results</td>
      </tr>
      <tr>
        <td/>
        <td>
          <table oraList="xmlGroup/searchList">
            <tr>
              <td><span oraField="userId"></span>
            </td>
            </tr>
          </table>
        </td>
      </tr>
    </table>
  </body>
  <xml>
    <root>
      <xmlGroup>
        <userId/>
        <searchList>
          <userId></userId>
        </searchList>
      </xmlGroup>
    </root>
  </xml>
</html>
```

Page Load Event

Syntax	Valid Values
<code>oraLoad=" "</code>	A JavaScript function.

WARNING: When executing oraLoad within a fragment UI map, and you need to execute a JavaScript function during page load (where the function invokes a business object, business service, or service script) you can use the special syntax "**oraLoad[\$SEQUENCEID]**". For other special syntax used for map fragments, refer to the [Construct a Portal Zone Header](#) section.

- In the following example, the `oraDisplayNone` function is executed during page load:

```
<html>
<body>
<table summary="" border="1" cellpadding="1" cellspacing="1">
  <tr>
    <td oraLoad="oraDisplayNone(item,'userId','')">User Id: </td>
    <td><span oraField="userId"></span></td>
  </tr>
</table>
</body>
<xml>
<root>
  <userId>SPLAXT</userId>
</root>
</xml>
</html>
```

- HTML rendered

User Id: SPLAXT

After Page Load Event

Syntax	Valid Values
<code>oraAfterLoad=""</code>	A JavaScript function.

In the following example the `oraGetValueFromScript` function is executed after page load.

```
<div>
  <label for="boGroup_parameters_externalSystem" oraLabel="boGroup/parameters/externalSystem">
  </label>
  <span>
    <select oraSelect="bs:F1-RetrieveExternalSystems" class="oraInput"
      id="boGroup_parameters_externalSystem" oraField="boGroup/parameters/externalSystem"
      oraSelectOut="valuePath:results/externalSystem; descPath:results/description"
      oraSelectIn="outboundMsgType:boGroup/parameters/outboundMsgType"
      oraAfterLoad
      ="oraGetValueFromScript(document.getElementById('boGroup_parameters_externalSystem'));">
    </select>
  </span>
</div>
```

Hide Elements

Hide Using a Function

The system provides multiple techniques for hiding an HTML element.

Syntax	Valid Values	Comments
<code>oraDisplayNone(item);</code>	(item, 'XPath', 'value', 'operator')	Used to hide an element based on the value of another element (referenced using its XPath). Enter a value of '' to interrogate a blank value. By default the operator is '='. This

Syntax	Valid Values	Comments
		may be set instead to another operator such as '!=', '>', or '<'.
	(item, function name, true false)	Used to indicate a JavaScript function, which must return a Boolean.
oralsSuppress="true"		Use this option for fields that need to be hidden always and not dependent on something else. Set this attribute on the HTML element (div element).

- Example where the User Id label is hidden when no User Id value exists.

```
<html>
<body>
<table summary="" border="1" cellpadding="1" cellspacing="1">
  <tr>
    <td oraLoad="oraDisplayNone(item,'userId','')>User Id: </td>
    <td><span oraField="userId"></span></td>
  </tr>
</table>
</body>
<xml>
<root>
  <userId></userId>
</root>
</xml>
</html>
```

- Example where the Save button is hidden when the user does not have security access to the action of change ('C') for the application service 'F1-DFLTS'.

```
<html>
<body>
<table summary="" border="1" cellpadding="1" cellspacing="1">
  <tr>
    <td oraLoad="oraDisplayNone(item, oraHasSecurity('F1-DFLTS', 'C'), false );">
      <input name="Save" type="button" onclick="oraInvokeBO('CM-
IndividualTaxpayer', null, 'replace')"/>
    </td>
  </tr>
</table>
</body>
<xml>
<root>
  <userId></userId>
</root>
</xml>
</html>
```

Check User's Security Access

The system provides two functions to check a user's security access to a given application service and access mode. These are commonly used for hiding elements.

Syntax	Parameters
oraHasSecurity()	'Application Service code'
	'Access Mode'
oraHasSecurityPath('x','y')	'Application Service XPath'
	'Access Mode XPath'

See the previous section for an example of the **oraHasSecurity** function. The following shows an example where the status button is hidden when the user does not have security access to the access mode 'ACT' of the application service 'FORMTST'.

```
<html>
<body>
<table>
  <tr>
    <td oraLoad="oraDisplayNone(item, oraHasSecurityPath('appService', 'accessMode'), false );">
      <input oraField="statusLabel" type="button" onclick="oraRunScript('UpdateState','status');"/>
    </td>
  </tr>
</table>
</body>
<xml>
<root>
  <status>ACTIVATE</status>
<statusLabel>Activate</statusLabel>
<appService>FORMTST</appService>
  <accessMode>ACT</accessMode>
</root>
</xml>
</html>
```

Invoke Schema Based Services

The system provides functions for invoking a business object, business service or service script.

Invoke BO Function

This function is used to perform a BO interaction directly from the UI map's HTML. It returns a 'true' or a 'false' depending on whether the invocation encounters an error.

Syntax	Parameters	Comments
oralInvokeBO()	'BO Name'	
	'XPath' or null	Identifies a group element via XPath. If you specify the word null , then the entire embedded XML object will be passed.
	'action'	Indicate the action to use. Valid values are add, delete, read, update, replace, fastAdd and fastUpdate . FASTPATH: Refer to BO Actions for more information about the various BO actions.

Example with the statement invoked in a JavaScript function.

```
function invokeBO {
  if (!oraInvokeBO('F1-User', 'xmlGroup', 'read')) {
    oraShowErrorAlert();
    return;
  }
}
```

Example with the statement invoked within onClick.

```
<input type="button" class="oraButton" oraMdLabel="DISPLAY_LBL" onClick="oraInvokeBO('F1-User');"/>
```

Invoke BS Function

This function is used to perform a business service interaction directly from the UI map's HTML. It returns a 'true' or a 'false' depending on whether the invocation encounters an error.

Syntax	Parameters	Comments
<code>oraInvokeBS()</code>	'BS Name' 'XPath' or null	Identifies a group element via XPath. If you specify the word null , then the entire embedded XML object will be passed.

Example with the statement coded within a JavaScript function.

```
function invokeBS {
    if (!oraInvokeBS('F1-UserSearch', 'xmlGroup')) {
        oraShowErrorAlert();
        return;
    }
}
```

Example with the statement invoked via onClick.

```
<input type="button" class="oraButton" oraMdLabel="DISPLAY_LBL" onClick="oraInvokeBS('F1-RetrieveInfo');"/>
```

Invoke SS Function

This function is used to perform a service script interaction directly from the UI map's HTML. It returns a 'true' or a 'false' depending on whether the invocation encounters an error.

Syntax	Parameters	Comments
<code>oraInvokeSS()</code>	'Service Script Name' 'XPath' or null	Identifies a group element via XPath. If you specify the word null , then the document belonging to the parent node will be passed. If the parent node is not enough, then the entire document can always be passed using the following syntax: <code>oraInvokeSS('service script', null, null, {\$SEQUENCEID})</code>

Example with the statement invoked within a JavaScript function:

```
function invokeSS {
    if (!oraInvokeSS('F1-GetUsers', 'xmlGroup')) {
        oraShowErrorAlert();
        return;
    }
}
```

Example with the statement invoked within onClick.

```
<input type="button" class="oraButton" oraMdLabel="DISPLAY_LBL" onClick="oraInvokeSS('F1-GetUserInfo');"/>
```

Refresh a Rendered Map or Portal Page

Refresh Map

This function is used to 'Refresh' only the map zone issuing the command.

Syntax

oraRefreshMap;

```
...
  <tr>
    <td/>
    <td><input type="button" onclick="oraRefreshMap();" value="Refresh"/></td>
  </tr>
...
```

Refresh Page

This function is used to refresh all zones in the portal.

Syntax

oraRefreshPage;

```
...
  <tr>
    <td/>
    <td><input type="button" onclick="oraRefreshPage();" value="Refresh"/></td>
  </tr>
...
```

Embed Framework Navigation**Navigate using Navigation Option**

This function is used to navigate to another page using the information defined on a navigation option.

Syntax

oraNavigate();

Parameters

'Navigation Option code'

'Key XPath'

WARNING: This function is only intended for a UI map defined within a portal zone. It should not be used within a UI map launched by a BPA script.

The following example exhibits two possible uses of this function: as a URL and as a button. Note that the UI Map schema must contain a fkRef attribute. Refer to [FK Reference Formatting](#) for more information.

```
<schema>
  <userId fkRef="CI_USER"/>
</schema>

<html>
<body>
<table summary="" border="1" cellpadding="1" cellspacing="1">
  <tr>
    <td>User Link: </td>
    <td><a href="" onclick="oraNavigate('userMaint','userId'); return false;">
      <span oraField="userId" oraType="fkRef:CI_USER"></span></a>
    </td>
  </tr>
</table>
<tr>
  <td>User Button: </td>
  <td><input type="submit" onclick="oraNavigate('userMaint','userId')"
    value="Go to User"/></td>
</tr>
</table>
</body>
<xml>
```

```
<root>
  <userId>SPLAXT</userId>
</root>
</xml>
</html>
```

HTML rendered.



Launch BPA Script

Launch BPA Script

Syntax	Parameters	Comments
<code>oraRunScript();</code>	'BPA script code'. 'XPath Element'	One or more element values may be passed into the BPA where it may be referenced as temporary variables.

WARNING: This function is only applicable to UI maps displayed in portal zones. UI maps launched within a running BPA script cannot directly launch another BPA script from the UI map's HTML. Instead, return a value from the UI map and execute a Perform Script or Transfer Control step type.

NOTE: It is incumbent on the script author to pull information out of temporary storage in the initial steps of the script.

In the following example, a temporary variable named 'personId' is created with value '1234567890' and the BPA script named 'Edit Address' is launched.

```
<html>
<body>
<table>
  <tr>
    <td>
      <div oraField="address"></div>
      <span oraField="city"></span>
      <span>,</span>
      <span oraField="state"></span>
      <span oraField="zip"></span>
      <span oraField="country"></span>
      <a href="" onClick="oraRunScript('Edit Address','personId');">edit</a>
    </td>
  </tr>
</table>
</body>
<xml>
<root>
  <personId>1234567890</personId>
  <address>123 Main St</address>
  <city>Alameda</city>
  <state>CA</state>
  <zip>94770</zip>
</root>
</xml>
</html>
```

HTML rendered.

123 Main St
Alameda, CA 94770 [edit](#)

Launch BPA Script With Values

This function is used to launch a BPA, providing name/value pairs to push into temporary storage. Multiple values can be passed. The BPA script can then reference the temporary variables by name.

Syntax	Parameters	Comments
<code>oraRunScriptWithValues();</code>	'BPA script code'. 'XPath Element Name':value	One or more pairs of element names and values.

NOTE: You would use this JavaScript function, instead of `oraRunScript`, if you need to push values to the BPA script that are not located in the UI Map's XML structure.

In the example below, a JavaScript function named 'editUser()' is responsible for launching the BPA script named 'UserEdit'. The temporary variable named 'userId' will be created with value 'CMURRAY'.

```
<html>
<head>
<script type="text/javascript">

function editUser() {
    var values = {'userId': 'CMURRAY'};
    oraRunScriptWithValues('UserEdit', values);
    return;
}

</script>
</head>
<body>
...
</body>
</html>
```

Exit UI Map with Bound Values

This function is used to exit a UI Map. When you quit the map you can specify a value to return to the script and, in addition, whether to return updated XML.

Syntax	Parameters	Comments
<code>oraSubmitMap();</code>	'Return Value' Boolean value	Indicates if the updated XML should be returned. Default is true .

In the following example, the Save button will return updated information, the Cancel button will not.

```
<html>
<body>
<table>
  <tr>
    <td/>
    <td style="padding-bottom:15px;">
      <a href="" onclick="oraShowErrorAlert(); return false;">
        <span oraErrorVar="ERRMSG-TEXT"></span></a>
    </td>
  </tr>
  <tr>
    <td >Address:</td>
    <td><input type="text" oraField="address"/></td>
  </tr>
  <tr>
    <td>City:</td>
```

```

    <td><input type="text" oraField="city"/></td>
  </tr>
  <tr>
    <td>State:</td>
    <td><input type="text" oraField="state"/></td>
  </tr>
  <tr>
    <td>Zip:</td>
    <td><input type="text" oraField="zip"/></td>
  </tr>
  <tr>
    <td/>
    <td style="padding-top:15px;">
      <input type="button" value="Save" onClick="oraSubmitMap('SAVE');"/>
      <input type="button" value="Cancel" onClick="oraSubmitMap('CANCEL',false);"/>
    </td>
  </tr>
</table>
</body>
</xml>
<root>
  <address>123 Main St</address>
  <city>Alameda</city>
  <state>CA</state>
  <zip>94770</zip>
</root>
</xml>
</html>

```

Save and Cancel buttons rendered:

Include a Map Fragment

This function is used to embed a map fragment within another UI map. Note that it is possible to use the include node within a map or a map fragment.

Syntax	Parameters	Comments
<code><oralInclude map=' ' prefixPath=' '/></code>	map='UI Map Code' prefixPath='Xpath'	Optionally specify an xpath prefix to be appended onto every included oraField, oraLabel, oraList, oraSelect valuePath and descPath, oraDownloadData, and oraUploadData attribute value defined within the included UI map fragment's HTML. NOTE: This functionality only applies to XPath attribute values when those values do not appear beneath an oraList attribute. Any XPath value within a table containing

Syntax	Parameters	Comments
		an oraList attribute will not be affected by a prefixPath.

- An example of a map fragment with two buttons, named 'F1-SaveCancelButtons'.

```
<input onClick = "oraSubmitMap('SAVE');" oraMdLabel="SAVE_BTN_LBL" class="oraButton" type="button"/>
<input onClick = "oraSubmitMap('CANCEL',false);" oraMdLabel="CANCEL_LBL" class="oraButton" type="button"/>
```

- An example of a map that includes the map fragment named 'F1-SaveCancelButtons'.

```
...
<tr>
  <td colspan="2" align="center">
<oraInclude map="F1-SaveCancelButtons"/>
  </td>
</tr>
...
```

Include a Web Component

A web component is a custom HTML element that produces a specific user interface feature. Each supported web component typically has one or more defined HTML attributes that affect how the web component functions and how it appears. The more complex web components may have a corresponding system configuration object that defines the behavior and information displayed by the resulting user interface element. For example the web component that produces a "tree" of information has a Tree configuration table, which defines the details about how to retrieve information for the tree and how to display each node.

Common Attributes

Some common attributes that may be used for each web component are:

- A reference to the specific instance of the configuration object that governs the details to produce.
- The ability to pass in context data as name and value pairs.
- A 'mode' that support showing a preview of the feature

Some attributes support a **single value** that is referenced. For these types of attributes, the value may be provided using one of the following references:

- Literal value. The value can be referenced directly. Example:

```
treename="F1-Tree"
```

- XPath Reference. XPath references must use the explicit syntax **x[value]**. Example:

```
treename="x[migrationTree]"
```

- Global or Portal context reference. These references must use the explicit syntax **c[value]**.

```
treename="c[TREE_NAME]"
```

- Field label reference. These references must use the explicit syntax **md[value]**.

```
text=md[F1_ADD_LBL]"
```

- Field help text reference. These references must use the explicit syntax **mdh[value]**.

```
text=mdh[F1_OPERATIONS_LBL]"
```

For **complex attributes** that support one or more name / value pairs, the syntax for defining the names and values follows the same rules as above for literal values, XPath references and context. Colons (":") should be used to separate the name from the value and semi-colons (";") separate each pair.

```
context="FIELD_NAME1:x[value1];FIELD_NAME2:F1AB;x[fieldName3]:c[FIELD_NAME3];"
```

A given web component may have additional HTML attributes specific to its functionality.

NOTE: Any UI map that defines a web component must include the F1-OJETLIBSR map fragment within the "body" tag.

```
<body>
<oraInclude map="F1-OJETLIBSR" />
. .
</body>
```

NOTE: Standard HTML attributes may also be provided (e.g ID=".." and style=".."). These are defined as normal. It should be noted that the web components themselves may control some styling aspects directly and thus override any style settings provided on the HTML web component. For example, the Contextual Insights configuration provides settings for text color that would override any color defined in the HTML.

The following sections describe each supported web component.

Trees

Refer to [Trees](#) for more information about tree configuration.

Syntax	Parameters	Comments
<code><ou-tree...></ou-tree></code>	<code>treename="singleValue"</code>	You must supply a reference to the name of the tree object that defines the configuration of the tree to display. This attribute expects a single value that follows the syntax described in the single value section above.
	<code>context="..."</code>	Optionally pass in one or more name / value pairs. The syntax follows the example shown in the complex attributes information above.

The following example uses an explicit reference to a tree and does not pass any context. The particular tree relies on global context, which the tree node algorithm has access to.

```
<ou-tree treename="C1-PremiseTree"></ou-tree>
```

Contextual Insight

Refer to [Contextual Insights](#) for information about the configuration related to defining contextual insights.

Syntax	Parameters	Comments
<code><ou-insights ...></ou-insights></code>	<code>insightType="singleValue"</code>	Use this attribute to specify an insight type to display. Either this attribute or the insight class attribute must be supplied. This attribute expects a single value that follows the syntax described in the single value section above.
	<code>insightClass="singleValue"</code>	Use an insight class to display all the insight types for the insight group related to this class. This attribute expects a single value that follows the syntax described in the single value section above.

Syntax	Parameters	Comments
	context="..."	Optionally pass in one or more name / value pairs. The syntax follows the example shown in the complex attributes information above.
	mode="preview"	Optionally pass in a mode of preview to indicate to the underlying insight algorithm that prepares the data that the insight is being called in preview mode, with no context available. Ideally the algorithm returns sample information.
	class=" "	Optionally provide a CSS helper class to control aspects of the rendered insight. Supported values: class="card-full-width" - Applicable to card insights. Use this option class to ensure that the width for a card insight adjusts to the width of the zone that contains it. Card insights that don't set this parameter use a fixed width.

The following example is from the insight preview map where the insight type is the one in context. No context data is needed and the mode is 'preview'.

```
<ou-insights insightType="x[insightType]" mode="preview"></ou-insights>
```

The following example uses an insight class and passes in context values from XPath elements with explicitly defined context names.

```
<ou-insights insightClass="ClCI" context="PER_ID:x[personId];ACCT_ID:x[accountId];PREM_ID:x[promiseId];"></ou-insights>
```

Button

The button web component provides support for the standard set of button formats used within the system.

Syntax	Parameters	Comments
<ou-button...></ou-button>	type="singleValue"	You must define the type of button to display. This attribute expects a single value that follows the syntax described in the single value section above. The valid type values are: <ul style="list-style-type: none"> image - image only text - text only imageText - image followed by text menu - text plus a dropdown caret to open the menu imageMenu - image plus a dropdown caret to open the menu If no type attribute is supplied, a 'broken button' image will be displayed.
	img="singleValue"	Define the path of the image to display. Either this attribute or the image reference attribute

Syntax**Parameters****Comments**

	<p>must be supplied for a button type that includes an image. This attribute expects a single value that follows the syntax described in the single value section above.</p> <p>Note that for SVG images, if the reference includes only the SVG file name with no path, the path is assumed to be the Framework SVG repository.</p>
imgRef="singleValue"	<p>Define the display icon reference of the image to be used. Either this attribute or the image attribute must be supplied for a button type that includes an image. This attribute expects a single value that follows the syntax described in the single value section above.</p>
text="..."	<p>Define the various text elements needed by the button. The syntax follows the example shown in the complex attributes information above. The valid text element name values are:</p> <ul style="list-style-type: none">• label - the label text to be used for the button• tooltip - the hover text to be used for the button• aria-label - the ARIA label for the button
menu="singleValue"	<p>Define the menu to be used with the button. This attribute must be supplied for a button type that includes a menu control. This attribute expects a single value that follows the syntax described in the single value section above.</p>
disabled="singleValue"	<p>This is a standard HTML attribute. A value of "true" or just the presence of the text "disabled" will result in an initially disabled button.</p>
security="..."	<p>Optionally define the security settings for the button. The button will be hidden if the user does not have the appropriate security access. The syntax follows the example shown in the complex attributes information above. The valid security element name values are:</p> <ul style="list-style-type: none">• service - the application service whose security access governs access to the button• accessMode - the specific access mode for the service that determines a more granular level of access to the button

Syntax

Parameters

Comments

`clickAction="..."`

Optionally define the action to be taken when the button is 'clicked'. The syntax follows the example shown in the complex attributes information above. There are specific 'name' values for the attribute as follows:

- **action** - the action to be taken. Valid values are 'BPA' and 'NAVIGATE'
- **script** - the script to be performed when the action is 'BPA'
- **navopt** - the navigation option to be used when the action is 'NAVIGATE'

The attribute may also include other name/value pairs that define information to be passed into the script or used as navigation context fields.

In addition to the security attribute settings, the system will check that the user has access to the script or navigation path before performing the action.

The standard HTML 'onClick' attribute may still be used. If the HTML includes an 'onClick' attribute as well as the 'clickAction', the 'onClick' attribute will take precedence

The following is an example of a simple button with text.

```
<ou-button type="text" text="label:md[F1_BOOKMARK_LBL];"></ou-button>
```

The following is an example of an icon button using a display icon reference.

```
<ou-button type="image" imgRef="F1CMNT"></ou-button>
```

The following is an example of an image menu button.

```
<ou-button type="imageMenu" imgRef="F1STTGS" menu="CI_CONTEXTSCRIPT" text="tooltip:md[F1INSTY_VIS_LBL];"></ou-button>
```

The following is an example of text button that navigates to another page.

```
<ou-button type="text" text="label:md[ALG_CD];tooltip:md[GOTO_ALG]" clickAction="action:NAVIGATE; navopt:flalgqTa"></ou-button>
```

Show Schema Default on Add

Default values within in the UI map's schema will be displayed on a UI map's input fields if an embedded <action> node has a value of 'ADD' or blank.

Syntax

```
<action>ADD</action>
```

```
<action> </action>
```

The schema default for the <description> element will be displayed:

```
<schema>
  <action/>
  <boGroup type="group">
    <key/>
    <description default="enter description here"/>
  </boGroup>
</schema>

<html>
<body>
<table summary="" border="1" cellpadding="1" cellspacing="1">
  <tr>
    <td>Description </td>
    <td><input oraField="boGroup/description"/></td>
  </tr>
</table>
</body>
<xml>
<root>
  <action>ADD</action>
  <boGroup>
    <key/>
    <description/>
  </boGroup>
</root>
</xml>
</html>
```

HTML rendered.

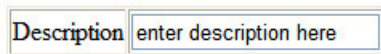

Configure a Chart

In addition to integrating charts with zones, the system supports using the same attributes within the UI Map HTML to configure a graphical representation of an XML list. The designer can control the type, size, position, and contents of the chart using these attributes. For details of the attributes and syntax, refer to [Data Explorer Graph Configuration](#).

Graph Examples

- Sample of a pie chart configuration:

```
<html>
<head>
<title>Pie Chart</title>
</head>
<body>

<div style="width:100%; height:290px;"
  oraChart="type:pie;"
  oraChartSeries1="list:set; labelPath:date; amount:amount; "
  oraChartBroadcast="BILL_ID:billId;">
</div>

</body>

<xml>
<root>
  <set>
<date>05-02-2003</date>
<amount>163.24</amount>
<billId>592211649441</billId>
  </set>
  <set>
<date>06-02-2003</date>
<amount>97.29</amount>
<billId>592211649442</billId>
```

```

    </set>
    <set>
<date>07-02-2003</date>
<amount>54.38</amount>
<billId>592211649443</billId>
    </set>
</root>
</xml>
</html>

```

- A pie chart rendered for a single series:

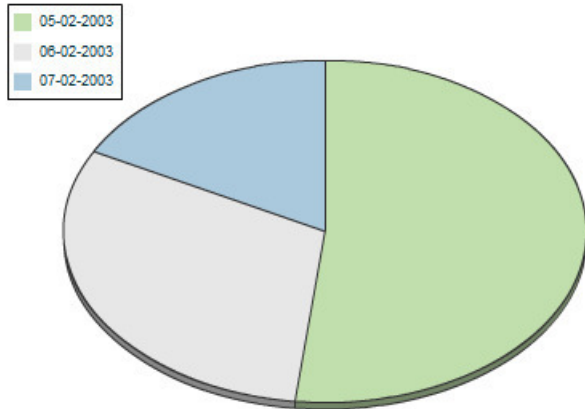

- Sample of a line, cluster, or stacked graph configuration - each with two series:

```

<html>
<head>
<title>Stacked Chart</title>
</head>
<body>

<div style="width:100%; height:300px;"
  oraChart="type:line;"
  oraChartSeries1="list:set; xaxis:date; label:Charge; amount:amount; "
  oraChartSeries2="list:set; xaxis:date; label:Balance; amount:balance; "
  oraChartBroadcast="BILL_ID:billId;">
</div>

<div style="width:100%; height:300px;"
  oraChart="type:cluster;"
  oraChartSeries1="list:set; xaxis:date; label:Charge; amount:amount; "
  oraChartSeries2="list:set; xaxis:date; label:Balance; amount:balance; "
  oraChartBroadcast="BILL_ID:billId;">
</div>

<div style="width:100%; height:300px;"
  oraChart="type:stacked;"
  oraChartSeries1="list:set; xaxis:date; label:Charge; amount:amount; "
  oraChartSeries2="list:set; xaxis:date; label:Balance; amount:balance; "
  oraChartBroadcast="BILL_ID:billId;">
</div>

</body>

<xml>
<root>
  <set>
<date>05-02-2003</date>
<amount>163.24</amount>
<balance>163.24</balance>
<billId>592211649441</billId>
  </set>
  <set>
<date>06-02-2003</date>

```

```
<amount>97.29</amount>
<balance>260.53</balance>
<billId>592211649442</billId>
  </set>
  <set>
<date>07-02-2003</date>
<amount>54.38</amount>
<balance>314.91</balance>
<billId>592211649443</billId>
  </set>
</root>
</xml>
</html>
```

- Three types of chart rendered for two series each: line, cluster, and stacked.

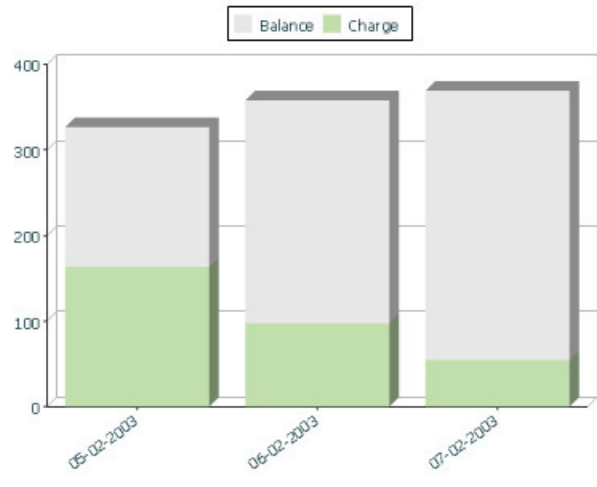
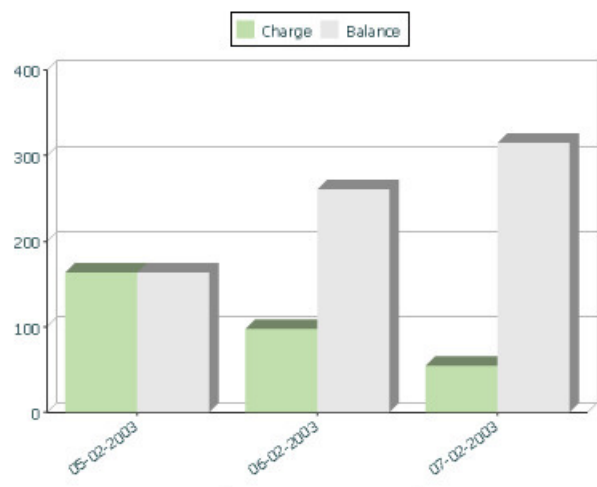

Upload and Download a CSV File

The following HTML attributes can be used to manage both an upload and a download between a list defined within the map's schema and a CSV (comma separated value) file. Note that this technique is only recommended for a small to medium volume of data, for example no more than several hundred rows. For higher volumes, it is recommended to use batch upload / download functionality instead.

The syntax is `oraUploadData="type:embed;path:list xpath;useLabels:true;showCount:true"`

Upload configuration requires you to name a CSV file to be uploaded, and an XML list as target. By convention, each CSV row will create a separate list instance. Each comma-separated field in the file will be uploaded as a separate element in the list. To embed an upload dialog within a map, the **oraUploadData** attribute must be associated with a container element such as a div, td, or span.

The optional **useLabels:true** value indicates that while parsing the upload CSV file, the headers are expected to be labels

NOTE: If you do not specify the **useLabels:true** value and the XML target element name is "camelCase" then the corresponding spreadsheet header should be title case with a space between words, e.g.;"Camel Case". Letters and special characters are not considered a different word, for example Address1 must be uploaded into the target XML element address1.

Specifying the optional **showCount:true** value will display the number of records uploaded.

CAUTION: If you are using a grid in conjunction with the **oraUploadData** function, then you must maintain the grid's list with a 'replace' business object action. Refer to [BO Replace Action](#) for more information.

Sample of **oraUploadData="embed"** within a div element.

```
<html>
<head>
  <title>File Upload</title>
</head>
<body>

  <div oraUploadData="type:embed;path:myList" > </div>

</body>

<xml>
<root>
  <myList>
<id>838383930</id>
  <name>Janice Smith</name>
  </myList>
  <myList>
<id>737773730</id>
  <name>Bill McCollum</name>
  </myList>
</root>
</xml>
</html>
```

This file upload dialog will be embedded into the body of the page where the oraUploadData is defined.

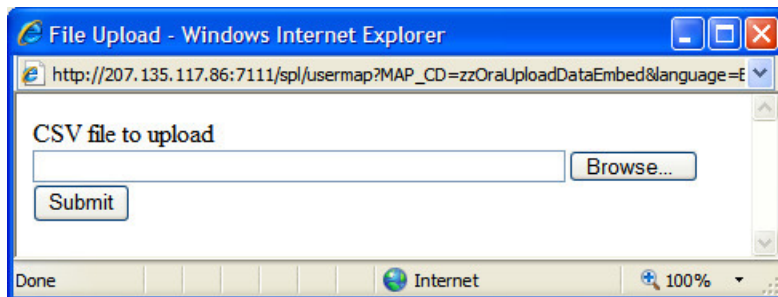

oraUploadData="type:popup;path:list xpath;useLabels:true;showOk:true;showCount:true"

Upload configuration requires you to name a CSV file to be uploaded, and an XML list as target. By convention, each CSV row will create a separate list instance. Each comma-separated field in the file will be uploaded as a separate element in the list. To upload a CSV file using a pop-up dialog, the oraUploadData attribute must be associated with an input element such as a button, text link, or image.

The optional useLabels:true value is used to indicate that while parsing the upload CSV file, the headers are expected to be labels

NOTE: If you do not specify the useLabels:true value and the XML target element name is "camelCase" then the corresponding spreadsheet header should be title case with a space between words, e.g., "Camel Case". Letters and special characters are not considered a different word, for example Address1 must be uploaded into the target XML element address1.

Specifying the optional showOk:true value will display an "Ok" button once the upload finishes. The popup will stay open until the button is pressed. Additionally, specifying the showCount:true value will display number of records uploaded.

CAUTION: If you are using a grid in conjunction with the **oraUploadData** function, then you must maintain the grid's list with a 'replace' business object action. Refer to [BO Replace Action](#) for more information.

Sample of oraUploadData="popup" associated with a button:

```
<html>
<head>
  <title>File Upload</title>
</head>
<body>
  <input type="button" name="submitButton" oraUploadData="type:popup;path:myList;" value='Get Data'>
  <table oraList="myList">
    <tr/>
    <tr>
      <td><span oraField="id" /></td>
      <td><span oraField="name" /></td>
    </tr>
  </table>
</body>
<xml>
<root>
  <myList>
    <id>838383930</id>
    <name>Janice Smith</name>
  </myList>
  <myList>
    <id>737773730</id>
    <name>Bill McCollum</name>
  </myList>
</root>
</xml>
</html>
```

HTML Rendered:

838383930 Janice Smith

737773730 Bill McCollum

Pressing the "Get Data" button will launch a standard file upload dialogue (provided by Framework) as shown below.

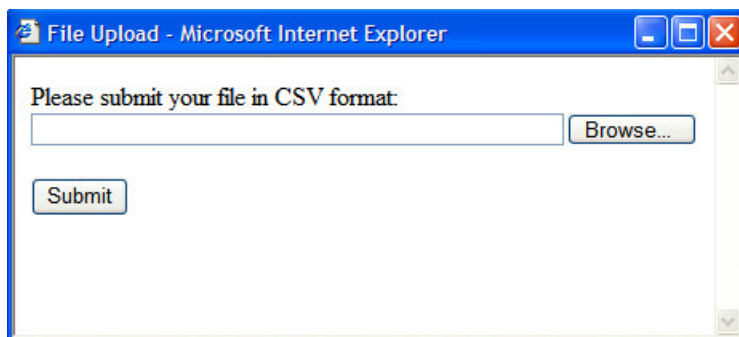

oraDownloadData="list xpath"

Download configuration requires you to name an XML list to be downloaded. By convention, each list instance will represent a separate row in the created file. By default every element of the list will be comma separated in the file.

NOTE: The number formatting is based on the user profile setting. For localities where the decimal symbol is a comma, an implementation may configure a property setting (`spl.csv.delimiter.useFromDisplayProfile=true`) to cause the system to use a semicolon as the delimiter that separates the elements rather than a comma.

Sample of oraDownloadData.

```
<html>
<head>
<title>File Download</title></head>
<body>
<input type="button" name="downloadButton" oraDownloadData="myList" value="Download" />
</body>
<xml>
<root>
  <myList>
    <id>881-990987</id>
    <name>John Mayweather</name>
  </myList>
  <myList>
    <id>229-765467</id>
    <name>Anna Mayweather</name>
  </myList>
  <myList>
    <id>943-890432</id>
    <name>Andrew Brewster</name>
  </myList>
</root>
</xml>
</html>
```

HTML Rendered:

Download

Pressing the "Download" button will launch a standard file download dialogue (provided by Framework) as shown below.

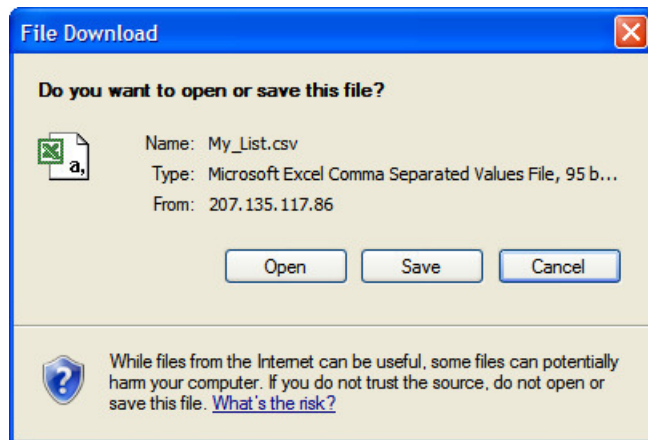

A successful download will result in a CSV file:

	A	B	C
1			
2	Id	Name	
3	881-99098	John Mayweather	
4	229-76546	Anna Mayweather	
5	943-89043	Andrew Brewster	
6			

To download data from a sub list use the attribute `oraDownloadDataInList` instead of `oraDownloadData`. The attribute `oraDownloadDataInList` will have the sub list name. The XPath of the sub list is used to pick data of the specific row from the parent list. Thus only the specific sub list is downloaded.

`oraDownloadDataUseLabels="true"`

The `oraDownloadDataUseLabels` attribute can be used in conjunction with the `oraDownloadData` attribute described above. Specify `oraDownloadDataUseLabels` if you want the generated CSV file to use the element labels for columns headers rather than element names.

Construct Portal Zone Map Fragments

Portal zones can reference a UI map for the zone header and filter area. This UI map is not a complete HTML document, but is instead configured as a UI Map fragment. When constructing a zone map fragment you can reference the following substitution variables. Note that these variables will be dynamically populated at run time with information particular to the map's zone within the portal:

Variable	Replacement Logic
[\$ZONEDESCRIPTION]	Zone's description text.
[\$SEQUENCEID]	Zone's sequence ID.
[\$ZONENAME]	Zone's name.
[\$HELPTEXT]	Zone's help text.
[\$ZONEPARAMNAME]	Zone parameter's value (or blank if it has not been specified).

WARNING:

- Refer to one of the following maps as examples: F1-UIMapHeader and F1-ExplorerHeader.
- These maps make use of the [oraInclude](#) tag to incorporate HTML fragments for the header menu and framework actions. Refer to the zone type parameters for the UI Map fragments you should include in your HTML.
- If you wish to have the "help text" icon appear next to your zone description, you should have `id="title_[$SEQUENCEID]"` on the `<td>` that contains your description.
- If it is necessary to encapsulate JavaScript within a UI Map fragment, it will be necessary to bound the JavaScript within a `![CDATA[]]` tag to ensure a valid XML document. Note that the tags themselves may need to be commented out to promote compatibility with older browsers. For example:

```
<script type="text/javascript">
  /* */
  //
  //javascript
  //
  /*]]&gt; */
&lt;/script&gt;</pre>
</div>
<div data-bbox="467 942 913 959" data-label="Page-Footer">
<p>Oracle Utilities Customer to Meter Administrative User Guide • 243</p>
</div>
```

NOTE: If you wish to preserve the values of a filter input field, within a filter map fragment, for the framework 'Go Back' and 'Go Forward' functionality, you must associate the input field (text box, select, etc.) with a unique HTML id. Input field values associated with a unique id will be captured in the framework's 'memento'. The 'memento' is used to rebuild the input map when the portal zone is navigated to using the 'Go Back' or 'Go Forward' functionality.

NOTE: Many specialized functions exist to manipulate zone behavior, for example:

- **oraGetZoneSequence(zoneName).** Uses the zone's code to retrieve its sequence number.
- **oraIsZoneCollapsed(sequenceId).** Uses the zone's sequence to determine if collapsed.
- **oraHandleCollapse(seq).** Collapse a zone.
- **oraHandleExpand(seq,refresh).** Expand and/or refresh a zone.

All of these, and many more functions, are located within the JavaScript library [userMapSupport.js](#) described below.

NOTE: When executing oraLoad within a fragment UI map, and you need to execute a JavaScript function during page load (where the function invokes a business object, business service, or service script) you can use the special syntax "oraLoad[\$SEQUENCEID]". Refer to the [Load Page Event](#) section for more information.

Example of oraLoad[\$SEQUENCEID] used within a function:

```
<script type="text/javascript">
function oraLoad[$SEQUENCEID]() {
checkRebateClaimStatus();
}

function checkRebateClaimStatus() {
    var work = id('analyticsFilterText[$SEQUENCEID]',
document).cells[0].innerText.split(' ');
    var rebateClaimId = work[work.length - 3];
    id('rebateClaimId', document).value = rebateClaimId;
oraInvokeSS('C1-CheckRCSt','checkRebateClaimStatus', false);
    var statusIndicator = id('statusInd', document).value;
    if (statusIndicator == 'C1PE' || statusIndicator == 'C1ID') {
        id('addRebateClaimLine', document).style.display = '';
    } else {
id('addRebateClaimLine', document).style.display = 'none';
    }
}
</script>
```

F1-ExplorerHeader rendered:

 [\$ZONEDESCRIPTION]



Invoking a Business Object

The oraInvokeBO function may be used within a portal zone header or zone filter map. It is similar to the command described in [Invoke BO Function](#) which allows for a business object to be invoked within the UI map's HTML. Refer to that section for a description of the first three parameters.

Syntax	Parameters	Comments
oraInvokeBO()	'BO Name'	
	'XPath' or null	
	'action'	
	null	This must be specified as the fourth argument.

Syntax	Parameters	Comments
	[\$SEQUENCEID]	This must be specified as the fifth argument.
	true false	Specify true if the fragment is used within a portal zone header. Specify false if the fragment is used with a zone filter map.

Example in a portal zone header:

```
oraInvokeBO('CM-User','xmlGroup','read', null, [$SEQUENCEID], true)
```

Invoking a Business Service

The oraInvokeBS function may be used within a portal zone header or zone filter map. It is similar to the command described in [Invoke BS Function](#) which allows for a business service to be invoked within the UI map's HTML. Refer to that section for a description of the first two parameters.

Syntax	Parameters	Comments
oraInvokeBS()	'BO Name'	
	'XPath' or null	
	null	This must be specified as the fourth argument.
	[\$SEQUENCEID]	This must be specified as the fifth argument.
	true false	Specify true if the fragment is used within a portal zone header. Specify false if the fragment is used with a zone filter map.

Example in a portal zone header:

```
oraInvokeBS('CM-UserSearch','xmlGroup', null, [$SEQUENCEID], true)
```

Invoking a Service Script

The oraInvokeSS function may be used within a portal zone header or zone filter map. It is similar to the command described in [Invoke SS Function](#) which allows for a service script to be invoked within the UI map's HTML. Refer to that section for a description of the first two parameters.

Syntax	Parameters	Comments
oraInvokeSS()	'Service Script Name'	
	'XPath' or null	
	null	This must be specified as the fourth argument.
	[\$SEQUENCEID]	This must be specified as the fifth argument.
	true false	Specify true if the fragment is used within a portal zone header. Specify false if the fragment is used with a zone filter map.

Example in a portal zone header:

```
oraInvokeSS('UserSearch','xmlGroup', null, [$SEQUENCEID], true)
```

Detecting Unsaved Changes

Use this function to return a Boolean set to true if there are unsaved changes. The system will interrogate the function when the user attempts to navigate and issue a warning accordingly. This function is only needed if a UI map is using custom javascript to manage elements such that the system is not able to detect whether changes have been made. Also note that it's the responsibility of the UI map javascript to manage the values in the Boolean used for this function.

```
function hasUnsavedChanges(){
    return isDirtyFlag;
}
```

Hiding Portal Tabs

The product provides the ability to use JavaScript to hide a tab on the current portal based on some condition using the oraAuthorizeTab JavaScript API. This API accepts a function as a parameter and turns off the tab index indicated.

For example, the UI Map may have a function to turn off one or more tab indexes.:

```
function overrideTabIndex(index){
    if (index == 2) return false;
    if (index == 3) return false;
}
```

The JavaScript is referenced "on load":

```
<body class="oraZoneMap"
onLoad="oraAuthorizeTabs(overrideTabIndex);">
```

Required JavaScript Libraries

All of the functionality described in this document depends on a pair of JavaScript libraries. If you are writing and executing your maps entirely within the UI map rendering framework - you do not need to manually insert the following libraries - the framework will insert them for you when the UI Map is rendered.

WARNING: When executing HTML outside of the framework you must include the following references explicitly within your HTML. In addition, the tool you use to render the HTML must have access to a physical copy of privateUserMapSupport.js for bind support.

```
src="privateUserMapSupport.js"
```

Your HTML document must reference this library to execute binding in a stand-alone environment.

WARNING: Referencing functions within this JavaScript library is dangerous - because these functions are owned by framework and they may be changed during version upgrade or via the normal patch process.

```
<script type="text/javascript" src="privateUserMapSupport.js"></script>
```

```
src="userMapSupport.js"
```

To take advantage of optional toolset features, you must reference this library.

NOTE: You can reference the functions within this JavaScript library to write custom functions within the UI map..

```
<script type="text/javascript" src="userMapSupport.js"></script>
```

```
onload="oraInitializeUserMap();"
```

To execute binding in a stand-alone environment, you must embed the following onload function into the <body> node.

```
<body onload="oraInitializeUserMap();">
```

UI Map Standards

Contents

- [Basic UI Map Templates](#)
- [Basic HTML and Styles](#)
- [Grids \(Tables of Data\)](#)
- [Action Buttons](#)
- [Available Styles](#)
- [Using OJET](#)

Basic UI Map Templates

All UI Maps share the same basic structure regardless of placement (page area, zone, pop-up) or usage (display only, input).

Sample XML

All information in this document is based upon the following XML structure.

```
<xml>
  <root>
    <address>123 Main St</address>
    <city>Alameda</city>
    <state>CA</state>
    <zip>94770</zip>
    <contactInformation>
      <type>Home Phone</type>
      <number>510-555-2287</number>
    </contactInformation>
    <contactInformation>
      <type>Cell Phone</type>
      <number>510-555-4285</number>
    </contactInformation>
  </root>
</xml>
```

Display Only UI Map

```
<html>
<head>
  <title oraMdLabel="ADDRESS_LBL"></title>
  <link rel="stylesheet" type="text/css" href="cisDisabled.css"/>
  <link rel="stylesheet" type="text/css" href="cisEnabled.css"/>
</head>
<body class="oraZoneMap">
<table cellpadding="4" cellspacing="4" width="100%">
  <colgroup>
    <col class="oraLabel oraTableLabel" />
    <col class="oraNormal oraTableData" />
  </colgroup>
  <tr>
    <td oraLabel="address"></td>
    <td oraField="address"></td>
  </tr>
  <tr>
    <td oraLabel="city"></td>
    <td oraField="city"></td>
  </tr>
  <tr>
    <td oraLabel="state"></td>
    <td oraField="state"></td>
  </tr>
  <tr>
    <td class="oraSectionEnd" oraLabel="zip"></td>
    <td class="oraSectionEnd" oraField="zip"></td>
  </tr>
</table>
```

```

        <td colspan="2" class="oraSectionHeader" oraMdLabel="CONTACT_LBL"></td>
</tr>
<tr>
    <td colspan="2" class="oraSectionStart oraEmbeddedTable">
        <table oraList="contactInformation" cellspacing="2">
            <thead >
                <tr>
                    <th class="oraGridColumnHeader" nowrap="nowrap">
                        <span oraLabel="contactInformation/type"></span>
                    </th>
                    <th class="oraGridColumnHeader" nowrap="nowrap">
                        <span oraLabel="contactInformation/number"></span>
                    </th>
                </tr>
            </thead >
            <tbody>
                <tr>
                    <td class="oraNormalAlt oraDisplayCell">
                        <span oraField="type"></span>
                    </td>
                    <td class="oraNormal oraDisplayCell">
                        <span oraField="number"></span>
                    </td>
                </tr>
            </tbody>
        </table>
    </td>
</tr>
</table>
</body>
<xml>
    <root>
        <address>123 Main St</address>
        <city>Alameda</city>
        <state>CA</state>
        <zip>94770</zip>
        <contactInformation>
            <type>Home Phone</type>
            <number>510-555-2287</number>
        </contactInformation>
        <contactInformation>
            <type>Cell Phone</type>
            <number>510-555-4285</number>
        </contactInformation>
    </root>
</xml>
</html>

```

Input UI Map

```

<html>
<head>
    <title oraMdLabel="ADDRESS_LBL"></title>
    <link rel="stylesheet" type="text/css" href="cisDisabled.css"/>
    <link rel="stylesheet" type="text/css" href="cisEnabled.css"/>
</head>
<body>
<table width="100%" cellpadding="12">
    <tr class="oraErrorText">
        <td><a href="" onclick="oraShowErrorAlert(); return false;">
            <span class="oraErrorText" oraErrorVar="ERRMSG-TEXT"></span></a>
        </td>
    </tr>
</table>
<table cellspacing="4" width="100%">
    <colgroup>
        <col class="oraLabel oraTableLabel" />
        <col class="oraNormal oraTableData" />
    </colgroup>
    <tr>
        <td oraLabel="address"></td>
        <td><input type="text" oraField="address"/></td>
    </tr>

```

```

</tr>
<tr>
  <td oraLabel="city"></td>
  <td><input type="text" oraField="city"/></td>
</tr>
<tr>
  <td oraLabel="state"></td>
  <td><input type="text" oraField="state"/></td>
</tr>
<tr>
  <td oraLabel="zip"></td>
  <td><input type="text" oraField="zip"/></td>
</tr>
<tr>
  <td colspan="2" class="oraSectionHeader" oraMdLabel="CONTACT_LBL"></td>
</tr>
<tr>
  <td colspan="2" class="oraSectionStart oraEmbeddedTable">
    <table oraList="contactInformation" cellspacing="2">
      <thead >
        <tr>
          <th class="oraGridColumnHeaderButton"></th>
          <th class="oraGridColumnHeaderButton"></th>
          <th class="oraGridColumnHeader" nowrap="nowrap">
            <span oraLabel="contactInformation/type"></span>
          </th>
          <th class="oraGridColumnHeader" nowrap="nowrap">
            <span oraLabel="contactInformation/number"></span>
          </th>
        </tr>
      </thead >
      <tbody>
        <tr>
          <td oraType="addGridRow"></td>
          <td oraType="deleteGridRow"></td>
          <td>
            <input type="text" oraField="type"/>
          </td>
          <td>
            <input type="text" oraField="number"/>
          </td>
        </tr>
      </tbody>
    </table>
  </td>
</tr>
<tr>
  <td colspan="2" class="oraSectionStart oraEmbeddedTable">
    <table cellspacing="2">
      <tr>
        <td>
          <input class="oraButton" oraMdLabel="C1_SAVE_LBL" type="button"
            onClick="oraSubmitMap('OK');"/>
        </td>
        <td>
          <input class="oraButton" oraMdLabel="CANCEL_LBL" type="button"
            onClick="oraSubmitMap('CANCEL',false);"/>
        </td>
      </tr>
    </table>
  </td>
</tr>
</table>
</body>
<xml>
  <root>
    <address>123 Main St</address>
    <city>Alameda</city>
    <state>CA</state>
    <zip>94770</zip>
    <contactInformation>
      <type>Home Phone</type>
    </contactInformation>
  </root>

```

```
        <number>510-555-2287</number>
    </contactInformation>
</contactInformation>
    <type>Cell Phone</type>
    <number>510-555-4285</number>
</contactInformation>
</root>
</xml>
</html>
```

Basic HTML and Styles

The basic templates introduced the standard HTML and styles used for UI Maps. These standards are described individually in the following sections.

Stylesheets

The styles to apply the standard look to the maps are all contained in stylesheets. These stylesheets should be included in all UI Maps.

```
...
    <link rel="stylesheet" type="text/css" href="cisDisabled.css"/>
    <link rel="stylesheet" type="text/css" href="cisEnabled.css"/>
...
```

Title

Each UI Map should have a <title> tag.

```
...
    <title oraMdLabel="ADDRESS_LBL"></title>
...
```

This will give the UI Map a descriptive title.

- If the UI Map is presented in a "pop-up", the title will be in the window title bar.
- If the UI Map is presented in the page area, the title will be added as a tag to the UI Map and will appear at the top of the UI Map.
- If the UI Map is presented as a zone map, it will be ignored. The <title> tag should still be included in the HTML as standard.

Zone Maps

When the map is presented in a zone as part of a portal, the UI Map should have a border so that the information is "contained" within the zone.

```
...
    <body class="oraZoneMap">
...
```

Page Area Maps vs Pop-Up Maps

The presentation of the UI Maps can vary from design to design. The following standards have been applied to decide when to use a Page Area UI Map and when to use a Pop-Up Map:

- If there are multiple UI Maps in the sequence, always use the Page Area.
- If the UI Map has many input fields, always use a Page Area.
- If the UI Map is a "confirmation" type dialog or only has one or two input fields, use a Pop-Up.

NOTE: The difference between "just a few input fields" and "many input fields" can be discretionary. The final decision should rest with the dialog designer.

Error Messages

Input maps have a ability to present error messages to the User.

```
...
<table width="100%" cellpadding="12">
  <tr class="oraErrorText">
    <td><a href="" onclick="oraShowErrorAlert(); return false;">
      <span class="oraErrorText" oraErrorVar="ERRMSG-TEXT"></span></a></td>
    </tr>
  </table>
...
```

This HTML structure provides the necessary elements and functions to display errors to the User. It should be directly after the <body> tag. When there is no error, nothing will be visible on the UI Map. It will be made visible if an error occurs and the UI Map is re-presented to the User. Clicking on the link (when visible) will result in a pop-up alert appearing with the long error message text.

Standard Layout and Styles

The information is presented on the UI Map by using a <table> to organize the information in rows and columns.

```
...
<table cellspacing="4" width="100%">
<colgroup>
<col class="oraLabel oraTableLabel" />
  <col class="oraNormal oraTableData" />
</colgroup>
...
```

The <colgroup> and <col> tags allow for the application of classes to the columns (the label is in the first column and the data is in the second column.). Using these tags mean that the class attribute (to apply styles) does not need to be defined on every <td>.

Grids (Tables of Data)

A UI Map could contain information that is best presented as a grid. These are referred to as "Embedded Tables". The embedded table can be used to display information or input information.

Example Embedded Table HTML

The embedded table will be included within a row (<tr>) of the basic layout:

```
...
<tr>
  <td colspan="2" class="oraEmbeddedTable">
    <table oraList="contactInformation" cellspacing="2">
      <thead >
        <tr>
          <th class="oraGridColumnHeader" nowrap="nowrap">
            <span oraLabel="contactInformation/type"></span>
          </th>
          <th class="oraGridColumnHeader" nowrap="nowrap">
            <span oraLabel="contactInformation/number"></span>
          </th>
        </tr>
      </thead >
      <tbody>
        <tr>
          <td class="oraNormalAlt oraDisplayCell">
            <span oraField="type"></span>
          </td>
          <td class="oraNormal oraDisplayCell">
            <span oraField="number"></span>
          </td>
        </tr>
      </tbody>
    </table>
  </td>
</tr>
```

```

    </td>
</tr>
...
<xml>
  <root>
    <address> 123 Main St</address>
    <city>Alameda</city>
    <state>CA</state>
    <zip>94770</zip>
    <contactInformation>
      <type>Home Phone</type>
      <number>510-555-2287</number>
    </contactInformation>
    <contactInformation>
      <type>Cell Phone</type>
      <number>510-555-4285</number>
    </contactInformation>
  </root>
</xml>

```

Embedding the Table

The embedded table is included within the overall table structure. The `colspan` attribute ensures that the embedded table can span the standard two columns of the overall layout table.

```

...
<tr>
  <td colspan="2" class="oraEmbeddedTable">
    ...
    ...
    ...
  </td>
</tr>
...

```

Embedded Table Structure

The embedded table is very similar to the basic layout table.

```

...
<table oraList="contactInformation" cellpadding="2">
<thead>
  ...
  ...
</thead>
<tbody>
  ...
  ...
</tbody>
</table>
...

```

- The `<table>` tag has a slightly smaller cellpadding and it defines the "list" element contained in the XML that will be used to provide the data.
- The `<thead>` element is used to give the embedded table headings for the columns.
- The `<tbody>` element is the element that will be repeated for each referenced "list" element in the XML. In the previous example, there are two "contactInformation" list elements, so the displayed embedded table will have two rows.

Column Headings

Embedded tables should have headings for the displayed columns. The `<thead>` tag defines these.

```

...
<thead>
  <tr>
    <th class="oraGridColumnHeader" nowrap="nowrap">
      <span oraLabel="contactInformation/type"></span>
    </th>

```

```

        <th class="oraGridColumnHeader" nowrap="nowrap">
            <span oraLabel="contactInformation/number"></span>
        </th>
    </tr>
</thead>
...

```

The "nowrap" attribute prevent the column heading from taking multiples lines. If multiples lines are required, the "nowrap" may be removed.

Input Fields

Embedded tables may be used for input as well as display only. The framework provides a convenient control to assist in the creation of editable embedded tables.

```

...
<tr>
    <td colspan="2" class="oraEmbeddedTable">
        <table oraList="contactInformation" cellspacing="2">
            <thead >
                <tr>
                    <th class="oraGridColumnHeaderButton"></th>
                    <th class="oraGridColumnHeaderButton"></th>
                    <th class="oraGridColumnHeader" nowrap="nowrap">
                        <span oraLabel="contactInformation/type"></span>
                    </th>
                    <th class="oraGridColumnHeader" nowrap="nowrap">
                        <span oraLabel="contactInformation/number"></span>
                    </th>
                </tr>
            </thead >
            <tbody>
                <tr>
                    <td oraType="addGridRow"></td>
                    <td oraType="deleteGridRow"></td>
                    <td>
                        <input type="text" oraField="type" />
                    </td>
                    <td>
                        <input type="text" oraField="number" />
                    </td>
                </tr>
            </tbody>
        </table>
    </td>
</tr>
...

```

There are two new columns added to the input embedded table.

- oraType="addGridRow" will add a "+" button to the row. This will allow the User to add an additional row to the existing grid.
- oraType="deleteGridRow" will add a "-" button to the row. This will allow the User to delete an existing row from the grid.

NOTE: The <thead> tag also requires these two new columns to be added.

These controls are, as standard, placed at the beginning of the row in the order shown. Either of the controls may be omitted if required (if, for example, Users are not permitted to delete information).

The presence of either of these controls will activate the "empty list" process. This means that if the XML has no data for the "list" specified, the input grid will display with an empty row ready for the input of new information.

Action Buttons

Example Action Button HTML

Action buttons are used to perform some specified function from the UI Map. The actions are as varied as the information being displayed/updated. Below are two common examples:

- Save. Normally used on an Input UI Map to allow a User to save any changes they have made.
- Cancel. Normally used on an Input UI Map to allow a User to cancel changes in progress.

```
...
<tr>
  <td colspan="2" class=" oraEmbeddedTable">
    <table cellspacing="2">
      <tr>
        <td>
          <input class="oraButton" oraMdLabel="C1_SAVE_LBL" type="button"
            onClick="oraSubmitMap( 'OK' );"/>
        </td>
        <td>
          <input class="oraButton" oraMdLabel="CANCEL_LBL" type="button"
            onClick="oraSubmitMap( 'CANCEL' ,false);"/>
        </td>
      </tr>
    </table>
  </td>
</tr>
...
```

Button Standards

The following points highlight some standards related to buttons.

- Buttons are included as an embedded table.
- Buttons should be grouped together. They should not be placed in different areas of the UI Map.
- The location of the buttons depends mainly on the type of UI Map.
 - Display Only UI Maps should have a Record Actions section in the upper right section of the UI map.
 - Input UI Maps should have the buttons at the foot of the UI Map (after all input fields).

Available Styles

Styles are all contained in the referenced CSS stylesheets. They are applied by the HTML "class" attribute. The actual style settings used are not documented here as they may be adjusted. This section only specifies when a particular style should be used.

NOTE: The "class" attribute may reference more than one style (class="oraLabel oraSectionEnd")

Style	Comments	Example
oraButton	Applied to <input> elements where the type is button.	... <input class="oraButton" oraMdLabel="CANCEL_LBL" type="button" onClick="oraSubmitMap('CANCEL' ,false);"/> ...
oraDisplayCell	Applied to the <td> tag of an embedded table. It defines how the table cell looks (not the data contained inside the cell).	... <td class="oraDisplayCell"> </td>

Style	Comments	Example
oraEmbeddedTable	Applied to the <td> tag that will contain the embedded table.	<pre> ... <tr> <td colspan="2" class=" oraEmbeddedTable"> <table cellpadding="2"> </table> </td> </tr> ... </pre>
oraError	<p>This style is applied to elements that are identified as "error elements". Refer to Display Errors for more information.</p> <p>NOTE: This style is not normally applied directly in the UI Map HTML</p>	
oraErrorText	This style is applied to the elements concerned with error messages.	<pre> ... <table width="100%" cellpadding="12"> <tr class="oraErrorText"> <td> </td> </tr> </table> ... </pre>
oraGridColumnHeader	This style is applied to the <td> tags that define column headers within embedded table.	<pre> ... <thead > <tr> <th class="oraGridColumnHeaderButton"></th> <th class="oraGridColumnHeaderButton"></th> <th class="oraGridColumnHeader" nowrap="nowrap"> </th> <th class="oraGridColumnHeader" nowrap="nowrap"> </th> </tr> </thead > ... </pre>
oraGridColumnHeaderButton	This style is applied to the <td> tags that define the column headers for the "+" and "-" buttons used on editable embedded tables.	<pre> ... <thead > <tr> <th class="oraGridColumnHeaderButton"> </th> <th class="oraGridColumnHeaderButton"> </th> <th class="oraGridColumnHeader" nowrap="nowrap"> </th> <th class="oraGridColumnHeader" nowrap="nowrap"> </th> </tr> </thead > ... </pre>
oraInput	<p>This style is applied to input fields:</p> <ul style="list-style-type: none"> <input type="text"> 	<pre> ... <input type="text" class="oraInput" oraField="address" /> ... </pre>

Style	Comments	Example
	<ul style="list-style-type: none"> • <input type="checkbox"> • <select> • <textarea> <p>NOTE: This can normally be omitted as input styles are applied automatically when oraSchemaDataTypes="true".</p>	
oraInputMoney	<p>This style is applied to input fields:</p> <ul style="list-style-type: none"> • <input type="text"> • <select> (rare) • <textarea> (not recommended) <p>NOTE: This can normally be omitted as input styles are applied automatically when oraSchemaDataTypes="true".</p>	<pre>... <input type="text" class="oraInputMoney" oraField="amount" /> ...</pre>
oraInputNumber	<p>This style is applied to input fields:</p> <ul style="list-style-type: none"> • <input type="text"> • <select> (rare) • <textarea> (not recommended) <p>NOTE: This can normally be omitted as input styles are applied automatically when oraSchemaDataTypes="true".</p>	<pre>... <input type="text" class="oraInputNumber" oraField="count" /> ...</pre>
oraLabel	<p>This style is applied to standard label fields that are right aligned.</p> <p>NOTE: This can normally be omitted as it is applied by the <col> tag.</p>	<pre>... <td class="oraLabel" oraLabel="address"></td> ...</pre>
oraLabelAlt	<p>This style is applied to standard label fields only if it is desired to have the label aligned to the left.</p>	<pre>... <td class="oraLabelAlt" oraLabel="address"></td> ...</pre>
oraLabelCenter	<p>This style is applied to standard label fields only if it is desired to have the label aligned in the center of the cell.</p>	<pre>... <td class="oraLabelCenter" oraLabel="address"></td> ...</pre>
oraLink	<p>This style is applied to foreign key references (links). This is automatically added by the UI Map framework but can also be used manually if desired.</p>	<pre>... <td class="oraLabel"> Google</td> ...</pre>
oraNormal	<p>This style is applied to standard data fields (display only) that are left aligned.</p>	<pre>... <td class="oraNormal" oraField="address"></td> ...</pre>

Style	Comments	Example
	<p>NOTE: This can normally be omitted as it is applied by the <col> tag.</p>	
oraNormalAlt	This style is applied to standard data fields (display only) only if it is desired to have the data aligned to the right.	<pre>... <td class=" oraNormalAlt" oraField="address"></td> ...</pre>
oraNormalCenter	This style is applied to standard data fields (display only) only if it is desired to have the data aligned in the center of the cell.	<pre>... <td class=" oraNormalCenter" oraField="address"></td> ...</pre>
oraPageTitle	<p>This style is applied to the element that contains the page title.</p> <p>NOTE: This style is not normally applied directly in the UI Map HTML. The is created by the UI Map framework when the UI Map is displayed in the page area.</p>	<pre>... ...</pre>
oraSectionEnd	<p>This style is applied to the <td> tags at the end of a "section" (group of elements). It provides some space to separate the section from the following information.</p> <p>NOTE: The style must be applied to both <td> tags or the label may be misaligned with the data/input.</p>	<pre>... <tr> <td class="oraSectionEnd" oraLabel="zip"> </td> <td class="oraSectionEnd" oraField="zip"> </td> </tr> ...</pre>
oraSectionHeader	<p>This style is applied to the <td> tag used to give a heading for a section within the information being displayed. It does not provide spacing before or after itself. The oraSectionStart and oraSectionEnd classes are used for this.</p> <p>NOTE: The section header should span both the label column and the data column.</p>	<pre>... <tr> <td class="oraSectionHeader" colspan="2" oraMdField="DATA_SECTION_LBL"></td> </tr> ...</pre>
oraSectionStart	<p>This style is applied to the <td> tags at the start of a "section" (group of elements). It provides some space to separate the section from the previous information (often a section header).</p> <p>NOTE: The style must be applied to both <td> tags or the label may be misaligned with the data/input.</p>	<pre>... <tr> <td class="oraSectionStart" oraLabel="zip"></td> <td class="oraSectionStart" oraField="zip"></td> </tr> ...</pre>
oraTableData	This style is applied to the <col> tag for the data column of the main table (second column). It is used to provide a percentage width for the horizontal space to be used for the information.	<pre>... <colgroup> <col class="oraLabel oraTableLabel" /> <col class="oraNormal oraTableData" /> </colgroup> ...</pre>
oraTableLabel	This style is applied to the <col> tag for the label column of the main table (first column). It is used	<pre>... <colgroup> <col class="oraLabel oraTableLabel" /> <col class="oraNormal oraTableData" /> </colgroup> ...</pre>

Style	Comments	Example
	to provide a percentage width for the horizontal space to be used for the labels.	<pre><col class="oraNormal oraTableData" /> </colgroup> ...</pre>
oraTinyText	This style is typically applied directly beneath an <input> tag to provide information or a hint to the user concerning information relevant to the input. For example, name or address format.	<pre>... <tr> <td oraLabel="address"></td> <td> <input type="text" oraField="address" /> <div class="oraTinyText" oraField="addressFormatHint"></div> </td> </tr> ...</pre>
oraZoneMap	This style is used applied when the UI Map is to be displayed as a zone on a portal.	<pre>... <body class="oraZoneMap"> ...</pre>

Using OJET

There are some UI maps delivered by the product that use UI widgets provided by Oracle JavaScript Extension Toolkit (OJET). Releases for OJET do not always align with releases of the framework. In addition, there are times when OJET adjusts APIs that the product uses. The framework will attempt to ensure that each release of the product has the latest and greatest version of the OJET libraries. Implementations are discouraged from attempting to use features in OJET that are not used by the product because the product is not necessarily testing those features and is not ensuring that upgrades to the APIs for those features are backward compatible.

Note that the product isolates the references to OJET into a UI map fragment that is included in the maps that use OJET widgets. This is so that changes to future versions of OJET are minimized to a single place. The map is called F1-OJETLIBS. If your implementation wants to use OJET, the recommendation is to use this UI map fragment.

Ensuring Unique Element IDs for UI Maps

The following describes how to modify JavaScript code to ensure the proper rendering of unique element IDs for UI Maps.

The modification is required only for code that renders HTML using a `getElementById()` (or similar) function to generate list IDs and avoid account verification or related errors.

The following sample snippet contains the necessary modifications:

```
...
function getElementsFromList(namePrefix) {
  var ret = [];
  var elements = document.getElementsByTagName("INPUT");
  for(var i=0;i<elements.length;i++) {
    var elemID = elements[i].id;
    if((id) && (id.startsWith(namePrefix + '_'))) {
      ret.push(elements[i]);
    }
  }
  ...
  return ret;
}
```

Since IDs aren't necessarily unique in generated UI Map IDs, the code shown above ensures uniqueness at runtime by appending an underscore and row number (e.g., `myField_1`, `myField_2`) for proper handling by Framework in the rendered HTML, while still allowing you to reference the unmodified IDs contained in the generated UI Map.

A switch in the `spl.properties` file also permits you to disable the generation of unique IDs for elements in a grid (as described below), though, for standards compliance reasons, it is highly recommended that this switch be left at its default value.

```
Property Name: spl.runtime.compatibility.uiMapDisableGenerateUniqueHtmlIDs
File Name: spl.properties (under web project in FW)
Default Value: false
Accepted Values: true or false
Description: This property controls the generation of unique IDs for all input elements inside
a list. When this value is set to true it disables the generation of unique IDs, thus
replicating the old behavior. When this property is set to false or this property is missing
it enables the generation of unique IDs, thus enabling the list to be standards-compliant.
```

Process Flows

This section describes concepts and provides guidelines related to the configuration of various type of process flows.

Understanding Process Flows

A process flow is a user interface guiding a user through a series of actions in order to accomplish a specific task. The task can be as simple as the collection of information in order to update business data or involve more complex logic such as submitting and tracking batch processes, exchanging messages with an external system, etc.

This section describes topics related to designing and working with process flows.

A Process Flow Is Made Of Panels

Each process flow consist of a number of sequential "steps" needed to accomplish a certain task. Each step is represented by a stop on a progress bar and an associated panel.

Progress is linear in that each step may only lead to a single next step. A process flow always starts at a single initial step but allows for one or more final steps at which the user may choose to complete the process.

At any step the user may take the following actions:

- Enter data or take action as prompted by the step's panel.
- Continue to a next step, if any.
- Navigate back to any step they have previously visited.
- Finish the process flow if the current step is a final step.
- Save off their work on the process flow and either continue their work or navigate away. At a later time the user may resume their work on the process flow from where they have left off.
- Cancel the process flow.

A process flow type defines the entire metadata needed to control the behavior of process flows of a given type. This includes the sequence of steps, the panel and rules associated with each step and more.

Panel Presentation

The panel presented on each step of the process flow is rendered based on the panel type selected on the step configuration.

For a **Data Area** type of panel, the panel is rendered using UI Hints built into the schema of a specified data area.

For a **UI Map** type of panel, the panel is rendered using a specified UI map fragment.

For a **Panel Set** type of panel, the panel is rendered as a set of tabs, one for each panel that references the current panel as its parent panel. Clicking on each tab renders the UI based on the selected panel's type. The behavior of a panel set is analogous to or can be thought of as a nested process flow within a single panel. A panel set may not include another panel set.

A Single UI Map

While the user enters data one panel at a time, data is collected and captured at the entire process flow level. All the elements edited and displayed on the various panels of the process flow must be included in the overall process schema and referenced by their appropriate XPath location in that schema. Each type of process flow defines its unique schema on a designated UI map.

The UI map's HTML should simply include the **Process Flow Controller (F1-ProcessController)** UI map fragment and nothing else. The latter is designed to render the user interface for a process flow based on the metadata defined on its process flow type.

Panel Scripts

A single **Pre-Processing** service script may be associated with a panel for the purpose of preparing the data before the panel is presented to the user. The system calls the script each time the user navigates to this panel on a non-finalized process flow.

A single **Post-Processing** service script may be associated with a panel for the purpose of validating the data entered by the user on that panel. The system calls the script each time the user exits the panel on a non-finalized process flow.

Process Flow Scripts

A single **Process Start** service script may be associated with a process flow for the purpose of preparing the data before a newly initiated process flow is presented to the user.

A single **Process End** service script is executed when the user clicks on the **Finish** or **Cancel Process** buttons to complete the process flow. The entire set of data collected by the process flow UI map schema is provided to this service script for final processing.

NOTE: The schema of these scripts should be the same as the **Process Flow UI map** schema. This would ensure that business rules have access to the entire data captured by the user.

Summary Panel

By default, when a user finishes a process flow, as well as when they view an already closed process, the process flow portal displays the last panel the user was working on. For more complex process flows, you may provide a panel that summarizes information from the entire process. When specified on the process flow type, the system displays that summary panel instead of the default view of a closed process. The user may toggle between the summary view and the detailed view at any time.

The summary panel may be implemented as a UI map fragment or a data area like other panels but may not be associated with any panel script.

Launching A New Process Flow

Each process flow must be initiated and executed by a designated BPA script that has the following simple steps:

- Set BPA area height to zero.
- Populate the temporary variable **\$processCode** with the code of the specific process flow type.
- Transfer control to the **Process Flow Navigation (F1-PROCEXEC)** common BPA script.

Launching a process flow of a specific type is assumed to be made from a designated menu option or within a specific context applicable to that type of work. As such, this item needs to be configured specifically for each type of process flow. The navigation option associated with that launching option should reference the BPA script associated with the corresponding type of process flow.

Saving Off Work

The user may save off their work on a process flow at any time. If enabled on the process flow type, the system would also automatically save the data when the user navigates to another panel or away from the process flow portal.

On either manual or automatic save operations, the **Process Manager** script defined on the process flow type is called to save off the entire process flow data on a designated record in the database.

The base product provides a generic **Process Flow** maintenance object that is designed to support the storage of any type of process flow as well a corresponding process manager script. Should process flows of a specific type be stored elsewhere, then a dedicated process manager script should be implemented and used instead.

Review Process Flow Records

A process flow record is created when a user saved off their work or the process flow type enables automatic saving. When the user finishes a process flow, depending on the process flow type configuration the record may be deleted or retained for audit purposes.

Reviewing process flow records of a specific type is assumed to be made from a designated menu option or within a specific context applicable to that type of work. As such this item needs to be configured specifically for each type of process flow. The navigation option associated with that item should reference a query portal designed to query and manage the specific type of process flow records.

In addition to standard query features, the query portal should allow the user to resume their work on a non-finalized process flow as well as review the data captured on a completed record. When implementing such a query portal, refer to the sample **Process Flow Query (F1PRSTRQ)** portal for key features. Your specific product may already include such query portals for process flow types it supports. Refer to your specific product documentation for additional information.

Designing Process Flows

A wide range of process flows may be designed to implement online tasks business users may need to perform. Refer to [Understanding Process Flows](#) for more information.

Below is a high-level summary of the steps required to design and configure various types of process flows.

Analyze The Task

The following provides a the high-level guidance in analyzing the necessary data and rules needed to support an implementation of a new type of process flow:

- Identify the data and business rules that are needed to complete the entire task.
 - When possible, organize data into logical groups of details defined as data areas.
 - Design logic for the final processing script that accepts the entire data entered along with the user's action to either complete or cancel the task.
 - If data needs to be initially prepared for a newly initiated process flow, design logic for a corresponding initial processing script.
 - Determine whether a summary panel may be useful for the user to review the outcome of a completed process.
- Design the sequence of panels the user should follow to complete the task. Identify the initial and final panels.
- Review each panel and determine the following:
 - Is it a single panel or a nested process flow (i.e. a panel set)?
 - What is the title of the panel and its label on the progress bar?
 - How should the layout be rendered? Use a data area that leverages UI Hints to describe the panel layout when possible. For more complex HTML requirements you may use a UI map fragment.

- Should details on this panel be defaulted with some initial values when the user enters this panel? If so, design logic for a corresponding pre-processing script.
- If data entered on this panel should be validated before the user exits the panel, design logic for a corresponding post-processing script.
- Design the summary panel if needed.
- Determine whether this type of process flow should be automatically saved by the system or solely rely on the user to control when data is saved.
- Determine whether a record of a completed process flow should be retained for audit purposes or deleted upon completion.
- Determine whether a user may delete in progress records of such process flow.
- Determine whether process flows of this type are saved and stored in a dedicated table in the database or are saved in the generic table provided by the base product. The assumption is that introducing new designated storage maintenance objects is not common. Refer to your edge product documentation for additional maintenance objects that may have been provided to support specific types of process flows shipped with the product.
- Determine the context in which a user can initiate, resume work on, and review process flows of that type.
 - The process flow may be launched from a menu or a favorite script etc.
 - Design the query portal a user would use to find and resume a saved off process flow of this type as well as review completed process flow records. Depending on the context of this task, the query may be associated with the same menu line that initiates the process flow.

Using UI Map Panels

Typically a map fragment is rendered as part of a complete UI map but when used as a process flow panel the system renders the panel assuming the fragment contains a complete map.

Therefore, such fragment should includes the following items:

- The standard error message section used for reporting errors.
- This line `<xml style="display:none"></xml>` at the end of the HTML content for proper binding of data to their HTML elements.

A UI map based panel allows for more control over some of the buttons available to the user. For example, the panel may prevent the user from proceeding to the next panel unless required information is entered. Refer to the explicit APIs listed in the process controller UI Map (F1-ProcessController) for more information.

Configure The Process Flow Type

The following describes the high-level steps needed to configure a new type of process flow:

- Create the UI map for the process flow. Its schema should contain all the details needed to complete the task. Its HTML should only include the process controller UI map fragment.
- Create a start processing service script if needed.
- Create a final processing service script such that it applies all the rules needed to complete or cancel the task.
- For each panel perform the following:
 - Create a UI map fragment for it unless it corresponds to a data area already included in the process flow schema. Make sure the XPath of each element references in the data area or UI map is the same XPath of that element in the process flow's UI map schema.
 - Create a pre-processing service script if needed. Not applicable to the summary panel.
 - Create a post-processing service script if needed. Not applicable to the summary panel.

- Set up a label and title MD fields if existing ones cannot be used.
- Create a BPA script for the process flow.
- Configure the [process flow type](#) record.
- Set up a navigation option and reference the BPA script on it. Associate the navigation option with a menu or provide other means for the user to initiate the process flow.
- Create a query portal for the specific type of process flow records. Add the new query portal to a menu or provide other means for the user to resume work on a process flow they have saved off or review completed records.

Control Visibility of Standard Buttons

You may leverage the following JavaScript functions to control the visibility of standard process flow buttons:

- Next: **enableNext()**, **disableNext()**, **hideNext()** , **showNext()**
- Finish: **enableFinish()**, **disableFinish()**, **hideFinish()** , **showFinish()**
- Save: **enableSave()**, **disableSave()**, **hideSave()** , **showSave()**.

Defining Process Flow Types

This portal is used to maintain process flow types.

Refer to [Understanding Process Flows](#) for more information.

You can access the portal from the **Admin Menu > System > Process Flow Type**.

The following zones may appear as part of the portal's **Main** tab page

- **Process Flow Type List.** This zone lists all process flow types. Broadcast a record to display the details of the selected process flow type.
- **Process Flow Type.** This zone provides information about the selected process flow type.

Action Method

Action method is an object that may be used to define configuration based on some criteria. For example, when initiating a Start Service scenario, the service request type may differ based on the CIS division and the customer class. When a user initiates a Start Service process, the system can prompt the user for information about the customer that can determine the CIS division and the customer class. The system can then call an algorithm passing this information to retrieve the appropriate service request type to use as defined in the action method. Throughout this section, the term 'criteria' is used to identify the information used to determine the desired configuration and the term 'details' or 'results' is used to identify the configuration information being determined.

If you were to design a use case to use this functionality consider the following:

- What information needs to be identified (the 'details'/'results')? The example above uses a configuration object as its example (service request type). However, the information you are determining could be anything that can differ by some combination of attributes. You could use this to determine which collection algorithm to execute based on criteria. Or the number of days to wait to continue with some process for some use case.
- When and where do I need to determine this information and what do I do with it once I receive it?
 - Is this needed as part of a user interaction?
 - Or is this needed for internal processing?

- What is the criteria needed to determine the desired information? Do I have this information at the time that I need it? Or do I need to prompt a user for the information?

The framework product supplies the generic objects needed to support this type of functionality. The individual edge products or implementations can build their use cases with the tools provided. The topics in this section further describes the provided features.

Action Method Role

The action method functionality is driven by the Action Method Role, which represents a given use case. Some examples of action method roles that may be relevant in an enterprise product are 'Start Service', 'Stop Service' and 'Transfer Service'. The valid action method roles are defined using an extendable lookup and referenced on the Action Method. One and only one action method may be defined for one action method role.

The action method role record may reference an action method role BPA script, if the use case for this Action Method Role involves user interaction. The responsibility of this script, if needed is to take the action method role value, determine the action method that references the role and identify the more specific Action Processing BPA script (defined on the business object) and transferring control to that script. This reference may be used for audit or information purposes, depending on how you have implemented the user experience. The action method role BPA is ideally configured on an appropriate menu entry or an action button on a specific user interface related to this use case.

If your business use case does not require user interaction, then an action method role BPA script is not necessary.

Action Method Business Object

The action method's business object is used to define the information that needs to be configured for both the criteria and the results. Continuing to use the above example, the business object for a Start Service use case defines a list that captures the CIS division and customer class along with the service request type to use. The information is configured in the XML data area for the action method and the schema design is dictated by the business requirements. For example, it may be that your use case dictates a default value for the results (in our case, the service request type) plus override values based on a division and customer class combination.

Get Action Method Details Plug-in

Besides defining the schema information for capturing the criteria and results, the business object defines the algorithm that should be invoked to retrieve the results based on the criteria.

The plug-in spot is **Get Action Method Details**. Its API is flexible in the information it receives and returns so that each action method use case can design the algorithm based on its business requirements.

The algorithm receives a list of 'Criteria Data' using a 'name' and up to 5 values (to handle multi-part primary keys). Typically only 'value 1' is needed for each entry. The algorithm type designed for a given action method business object can determine what information is receives. It could be that it expects the criteria elements defined on the action method. In our example, the algorithm type could expect to receive the CIS division and customer class. Alternatively, the algorithm type could be designed to receive a value that can be used to determine the criteria needed. For example, it could receive the account ID and use that information to determine the CIS division and customer class.

The algorithm returns one or more results as 'Details'. The information returned is based on the use case. In our example, the service request type is returned. Your business requirements may use the action method role to return multiple results, for example a service request type and a process flow type to invoke to capture all the information needed to start service.

The product provides a business service **F1-RetrieveActionMethodDetails** to call the algorithms for a given action method value.

Action Processing BPA

If your business requirement requires user interaction either to determine the criteria to pass to the Get Action Method Details algorithm or to use the resulting information to continue with an online action, an Action Processing BPA is needed. This BPA should be designed and linked to your action method business object as an option using the **Action Processing BPA Script** option type.

The design of this BPA depends on your business requirements. But at a high level, it may need to prompt the user for information needed to determine the criteria associated with the action method details, then call the **F1-RetrieveActionMethodDetails** business service to execute the algorithms for your action method. Once the results are returned, the script would proceed with the next step in the business use case.

NOTE: If any additional information needs to be gathered by the server before or after the call to the business service that executes the algorithms, then the recommendation is that the BPA should call a service script that does all the server level logic at one time.

Action Method Role vs. Action Method Business Object

The action method role defines the use case. The business object is used to design the schema for the criteria and the results and identifies the action processing BPA and the Get Action Method Details plug-in. It may warrant a unique business object for each action method role. However, there may be cases where more than one action method role and its action method can reuse the same business object. For example, imagine there are different service request types for Start Service, Stop Service and Transfer Service, however in all cases the valid value is driven by the CIS division and customer class. These three separate action method roles and action methods can reuse a common business object defining the criteria of CIS division and customer class determining the appropriate service request type.

Defining Action Methods

Refer to [Action Method](#) for an overview of action method functionality.

To maintain the action methods applicable to your implementation, open **Admin > System > Action Method**.

This is a standard [All-in-One portal](#) and includes the standard List and display zones for an action method.

The information captured on the action method depends on the business objects supported by your product or implementation. Refer to the embedded help text for more information.

Algorithms

In this section, we describe how to set up the user-defined algorithms that perform many important functions including:

- Validating the format of a phone number entered by a user.
- Validating the format of a latitude/longitude geographic code entered by a user.
- In products that support payment and billing:
 - Calculating late payment charges.
 - Calculating the recommended deposit amount.
 - Constructing your GL account during the interface of financial transactions to your GL
- And many other functions...

The Big Picture Of Algorithms

Many functions in the system are performed using an algorithm. Algorithms are called at strategic points (often referred to as a "plug-in spot") within system processing to perform specific code. The plug-in spots are preconfigured with the product and vary from object to object. Algorithms are used by the base product to provide out of the box functionality. The algorithm framework provides a means for implementations to insert their own custom code, which can be instead of the base delivered code or in addition to it.

NOTE: Algorithm = Plug-in. We use the terms plug-in and algorithm interchangeably throughout this documentation.

Algorithm Type Versus Algorithm

Often the system will just talk about algorithms but in actuality there are two important objects that provide this plug-in functionality.

- An **Algorithm Type** defines the plug-in spot. In addition, it defines program to execute. The program may be defined using Java or using a [plug-in script](#). The algorithm type also defines any parameters that must be supplied to algorithms of this type.
- An **Algorithm** is an instance of an **Algorithm Type**. If the algorithm type does not define any parameters, then there will be only one algorithm for the algorithm type. If the algorithm defines parameters, then there could be several algorithms for a given algorithm type, one for each unique set of parameter values for a given use case. The algorithm is the object that gets referenced on a given control table when configuring your system.

Algorithm Plug-in Spot

The plug-in spot, also called Algorithm Entity and System Event, defines several aspects of the functionality for algorithms that are executed.

- When in system processing are algorithms of this plug-in spot executed? For example, algorithms for the Installation Option - To Do Pre-creation are called when a To Do is getting added, before any insert to the database is performed.
- The API for the plug-in spot. This is often referred to as the "hard parameters" for the plug-in spot. What information is every algorithm provided when called? Additionally, if the algorithm is expected to return information to the caller, this is also part of the hard parameters. For example, the Installation Option - To Do Pre-creation plug-in spot receives all the information about the To Do that is about to be added. It may add or update values. It may also return an indication to not create the To Do, if desired.

NOTE: The hard parameters are different from the parameters defined on the algorithm type. Those are referred to as the "soft parameters". Those parameters are used to configure settings that the algorithm type code uses per its specific functionality.

- What is the responsibility of algorithms for the plug-in spot? When defining a plug-in spot, the product defines the responsibility of the code for the algorithm types created for that spot. For example, is the algorithm determining information and returning it? Or is it supposed to perform an update? Algorithms for the Installation Option - To Do Pre-creation plug-in spot should not do any updates. Rather they should adjust the To Do information (if desired) in the hard parameters and return them. The calling logic will use that adjusted information when inserting the To Do record.
- Where do you configure the algorithm? We have been using the Installation Option - To Do Pre-creation plug-in spot as an example. As the description suggests, these algorithms are configured on the Installation Option - Algorithm collection. Each plug-in spot defines where (on which control table) the algorithms are plugged in. The system standard for the description of the Algorithm Entity flag value that defines the available plug-in spots is "Control Table Name - Event". For example the To Do Type - Calculate Priority algorithm plug-in spot means that algorithms are configured on the To Do Type. This information also indicates the granularity of the algorithm. Installation Option algorithms are system wide. But an algorithm plugged in on To Do Type, for example, indicates that only To Do Entries for that To Do Type will have that algorithm executed.
- Are multiple algorithms allowed? There are some plug-in spots where it doesn't make sense to support multiple algorithms. An example of this is the Batch Control - Select Records plug-in. This plug-in is used by the plug-in driven batch process and is responsible for selecting the records to process. Only one algorithm of this type is allowed on a given Batch Control. An example of a plug-in spot that would support multiple algorithms is a validation plug-in spot. Note that when a plug-in spot supports multiple algorithms, there can be yet additional aspects of the plug-in spot design.
 - In some cases, this type of plug-in spot simply executes each algorithm. A validation plug-in spot is an example of this.
 - In some cases, the algorithm could return an indication to the plug-in spot 'driver' to not execute any subsequent algorithms. Business Object Status - Enter is an example of a plug-in spot that supports this capability.

- In some cases, the plug-in spot may support sharing information from one algorithm to the next. Migration Plan - Pre-Compare is an example of a plug-in spot that supports this capability.

Each plug-in spot is defined in the Algorithm Entity lookup (**ALG_ENTITY_FLG**). When defining an algorithm type or defining a plug-in script, once you select the algorithm entity value, a help icon should appear. Clicking this icon will show you the description of the plug-in spot. It may be that online help provides more information about a given plug-in spot as well. Note that to see the hard parameters defined for a given plug-in spot, go to the [Script](#) page in add mode and select the script type of plug-in and the desired algorithm entity lookup value. Then navigate to the Data Area tab. The **View Plug-In Script Data Area** link will display the hard parameters.

Base Product Algorithms

The base product provides many, many algorithm types and algorithms out of the box. Sometimes algorithms are delivered to provide support for common use cases that we know our clients will need. Many algorithms, however, are provided because we are implementing system functionality using the same infrastructure and capabilities that our implementation use for their own custom code.

When an algorithm type is delivered, the decision as to whether an algorithm is also provided depends on some factors related to whether soft parameters are defined for the algorithm type.

- If no parameters are defined for the algorithm type, a corresponding algorithm is typically also provided.
- If parameters are defined and the values are on configuration data that is normally owned by the implementation, a base algorithm will probably not be defined.
- If parameters are defined and the values are not dependent on configuration data, it's possible that one or more algorithms are provided.

To review the algorithm types that are delivered with the product, go to the Algorithm Type query. The query provides several search options, including searching by the algorithm entity lookup value.

How To Add A New Algorithm

Before you can add a new algorithm, you must determine if you can use one of the [algorithm types](#) supplied with the system by using the algorithm type query.

If you can use one of the algorithm types, simply add the algorithm and then reference it on the respective control table. Refer to [Defining Algorithms](#) for how to do this.

If you have to add a new algorithm type, you may have to involve a programmer. Let's use an example to help clarify what you can do versus what a programmer must do. Assume that you require an additional geographic type validation algorithm. To create your own algorithm type you must:

- Write a new program to validate geographic type in the appropriate manner. Alternatively, you may configure a plug-in script to implement the validation rules. The advantage of the latter is that it does not require programming. Refer to [plug-in script](#) for more information.
- Create an Algorithm Type called **Our Geographic Format** (or something appropriate). On this algorithm type, you'd define the name of the program (or the plug-in script) that performs the function. You'd also define the various parameters required by this type of algorithm.
- After creating the new Algorithm Type, you can reference it on an Algorithm.
- And finally, you'd reference the new Algorithm on the Geographic Type that requires this validation.

Minimizing The Impact Of Future Upgrades

The system has been designed to use algorithms so an implementation can introduce their own logic in a way that's 100% upgradeable (without the need to retrofit logic). The following points describe strong recommendations about how to construct new algorithm type programs so that you won't have to make program changes during future upgrades:

- Do not alter an algorithm type's hard parameters. For example, you might be tempted to redefine or initialize parameters defined in an algorithm type's linkage section. Do not do this.
- Follow the naming conventions for the new algorithm type code and your source code, i.e., both the source code and the algorithm type should be prefixed with "CM". The reason for this naming convention is to make it impossible for a new, base-package algorithm type from overwriting your source code or algorithm type meta-data (we will never develop a program or introduce meta-data beginning with CM).
- Avoid using embedded SQL to perform insert/update/delete. Rather, invoke the base-package's object routines or common routines.
- Avoid using base messages (outside of common messages, i.e., those with a message number < 1000) as we may deprecate or change these messages in future releases. The most common problem is caused when an implementation clones a base package algorithm type program because they need to change a few lines of logic. Technically, to be 100% upgradeable, you should add new messages in the "90000" or greater category (i.e., the category reserved for implementation-specific messages) for every message in your new program even though these messages may be duplicates of those in the base package.

Defining Algorithm Types

The system provides many algorithm types to support base product functionality. If you need to introduce a new type of algorithm, open **Admin > System > Algorithm Type**.

Use the **Algorithm Type Query** portal to search for an existing algorithm type. Once an algorithm type is selected, you are brought to the maintenance portal to view and maintain the selected record.

FASTPATH: Refer to [The Big Picture Of Algorithms](#) for more information.

CAUTION: Important! If you introduce a new algorithm type, carefully consider its naming convention. Refer to [System Data Naming Convention](#) for more information.

Description of Page

Enter an easily recognizable **Algorithm Type** and **Description**.

Owner indicates if this algorithm type is owned by the base package or by your implementation (**Customer Modification**). The system sets the owner to **Customer Modification** when you add an algorithm type. This information is display-only.

Enter a **Detailed Description** that describes, in detail, what algorithms of this type do.

Use **Algorithm Entity** to define where algorithms of this type can be "plugged in". If a detailed description about an algorithm entity is available, a small help icon is visible adjacent to the dropdown. Click the icon to view the information.

NOTE: The values for this field are customizable using the [lookup](#) table. This field name is **ALG_ENTITY_FLG**.

Use **Program Type** to define if the algorithm's program is written using **Java**, a **Plug-In Script**, or **Java (Converted)**, meaning the program has been converted to Java.

NOTE: **Java (Converted)** program types are not applicable to all products.

Use **Program Name** to define the program to be invoked when algorithms of this type are executed:

- If the Program Type is **Java (Converted)**, enter the name of the converted program.
- If the Program Type is **Java**, enter the Java class name.
- If the Program Type is **Plug-In Script**, enter the plug-in [script](#) name. Only plug-in scripts defined for the algorithm entity may be used.

NOTE: View the source. If the program is shipped with the base package, you can use the adjacent button to display the source code of this program in the [Javadocs](#) viewer. For plug-in scripts, drill into the plug-in script to view the details.

Use the **Parameter Types** grid to define the types of parameters that algorithms of this type use. The following fields should be defined for each parameter:

- Use **Sequence** to define the relative position of the **Parameter**.
- Use **Parameter** to describe the verbiage that appears adjacent to the parameter on the Algorithm page.
- Indicate whether the parameter is **Required**. This indicator is used when parameters are defined on algorithms that reference this algorithm type.
- **Owner** indicates if the parameter for this algorithm type is owned by the base package or by your implementation (**Customer Modification**). The system sets the owner to **Customer Modification** when you add an algorithm type with parameters. This information is display-only.

NOTE: When adding a new algorithm type that is for a Java program, the parameters are automatically generated based on the Java code. Once an algorithm type exists, any additional parameters defined in the Java code should be manually added to the algorithm type. For other program types, algorithm type parameters must be manually defined.

NOTE: When a new algorithm type parameter is added for any program type, existing algorithms for the algorithm type do not automatically get updated with the new parameter. The algorithms must be manually updated.

Defining Algorithms

This portal is used to view and maintain information about an algorithm.

You can access the portal from the **Admin Menu > System > Algorithm**. You are brought to a query portal with options for searching for a specific algorithm. Once an algorithm has been selected you are brought to the maintenance portal to view and maintain the selected record.

Refer to [The Big Picture Of Algorithms](#) for more information.

CAUTION: Important! If you introduce a new algorithm, carefully consider its naming convention. Refer to [System Data Naming Convention](#) for more information.

The following zones may appear as part of the portal's **Main** tab page

- **Algorithm.** This zone provides information about the selected algorithm.
- **Other Algorithms.** This zone lists other algorithms of the same algorithm type. The zone is only visible when such algorithms exist.

The following zones may appear as part of the portal's **References** tab page

- **Algorithm References.** This zone list various configuration entities referencing the current algorithm.

NOTE: If the product delivers an algorithm with parameter values defined, an implementation may override the base provided parameter values by adding an additional effective dated collection of parameters.

NOTE: If an algorithm is defined and subsequently a new parameter is added to the algorithm type, existing algorithms for the algorithm type should be updated to add a new effective dated entry to the parameter collection. At this point the latest list of parameters for the algorithm type are visible. Configure the parameters accordingly.

Advanced Algorithm Tips

Initiating Actions that Cannot be Rolled Back

If you have an algorithm that creates a sync request or performs some other logic that could cause a message to be sent and cannot be rolled back, you should be sure to cater for warnings in the design.

- The algorithm should be performed after all validations that could accumulate warnings.
- The algorithm should include a step to call the Business Service **F1-CheckWarning** and see if any warnings have been accumulated. If so, don't perform the action. It means that the user will get a warning and if they click "OK", all the processing will happen again, but this time without accumulating any warnings. Refer to the plug-in script **F1-GnChgDCap** for an example.

Script Options

We use the term "script" to define processing rules that your implementation sets up to control both front-end and back-end processing:

- Rules that control front-end processing are defined using [Business Process Assistant \(BPA\)](#) scripts. For example, your implementation could set up a BPA script to guide a user through your organization's payment cancellation process.
- Rules that control back-end processing are defined using [Server-based](#) scripts. For example, your implementation could set up a server-based script to control the processing that executes whenever a given type of adjustment is canceled.

The topics in this section describe how to configure your scripts.

The Big Picture Of Scripts

This section describes features and functions that are shared by both BPA scripts and server-based scripts.

Scripts Are Business Process-Oriented

To create a script, you must analyze the steps used to implement a given business process. For example, you could create a "stop auto pay" BPA script that:

- Asks the user to select the customer / taxpayer using an appropriate search page
- Asks the user to define the date on which the person would like to stop making automatic payments
- Invokes a server-based script that populates the end-date on the account's latest automatic payment instructions.

After you understand the business process, you can set up a script to mimic these steps. If the business process is straightforward (e.g., users always perform the same steps), the script configuration will be straightforward. If the business process has several logic branches, the composition of the script may be more challenging.

A Script Is Composed Of Steps

A script contains one or more steps. For example, a "stop auto pay" BPA script might have three steps:

- Ask the user to select the customer / taxpayer using an appropriate search page
- Ask the customer the date on which they'd like to stop making automatic payments (and default the current date)
- Invoke a server-based script that, in turn, updates the account's auto pay options.

Each step references a step type. The step type controls what happens when a step executes. It might be helpful to think of a script as a macro and each step as a "line of code" in the macro. Each step's step type controls the function that is executed when the step is performed.

FASTPATH: Refer to [How To Set Up Each Step Type](#) for a detailed description of all available step types and how to set them up.

A Script May Declare Data Areas

Both BPA and server-based scripts may have one or more [data areas](#):

- If the script contains steps that exchange XML documents, you must declare a data area for each type of XML document. For example, if a BPA script has a step that invokes a service script, the BPA script must declare a data area that holds the XML document that is used to pass information to and from the service script.
- You can use a data area as a more definitive way to declare your temporary storage. For example, you can describe your script's temporary storage variables using a [stand-alone data area](#) schema and associate it with your script.

Various step types involve referencing the script's data areas as well as support the ability to compare and move data to and from field elements residing in the data areas.

An Edit Data step supports the syntax to dynamically declare data areas as part of the step itself. This technique eliminates the need to statically declare a data area. Refer to [Edit Data Syntax](#) for more information on edit data commands and examples of the use of dynamic data areas.

NOTE: Some server based scripts may not use data areas as means of defining or exchanging data, depending on script type and the chosen scripting technique. Refer to [The Big Picture Of Server Based Scripts](#) for an overview of server scripts and their applicable scripting options.

Securing Script Execution

The system supports the ability to secure the execution of scripts by associating the script with an Application Service. Refer to [The Big Picture of Application Security](#) for more information. Application security is optional for user-invocable BPA scripts. If a script is not associated with an application service, all users may execute the script. Otherwise, only users that have **Execute** access to the application service may execute the script. For service scripts, the application service is required.

The Big Picture Of BPA Scripts

FASTPATH: Refer to [The Big Picture Of Scripts](#) to better understand the basic concept of scripts.

Users may require instructions in order to perform certain tasks. The business process assistant allows you to set up scripts that step a user through your business processes. For example, you might want to create scripts to help users do the following:

- Add a new person to an existing account
- Set up a customer to pay automatically
- Modify a customer who no longer wants to receive marketing information
- Modify a customer's web password
- Record a trouble order
- Merge two accounts into one account
- Fix a bill with an invalid rate

- ... (the list is only limited by your time and imagination)

Users execute these scripts via the [business process assistant](#) (BPA). Users can also define their favorite BPA scripts in their [user preferences](#). By doing this, a user can execute a script by pressing an accelerator key (Ctrl + Shift + a number).

Don't think of these scripts as merely a training tool. BPA scripts can also reduce the time it takes to perform common tasks. For example, you can write a script that reduces the "number of clicks" required to add a new person to an existing account.

CAUTION: Future upgrade issues. Although we make every effort not to remove fields or tab pages between releases, there may be times when changes made by the base-package will necessitate changes to your scripts. Please refer to the release notes for a list of any removed fields or tab pages.

CAUTION: Scripts are not a substitute for end-user training. Scripts minimize the steps required to perform common tasks. Unusual problems (e.g., a missing meter exchange) may be difficult to script as there are many different ways to resolve such a problem. However, scripts can point a user in the right direction and reduce the need to memorize obscure business processes.

The topics in this section describe background topics relevant to BPA scripts.

How To Invoke Scripts

Refer to [Initiating Scripts](#) for a description of how end-users initiate scripts.

Developing and Debugging Your BPA Scripts

We recommend considering the approaches outlined below when you construct scripts.

While designing your scripts, determine the most maintainable way to set them up. Rather than creating complex, monolithic scripts, we recommend dividing scripts into smaller sections. For example

- Determine if several scripts have similar steps. If so, set up a script that contains these common steps and invoke it from the main scripts using a **Perform script** step.
- Determine if a large script can be divided into logical sections. If so, set up a small script for each section and create a "master script" to invoke each sub script via a **Transfer control** step.

For debugging purposes, you may find it helpful to categorize the step types into two groups: those that involve some type of activity in the [script area](#), and those that don't. The following step types cause activity in the script area: **Height, Display text, Prompt user, Input data, Input Map, Set focus to a field**.

The rest of the step types are procedural and involve no user interaction. There are two techniques you can use to assist in debugging these step types.

- You can instruct the system to display text in the script area.
- You can display an entire data area (or a portion thereof) in the script area by entering `%+...+%` where ... is the name of the node whose element(s) should be displayed.

NOTE: Time saver. When you develop a new BPA script, change your [user preferences](#) to include the script as your first "favorite". This way, you can press Ctrl+Shift+1 to invoke the script (eliminating the need to select it from the [script menu](#)).

Launching A Script From A Menu

You can create menu items that launch BPA scripts rather than open a page. To do this, create a [navigation option](#) that references your script and then add a menu item that references the navigation option.

If the navigation option is referenced on a [context menu](#) and the navigation option has a "context field", a temporary storage variable will be created and populated with the unique identifier of the object in context. For example, if you add a "script" navigation option to the bill context menu and this navigation option has a context field of BILL_ID, the system will create a temporary storage variable called BILL_ID and populate it with the respective bill id when the menu item is selected.

Launching A Script When Starting The System

You can set the system to launch a script upon startup. This may be used for integrations from an external system or for use cases within the application where a link has been configured to launch the application in a new browser tab, allowing the original page to remain open. Refer to [Creating Application Links in External Applications](#) for details of what is supported.

Executing A Script When A To Do Entry Is Selected

The system creates [To Do entries](#) to highlight tasks that require attention (e.g., records in error). Users can complete many of these tasks without assistance. However, you can set up the system to automatically launch a script when a user selects a To Do entry. For example, consider a To Do entry that highlights a bill that's in error due to an invalid mailing address. You can set up the system to execute a script when this To Do entry is selected by a user. This script might prompt the user to first correct the customer's default mailing address and then re-complete the bill.

The following points provide background information to help you understand how to implement this functionality:

- Every To Do entry references a [To Do type](#) and a [message category and number](#). The To Do type defines the category of the task (e.g., bill errors). The message number defines the specific issue (e.g., a valid address can't be found.). Refer to [The Big Picture of System Messages](#) for more information about message categories and numbers.
- When a user drills down on a To Do entry, either a script launches OR the user is transferred to the transaction associated with the entry's To Do type. You control what happens by configuring the To Do type accordingly:
 - If you want to launch a script when a user drills down on an entry, you link the script to the [To Do type and message number](#). Keep in mind that you can define a different script for every message (and some To Do types have many different messages).
 - If the system doesn't find a script for an entry's To Do type and message number, it transfers the user to the To Do type's default transaction.

NOTE: How do you find the message numbers? We do not supply documentation of every To Do type's message numbers (this list would be impossible to maintain and therefore untrustworthy). The best way to determine which message numbers warrant a script is during pre-production when you're testing the system. During this period, To Do entries will be generated. For those entries that warrant a script, simply display the entry on [To Do maintenance](#). On this page, you will find the entry's message number adjacent to the description.

- These types of scripts invariably need to access data that resides on the selected To Do entry. Refer to [How To Use To Do Fields](#) for the details.

The Big Picture Of Script Eligibility Rules

You can configure [eligibility criteria](#) on the scripts to limit the scripts that a user sees in the [script search](#). For example, you could indicate a script should only appear on the script menu if the user belongs to the level 1 customer service representative group. You may also indicate that a script should only appear if the data a user is viewing has certain criteria. For example, if you are using Oracle Utilities Customer Care and Billing, you can indicate that a script should only appear if the current account's customer class is residential. By doing this, you avoid presenting the user with scripts that aren't applicable to the current data in context or the user's role.

The topics in this section describe eligibility rules.

Script Eligibility Rules Are Not Strictly Enforced

The [script search](#) gives a user a choice of seeing all scripts or only scripts that are eligible (given the current data in context and their user profile). This means that it's possible for a script that isn't eligible for the given context data / user to be executed via this search. In other words, the system does not strictly enforce a script's eligibility rules.

It might be more helpful to think of eligibility rules as "highlight conditions". These "highlight conditions" simply control whether the script appears in the [script search](#) when a user indicates they only want to see eligible scripts.

You Can Mark A Script As Always Eligible

If you don't want to configure eligibility rules, you don't have to. Simply indicate that the script is always eligible.

You Can Mark A Script As Never Eligible

If you have scripts that you do not want a user to select from the script menu, indicate that it is never eligible. An example of a script that you wouldn't want a user to select from the menu is one that is [launched when a To Do entry is selected](#). These types of scripts most likely rely on data linked to the selected To Do entry. As a result, a user should only launch scripts of this type from the To Do entry and not from the script menu.

Criteria Groups versus Eligibility Criteria

Before we provide concrete examples of eligibility criteria, we need to explain two concepts: Criteria Groups and Eligibility Criteria. A script's criteria groups control whether a user is eligible to choose a script. At a high level, it works like this:

- A criteria group has one or more eligibility criteria. A group's criteria control whether the group is considered true or false.
- When you create a group, you define what should happen if the group is true or false. You have the following choices:
 - The user is eligible to choose the script
 - The user is not eligible to choose the script
 - The next group should be checked

We'll use the following example from Oracle Utilities Customer Care and Billing to help illustrate these points. Assume a script is only eligible if:

- The customer has electric service and the user belongs to user group A, B or C
- OR, the customer has gas service and the user belongs to user group X, Y or A

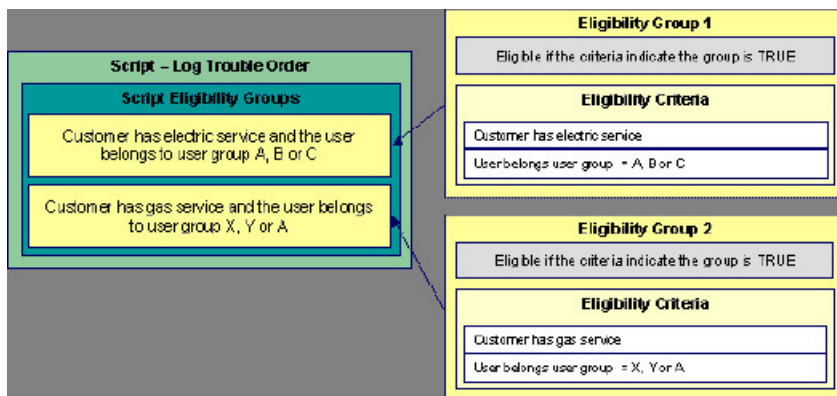

This script requires two eligibility groups because it has two distinct conditions:

- IF (Customer has electric service AND (User belongs to user group A, B or C))
- IF (Customer has gas service AND (User belongs to user group X, Y or A))

If either condition is true, the script is eligible.

You would need to set the following criteria groups in order to support this requirement:

Group No.	Group Description	If Group is True	If Group is False
1	Customer has electric service and the user belongs to user group A, B or C	Eligible	Check next group
2	Customer has gas service and the user belongs to user group X, Y or A	Eligible	Ineligible

The following criteria are required for each of the above groups:

Group 1: Customer has electric service and the user belongs to user group A, B or C				
Seq	Logical Criteria	If Eligibility Criteria is True	If Eligibility Criteria is False	If Insufficient Data
10	Customer has electric service	Check next condition	Group is false	Group is false
20	User belongs to user group A, B or C	Group is true	Group is false	Group is false

Group 2: Customer has gas service and the user belongs to user group X, Y or A				
Seq	Logical Criteria	If Eligibility Criteria is True	If Eligibility Criteria is False	If Insufficient Data
10	Customer has gas service	Check next condition	Group is false	Group is false
20	User belongs to user group X, Y or A	Group is true	Group is false	Group is false

The next section describes how you might configure the specific logical criteria in each of the groups.

Defining Logical Criteria

When you set up an eligibility criterion, you must define two things:

- The field to be compared
- The comparison method

You have the following choices in respect of identifying the *field to be compared* :

- You can execute an algorithm to retrieve a field value from somewhere else in the system.
- Some products may support choosing a characteristic linked to an appropriate object in the system (such as an account or person).

You have the following choices in respect of identifying the *comparison method*:

- You can choose an operator (e.g., >, <, =, BETWEEN, IN, etc.) and a comparison value.
- You can execute an algorithm that performs the comparison (and returns True, False or Insufficient Data). This is also a very powerful feature, but it's not terribly intuitive. We'll present a few examples later in this section to illustrate the power of this approach.

The [Examples Of Script Eligibility Rules](#) provide examples to help you understand this design.

Examples Of Script Eligibility Rules

The topics in this section provide examples about how to set up script eligibility rules.

A Script With A Time Span Comparison

A script that is only eligible for senior citizens has the following eligibility rules:

- Customer class = Residential
- Birth date equates to that of a senior citizen

These rules require only one eligibility group on the script. It would look as follows:

Group No.	Group Description	If Group is True	If Group is False
1	Residential and Senior Citizen	Eligible	Ineligible

The following criteria will be required for this group:

Group 1: Residential, Calif, Senior					
Seq	Field to Compare	Comparison Method	If True	If False	If Insufficient Data
10	Algorithm: retrieve account's customer class	= R	Check next condition	Group is false	Group is false
30	Person characteristic: Date of Birth	Algorithm: True if senior	Group is true	Group is false	Group is false

The first criterion is easy; it calls an algorithm that retrieves a field on the current account. This value, in turn, is compared to a given value. If the comparison results in a True value, the next condition is checked. If the comparison doesn't result in a True value, the **Group is false** (and, the group indicates that if the group is false, the script isn't eligible).

The last criterion contains a time span comparison. Time span comparisons are used to compare a date to something. In our example, we have to determine the age of the customer based on their birth date. If the resultant age is > 65, they are considered a senior citizen. To pull this off, you can take advantage of a comparison algorithm supplied with the base script as described below.

- Field to Compare. The person characteristic in which the customer's birth date is held is selected.
- Comparison Method. We chose a comparison algorithm that returns a value of **True** if the related field value (the customer's date of birth) is greater than 65 years (refer to **SECC-TIMESPN** for an example of this type of algorithm). Note that this time span algorithm can be used to compare days, weeks and months as well.

You'll notice that if a value of **True** is returned by the **True if senior** algorithm, the group is true (and we've set up the group to indicate a true group means the script is eligible).

A Script With Service Type Comparison

Imagine a script that is only eligible if the current customer has gas service and the user belongs to user groups A, B or C. This script would need the following eligibility rules:

- Customer has gas service
- User belongs to user group A, B, or C

These rules require only one eligibility group on the script. It would look as follows:

Group No.	Group Description	If Group is True	If Group is False
1	Has gas service and user is part of user group A, B or C	Eligible	Ineligible

The following criteria are required for this group:

Group 1: Has gas service and user is part of user group A, B, or C					
Seq	Field to Compare	Comparison Method	If True	If False	If Insufficient Data

10	Algorithm: check if customer has gas service	= True	Check next condition	Group is false	Group is false
20	Algorithm: check if user belongs to user group A, B or C	= True	Group is true	Group is false	Group is false

Both criteria are similar - they call an algorithm that performs a logical comparison. These algorithms are a bit counter intuitive (but understanding them provides you with another way to implement complex eligibility criteria):

The first criterion works as follows:

- **Field to Compare.** We chose a "field to compare" algorithm that checks if the current account has service agreements that belong to a given set of service types. It returns a value of **True** if the customer has an active service agreement that matches one of the service types in the algorithm. In our example, the "check if customer has gas service" algorithm returns a value of **True** if the customer has at least one active service agreement whose SA type references the gas service type. The "check if customer has electric service" algorithm is almost identical, only the service type differs.
- **Comparison Method.** We simply compare the value returned by the algorithm to True and indicate the appropriate response.

The second criterion works similarly:

- **Field to Compare.** We chose a "field to compare" algorithm that checks if the user belongs to any user group in a set of user groups. It returns a value of **True** if the user belongs to at least one user group defined in parameters of the algorithm. Refer to algorithm type **SECF-USRNGRP** for an example of this type of logic.
- **Comparison Method.** We simply compare the value returned by the algorithm to True and indicate the appropriate response.

NOTE: Bottom line. The "field to compare" algorithm isn't actually returning a specific field's value. Rather, it's returning a value of **True** or **False**. This value is in turn, compared by the "comparison method" and the group is set to true, false or check next accordingly.

The Big Picture Of Server-Based Scripts

FASTPATH: Refer to [The Big Picture Of Scripts](#) to better understand the basic concept of scripts.

Server-based scripts allow an implementation to configure backend business processes. The system supports three types of server-based scripts, **Plug-In** scripts, **Service** scripts and **Groovy Library** scripts.

- **Plug-in** scripts allow an implementation to develop routines that are executed from the system's various plug-in spots. For example, an implementation could configure a plug-in script that is executed every time an adjustment of a given type is frozen.
- **Service** scripts allow an implementation to develop common routines that are invoked from both front-end and back-end services. For example, an implementation could create a service script that terminates an account's automatic payment preferences. This service script could be invoked from a BPA script initiated by an end-user when a customer asks to stop paying automatically, and it could also be executed from a plug-in script if a customer fails to pay their debt on time. Service scripts are typically written using xpath scripting.
- **Groovy Library** scripts allow an implementation to develop groups of common routines written in the Groovy language which may be invoked from **Groovy Member** step types.

The topics in this section describe background topics relevant to server-based scripts.

Additional Coding Options For Server Scripts

Server based scripts often perform complex functions best supported by coding in languages with more comprehensive command sets than the base script steps. The system supports two common third-party languages for this purpose.

XML Path Language (XPath) is a language for querying and evaluating elements or nodes in an XML document. XPath commands and expressions can be used directly within [edit data](#) step types. The script engine version is used to define the applicable XPath version.

Groovy is an object-oriented, dynamic language for the Java platform. The framework supports the use of Groovy within server-based scripts to provide restricted and controlled access to Java-like code, particularly for cloud based implementations. The following topic provides more information on how to incorporate Groovy code into scripts.

Using Groovy Within Scripts

Groovy code can be incorporated in scripts using the step type **Groovy Members**. For each script with Groovy code, there will be a single Groovy class created by concatenating all **Groovy Members** steps.

For security, the product and third party Java classes available for scripting in Groovy are restricted. The allowable base classes may be viewed in the [Groovy Javadocs](#) viewer via the 'View Groovy Javadocs' link in the context sensitive Script Tips zone. The list of allowable third party classes can be viewed via the 'View third party Groovy allowlist' link in the Script Tips zone.

NOTE: This system supports the use of Groovy for back end processing purposes. It is not intended for user interfaces. Groovy is also not applicable to BPA scripts.

Groovy Script Engine

For scripts invoked from within Java and entirely written in Groovy should use a script engine version of **Groovy**. The system processes this type of script in a similar way to code written in Java. This avoids the need to convert the script to and from XML format and allows the use of code that acts directly on the system objects with consequent performance benefits.

The following script types support the Groovy engine version:

Plug In Scripts

Plug-in Scripts can be configured to use the Groovy engine if they contain only Groovy oriented step types. The system provides an automatically generated superclass that defines the plug-in spot API. Internally, the Groovy code must conform to the system conventions for Java based algorithm types, including the inclusion of an 'invoke' method that is the plug-in entry point, and the definition of 'soft' parameters using annotations.

Groovy Library Scripts

Groovy Library Scripts provide the ability to create groups of common routines written in Groovy that can be called from within other scripts. Scripts of this type must include a single step type of **Groovy Library Interface** in which the publicly available methods in the library are listed. The supporting code for those methods is defined in one or more **Groovy Members** step types within the library script. The methods defined in the library can accept arguments and return values of any type. Scripts of this type use the Groovy engine by default and cannot include scripting step types.

Scripts that need to invoke methods from a Groovy library can use the `createLibraryScript` method provided by the system to instantiate the library interface. Ensure that the class being instantiated includes the `.class` filename extension.

Invoking Groovy within the Scripting Engine

If a plug-in script or a service script is configured to use a scripting engine version, it can include a mixture of regular and **Groovy Members** step types. The script step types will define the process to be executed. The **Groovy Members** steps contain code that can be called from **Edit Data** step types within the script using the `invokeGroovy` command. Only

Groovy methods that receive no arguments and return void are supported using this command. Refer to the section on [edit data](#) steps for more details.

For scripts using this option, the framework provides a superclass containing methods that support common scripting actions such as move commands, string evaluation, and methods to invoke business objects, business services and service scripts. Refer to the Groovy specific Javadocs for details of the supported methods.

Importing Groovy Classes

All the Groovy classes used by your script should be explicitly declared in a **Groovy Imports** step type. When saving a script, if the system finds classes referenced in the script that are not explicitly declared, the system issues a warning and automatically adds import statements for the classes. Script writers should review the imports to confirm that they are the correct classes (in case there is a class with the same name in two different packages).

Backward Compatibility

In previous releases, the system did not require explicit imports and had logic to automatically import all callable classes available to Groovy at run-time. For any existing script that does not explicitly declare its imports, the system continues to fall back on importing all callable classes at runtime. However, the recommendation is to identify and update any such script as this is not the recommended practice.

The system provides a batch program **F1-CAGVY** that reports all scripts that required the automatic import step to successfully compile. In addition, this batch program is useful when the version of Groovy is upgrade to proactively detect possible issues in compilation of existing scripts that may occur due to changes in Groovy. Implementations are encouraged to run this batch program in the short term to identify and fix any scripts missing explicit imports and also for any Groovy version upgrade to review any implementation owned scripts that may be reported.

Plug-In Scripts

NOTE: This section assumes you are familiar with the notion of plug-in spots (algorithm entities) and plug-ins. See [The Big Picture Of Algorithms](#) for more information.

As an alternative to writing a java program for a plug-in spot, the framework supports creating plug-ins using the defined script steps, Xpath commands, Groovy code or a combination of these three options.

The following topics describe basic concepts related to plug-in scripts.

A Plug-In Script's API

Like program-based plug-ins, plug-in scripts:

- Run on the application server
- Have their API (input / output interface) defined by the plug-in spot (i.e., plug-in scripts don't get to declare their own API)
- Can only be invoked by the "plug-in spot driver"

For plug-ins configured to use a script engine version, the best way to understand the script's API is to use the **View Script Schema** hyperlink to view its parameters data area schema.

```

<schema>
  <parm type="group">
    <soft type="list">
      <value/>
    </soft>
    <hard type="group">
      <action use="input"/>
      <businessObject type="group" use="input">
        <id/>
      </businessObject>
    </hard>
  </parm>
</schema>

```

Notice the two groups: soft and hard. If you are familiar with plug-in spots, you'll recognize these as the classic soft and hard parameters:

- The **soft** parameters are the values of the parameters defined on the algorithm. Notice they are not named - if you want to reference them in your plug-in script, you must do it by position.
- The **hard** parameters are controlled by the plug-in spot (i.e., the algorithm entity). Notice that this plug-in spot has a single input parameter called "**businessObject/id**". Also notice the **use=** attribute - this shows that this parameter is input-only (i.e., you can't change it in the plug-in script).

NOTE: XPath. You can click on an element name to see the XPath used to reference the element in your script.

Plug-ins configured to use the **Groovy** engine version do not use an XML interface for the API and instead are processed in the same way as Java algorithms. The framework supplies a dynamically generated superclass that implements the plug-in spot for Groovy objects. Use the **View Script Superclass** hyperlink to view this superclass and the methods to set and get the hard parameters.

NOTE: For plug-in scripts using the **Groovy** engine version, soft parameters do not appear in the plug-in spot API as defined by the superclass. Plug-ins using only Groovy code define their soft parameters using annotations, in a similar way to Java algorithms, and fetch those values using methods defined in the algorithm code.

Setting Up Plug-In Scripts

The following points describe how to implement a plug-in script:

- Compose your plug-in [script](#), associating it with the appropriate algorithm entity (plug-in spot).
- Create a new algorithm type for the respective algorithm entity, referencing your plug-in script as the program to carry out the algorithm type's function. Only plug-in scripts associated with the algorithm entity may be referenced on the algorithm type.
- Set up an algorithm for the respective algorithm type and plug it in where applicable. Refer to [Setting Up Algorithm Types](#) for more information.

Service Scripts

BPA scripts run on the client's browser and guide the end-users through business processes. Service scripts run on the application server and perform server-based processing for [BPA scripts](#), [zones](#) and more. You may want to think of a service script as a common routine that is set up via scripting (rather than programming).

The following topics describe basic concepts related to service scripts.

A Service Script's API

As with any common routine, a service script must declare its input / output parameters (i.e., its API). A service script's API is defined on its [schema](#).

NOTE: Refer to [Schema Nodes and Attributes](#) for a complete list of the XML nodes and attributes available to you when you construct a schema.

Invoking Service Scripts

Any type of script configured to use a scripting engine version may [invoke a service script](#):

- A BPA script may invoke a service script to perform server-based processing.
- Plug-in scripts may invoke a service script (like a "common routine").
- A service script may call another service script (like a "common routine").

Map zones may be configured to invoke service scripts to obtain the data to be displayed. Refer to [Map Zones](#) for more information.

[Inbound web services](#) support interaction with service scripts allowing the outside world to interact directly with a service script.

You can also invoke a service script from a Java class.

Groovy Library Scripts

Just as service scripts can define common routines written in scripting language, Groovy library scripts are used to define groups of common components or methods written in Groovy. Groovy library code runs on the application server and performs server-based processing for scripts that utilize Groovy code.

The following topics describe basic concepts related to Groovy library scripts.

A Groovy Library Script's API

A Groovy library script's API is composed of one or more public methods whose code is defined in the script's steps. Those methods are defined in a step type of **Groovy Library Interface**. A Groovy library script must have one (and only one) step of this type.

Invoking Groovy Library Methods

Any type of script that supports the **Groovy Members** step type may invoke common methods defined in Groovy library scripts.

Code within a **Groovy Members** step must create an instance of the Groovy library interface definition to enable the interface methods to be invoked. Refer to the topic [Using Groovy Within Scripts](#) for more information.

Debugging Server-Based Scripts

The server can create log entries to help you debug your server scripts.

The logs contain a great deal of information including the contents of the referenced data area for **Move data**, **Invoke business object**, **Invoke business service** and **Invoke service script** steps.

Refer to the [Debug Mode](#) topic in the Configuration Tools chapter for details of how to execute the application in debug mode.

Maintaining Scripts

The script maintenance transaction is used to maintain your scripts. The topics in this section describe how to use this transaction.

FASTPATH: Refer to [The Big Picture Of Scripts](#) for more information about scripts.

Script - Main

Use this page to define basic information about a script. Open this page using **Admin > System > Script**.

Use the **Script Query** portal to search for an existing script. Once a script is selected, you are brought to the maintenance portal to view and maintain the selected record.

NOTE: Script Tips. A context sensitive "Script Tips" zone is associated with this page. The zone provides links to [Edit Data Syntax](#) and [Advanced Schema Topics](#) so that users can quickly access those online help topics to aid in constructing scripts. In addition, the zone provides links to view the [Groovy Javadocs](#) viewer and the allowlist of third party Groovy classes so that users can verify the restricted list of classes available for Groovy coding in the script.

Description of Page

Enter a unique **Script** code and **Description** for the script. Use the **Detailed Description** to describe the purpose of this script in detail. **Owner** indicates if the script is owned by the base package or by your implementation (**Customer Modification**).

CAUTION: Important! If you introduce a new script, carefully consider its naming convention. Refer to [System Data Naming Convention](#) for more information.

Script Type indicates if this is a **BPA Script**, **Plug-In Script**, **Groovy Library Script** or **Service Script**. Refer to [The Big Picture Of BPA Scripts](#) and [The Big Picture Of Server Based Scripts](#) for more information.

Accessibility Option appears only for BPA scripts. Set this value to **Accessible from Script Menu** for any script that may be launched as a stand-alone script. Scripts with this configuration may be linked to a navigation option so that they may be invoked from a menu and may be configured by a user as a favorite script. Set this value to **Not Accessible from Script Menu** for any script that cannot be launched on its own. For example, any script that is invoked as a sub-script from another script should have this setting. In addition, any script that is designed to be launched from within a specific portal where certain data is provided to the script should include this setting.

Enter an **Application Service** if the execution of the script should be secured. The application service should include **Execute** as one of its access modes. Refer to [Securing Script Execution](#) for more information. This field does not appear if the script type is **Groovy Library Script**.

Algorithm Entity appears only for [plug-in scripts](#). Use this field to define the [algorithm entity](#) into which this script can be plugged in.

Business Object appears only for business object related plug-in scripts. Enter the [Business Object](#) whose elements are to be referenced by the plug-in script.

Script Engine Version defines key information affecting the context and execution of the script.

- Script engine version values of 1, 2 and 3 define the version of the XML Path Language (XPath) to be used for the script. Versions 2 and 3 use the XPath 2 engine supplied by the XQuery team. This is the same engine used inside the Oracle database. The current script engine version 3 is a modified version that offers performance improvements without impacting existing version 2 scripts.

The default script engine version is 3.0 for plug-in and service scripts. The default version for BPA scripts is 1.0 as higher level versions are not applicable.

There are some additional details to note about script engine version 1.0:

- The XPath library used is Jaxen
- For BPA scripts, it uses the browser's xpath and XML support except for Internet Explorer where the XSD parser is used.
- XPath 1 (and even JavaScript) uses floating point arithmetic, which means that adding a collection of numbers with two decimal places might end up with a value of 10779.079999999998 instead of 10779.08
- A Script Engine Version value of **Groovy** is only applicable to plug-in scripts. It is used to indicate that only Groovy related step types are used in the script and signals to the system that there is no need to convert the data to and from an XML interface. This allows for greater efficiency in script execution.
- The value **Framework Version 2.1 Compatibility Mode** remains for upgrade purposes. This value should only be applicable to early versions of BPA scripts using syntax that is incompatible with XPath syntax.

NOTE: The **Script Engine Version** field does not appear for **Groovy Library** scripts. The script engine version for these scripts is set to **Groovy** by default and cannot be changed.

Click the **View Script Schema** to view the [script's data areas](#) on the [schema viewer](#) window. This link does not appear if the script engine version is **Groovy**.

Click the **View XSD** hyperlink to view a script's schema definition in XSD format. This link only appears if the script type is **BPA Script** or **Service Script**.

The **View Script Superclass** hyperlink appears only for plug-in scripts using an engine version of **Groovy**. Click this link to view the code of the runtime generated superclass for the related plug-in spot's implementation.

The **View Script As Text** hyperlink appears for server-based scripts only. Click this link to view the internal scripting commands in a separate window.

The [tree](#) summarizes the script's steps. You can use the hyperlink to transfer to the **Step** tab with the corresponding step displayed.

Script - Step

Use this page to add or update a script's steps. Open this page using **Admin > System > Script** and then navigate to the **Step** tab.

NOTE: Time saver. You can navigate to a step by clicking on the respective node in the tree on the Main tab.

Description of Page

The **Steps** accordion contains an entry for every step linked to the script. When a script is initially displayed, its steps are collapsed. To see a step's details, simply click on the step's summary bar. You can re-click the bar to collapse the step's details. Please see [accordions](#) for the details of other features you can use to save time.

Select the **Step Type** that corresponds with the step. Refer to [How To Set Up Each Step Type](#) for an overview of the step types.

CAUTION: The Step Type affects what you can enter on other parts of this page. The remainder of this section is devoted to those fields that can be entered regardless of Step Type. The subtopics that follow describe those fields whose entry is contingent on the Step Type.

Step Sequence defines the relative position of this step in respect of the other steps. The position is important because it defines the order in which the step is executed. You should only change a Step Sequence if you need to reposition this step.

But take care; if you change the Step Sequence and the step is referenced on other steps, you'll have to change all of the referencing steps.

NOTE: Leave gaps in the sequence numbers. Make sure you leave space between sequence numbers so that you can add new steps between existing ones in the future. If you run out of space, you can use the **Renumber** button to renumber all of the steps. This will renumber the script's steps by 10 and change all related references accordingly.

Display Step is only enabled on BPA scripts for step types that typically don't cause information to be displayed in the [script area](#) (i.e., step types like **Conditional Branch**, **Go to a step**, **Height**, etc). If you turn on this switch, information about the step is displayed in the script area to help you debug the script.

CAUTION: Remember to turn this switch off when you're ready to let users use this script.

NOTE: If **Display Step** is turned on and the step has **Text**, this information will be displayed in the script area. If **Display Step** is turned on and the step does not have **Text**, a system-generated messages describing what the step does is displayed in the script area.

Display Icon controls the [icon](#) that prefixes the **Text** that's displayed in the script area. Using an icon on a step is optional. This field is only applicable to BPA scripts.

Text is the information that displays in the [script area](#) when the step executes. You need only define text for steps that cause something to display in the script area.

FASTPATH: Refer to [How To Substitute Variables In Text](#) for a discussion about how to substitute variables in a text string.

FASTPATH: Refer to [How To Use HTML Tags And Spans In Text](#) for a discussion about how to format (with colors and fonts) the text that appears in the script area.

The other fields on this page are dependent on the **Step Type**. The topics that follow briefly describe each step type's fields and provide additional information about steps.

Click on the **View Script Schema** hyperlink to view the script's data areas. Doing this opens the [schema viewer](#) window.

The **View Script As Text** hyperlink appears for server-based scripts only. Click this link to view the internal scripting commands in a separate window. The presented script syntax is valid within [edit data](#) steps.

How To Set Up Each Step Type

The contents of this section describe how to set up each type of step. Note that some step types are only applicable for BPA scripts and some step types are only supported for server based scripts. Each section indicates whether there are any script type limitations.

Conditional Branch Steps

Conditional branch steps allow you to conditionally jump to a different step based on logical criteria. For example, you could jump to a different step in a script if the customer is residential as opposed to commercial. In addition, several fields are required for **Conditional Branch** steps:

Compare Field Type and **Compare Field Name** define the first operand in the comparison. The **Field Type** defines where the field is located. The **Field Name** defines the name of the field. The following points describe each field type:

- **Current To Do Information.** Use this field type when the field being compared resides on the current To Do entry. Refer to [How To Use To Do Fields](#) for instructions on how to define the appropriate **Field Name**.

- **Data Area.** Use this field type when the field being compared is one that you put into one of the scripts data areas in an earlier step. **Field Name** must reference both a data area structure name as well as the field, for example "parm/charType". Refer to [How To Reference Fields In Data Areas](#) for instructions on how to construct the appropriate **Field Name**.
- **Page Data Model.** Use this field type when the field being compared resides on one of the tab pages in the [object display area](#). Refer to [How To Find The Name Of Page Data Model Fields](#) for instructions on how to find the appropriate **Field Name**.
- **Predefined Value.** Use this field type when the field being compared is a [global variable](#).
- **Temporary Storage.** Use this field type when the field being compared is one that you put into temporary storage in an earlier step. The **Field Name** must be the same as defined in an earlier step.
- **User Interface Field.** Use this field type when the field being compared resides on the currently displayed tab page. Refer to [How To Find The Name Of User Interface Fields](#) for instructions on how to find the appropriate **Field Name**.

Condition defines the comparison criteria:

- Use >, <, =, >=, <=, <> (not equal) to compare the field using standard logical operators. Enter the comparison value using the following fields.
- Use **In** to compare the first field to a list of values. Each value is separated by a comma. For example, if a field value must equal **1, 3** or **9**, you would enter a comparison value of **1,3,9**.
- Use **Between** to compare the field to a range of values. For example, if a field value must be between **1** and **9**, you would enter a comparison value of **1,9**. Note, the comparison is inclusive of the low and high values.

Comparison Field Type, Comparison Field Name and **Comparison Value** define what you're comparing the first operand to. The following points describe each field type:

- **Current To Do Information.** Use this field type when the comparison value resides on the current To Do entry. Refer to [How To Use To Do Fields](#) for instructions on how to define the appropriate **Field Name**.
- **Data Area.** Use this field type when the comparison value resides in one of the scripts data areas. **Field Name** must reference both a data area structure name as well as the field, for example "parm/charType". Refer to [How To Reference Fields In Data Areas](#) for instructions on how to construct the appropriate **Field Name**.
- **Page Data Model.** Use this field type when the comparison value resides on one of the tab pages in the [object display area](#). Refer to [How To Find The Name Of Page Data Model Fields](#) for instructions on how to find the appropriate **Field Name**.
- **Predefined Value.** Use this field type when the field being compared is a constant value defined in the script. When this field type is used, use **Comparison Value** to define the constant value. Refer to [How To Use Constants In Scripts](#) for instructions on how to use constants.
- **Temporary Storage.** Use this field type when the comparison value is a field that you put into temporary storage in an earlier step. The **Field Name** must be the same as defined in an earlier step.
- **User Interface Field.** Use this field type when the comparison value resides on the currently displayed tab page. Refer to [How To Find The Name Of User Interface Fields](#) for instructions on how to find the appropriate **Field Name**.

NOTE: Conditional field types. The field types **Current To Do Information, Page Data Model** and **User Interface Field** are only applicable to BPA scripts. Only the field types **Temporary Storage** and **Predefined Value** are applicable when the Condition is **In** or **Between**.

The above fields allow you to perform a comparison that results in a value of **TRUE** or **FALSE**. The remaining fields control the step to which control is passed given the value:

- **If True, Go to** defines the step that is executed if the comparison results in a **TRUE** value.
- **If False, Go to** defines the step that is executed if the comparison results in a **FALSE** value.

NOTE: Numeric Comparison. Comparison of two values may be numeric or textual (left-to-right). Numeric comparison takes place only when values on both side of the comparison are recognized as numeric by the system. Otherwise, textual comparison is used. Fields for **Current To Do Information**, **Data Area**, **Page Data Model**, and **User Interface Field** types are explicitly associated with a data type and therefore can be recognized as numeric or not. This is not the case for fields residing in **Temporary Storage** or those set as **Predefined Values**. A **Temporary Storage** field is considered numeric if it either holds a numeric value moved to it from an explicitly defined numeric value (see above) or it is a resultant field of mathematical operation. A **Predefined Value** field is considered numeric if the other field it is compared to is numeric. For example, if a numeric field is compared to a **Predefined Value** the latter is considered numeric as well resulting in numeric value comparison. However, if the two fields are defined as **Predefined Values** the system assumes their values are text strings and therefore applies textual comparison.

Display Text Steps

NOTE: BPA scripts only. This step type is only applicable to BPA scripts.

Display text steps cause a text string to be displayed in the script area. Steps of this type can be used to provide the user with guidance when manual actions are necessary. In addition, they can be used to provide confirmation of the completion of tasks.

The information you enter in the **Text** field is displayed in the [script area](#) when the step is executed.

The text string can contain [substitution variables](#) and [HTML formatting commands](#). Also note that for debugging purposes, you can display an entire data area (or a portion thereof) by entering `%+...+%` where `...` is the name of the node whose element(s) should be displayed.

Edit Data Steps

Edit data steps provide a free format region where you can specify commands to control your script processing.

Enter your scripting commands in the **Edit Data Text** field. Click the adjacent icon to open a window providing more space for defining the edit data step.

In general, the syntax available within edit data mimics the commands available within the explicit step types. However, there are a few commands that are available only within edit data. For example, the two structured commands: **For**, and **If**.

NOTE: Not all BPA step types are supported using the edit data syntax. Refer to the details below for more information on edit data commands and examples.

The topics in this section provide detail of the syntax supported in the edit data step type.

Contents

- [Comments](#)
- [Temporary Variables](#)
- [Context Variables](#)
- [Move Statement](#)
- [Go To Statement](#)
- [Conditional Branch Statement](#)
- [If Statement](#)
- [For Statement](#)
- [List Processing](#)
- [Functions for Processing a List](#)
- [Declare and Invoke Schema Based Objects](#)
- [System and Global Variables](#)
- [Perform Script and Transfer](#)
- [Navigate Statement](#)
- [Invoke Map Statement](#)
- [Declare BO with BO Group](#)
- [Generate Edit Map Statements](#)
- [Terminate Statement](#)
- [Invoking Groovy Code](#)
- [Debugging a BPA Script](#)
- [Useful Tips and Tricks](#)

Comments

You can place comments into your script using the double slash notation `//` in the first two characters of the edit data step.

Example:

```
//  
// quit with error  
//  
if ("not(customer/securityEnabled)")  
terminate with error (8000, 1001 %1="customer/id" %2='not allowed');  
end-if;
```

Temporary Variables

Temporary variables can be declared within all types of scripts. They should be referenced by a leading single dollar sign (`$`). However, temporary variables behave differently in the various script types:

- In BPA Scripts temporary variables remain persistent from one BPA script to another (refer to the [Perform Script and Transfer Control statements](#)), which means that you can use temporary variables to communicate between BPA scripts.
- Temporary variables cannot be passed from a BPA script to a service or plug-in script. Only data area elements can be passed between these types of scripts.
- Within service and plug-in scripts, temporary variables remain persistent only for the life of the particular script that declared the variable. This means that temporary variables cannot be passed between plug-in scripts and service scripts, only [global variables](#), [context variables](#) and data area elements can be passed between these types of scripts.

Declaring / Initializing / Defaulting Temporary Variables

When using a temporary variable, it should be declared or initialized with an appropriate value before using it. A typical method for declaring a variable is to simply move data to it in a move statement, for example.

```
move "0" to $index;
```

FASTPATH: Refer to [Move to a Temporary Variable](#) for more information on implicit declaration of a temporary variable within a move statement.

For BPA scripts, as mentioned above, temporary variables may be passed from one BPA script to another. As such, it is common to reference a temporary variable in a BPA that should have been initialized by a previous BPA. However, if there is any reason that a temporary variable did not get initialized by a previous BPA, a reference to it will cause an error. It is good practice, therefore, to use the **default** statement that will initialize temporary variables that are not already created / initialized.

- The following statement will initialize the temporary variable \$InputAction – but only if the temporary variable has not yet been initialized:

```
default $InputAction;
```

- The following statement will set the value of the temporary variable \$InputAction to 'read' – but only if the variable has not yet been initialized:

```
default $InputAction as 'read';
```

NOTE: Scripts should take care not to define variables using a reserved keyword. The following table lists the reserved keywords.

Keyword

add

as

asError

bpa

branch

data

declareBO

declareBS

declareDA

declareMap

declareSS

default

delete

edit

element

else

end-edit

end-for

end-if

error

escape

evaluate

fastAdd

fastUpdate

for

goto

Keyword

if

in

invokeBO

invokeBS

invokeMap

invokeSS

label

map

move

navigate

navigateAndReloadDashboard

null

page

performScript

popup

read

readWithoutVersion

replace

suppress

target

terminate

to

transferControl

update

using

warn

with

Context Variables

Context variables are only available within service scripts. The context variable will be available for the duration of the service script and all that it invokes. Therefore, you can use a context variable within a service script to communicate information to a lower level service script or schema. They should be referenced by leading double dollar signs ('\$\$').

NOTE: Because context variables are available for lower level scripts, they may sometimes be referred to as global variables or global context variables. But they should not be confused with [global variables](#).

Declaring / Initializing / Defaulting Context Variables

When using a context variable, it should be declared or initialized with an appropriate value before using it. A typical method for declaring a variable is to simply move data to it in a move statement, for example.

```
move 'context variable' to $$contextVariable;
```

FASTPATH: Refer to [Move using a Context Variable](#) for more information.

Move Statement

The **move** statement copies a source value to a target. The following table highlights various options supported in the move statement.

Statement	Example Description	Example Syntax
Move to Element move "xpath" to "xpath";	Move statement with simple XPath reference.	<pre>move "acct/totalBalance" to "parm/formattedValue";</pre>
NOTE: An XPath expression is surrounded by double quotes.	Move statement with XPath concatenate function.	<pre>move "concat(person/ firstName, ', ', person/lastName)" to "parm/fullName";</pre>
	Move statement with XPath substring-before function.	<pre>move "substring-before(parm/ fullName, ', ')" to "person/firstName";</pre>
	Move statement with XPath substring-after function.	<pre>move "substring-after(parm/ fullName, ', ')" to "person/lastName";</pre>
	Move statement with XPath substring function.	<pre>move "substring(parm/date,1,4)" to "parm/year";</pre>
Move to Element move 'literal' to "xpath";	Move statement using a literal string.	<pre>move 'okay for mailing' to "account/ preferences[type="mail"]/text";</pre>
NOTE: A literal value is surrounded by single quotes.		
Move to Element move 'Boolean' to "xpath";	Move statement with Boolean as literal string.	<pre>if ("account/balance > 0") move 'true' to "account/hasDebitBalance"; end-if;</pre>
	Moving an expression, which results in a Boolean. Note that the filter in the example below is located on a group node.	<pre><schema> <account> <hasDebitBalance type="boolean"/ > <balance/> </account> </schema></pre> <pre>move "boolean(account[balance>0])" to "account/hasDebitBalance";</pre>
Move to Group move "xpath" to "xpath";	Move a set of elements from one group with another. The system matches the initial level of element names and the group / list names from the source schema to the target schema. For lists and groups, the default behavior is to move all elements within the source group / list to the target group / list (even if they are not defined in the target group / list). The business service F1-MoveByName may be used for more granular control of the move	<pre>move "account/ custInfo" to "person";</pre> <p>This statement is equivalent to the following statement:</p> <pre>move "account/custInfo/ *" to "person/*";</pre>

Statement	Example Description	Example Syntax
	(without having to define each individual move statement).	
Move using a Temporary Variable	When moving to a temporary local variable, it is not surrounded by double quotes. move "xpath" to \$variable;	<pre>move "count(Person/names/ personName) + count(Person/ids/personId) " to \$PersonChildCount;</pre>
	When moving from a temporary variable, the variable is surrounded by double quotes. move "\$variable" to "xpath";	<pre>move "\$AccountBalance" to "parm/formattedValue";</pre>
Move using a Context Variable move "xpath" to \$\$variable; move \$\$variable to "xpath";	Context variables, source or target, are referenced without any double quotes.	<pre>move 'context value' to \$\$contextVariable; // // here, we move from a context variable. move \$\$contextVariable to "MarketMessage/sender";</pre>
Move using a Dynamic Location move "xpath" 'literal' to evaluate("xpath" \$variable); move evaluate("xpath" \$variable) to "xpath" \$variable;	The evaluate statement allows your move source or target location to be dynamically derived from a variable or schema element location.	<pre>move 'literal' to evaluate("schemaLocation"); // move "schemaLocation" to evaluate(\$Variable); move evaluate("schemaLocation") to \$Variable; // move evaluate(\$Variable) to "schemaLocation";</pre>
Move escape move escape("xpath" \$variable) to "xpath" \$variable;	Move escape is only available for service scripts and plug-in scripts. The escape statement scans your source text value for HTML content and escapes it, i.e. replaces any HTML-like characters with special characters that are escaped from HTML rendering. By doing so the text would be displayed as plain text when displayed as part of an HTML element. NOTE: You should only use this function if the text is to be displayed as part of an HTML element and is suspected to contain HTML-like characters or even malicious HTML that should not be rendered as HTML. If incorrectly displayed using a non HTML element, the special escape characters, if any would be visible as part of your text. Refer to the UI Map Attributes and Functions for more information on how to define an element to display HTML content.	<pre>move escape("schemaLocation") to \$Variable; // move escape(\$Variable) to "schemaLocation";</pre>
Move null move null to "xpath";	You can remove information from the XML instance document through the special syntax of move 'null'. Note that you can specify either a node name in the XPath expression or a group name. If you specify a group then the group and all child elements will be eliminated from processing.	Remove a node and all of its child nodes: <pre>if ("boolean(customer/ securityEnabled)") goto updateInfo; else move null to "customer"; end-if;</pre>

Statement	Example Description	Example Syntax
		Remove all child nodes of a group node with the suffix <code>/*</code> . <pre>if ("boolean(customer/ securityEnabled)") move null to "customer/*"; end-if;</pre>

Go To Statement

The edit data step supports functionality analogous to the [Go To](#) step type. The syntax is **goto label**; where the label represents another location within the edit data text field (identified by this label) or represents another step in the script.

The following is an example of going to another location in the same step identified by the label **addSpouse**.

```
if ( "string(parm/spouse/name) != $BLANK" )
  goto addSpouse;
end-if;
addSpouse: invokeBO 'Person' using "parm/spouse" for add;
```

The following is an example of going to a different step within the same script. The step sequence is the reference used as the label.

```
if ( "string(parm/spouse/name) != $BLANK" )
  goto 110;
end-if;
.
.
.
110: invokeBO 'Person' using "parm/spouse" for add;
```

Conditional Branch Statement

The edit data step supports functionality analogous to the [Conditional Branch](#) step type. The syntax is **branch (“xpath”) goto label else label**; where:

- The XPath condition in the **branch** statement must evaluate to a Boolean value of True or False.
- The targets for the **goto** and **else** statements are labels that represent another location within the edit data text field (identified by this label) or represent another step in the script.

The following example uses labels for **addSpouse** and **addAccount**

```
branch ( "string(parm/spouse/name) != $BLANK" ) goto addSpouse else addAccount;
```

If Statement

The **if** statement is similar to the conditional branch statement. Either can be used to structure the logic of your script. This statement may optionally include an **else** statement but it should always end with an **end-if** statement.

NOTE: This is an example of a statement that is not represented as a separate step type. It is only available within the edit data text.

The syntax is **if (“xpath”) else end-if**; The XPath condition must evaluate to a Boolean value of True or False. The following are some examples.

Example where the XPath contains a simple logical condition.

```
if ( "string(parm/spouse/name) != $BLANK" )
  //
  // Create spouse since spouse name present
  goto addSpouse;
else
  //
  // Create account without spouse
```

```
goto addAccount;
end-if;
```

Example where the XPath contains a complex condition.

```
if ("string(parm/spouse/name) != $BLANK and string(parm/hasSpouse) = true or boolean(parm/requireSpouse)")
//
// Create spouse since spouse name present
goto addSpouse;
end-if;
```

Example of a stacked set of statements used to evaluate multiple possible values of a field.

```
if ("parm/rowCount = 0")
//
// no rows found
goto quit;
end-if;
if ("parm/rowCount = 1")
//
// one row found
goto process;
end-if;
if ("parm/rowCount > 1")
//
// more than one row found
goto quit;
end-if;
quit: terminate;
```

The following XPath shows Boolean based on the existence of the node. In this example, if the node exists in the XML instance document being processed, the statement will evaluate to True. If no element is found, the statement evaluates to false.

NOTE: When treating XPath nodes as Boolean variables be aware that an empty node evaluates to True. Only a missing node return False.

```
if ("boolean(parm/spouse/name)")
goto addSpouse;
else
//
// Create account without spouse
goto addAccount;
end-if;

if ("not(parm/spouse/name)")
//
// Create account without spouse
goto addAccount;
else
goto addSpouse;
end-if;
```

For Statement

The **for** statement creates a list of nodes or values depending on your XPath expression. If you specify a list node then every child node of the list, along with its contents, will be available within the loop. If you specify a child node directly, then a list of values only will be available within the loop.

NOTE: For more information on creating new entries in a list, please refer to the [creating a new list instance](#) example.

NOTE: This is an example of a statement that is not represented as a separate step type. It is only available within the edit data text.

The syntax is **for (\$variable in "xpathList") end-for**; The XPath condition must evaluate to a Boolean value of True or False.

The following examples are based on this sample schema:

```
<schema>
  <SAList type="list">
    <id/>
    <balance/>
  </SAList>
  <SAContributor type="list">
    <id/>
  </SAContributor>
</schema>
```

Example that specifies the list node in the XPath expression where all child nodes are available for processing.

```
move "0" to $AccountBalance;
move "0" to $index;
for ($SAList in "SAList")
  move "$SAList/balance + $AccountBalance" to $AccountBalance;
  //
  // keep track of each SA contributing to the balance in the SA Contributor list
  move "1 + $index" to $index;
  move "$SAList/id" to "SAContributor[$index]/id";
end-for;
```

Example that specifies a child node within the list node in the XPath expression. Only values of that node are available for processing.

```
move "0" to $AccountBalance;
for ($SABalance in "SAList/balance")
  move "$SABalance + $AccountBalance" to $AccountBalance;
end-for;
```

Example that shows that a filter can be used to limit the rows selected by the **for** loop.

```
move "0" to $AccountDebitBalance;
for ($SAList in "SAList[Balance>0]")
  move "$SAList/balance + $AccountDebitBalance" to $AccountDebitBalance;
end-for;
```

Example that shows the use of a filter when specifying child nodes.

```
move "0" to $AccountCreditBalance;
for ($SABalance in "SAList[Balance<0]/balance")
  move "$SABalance + $AccountCreditBalance" to $AccountCreditBalance;
end-for;
```

List Processing

This section provides details about processing lists. The examples in this section reference the following schema:

```
<schema>
  <parm type="group">
    <name/>
  </parm>
  <Person type="group">
    <names type="list">
      <type/>
      <name/>
    </names>
  </Person>
</schema>
```

Referencing a List Element. You can move a value to a particular list instance by referencing an identifying node in the list within a filter. The syntax is **move "xpath" to "xpathList[filter]/element"**; Example:

```
move "parm/name" to "Person/names[type='main']/name";
```

Creating a New List Instance. A special notation can be used within a move target statement to indicate a new list instance should be created. The "+" indicates to the script processor that a new instance of a list should be initiated for the target element. The syntax is **move "xpath" to "+xpathList"**; Example:

```
move "parm/name" to "Person/+names/name";
```

Deleting a List Instance. An XML list entry can be deleted from the database by moving an action attribute of 'delete' to the element name. To cause a database delete of a list entry requires an attribute of action="delete" in the target node and a subsequent update BO interaction. The syntax is **move 'delete' to 'xpathList@action'**); Example:

```
if ("parm/action = 'd'")
  move "0" to $index;
  for ($CCList in "CCList")
    move "1 + $index" to $index;
    if ("CCList/id = parm/id")
      move 'delete' to "CCList[$index]@action";
      goto update;
    end-if;
  end-for;
end-if;
```

The following shows the resulting XML.

```
<root>
  <CCList>
    <id>9876538976</id>
    <balance>309.98</balance>
  </CCList>
  <CCList action="delete">
    <id>4321125899</id>
    <balance>87.45</balance>
  </CCList>
</root>
```

NOTE: Deleting a list instance through use of the action attribute is risky if iterative BO interactions are required. The XML document that contains the list instance to be deleted will not be altered after a successful BO interaction, which means the document will still contain the list instance even though it no longer exists. To solve this problem, it is essential to re-read the BO after any BO update where the action attribute of 'delete' has been used.

NOTE: An alternative to the delete attribute described here, is to use the BO action of [replace](#). Manipulating a list to use the replace action avoids the problem described above concerning stale information in request documents post BO update.

Functions for Processing a List

XPath provides several functions that are useful to process elements of a list including **count**, **sum** and **last**.

The following examples are based on this sample XML document:

```
<xml>
  <ft>
    <type>bill</type>
    <date>20100101</date>
    <amt>30.30</amt>
    <cat>tax</cat>
  </ft>
  <ft>
    <type>adj</type>
    <date>20100301</date>
    <amt>20.20</amt>
    <cat>int</cat>
  </ft>
  <ft>
    <type>bill</type>
    <date>20100201</date>
    <amt>10.10</amt>
    <cat>tax</cat>
```

```
</ft>
</xml>
```

The following is an example of a sum. The syntax is **move "sum(xpathList/element)" to \$variable**; The example sums the total balance.

```
move "sum(ft/amt)" to $TotalBalance;
```

The following is an example of a sum using a filter to get a subtotal. The example sums the balance of the entries that have the 'tax' category.

```
move "sum(ft[cat='tax']/amt)" to $TaxBalance;
```

The following is an example of a count. The syntax is **move "count(xpathList)" to \$variable**; The example finds the count of the number of FT entries in the list.

```
move "count(ft)" to $TranCount;
```

The following is an example of 'last', which is used to locate the last entry. The syntax is **move "last(xpathList)" to \$variable**; The example finds the last amount in the FT list.

```
move "ft[last()]/amt" to $LastAmount;
```

Declare and Invoke Schema Based Objects

You can invoke a business object, business service or service script within the edit data step. To support the dynamic invoke, a dynamic data area name can be declared.

The schema being declared may be a business object (BO) schema, a business service (BS) schema, a service script (SS) schema, data area (DA) schema or a UI map schema. The declare statement will differ based on the type of schema, but the syntax is analogous.

- **declareBO 'BO Name' | \$variable | "xpath" as 'DynamicDataArea';**
- **declareBS 'BS Name' | \$variable | "xpath" as 'DynamicDataArea';**
- **declareSS 'SS Name' | \$variable | "xpath" as 'DynamicDataArea';**
- **declareDA 'DA Name' | \$variable | "xpath" as 'DynamicDataArea';**
- **declareMap 'Map Name' | \$variable | "xpath" as 'DynamicDataArea';**

When invoking a BO, BS or SS, the name of the object can be specified as a literal or it can be a value contained within an element or a variable. For every Invoke, you must supply an XPath reference to a group name.

When invoking a business object, an action must be supplied. The syntax is **invokeBO 'BO Name' | \$variable | "xpath" using "xpath" for action**; The valid actions are as follows:

- **read.** This action reads the current view of the BO data.
- **add.** This action will add the object and read and return the resulting view of the BO.
- **fastAdd.** This action will add the object but does not perform a subsequent 'read' to return the resulting view of the BO. This option is better than add for performance purposes if there is no reason to re-read the record.
- **update.** This action will update the object and read and return the resulting view of the BO. This action executes a 'merge' of the information specified in the invoke statement's request XML document with existing BO data. Using this action allows the script to only indicate the elements that are changing.
- **fastUpdate.** This action will update the object but does not perform a subsequent 'read' to return the resulting view of the BO. This option is better than update for performance purposes if there is no reason to re-read the record.
- **delete.** This action deletes the object.
- **replace.** This action is an alternate to the update action. The replace action completely replaces existing BO data with the information in the request document. Typically, the replace action is used when a BO contains a list because it is easier to simply replace all instances of a list rather than attempt a list merge, which requires special logic to [delete a list instance](#) explicitly.

NOTE: The replace action must be used when using the UI map functionality to [Upload a CSV File](#).

NOTE: The replace action is currently not supported for any maintenance object that is maintained in a 'fixed' page that uses a list metaphor to show all the records in the page at once. Currency is an example of this type of page.

Examples:

```
invokeBO 'BusinessObject' using "dataArea" for fastAdd;
invokeBO $variableBO using "dataArea" for fastUpdate;
invokeBO "daName/boElement" using "dataArea" for replace;
```

The syntax of the invoke statements for both a business service and service script are similar. The BS / SS is specified along with the XPath reference to the group name:

- **invokeBS 'BS Name' | \$variable | "xpath" using "xpath";**
- **invokeSS 'SS Name' | \$variable | "xpath" using "xpath";**

The examples use the **invokeBS** statement but the statements are similar for the **invokeSS** statement.

```
invokeBS 'BusinessService' using "dataArea";
invokeBS $variableBS using "dataArea";
invokeBS "daName/bsElement" using "dataArea";
```

BO Warnings. Note that for BPA scripting, the **invoke** statements may also indicate how to handle warnings.

Syntax	Description	Examples
with warn asError	Indicates that a warning should be treated as an error displayed in the UI map. The text asError is optional.	<pre>invokeBO 'BusinessObject' using "dataArea" for add; invokeSS 'ServiceScript' using "dataArea" with warn asError;</pre>
with warn popup	Indicates that a warning should be presented in the standard framework popup. In this scenario, the user is presented with standard OK and Cancel buttons. If the user clicks OK, it means that the process should continue. If the user clicks Cancel, the processing should discontinue. This is the recommended setting.	<pre>invokeBS "daName/bsElement" using "dataArea" with warn popup;</pre>
with warn suppress	Indicates that a warning should be suppressed. This is the default if no warning syntax is added to the invoke statement.	<pre>invokeBS "daName/bsElement" using "dataArea" with warn suppress; invokeSS 'ServiceScript' using "dataArea";</pre>

NOTE: For service scripts, all objects invoked from the service script will inherit their warning level. Therefore, if the service script is invoked **with warn**, all nested invoke statements will also be invoked **with warn**.

For BPA scripts, there should also be logic following the invocation to handle errors and warnings (if **with warn as popup** is used). The system variable **\$WARNING** is set to **true** if the user has clicked the Cancel button in the warning popup. If a map was shown, the logic should redisplay the map (where the warning message will be redisplayed.) This allows the user to potentially make changes and save again. If no map was shown prior to the warning, then the logic should terminate.

The system variable **\$ERROR** indicates that an error was received. If a map was shown prior to the error, then the logic should redisplay the map where the error will be shown. If no map was shown, then the product provides a BPA Script **F1-HandleErr** that should be used to display the error. The following is an example of typical error handling logic.

```
invokeBO "F1-DetermineBo/output/bo" using "boSchema" for update with warn popup;
```

```

if (" $WARNING")
  if ("map_schema/action = 'DEL'")
    terminate;
  else
    goto maintMap;
  end-if;
end-if;
if (" $ERROR")
  if ("map_schema/action != 'DEL'")
    goto maintMap;
  else
    transferControl 'F1-HandleErr';
  end-if;
end-if;

```

System and Global Variables

The following tables highlight system and global variables available for script writing.

System Variables - All Script Types

The following system variables are available for all script types (service scripts, plug-in scripts, and BPA scripts).

Variable	Description	Example
\$BLANK	Represents an empty node.	<pre> if ("string(parm/spouse/name) != \$BLANK") goto addSpouse; end-if; </pre>
\$CURRENT-DATE	<p>Represents the current date.</p> <p>For BPA scripts, this is the browser date.</p> <p>For server scripts this is the server date (and is affected by the system date override logic).</p>	<pre> move "\$CURRENT-DATE" to \$tempDate; </pre>
\$CURRENT-STD-DTTM	Represents the current date-time expressed in standard time (meaning without any adjustments for summer time / daylight savings time).	<pre> move "\$CURRENT-STD-DTTM" to \$tempDateTime; </pre>
\$DEVICE-OS	Represents the user's device operating system.	<pre> move "\$DEVICE-OS" to \$tempDeviceOs; </pre>
\$DEVICE-BROWSER	Represents the user's device browser.	<pre> move "\$DEVICE-BROWSER" to \$tempDeviceBrowser; </pre>
\$DEVICE-DISPLAY-TYPE	Represents the user's device screen display type whether it is Desktop size or Medium or Small size. Returned values may be like oraDesktop, oraTablet and oraPhone.	<pre> move "\$DEVICE-DISPLAY-TYPE" to \$tempDeviceDisplayType; </pre>
\$DEVICE-INFO	Provides the combination of all three device properties (DEVICE-OS, DEVICE-BROWSER and DEVICE-DISPLAY-TYPE) and each property value is separated by semi-colon.	<pre> move "\$DEVICE-INFO" to \$tempDeviceInfo; </pre>

System Variables - BPA Scripts Only

The following system variables are only available / applicable for BPA script types.

Variable	Description	Example
\$DOUBLE_QUOTE	Represents a double quote.	<code>move "\$DOUBLE_QUOTE" to \$tempField;</code>
\$SINGLE_QUOTE	Represents an apostrophe.	<code>move "\$SINGLE_QUOTE" to \$tempField;</code>
\$SPACE	Contains a single space value.	<code>move "\$SPACE" to \$tempField;</code>
\$SYSTEM-DATE	Represents the server date. Note that this date is affected by the system date override logic)	<code>move "\$SYSTEM-DATE" to \$tempDate;</code>

System Variables - Server Scripts Only

The following system variables are only available / applicable for service script and plug-in script types.

Variable	Description	Example
\$ADDITIONAL-IP-INFO	An HTTP request includes an "additional IP address" header field. This may be populated by an implementation if there is some information available on the proxy server or load balancer, such as the originating IP address.	<code>move "\$ADDITIONAL-IP-INFO" to "parm/request/headerIpAddress";</code>
\$CURRENT-DTTM	Represents the current date-time.	<code>move "\$CURRENT-DTTM" to \$tempDateTime;</code>
\$F1-INSTALLATION-TIMEZONE	Represents the time zone code defined on the installation options .	<code>move "\$F1-INSTALLATION-TIMEZONE" to \$timeZone;</code>
\$LANGUAGE	Represents the language code the script is using. Typically this is the user's default language.	<code>move "\$LANGUAGE" to \$tempLanguage;</code>
\$PROCESS-DATE	Represents the process date. The process date differs from the current date because the process date will remain consistent throughout the duration of the process being executed. For example, if a service script stores several business objects – the process date is initialized at the start of the service script execution and each business object will have the same process date defaulted. The current date, especially the current date time, will reflect the actual time of processing.	<code>move "\$PROCESS-DATE" to \$tempDate;</code>
\$PROCESS-DTTM	Represents the process date-time. Note that the process date and time is initialized at the start of a particular process and will not reflect the exact date and time of an update.	<code>move "\$PROCESS-DTTM" to \$tempDateTime;</code>
\$REQUESTING-IP-ADDRESS	Represents the IP address from the HTTP request. Note that if the request is routed through a proxy server or load balancer, this IP address is be the IP address of the proxy or load balancer, not the IP address of the end user. Refer to the \$ADDITIONAL-IP-INFO variable for information.	<code>move "\$REQUESTING-IP-ADDRESS" to "parm/request/systemIpAddress";</code>
\$USER	Represents the user ID of the user executing the script.	<code>move "\$USER" to \$tempUser;</code>

Variable	Description	Example
		For BPA scripts that need to know the user ID of the current user, refer to Useful Tips and Tricks .

Global Variables

BPA scripts and service scripts have access to the values defined in [Global Context](#).

When a BPA script is launched from the user interface, these variables will be automatically initialized. They may be referenced with a single dollar sign in front of the field name. For example if PER_ID is a supported global variable, then \$PER_ID can be referenced within the BPA script:

```
move "$PER_ID" to "schema/customerId";
```

For service scripts, global variables may only be referenced if the service script has been invoked directly from a BPA script or a zone on a portal. When a service script is invoked from a BPA script or portal zone, it will have access to the suite of global context variables populated in the UI session. For service scripting, the global fields must be prefixed by two dollar signs (instead of one like in BPA scripting). For example if PER_ID is a supported global context variable, then \$\$PER_ID can be referenced within the service script.

```
move $$PER_ID to "schema/customerId";
```

NOTE: As described in [Context Variables](#), a service script may declare context variables that use the same two dollar sign syntax.

Perform Script and Transfer Control Statements

The edit data step supports functionality analogous to the [Perform script](#) step type and the [Transfer Control](#) step type. These are both applicable only to BPA scripts.

Syntax	Valid Values	Comments
performScript	'BPA Script Name'	Script to perform is explicitly provided.
	\$Variable	Script to perform is found in a variable.
	"XPath"	Script to perform is found in an element, referenced by its XPath.
transferControl	Analogous to the performScript statement	

NOTE: When the script named in the **performScript** statement has finished, control will be returned to the calling BPA script. When the script named in the **transferControl** statement has finished, you will not be returned to the calling script, complete control will be granted to the transferred to script.

Navigate Statement

The edit data step supports functionality analogous to the [Navigate to a page](#) step type. This is applicable only to BPA scripts.

Syntax	Valid Values	Comments
navigate	'Navigation Code'	Navigation option is explicitly provided.
	\$Variable	Navigation option is found in a variable.
	"XPath"	Navigation option is found in an element, referenced by its XPath.

In addition, the edit data step supports the ability to indicate that the dashboard should be refreshed when navigating. This is only applicable to BPA scripts.

Syntax	Valid Values
navigateAndReloadDashboard	Analogous to the navigate statement

Declare BO with BO Group

This statement is specific to BPA scripts that plan to use the base script Main BO Maintenance Processing (**F1–MainProc**) for its Generate Edit Map statements. This script expects that the data used to display in the map is within a **boGroup** tag.

Syntax	Valid Values	Comments
declareBOWithBOGroup	'BO Name'	BO is explicitly provided.
	\$Variable	BO is found in a variable.
	"XPath"	BO is found in an element, referenced by its XPath.

The following table highlights additional syntax for this statement.

Syntax	Valid Values
as	'Dynamic Schema Name'

Examples:

```
declareBOWithBOGroup 'BusinessObject' as 'newMapSchema';
declareBOWithBOGroup $variableBO as 'newMapSchema';
declareBOWithBOGroup "daName/boElement" as 'newMapSchema';
```

Invoke Map Statement

The edit data step supports functionality analogous to the [Invoke map](#) step type. This is applicable only to BPA scripts.

Syntax	Valid Values	Comments
invokeMap	'Map Name'	UI Map is explicitly provided.
	\$Variable	UI Map is found in a variable.
	"XPath"	UI Map is found in an element, referenced by its XPath.

The following table highlights additional syntax for this statement.

Syntax	Valid Values	Comments
using	"Data Area group name"	Indicates the data area to be passed to and from the server when rendering the HTML form associated with the map.
target	bpa	
	page	
	popup	

Refer to the [Invoke map](#) step type for more information about the **target** values.

If the UI map is configured to return a value, then it can be evaluated using the **\$MAP-VALUE** variable.

```
invokeMap 'UI Map' using "dataArea";  
invokeMap $variableMap using "dataArea";  
invokeMap "daName/mapElement" using "dataArea" target bpa;  
  
// $MAP-VALUE is a variable returned by the invoked map.  
if ("$MAP-VALUE='continue' ")  
    goto 300;  
else  
    terminate;  
end if;
```

Generate Edit Map Statements

The 'generate edit map' statements are used to dynamically generate and launch a UI edit map based on a schema definition. The schema used may be a BO schema, a BS schema, an SS schema or a DA schema. This is applicable only to BPA scripts. The generate statement will differ based on the type of schema, but the syntax is analogous.

Syntax

generateBOEditMap

generateBSEditMap

generateSSEditMap

generateDAEditMap

The BO code / BS code / SS code / DA code may be specified using a literal (surrounded by single quotes), as a temporary variable or by referencing an XPath schema location (surrounded by double quotes).

The following table highlights additional syntax for this statement.

Syntax	Valid Values	Comments
using	"Data Area group name"	Indicates the data area to be passed to and from the server when rendering the HTML form associated with the map.
target	bpa page popup	

The target values indicate where the generated map should be displayed as described in the [Invoke map](#) step type. If the UI map is configured to return a value, then it can be evaluated using the **\$MAP-VALUE** variable.

The examples use the **generateBOEditMap** but the statements are similar for the other schema types.

```
generateBOEditMap 'BO Name' using "dataArea";  
generateBOEditMap $variableMap using "dataArea";  
generateBOEditMap "daName/mapElement" using "dataArea" target bpa;  
  
// $MAP-VALUE is a variable returned by the invoked map.  
if ("$MAP-VALUE='continue' ")  
    goto 300;  
else  
    terminate;  
end if;
```

Terminate Statement

The edit data step supports functionality analogous to the [Terminate](#) step type.

The following is an example of a simple **terminate** step that will stop the script.

```
if ( "not (parm/spouse/name) " )
  terminate;
else
  goto addSpouse;
end-if;
```

The **terminate with error** statement is only available in a service script.

NOTE: For issuing an error from a BPA script refer to [Useful Tips and Tricks](#).

Syntax	Attributes	Comments
terminate with error (x, y %n= element=)	'x' represents the message category	Required.
	'y' represents the message number	Required.
	%n="Element XPath" or %n='literal'	Specify the substitution parameters supported by the message using either literal values or XPath references. When the value to substitute is an element within a list, use the XPath of the element within the list qualified by the list occurrence.
	element='Element XPath' or element=\$variable	Optionally specify an element name within a UI map to highlight as part of the error. When the element in error is within a list, use the XPath of the element within the list qualified by the list occurrence.

Example of a simple field:

```
if ( "string(customer/lastName) = $BLANK" )
  terminate with error (8000, 1001 %1="customer/
lastName" %2='Last name required' element='customer/lastName');
end-if;
```

Example of terminate where the element to mark is in a list:

```
for ($list in "parm/hard/newBusinessObject/listName")
  if /** check some condition for elementName
  terminate with error (11000, 11000 %1="$list/elementName" element='$list/elementName');
  end-if;
end-for;
```

FASTPATH: For more information on presenting errors in a UI map, please refer to [Display Errors](#).

Invoking Groovy Code

If you have a plug-in script or a service script that mixes XPath scripting and Groovy scripting, the edit data step supports the ability to invoke Groovy code using the syntax **invokeGroovy 'method'**; where 'method' is the name of a method defined in a **Groovy Members** step within the script. Only methods that do not receive arguments and return void can be invoked in this way. However, the method invoked from the edit data step can be supported by additional Groovy code in other **Groovy Members** step types.

Example Edit Data step:

```
invokeGroovy 'invoke';
```

Example Groovy Members step:

```
void invoke() {
    initParms()
    readBO()
    initConfig()
    retrieve()
    updateBO()
}
```

NOTE: As mentioned in [Using Groovy Within Scripts](#), if this is a plug-in script and the code is only Groovy, you should use the **Groovy** script engine version rather than the above technique. This is considered more efficient as it avoids the conversion of the data to and from the XML interface.

Debugging a BPA Script

If a BPA script has height greater than zero, then selected nodes of the script's data area can be displayed at runtime. The XML data is displayed during script execution within the BPA script's display area. Specify the XPath of an XML node from any of the BPA script's data areas, between the paired characters: '%+' and '+%'.

For example, the entire contents of the schema group node named 'input', and the specific contents of the schema element named 'output/status' will be displayed in the BPA script's display area. The debug text must be entered into the BPA script's text area and not within the script's edit data field. Debug text can be declared for any explicit step of the script.

```
display input: %+input+% , and output status: %+output/status+%
```

Useful Tips and Tricks

This section provides some suggestions about how to implement some common logic.

Finding the Logged In User in a BPA

For server based scripts, the **\$USER** variable is populated with the current logged in user. This variable is not available for BPA scripts. The BPA can call the service script **F1-GetUser** if this information is needed.

Issuing an Error from a BPA script

For server based scripts, you use the **terminate with error** statement to return an error message to display to the user. The BPA can display that error by transferring control to **F1-HandleErr** as described in the [Declare and Invoke Schema Based Objects](#). This is not supported in a BPA script. A technique that is available to a BPA for issuing an error is to call the business service **F1-RethrowError** passing the error details. This business service populates the appropriate system error fields needed to issue the error. Then transfer control to **F1-HandleErr**.

```
if ("string($assignedToUser) != string(F1-GetUser/user)")
    declareBS 'F1-RethrowError' as 'errorMsg';
    move '11010' to "errorMsg/messageCategory";
    move '11511' to "errorMsg/messageNumber";
    move "$toDoEntryId" to "errorMsg/messageParameters/+parameters/parameterValue";
    invokeBS 'F1-RethrowError' using "errorMsg";
    transferControl 'F1-HandleErr';
end-if;
```

Go To Steps

Go to steps allow you to jump to a step other than the next step. Additional fields required for **Go To** steps:

Next Step defines the step to which the script should jump.

Height Steps

NOTE: BPA scripts only. This step type is only applicable to BPA scripts.

Height steps are used to change the height of the script area to be larger or smaller than the standard size.

The following additional fields are required for **Height** steps:

Script Window Height defines the number of **Pixels** or the **Percentage** (according to the **Height Unit**) that the script window height should be adjusted. The percentage indicates the percentage of the visible screen area that the script area uses. For example, a percentage value of **100** means that the script area will use the entire area.

NOTE: Standard Number of Pixels. The default number of pixels used by the script area is **75**.

NOTE: Adjust script height in the first step. If you want to adjust the height of the script area, it is recommendation to define the **height** step type as your first step. Otherwise, the script area will open using the standard height and then readjust, causing the screen to redisplay.

NOTE: Hide script area. You could use this type of step to set the height to **0** to hide the script area altogether. This is useful if the script does not require any prompting to the user. For example, perhaps you define a script to take a user to a page and with certain data pre-populated and that is all.

NOTE: Automatically close script area. If you want the script area to close when a script is completed, you could define the final step type with a height of 0.

Input Data Steps

NOTE: BPA scripts only. This step type is only applicable to BPA scripts.

Input data steps cause the user to be prompted to populate an input field in the script area. The input value can be saved in a field on a page or in temporary storage. A **Continue** button always appears adjacent to the input field. You may configure steps of this type to display one or more buttons in addition to the **Continue** button. For example, you may want to provide the ability for the user to return to a previous step to fix incorrect information. The user may click on any of these buttons when ready for the script to continue.

The following additional fields are required for **Input Data** steps:

Destination Field Type and **Destination Field Name** define where the input field will be saved. The **Field Type** defines where the field is located. The **Field Name** defines the name of the field. The following points describe each field type:

- **Page Data Model.** Use this field type to put the input field into a field that resides on any of the tab pages in the [object display area](#) (i.e., the field populated doesn't have to reside on the currently displayed tab page, it just has to be part of the object that's currently displayed). Refer to [How To Find The Name Of Page Data Model Fields](#) for instructions on how to find the appropriate **Field Name**.
- **Temporary Storage.** Use this field type to put the input field into temporary storage. Use **Field Name** to name the field in temporary storage. Refer to [How To Name Temporary Storage Fields](#) for more information.
- **User Interface Field.** Use this field type to put the input field into a field that resides on the currently displayed tab page. Note, if you want to execute underlying default logic, you must populate a **User Interface Field**. Refer to [How To Find The Name Of User Interface Fields](#) for instructions on how to find the appropriate **Field Name**.

The **Prompt Values** grid may be used to define additional buttons. A separate button is displayed in the script area for each entry in this grid.

- **Prompt Text** is the verbiage to appear on the button. Refer to [How To Substitute Variables In Text](#) for a description of how you can substitute field values into the prompts.
- **Sequence** controls the order of the buttons.
- **Next Script Step** defines the step to execute if the user clicks the button.

Invoke Business Object Steps

Invoke business object steps allow you to interact with a [business object](#) in order to obtain or maintain its information.

The following additional fields are required for **Invoke business object** steps:

Use **Warning Level** to indicate whether warnings should be suppressed and if not, how they should be presented to the user. By default, warnings are suppressed. If **Warn As Popup** is used, the warning is displayed using the standard popup dialog. If **Warn As Error** is used processing is directed to the **If Error, Go To** step. This field is only applicable to BPA scripts. Refer to [BO warnings](#) for more information about handling warnings when invoking a BO.

Group Name references the [data area](#) to be passed to and from the server when communicating with the **Business Object**. Indicate the **Action** to be performed on the object when invoked. Valid values are **Add, Delete, Fast Add (No Read), Fast Update (No Read), Read, Replace, Update**.

FASTPATH: Refer to [BO Actions](#) for more information about the various actions.

The business object call will either be successful or return an error. The next two fields only appear when the call is issued from a BPA script, to determine the step to which control is passed given the outcome of the call.

If Success, Go To defines the step that is executed if the call is successful. This field is only applicable to BPA scripts.

If Error, Go To defines the step that is executed if the call returns on error. Please note that the error information is held in [global variables](#). This field is only applicable to BPA scripts.

NOTE: Error technique. Let's assume a scenario where a business object is invoked from a BPA script and the call returned an error. If the BPA script is configured to communicate with the user using a UI map, you may find it useful to invoke the map again to present the error to the user. Alternatively, you may invoke a step that transfers control to a script that displays the error message information and stops.

Invoke Business Service Steps

Invoke business service steps allow you to interact with a [business service](#).

The following additional fields are required for **Invoke business service** steps:

Use **Warning Level** to indicate whether warnings should be suppressed and if not, how they should be presented to the user. By default, warnings are suppressed. If **Warn As Popup** is used, the warning is displayed using the standard popup dialog. If **Warn As Error** is used processing is directed to the **If Error, Go To** step. This field is only applicable to BPA scripts.

Group Name references the [data area](#) to be passed to and from the server when the **Business Service** is invoked.

The business service call will either be successful or return an error. The next two fields only appear when the call is issued from a BPA script, to determine the step to which control is passed given the outcome of the call.

If Success, Go To defines the step that is executed if the call is successful. This field is only applicable to BPA scripts.

If Error, Go To defines the step that is executed if the call returns on error. Please note that the error information is held in [global variables](#). This field is only applicable to BPA scripts.

NOTE: Error technique. Let's assume a scenario where a business service is invoked from a BPA script and the call returned an error. If the BPA script is configured to communicate with the user using a UI map, you may find it useful

to invoke the map again to present the error to the user. Alternatively, you may invoke a step that transfers control to a script that displays the error message information and stops.

Invoke Function Steps

NOTE: Functions were implemented prior to the introduction of business services (BS), service scripts (SS) and business objects (BO). The functionality is still supported, but the recommendation for implementations going forward is to use a step that invokes one of the above configuration tool objects in a script rather than defining a function.

NOTE: BPA scripts only. This step type is only applicable to BPA scripts.

Invoke function steps may be used to retrieve or update data independent of the page currently being displayed. For example, if you design a script that takes different paths based on the customer's customer class, you could invoke a function to retrieve the customer's customer class.

FASTPATH: You must set up a function before it can be referenced in a script. Refer to [Maintaining Functions](#) for the details.

The following additional fields are required for **Invoke Function** steps:

Function defines the name of the function. The function's **Long Description** is displayed below.

When a function is invoked, it will either be successful or return an error. The next two fields control the step to which control is passed given the outcome of the function call:

- **If Success, Go to** defines the step that is executed if the function is successful.
 - **If Error, Go to** defines the step that is executed if the function returns on error. Refer to [How To Use Constants In Scripts](#) for a list of the global variables that are populated when a function returns an error.
-

NOTE: Error technique. If a function returns an error, we recommend that you invoke a step that transfers control to a script that displays the error message information and stops (note, the error information is held in [global variables](#)). You would invoke this script via a **Transfer Control**.

The **Send Fields** grid defines the fields whose values are sent to the function and whose field value source is not **Defined On The Function**. For example, if the function receives an account ID, you must define the name of the field in the script that holds the account ID.

- **Field** contains a brief description of the field sent to the function.
- **Source Field Type** and **Mapped Field / Value** define the field sent to the function. Refer to the description of Source Field under [How To Set Up Move Data Steps](#) for a description of each field type.
- **Comments** contain information about the field (this is defined on the function).

The **Receive Fields** grid defines the fields that hold the values returned from the function. For example, if the function returns an account's customer class and credit rating, you must set up two fields in this grid.

- **Field** contains a brief description of the field returned from the function.
- **Destination Field Type** and **Mapped Field** define the field returned from the function. Refer to the description of Destination Field under [How To Set Up Move Data Steps](#) for a description of each field type.
- **Comments** contain information about how the field (this is defined on the function).

Invoke Map Steps

NOTE: BPA scripts only. This step type is only applicable to BPA scripts.

Invoke map steps are used to invoke a **UI Map** to display, capture and update data using an HTML form. You may configure steps of this type to display one or more buttons in addition to the **Continue** button. For example, you may want to provide the ability for the user to return to a previous step to fix incorrect information. The user may click on any of these buttons when ready for the script to continue.

The following additional fields are required for **Invoke map** steps:

Group Name references the **data area** to be passed to and from the server when rendering the HTML form associated with the **Map**.

Use **Target Area** to designate where the map will be presented.

- Select **BPA Zone** if the map should be presented within the **script area**.
- Select **Page Area** if the map should be presented in the **object display area**, i.e. the frame typically used to house a maintenance page.
- Select **Pop-up Window** if the map should be launched in a separate window.

The **Returned Values** grid contains a row for every button defined on the map.

- **Returned Value** is the value returned when the user clicks the button.
- **Use as Default** can only be turned on for one entry in the grid. If this is turned on, this value's Next Script Step will be executed if the returned value does not match any other entry in the grid. For example, if the user closes a pop-up (rather than clicking a button), the default value will be used.
- **Next Script Step** defines the step to execute if the user clicks the button.

Invoke Service Script Steps

Invoke service script steps allow you to execute a **service script**.

The following additional fields are required for **Invoke service script** steps:

Use **Warning Level** to indicate whether warnings should be suppressed and if not, how they should be presented to the user. By default, warnings are suppressed. If **Warn As Popup** is used, the warning is displayed using the standard popup dialog. If **Warn As Error** is used processing is directed to the **If Error, Go To** step. This field is only applicable to BPA scripts.

Group Name references the **data area** to be passed to and from the server when the **Service Script** is invoked.

The service script call will either be successful or return an error. The next two fields only appear when the call is issued from a BPA script to determine the step to which control is passed given the outcome of the call.

If Success, Go To defines the step that is executed if the call is successful. This field is only applicable to BPA scripts.

If Error, Go To defines the step that is executed if the call returns on error. Please note that the error information is held in **global variables**. This field is only applicable to BPA scripts.

NOTE: Error technique. Let's assume a scenario where a service script is invoked from a BPA script and the call returned an error. If the BPA script is configured to communicate with the user using a UI map, you may find it useful to invoke the map again to present the error to the user. Alternatively, you may invoke a step that transfers control to a script that displays the error message information and stops.

Groovy Imports Steps

NOTE: Server based scripts only. This step type is not applicable to BPA scripts.

Groovy Imports step types provide a free format text area where you list the Groovy classes to be imported for use by the code in **Groovy Member** steps within the script.

Enter a description of the imports step in the **Text** field. Click the adjacent icon to open a window providing more space for entering text.

Enter the list of classes to import in the **Edit Data Text** field using the syntax **import 'class'**; where 'class' is the fully qualified package name of the Groovy class. Click the adjacent icon to open a window providing more space for editing the text.

When saving a script, if the system has been configured accordingly, when the system detects references to a Groovy class that is not explicitly listed in this step, the system warns the user and adds an explicit import for that class. (If no Groovy Import step type exists for the script, one will be added.) Users should review the imported class to ensure it is the expected class, in the case of multiple classes with a similar name.

NOTE: For security, the classes that may be imported are restricted to those allowed by the Framework. The warning and automatic update to the script is controlled by a property setting. Refer to the topic [Using Groovy Within Scripts](#) for more information.

Groovy Library Interface Steps

NOTE: Server based scripts only. This step type is not applicable to BPA scripts.

Groovy Library Interface steps are only applicable to **Groovy Library Scripts**. They provide a free format text area where you can list the Groovy methods defined within the script that are available for use by other scripts.

Enter a description of the interface step in the **Text** field. Click the adjacent icon to open a window providing more space for entering text.

Enter the list of interface methods in the **Edit Data Text** field. Click the adjacent icon to open a window providing more space for editing the list.

NOTE: Every **Groovy Library Script** must have one and only one step of type **Groovy Library Interface**. The supporting code for the available methods is defined using one or more **Groovy Member** steps in the same script. Refer to the topic [Using Groovy Within Scripts](#) for more information.

Groovy Member Steps

NOTE: Server based scripts only. This step type is not applicable to BPA scripts.

Groovy Member steps provide a free format text area where you can enter Groovy code.

Enter a description of the code block in the **Text** field. Click the adjacent icon to open a window providing more space for entering text.

Enter your code in the **Edit Data Text** field. Click the adjacent icon to open a window providing more space for editing the code.

NOTE: While it is possible to set up multiple steps of type **Groovy Member** the system treats these steps as a single class for compilation and execution purposes. Refer to the topic [Using Groovy Within Scripts](#) for more information.

Label Steps

Label steps allow you to describe what the next step(s) are doing. Steps of this type are helpful to the script administrators when reviewing or modifying the steps in a script, especially when a script has many steps. When designing a script, the label steps enable you to provide a heading for common steps that belong together. The script tree displays steps of this type in a different color (green) so that they stand out from other steps.

There are no additional fields for **Label** steps.

Mathematical Operation Steps

NOTE: BPA scripts only. This step type is only applicable to BPA scripts.

Mathematical operation steps allow you to perform arithmetic on fields. You can also use this type of step to add and subtract days from dates. For example, you could calculate a date 7 days in the future and then use this value as the customer's next credit review date. The following additional fields are required for **Mathematical Operation** steps:

Base Field Type and **Base Field Name** define the field on which the mathematical operation will be performed. The **Field Type** defines where the field is located. The **Field Name** defines the name of the field. The following points describe each field type:

- **Page Data Model.** Use this field type when the field resides on any of the tab pages in the [object display area](#). Refer to [How To Find The Name Of Page Data Model Fields](#) for instructions on how to find the appropriate **Field Name**.
- **Temporary Storage.** Use this field type when the field resides in temporary storage. You must initialize the temporary storage field with a Move Data step before performing mathematical operations on the field. Refer to [How To Set Up Move Data Steps](#) for more information.
- **User Interface Field.** Use this field type when the field resides on the currently displayed tab page. Refer to [How To Find The Name Of User Interface Fields](#) for instructions on how to find the appropriate **Field Name**.

Math Operation controls the math function to be applied to the **Base Field**. You can specify +, -, /, and *. Note, if the base field is a date, you can only use + or -.

Math Field Type, **Math Field Name** and **Math Field Value** define the field that contains the value to be added, subtracted, divided, or multiplied. The following points describe each field type:

- **Current To Do Information.** Use this field type when the value resides on the current To Do entry. Refer to [How To Use To Do Fields](#) for instructions on how to define the appropriate **Field Name**.
- **Page Data Model.** Use this field type when the value resides on any of the tab pages in the [object display area](#). Refer to [How To Find The Name Of Page Data Model Fields](#) for instructions on how to find the appropriate **Field Name**.
- **Predefined Value.** Use this field type when the value is a constant. When this field type is used, use **Source Field Value** to define the constant value. Refer to [How To Use Constants In Scripts](#) for more information. Note, if you are performing arithmetic on a date, the field value must contain the number and type of **days/ months/ years**. For example, if you want to add 2 years to a date, the source field value would be **2 years**.
- **Temporary Storage.** Use this field type when the value is a field that you put into temporary storage in an earlier step. The **Field Name** must be the same as defined in an earlier step.
- **User Interface Field.** Use this field type when the value resides in a field on the current tab page. Refer to [How To Find The Name Of User Interface Fields](#) for instructions on how to find the appropriate **Field Name**.

Move Data Steps

Move data steps allow you to move data (from a source to a destination). The following additional fields are required for **Move data** steps:

Source Field Type, **Source Field Name** and **Source Field Value** define what you're moving. The following points describe each field type:

- **Context Variable.** Use this field type in a plug-in or service script if the source value is a variable initiated in a higher level script. This is only applicable to Service Scripts and Plug-in Scripts.
- **Current To Do Information.** Use this field type when the source value resides on the current To Do entry. Refer to [How To Use To Do Fields](#) for instructions on how to define the appropriate **Field Name**. This is only applicable to BPA Scripts.
- **Data Area.** Use this field type when the field being compared is one that you put into one of the script's data areas in an earlier step. **Field Name** must reference both a data area structure name as well as the field, for example "parm/charType". Refer to [How To Reference Fields In Data Areas](#) for instructions on how to construct the appropriate **Field Name**.
- **Global Context.** Use this field type when the source value is a [global context variable](#). This is only applicable to BPA Scripts.
- **Page Data Model.** Use this field type when the source value resides on any of the tab pages in the [object display area](#) (i.e., the source field doesn't have to reside on the currently displayed tab page, it just has to be part of the object that's currently displayed). Refer to [How To Find The Name Of Page Data Model Fields](#) for instructions on how to find the appropriate **Field Name**. This is only applicable to BPA Scripts.
- **Portal Context.** Use this field type when the source value is a variable in the portal context. This is only applicable to BPA Scripts.
- **Predefined Value.** Use this field type when the source value is a constant value defined in the script. When this field type is used, use **Source Field Value** to define the constant value. Refer to [How To Use Constants In Scripts](#) for instructions on how to use constants.

NOTE: Concatenating fields together. You can also use **Predefined Value** if you want to concatenate two fields together. For example, let's say you have a script that merges two persons into a single person. You might want this script to change the name of the person being merged out of existence to include the ID of the person remaining. In this example, you could enter a **Source Field Value** of **%ONAMEmerged into person %PERID** (where **ONAME** is a field in temporary storage that contains the name of the person being merged out of existence and **PERID** contains the ID of the person being kept). Refer to [How To Substitute Variables In Text](#) for a description of how you can substitute field values to compose the field value.

- **Temporary Storage.** Use this field type when the source value is a field that you put into temporary storage in an earlier step. The **Field Name** must be the same as defined in an earlier step.
- **User Interface Field.** Use this field type when the source value resides on the currently displayed tab page. Refer to [How To Find The Name Of User Interface Fields](#) for instructions on how to find the appropriate **Field Name**. This is only applicable to BPA Scripts.

Destination Field Type and **Destination Field Name** define where the source field will be moved. The **Field Type** defines where the field is located. The **Field Name** defines the name of the field. The following points describe each field type:

- **Context Variable.** Use this field type in your plug-in or service script if you use a variable to communicate information to a lower level service script or schema. This is not applicable to BPA Scripts.
- **Data Area.** Use this field type when the destination field resides on one of the scripts data areas. **Field Name** must reference both a data area structure name as well as the field, for example "parm/charType". Refer to [How To Reference Fields In Data Areas](#) for instructions on how to construct the appropriate **Field Name**.

- **Page Data Model.** Use this field type when the destination field resides on any of the tab pages in the [object display area](#) (i.e., the field populated doesn't have to reside on the currently displayed tab page, it just has to be part of the object that's currently displayed). Refer to [How To Find The Name Of Page Data Model Fields](#) for instructions on how to find the appropriate **Field Name**. This is only applicable to BPA Scripts.
- **Portal Context.** Use this field type when the destination to be updated is in the current portal context. This is only applicable to BPA Scripts.
- **Temporary Storage.** Use this field type when the destination field resides in temporary storage. Use **Field Name** to name the field in temporary storage. Use **Field Name** to name the field in temporary storage. Refer to [How To Name Temporary Storage Fields](#) for more information.
- **User Interface Field.** Use this field type when the destination field resides on the currently displayed tab page. Refer to [How To Find The Name Of User Interface Fields](#) for instructions on how to find the appropriate **Field Name**. This is only applicable to BPA Scripts.

NOTE: Conditional field types. The field types **Current To Do Information**, **Page Data Model** and **User Interface Field** are only applicable to BPA scripts.

Navigate To A Page Steps

NOTE: BPA scripts only. This step type is only applicable to BPA scripts.

Navigate to a page steps cause a new page (or tab within the existing page) to be displayed in the object display area. Steps of this type are a precursor to doing anything on the page. The following additional field is required for **Navigate to a page** steps:

Navigation Option defines the transaction, tab, access mode (add or change) and any context fields that are passed to the transaction in change mode. For example, if you want a script to navigate to Person - Characteristics for the current person being displayed in the dashboard, you must set up an appropriate navigation option. Refer to [Defining Navigation Options](#) for more information.

NOTE: Navigating to a page in update mode. Before you can navigate to a page in change mode, the page data model must contain the values to use for the navigation option's context fields. If necessary, you can move values into the page data model using a [Move Data step](#) first. For example, before you can navigate to a page in change mode with an account ID in context, you may need to move the desired account ID into the ACCT_ID field in the page data model. The actual field name(s) to use are listed as context fields on the [navigation option](#).

Perform Script Steps

NOTE: BPA scripts only. This step type is only applicable to BPA scripts.

Perform script steps cause another BPA script to be performed. After the performed script completes, control is returned to the next step in the original script. You might want to think of the scripts referred to on steps of this type as "subroutines". This functionality allows you to encapsulate common logic in reusable BPA scripts that can be called from other BPA scripts. This simplifies maintenance over the long term.

The following additional field is required for **Perform script** steps:

Script is the name of the script that is performed.

Press A Button Steps

NOTE: BPA scripts only. This step type is only applicable to BPA scripts.

Press a button steps cause a button or link text to be ‘pressed’ in the [object display area](#), the [application toolbar](#) or the [page title area](#). For example, you could use this type of step to add a new row to a person's characteristic (and then you could use a **Move Data** step to populate the newly added row with a given char type and value). The following additional fields are required for **Press a button** steps:

Button Name is the name of the button to be pressed. This button must reside on the currently displayed tab page (or in the application toolbar or page actions toolbar). Refer to [How To Find The Name Of A Button](#) for more information.

Prompt User Steps

NOTE: BPA scripts only. This step type is only applicable to BPA scripts.

Prompt user steps cause the user to be presented with a menu of options. The options can be presented using either buttons or in the contents of a drop down. You can also use steps of this type to pause a script while the user checks something out (and when the user is ready to continue with the script, they are instructed to click a prompt button). The following additional fields are required for **Prompt User** steps:

Prompt Type controls if the prompt shown in the script area is in the form of **Button(s)** or a **Dropdown**. Note, if you use a **Dropdown**, a Continue button appears adjacent to the dropdown in the script area when the step executes. The user clicks the Continue button when they are ready for the script to continue.

The **Prompt Values** grid contains a row for every value that can be selected by a user. Note, if you use a **Prompt Type of Button(s)**, a separate button is displayed in the script area for each entry in this grid.

- **Prompt Text** is the verbiage to appear on the button or in the dropdown entry. Refer to [How To Substitute Variables In Text](#) for a description of how you can substitute field values into the prompts.
- **Sequence** controls the order of the buttons or dropdown entries.
- **Use As Default** can only be turned on for one entry in the grid. If this is turned on for a dropdown entry, this value is defaulted in the grid. If this is turned on for a button, this button becomes the default (and the user should just have to press `Enter` (or `space`) rather than click on it).
- **Next Script Step** defines the step to execute if the user clicks the button or selects the dropdown value.

Set Focus To A Field Steps

NOTE: BPA scripts only. This step type is only applicable to BPA scripts.

Set focus to a field steps cause the cursor to be placed in a specific field on a page. A **Continue** button always appears in the script area when this type of step executes. The user may click the **Continue** button when they are ready for the script to continue. You may configure steps of this type to display one or more buttons in addition to the **Continue** button. For example, you may want to provide the ability for the user to return to a previous step to fix incorrect information. The user may click on any of these buttons when ready for the script to continue.

The following additional fields are required for **Set focus to a field** steps:

Destination Field Name defines the field on which focus should be placed. This field must reside on the currently displayed tab page. Refer to [How To Find The Name Of User Interface Fields](#) for instructions on how to find the appropriate **Field Name**.

The **Prompt Values** grid may be used to define additional buttons. A separate button is displayed in the script area for each entry in this grid.

- **Prompt Text** is the verbiage to appear on the button. Refer to [How To Substitute Variables In Text](#) for a description of how you can substitute field values into the prompts.
- **Sequence** controls the order of the buttons.
- **Next Script Step** defines the step to execute if the user clicks the button.

Terminate Steps

Terminate steps cause a server-based script to end processing successfully or issue an error.

The following additional fields are required for **Terminate** steps:

Error indicates whether an error should be thrown or not. If error, **Error Data Text** must be specified, indicating the error message and any message substitution parameters. Refer to [Edit Data Syntax](#) the actual syntax of initiating an error message.

NOTE: The ability to terminate a step in error is only supported for server-based scripts.

Transfer Control Steps

NOTE: BPA scripts only. This step type is only applicable to BPA scripts.

Transfer control steps cause the current BPA script to terminate and the control to pass to another BPA script. You might want to construct a BPA script with steps of this type when the script has several potential logic paths and you want to segregate each logic path into a separate BPA script (for ease of maintenance).

The following additional fields are required for **Transfer control** steps:

Subscript is the name of the script to which control is transferred.

Additional Topics

The contents of this section provide additional information about steps.

How To Find The Name Of User Interface Fields

This section is only relevant if you are using the legacy capability of BPA scripts to bring a user to a base fixed page and populate information into fields on that page. Follow these steps to find the name of a field that resides on a fixed page:

- Navigate to the page in question.
- Right click in the body of the page.
- Select **Inspect** from the pop-up menu to display the HTML.
- In the search look for the text "Widget Info". Note that if there are multiple sections on the page, you will find multiple "Widget Info" results. Based on the details shown, you are able to confirm which section you are looking for. For example, the following is an example from the Algorithm - Main page:

```

* Widget Info:
*   Widget_ID , Element Type - label info - label
*   ALG_CD, IT - CI_ALG$ALG_CD - Algorithm Code
*   IM_ALG_CD, IM - $SEARCH_FOR_ALG_LBL - Search for Algorithm
*   OWNER_FLG, IS - $OWNER_FLG - Owner
*   DESCR50, IT - $DESCR50 - Description
*   IM_Main_algtypCont, IM - $F1_SHOW_ALG_CTX - Show Algorithm Context Menu
*   ALG_TYPE_CD, IT - $ALG_TYPE_CD - Algorithm Type
*   IM_ALG_TYPE_CD, IM - $SEARCH_ALGTYPE_LBL - Search for Algorithm Type
*   ALG_TYPE_DESCR50, PL - $DESCR50 - Description
*   ALG_TYPE_LONG_DESC, IA - $DESCRLONG - Detailed Description
*   IM_VerScroll_lftArrow, IM - $PREVIOUS_ALG_LBL - Previous Version
*   ALG_VER$recordCount, SN - $OF_LBL - Of
*   IM_VerScroll_rtArrow, IM - $NEXT_ALG_LBL - Next Version
*   IM_ADD, IM - $ADD_ALG_LBL - Add Version
*   IM_DEL, IM - $DELETE_ALG_LBL - Delete Version
*   ALG_VER$EFFDT, IT - $EFFDT - Effective Date
*   L_OWNER_LBL, LP - $OWNER_FLG - Owner
*   ALG_VER$OWNER_FLG, IS - $OWNER_FLG - Owner
*   resultGrid, GD

```

The field names that you'll reference in your scripts are defined on the left side of the HTML (e.g., ALG_CD, DESCR50, ALG_TYPE_CD, etc.).

The names of fields that reside in scrolls are in a slightly different format. The following is an example of the HTML for the version scroll that appears on Algorithm - Main. Notice that the fields in the scroll are prefixed with the name of the scroll plus a \$ sign. For example, the effective date is called **ALG_VER\$EFFDT**.

```

*   IM_VerScroll_lftArrow, IM - $PREVIOUS_ALG_LBL - Previous Version
*   ALG_VER$recordCount, SN - $OF_LBL - Of
*   IM_VerScroll_rtArrow, IM - $NEXT_ALG_LBL - Next Version
*   IM_ADD, IM - $ADD_ALG_LBL - Add Version
*   IM_DEL, IM - $DELETE_ALG_LBL - Delete Version
*   ALG_VER$EFFDT, IT - $EFFDT - Effective Date
*   L_OWNER_LBL, LP - $OWNER_FLG - Owner
*   ALG_VER$OWNER_FLG, IS - $OWNER_FLG - Owner

```

The names of fields that reside in grids are in a slightly different format. The following is an example of the HTML for the algorithm parameters grid that appears on Algorithm - Main. Notice that the fields in the grid are prefixed with the name of the grid plus a :x\$. For example, the algorithm parameter label is called **ALG_PARM:x\$ALG_PARM_LBL**. When you reference such a field in your script, you have the following choices:

- Substitute **x** with the row in the grid (and keep in mind, the first row in a grid is row **0** (zero); this means the second row is row **1**).
- If you want to reference the "current row" (e.g., the row in which the cursor will be placed), you can keep the **x** notation (**x** means the "current row").

```

* Widget Info:
*   Widget_ID , Element Type - label info - label
*   ALG_PARM:x$ALG_PARM_LBL, IL - CI_ALG_TYPE_PRM_L$ALG_PARM_LBL - Parameter
*   ALG_PARM:x$SEQNO, IL - $SEQNO - Sequence
*   ALG_PARM:x$ALG_PARM_VAL, IA - $ALG_PARM_VAL - Value
*

```

How To Find The Name Of Page Data Model Fields

You find the name of a **Page Data Model** field in the same way described under [How To Find The Name Of User Interface Fields](#). The only restriction is that you cannot refer to hidden / derived fields. However, you can refer to any of the object's fields regardless of the tab page on which they appear. For example, if you position the object display area to the Main tab of the Account transaction, you can reference fields that reside on all of the tab pages.

CAUTION: If you populate a **Page Data Model** field, none of the underlying default logic takes place. For example, if you populate a customer contact's contact type, none of the characteristics associated with the customer contact type are defaulted onto the customer contact. If you want the underlying defaulting to take place, you must populate a **User Interface Field**.

How To Find The Name Of A Button

This section is only relevant if you are using the legacy capability of BPA scripts to bring a user to a base fixed page and perform functionality by executing existing buttons on that page.

If you want a **Press a button** step to press a button or click a link in the application toolbar, use one of the following names:

Button Name

IM_GOBACK

IM_HISTORY

IM_GOFORWARD

IM_menuButton

IM_USER_HOME

IM_MY_PREF

IM_helpButton

If you want a **Press a button** step to press a button in the page actions toolbar, use one of the following names:

Button Name

IM_SAVE

IM_REFRESH

IM_CLEAR

IM_COPY

IM_DELETE

IM_ScrollBack

IM_ScrollForward

The following buttons are also supported:

Button Name

IM_TO_DO

IM_CurrentTo Do

Comments

This navigates to the [To Do Entry](#) page for the user's current To Do. Refer to [A User's Current To Do](#) for more information.

Button Name	Comments
IM_MINIMIZE_DASHBOARD	Pressing this will collapse the dashboard. Note that when a script is finished, it will return the dashboard to the state it was when the script was launched.
IM_MAXIMIZE_DASHBOARD	Pressing this will expand the dashboard. Note that when a script is finished, it will return the dashboard to the state it was when the script was launched.

Follow these steps to find the name of other buttons that reside in the object display area of a fixed page:

- Navigate to the page in question.
- Right click in the body of the page
- Select **Inspect** from the pop-up menu.
- In the search look for the text "Widget Info". Note that if there are multiple sections on the page, you will find multiple "Widget Info" results. Based on the details shown, you are able to confirm which section you are looking for.
- Iconized buttons (e.g., search buttons) are represented as HTML images and their field names are prefixed with **IM**. The following is an example of the HTML on the Algorithm - Main page (notice the **IM** fields for the iconized buttons).

```
* Widget Info:
*   Widget_ID , Element Type - label info - label
*   ALG_CD, IT - CI_ALG$ALG_CD - Algorithm Code
*   IM_ALG_CD, IM - $SEARCH_FOR_ALG_LBL - Search for Algorithm
*   OWNER_FLG, IS - $OWNER_FLG - Owner
*   DESCR50, IT - $DESCR50 - Description
*   IM_Main_algtypCont, IM - $F1_SHOW_ALG_CTX - Show Algorithm Context Menu
*   ALG_TYPE_CD, IT - $ALG_TYPE_CD - Algorithm Type
*   IM_ALG_TYPE_CD, IM - $SEARCH_ALGTYPE_LBL - Search for Algorithm Type
```

- Transaction-specific actions buttons are represented as switches. The following is an example of the HTML on the Batch Job Submission - Main page (notice the **SW** fields for the buttons). Note, if you want to **Set focus** to such a field, you would move a **Predefined Value** of **TRUE** to the switch.

```
*   ACTION_Q_SW, BU - $ACTION_Q_SW - Duplicate & Queue
*   ACTION_CANCEL_SW, BU - $CANCEL_SW - Cancel
```

How To Substitute Variables In Text

You can substitute field values into a step's text string. You do this by prefixing the field name whose value should be substituted in the string with a **%**. For example, the message, "On **%COMPLETION_DTTM** this bill was completed, it's ending balance was **%ENDING_BALANCE**" contains two substitution variables (the bill's completion date / time and the bill's ending balance).

To substitute the value of an element from a data area you need to reference its XPath location as follows: **%=XPath=**%. If you want to substitute the whole XML node, not just the value, you need to reference it as follows **%+XPath+%**.

Only fields linked to the [current To Do](#) and fields that reside in [temporary storage](#) and [global variables](#) can be substituted into a text string.

NOTE: You can substitute fields that reside in the User Interface or Page Data Model by first moving them into temporary storage (using a **Move data** step).

You can also substitute field values into the verbiage displayed in [prompts](#) using the same technique.

How To Use HTML Tags And Spans In Text Strings and Prompts

You can use HTML tags in a step's text string. For example, the word "Continue" will be italicized in the following text string "Press<i>Continue</i> after you've selected the customer" (the **<i>** and **</i>** are the HTML tags used to indicate that the surrounded text should be italicized).

The following are other useful HTML tags:

- `
` causes a line break in a text string. If you use `

` a blank line will appear.
- ` text ` causes the surrounded text to be colored as specified (in this case, red). You can also use hex codes rather than the color name.

Please refer to an HTML reference manual or website for more examples.

NOTE: Refer to [Color Contrast](#) for information about the use of the HTML color 'red' and its impact on accessibility.

How To Use Constants In Scripts

Some steps can reference fields called **Predefined Values**. For example, if you want to compare an input value to the letter "Y", the letter **Y** would be defined as a Predefined Value's field value.

Special constants are used for fields defined as switches. When you move **TRUE** to a switch, it turns it on. When you move **FALSE** to a switch, it turns it off.

You can use a [global variable](#) as a Predefined Value. For example, if you wanted to move the current date to a field, you'd indicate you wanted to move a Predefined Value named **%CURRENT_DATE**.

How To Use Global Variables

Some explicit steps can reference fields called **Predefined Values**. In addition to referencing an ad hoc constant value (e.g., the letter **Y**), you can also reference a global variable in such a field value. A global variable is used when you want to reference system data.

Note that when using the Edit Data step type, the variable available are slightly different. Refer to [Edit Data Syntax](#) for details.

The following global variables exist for BPA scripts:

Variable Name	Comments
%PARM-<name>	This is the value of a parameter of that name passed in to the application when launched via the standard system URL. Refer to Launching A Script When Starting the System for more information on these parameters.
%PARM-NOT-SET	This is to be used to compare against %PARM-< > parameters to check if the parameter has been set or not when the application was launched. A parameter that has not been set would be considered equal to this global variable. It is recommended to compare parameters against this global variable before using them for the first time.
%BLANK	A constant that contains a blank value (no value).
%SPACE	A constant that contains a single space value.
%CURRENT-DATE	The current date as known by the browser, not the server.
%SYSTEM-DATE	The server date. Note that this date is affected by the system date override logic)
%SAVE-REQUIRED	A flag that contains an indication of whether the data on a page has been changed (and thus requires saving). You may want to interrogate this flag to force a user to save their work before executing subsequent steps. This flag will have a value of TRUE or FALSE .
%NEWLINE	A constant that contains a new line character (carriage return). Upon substitution, a line break is inserted in the resultant text. NOTE: This constant does not have the desired effect when the resultant text is HTML. For example, a step's text and prompt strings. This is because HTML ignores special characters such as new lines. Refer to How To Use HTML Tags And Spans In Text to learn how to cause a line break in an HTML text.

To refer to a [global context](#) variable, use %FIELD_NAME. For example, if the field SP_ID is in the global context, you may reference %SP_ID to reference the ID of the service point currently in context. In addition, the following special values are supported:

Variable Name	Comments
%CONTEXT-PERSONID	A constant that contains the ID of the current person.
%CONTEXT-ACCOUNTID	A constant that contains the ID of the current account.
%CONTEXT-PREMISEID	A constant that contains the ID of the current premise.

In addition, if the script is invoking something else via one of the various “Invoke” step types and an error is returned, the following global variables contain information about the error:

Variable Name	Comments
%ERRMSG-CATEGORY %ERRMSG-NUMBER	The unique identifier of the error message number.
%ERRMSG-TEXT	The brief description of the error.
%ERRMSG-LONG	The complete description of the error.

How To Name Temporary Storage Fields

Input Data and **Move Data** steps can create fields in temporary storage. You specify the name of the temporary storage field in the step's **Field Name**. The name of the field must not begin with % and must not be named the same as the [global variables](#). Besides this restriction, you can use any **Field Name** that's acceptable to JavaScript (i.e., you can name a field in temporary storage almost anything). Keep in mind that field names are case-sensitive.

How To Work With Dates

Before we discuss how to work with dates in your scripts, we need to point out that there are two types of date fields: date-only and date-time. Date-only fields only contain a date. Date-time fields contain both a date and a time. The following topics describe how to work with dates on the various step types.

NOTE: If you're working with a field that resides on the database (as opposed to a temporary storage field), the database field name will tell you what type of date it is: date-only fields are suffixed with **DT**, and date-time fields are suffixed with **DTTM**.

Move Data

If you intend to use a **Move data** step to populate a *date-time* field, please be aware of the following:

- If the destination field resides in the *page data model*, the source field value must be in the format YYYY-MM-DD-HH.MM.SS or YYYY-MM-DD. If the field is in the format YYYY-MM-DD, the time of 12:00 am will be defaulted.
- If the destination field resides in the *user interface*, you must use two steps if you want to populate both date and time. To explain this, we'll assume the field you want to populate is called EXPIRE_DTTM:
 - First, you populate the date portion of the field. To do this, you'd move a date (this value can be in any valid date format that a user is allowed to enter) to a field called EXPIRE_DTTM_FWDDTM_P1. In other words, you suffix **_FWDDTM_P1** to the field name.
 - If you want to populate the time, you'd move the time (again, the field value can be in any format that a user could use to enter a time) to a field called EXPIRE_DTTM_FWDTTM_P2. In other words, you suffix **_FWDDTM_P2** to the field name.

If you intend to use a **Move data** step to populate a *date-only* field, please be aware of the following:

- If the destination field resides in the *page data model*, the source field value must be in the format YYYY-MM-DD.
- If the destination field resides in the *user interface*, the source field can be in any valid date format that a user is allowed to enter.

NOTE: %CURRENT-DATE. Keep in mind that the [global variable](#)%CURRENT-DATE contains the current date and you can move this to either a page data model, user interface, or temporary storage field. If you move %CURRENT-DATE to a temporary storage fields, it is held in the format YYYY-MM-DD.

Mathematical Operation

If you intend to use a **Mathematical operation** step to calculate a date, you can reference both date-only and date-time fields. This is because mathematical operations are only performed against the date portion of date-time fields.

Mathematical operations are limited to adding or subtracting days, months and years to / from a date.

NOTE: A useful technique to perform date arithmetic using the current date is to move the [global variable](#)%CURRENT-DATE to a temporary storage field and then perform the math on this field.

Input Data

If you intend to use an **Input data** step on a *date-time* field, please be aware of the following:

- If the field resides in the *page data model*, the user must enter a value in the format YYYY-MM-DD-HH.MM.SS (and therefore we do not recommend doing this).
- If the field resides in the *user interface*, you must use two steps if you want to populate both date and time. To explain this, we'll assume the field you want to populate is called EXPIRE_DTTM:
 - First, you populate the date portion of the field. To do this, you'd input the date (this value can be in any valid date format that a user is allowed to enter) in a field called EXPIRE_DTTM_FWDDTM_P1. In other words, you suffix **_FWDDTM_P1** to the field name.
 - If you want to populate the time, you'd input the time (again, the field value can be in any format that a user could use to enter a time) in a field called EXPIRE_DTTM_FWDTTM_P2. In other words, you suffix **_FWDDTM_P2** to the field name.

If you intend to use an **Input data** step to populate a *date-only* field, please be aware of the following:

- If the field resides in the *page data model*, the user must enter a value in the format YYYY-MM-DD (and therefore we do not recommend doing this).
- If the field resides in the *user interface*, the user can enter any valid date format.

How To Use To Do Fields

As described under [Executing A Script When A To Do Entry Is Selected](#), you can set up the system to automatically launch a script when a user selects a To Do entry. These types of scripts invariably need to access data that resides on the selected To Do entry. The following points describe the type of information that resides on To Do entries:

- **Sort keys.** These values define the various ways a To Do list's entries may be sorted. For example, when you look at the bill segment error To Do List, you have the option of sorting the entries in error number order, account name order, or in customer class order. There is a sort key value for each of these options.
- **Message parameters.** These values are used when the system finds *%n* notation within the message text. The *%n* notation causes field values to be substituted into a message before it's displayed. For example, the message text **The %1 non-cash deposit for %2 expires on %3** will have the values of three fields merged into it before it is displayed to the user (%1 is the type of non-cash deposit, %2 is the name of the customer, and %3 is the expiration date of the non-cash deposit). Each of these three values is stored as a separate message parameter on the To Do entry.
- **Drill keys.** These values are the keys passed to the page if a user drilled down on the entry (and the system wasn't set up to launch a script). For example, a To Do entry that has been set up to display an account on the account maintenance page has a drill key of the respective account ID.
- **To Do ID.** Every To Do entry has a unique identifier referred to as its To Do ID.

You can access this information in the following types of steps:

- **Move Data** steps can move any of the above to any data area. For example, you might want to move a To Do entry's drill key to the page data model so it can be used to navigate to a specific page.
- **Conditional Branch** steps can perform conditional logic based on any of the above. For example, you can perform conditional logic based on a To Do entry's message number (note, message numbers are frequently held in sort keys).
- **Mathematical Operation** steps can use the above in mathematical operations.

A To Do entry's sort key values are accessed by using a **Field Type** of **Current To Do Information** and a **Field Name** of **SORTKEY[index]**. Note, you can find an entry's potential sort keys by displaying the entry's To Do type and navigating to the [Sort Keys](#) tab. If you want to reference the first sort key, use an index value of **1**. If you want to use the second sort key, use an index value of **2** (and so on).

A To Do entry's drill key values are accessed by using a **Field Type** of **Current To Do Information** and a **Field Name** of **DRILLKEY[index]**. Note, you can find an entry's potential drill keys by displaying the entry's To Do type and navigating to the [Drill Keys](#) tab. If you want to use the first drill key, use an index value of **1**. If you want to use the second drill key, use an index value of **2** (and so on).

A To Do entry's message parameters are accessed by using a **Field Type** of **Current To Do Information** and a **Field Value** of **MSGPARAM[index]**. Note, because a To Do type can have an unlimited number of messages and each message can have different parameters, finding an entry's message parameters requires some digging. The easiest way to determine these values is to display the To Do entry on [To Do maintenance](#). On this page, you will find the entry's message category/number adjacent to the description. Once you know these values, display the message category/number on [Message Maintenance](#). You'll find the message typically contains one or more %n notations (one for each message parameter). For example, the message text **The %1 non-cash deposit for %2 expires on %3** has three message parameters. You then need to deduce what each of the message parameters are. You do this by comparing the message on the To Do entry with the base message (it should be fairly intuitive as to what each message parameter is). If we continue using our example, **%1** is the non-cash deposit type, **%2** is the account name, and **%3** is the expiration date. You can access these in your scripts by using appropriate index value in **MSGPARAM[index]**.

A To Do entry's unique ID is accessed by using a **Field Type** of **Current To Do Information** and a **Field Value** of **TD_ENTRY_ID**.

In addition, any of the above fields can be [substituted into a text string or prompt](#). Simply prefix the To Do field name with a % as you would fields in temporary storage. For example, assume you want your script to display the following text in the script area: "ABC Supply does not have a bill cycle" (where ABC Supply is the account's name). If the first sort key linked to the To Do entry contains the account's name, you'd enter a text string of **%SORTKEY[1] does not have a bill cycle**.

How To Reference Fields In Data Areas

Various step types involve referencing field elements residing in the [script's data areas](#). To reference an element in a data area you need to provide its absolute XPath notation starting from the data area name. For example, use "F1-BatchControl/batchControl" to reference a top-level "batchControl" element in a script data area called "F1-BatchControl".

You don't have to type in long XPath notations. Use the **View Script Schema** hyperlink provided on the [Script - Step](#) tab page to launch the script's data areas schema.

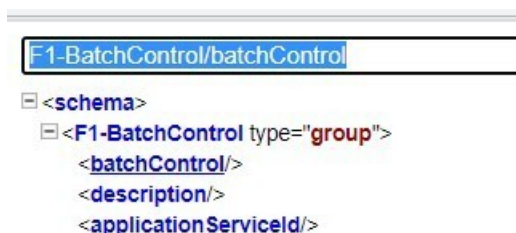

Figure 4: Schema Viewer

Doing this opens the [schema viewer](#) window where you can:

- Click on the field element you want to reference in your script step. The system automatically populates the text box on the top with the element's absolute XPath notation.
- Copy the element's XPath notation from the text box to your script.

You can also use the **View Data Area**, **View Service Script Data Area**, or **View Plug-In Script Data Area** links on [Script - Data Area](#) to the same effect. These open up the schema viewer for a specific data area respectively.

Script Engine Version 2 and Above Notes

Scripting using the engine version 2 or above requires some extra syntax to take advantage of XPath 2 functionality. In general, any variable declared will be assumed to be a string. This means, that if you intend to construct a mathematical statement then it is necessary to explicitly declare the data type of variables as integers, numbers, or dates.

NOTE: Unless otherwise noted, all XPath examples in this topic are for the Version 1 engine – which means XPath 1. Statements that function using XPath 1 will not necessarily work for XPath 2. This is especially true when executing math, see below for examples.

Date and Time Arithmetic

XPath date/time and interval data types support arithmetic operations ('+', '-', '*' etc.) and functions, which can be used for time calculations in the same way as '1 + xs:integer(value)' is used for numeric calculations.

Compare time duration:

```
if ("xs:dateTime(fn:current-dateTime()) - xs:dateTime($updateDateTimeX)
    ge xs:dayTimeDuration(concat('PT', BO/hoursBetweenStatisticsUpdate, 'H'))")
    goto 60;
end-if;
```

Compare one date to another:

```
if ("xs:date(parm/endDate) < xs:date(parm/startDate)")
    terminate with error (11108, 11507 element='endDate');
end-if;
```

Compare a date against today's date:

```
if ("xs:date(parm/startDate) <= xs:date($CURRENT-DATE)")
    terminate with error (11108, 11507 element='endDate');
end-if;
```

Calculate the end of month:

```
// covert to ISO
move "concat($year, '-', $mon2, '-01T00:00:00')" to $monthStart;

// calculate
move "xs:dateTime($monthStart) + xs:yearMonthDuration('P1M') - xs:dayTimeDuration('P0DT1S')"
    to $monthEnd;

// convert from ISO to OUAF
move "concat($year, '-', $mon2, '-', substring(string($monthEnd), 9, 2), '-23.59.59')" to $endDateTime;
```

NOTE: XPath date/time/interval formats use the ISO standard, which needs to be converted to/from formats supported in the framework.

Comparing Date/Times in String Format

Any ISO-like string format for date/time preserves the YYYY MM DD HH MM SS sequence, which is zero-padded. Regardless of separators, this format will remain appropriate for comparison operations. In particular, date/time values in the framework format “YYYY-MM-DD.HH.MM.SS” can be used with “=”, “!=”, as well as “>”, “>=”, “<”, “<=” operators.

```
// retrieve framework date/time value
```



```

invokeBS 'CM-MAXMSRMT' using "CM-MAXMSRMT";
move "string(cm-MAXMSRMT/results[1]/measurementDateTime)" to $lastMsmtDT;

// construct another date/time
move "concat($year,'-01-01-00.00.00')" to $startDateTime;

// compare using string operators
if ("{$lastMsmtDT} >= {$startDateTime}")
    move "substring($lastMsmtDT,1,4)" to $latestMsmtYear;

```

Converting Date/Times Between Framework and ISO

Conversion of date/time from framework format to ISO is only necessary for date/time arithmetic. Comparisons can be done with the framework format directly. The only difference between the framework format and ISO date/time formats is in the separators:

Framework: “YYYY-MM-DD.HH.MM.SS”

ISO: “YYYY-MM-DDTHH:MM:SS”

Example of converting from the framework format to ISO:

```

move "concat(substring($ouafDT, 1, 10), 'T', translate(substring($ouafDT, 12), '.', ':'))" to $isoDT;

```

Example of converting from ISO to the framework format:

```

move "concat(substring($isoDT, 1, 10), '.', translate(substring($isoDT, 12), ':', '.'))" to $ouafDT;

```

Round Money With a Dynamic Currency Scale

Because different currencies support a different number of decimals, the framework provides an API for rounding a monetary amount based on a given currency.

```

move "parm/amount" to $qty;
move "currency/decimals" to $decimals;
move "fn:round(xs:decimal($qty) * math:exp10(xs:double($decimals)))
    div math:exp10(xs:double($decimals))" to "parm/roundedAmount";

```

Looping through Sequences

In XPath 2 it is possible to organize a for-loop over a sequence of integers, not only a node list.

This example shows a loop over a range of months. This is a sequence-forming construct in XPath. The XPath node list, which we are familiar with, is just another type of sequence.

```

for ($month in "1 to 12")

```

This example shows a loop over a give range of years in descending order:

```

for ($year in "fn:reverse(parm/startYear to parm/endYear)")
    move "concat($year,'-01-01-00.00.00')" to $startDateTime;
    move "concat($year,'-12-31-23.59.59')" to $endDateTime;
    ...

```

This example shows a loop through a node list using ‘index’, so that other node lists can be accessed:

```

for ($idx in "1 to count(parm/touData/touList)")
    move "parm/touData/touList[$idx]" to $tou; // access any list with this index

```

The above syntax can be used as an elegant alternative to maintaining indices separately, for example instead of the following:

```

move "0" to $idx;
for ($item in "parm/touData/touList")
    move "1 + xs:integer($idx)" to $idx;

```

String Padding and Decimal Formatting

This is used with specific input formats or output formatting. It is applicable to zero, space and other types of padding.

This example shows prefixing for date/time components, for example producing “2010-01-02” instead of “2010-1-2”.

```
move "substring(concat('0',string($month)), string-length(string($month)), 2)" to $mon2;
```

This example shows suffixing for adding decimal zero-padded alignment, for example producing “12.30” and “4.00” instead of “12.3” and “4”. The example performs 3 tasks: rounding to 2 decimals, inserting a period if necessary, and zero padding.

```
// round and zero-pad to 2 decimals
move "$item/amount" to $qty;
move "fn:round(xs:double($qty) * 100) div 100" to $qty;
move "string($qty)" to $qty;
move "concat(substring-before(concat($qty, '.'), '.'), '.', substring(concat(substring-
after($qty, '.'), '00'), 1, 2))" to $qty;
```

Ternary Operation

This makes a choice between values based on a condition, so that it could be used in a single expression instead of an if/else block. It is known in C/C++ as ‘cond ? value1 : value2’ or in BASIC as ‘IFF(cond, value1, value2)’. In XPath the syntax is: “if (cond) then value1 else value2”. Note this is not the top-level scripting if-statement block.

In XPath this is an expression, which can be combined with other expressions. In scripting it can be used as:

```
move "if (string(D1-UnitOfMeasure/
measuresPeakQuantity) = 'D1MP') then 'D1MX' else 'D1SM' " to $func;
```

Pipeline Processing

In scripting, it is not easy to create a simple reusable piece of code as there are no local functions, and a separate script call is a coding overhead and requires packing/unpacking parameters. To avoid copying and pasting the same code block between similar script stages, consider ‘pipelining’, which is breaking the overall process into separate top-level steps, some of which could be shared between alternating paths. This is common for parameter preparation and output formatting. An intermediate result between stages can be stored in a “parm” substructure.

Instead of this code:

```
if ("type = A")
  prepare params ...
  call services for A ...
  format output ...
end-if;
if ("type = B")
  prepare params ...
  call services for B ...
  format output ...
end-if;
```

Consider this alternative:

```
prepare params ...
if ("type = A")
  call services for A ...
end-if;
if ("type = B")
  call services for B ...
end-if;
format output ...
```

XPath 2 Functions

Script engine versions 2 and above support XQuery 1.0 Functions and Operators, and the XQuery 1.0 standard itself with some minor limitations. Below are the URLs to both specifications. The first link has the functions/operators available to use from XQuery.

- <http://www.w3.org/TR/xpath-functions/>
- <http://www.w3.org/TR/xquery/>

The following can only access local file systems. (For other protocols like http they will return an empty sequence):

- fn:doc
- fn:collection

Script - Data Area

Use this page to define the data areas used to pass information to and from the server or any other data area describing your temporary storage. Open this page using **Admin > System > Script** and then navigate to the **Data Area** tab.

NOTE: Conditional tab page. This tab page does not appear for [Groovy Library scripts](#) or [plug-in scripts](#) using the **Groovy** engine version.

Description of Page

The grid contains the script's data areas declaration. For steps that invoke an object that is associated with a schema, you must declare the associated schema as a data area for your script. In addition, if you have defined one or more data areas to describe the script's temporary storage, you need to declare them too. The following bullets provide a brief description of each field on a script data area:

- **Schema Type** defines the type of schema describing the data area's element structure.
- The data area's schema is the one associated with the referenced **Object**. Only objects of the specified Schema Type may be selected.
- **Data Area Name** uniquely identifies the data area for referencing purposes. By default, the system assigns a data area with the associated object name.
- Click on the **View Data Area** link to view the data area's schema in the [schema viewer](#) window.

The **View Service Script Data Area** link appears for service scripts only. Use this link to view the script's parameters data area schema in the [schema viewer](#) window.

The **View Plug-In Script Data Area** link appears only for plug-in scripts using a script engine version. Use this link to view the script's parameters data area schema in the [schema viewer](#) window.

FASTPATH: Refer to [A Script May Declare Data Areas](#) for more information on data areas.

Script - Schema

Use this page to define the data elements passed to and from a service script. Open this page using **Admin > System > Script** and then navigate to the **Schema** tab.

NOTE: Conditional tab page. This tab page only appears for [service scripts](#).

Description of Page

The contents of this section describe the zones that are available on this portal.

The **General Information** zone displays the script name and description.

The [Schema Designer](#) zone allows you to edit the service script's parameters schema. The purpose of the schema is to describe the input and output parameters used when invoking the script.

NOTE: Refer to [Schema Nodes and Attributes](#) for a complete list of the XML nodes and attributes available to you when you construct a schema.

The **Schema Usage Tree** zone summarizes all cross-references to this schema. For each type of referencing entity, the [tree](#) displays a summary node showing a total count of referencing items. The summary node appears if at least one referencing item exists. Expand the node to list the referencing items and use their description to navigate to their corresponding pages.

Script - Eligibility

Use this page to define a script's eligibility rules. Open this page using **Admin > System > Script** and then navigate to the **Eligibility** tab.

NOTE: Conditional tab page. This tab page only appears for [BPA scripts](#).

Description of Page

Use the **Eligibility Option** to indicate whether the script is **Always Eligible**, **Never Eligible** or to **Apply Eligibility Criteria**. The remaining fields on the page are only visible if the option is **Apply Eligibility Criteria**.

CAUTION: The following information is not intuitive; we strongly recommend that you follow the guidelines under [The Big Picture Of Script Eligibility](#) before attempting to define this information.

The **Eligibility Criteria Group** scroll contains one entry for each group of eligibility criteria. The following fields may be defined for each group:

- Use **Sort Sequence** to control the relative order in which the group is executed when the system determines if the script should appear in the [script search](#).
- Use **Description** and **Long Description** to describe the criteria group.
- Use **If Group is True** to define what should happen if the eligibility criteria (defined in the following grid) return a value of **True**.
 - Choose **Eligible** if this script should appear.
 - Choose **Ineligible** if this script should not appear.
 - Choose **Check Next Group** if the next criteria group should be checked.
- Use **If Group is False** to define what should happen if the eligibility criteria (defined in the following grid) return a value of **False**.
 - Choose **Eligible** if this script should appear.
 - Choose **Ineligible** if this script should not appear.
 - Choose **Check Next Group** if the next criteria group should be checked.

The grid that follows contains the script's eligibility criteria. Think of each row as an "if statement" that can result in the related eligibility group being true or false. For example, you might have a row that indicates the script is eligible if the current account in context belongs to the residential customer class. The following bullets provide a brief description of each field on an eligibility criterion. Please refer to [Defining Logical Criteria](#) for several examples of how this information can be used.

- Use **Sort Sequence** to control the order in which the criteria are checked.
- Use **Criteria Field** to define the field to compare:
 - Choose **Algorithm** if you want to compare anything other than a characteristic. Push the adjacent search button to select the algorithm that is responsible for retrieving the comparison value.
 - Some products may also include an option to choose **Characteristic**. Choosing this option displays adjacent fields to define the object on which the characteristic resides and the characteristic type. The objects whose characteristic values may be available to choose from depend on your product.
- Use **Criteria Comparison** to define the method of comparison:
 - Choose **Algorithm** if you want an algorithm to perform the comparison and return a value of True, False or Insufficient Data. Push the adjacent search button to select the algorithm that is responsible for performing the comparison.

- Choose any other option if you want to compare the **Criteria Field** using a logical operator. The following options are available:
 - Use **>**, **<**, **=**, **>=**, **<=**, **<>** (not equal) to compare the **Criteria Field** using standard logical operators. Enter the comparison value in the adjacent field.
 - Use **IN** to compare the **Criteria Field** to a list of values. Each value is separated by a comma. For example, if a field value must equal **1, 3 or 9**, you would enter a comparison value of **1,3,9**.
 - Use **BETWEEN** to compare the **Criteria Field** to a range of values. For example, if a field value must be between **1 and 9**, you would enter a comparison value of **1,9**. Note, the comparison is inclusive of the low and high values.
- The next three fields control whether the related logical criteria cause the eligibility group to be considered true or false:
 - Use **If True** to control what happens if the related logical criterion returns a value of True. You have the options of **Group is true**, **Group is false**, or **Check next condition**. If you indicate **Group is true** or **Group is false**, the script is judged **Ineligible** or **Eligible** based on the values defined above in **If Group is False** and **If Group is True**.
 - Use **If False** to control what happens if the related logical criterion returns a value of False. You have the options of **Group is true**, **Group is false**, or **Check next condition**. If you indicate **Group is true** or **Group is false**, the script is judged **Ineligible** or **Eligible** based on the values defined above in **If Group is False** and **If Group is True**.
 - Use **If Insufficient Data** to control what happens if the related logical criterion returns a value of "Insufficient Data". You have the options of **Group is true**, **Group is false**, or **Check next condition**. If you indicate **Group is true** or **Group is false**, the script is judged **Ineligible** or **Eligible** based on the values defined above in **If Group is False** and **If Group is True**.

Merging Scripts

Use the Script Merge page to modify an existing script by copying steps from other scripts. The following points summarize the many diverse functions available on the Script Merge transaction:

- You can use this transaction to renumber steps (assign them new sequence numbers).
- You can use this transaction to move a step to a different position within a script. When a step is moved, all references to the step are changed to reflect the new sequence number.
- You can use this transaction to delete a step.
- You can use this transaction to copy steps from other scripts. For example:
 - You may want to create a script that is similar to an existing script. Rather than copying all the information from the existing script and then removing the inapplicable steps, this page may be used to selectively copy steps from the existing script to the new script.
 - You may have scripts that are very similar, but still unique. You can use this transaction to build large scripts from smaller scripts. In this scenario, you may choose to create special 'mini' scripts, one for each of the various options that may make a script unique. Then, you could use the script merge page to select and merge the mini scripts that are applicable for a main script.

NOTE: The target script must exist prior to using this page. If you are creating a new script, you must first create the [Script](#) and then navigate to the merge page to copy step information.

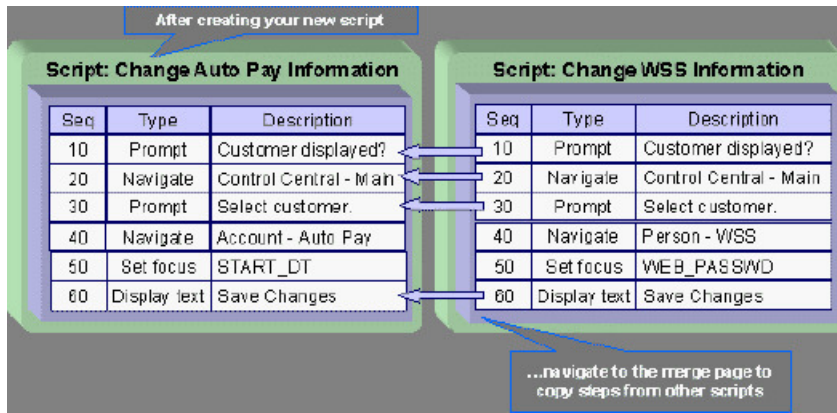

NOTE: Duplicate versus Merge. The **Script** page itself has **duplication** capability. You would duplicate a script if you want to a) create a new script and b) populate it with *all* the steps from an existing script.

Script Merge

Open **Admin > System > Script Merge** to open this page.

Description of Page

For **Original Script**, select the target script for merging steps.

For **Merge From Script**, select the template script from which to copy the steps.

NOTE: You may only copy steps from one Merge From script at a time. If you want to copy steps from more than one script, select the first Merge From script, copy the desired steps, save the original script, and then select the next Merge From script.

The left portion of the page displays any existing steps for the **Original Script**. The right portion of the page displays the existing steps for the **Merge From Script**.

You can use the **Copy All** button to copy all the steps from the **Merge From** script to the **Original** script. If you use **Copy All**, the steps are added to the end of the original script.

Each time you save the changes, the system renumbers the steps in the original script using the **Start From Sequence Number** and **Increment By**.

Merge Type indicates **Original** for steps that have already been saved in the original script or **Merge** for steps that have been merged, but not yet saved. The **Sequence**, **Step Type** and **Description** for each step are displayed.

The topics that follow describe how to perform common maintenance tasks:

Resequencing Steps

If you need to resequence the steps:













- Use the up and down arrows in the Original Script grid to reorder the steps.
- Make any desired changes to the **Start From Sequence Number** or **Increment By**.
- Click Save.

The steps are given new sequence numbers according to their order in the grid.









Removing a Step from Script

If you want to remove a record linked to the Original script, click the delete button to the left of the record.

For example, to remove the **Reset existing bundle XML** step, click the  icon.

		Merge Type	Sequence	Step Type	Description
	 	Original	10	Edit data	Edit data - Check that the BO is an Export Bundle
	 	Original	20	Edit data	Edit data - Read the Bundle
	 	Original	30	Edit data	Edit data - Reset existing bundle XML
	 	Original	40	Edit data	Edit data - Create new bundle XML

After removal, the grid displays:









		Merge Type	Sequence	Step Type	Description
	 	Original	10	Edit data	Edit data - Check that the BO is an Export Bundle
	 	Original	20	Edit data	Edit data - Read the Bundle
	 	Original	40	Edit data	Edit data - Create new bundle XML

NOTE: You cannot delete a step that is referenced by other steps unless you also delete the referencing steps, such as **Go to step** or **Prompt** type steps. The system informs you of any missing referenced steps when you attempt to save the original script.

Adding a Step to a Script

You can move any of the steps from the Merge From script to the Original Script by clicking the left arrow adjacent to the desired step. Once a record is moved it disappears from the Merge From information and appears in the Original information with the word **Merge** in the Merge Type column.

For example, to copy the **Navigate to a page** step, click the left arrow.

	Merge Type	Sequence	Step Type	Description
		10	Height	Height - 0%
		20	Move data	Move data - Copy 'APP_SVC_ID' to 'APP_SVC_ID'
		30	Move data	Move data - Copy 'USR_GRP_ID' to 'USR_GRP_ID'
		40	Navigate to a page	Navigate to a page - userGroupAppService
		50	Conditional branch	Conditional branch - Compare ACTION with UPDATE
		60	Press a button	Press a button - IM_scrollSec_add
		70	Move data	Move data - Copy 'APP_SVC_ID' to 'UGP\$APP_SVC_ID'
		80	Label	Label - End of Script

The step is moved to the left portion of the page.

	Merge Type	Sequence	Step Type	Description
↔	↔ ↔	Merge	40	Navigate to a page Navigate to a page - userGroupAppService

	Sequence	Step Type	Description
↔	10	Height	Height - 0%
↔	20	Move data	Move data - Copy 'APP_SVC_ID' to 'APP_SVC_ID'
↔	30	Move data	Move data - Copy 'USR_GRP_ID' to 'USR_GRP_ID'
↔	50	Conditional branch	Conditional branch - Compare ACTION with UPDATE
↔	60	Press a button	Press a button - IM_scrollSec_add
↔	70	Move data	Move data - Copy 'APP_SVC_ID' to 'UGP\$APP_SVC_ID'
↔	80	Label	Label - End of Script

NOTE: If you add a step, such as **Go to step** or **Prompt** type steps, that references other steps, you must also add the referenced steps. The step references are updated to use the new sequence numbers when you save the original script. The system informs you of any referenced steps that haven't been added when you attempt to save the original script.

Removing an Uncommitted Step from a Script

	Merge Type	Sequence	Step Type	Description
↔	↔ ↔	Merge	40	Navigate to a page Navigate to a page - userGroupAppService

Remove Merged Step - Script Merge - row 1

	Sequence	Step Type	Description
↔	10	Height	Height - 0%
↔	20	Move data	Move data - Copy 'APP_SVC_ID' to 'APP_SVC_ID'
↔	30	Move data	Move data - Copy 'USR_GRP_ID' to 'USR_GRP_ID'
↔	50	Conditional branch	Conditional branch - Compare ACTION with UPDATE
↔	60	Press a button	Press a button - IM_scrollSec_add
↔	70	Move data	Move data - Copy 'APP_SVC_ID' to 'UGP\$APP_SVC_ID'
↔	80	Label	Label - End of Script

Maintaining Functions

NOTE: Functions were implemented prior to the introduction of business services (BS), service scripts (SS) and business objects (BO). The functionality is still supported, but the recommendation for implementations going forward is to use one of the above configuration tool objects in a script rather than defining a function. The documentation has not been updated throughout this section to highlight where BS, SS or BO could be used to perform the equivalent logic.

Invoke function steps may be used to retrieve or update data independent of the page currently being displayed. For example, if you design a script that takes different paths based on the customer's customer class, you could invoke a function to retrieve the customer's customer class. Doing this is much more efficient than the alternative of transferring to the account page and retrieving the customer class from the Main page.

An **Invoke function** step retrieves or updates the relevant data by executing a service (on the server). These types of steps do not refer to the service directly. Rather, they reference a "function" and the function, in turn, references the service.

NOTE: Functions are abstractions of services. A function is nothing more than meta-data defining the name of a service and how to send data to it and retrieve data from it. Functions allow you to define a scriptwriter's interface to services. They also allow you to simplify a scriptwriter's set up burden as functions can handle the movement of data into and out of the service's XML document.

The topics in this section describe how to set up a function.

NOTE: You can retrieve data from all base-package objects. If you know the name of the base-package "page" service used to inquire upon an object, you can retrieve the value of any of its fields for use in your scripts. To do this, set up a function that sends the unique identifier of the object to the service and retrieves the desired fields from it.

Function - Main

Use this page to define basic information about a function. Open this page using **Admin > System > Function**.

Description of Page

Enter a unique **Function** code and **Description** for the function.

Use the **Long Description** to describe, in detail, what the function does.

Define the **Internal Service** that the function invokes.

NOTE: Only page services can be invoked.

The tree summarizes the following:

- The fields sent to the service. You can use the hyperlink to transfer to the **Send Fields** tab with the corresponding field displayed.
- The fields received from the service. You can use the hyperlink to transfer to the **Receive Fields** tab with the corresponding field displayed.
- Scripts that reference the function. You can use the hyperlink to transfer to the script page.

Function - Send Fields

Use this page to add or update the fields sent to the service. Open this page using **Admin > System > Function** and then navigate to the **Send Fields** tab.

NOTE: Displaying a specific field. Rather than scrolling through each field, you can navigate to a field by clicking on the respective node in the tree on the Main tab. Also note, you can use the Alt+right arrow and Alt+left arrow accelerator keys to quickly display the next and previous entry in the scroll.

NOTE: You're defining the service's input fields. On this tab, you define which fields are populated in the XML document that is sent to the service. Essentially, these are the service's input fields.

Description of Page

Use **Sequence** to define the order of the **Send Fields**.

Enter a unique **Function Field Name** and **Description** for each field sent to the application service. Feel free to enter **Comments** to describe how the field is used by the service.

Use **Field Value Source** to define the source of the field value in the XML document sent to the service:

- If the field's value is the same every time the function is invoked, select **Defined On The Function**. Fields of this type typically are used to support "hard-coded" input values (so that the scriptwriter doesn't have to populate the field every time they invoke the function). Enter the "hard-coded" **Field Value** in the adjacent field.
- If the field's value is supplied by the script, select **Supplied By The Invoker**. For example, if the function retrieves an account's customer class, the script would need to supply the value of the account ID (because a different account ID is passed each time the function is invoked). Turn on **Required** if the invoker must supply the field's value (it's possible to have optional input fields).

Regardless of the Field Value Source, use **XML Population Logic** to define the XPath expression used to populate the field's value in the XML document sent to the service.

Function - Receive Fields

Use this page to add or update the fields received from the service. Open this page using **Admin > System > Function** and then navigate to the **Receive Fields** tab.

NOTE: Displaying a specific field. Rather than scrolling through each field, you can navigate to a field by clicking on the respective node in the tree on the Main tab. Also note, you can use the Alt+right arrow and Alt+left arrow accelerator keys to quickly display the next and previous entry in the scroll.

NOTE: You're defining the application service's output fields. On this tab, you define which fields are populated in the XML document that is received from the service. Essentially, these are the service's output fields.

Description of Page

Use **Sequence** to define the order of the **Receive Fields**.

Enter a unique **Function Field Name** and **Description** for each field received from the service. Feel free to enter **Comments** to describe the potential values returned from the service.

Turn on **Required** if the invoker must use the field.

Regardless of the Field Value Source, use **XML Population Logic** to define the XPath expression used to retrieve the field's value from the XML document received from the service.

NOTE: Fields in multiple lists. If a field within the list is unique across the service, the generic list reference is sufficient for the XML population logic. However, if the field you are trying to reference is in multiple lists, the XPath must include the list name. For example, instead of `/pageBody/list/listBody/field[@name='FIELD_NAME']`, the XPath Population Logic must read `/pageBody/list[@name='LIST_NAME']/listBody/field[@name='FIELD_NAME']`.

Maintaining Managed Content

The Managed Content object is used to store various types of text content. Some content is used internally such as Allowlists. Other content may be used by implementations such as XSL files used for communicating messages with an external system, JavaScript include files, and CSS files. These files may then be maintained in the same manner as the HTML in UI Maps.

Open this page using **Admin > System > Managed Content**.

Use the **Managed Content Query** portal to search for an existing managed content entry. Once the managed content is selected, you are brought to the maintenance page to view and maintain the selected record.

Most fields on the page are self explanatory.

Use **Managed Content Type** to indicate the type of content.

- **Allowlist**

is used to capture a list of supported values for given functionality. For example, the product provides allowlists for SQL functions and valid HTML tags.

- **XSLTC** is used to reference XSL files. These may be used internally for user interface referencing. Additionally, the XSLs may be referenced for sending messages to external system using [outbound message](#) and for receiving messages in SOAP as [inbound messages](#).

NOTE: The value FIX (XSLT) is no longer supported and will be deprecated in a future release. Other managed content values are not currently supported by any current framework functionality and are reserved for future use.

Use the **Schema** tab to view and maintain the contents of the managed context text.

Defining Entity Tags

This portal is used to maintain an entity tag along with the list of entities associated with it. Entity tagging supports grouping of configuration, demo and test related entities so they can better describe a logical function. Each group is represented by a unique tag name and entities may be associated with multiple tags.

An entity tag may explicitly restrict the type of entities it can be associated with by referencing a specific maintenance object as part of the entity tag record.

You can access the portal from the **Admin Menu > Implementation Tools > Entity Tag**. You are brought to a query portal with options for searching for a specific tag name. Once an entity tag has been selected you are brought to the maintenance portal to view and maintain the selected record.

A **Tags** dashboard zone allows you to review, add and remove tags for the current entity you review. For configuration type of entities, you may use this portal to tag multiple entities at once.

The following zones may appear as part of the portal's **Main** tab page

- **Entity Tag.** This zone provides information about the selected entity tag.
- **Tagged Entities.** This zone lists entities associated with the selected entity tag. You may also use the zone to remove entities from the list.
- **Tag Entities.** Use this zone to add configuration entities to the selected tag.

Advanced Schema Topics

The topics in this section describe some advanced information related to schemas used for business objects, business services, service scripts and UI maps.

Schema Nodes and Attributes

For business object definition, the purpose of the schema is to create a link between the schema and a maintenance object. For business service definition you are specifying the link between the schema and a service (either a general service, search service, or a maintenance object service). For service script definition, you are defining the API for passing information to and from the script. The following documentation is a complete list of the XML nodes and attributes available to you when you construct a schema.

Contents

- [The Four Element Types](#)
- [The Data Type of a Field Element](#)
- [Referencing Other Elements](#)
- [Standard Time Considerations](#)
- [The Mapping Attributes](#)
- [Descriptive Attributes](#)
- [Schema Constants](#)
- [Defaulting and System Variables](#)
- [The Flattening Nodes and Attributes](#)
- [Search Zone](#)
- [Extend Security for Service Script](#)
- [Overriding Action for a Business Service](#)
- [Specifying searchBy for a Search Service](#)
- [Including Other Schemas](#)
- [Compatibility Attributes](#)

The Four Element Types

A schema element can be one of four different structure types. Note that there are two classes of element types: the structural nodes group and list, and the data containing nodes of field and raw.

Mnemonic	Valid Values	Description	Examples
type=	"field"	The field type is the default type for any element not explicitly labeled as something other than a field. Therefore, you virtually never have to explicitly label an element as a field. Note that a field element, unlike group or list, will contain information in its nodes - rather than other nodes.	
	"group"	<p>The group element is typically a structural element of the schema only, in which case it has no mapping.</p> <p>Note that when grouping several elements that are all used to map an XML structure of a CLOB / XML field of a business object driven record, the mapping may be at the group level.</p>	<p>Example where a group is used to create a structure</p> <pre><schema> <input type="group" <userId/> </input> <output type="group"> <firstName/> <lastName/> </output> </schema></pre> <p>Example where the group includes the mapping:</p> <pre><parameters type="group" mapXML="BO_DATA_AREA" mdField= "F1_TODOSUMEMAIL_PARM_LBL" / > <numberOfDays mdField="F1_NBR_DAYS" required="true" /> <frequency mdField="F1_FREQUENCY" / ></pre>
	"list"	The list node is structural node like the group node. The only difference is that the list structure	<p>Example of a schema with a list:</p> <pre><schema> <statesList type="list"></pre>

Mnemonic	Valid Values	Description	Examples
		has the ability to repeat multiple times in an XML document.	<pre><state isPrimeKey="true" /> > <description/> </statesList> </schema></pre> <p>Example of a schema with a list:</p> <pre><xml> <statesList> <state>AK</state> <description>Alaska</ description> </statesList> <statesList> <state>AL</state> <description>Alabama</ description> </statesList> ... </xml></pre>
	"raw"	The raw data type is used to capture a chunk of raw text that doesn't have any inherent structure associated with it.	<pre><sendDetail type="raw" /></pre> <p>Example of an XML instance for the above schema:</p> <pre><sendDetail> <messageInfo> <senderAddress>123 W. Main St, </senderAddress> <corpZone>3A</ corpZone> </messageInfo> </sendDetail></pre>

The Data Type of a Field Element

Of the four different element types, only a field can have a data type.

Mnemonic	Valid Values	Description	Examples
dataType=	"string"	By default, a field element is a string. Therefore, there is no requirement to specify the string data type.	<pre><schema> <custName dataType="string" /> > </schema></pre>
	"number"	<p>Defines an element that is a number.</p> <p>NOTE: UI hints include a setting to Suppress Automatic Number Formatting.</p> <p>NOTE: Use currencyRef attribute for auto-display of currency symbol that is associated with the referenced currency code. The currency decimal positions are ignored by this formatting allowing you</p>	<p>Examples</p> <pre><schema> <count dataType="number" /> > </schema></pre> <pre><schema> <taxRate dataType="number" currencyRef="currency" /> > </schema></pre>

Mnemonic	Valid Values	Description	Examples
		to display a currency symbol for a unit rate with many decimals.	
"money" Optional additional attributes currencyRef ="element name"		Defines an element that represents a monetary amount. The currency reference is optional and if left blank the installation currency will be used. Automatic formatting and validation to be applied based on the currency. For example, the currency symbol will be shown when auto-rendering. In addition, the number of decimal places must not exceed the valid number defined for the currency. NOTE: Refer to Referencing Other Elements for supported syntax for referring to other elements.	<pre><schema> <currency default="USD" suppress="true" /> <balance dataType="money" currencyRef="currency" / > </schema></pre>
"lookup" Required additional attribute lookup ="field name"		Defines an element that has valid values defined using a lookup. The lookup field is required.	<pre><schema> <status dataType="lookup" lookup="STATUS_FLG" /> </schema></pre>
"lookupBO" Required additional attribute lookupBO ="bo name"		Defines an element that has valid values defined using an extendable lookup. The extendable lookup's business object is required.	<pre><schema> <category dataType="lookupBO" lookupBO="CM- BusinessCategory" /> </schema></pre>
"boolean"		Defines an element that has values of "Y" and "N".	<pre><schema> <allowsEdit dataType="boolean" / > </schema></pre>
"date"		Defines an element that represents a date.	<pre><schema> <startDate dataType="date" / > </schema></pre>
"dateTime"		Defines an element that represents a date and time. NOTE: Refer to Standard Time Considerations for additional configuration available for date / time fields that represent standard time.	<pre><schema> <startDateTime dataType="dateTime" /> </schema></pre>
"time"		Defines an element that represents a time.	<pre><schema> <startTime dataType="time" / > </schema></pre>
"uri"		Defines an element captures a URI. Elements defined with	<pre><schema></pre>

Mnemonic	Valid Values	Description	Examples
		this type enable the support for URI Allowlist and Substitution as described in Referencing URIs .	<pre><exportDirectory dataType="uri" /> </schema></pre>

Referencing Other Elements

There are several attributes that allow for a reference to another element in the same schema. The supported syntax of the XPath reference is the same in every case. This section provides examples using the default reference attribute (**defaultRef**).

Reference a sibling element:

```
<schema>
  <id mapField="ACCT_ID" required="true" />
  <altId defaultRef="id" required="true" />
</schema>
```

Reference an element in a higher group:

```
<schema>
  <id mapField="ACCT_ID" required="true" />
  <msgInfo type="group" mapXML="XML_FIELD">
    <altId defaultRef="../id" required="true" />
  </msgInfo>
</schema>
```

Reference an element in a lower group:

```
<schema>
  <id mapField="ACCT_ID" defaultRef="msgInfo/altId" required="true" />
  <msgInfo type="group" mapXML="XML_FIELD">
    <altId required="true" />
  </msgInfo>
</schema>
```

Reference an element in another group:

```
<schema>
  <acctInfo type="group">
    <id mapField="ACCT_ID" required="true" />
  </acctInfo>
  <msgInfo type="group" mapXML="XML_FIELD">
    <altId defaultRef="../acctInfo/altId" required="true" />
  </msgInfo>
</schema>
```

Standard Time Considerations

Most date / time fields represent "legal" time such that if a time zone changes their clocks for winter and summer time, the date / time field captures the current observed time. However, some date / time fields should always be captured in standard time to avoid confusion / ambiguity. A good example is a date and time related to detailed interval data. Refer to [Designing Time Zones](#) for more information.

When defining an element with **dataType="dateTime"**, you may optionally configure **stdTime="true"** indicating that data captured in the element always represents standard time in the 'base' time zone. The 'base' time zone is specified on the [Installation options](#).

NOTE: If an element is mapped to a table / field with a Standard Time Type of **Physical**, then **stdTime="true"** is implied. Refer to [Fields](#) for more information.

Example:

```
<schema>
  <startTime dataType="Time" stdTime="true" />
</schema>
```

If the time zone that represents the date / time field is not the installation time zone, use the optional setting **stdTimeRef**="XPath to time zone element" on a date / time element to indicate that the element represents standard time and indicates the time zone to use. Refer to [Referencing Other Elements](#) for supported syntax for referring to other elements. .

Example:

```
<schema>
  <alternateTimeZone fkRef="F1-TZONE" suppress="true"/>
  <startDateTime dataType="dateTime" stdTimeRef="alternateTimeZone" />
</schema>
```

NOTE: If an element is mapped to a table / field with a Standard Time Type of **Referenced**, then **stdTime**="XPath" is implied. Refer to [Fields](#) for more information.

NOTE: When schema elements are captured in standard time the UI map supports HTML notation to automatically display the data applying a daylight savings time / summer time correction. Refer to the HTML attribute **oraType**="dateTime; stdTime:true" for more information.

There may be cases where the date / time is captured as standard time in one time zone, but should be displayed using a different time zone. In this case, the attribute **displayRef**="XPath" may be used in addition to the appropriate attribute that identifies the time zone that the data is capture in. Refer to [Referencing Other Elements](#) for supported syntax.

```
<schema>
  <displayTimeZone fkRef="F1-TZONE" suppress="true" />
  <startDateTime dataType="dateTime" stdTime="true" displayRef="displayTimeZone" />
</schema>
```

The Mapping Attributes

When constructing your schema, you can choose from one of the following mapping attributes.

Mnemonic	Valid Values	Description	Examples
mapField=	"field name"	In the case of a business object, the mapField attribute is used to identify the database column the element is related to. For business service schemas, the mapField= attribute is used to link a schema element with a service element.	<pre><schema> <factId mapField="FACT_ID" /> </schema></pre>
mapChild=	"table name"	<p>The mapChild attribute is used only for business object mapping. It is used in two ways:</p> <ul style="list-style-type: none"> First, to create a list in the business object that corresponds to a child table of an MO. Second, you can use mapChild to identify the child table a flattened field lives in. For more information on flattening, refer to flattening section below. 	<p>Example of a list within a child table in a BO:</p> <pre><persons type="list" mapChild="CI_ACCT_PER" <personId mapField="PER_ID" / > </persons></pre>

Mnemonic	Valid Values	Description	Examples
mapList=	"list name"	<p>The mapList attribute is used only for business service mapping. It is used in two ways:</p> <ul style="list-style-type: none"> First, to create a list in the business service that corresponds to a list in the service. Second, you can use mapList to identify the list that a flattened field lives in. For more information on flattening, refer to flattening section below. 	<p>Example of a list within a business service:</p> <pre><selectList type="list" mapList="DE" <value mapField="COL_VALUE"> <row mapList="DE_VAL"> <SEQNO is="2"/> </row> </value> </selectList></pre>
mapXML=	"field name"	<p>The mapXML attribute is typically used to map XML structures into a large character / XML field of the service. Note that when you use mapXML to map either a list or group structure (type="list" or type="group") you don't have to map all the child elements within the structure. It is also possible to map list elements to a large character field associated with the list child.</p>	<pre><enrollmentRequest type="group" mapXML="CASE_CLOB"> <messageID/> <sender/> </enrollmentRequest> <enrollmentKey mapXML="CASE_CLOB" /> <enrollmentInfo type="list" mapChild="CI_CASE_CHILD"> <sequence mapField="CHILD_SEQ" /> <name mapXML="CASE_CHILD_CLOB" / > <value mapXML="CASE_CHILD_CLOB" / > </enrollmentInfo></pre>
isPrimeKey=	"true"	<p>You must specify a primary key for a list defined within a mapped XML element (type="list" mapXML="CLOB"). The primary key is used by the framework to determine whether a list element add, update or delete is required during a business object update.</p> <p>NOTE: You do not need to specify the prime key for a business object list mapped to maintenance object list. When a physical list is mapped, the prime key is derived from existing physical meta-data.</p>	<pre><questionnaire type="list" mapXML="CASE_CLOB"> <question isPrimeKey="true" /> <answer/> </questionnaire></pre>
orderBy=	"XPath asc desc, XPath asc desc"	<p>By default, a list defined within a mapped XML element (type="list" mapXML="CLOB") is sorted by the first element of the list. A different sort order may be specified using the orderBy attribute. The attribute value is a comma separated list of</p>	<pre><questionnaire type="list" orderBy="page/section, page/sequence" mapXML="CASE_CLOB"> <question isPrimeKey="true" / > <answer/> <page type="group"> <section/> <sequence/> </page> </questionnaire></pre>

Mnemonic	Valid Values	Description	Examples
		field XPath(s) (relative to the list element) with an optional sort order (ascending is the default).	
		NOTE: This is only available for lists mapped as XML within business objects.	

Descriptive Attributes

The following attributes can be used to describe a schema element and provide additional configuration related to the element. Typically, these attributes are useful for field elements only.

Mnemonic	Valid Values	Description	Examples
<code><!-- comment --></code>		Use this to add a comment to a schema by using special open and close characters: <code><!--</code> and <code>--></code> .	<pre><schema> <!-- This schema is used to capture business information only, please refer to the 'HUMAN' BO for person information --> </schema></pre>
<code>description=</code>	"text"	The description of an element may be used to provide an internal description of the element to help a reader of the schema to understand the business reason for the element.	<pre><schema> <active type="boolean" description="active account" label="Active" /> </schema></pre>
<code>label=</code>	"text"	The label of an element is meant to be a short bit of verbiage that would typically precede the element in a user interface.	<pre><schema> <active type="boolean" description="active account" label="Active" /> </schema></pre>
<code>required=</code>	"true"	Used to require the existence of an element during object interaction. NOTE: For included schemas, the <code>required="true"</code> attribute is not processed on business object and business service schemas when they are included within a service script schema. This is to support the ability of the service script to populate required elements before an embedded business object or business service is invoked from the service script.	<pre><schema> <logDate mapField="LOG_DT" default="%CurrentDate" required="true" private="true" </schema></pre>
<code>mdField=</code>	"field code"	The meta-data field attribute is used to associate an element with a field's metadata. The field defines data type, as well as its	<pre><schema> <active mdField="CM_ACTIVE_SW" /> </schema></pre>

Mnemonic	Valid Values	Description	Examples
		<p>label and help text. If you link an element with a meta-data field, you don't need to specify any of these attributes.</p> <p>NOTE: For a business object schema, the mapField attribute is used to derive the data type and label. An mdField attribute may be provided to override these attributes, if needed. If the element is mapped to an XML column, the mdField is needed to provide the appropriate data type and label.</p>	
fkRef=	"FK Reference Code"	<p>If the element is a foreign key, defining its FK Reference will enable framework validation of the element during schema interaction and automatically provide descriptions and navigation capability.</p>	<pre><schema> <person fkRef="PER" mapField="CHAR_VAL_FK1"> <row mapChild="CI_SA_CHAR"> <CHAR_TYPE_CD is="PER"/ > </row> </person> </schema></pre>
private=	"true"	<p>Marking an element as private will prevent it from being exposed in schema interaction.</p> <p>NOTE: A private element requires a default.</p>	<pre><schema> <type mdField="SA_TYPE_CD" default="E1" private="true"/ > </schema></pre>
suppress=	"true"	<p>This setting prevents an element from appearing in automatically generated user interfaces.</p> <p>NOTE: This attribute can be specified on a group, in which case all elements of the group will be suppressed.</p> <p>NOTE: Refer to Defaulting and System Variables for advice related to default values for suppressed elements.</p>	<pre><schema> <ls mdField="LIFE_SUPPORT_FLG" default="N" suppress="true"/ < </schema></pre>
	"blank"	<p>This setting means that automatic UI rendering in display mode will hide the element if its value is blank. The element will still</p>	<pre><schema> <email mdField="EMAIL" suppress="blank"/> </schema></pre>

Mnemonic	Valid Values	Description	Examples
		<p>be modifiable on the input map whether blank or not.</p>	
	<p>"input"</p>	<p>This setting means that automatic UI rendering will suppress the element for input, although it may still be displayed if it is not blank.</p> <p>NOTE: Elements marked as suppress="input" will behave as with suppress="blank". If the value is blank, no value will be displayed on either the display or input map. If the element's value is present, then the element will be displayed on both the display and input map.</p> <p>NOTE: Refer to Defaulting and System Variables for advice related to default values for suppressed elements.</p>	<pre><schema> <email mdField="EMAIL" suppress="input" /> </schema></pre>
<p>noAudit=</p>	<p>"true"</p>	<p>This setting prevents an element from appearing as a changed element in the business object's audit plug-in spot. If specified on a group or list node it applies to the whole node. You cannot specify it on the schema root node, only on schema elements.</p> <p>NOTE: This attribute is only applicable to business object schemas.</p>	<pre><schema> ... <version mapField="VERSION_NBR" noAudit="true" /> ... <workFields type="group" noAudit="true" <lastProcessedId/> <lastProcessedTime/> </workFields> </schema></pre>
<p>storeEmptyNodes=</p>	<p>"true"</p>	<p>By default, empty nodes are removed from a business object instance when saved. This setting allows a group or a list element to explicitly keep its empty nodes.</p> <p>This attribute may be useful in situations where business object data is exchanged with an external system and there is a need to distinguish between an empty value for an element that participates in the synchronization and an element that does not participate and therefore omitted from the message altogether.</p>	<pre><schema> <message type="group" storeEmptyNodes= ... </message> </schema></pre>

Mnemonic	Valid Values	Description	Examples
		<p>NOTE: This is only available for group and list elements.</p>	
emitEmptyGroups=	"true"	<p>By default, empty nodes are not included in the output of a business object or a business service call. This attribute is set at the top level schema node, allowing empty nodes of all groups and list elements to be included in the output.</p> <p>This attribute may be useful in the same situations that may require the use of the storeEmptyNodes= attribute.</p> <p>NOTE: This is only available for business object and business service schemas.</p>	<pre><schema emitEmptyGroups="true"> <message type="group"> ... </message> </schema></pre>
emitEmptyElements=	"true"	<p>This attribute is similar to the emitEmptyGroups= attribute but may also be specified at the field level. The attribute is applicable to all schema types.</p>	<pre><schema> <messageNumber type="field" emitEmptyE... ... </message> </schema></pre>
adheresToDA=	"comma separated list of data area names."	<p>This attribute is applicable to the schema, group and list nodes. It claims that this sub-schema node is intended to "look like" the schema of one of the listed data areas, for polymorphism reasons in general.</p> <p>NOTE: The recommended approach for enforcing the structure of a shared data area is by including it in the schema. This attribute should be limited to use cases where the ability to include the data area is not possible.</p>	<pre><schema> <messageNumber type="group" adheresToD... ... </message> </schema></pre>

Schema Constants

There are some product owned schemas where the design warrants a value to be defaulted in the schema, but where the value is implementation specific and therefore cannot be defined by the product. For these situations, the product may use a technique called a schema constant. The design of the schema will include a declared constant. At implementation time, a configuration task will include defining the appropriate value for the constant.

For example, imagine the product delivers an algorithm that will create an outbound message when a certain condition occurs. The outbound message type to use must be configured by the implementation. To use a schema constant to define the outbound message type, the base product will configure the following:

- An option type lookup value for the lookup **F1CN_OPT_TYP_FLG** is defined. For example, **M202 - Activity Completion Outbound Message Type** with a Java Value Name of **outmsgCompletion**
- The base schema that is used to create the "complete activity" outbound message references the schema constant using the Java Value Name of the option type's lookup value

```
...
<outboundMessageType mapField="OUTMSG_TYPE_CD" default="%Constant(outmsgCompletion)"/>
...
```

At implementation time, the administrative users must configure the appropriate outbound message type for "activity completion". Then, navigate to [Feature Configuration](#), choose the **Schema Constants** feature type, choose the option type **Activity Completion Outbound Message Type** and enter the newly created outbound message type in the option value.

Schema constants may also be used in the flattening syntax to define [the row elements required for flattening](#).

Defaulting and System Variables

The default attribute can be used to default values into field elements as well as [the row elements required for flattening](#). You can default a field to a constant or to one of several system variables.

When an element is required, the default value is applied at the server level when adding or changing the record where no value is provided for this element.

When an element is optional, a default value may be configured to provide a suggested value to the user when populating the record on the user interface in Add mode. Users should be able to remove the default value for this type of element and the system will not attempt to populate it at save time.

NOTE:

The standard for our 'list' maintenance is to show an empty row for a new list that a user may or may not choose to populate. As such, UI default values are not shown for list elements.

It is not recommended to configure a default attribute for an optional element that is not editable or visible on the user interface in Add mode (for example an element with **suppress="true"** or **suppress="input"** or a list element whose default value is not shown per the previous point). The default for this type of element is still applied but the user doesn't have the ability to reset the value. This may result in inconsistencies as defaulting does not occur for optional fields added by a use case other than the UI interaction.

Mnemonic	Valid Values	Description	Examples
default=	"value"	Use this attribute to default an element to a specified value. The values that are valid depend on the dataType setting.	<pre><schema> <perType mapField="PER_OR_BUS_FLG" default="P" required="true"/ > </schema> <schema> <frequency dataType="number" default="1" required="true"/ > </schema></pre>
	"%CurrentDate"	Used to default the element to the current date. This is only applicable to date elements.	<pre><schema> <logDate mapField="LOG_DT" default="%CurrentDate" required="true"/ > </schema></pre>
	"%CurrentDateTime"	Used to default the element to the current date / time. This is	<pre><schema> <logDateTime mapField="LOG_DTTM" default="%CurrentDateTime" required="true"/></pre>

Mnemonic	Valid Values	Description	Examples
		only applicable to date / time elements.	</schema>
"%StandardDateTime"		Used to default the standard date and time. The standard date and time is identical to the current date and time, unless daylight savings time / summer time is in effect for the base time zone. This may be used with the stdTime attribute. NOTE: Refer to Standard Time Considerations for more information.	<schema> <startDateTime mapField="START_DTTM" default="%StandardDateTime" required="true"/> </schema>
"%ProcessDate"		You can default the process date. The process date differs from the current date because the process date will remain constant throughout the duration of the process being executed. The current date will reflect the actual date of processing. This is similar to the batch business date that is a standard batch parameter .	<schema> <billDate mapField="BILL_DT" default="%ProcessDate" required="true"/> </schema>
"%ProcessDateTime"		This is similar to " %ProcessDate " but for date / time fields.	<schema> <calcDateTime mapField="CALC_DTTM" default="%ProcessDateTime" required="true"/> </schema>
"%CurrentUser"		Used to default the element to the current user.	<schema> <logUser mapField="LOG_USER" default="%CurrentUser" required="true"/> </schema>
"%CurrentUserTimeZone"		Used to default the element to the current user's time zone. If the current user's time zone is not found, the installation time zone is used.	<schema> <timeZone default="%CurrentUserTimeZone" required="true"/> </schema>
"%CurrentUserLanguage"		Used to default the element to the current user's language.	<schema> <custLanguage mapField="CUST_LANG" default="%CurrentUserLanguage" required="true"/> </schema>
"%InstallationCurrency"		Used to default the currency from the installation record.	<schema> <currency mapField="CURRENCY_CODE" default="%InstallationCurrency" required="true"/> </schema>
"%InstallationCountry"		You can default the country from installation record.	<schema> <country mapField="COUNTRY" default="%InstallationCountry" required="true"/> </schema>

Mnemonic	Valid Values	Description	Examples
			</schema>
	"%InstallationLanguage"	You can default the language from the installation record.	<pre><schema> <language mapField="LANGUAGE" default="%InstallationLanguage" required="true"/> </schema></pre>
	"%Constant()"	You can default an element value using a schema constant .	<p>The following is an example of a schema constant used as a default value, where the Java Value Name of the Lookup Value is 'customerLanguage'.</p> <pre><language mapField="CUSTOMER_LANG" default="%Constant(customerLanguage)" required="true"/></pre>
	"%Context()"	<p>You can default a value contained in a context variable.</p> <p>WARNING: Context variables must be initialized within a server script before the schema context default can be applied. Refer to Context Variables for more information.</p>	<p>An example of a context variable used as a default value:</p> <pre><source mapField="PER_ID" default="%Context(source)" required="true"/></pre> <p>NOTE: When defining a context variable in scripting, it should be prefixed with \$\$. When referring to the variable in the %Context() syntax, the prefix is not included.</p>
defaultRef=	"XPath"	Use this attribute to default the value of one element to the value of another one.	Refer to Referencing Other Elements for supported syntax for referring to other elements.

The Flattening Nodes and Attributes

The term "flattening" is used to describe the act of defining one or more single elements for a schema that are actually part of a list within the maintenance object. Flattening is possible if there are other attributes of the list that can be defined to uniquely describe the element or elements. A common use case for flattening is a characteristic. Rather than defining the characteristics of an object using a collection where the user must choose the characteristic type and then define the value, the characteristics are defined as actual elements with the appropriate label already displayed. This technique enables the designer of the schema and the user interface to display each separate characteristic in the logical place in the user interface rather than all lumped together.

NOTE: A flattened element represents a unique row in the database. This row is inserted when the flattened values are created. The row is updated when any of the flattened values are changed. The row is deleted when all the flattened values are removed. The behavior of effective dated elements is slightly different - please see [Flattening an Effective Dated List](#).

NOTE: The flattening feature can also be used to define a list, see [Flattened List](#).

Identifying the List or Child Table

When flattening a child table, the row node is required to identify the list / child table that the element comes from. Within the row node, at least one element must be defined with an **is=** definition that ensures that the element is a unique row in

the database. It may also define elements or fields in the row that are suppressed and are populated using default value configuration.

- For a business object, the row node defines the child table the flattened field belongs to.

The syntax is `<row mapChild="table name">`. This example is for the list of persons for an account in the customer care and billing product. One person may be marked as the "main" person. This illustrates how to define an explicit element for the main person ID to simplify references to that field. It is part of the CI_ACCT_PER child table. What makes it unique is that the MAIN_CUST_SW is **true** (and only one row may have that value)

```
<custId mapField="PER_ID" mdField="CM-MainCust">
  <row mapChild="CI_ACCT_PER">
    <MAIN_CUST_SW is="true" />
    <ACCT_REL_TYPE_CD default="MAIN" />
  </row>
</custId>
```

NOTE: The above example illustrates that the row node may also define elements within the list that are suppressed and assigned a default value. This syntax is never used to identify a particular row. Note that a default value can either be a literal string, or a [system variable](#).

- For a business service, the row node identifies the list name the flattened field belongs to.

The syntax is `<row mapList="list name">`. This example shows two entries from a list being flattened to a field value and description.

```
<selectList type="list" mapList="DE">
  <value mapField="COL_VALUE">
    <row mapList="DE_VAL">
      <SEQNO is="2" />
    </row>
  </value>
  <description mapField="COL_VALUE">
    <row mapList="DE_VAL">
      <SEQNO is="3" />
    </row>
  </description>
</selectList>
```

Uniquely Identifying the Flattened Field or List

The `is=` syntax within a row or rowFilter element is used to uniquely identify the row.

Mnemonic	Valid Values	Description	Examples
<code>is=</code>	"value"	Use this attribute to reference a value directly.	<pre><tdTypeCd mapField="CHAR_VAL_FK1"> <row mapChild="F1_EXT_LOOKUP_VAL_CHAR"> <CHAR_TYPE_CD is="CM-TD-TYPE" /> </row> </tdTypeCd></pre>
	<code>"%Constant()"</code>	You can configure a flattened element using a schema constant . During a service interaction the value of the schema constant will be used to identify the flattened element in its child row.	<p>An example of a schema constant used in flattening syntax where the Java Value Name of the Lookup field value is 'cmRate'.</p> <pre><unitRate mapField="CHAR_VAL" dataType="number"> <row mapChild= "F1_EXT_LOOKUP_VAL_CHAR"> <CHAR_TYPE is ="%Constant(cmRate)" /> </row></pre>

Mnemonic	Valid Values	Description	Examples
	%n	The %n substitution value is used to reference a relative list instance. A relative list instance is typically used to configure a flattened element for a child table keyed by sequence number. The value of n should be a positive integer value. During a business object read interaction the relative list instance (position) specified by the integer will be returned.	<pre></unitRate></pre> <p>An example with a relative list instance - where the first instance of the row is returned.</p> <pre><schema> <mainPhone mapField="PHONE"> <row mapChild="CI_PER_PHONE"> <PHONE_TYPE_CD is="%Constant(mainPhoneType)"/> > <SEQ_NUM is="%1"/> </row> </mainPhone> </schema></pre>

FASTPATH: Additional values for `is=` are used when [Flattening an Effective Dated List](#). Refer to that section for more information.

Flattening a Pre-defined Characteristic Type

If the flattened field is in a characteristic collection and the characteristic type is a predefined characteristic, automatic UI rendering will generate a dropdown for the list of valid values. For example, the schema below will generate a dropdown for the Usage element showing the valid values of the Status Reason Usage (**F1-SRUSG**) characteristic type.

```
<usage mdField="STATUS_RSN_USAGE" mapField="CHAR_VAL">
  <row mapChild="F1_BUS_OBJ_STATUS_RSN_CHAR">
    <CHAR_TYPE_CD is="F1-SRUSG"/>
    <SEQ_NUM is="1"/>
  </row>
</usage>
```

Defining Multiple Elements from the List

When attempting to include multiple columns from the same list, the system provide shorthand notation for copying the flattening rules defined on another element so that the flattening rules do not need to be repeated. To do this, the row node includes the **rowRef** attribute and it indicates the other element name that defines the mapping information. The following example illustrates flattening the fields Customer ID and Receives Copy of Bill from the same list of Persons for an Account (where the `MAIN_CUST_SW` is `true`).

```
<custId mapField="PER_ID">
  <row mapChild="CI_ACCT_PER">
    <MAIN_CUST_SW is="true" />
    <ACCT_REL_TYPE_CD default="MAIN" />
  </row>
</custId>
<copyBill mapField="RECEIVE_COPY_SW" rowRef="custId"/>
```

Note that the above notation also illustrates that the **rowRef** may be defined directly in the element's attribute definition.

NOTE: Refer to [Referencing Other Elements](#) for supported syntax for referring to other elements.

Flattening Two Layers Deep

If your maintenance object or service has nested lists two layers deep, the system supports flattening an element within a flattened element. This technique also uses the **rowRef** attribute. The flattening of the second level refers to the flattened element of the first level. The following example illustrates flattening a characteristic into an element called `legalContact` for the "main" customer. Notice that the `legalContact` element has two row nodes: one to refer to the flattening information for its parent record and one to define its child table

```
<custId mapField="PER_ID">
  <row mapChild="CI_ACCT_PER">
```

```

    <MAIN_CUST_SW is="true" />
    <ACCT_REL_TYPE_CD default="MAIN" />
  </row>
</custId>
<legalContact mapField="CHAR_VAL_FK1">
  <row rowRef="custId">
    <row mapChild="CI_ACCT_PER_CHAR" >
      <CHAR_TYPE_CD is="LEGAL" />
    </row>
  </row>
</legalContact>

```

Note that the above notation also illustrates that the **rowRef** may be defined as an attribute of a row node rather than directly in the element's attribute definition.

Defining a Flattened List

There are times that a list or child table supports multiple values of the same "type" and these should be presented as a list. To continue with the example above, the list of persons for an account may identify one person as the "main" person. This person has been flattened to a single element (with the account relationship type defaulted and suppressed). To maintain the other persons related to an account, you can define a list where each row captures the Person Id and the Account Relationship Type.

Rather than a row node, the flattened list is configured with a **rowFilter** element. The following schema illustrates the described example. The list node defines the child table. The **rowFilter** includes the criteria that identify the rows within the table to include. The elements of the list are defined within the list node outside the **rowFilter** element.

```

<custId mapField="PER_ID">
  <row mapChild="CI_ACCT_PER">
    <MAIN_CUST_SW is="true" />
    <ACCT_REL_TYPE_CD default="MAIN" />
  </row>
</custId>
<miscPersons type="list" mapChild="CI_ACCT_PER">
  <rowFilter>
    <MAIN_CUST_SW is="false" />
  </rowFilter>
  <relType mapField="ACCT_REL_TYPE_CD" />
  <personId mapField="PER_ID" />
</custId>

```

Note that the system will validate that if a schema contains flattened single elements and flattened lists from the same child table, the criteria that defines what makes them unique must be analogous.

Flattening an Effective Dated List

There are some lists in the application that are effective dated (and still others that have effective date and time). For example, there are some effective dated characteristic collections. In these collections, the design is to capture a single value for a characteristic type that may change over time. It is not meant to support multiple characteristic values in effect at the same time.

There are some maintenance objects that have effective dated characteristics and no sequence based characteristics. For those entities, implementations may want to use the characteristic to define an additional field that doesn't require effective dates.

When considering designing an element for your schema that represents a value in an effective dated collection, consider if the value is one that is used in processes, like calculating a bill, such that it is important to capture changes to the value over time.

- If it is not important to track the changes to the value, the recommendation is to set the effective date to a fixed value in the schema. (Examples below).
- If it is important to track the changes to the value, then you need to consider how you want to design the schema.
 - One option is to define a flattened list as described above. Both the value and the effective date are elements in this list. In this use case, you manage the list just like any list. You can add or remove values.

- Another option is to define a flattened single value in the schema. With this option, when retrieving the record, the latest effective value is returned. In this design, the important question is how is the reference date defined.

NOTE: Refer to [Referencing Other Elements](#) for supported syntax for referring to other elements.

Flattened Elements Where Changes Are Not Tracked

The following is an example of flattening an element in an effective dated collection where the value does not need to be effective dated. The recommendation in this case is to simply hard-code the date in the **is=** attribute.

```
<schema>
  <externalReference mapField="ADHOC_CHAR_VAL" mdField="CM_EXT_REF" dataType="string">
    <row mapChild="CI_SA_CHAR">
      <CHAR_TYPE is="CM_EXT_REF"/>
      <EFFDT is="2000-01-01"/>
    </row>
  </externalReference>
</schema>
```

Flattened Elements Where Changes Are Effective Dated

If you want the BO schema to flatten an effective dated value that should keep track of changes over time, the flattened value will represent the latest effective entry. In this case, the recommendation is to explicitly define the date or date/time field as an element. Then there is syntax for the **is=** attribute to indicate that the explicit date field is the date to use for the value.

Mnemonic	Valid Values	Description	Examples
is=	"%effectiveDate()"	Use this configuration to indicate that the date to use is the value of another element. NOTE: Refer to Referencing Other Elements for supported syntax for referring to other elements.	<pre><schema> <price mapField="CHAR_VAL" dataType="number" required="true"> <row mapChild="CI_SA_CHAR"> <CHAR_TYPE is="PRICE"/ > <EFFDT is="%effectiveDate(priceEdate)" / > </row> </price> <priceEdate mapField="EFFDT" rowRef="price" /> </schema></pre>
	"%effectiveDateTime()"	Use this configuration to indicate that the date / time to use is the value of another element. NOTE: Refer to Referencing Other Elements for supported syntax for referring to other elements.	<pre><schema> <price mapField="CHAR_VAL" dataType="number"> <row mapChild="RATE_CHAR"> <CHAR_TYPE is="PRICE"/ > <EFFDTTM is="%effectiveDateTime(priceEdatetime)" / > </row> </price> <priceEdatetime mapField="EFFDTTM" rowRef="price" /> </schema></pre>

You should consider if the explicit date or date/time element should be displayed on the user interface when the flattened field is shown or if that should be suppressed. Designers should also consider the user dialogue for updating the value. It may be more intuitive for the flattened field to be display only and to have a separate dialogue for updating the effective dated value.

For this option, the suggestion is that the maintenance page for the object includes a separate zone that shows the history of the effective dated values over time. The latest value may be included in that zone as well.

Note that for backward compatibility, the system also supports the following options. However, they are not recommended. They implicitly defined the reference date as the current date at all times. The options supported adding new effective dated

rows when the value changed. But the technique also caused new effective dated rows to appear when other elements of the same schema were updated. The new rows would have the current date or date/time with the same row value because the reference date or date/time is the current date, which is a change. The product does not recommend managing an effective dated characteristic without defining the date or date/time as an explicit element.

Mnemonic	Valid Values	Description	Examples
is=	"%effectiveDate"	This configuration is not recommended	<pre><schema> <price mapField="CHAR_VAL" dataType="number"> <row mapChild="CI_SA_CHAR"> <CHAR_TYPE is="PRICE"/ > <EFFDT is="%effectiveDate"/> </row> </price> </schema></pre>
	"%effectiveDateTime"	This configuration is not recommended	<pre><schema> <price mapField="CHAR_VAL" dataType="number"> <row mapChild="RATE_CHAR"> <CHAR_TYPE is="PRICE"/ > <EFFDT is="%effectiveDateTime" / > </row> </price> </schema></pre>

Search Zone

A UI Map schema element can be configured to enable an automatic search dialog when the schema is included within a maintenance UI map.

NOTE: Please note that an fkRef can be configured with a search zone. If a schema element has an fkRef but no explicit search attributes (as described here) then the fkRef search information will be used in the UI map. In other words, if the schema element already has an fkRef, then these explicit search attributes in the schema are only used to override the fkRef search information.

NOTE: Refer to the [UI Map Attributes and Functions](#) for more information on search zone configuration.

search="search zone"

The search attribute can be used within a UI map schema and is used to automatically generate the oraSearch UI map attribute. The search zone is an explorer zone configured as a search.

```
<person fkRef="PER" search="C1_PSRCH"/>
```

searchField="search field:element|'literal';"

The searchField attribute can only be used in conjunction with the search attribute. The searchField attribute is used to build the oraSearchField UI map attribute. The searchField value is used to populate a search zone filter with an initial value when the search zone is launched. The initial value can be a literal also. The searchField value is used to match to the filter mnemonic also named searchField.

Search field: element|'literal'. The search field represents the search zone filter to populate on launch. The element is the map's schema element used to populate the filter. The element is optional, if left blank, it will default to the element that this attribute is specified on. The searchField also takes 'literal' as input value

NOTE: Multiple filters can be populated within the search zone at launch, but multiple search field pairs must be constructed within the attribute value. The value specified here will be used to directly build the HTML attribute `oraSearchField` within the UI map where this schema is specified.

NOTE: Note that the element reference is *relative*. Refer to [Referencing Other Elements](#) for supported syntax for referring to other elements.

```
<person fkRef="PER" search="C1_PSRCH" searchField="PERSON; PER_TYPE:personType; "/>
```

searchOut="search field:element;"

The `searchOut` attribute can only be used in conjunction with the `search` attribute. The `searchOut` attribute is used to build the `oraSearchOut` UI map attribute. The `searchOut` value is used to capture a selected value from the search zone and move it to a UI map element. The `searchOut` value specified should match the `ELEMENT_NAME` mnemonic within the search result zone parameter.

Search field: element. The search field represents the search zone result brought back to the UI map. The element is the map's schema element to be populated. The element is optional, if left blank, it will default to the element that this attribute is specified on.

NOTE: Multiple elements can be populated as a result of search zone selection, but multiple search field pairs must be constructed within the attribute value. The value specified here will be used to directly build the HTML attribute `oraSearchOut` within the UI map where this schema is specified.

NOTE: Note that the element reference is *relative*. Refer to [Referencing Other Elements](#) for supported syntax for referring to other elements.

```
<person fkRef="PER" search="C1_PSRCH" searchField="PER_ID"
searchOut="PER_ID;PRIMARY_PHONE:personPhone; "/>
```

Extend Security for Service Script

Application service security will be enforced when either a business object or a service script is invoked from a BPA script or a UI map, but not from a service script. If you want security to be enforced when the business object or a service script is invoked from a service script, you must add the following attribute to the service script's schema.

appSecurity="true"

The `appSecurity` attribute is only available for service script schemas. If specified, any business object or service script directly invoked by the service script will have their application service evaluated for access.

```
<schema appSecurity="true">
  ...
</schema>
```

Overriding Action for a Business Service

If you want to invoke a business service with an action other than 'read', you need to specify the action attribute on the primary node business service schema.

pageAction="add, change, delete"

The action attribute is used to override the default action of read on a business service schema. Valid values are:

- add
- update (only allowed for maintenance object service)
- change (not allowed for maintenance object service)

- delete
- read (this is the default action if no pageAction specified)

Example:

```
<schema pageAction="change">
  <parm type="group">
    <ele1/>
    <ele2/>
  </parm>
</schema>
```

Specifying searchBy for a Search Service

If you want to invoke a search service then you must explicitly specify the searchBy attribute appropriate for the elements mapped in the schema.

searchBy="MAIN"

The value values of the searchBy attribute can be found by viewing the XML schema linked to the business service, use the View XML URL. Typical values are:

- MAIN
- ALT
- ALT2
- ALT3
- etc.

```
<schema searchBy="MAIN">
  <AccountID mapField="ACCT_ID" />
  <Results type="list">
    <AccountID mapField="ACCT_ID" />
  </Results>
</schema>
```

Including Other Schemas

There are no limitations on your ability to include a schema into another schema - all types can be included in all other types. Nested includes are also allowed - and at present there is no limitation on the depth of the nesting.

Including a schema requires two parts:

1. The include node
2. The name attribute

The following table highlights the supported include statements.

Mnemonic	Description	Examples
<includeBO name=""/>	<p>Including a business object schema into another schema is allowed.</p> <p>Note that the mapping rules of a business object or business service schema may or may not make sense in the context of the parent schema. Include other schemas at your own risk. However, a very useful aspect of XML processing is that the framework ignores non-pertinent attributes. In other</p>	<pre><schema> <cust type="group"> <includeBO name="C1-Person"/> </cust> <spouse type="group"> <includeBO name="C1-Person"/> </spouse> </schema></pre>

Mnemonic	Description	Examples
	words, it will not hurt to have mapping attributes included into a script schema.	
<code><includeBS name=" "/></code>	Used to include a business service schema.	<pre><schema> <includeBS name="F1-ReadMOLog" /> </schema></pre>
<code><includeDA name=" "/></code>	Used to include a data area schema.	<pre><schema> <includeDA name="F1CommonSchemaFieldData" / > </schema></pre>
<code><includeMP name=" "/></code>	Used to include a UI map schema.	<pre><schema> <includeMP name="F1-DisplayRecordActions" / > </schema></pre>
<code><includeSS name=" "/></code>	Used to include a service script schema.	<pre><schema> <includeSS name="F1-ActShowZn" /> </schema></pre>

Compatibility Attributes

These attributes were added as part of upgrades from previous versions of the Framework.

fwRel="2"

This attribute has been added to schemas created in Framework 2 as part of a Framework 4 upgrade. New schemas will not need this attribute. It is not advisable to modify this attribute without understanding the following behavior differences as improper changes could result in errors:

NOTE: Schemas created in Framework 2 with the `fwRel="2"` attribute will store any XML mapped fields under groups as top-level XML elements in the `mapXML` field. This means that if two or more fields, in different group structures, were to have the same field name, their storage would conflict with one another resulting in errors. The new behavior, without the `fwRel="2"` attribute, will preserve the group structure and avoid the conflicts.

```
<schema fwRel="2"
  ...
</schema>
```

UI Hint Syntax

Contents

- [Working Examples](#)
- [Technical Notes](#)
- [Format an Input Map Title](#)
- [Create a Section](#)
- [Include a Map Fragment](#)
- [Build Dropdown](#)
- [Conditionally Hide Elements](#)
- [Conditionally Protect Elements](#)
- [Trigger Dependent Behavior](#)
- [Control Rendering Target](#)
- [Generate a Text Area](#)
- [Modify FK Reference Defaults](#)
- [Suppress Automatic Number Formatting](#)
- [Auto Capitalize the Input Data](#)

Working Examples

For working examples of uiHint functionality, refer to the following business objects:

BOs with User Assigned Keys

The following examples illustrate the patterns used to enable uiHints on an object with a user specified key.

- **F1-OutcomeStyleLookup.** This extendable lookup BO does not require state transition, but does allow duplicate and delete actions.
- **F1-TodoSumEmailTyp.** This request type illustrates the hints required to support state transition on a display map.
- **F1-WebSvc.** This web service BO is a good example for management of complex JavaScript requirements. Both display and input maps have functionality that requires specialized javascript.

BO with System Generated Key

The following example illustrates the pattern used to enable uiHints on an object with a system generated key.

- **F1-GenericAttachment.** This attachment BO has a system assigned key, which entails the following special handling:
 - **F1-AttachmentMain.** This is the main section data area contains the elements common to all attachments, including the key, bo, and version. Because this data area is used to define the main section of the generated maps, the main section of the map can be extended by an implementation via data area extension functionality.
 - **F1-AttachmentActions.** This record actions map contains the standard actions, Edit and Delete, plus custom actions used only by attachments, View and Upload.
 - **F1-AttachmentIDFrag.** This record information map contains the primary key of the attachment.

Display Map Service Script

Display map service scripts can be fully supported via dynamic HTML generation. However, to help eliminate the need for a display service script, self-contained uiHint functionality has been developed to write the business object status and determine valid state transitions. So the two most common reasons to craft a display service script have been eliminated.

A typical reason to use a display pre-script is if you have an embedded map fragment that contains a business service schema. The display service script can be used to invoke the business service. Both the map fragment and the display service script must declare the business service schema to support this scenario.

WARNING: The zone used to display the object's map must have a derivation script, like **F1-GncDsMpDZ** or **F1-GenDss**, that will invoke a display service script for the business object if it has been defined as a BO option - but not require an explicit display map BO option. In addition, the display service script's schema must be enabled for uiHint functionality - as the script's schema will be dynamically rendered by the zone - and not the BO schema.

- **F1-ExcelSpreadsheet.** This attachment BO has a display service script used to manipulate the attachment business object before displaying it:
- **F1-AttchDtU.** This display map service script's schema has been defined with the uiHint namespace, and will have a display map generated for it.

Maintenance Pre-Processing Service Script

Maintenance pre-processing service scripts can be used with uiHints.

- **F1-ExcelSpreadsheet.** This attachment BO has a maintenance pre-processing service script used to manipulate the attachment business object before rendering the maintenance map:
- **F1-AttchPre.** This pre-processing service script's schema mimics a maintenance map schema with embedded boGroup and action elements. It will be invoked before the maintenance map is rendered.

Maintenance Post-Processing Service Script

Maintenance post-processing service scripts can be used with uiHints.

- **F1-ExcelSpreadsheet.** This attachment BO has a maintenance post-processing service script used to manipulate the attachment business object after rendering the maintenance map:
- **F1-AttchPost.** This post-processing service script's schema mimics a maintenance map schema with embedded boGroup and action elements. It will be invoked after the maintenance map is rendered.

Technical Notes

The following prerequisites are required to support dynamic HTML generation:

Schema Requirements

To support automated UI generation, the business object schema must contain the following:

- `<schema xmlns:uiHint="http://oracle.com/ouafUIHints">`. The schema node must name the uiHint namespace.
- `isPrimeKey="true"`. Every element of the business object schema that is part of the primary key must be identified.

Maintenance Script Requirements

The maintenance script for the MO must be enabled for dynamic generation.

CAUTION: The business object maintenance BPA script must be declared as an MO Option for uiHint maintenance functionality to work!

If the script performs **F1-BOProc** then it is likely no special functionality is needed. However, if the maintenance script contains its own call to **F1-GetValOpt** then the following statement is required prior to that call:

```
move 'false' to "F1-GetBOOpts/input/maintenanceMapRequired";
performScript 'F1-GetValOpt';
```

After the call to **F1-GetValOpt** the following logic must be included to dynamically declare the map schema if the business object does not have a maintenance map of its own:

```
// Perform Main Processing
if ("F1-GetBOOpts/output/maintenanceMap = $BLANK")
  declareBOWithBOGroup "$bo" as 'map_schema';
else
  declareMap "F1-GetBOOpts/output/maintenanceMap" as 'map_schema';
```

end-if;

Format an Input Map Title

NOTE: Throughout this topic the term "field" to refer to both the generic concept of displaying and capturing data in a 'field' as well as referring to the meta-data object supplied in the product to define [Fields](#). When referring to the latter, the term "MD Field" (meta-data Field) is used.

A uiHint element can be used to build a title for a maintenance map. The title will only print on the maintenance map, not on the display map. It will be printed as the first line in the map, centered, with a heading style.

Syntax	Description	Examples
<code><uiHint:title mdField=" "/></code>	Displays the label of a referenced MD field as the title.	<pre><schema xmlns:uiHint="http:// oracle.com/ouafUIHints"> <uiHint:title mdField="STATUS_RSN_LBL" /> ... </schema></pre>
<code><uiHint:title text=" "/></code>	Displays the indicated text as the title. (Do not use this mechanism when multiple languages are supported.)	<pre><schema xmlns:uiHint="http:// oracle.com/ouafUIHints"> <uiHint:title text="Status Reason" /> ... </schema></pre>

Create a Section

The uiHint namespace supports the definition of a UI map section. Note that sections are currently created in generated UI Maps when the schema has a group or list node with a label or mdField. The functionality described here enables the creation of a section without requiring a labeled group or list node within the schema. Every section must be bounded by **startSection** and **endSection** element pair.

Syntax	Supporting Attributes	Description
<code><uiHint:startSection .../></code>	<code>sectionColumn="left right fullWidth float"</code>	The default is that the section will be the full width in display maps. To override that setting, specify if you want a half-width section to appear in either the left (left) or right (right) column or to float (float). Sections that are marked as 'float' will display half-width and be aligned according to whether prior sections are displayed or conditionally hidden. For example, if a left-aligned section is followed by a floating section, the floating section will appear in the right column if the left section is populated but will display in the left column if the left section is hidden / collapsed.
	<code>editColumn="left right fullWidth float"</code>	By default a section appears as full width in maintenance maps. To override that setting, specify if you want a half-width section to appear in either the left (left) or right (right) column or to float (float). The behavior is the analogous to the sectionColumn behavior.

Syntax	Supporting Attributes	Description
	sectionOpen="false"	By default a section is open on initial display. Specify this attribute to initially display the section as closed (collapsed).
	mdField=" "	Specify the name of a MD field whose label should be used as the section heading.
	label=" "	Specify the explicit text to use as the section heading.
	visibleOn="displayMap inputMap"	By default a section appears on both the display and the input maps. Use this attribute to limit the display of the section to either the display map (displayMap) or input map (inputMap).

The syntax for the end section attribute is `<uiHint:endSection/>`

Examples:

```
<schema xmlns:uiHint="http://oracle.com/ouafUIHints">
  <uiHint:startSection label="Main" sectionColumn="left" />
  ...
  <uiHint:endSection/>
</schema>
```

```
<schema xmlns:uiHint="http://oracle.com/ouafUIHints">
  <uiHint:startSection mdField="F1-ADD-
INFO" sectionColumn="fullWidth" editColumn="float" sectionOpen="false" visibleOn="displayMap" />
  ...
  <uiHint:endSection/>
</schema>
```

NOTE: The sectionColumn, editColumn and sectionOpen attributes are available for group and list nodes as well.

Include a Map Fragment

You can specify a UI map fragment to inject HTML into a generated map using the **includeMap** element name. This allows for you to support more sophisticated behavior on your user interface. For any element that is included for rendering in the map fragment, be sure to suppress the element in its schema definition, otherwise HTML will automatically be generated for the element.

Syntax	Supporting Attributes	Description
<code><uiHint:includeMap .../></code>	map=" "	Specify the name of the map.
	visibleOn="displayMap inputMap"	By default the details from the map fragment appear on both the display and the input maps. Use this attribute to limit the display of the section.

Example:

```
<schema xmlns:uiHint="http://oracle.com/ouafUIHints">
  ...
  <uiHint:includeMap map="StandardActionButtons" visibleOn="displayMap" />
  ...
</schema>
```

NOTE: Important note on the map fragment schema: If a map fragment contains a schema, then the fragment schema structure will be injected into the dynamically generated schema when the business object is rendered for input.

Technically, the fragment schema will be inserted after the boGroup structure within the map's schema. This method may be used to support the implementation of maintenance pre and post script processing for a business object and oraInvokeBS function calls within embedded JavaScript.

If JavaScript is required within an XHTML UI Map fragment, it is necessary to bound it within a `![CDATA[]]` tag to ensure a valid XML document. Note that the tags themselves may need to be commented out to promote compatibility with older browsers. For example:

```
<script type="text/javascript">
/*  */
//
//javascript
//
/* ]&gt; */
&lt;/script&gt;</pre>
</div>
<div data-bbox="88 273 896 334" data-label="Text">
<p><b>Flush the cache:</b> For performance reasons, the Framework automatically caches business object schemas, data areas, and UI maps. When you update a business object, the cache is automatically flushed. However, if the business object includes either a data area or embedded UI map fragment, the cache must be manually flushed in order for your changes to be recognized. Refer to <a href="#">Server Cache</a> for more information.</p>
</div>
<div data-bbox="88 352 257 370" data-label="Section-Header">
<h2>Build A Dropdown</h2>
</div>
<div data-bbox="88 375 896 404" data-label="Text">
<p>Syntax is provided to build a dropdown list in an edit map. The dropdown may be built using data returned from a service script, a business service or a table.</p>
</div>
<div data-bbox="88 410 906 500" data-label="Table">
<table border="1">
<thead>
<tr>
<th>Syntax</th>
<th>Description</th>
</tr>
</thead>
<tbody>
<tr>
<td>uiHint:select="ss: "</td>
<td>Specify the name of the service script after the colon.</td>
</tr>
<tr>
<td>uiHint:select="bs: "</td>
<td>Specify the name of the business service after the colon.</td>
</tr>
<tr>
<td>uiHint:select="table: "</td>
<td>Specify the name of the table after the colon.</td>
</tr>
</tbody>
</table>
</div>
<div data-bbox="88 513 885 543" data-label="Text">
<p>When specifying a service script or a business service, extra mapping information is needed to pass data to and from the service.</p>
</div>
<div data-bbox="88 550 906 714" data-label="Table">
<table border="1">
<thead>
<tr>
<th>Syntax</th>
<th>Values</th>
<th>Description</th>
</tr>
</thead>
<tbody>
<tr>
<td rowspan="2">uiHint:selectIn=" "</td>
<td>serviceXPath:element</td>
<td>Used to pass the value of another element into the service (mapping to the service's XPath).</td>
</tr>
<tr>
<td>serviceXPath:'Literal'</td>
<td>Used to pass a constant or literal to the service (mapping to the service's XPath).</td>
</tr>
<tr>
<td>uiHint:selectOut="valuePath: ; descPath: "</td>
<td>See examples below.</td>
<td>Used to indicate which element in the service's output holds the values and which one holds the descriptions.</td>
</tr>
</tbody>
</table>
</div>
<div data-bbox="88 729 163 745" data-label="Text">
<p>Examples:</p>
</div>
<div data-bbox="88 751 870 888" data-label="Text">
<pre>&lt;schema xmlns:uiHint="http://oracle.com/ouafUIHints"&gt;
  &lt;boStatus mapField="BO_STATUS_CD" uiHint:select="bs:F1-BOStateReasonList"
    uiHint:selectIn="boStatusBO:boStatusBO" uiHint:selectOut="valuePath:results/status;
    descPath:results/description"/&gt;
  ...
  &lt;algorithm mdField="ALG_CD" uiHint:select="bs:F1-RetrieveSysEvtAlgorithms"
    uiHint:selectIn="algorithmEntity:'F1AA';" uiHint:selectOut="valuePath:results/algorithm;
    descPath:results/description"/&gt;
  ...
  &lt;outboundMsgType mdField="OUTMSG_TYPE_CD" required="true" fkRef="F1-
  OMTYP" uiHint:select="table:F1_OUTMSG_TYPE"/&gt;
&lt;/schema&gt;</pre>
</div>
<div data-bbox="467 942 913 959" data-label="Page-Footer">
<p>Oracle Utilities Customer to Meter Administrative User Guide • 359</p>
</div>
```

Conditionally Hide Elements

The **displayNone** attribute is used to suppress elements on the map based on conditions.

Syntax	Values	Description
uiHint:displayNone=	"XPath','value','!=' '='"	Used to conditionally hide this element based on the value of another element (referenced using its XPath). Enter a value of '' to interrogate a blank value. By default the operator is '='. This may be overridden using '!='.
	"function name, true false "	Used to indicate a JavaScript function, which must return a Boolean.

WARNING:

Embedded spaces are not supported within the comma separated string values of this attribute.

This setting may be used on group nodes, list nodes, and elements - except for elements within a list. Elements within a list cannot be hidden conditionally.

The following example illustrates that two elements (currency reference and lookup) that will be hidden or displayed based on the value of the data type element. Note that this example also illustrates [Trigger Dependent Behavior](#) because the data type element's value may change and if it does, the condition for hiding the subsequent elements should be re-evaluated.

```
<schema xmlns:uiHint="http://oracle.com/ouafUIHints">
  ...
  <dataType mdField="F1_SE_DATA_TYPE" dataType="lookup" lookup="F1_SE_DATA_TYPE"
    uiHint:dependents="currencyRef;lookup; "/>
    <currencyRef mdField="F1_SE_CURR_REF_LBL" uiHint:displayNone='dataType','F1MO','!=' />
    <lookup mdField="F1_SE_LOOKUP_LBL" fkRef="F1-LKUPF" uiHint:displayNone='dataType','F1LP','!'
      =' '/>
  ...
</schema>
```

The following example illustrates referring to a function where the function receives parameters:

```
<uiHint:startSection mdField="F1_SE_DEFAULT_SECT"
  uiHint:displayNone="isApplicableForSchemaType(item,'F1MP'),true"/>
```

Conditionally Protect Elements

The **protect** attribute is used to protect elements on the map based on other factors.

Syntax	Values	Description
uiHint:protect=	"XPath','value','!=' '='"	Used to conditionally protect this element based on the value of another element (referenced using its XPath). Enter a value of '' to interrogate a blank value. By default the operator is '='. This may be overridden using '!='.
	"function name, true false "	Used to indicate a JavaScript function, which must return a Boolean.
	" action ','A' 'C','!=' '='"	Use the ' action ' setting to protect the element based on the current action. For example, certain elements may only be specified when adding a record. Any subsequent changes to

Syntax	Values	Description
		the record should protect the element from being changed. When using this option, the valid values for the 'value' are A (add) and C (change).

WARNING:

Embedded spaces are not supported within the comma separated string values of this attribute.

The protect UI Hint may be used on group nodes, list nodes, and elements - except for elements within a list. Elements within a list cannot be protected conditionally.

The following UI Hint will protect the statistics category when the action is 'C'.

```
<schema xmlns:uiHint="http://oracle.com/ouafUIHints">
...
<statisticsCategory dataType="lookup" mapField="STAT_CATEGORY_FLG"
  lookup="STAT_CATEGORY_FLG" uiHint:protect="'action','C','='"/>
...
</schema>
```

Trigger Dependent Behavior

The dependents attribute is used to trigger behavior on a child element when a parent element is changed.

Syntax	Values
uiHint:dependents=" "	A list of one or more dependent elements separated by semicolons.

The following example illustrates that the dropdown list of one element is driven by the value of another element. In this example, when the Country changes, the list of States to choose from should change to only show the states for the indicated country.

```
<schema xmlns:uiHint="http://oracle.com/ouafUIHints">
<country label="Country" uiHint:select="table:CI_COUNTRY" uiHint:dependents="state" />
<state label="State" uiHint:select="ss:CM-RetrieveCountryStates"
  uiHint:selectIn="input/country:country;" uiHint:selectOut="valuePath:output/state/stateCode;
  descPath:output/state/stateDesc" />
...
</schema>
```

NOTE:

Dependent targets may only name elements, not group or list nodes.

Do not modify the "id" attribute value of dependent and parent element. Data population in dependent is done based on the "id" attribute value.

Control Rendering Target

By default all elements that are not suppressed are visible on both the display map and the input map. Use the **visibleOn** attribute to limit the inclusion of an element to either the display or input map.

Syntax	Values
uiHint:visibleOn=	"displayMap"
	"inputMap"

```
<schema xmlns:uiHint="http://oracle.com/ouafUIHints">
...
```

```
<uiHint:includeMap map="StandardActionButtons" visibleOn="displayMap"
...
</schema>
```

Generate a Text Area

By default, a standard text box is rendered in an input map for any string element. If the field is larger and you wish to have a bigger text area (with a scroll bar), use the **textArea** attribute.

Syntax

uiHint:textArea="true"

```
<schema xmlns:uiHint="http://oracle.com/ouafUIHints">
...
<message label="Message" uiHint:textArea="true"/>
...
</schema>
```

Modify FK Reference Defaults

By default, when an element with **fkRef** is displayed, an info string, context menu, navigation, and search are enabled (if the FK reference has been configured accordingly). Syntax is provided to allow you to selectively turn off any of these features.

Syntax

uiHint:fkRef="info:false;context:false;navigation:false;search:false;"

Only the feature that you wish to turn off needs to be specified. The following example illustrates turning off the navigation capability, meaning the text will not be rendered as hypertext.

```
<schema xmlns:uiHint="http://oracle.com/ouafUIHints">
...
<attachmentID fkRef="F1-
ATTCH" primeKey="true" suppress="input" uiHint:fkRef="navigation:false;"/>
...
</schema>
```

FASTPATH: Refer to [FK Reference Formatting](#) in the UI Map Attributes section for more information on each FK reference setting.

Suppress Automatic Number Formatting

By default numeric fields (**dataType="number"**) are formatted as numbers. An attribute is provided to instead apply alphanumeric formatting.

Note: If **dataType** is not specified explicitly, it is derived from **mdField** or **mapField**.

Syntax

uiHint:alphaFormat="true|false"

By default, its value is **false** (and therefore can be left out altogether).

Examples:

```
<schema xmlns:uiHint="http://oracle.com/ouafUIHints">
...
<numberCount mdField="" dataType="number" uiHint:alphaFormat="true"/>
...
</schema>
```

Auto Capitalize the Input Data

The `uiHint` provides syntax to automatically capitalize input data.

Syntax

`uiHint:capitalize="true|false"`

By default, its value is **false** (and therefore can be left out altogether).

```
<schema xmlns:uiHint="http://oracle.com/ouafUIHints">
  <toDoTypeCd mdField="TD_TYPE_CD" uiHint:capitalize='true' isPrimeKey="true"/>
</schema>
```

NOTE: This attribute is ignored if `uiHint:textArea="true"` is configured.

The attribute is only available in the schema designer when the `isPrimeKey` is set to **true**. The attribute may be added to any string element when using the source viewer.

Schema Designer

The Schema Designer is a user-friendly interface for performing the following common schema editing tasks:



- Displaying existing schemas.
- Creating schema elements.
- Moving elements within a schema.
- Adding attribute values.

The designer provides two view modes:

- **Text** mode shows the schema elements and their attributes written in the proper syntax and allows for direct text entry.
- **Tree** mode is a view showing the elements in a tree format with many of the key attributes of each element in tabular form. While in this mode, the **Node Display** controls allow the user to choose between displaying the elements by their internal identifiers or their associated screen labels while viewing or editing the schema.

NOTE: Schemas that are not owned by the current installation owner are protected in both view modes.

The following sections provide more information about functionality available in the Tree mode.

- If the schema definition refers to another schema using an 'include' statement, a triangle is visible to the left of the tree area. One can expand that schema by clicking the triangle.
- Detailed information about an element's definition can be displayed and if applicable, updated from the **Tree** view by clicking the edit icon for that element, which appears on the right.  Note that the element attributes are only editable if the element is defined in this schema. When viewing the attributes of an element that is part of an 'include' of another schema, the attributes are display only.
- Context-sensitive embedded help is provided for fields and controls in the edit pane by clicking the Help icon 
- There is a menu dropdown icon visible to the left of the tree for any element that is defined in the current schema being viewed. It is not visible for elements included from another schema. New elements may be added in the **Tree** mode.

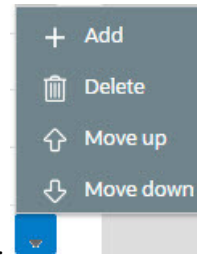

Clicking that dropdown displays options to Add, Delete or Move an element. Note that not all options are visible, based on what is allowed for the element adjacent to the menu. For example, on the main "schema" node, only the Add option is visible as deleting or moving the "schema" node is not applicable.

When adding a new element, you are prompted first for the element position, which is either a sibling node to the current element or a child node of that element. For either option, the new element is added below the one adjacent to where the menu is clicked. You are then prompted for the element type.

The following lists the possible element types. Most are self explanatory and represent standard schema options.

- **Characteristic List.** This is a special type of Flattened List element that is used to map list elements that include a sequence and a characteristic value for a given characteristic type. This element is only applicable for maintenance objects that have one or more characteristic child tables where the primary key is the maintenance object's key, characteristic type and sequence. Effective dated characteristic collections are not supported. The user defines the list name, the characteristic value element name and the characteristic type. The system will configure the remaining flattening information accordingly.
- **Characteristic.** This is a special type of Flattened Field element that is used to map a single element to the characteristic for a given characteristic type. This element is only applicable for maintenance objects that have one or more characteristic child tables where the primary key is the maintenance object's key, characteristic type and sequence. Effective dated characteristic collections are not supported. The user defines the element name and the characteristic type. The system will configure the remaining flattening information accordingly.
- **Comment.** This adds a comment to the schema.
- **Embedded HTML.** This is specific to a schema enabled for UI Hints. It is used to include a UI map fragment.
- **Field**
- **Flattened Field**
- **Flattened List**
- **Group**
- **Include BO Schema**
- **Include BS Schema**
- **Include DA Schema**
- **Include Map Schema**
- **Include SS Schema**
- **Input Map Title.** This is specific to a schema enabled for UI Hints. It is used to define a title element for the map.
- **List**
- **Nested Flattened Field.** This is a flattened field from a child table.
- **Raw Element.** This element is used to capture text as is. It is typically used to capture an XML structure without any details of the definition of the individual nodes.
- **Section.** This is specific to a schema enabled for UI Hints. It is used to define a section within the map.
- **Simple Field.** This is a special type of Field element that is used to define an element that is mapped to a column that supports data defined in an XML structure. (This is either a column with the character large object data type (CLOB) or the XML data type).

The **Schema Designer** is available by choosing the **Schema** tab on the [Business Object](#), [Data Area](#), [UI Map](#), [Business Service](#), and [Script](#) pages.

Schema Viewer

The schema viewer shows a tree-view presentation of a schema in its expanded form.

The schema illustrates the structure to be used when communicating with the schema's associated object. The following takes place when a schema is expanded:

- If the schema definition includes references to other schemas, these references are replaced with the corresponding schema definitions.
- Also, if the schema definition contains **private** elements, they are omitted from this view.

Clicking on any node on the tree populates the text box on the top with the node's absolute XPath expression. You will find this feature very useful when writing scripts interacting with schema-based objects. [Scripting](#) often involves referencing elements in a schema-based XML document using their absolute XPath expression. You can use this feature on the schema viewer to obtain the XPath expression for an element and copy it over to your script.

Business Event Log

Business Event Log may be viewed as a tool designed to capture any type of business event worth noting. You configure business objects to represent the various types of events your application calls for. The following type of details may be captured for each event:

- The business object representing the type of event.
- The date and time the event took place and who initiated it.
- The business entity for which this event is logged.
- Standard application message to describe the event.
- Additional context information that is available at the time of the event and varies for each type of event. The Business Event Log maintenance object supports a standard characteristics collection as well as an XML storage (CLOB) field. The event's business object determines where each piece of information resides. Refer to [Business Objects](#) for more information.

One common type of event may be the audit of changes made to sensitive data, for example, tracking an address change. Whenever an entity associated with a business object is added, changed, or deleted the system summarizes the list of changes that took place in that transaction and hands them over to **Audit** business object algorithms to process. You may design such an algorithm to audit the changes as business event logs. Refer to [a business object may define business rules](#) for more information.

You can also allow users to initiate business event logs to capture important notes about a business entity by exposing a [BPA Script](#) to invoke the event's corresponding business object.

Bottom line is that any process can create a business event log by invoking the business object representing the appropriate type of event.

Miscellaneous Topics

The following sections describe miscellaneous system wide topics.

Javadocs Viewer

The system provides a Javadocs viewer and a Groovy Javadocs viewer, which are interactive tools that allows you to browse Java documentation files (Javadocs) for Java classes that execute on the application server. For information about how to use Javadocs and navigate within the viewer, refer to Javadocs help.

Javadocs

To launch the Javadocs viewer, open open **Admin > Implementation Tools > Javadocs**.

NOTE: Proprietary Java Classes. A small number of Java classes have been suppressed due to their proprietary nature.

Additionally, when viewing a record that references a Java program in the [algorithm type](#) page, the [batch control](#) page or the [FK reference](#) page, an icon adjacent to Java program allows you to view the Javadocs for that program.

Groovy Javadocs

The Groovy Javadocs viewer includes the Java classes that are accessible to Groovy code within scripts. Launch this viewer using the 'View Groovy Javadocs' link in the Script Tips zone on the [script](#) page.

Module Configuration

The system provides the ability to simplify the user interface based on functionality areas practiced by your organization.

Menu items and other user interface elements are associated with function modules. By default, all function modules are accessible. If a function module is not applicable to your business you may turn it off. Refer to [Turn Off A Function Module](#) for more information on how to turn off a module.

If a function module is made non-accessible, i.e. turned off, its related elements are suppressed from the user interface. In addition the system may validate that related functionality is not accessed. This also means that turning off the wrong module may cause any of the following to occur:

- Menu items may not appear. Refer to [Menu Item Suppression](#) to better understand how menu item suppression works.
- Entire menus may not appear. Refer to [Menu Suppression](#) to better understand how menu suppression works.
- Tabs on pages may not appear.
- Fields may not appear.
- The system may return an error message when you attempt to use a function (indicating the function is turned off).

To correct the above situation, simply remove the module from the turned off list thus making it accessible again.

Your module configuration setup is displayed on the [installations](#) record.

Menu Item Suppression

The following points describe how your module configuration can suppress [menu items](#).

- Menu items that are owned by the base product (as opposed to those your implementation adds) are associated with one or more function modules. If your module configuration has turned off all of the menu item's modules, the menu item is suppressed. If at least one of the modules is accessible, i.e. turned on, the menu item is not suppressed.
- If a menu line doesn't contain any accessible items, the menu line is suppressed.

- If all lines on the [Admin menu](#) are suppressed, the menu itself is suppressed in the application toolbar. This is not expected to ever occur for the Main menu as the user preferences is on that menu and the expectation is that all users have access to their preferences.
- Menu items that are suppressed are not visible in the [Menu Item Search](#) results.

Menu Suppression

In addition to the above Menu Item Suppression logic, the following points describe how your module configuration can suppress an entire menu.

- Menus that are owned by the base product (as opposed to those your implementation adds) are associated with one or more function modules.
- If your module configuration has turned off all of the menu's modules, the entire menu is suppressed. If at least one of the modules is accessible, i.e. turned on, the menu is not suppressed.

Turn Off A Function Module

The base package is provided with a **Module Configuration** [Feature Configuration](#) that allows your organization to turn off base package function modules.

To turn off any of the base package function modules add a **Turned Off** option to this feature configuration referencing that module. Refer to the **MODULE_FLG** lookup field for the complete list of the application's function modules.

Any module not referenced on this feature configuration is considered turned on, i.e. accessible. To turn on a module, simply remove its corresponding **Turned Off** option from this feature configuration.

You may view your module configuration setup on the [installation options](#) page.

NOTE: Only one. The system expects only one **Module Configuration** feature configuration to be defined.

Global Context Overview

The framework web application provides each product the ability to nominate certain fields to act as a "global context" within the web application. For example, in Oracle Utilities Customer Care and Billing, the global context fields include Account ID, Person ID and Premise ID. The values of these fields may be populated as a result of searching or displaying objects that use these fields in their keys. If you navigate to the Bill page and display a bill, the global context is refreshed with the Account ID associated with that bill. The global context for Person ID and Premise ID are refreshed with data associated with that account.

The fields designated as global context for the product are defined using the lookup **F1_UI_CTXT_FLDS_FLG**.

Changing the values of the global context typically cause data displayed in zones on the dashboard to be refreshed to show information relevant to the current values of these global context fields.

When the value of one of the global context fields changes, an algorithm plugged into the [installation record](#) is responsible for populating the remaining global context values accordingly. Refer to your specific product for more information about the base algorithm that is provided for that product.

System Data Naming Convention

There are several maintenance objects in the system that include owner flag in one or more of its tables. We refer to the data in these tables as "system data". Some examples of system data tables include Algorithm Type, Batch Control, Business Object and Script. Implementations may introduce records to the same tables. The owner flag for records created by an implementation is set to **CM** (for customer modification), however the owner flag is not part of the primary key for any

of the system data tables. As a result, the base product provides the following guidelines for defining the primary key in system data tables to avoid any naming conflict.

Base Product System Data

For any table that includes the owner flag, the base product will follow a naming convention for any new data that is owned by the base product. The primary key for records introduced by the product is prefixed with **xn-** where **xn** is the value of the owner flag. For example, if a new background process is introduced to the framework product, the batch code name is prefixed with **F1-**.

NOTE: There are some cases where the hyphen is not included. For example, portal codes omit the hyphen.

For most system data, the remainder of the primary key is all in capital case. An exception is schema oriented records. For business objects, business services, scripts, data areas and UI maps, the product follows the general rule of using CapitalCase after the product owner prefix. For example, **F1-AddToDoEntry** is the name of a base product business service.

NOTE: Data Explorer Business Services. For business services used to invoke a data explorer zone, it is recommended to name the Business Service the same name as the related zone rather than defining a different CapitalCase name for the business service.

Please note that this standard is followed for all new records introduced by the base product. However, there are base product entries in many of these system data tables that were introduced before the naming convention was adopted. That data does not follow the naming convention described above.

NOTE: Schema naming conventions. A context sensitive "Schema Tips" zone is associated with any page where a schema may be defined. The zone provides recommended naming conventions for elements within a schema along with a complete list of the XML nodes and attributes available to you when you construct a schema.

Implementation System Data

When new system data is introduced for your implementation you must consider the naming convention for the primary key. The product recommends prefixing records with **CM**, which is the value of the owner flag in your environment. This is consistent with the base product naming convention. This convention allows your implementation to use the CM packaging tool in the Software Development Kit as delivered. The extract file provided with the tool selects system data records with an owner flag of **CM** and with a **CM** prefix.

NOTE: If you choose not to follow the CM naming convention for your records and you want to use the CM packaging tool, your implementation must customize the extract file to define the appropriate selection criteria for the records to be included in the package. Refer to the Software Development Kit documentation for more information.

Also note that owner flag may be introduced to an existing table in a new release. When this happens, the CM packaging tool is also updated to include these new system data tables. Your implementation will have existing records in those tables that probably do not follow any naming convention. After an upgrade to such a release, if you want to include this data in the CM packaging tool, you must customize the extract file for the tables in question.

Accessibility Considerations

This section provides information about topics related to accessibility that should be considered when extending the system via configuration tools.

Color Contrast

The HTML color **red** (RGB code #FF0000) when used for text on a white background does not comply with the accessibility color contrast guidelines. When it is desired to use red for text for emphasis in a zone, map or in a text string, the product recommends the shade of red with the RGB code #E0292F.

Note that in addition, the product provides a special CSS class **textColorRedOnWhite** which may be used when HTML references are used for applying the red color. For example, UI map, zone help text and scripting.

Referencing URIs

There are some configuration objects that require a reference to a URI, including file path URIs. The following sections highlight some functionality supported by the product with respect to defining / accessing URIs.

NOTE: In order for the functionality described below to occur, specific APIs must be used by the underlying code related to the fields that capture or process the file path or URL information. If you find that there is a URI-related field that does not provide the functionality described here, please contact customer support.

NOTE: For schema elements in a business object that reference a [Field](#) with the **URI** data type or define the element with the **URI** data type configured in the [schema](#) will automatically use the appropriate API that validates the value that may reference a substitution variable or must be checked against the allowlist if applicable.

Validation Against an Allowlist

Based on a property setting, your implementation may be configured to define a allowlist of URIs. If this setting is enabled, the system will issue an error if the URI is not defined in the allowlist. Consult your system administrator to verify if this setting is enabled or not for your implementation.

FASTPATH: Refer to [URI Substitution](#) for information about how defining substitution tokens for URIs using the properties file technique automatically adds the defined URI to the allowlist.

URI Substitution

The system supports the ability to define substitution variables (sometimes referred to as tokens) for both URL values and file path values that reference native file storage locations. For URLs, the system supports defining variables in a Substitution Variable properties file. For native file storage paths, there are two options: the Substitution Variable properties file or via a File Storage configuration extendable lookup. More details on both these options are found below.

- Substitution variables properties file. A substitution variable for all or part of the URI definition may be configured in a properties file. This allows the system administrators to define the proper URI locations in a properties file whereas the configuration users only need to know the variable name. For example, when defining a location for an extract file in an extract batch job, instead of typing a file path of **h:\oracle\serverName\1.0.0\batch\extract**, the batch user can enter **@FILE_EXTRACT@**, assuming there is an entry in the substitution variables file with a name of **FILE_EXTRACT**, and a value of **h:\oracle\serverName\1.0.0\batch\extract**. Another example is that the batch user could enter **@BATCH_FILES@\extract**, assuming that the URI variable for **BATCH_FILES** is defined as **h:\oracle\serverName\1.0.0\batch**.

NOTE: The product automatically populates the value of **SPLOUTPUT** in the properties file so that this may be used in URI configuration. In addition, the product may supply some pre-defined variable names for other common references. As part of this, the 'advanced' menu in the system installation steps may prompt for installers to define the

values of these pre-defined variables, if desired. Installations may opt to define additional substitution variables for various URI references. Refer to the *System Administration Guide* for more information.

- File Storage extendable lookup. Specifically for file paths that reference the native file system, the system also supports the ability to define a path using the **File Storage Configuration** extendable lookup. The following points highlight the steps to take for this option.
 - Navigate to [Extendable Lookup](#) and search for the **File Storage Configuration** lookup.
 - Click **Add** to create a new entry. Define a lookup value name. This will be used when configuring a file path that uses this value. Choose the File Adapter value of **Native File Storage**. Enter the desired file path value. The values defined here may in turn refer to values defined in the Substitution Variables properties file. For example, the file path can reference @SPLOUTPUT@.
 - To reference this value in system configuration, use the syntax **file-storage://XXXX**, where XXXX is the extendable lookup value. Using the same example from above, if you define an extendable lookup value of CM-FileExtract with a file path of **h:\oracle\serverName\1.0.0.0\batch\extract**, then when configuring the extract file path for an extract batch job, enter **file-storage://CM-FileExtract**. Another example is that if the extendable lookup value's file path is configured as **h:\oracle\serverName\1.0.0.0\batch**, then the user configuring the file path on the batch extract can enter **file-storage://CM-FileExtract/extract**

When should you define substitution variables in the properties file and when you define them in the extendable lookup? The following points highlight differences between the options that may help this decision.

- Substitution variables for URLs are only supported via the properties file.
- The properties file can typically only be modified by a system administrator. If there are values that are set at installation time and don't change, then defining the values in the properties file may be beneficial.
- When defining additional environments, such as test environments or production, the values in the extendable lookup may be copied using CMA. Ideally the values are defined such that they are the same between various regions.

External File Storage

The system supports using Oracle Cloud Object Storage for managing files in cloud implementations and can be configured to read files from or write files to this external location. Refer to Oracle Cloud Object Storage documentation for more information about obtaining an account and defining appropriate file locations or "buckets".

Once your cloud storage information is defined, the following points highlight the configuration steps required in the application.

- Define a [signature key ring](#). When the system tries to communicate with cloud object storage, it must provide a signature key so that cloud storage can confirm that the request is from a trusted source.
 - Navigate to [Key Ring](#) in add mode and select the **RSA Signature Key Pair** business object.
 - Define a key ring code, which will be used in the File Storage configuration (below) along with a description.
 - Once the key ring is added, click **Generate Key** to generate a private / public key pair.
 - Click View Public Key to launch a pop-up that displays the public key, allowing the user to copy the key.
- At this point, the user should navigate to cloud object storage and register the public key. Once this is done, the key ring is now ready to be configured in file storage configuration.
- Use a File Storage extendable lookup to define the location and connection information so that you may reference this location in system configuration. The following points highlight the steps to take for this option.
 - Navigate to [Extendable Lookup](#) and search for the **File Storage Configuration** lookup.
 - Click **Add** to create a new entry. Define a lookup value name. Note that the lookup value should not have a slash or backslash in its name. This will be used when configuring a file path that uses this value. Choose the File Adapter

value of **Oracle Cloud Object Storage**. Provide the following information that identifies the cloud storage options: User, Tenancy, Compartment, Namespace and Region. For the Key Ring, choose the value defined above.

- To reference this value in system configuration, use the syntax **file-storage://XXXX/...**, where XXXX is the extendable lookup value and any additional path information that is appropriate. For example, if you define an extendable lookup value of **CM-CloudStorage** and you have a bucket defined in Cloud Storage for processUpload, when configuring the file path for the upload batch job, enter **file-storage://CM-CloudStorage/processUpload**.
- The product supports referencing virtual folders for a bucket. Simply add the virtual folder name(s) after the bucket name. For example, if there is a bucket called 'financials' and a virtual folder for 'paymentUpload', the file path may have this value: **file-storage://CM-CloudStorage/financials/paymentUpload**. For extract processes, if the file path references a virtual folder that does not exist for the referenced bucket, the virtual folder is created as part of the extract process.
- You may optionally use a Bucket Name Prefix on the file storage configuration to support defining different Bucket Names for different environments. For example, imagine you want to have a separate "processUpload" bucket for a development region, a test region and a production region. In the Cloud Storage configuration you can define separate buckets for "DEV_processUpload", "TEST_processUpload" and "PROD_processUpload". If you needed to define the full bucket on each file path reference on various batch jobs, migrating the batch job configuration from one environment to another would require a manual step to change all the bucket references. Instead, the system supports defining a Bucket Name Prefix, which if populated will be prepended to bucket reference before connecting to Cloud Storage. This means that the prefix is defined once and all the references throughout the system can keep the common part of the Bucket name (such as "processUpload"). Then only the File Storage configuration needs to differ between the different regions.
- If your implementation integrates with an external reporting tool that can write the report output to specific delivery channels (buckets) check the Reporting Configuration switch. Define one or more Bucket Names for the buckets that the reporting tool may use for delivery channel options.

NOTE: Refer to the [Key Ring](#) documentation for information about practicing key rotation.

Caching Overview

A great deal of information in the system changes infrequently. In order to avoid accessing the database every time this type of information is required by an end-user or a batch process, the system maintains a cache of static information on the web server and in the batch thread pool worker. These are referred to as the "application caches". Some examples of application caches include

- System messages
- Field label and other field information
- Security Information

The framework product provides many specific caches for commonly used (and infrequently changed) data. In addition, specific edge applications may introduce additional caches as appropriate.

Information may also be cached on each user's browser.

The following topics highlight information about refreshing the various caches.

Server Cache

The server cache refers to data that is cached on the web server. An important use of this cache is for users' online access to the application. The caches aid in better performance while navigating throughout the system, allowing for data to be accessed from the cache rather than by always accessing the database. Besides user access to the web server cache, other functionality deployed to the web server uses caches in a similar way. For example, web services are deployed to the web server and access their own version of the cache.

The contents of the cache are cleared whenever the web server is restarted. This means that fresh values are retrieved from the database once users and web services start using the application again.

The product also supplies a flush command that one can issue in the browser's URL to immediately clear the contents of the cache. The command **flushAll.jsp** flushes every cache.

For example, assume the following:

- the web server and port on which you work is called **OU-Production:7500**
- you add a new record to a control table and you want it to be available on the appropriate transactions immediately

You would issue the following command in your browser's address bar: **http://OU-Production:7500/flushAll.jsp**. Notice that the command replaces the typical `cis.jsp` that appears after the port number.

If your system has been configured correctly, the **flushAll** command will submit a request to do a "global" flush of caches (including the web services cache and the thread pool worker cache). This functionality uses a JMS Topic to publish the flush request. Refer to the *Server Administration Guide* for details on how to configure the JMS topic.

Also note that the system provides a business service **F1-FlushAllService**, which is equivalent to the `flushAll` command (except that it does not restart your browser session). This may be useful for any processes that are built to orchestrate updates to configuration data where you want to ensure that the cache is immediately flushed. This business service is also exposed as a REST web service.

Batch Cache

When submitting a batch job, the batch component uses a Hibernate data cache to cache administrative data that doesn't change very often. The tables whose records are included in this cache are configured using the Caching Regime value of **Cached for Batch**. This is often referred to as the "L2 cache". Refer to [Tables](#) for more information. When starting a thread pool worker, data in tables marked as cached is loaded and cached for as long as that thread pool is running.

In addition batch jobs may also access application caches when applicable. When starting a thread pool worker, application data that is cached is loaded and cached for as long as that thread pool is running.

If there are any batch jobs that update any tables that are marked as **Cached for Batch**, you must run that batch job using a special thread pool that is configured with the caching disabled. Contact your system administrator to confirm the thread pool that is configured this way.

If there is a change in cached data that should be available for the next batch job, the following points highlight how the cache can be refreshed:

- By default the system is configured to automatically refresh the Hibernate cache every 60 seconds. However, an implementation may override the configuration to either change the number of seconds between intervals or to disable the automatic caching altogether. Application caches used by the batch jobs are not impacted by this refresh.
- Restart the thread pool workers.
- Run the **F1-FLUSH** (Flush all Caches) background process. This background process will flush the application data cached for all thread pool workers for all thread pools.
- If your the region has configured the thread pool workers to "listen" to requests for global flush as described in the [Server Cache](#) section, the thread pool worker caches are also refreshed when a **flushAll** command is issued.

Client Cache

In addition to the web server's cache, information is also cached on each user's browser. After clearing the cache that's maintained on the web server, you must also clear the cache that's maintained on your client's browser. To do this, follow the following steps (note that depending on the browser you use, the steps may vary slightly):

- Select **Tools** on your browser's menu bar
- Select **Internet Options...** on the menu that appears.
- Click the **Delete Files** button on the pop-up that appears.

- Turn on **Delete all offline content** on the subsequent pop-up that appears and then click **OK**.
- And then enter the standard URL to re-invoke the system.

NOTE: Automatic refresh of the browser's cache. Each user's cache is automatically refreshed based on the **maxAge** parameter defined in the web.xml document on your web server. We recommend that you set this parameter to **1** second on development / test environments and **28800** seconds (8 hours) on production environments. Please speak to system support if you need to change this value.

Expression Parser

The product provides support for defining expressions that may be of a mathematical or logical/boolean nature. The expression may include variables and functions.

The data explorer [column parameter](#) is an example of where this may be used. That parameter supports the definition of a formula. Edge applications may include support for a formula or expression using this parser as well. For example, several applications include a type of 'rule' object (calculation rule, form rule or usage rule) that is used for validation or calculation that may support applying a formula.

The following tables highlight what is supported in the expressions that use this parser.

Category	Supported in Expression	Description
Data types	Number	
	String	
	Boolean	
	List	
Literals	Numbers	
	Strings surrounded with either single quote or double quote.	
	NOTE: 'Escaping' special characters is not currently supported.	
	Boolean values: true and false .	
Operations	+	Plus
	—	Minus
	/	Division
	*	Multiplication
	^ or **	Power
	%	Modulus
Logical operations	=	Equal
	>	Greater than
	>=	Greater than or equal to
	<	Less than
	<=	Less than or equal to
	!= or <>	Not equal to

This table identifies the functions that are supported. Note that several of the functions are applicable to a list of values. Note that although the functions are listed in lower case, the column parameter syntax in data explorer indicates referencing the functions as all capital letters. The system converts the data explorer column formula to lowercase before being evaluated.

Function	Parameter	Results	Comments
size()	List element	Number of elements in the list.	
isEmpty()	List element	Returns true if the list is empty.	

Function	Parameter	Results	Comments
sum()	List element of type 'number'	Returns the sum of the numbers in the list.	
avg()	List element of type 'number'	Returns the average of the numbers in the list.	
	One or more numbers separated by commas	Returns the average of the number arguments.	
max()	List element	Returns the largest value in the list.	
	One or more comparable elements.	Returns the largest value of the number arguments.	
min()	List element	Returns the smallest value in the list.	
	One or more comparable elements.	Returns the smallest value of the number arguments.	
abs()	Number	Returns the absolute value.	
ceiling()	Number	Rounds the number to the ceiling.	
exp10()	Number	Raises 10 to the number power.	
acos()	Number	Returns the arc cosine of the number in radians.	The result will lose precision, as it uses double float based functions.
asin()	Number	Returns the arc sine of the number radians.	The result will lose precision, as it uses double float based functions.
atan()	Number	Returns the arc tangent of the number radians.	The result will lose precision, as it uses double float based functions.
cos()	Radian	Returns the cosine of the radian angle input.	The result will lose precision, as it uses double float based functions.
exp()	Number	Raises e to the number power.	The result will lose precision, as it uses double float based functions.
log10()	Number	Takes the log, base 10, of the number.	The result will lose precision, as it uses double float based functions.
log()	Number	Takes the natural log (base e) of the number.	The result will lose precision, as it uses double float based functions.
sin()	Radian	Returns the sine of the radian angle input.	The result will lose precision, as it uses double float based functions.
sqrt()	Number	Returns the square root of the number.	The result will lose precision, as it uses double float based functions.
tan()	Radian	Returns the tangent of the radian angle input.	The result will lose precision, as it uses double float based functions.
floor()	Number	Rounds the number to the floor.	
round()	Number	Assumes a scale of 0. The default rounding mode of "round half up" is applied.	
	Number, Scale	The default rounding mode of "round half up" is applied.	
	Number, Scale, Mode	The mode must be set to one of the following: <ul style="list-style-type: none"> • "ROUND_CEILING" • "ROUND_DOWN" • "ROUND_FLOOR" • "ROUND_HALF_DOWN" • "ROUND_HALF_UP" • "ROUND_HALF_EVEN" • "ROUND_UP" • "ROUND_UNNECESSARY" 	
negate()	Number	Returns the negative value of the number.	Only available in data explorer.

The following are special functions supported in the application for a list of values. In each case, the syntax is *function* [*indexVariable* in *listName* | *expression using indexVariable*], where the *indexVariable* is chosen by the formula writer to represent each entry in the list and the expression used to evaluate each entry must reference that variable.

NOTE: The syntax supported for a given use of the formula in a functional area is driven by that particular functional area. For example, in Oracle Public Sector Revenue Management, a formula is supported in the “conditional element validation” form rule. In that form rule all variables including lists are declared in the form rule using letters and the formulas in turn use these letters. In that scenario, the functions below would reference the declared variable letter as the “listName”. Other specific functional area that use this expression parser may support different syntax for referencing elements or lists.

Function	Description	Examples
any []	This function returns the value true if any of the entries in list satisfies the expression.	The following returns true if any entry in the Balance list is greater than 0. <code>any [i in list/Balance i > 0]</code>
all []	This function returns the value true if all of the entries in the list satisfy the expression.	The following returns true if all phone numbers are populated. <code>all [i in list/phoneNumber i != ' ']</code>
collect []	This function returns a new list of elements from the referenced list where the value of each entry of the new list is the result of the expression applied to each original value.	The following returns a new list with the tax rate applied to each amount. <code>collect [i in list/amount i * taxRate]</code>
select []	This function returns a list of all the values of the original list that satisfy the Boolean expression.	The following returns a new list with only the amounts that are negative numbers. <code>select [i in list/amount i < 0]</code>
reject []	This function returns a list of all the values of the original list that do not satisfy the Boolean expression.	The following returns a new list with only the amounts that are not negative numbers. <code>reject [i in list/amount i < 0]</code>

Debug Mode

Your implementation team can execute the system using a special mode when they are configuring the application. To enable this mode, enter **?debug=true** at the end of the URL that you use to access the application. For example, if the standard URL was **http://CD-Production:7500/cis.jsp**, you'd enter **http://CD-Production:7500/cis.jsp?debug=true** to enable configuration mode.

In addition, if you have security access to the application service **F1OUIDBUG**, you can enable this mode without changing the URL via the [Help Menu](#) - Enable Debug option. If debug mode is enabled, the help menu entry shows a Disable Debug option, allowing you to turn it off without changing the URL.

When in this mode certain debugging oriented tools become available via an icon visible.  Clicking the icon displays a slide-out panel with options defined below.

The following are only applicable in a non-Cloud environment:

- **Start Debug** starts a logging session. During this session the processing of various configuration tools objects are logged. For example, the log will show the data areas that are passed in at each step and the data areas returned after the step is processed.
- **Stop Debug** stops the logging session.
- **Show Trace** opens a window that contains the logging session. All of the steps are initially collapsed.
- **Clear Trace** clears your log file.

NOTE: The buttons are secured. An application service **F1CONFIGLOG** has been provided for this functionality to allow implementations to restrict user access to these buttons. An additional application service **F1DEBBUG** is checked when the environment is not a 'development' environment. This allows implementations to provide an additional layer of security for their production users.

The following are available to view log entries captured while using the system.

- **Show User Log** allows you to view your own log entries. The number of "tail" entries to view may be specified in the adjacent **Log Entries** field before clicking the button. Limiting the number of entries to view allows the user to quickly and easily see only the latest log entries without having to manually scroll to the end of the log.
- **Show Log** allows for advanced settings. It provides for a date / time range to allow a user to target the output for a specific period. In addition, administrative users may request to view logs of other users. The following are examples of when this capability is needed:
 - Batch and integration logs are captured by special user codes created for this type of processing. These users typically do not represent a human and therefore wouldn't access logs using "show user log". Instead someone else would be accessing these logs.
 - Customer admins would like to retrieve logs for an end user possibly for support reasons. An end user might not have technical skills to gather or assess the logs nor would they be given the privilege to access the logs for security reasons
- Checking the **Global Debug** indication starts various tracing options that are added to the user log.

NOTE: Show User Log button is secured. An application service **F1USERLOG** has been provided for this functionality to allow implementations to restrict user access to this button. Only users with access to the **Administrative** access mode of the application service are allowed to view logs of other users. Such restrictions may be called for in production environments.

For Cloud implementations only, the following buttons are available in this mode:

- **Restart TPWs** - This button forces batch containers to terminate, interrupting all running batches. New containers will spin up and the interrupted batches resume. Refer to the Batch Best Practices technical reference paper for more information about this button and when to use it.
- **Restart CM Jar Servers** - This button is provided to aid with support in the cloud for custom Java code in certain use cases. Refer to the Cloud Services Implementation Guide for more information.

Other parts of the system may show additional configuration oriented icons when in this mode. For example, explorer zones may provide additional tools to assist in debugging zone configuration. These icons are described in the context of where they appear.

Also, in debug mode drop down lists in data explorer and UI map zones will contain the code for each item in addition to the item's display string.

Prepare Issue Details

When a user encounters an error with the product and submits a service request, information about the environment, the release and the configuration of the user is often very helpful in understanding the cause of the problem. The system provides a script to capture the environment details and issue description for reporting purposes.

To access the script use **Menu > Tools > Prepare Issue Details**. The option is also available in the help menu in the toolbar.

A pop-up window is provided to display the details that are being captured, including a generated Issue ID to uniquely identify the report. The pop-up allows the user to add additional information describing the specific issue. When the user presses Save, the details are added to the system log with the issue ID, which can be searched when investigating the problem. A message will be displayed to either confirm the details were successfully logged or indicate that an error occurred.

NOTE: The script and menu item are secured. An application service **F1-PREPISSUEDTLS** has been provided to allow implementations to restrict user access to this functionality.

System Override Date

The system provides a way to override the system date used for online operations. This feature is available if the server administrator has enabled it in the environment properties. For instructions on configuring environment properties see the *Server Administration Guide*. The system date override feature is not recommended for production environments.

Under the **General System Configuration** [Feature Configuration](#), the **System Override Date Option Type** holds the date the application will use as the global system date instead of retrieving the same from the database. This feature can be especially useful in running tests that require the system date to be progressed over a period of time.

The system override date feature is also available at the user level. This is useful when a user wants override the system date to run tests without affecting the system date for other users in the environment. In order to override the system date for the user, open the [User — Characteristics](#) page, add the **System Override Date** characteristic type with a characteristic value set to the desired date in the YYYY-MM-DD format.

If system override dates are defined at both the feature configuration level and the user level, the date set at the user level will take precedence.

Additional Search Options

The product supports fuzzy searching in explorer zone types using the Oracle Text CONTAINS operator.

Refer to the DBA guide for details on setting up the database to support fuzzy searching. Note that there are some implementations where fuzzy searching will not be possible. For example, it's only available for implementations using the Oracle database. Additionally, not all languages are supported. Refer to the Oracle Database documentation for more information about fuzzy searching.

For information about the particular syntax to use in the explorer zones, refer to [SQL Statement](#) in the zone parameter details section.

Extensions Dashboard

This portal provides a high level summary of configuration entities that have been customized and extended to meet your business requirements. Included are customer owned entities and extended product owned entities. The portal is intended to be used by your implementation team to get an appreciation of areas that have been customized and may need to be reviewed or retested for various reasons.

Use **Admin > Implementation Tools > Extensions Dashboard** to navigate to the portal.

The following zones may appear as part of the portal's **Main** tab page

- **Extensions Summary.** This zone provides a summary of customized entities by maintenance object. You may select a specific maintenance objects to review entities of this type.
- **Extension Entities.** This zone lists customized entities of the selected maintenance object. It is only visible when a maintenance object is selected on the Extensions Summary zone.
- **Extension Details.** This zone provides additional information as to which specific tables contain the custom owned content for the selected entity. It is only visible when a specific customized entity is selected.

To Do Lists

Certain events that occur within the system will trigger messages describing work that requires attention. For example, if a bill segment has an error, the system generates a To Do message to alert the person responsible for correcting such errors.

Each type of message represents a To Do list. For example, there are To Do lists for bill segment errors, payment errors, customer contact reminder, etc.

We refer to each message as a **To Do Entry**. Each To Do entry is assigned a specific **To Do Role**. The role defines the users who may work on the entry. A To Do entry has a **To Do log** that maintains record of the progress on the To Do entry. For example, the To Do log indicates when the To Do entry was created, when it was assigned to a user and to whom it was assigned, and when and by whom it was completed.

FASTPATH: Refer to [To Do Processing](#) for a description of end-user queries and tools assisting in reviewing, assigning and processing To Do entries.

The Big Picture of To Do Lists

The topics below provide more information about To Do configuration.

To Do Entries Reference A To Do Type

Every [To Do entry](#) references a To Do type. The To Do type controls the following functions:

- The page into which a user is taken when they drill down to the related object on an entry.
- The message associated with the To Do that appears on various pages. Note this message can be overridden for specific To Do messages by specifying a different message number in the process that creates the specific To Do entry. For example, the process that creates To Do entries associated with bill segments that are in error displays the error message rather than a generic "bill segment is in error" message.
- The To Do entry [sort keys](#). Note that the processes that create To Do entries are responsible for populating the sort key values.
- Whether (and how) the To Do entry is downloaded to an external system (e.g., an email system).
- The roles to which an entry may be reassigned.
- The default priority of the To Do entry. Note that this value may be overridden by a **Calculate Priority** algorithm.
- An indication of whether a To Do of that type may be created manually by a user.
- The algorithms used to perform specific business rules for To Do entries of this type.
- The characteristics applicable to the To Do.

To Do Entries Reference A Role

Every [To Do entry](#) references a role. The role defines the users who may be assigned to **Open** entries.

The permissible roles that may be assigned to a To Do entry are defined on the entry's To Do type. After an entry is created, its role may be changed to any role defined as valid for the entry's To Do type.

The base package determines the initial To Do Role as follows:

- The system checks if an entry's message category / number is rerouted to a specific role. If so, it defaults this role. Refer to [Adjusting the To Do Role](#) for more information.
- There may be some other condition related to the object linked to your To Do entry that warrants an override role. A [To Do pre-creation plug-in](#) would be used to check the conditional logic and override the role, if applicable.
- If a Role wasn't determined in one of the previous steps and a Role is provided by the initiating process (algorithm or background process), the entry is created with that Role.
- If the entry does not have a role after the above takes place, the entry's To Do type's default role is assigned to the entry.

NOTE:

At installation time, the system provides a default role assigned to the system To Do types when first installed called **F1_DFLT**. This is done to allow testing of the system prior to implementing of appropriate To Do roles for your organization. The recommendation is to configure all the To Do Types with appropriate business oriented To Do roles once they are defined.

Supervisors for a Role

Most organizations have the notion of a supervisor who is responsible for all entries assigned to a given role. A user that is considered a supervisor should be a valid user in a role. In addition, application security is used to provide supervisors access to additional capabilities, namely the ability to review To Do entries assigned to other users and the ability to assign To Do entries to other users.

The pages listed in [To Do Supervisor Functions](#) are meant for supervisors only. So security for these pages should be restricted to those users that are considered supervisors. The [To Do Management](#) portal and the [To Do Search](#) page are available to all users. There is a special access mode for Supervisors to allow those users the ability to assign To Do entries to other users.

The Lifecycle Of A To Do Entry

The following state transition diagram will be useful in understanding the lifecycle of a To Do entry.

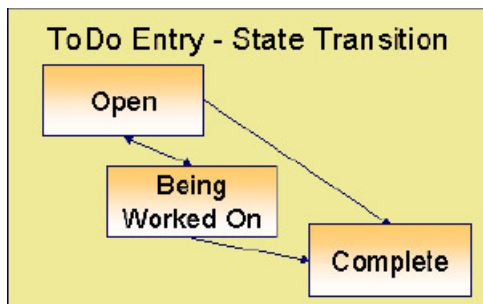

A To Do entry is typically created in the **Open** state. Entries of this type can be viewed by all users belonging to the entry's role. Refer to [How Are To Do Entries Created?](#) for information about how entries are created.

An **Open** entry becomes **Being Worked On** when it is assigned to a specific user or when a user proactively assumes responsibility for the entry. While an entry is **Being Worked On**, it is visible on the To Do Summary page only by the user who is assigned to it.

NOTE: To Do entries may be created in the Being Worked On state. Some To Do background processes may create To Do entries in the **Being Worked On** state. When a user adds a To Do entry online and assigns the To Do to a user (as opposed to a role), the To Do entry is also created in the **Being Worked On** state.

A **Being Worked On** entry may be forwarded to a different user or role. If the entry is forwarded to a role, it becomes **Open** again. This may also be referred to as "reopening" or "unassigning" a To Do entry.

When an entry becomes **Complete**, it is no longer visible in various To Do queries (but it remains on the database for audit purposes). There are two ways an entry can become **Complete**:

- A user can manually indicate it is **Complete** (there are several ways to do this).
- For To Do entries that are logically associated with the state of some object, the system automatically marks the entry **Complete** when the object is no longer in the respective state. For example, an entry that's created when an account doesn't have a bill cycle is completed when the account has a bill cycle.

CAUTION: Important! The automatic completion of To Do entries occurs when the background process responsible for creating entries of a given type is executed. Therefore, if you only run these processes once per day, these entries remain **Being Worked On** even if the object is no longer in the respective state.

- The To Do monitor process may be used to evaluate whether or not the To Do entry can be closed automatically. Refer to [Monitoring a To Do Entry](#) for more information.

How Are To Do Entries Created?

A To Do Entry may be created in the following ways:

- A [background process](#) can create To Do Entries.
- An [algorithm](#) can create entries of a given type. Because the use of algorithms is entirely dependent on how you configure the control tables, the number of types of such entries is indeterminate.
- A user can create entries of To Do types that have a **Manual** usage. Refer to [To Do Entries Created Manually](#) for information about setting up manual To Do types.

For any base product process that includes logic to create a To Do entry, the system supplies a sample To Do type that may be used. Although the To Do types provided by the product are system data, the following information related to each To Do type may be customized for an implementation and is not overwritten during an upgrade:

- The creation process. If the To Do is created by a background process where the background process is referenced on a To Do type. Refer to [To Do Entries Created By Background Processes](#) for more information.
- The routing process. Refer to [To Do Entries May Be Routed Out of the System](#) for more information.
- The priority. Refer to [To Do Type - Main](#) for more information.
- The [roles](#) that may be associated with the To Do type. Refer to [To Do Entries Reference a Role](#) for more information.
- The [message override](#) information. Refer to [Suppress the Creation of the To Do Entry, Adjusting the To Do Role and Working on a To Do Entry](#) for more information.

Suppress the Creation of the To Do Entry

The system provides the ability to indicate that a To Do Entry should not be created based on conditions. When the system detects that no To Do should be created, there is no error. The system simply returns to the caller with an indication that no To Do was created. This functionality only applies to automatic To Do Entries created by an algorithm or background process. It does not apply to manually created To Do Entries.

Suppress Based on To Do's Message

There are some types of To Do Entries that are generated with a message that is specific to a condition that was found for a record. For example, business errors found when trying to update a record through a system process will generate a To Do entry using the error message as the To Do Entry's message. There may be some use cases where the error reported is not something that a user needs to address and it may be beneficial to your organization to suppress the To Do Entry. Note that this is only appropriate if the message generated is for informational or warning purposes and doesn't require action or if you know that the error will be resolved by a subsequent step.

The configuration to suppress a To Do entry based on its message is on the [To Do type's message overrides](#) page.

NOTE: Message Category / Message Number. Every error in the system has a unique message category / number combination. Refer to [The Big Picture of System Messages](#) for more information about message categories and numbers.

We do not supply documentation of every possible message that can be handled by a given To Do type. The best way to build each To Do type's reroute list is during the pre-production period when testing the system. During this period, compile a list of the messages that warrant special behavior described here.

Note that if the To Do type is configured to reference a specific message category / number, it means all To Do entries have the same message. If your organization does not want To Do entries created for this To Do type, then rather than using this suppression technique, you should identify the background process or algorithm that generates the To Do entries of this type and change the configuration there such that it does not try to create the To Do in the first place.

Suppress Based on a Condition

There may be use cases where a To Do entry should be suppressed based on some conditional logic. For example, consider the billing process in Oracle Utilities Customer Care and Billing. There is typically a bill cycle schedule that allows for attempting to bill all the accounts for the bill cycle over a multi-day window. There are some errors that occur on day 1 of the window that may be resolved by day 2 or 3. An implementation may choose to suppress To Do entries for this condition if this is day 1 or day 2 of the bill cycle. If the error still occurs on day 3, then the To Do entry should be generated. This type of condition needs to be determined using an algorithm. The To Do pre-creation plug-ins support returning an indication to suppress the To Do entry. Refer to [To Do Pre-creation Plug-ins](#) for more information.

To Do Entries Created By Background Processes

There are different types of To Do entries created by background processes:

- To Do entries created by dedicated To Do background processes
- To Do entries created for object-specific errors detected in certain background processes
- To Do entries created based on a specific condition

Dedicated To Do Background Processes

There are To Do entries that are created by system background processes whose main purpose is to create To Do entries based on a given condition. For these background processes, the To Do Type indicates the creation background process.

Note that the [Plug-in Driven batch program](#) cannot be used for this purpose. This program assumes that any To Do Type that references it as a creation process is using the link for the [Object-Specific Error Condition](#) use case. If you want to use the plug-in driven batch process to create To Do entries based on a given condition, then you need to follow the pattern described in [To Dos Created by Background Processes for Specific Conditions](#).

NOTE: If you don't schedule the background process, the entries will not be created! The To Do entries of this type will only be created if you have scheduled the associated background process. Therefore, if you want the system to produce a given entry, schedule the background process.

To Dos Created for Object-Specific Error Conditions

A system background process may create a To Do entry when an error is detected during object-specific processing. This is applicable for processes that do not have built in error handling, for example where there is an explicit "error" state or where the record has an explicit "exception" record.

For these background processes, the To Do Type must reference the creation background process.

To have the system create To Do entries for some or all of the errors generated by one of these processes, you must do the following:

- If you want the system to generate To Do entries for errors detected by one of the background processes below, go to the appropriate To Do type and populate the creation background process.

- If you want the system to generate To Do entries for some errors for the process, but not for all errors, populate the creation background process and then proceed to the [message overrides](#) tab to [suppress](#) certain messages. Do this by indicating the message category and message number you want to suppress. Any error that is suppressed is written to the [batch run tree](#).

The functionality will only create a new To Do entry if there is not already an existing (non-complete) To Do for the same To Do type, drill key and message category / message number. It will also check for an existing To Do for a successfully processed record and complete that To Do.

If you do not populate the creation background process, the errors are written to the [batch run tree](#).

NOTE: Errors received while creating a To Do entry. If the background process cannot successfully create a To Do entry to report an object-specific error, the error is written to the batch run tree along with the error encountered while attempting to create the To Do entry.

NOTE: System errors are not included. To Do entries are not created for a system error, for example an error related to validation of input parameter. These errors are written to the [batch run tree](#). Refer to [Processing Errors](#) for more information.

To Dos Created by Background Processes for Specific Conditions

There are some system background processes that create a To Do entry when the process detects a specific condition that a user should investigate. For each background process, the To Do type is an input parameter to the process. The system provides To Do types for each base package background process that may create a To Do entry.

NOTE: No Creation Process. These To Do types do not need (and should not have) a **Creation Process** specified.

To Do Entries Created By Algorithms

There are To Do entries that are created by algorithm types supplied with the base package. The system supplies a To Do Type for each of these To Do entries that you may use.

If you want to take advantage of these types of entries for system algorithm types, you must do the following:

- Create an [algorithm](#):
 - This algorithm must reference the appropriate Algorithm Type.
 - These algorithms have a parameter of the To Do Type to be created. You should specify the To Do Type indicated in the table.
- Plug the algorithm into the respective control table.

To Do Entries Created Manually

You must set up manual To Do entry types if you want your users to be able to create To Do entries online. Users may create a manual To Do entry as a reminder to themselves to complete a task. Online To Do entries may also be used like electronic help tickets in the system. For example, if a user is having a problem starting service, the user can create a To Do that describes the problem. The To Do can be assigned to a help resolution group that could either resolve the problem or send the To Do back to the initiating user with information describing how to resolve the problem.

If you want to take advantage of manual To Do entries, create a To Do type and specify the following information.

On the Main tab:

- Set the **To Do Type Usage** flag to **Manual**.
- Set the **Navigation Option** to **toDoEntryMaint** (To Do entry maintenance).

- Set the **Message Category** and **Message Number** to the message you want to be used for To Do entries of this type. The system will populate the message parameter with the Subject. To show only the subject in the To Do's message, use a message with "%1" as its text.

On the Roles tab:

- Specify the [To Do roles](#) that may be assigned to To Do entries of this type.
- Indicate the To Do role that should be defaulted when you create To Do entries of this type.

On the Sort Keys tab:

When a user adds a manual To Do entry, the system creates an entry with three sort key values. (Sort keys may be used on the To Do list page to sort the entries in a different order.) The To Do type should be set up to reference the sort keys as follows:

Sequence	Description
1	Created by user ID
2	Created by user name
3	Subject

We recommend that the keys have an **Ascending** sort order and that the Subject is made the default sort key.

NOTE: It is possible to define additional sort keys and use a To Do Post Processing algorithm to populate the values. In this case, the base sort keys defined above should still be defined.

On the Drill Keys tab:

When a user adds a manual To Do entry, it is created with a drill key value equal to the To Do entry's ID. When the user clicks the Go To button next to the message in the To Do list, the system uses the drill down application service (defined on the main tab) and the drill key to display the associated To Do entry.

The To Do type must be set up with a drill key that reference the To Do entry table and the To Do entry ID:

Sequence	Table	Field
1	CI_TD_ENTRY	TD_ENTRY_ID

Refining a To Do Entry's Details at Creation Time

When a To Do Entry is created, the key information provided to the system are the To Do Type and the drill key, which is the identifier of the object related to the To Do entry. With this information, system logic along with algorithms called at creation time can add details to the To Do entry or update important attributes so that the To Do can be worked on by the right team in the right priority.

The topics in this section will highlight the features provided to further refine a To Do Entry at creation time.

Linking Additional Information to a To Do Entry

Additional information may be linked to a To Do entry using characteristics. This may include master data so that the To Do entry is associated with one or more specific main objects in the system. It may also include other information that is helpful to any user that may be working on the To Do entry.

For **manual** To Do entries, the valid characteristic types that may be linked to the To Do entry must be defined on the [To Do Type](#) for that To Do entry. When create a manual To Do entry, the user populates the related characteristics as part of creating the To Do.

For **automatic** To Do entries, the program that generates the To Do may link related data to the To Do using characteristics.

In addition, the system [To Do Pre-creation plug-ins](#) can be used to link additional characteristics. These algorithms would use the drill key, which is the related object for the To Do entry. Based on the drill key, it can look up other information

and create appropriate characteristics. Your specific product may be providing one or more algorithms to determine key master data records associated with the related object. For example, Oracle Utilities Customer Care and Billing provides an algorithm that attempts to link a related person, account, premise, service agreement and service point for that drill key. Other edge applications provide a similar algorithm for their relevant entities.

Any information that your user may need to have to help work a To Do entry should be linked to the To Do via a characteristic. For example, if the Rate Class of an account is important or the amount of the previous bill will help determine the priority of the To Do entry, this information may need to be linked as a characteristic.

NOTE: With the volume of To Do entries in the system, it is recommended to carefully consider what information you are linking to the To Do as a characteristic. Users can drill down on details when investigating a To Do entry. Only very important and critical information that would help users in reviewing To Do entries in the [To Do Management](#) portal and make decisions about prioritization and assignments should be linked as characteristics.

Note, before you can set up these algorithms, you must define the characteristic types that you'll use to hold each of these entities. Also note that it is not necessary to define these characteristics as valid characteristic types on the To Do type.

If your To Do entries reference characteristics that are related to your global context data, you may want to configure an alert algorithm to display an alert if a related entry is **Open** or **Being Worked On**. Refer to [Installation Options](#) for more information.

NOTE: Count of related To Do entries. There are some user interfaces that display a count of related To Do entries. This logic looks at foreign key characteristics linked to the To Do entry where the underlying object is a master or transaction object. It counts the distinct list of other non-closed To Do entries that reference the same characteristic(s).

Adjusting the To Do Role

When creating a To Do entry, for a To Do type, there may be attributes of the To Do entry that require that a special set of users work on it. This is sometimes referred to as 'rerouting the To Do entry' to a different role. This section highlights ways to override the role based on conditions specific to a To Do entry.

The information in this section only applies to automatic To Do Entries created by an algorithm or background process. It does not apply to manually created To Do Entries.

Refer to [To Do Entries Reference A Role](#) for the hierarchy used to determine the role .

Reroute Based on To Do's Message

As described in [Suppress the Creation of the To Do Entry](#), To Do entries created for a given To Do type may have different messages based on the specific condition for a record. You may decide that based on the message, the To Do should be routed to a specific Role that is more knowledgeable about a specific error condition. The same [message override](#) configuration that may be used for suppression of a To Do entry, may alternatively be used to assign a specific Role. For example, if certain bill segment errors are always resolved by the rate specialist team, you can indicate the role for that team on the To Do type, message override.

Reroute Based on a Condition

The [To Do Pre-creation plug-ins](#) may be used to assign a specific role based on some condition related to the To Do entry's specific data.

The product provides configuration on [access group](#) to define To Do assignment overrides. The override list defines a To Do type and To Do role. This is useful if your product associates access groups with specific master data for row level security purposes and you would also like to direct To Do entries related to this data to a specific role.

Oracle Utilities Customer Care and Billing also defines similar To Do assignment override configuration on CIS division and Account Management Group.

A pre-creation algorithm is responsible for checking if data linked to the To Do entry is related to a configuration object that supports an assignment override and then looks for an override for the To Do type. You can decide if this algorithm should be plugged in at the To Do Type level or the Installation level. The decision is based on how many To Do types you define overrides for. If it's a small number, then it makes more sense to plug the algorithm in for each To Do type that you define

an override for. This ensure that the configuration is only checked for To Do entries that will have an override. However, if the number of To Do types that are eligible for overrides is larger or if the list changing or growing often, it may be better to plug the algorithm in at the Installation level to ensure that every To Do is checked for a possible override.

NOTE: Note that your product may already provide a base delivered pre-creation algorithm that is checking for this override. If so, that can be used by your implementation. If not, your implementation can provide an appropriate algorithm.

To Do Pre-creation Plug-ins

The system provides two To Do Pre-creation plug-in spots that allow for functionality to add or update information on the To Do Entry that is about to be created. The two plug-in spots are [To Do type](#) and [installation options](#). In general, the installation option To Do pre-creation algorithms would be used for logic that applies to many To Do types and the To Do type pre-creation algorithms would be used for logic that is specific to that To Do type.

If at least one To Do pre-creation algorithm is plugged in on the To Do type, only those algorithms are executed when creating the To Do entry and the installation option algorithms are ignored. The system provides a base delivered To Do type pre-creation algorithm that executes the Installation option To Do pre-creation algorithms. This allows you to control whether the installation algorithms should also be executed for a To Do type that has specific algorithms and if so, when.

The following points highlight functionality supported by both To Do pre-creation plug-in spots.

- Indicate that the To Do entry should be suppressed (not created). The expectation is that this type of algorithm is configured on the To Do type rather than at the installation options level, as this allows for more granular conditions to be checked for a given To Do entry. Refer to [Suppress the Creation of the To Do Entry](#) for more information.
- Linking context specific data to the To Do entry using characteristics. Refer to [Linking Related Information to a To Do Entry](#) for more information.
- Overriding the Role of a To Do entry based on specific configuration related to the To Do's characteristic data. Refer to [Adjusting the To Do Role](#) for more information.

Assigning a Priority

As described in [The Priority of a To Do Entry](#), a To Do type may reference a Calculate Priority algorithm. If so, this algorithm is called as part of the steps to create a To Do entry. The algorithm may use the drill key or any of the related information linked to the To Do as described above to determine priority information.

The Priority Of A To Do Entry

Some To Do entries may be more urgent to resolve than others. A To Do entry is associated with a priority level representing its relative processing order compared to other entries.

Priority level is assigned as follows:

- If one or more **Calculate Priority** plug-ins are defined on the To Do entry's type, the system calls them to determine the entry's priority. They are called initially when a To Do entry is created and each time it gets updated. You may want to use this method if an entry's priority is based on context or time-based factors. For example, when priority takes into consideration account specific attributes. The system also provides a batch process (**F1-TDCLP**) that calls the calculate priority algorithms "at will" for non-closed To Do entries. This is useful when the priority should be reassessed periodically based on factors external to the To Do entry's information. Refer to [To Do Type](#) for more information on priority calculation algorithms. When the priority is determined by one of the algorithms, a log entry is created indicating that the priority was calculated.
- If a priority value has not been determined by a plug-in, the system defaults a To Do entry's initial priority to the value specified on its type.

A user may manually override a To Do entry's priority at any time. When a user overrides the priority, a log entry is created indicating that the priority was overridden. Notice that once a To Do entry's priority is overridden, **Calculate Priority** plugins are no longer called so as to not override the value explicitly set by the user.

NOTE: The system does not use priority values to control order of assignment nor processing of To Do entries. Priority is available to assist your organization with supporting a business practice that ensures higher priority issues are worked on first.

Working On A To Do Entry

A user can drill down on a To Do entry. When a user drills down on an entry, the user is transferred to the maintenance page associated with the entry (the To Do entry's drill key). The page to which the user is taken is configured on the To Do type.

It is also possible to configure the To Do type to launch a script when a user drills down on an entry rather than taking the user to a specific page. The script can check conditions related to the To Do entry to determine a more appropriate page or could be configured to walk the user through the steps required to resolve the To Do entry.

A script is linked to a To Do type based on its message number using the [To Do type's message overrides](#). Refer to [Executing A Script When A To Do Is Selected](#) for more information.

After finishing work on an entry, the user can mark it as **Complete**. Completed entries do not appear on the To Do list queries (but they are retained on the database for audit purposes). If the user cannot resolve the problem, the user can forward the To Do to another user.

Monitoring A To Do Entry

A To Do type may reference a To Do monitor [algorithm](#). The algorithms are executed by the To Do monitor background process (F1-TDMON). The process executes the monitor algorithms for any non-complete To Do entry whose To Do type references at least one monitor algorithm.

Monitor algorithms may be useful if there are business requirements where a To Do could be automatically completed based on criteria that the algorithm can review. For example, an algorithm may be used to detect if the situation that caused the To Do Entry to be generated has been remedied in the meantime, allowing for the To Do Entry to be completed.

To Do Entries Have Logs

Each [To Do entry](#) has a To Do log that maintains a record of the To Do's progress in the system. For example, the To Do log indicates when the To Do entry was created, when it was assigned to a user and to whom it was assigned, and when and by whom it was completed. Users can view the log to see who assigned them a particular To Do and whether any work has already been done on the To Do.

A log entry is created for all actions that can be taken on a To Do entry. Log entries are created for the following events:

- A To Do entry is created (either by the system or by a user)
- A To Do entry is completed (either by the system or by a user)
- A user takes an open To Do entry
- A supervisor assigns a To Do entry
- A user forwards an entry to another user or role
- A user sends back a To Do to the user who forwarded it
- A user manually adds a log entry to record details about the To Do's progress
- A user manually overrides the To Do entry's priority
- The To Do entry's priority was updated as a result of a calculate priority algorithm.

FASTPATH: For information about the contents of log entries for each of the events, refer to [Log Entry Events](#).

Implementing Additional To Do Entry Business Rules

If your business practice calls for additional validation rules or processing steps to take place after a To Do Entry is created or updated, you may want to take advantage of the **To Do Post Processing** plug-ins defined on [To Do type](#).

For example, you may want to validate that To Do entries are only assigned to users with the proper skill levels needed to resolve them. Refer to **F1-VAL-SKILL** for a sample algorithm handling such validation.

To Do Entries May Be Routed Out Of The System

A To Do type can be configured so that its entries are interfaced to another system.

For example, a given To Do type can be configured to create an Email message whenever a new To Do entry is created. The following points describe how to do this:

- Define the name of the background process responsible for interfacing the new To Do entries to another system on the respective To Do type. The base package contains a batch process called **F1-TDEER** that can be used for most situations. This batch process invokes the **External Routing algorithms** defined on each entry's To Do type.
- Plug in an appropriate **External Routing** algorithm on the respective To Do type. The logic in this type of algorithm performs the interface efforts for a specific To Do entry. For example, if an Email message should be created for a To Do entry, the logic in the algorithm would compose and send the Email message(s) for a specific To Do entry.

To Do Information May Be Formatted By An Algorithm

A **To Do Information** algorithm may be plugged in on the [installation record](#) to format the standard To Do information that appears throughout the system. This algorithm may be further overridden by a corresponding plug-in on the [To Do Type](#).

Periodically Purging To Do Entries

Completed To Do entries should be periodically purged from the system by executing the **F1-TDPG** background process. This background process offers you the following choices:

- You can purge all To Do entries older than a given number of days.
- You can purge To Do entries for a specific list of To Do types that are older than a given number of days.
- You can purge all To Do entries except for a specific list of To Do types that are older than a given number of days.

We want to stress that there is no system constraint as to the number of **Completed** To Do entries that may exist. You can retain these entries for as long as you desire. However, you will eventually end up with a very large number of **Completed** entries and these entries will cause the various To Do background processes to degrade over time. Therefore, you should periodically purge **Completed** To Do entries as they exist only to satisfy auditing and reporting needs.

NOTE: Different retention periods for different types of To Do entries. Keep in mind that the purge program allows you to retain different types of entries for different periods of time.

Setting Up To Do Options

The topics in this section describe how to set up To Do management options.

Installation Options

There are a number of installation options that may be configured to govern various aspects of To Do processing.

- A **To Do Information** algorithm may be plugged in on the Installation record. Refer to [To Do Entries My be Formatted By An Algorithm](#) for more information.
- A **To Do Pre-creation** algorithm may be plugged in on the Installation record to set additional information for a To Do entry before it is created. Refer to [To Do Pre-creation Plug-ins](#) for more information.
- A **Next To Do Assignment** algorithm must be plugged into the Installation record if your organization opts to use the next assignment feature supported by the Current To Do dashboard zone. The algorithm is responsible for determining the next To Do entry the user should work on. Make sure you provide users with security access rights to the zone's next assignment action. Refer to the [Current To Do](#) zone for more information.
- If your To Do entries reference characteristics related to your global context data and your product supports dashboard alerts generated by algorithms, you may want configure an algorithm to display an alert if an entry is **Open** or **Being Worked On** for the data currently in context. Refer to your product's documentation to determine if these types of alerts are supported.

Messages

You need only set up new messages if you use algorithms to create To Do entries or prefer different messages than those associated with the base package's To Do types.

Feature Configuration

The base package is provided with a generic **Activity Queue Management Feature Configuration** type. You may want to set up a feature configuration of this type to define any To Do management related options supporting business rules specific to your organization.

For example, the base package provides the following plug-ins to demonstrate a business practice where To Do entries are only assigned to users with the proper skill levels to work on them.

- The base **To Do Post Processing** To Do Type algorithm **F1-VAL-SKILL** validates that a user has the necessary skill levels required to work on a given To Do entry.
- The base **Next To Do Assignment** installation options algorithm **F1-NEXT-TDSK** has the ability to assign To Do entries to users that have the proper skills to work on them. This plug-in is applicable if your organization practices [work distribution](#) "on demand."

You must set up such an **Activity Queue Management** feature configuration if you want to use any of the above base package plug-ins.

The following points describe the various **Option Types** provided with the base package:

- **Skill.** This option provides a reference to a skill category. For example, if you were using characteristics to represent skill categories then you should reference each characteristic type using this option.
- **Override Skill.** This option provides an override skill information reference for a specific message. For example, if you were using a To Do Type characteristic to specify an override skill category and level for a specific message category / number then you would reference this characteristic type using this option.

NOTE: Skill Setup. Refer to the description of the above base package algorithms for further details on how to setup skill level information.

NOTE: More Options. Your implementation may define additional options types. You do this by add new lookup values to the lookup field **F1QM_OPT_TYP_FLG**.

NOTE: Only one. The system expects only one **Activity Queue Management** feature configuration to be defined.

Defining To Do Roles

This section describes the control table used to maintain To Do roles.

To Do Role - Main

The **Main** page is used to define basic information about a To Do role.

To maintain this information, select **Admin > General > To Do Role**.

Description of Page

Enter a unique **To Do Role** and **Description** for the To Do role.

The grid contains the ID of each **User** that may view and work on entries assigned to this role. The First Name and Last Name associated with the user is displayed adjacent.

NOTE: System Default Role. The system supplies a default role **F1_DFLT** linked to each system To Do type. This is done so that To Do functionality may be tested prior to the creation of appropriate business oriented To Do roles.

In addition, various "type" objects or algorithms may reference a To Do role to use when creating a To Do for a given business scenario. This is dependent on your specific product.

To Do Role - To Do Types

The **To Do Types** page defines the To Do types that may be viewed and worked on by users belonging to a given To Do role.

To maintain this information, select **Admin > General > To Do Role** and navigate to the **To Do Types** page.

Description of Page

Enter the ID of each **To Do Type** whose entries may be viewed and worked on by the role.

Use As Default is a display-only field that indicates if the role is assigned to newly created entries of this type. You may define the default role for a given To Do type on the To Do Type maintenance page.

CAUTION: If you remove a To Do type where this role is the default, you must define a new role as the default for the To Do type. You do this on the To Do Type maintenance page.

Defining To Do Types

This section describes the control table used to maintain To Do types.

To Do Type - Main

The **Main** page is used to define basic information about a To Do type.

FASTPATH: Refer to [The Big Picture Of To Do Lists](#) for more information about To Do types and To Do lists in general.

To maintain this information, select **Admin > General > To Do Type**.

CAUTION: Important! If you introduce a To Do type, carefully consider its naming convention. Refer to [System Data Naming Convention](#) for more information.

Description of Page

Enter a unique **To Do Type** and **Description** for the To Do type.

Owner indicates if this entry is owned by the base package or by your implementation (**Customer Modification**).

Use the **Detailed Description** to provide further details related to the To Do Type.

Enter the default **Priority** of To Do entries of this type in respect of other To Do types. Refer to [The Priority Of A To Do Entry](#) for more information.

For **To Do Type Usage**, select **Automatic** if To Dos of this type are created by the system (i.e., a background process or algorithm). Select **Manual** if a user can create a To Do of this type online.

Define the **Navigation Option** for the page into which the user is transferred when drilling down on a To Do entry of this type.

Use **Creation Process** to define the background process, if any, that is used to manage (i.e., create and perhaps complete) entries of this type. A **Creation Process** need only be specified for those To Do types whose entries are created by a background process. Refer to [To Do Entries Created By Background Processes](#) for more information.

Use **Routing Process** to define the background process that is used to download entries of a given type to an external system, if any. A **Routing Process** need only be specified for those To Do types whose entries are routed to an external system (e.g., an Email system or an auto-dialer). Refer to [To Do Entries May Be Routed Out Of The System](#) for more information.

Use **Message Category** and **Message Number** to define the message associated with this To Do type's entries. Note: this message will only be used if the process that creates the To Do entry does not supply a specific message number. For example, the process that creates To Do entries that highlight bill segments that are in error would not use this message; rather, the entries are marked with the message associated with the bill segment's error.

Use the characteristics collection to define a **Characteristic Type** and **Characteristic Value** common to all To Do entries of this type. You may enter more than one characteristic row for the same characteristic type, each associated with a unique **Sequence** number. If not specified, the system defaults it to the next sequence number for the characteristic type.

To Do Type - Roles

The **Roles** page defines the roles who may view and work on entries of a given To Do type.

To maintain this information, select **Admin > To Do Type > Search** and navigate to the **Roles** page.

Description of Page

Enter each **To Do Role** that may view and work on entries of a given type. Turn on **Use as Default** if the role should be assigned to newly created entries of this type. Only one role may be defined as the default per To Do type.

FASTPATH: Refer to [To Do Entries Reference A Role](#) for more information about roles and To Do entries.

To Do Type - Sort Keys

The **Sort Keys** page defines attributes that may be used to sort To Do entries.

The To Do Information zone on the To Do Management portal provides the ability to search for To Do entries using sort keys and includes up to five sort key values as columns in the results, which may be used for sorting as required.

The To Do list page includes an **Extra Information** option to allow To Do entries to be sorted by a selected sort key. Note the default sort key for this type of sorting is also defined on To Do type.

Note that this information is captured as a string and is meant for sorting purposes. The system does not capture data type information to be able to format the information for display. For example, dates are not going to display as per the user's display profile configuration.

To maintain this information, select **Admin > To Do Type > Search** and navigate to the **Sort Keys** page.

CAUTION: Do not change this information unless you are positive that the process / algorithm that creates entries of a given type stores this information on the entries.

Description of Page

The following fields display for each sort key.

Sequence is the unique ID of the sort key.

Description is the description of the sort key that appears on various pages.

Use as Default indicates the default sort key that is initially used when a user opens the To Do List page. Only one sort key may be defined as the default per To Do type.

Sort Order indicates whether the To Do entries should be sorted in **Ascending** or **Descending** order when this sort key is used on the To Do List page.

Owner indicates if this entry is owned by the base package or by your implementation (**Customer Modification**).

To Do Type - Drill Keys

The **Drill Keys** page defines the keys passed to the application service (defined on the Main page) when you drill down on an entry of a given type.

To maintain this information, select **Admin > To Do Type > Search** and navigate to the **Drill Keys** page.

CAUTION: Do not change this information unless you are positive that the process / algorithm that creates entries of a given type stores this information on the entries.

Description of Page

Navigation Option shows the page into which the user is transferred when drilling down on a To Do entry of this type.

The following fields display for each drill key.

Sequence is the unique ID of the drill key.

Table and **Field** are passed to the application service when you drill down on an entry of a given type.

Owner indicates if this entry is owned by the base package or by your implementation (**Customer Modification**).

To Do Type - Message Overrides

The **Message Overrides** page is used if you want To Do entries that reference a given message category / number to be routed to a specific To Do role or suppressed altogether or if you want to associate a script to a given message category / number.

FASTPATH: Refer to [To Do Entries Reference A Role](#) and [Suppress the Creation of the To Do Entry](#) and [Adjusting the To Do Role](#) for more information.

To maintain this information, select **Admin > To Do Type > Search** and navigate to the **Message Overrides** page.

Description of Page

The following fields display for each override.

Message Category and **Number** allow the message to be overridden.

Exclude To Do Entry indicates if a To Do entry of this type that references the adjacent **Message Category** and **Number** should not be created.

Override Role indicates the to do role to which a To Do entry of this type that references the adjacent **Message Category** and **Number** should be addressed. This field is protected if **Exclude To Do Entry** is on.

Script indicates the script that should execute when a user drills down on a To Do entry of this type that references the adjacent **Message Category** and **Number**. This field is protected if **Exclude To Do Entry** is on. Refer to [Working On A To Do Entry](#) for more information.

To Do Type - To Do Characteristics

The **To Do Characteristics** page defines characteristics that can be defined for To Do entries of this type. The characteristic types for characteristics that are linked to the To Do entry as a result of a pre-creation algorithm do not need to be defined here.

To maintain this information, select **Admin > General > To Do Type > Search** and navigate to the **To Do Characteristics** page.

Turn on the **Required** switch if the **Characteristic Type** must be defined on To Do entries of this type.

Enter a **Characteristic Value** to use as the default for a given **Characteristic Type** when the **Default** switch is turned on. Use **Sequence** to control the order in which characteristics are defaulted.

To Do Type - Algorithms

The **To Do Algorithms** page defines the algorithms that should be executed for a given To Do type.

To maintain this information, select **Admin > To Do Type > Search** and navigate to the **Algorithms** page.

Description of Page

The grid contains **Algorithms** that control important To Do functions. If you haven't already done so, you must [set up the appropriate algorithms](#) in your system. You must define the following for each algorithm:

- Specify the **System Event** with which the algorithm is associated (see the table that follows for a description of all possible events).
- Specify the **Sequence Number** and **Algorithm** for each system event. You can set the **Sequence Number** to 10 unless you have a **System Event** that has multiple **Algorithms**. In this case, you need to tell the system the **Sequence** in which they should execute.

The following table describes each **System Event**.

System Event	Optional / Required	Description
Calculate Priority	Optional	<p>Algorithms of this type may be used to calculate a To Do entry's priority. Refer to The Priority of a To Do Entry for more information on when this plug-in is called.</p> <p>Note that it is not the responsibility of the algorithms to actually update the To Do entry with the calculated priority value but rather only return the calculated value. The system carries out the update as necessary.</p>

System Event	Optional / Required	Description
		If more than one algorithm is plugged-in the system calls them one by one until the first to return a calculated priority.
External Routing	Optional	<p>Algorithms of this type may be used to route a To Do entry to an external system.</p> <p>The base package F1-TDEER background process invokes the algorithms for every To Do entry that its type references the process as the Routing Process and that the entry was not already routed. The background process marks an entry as routed by updating it with the batch control's current run number.</p> <p>If more than one algorithm is plugged-in the batch process calls them one by one until the first to indicate the To Do entry was routed.</p>
To Do Information	Optional	<p>We use the term "To Do information" to describe the basic information that appears throughout the system to describe a To Do entry. The data that appears in "To Do information" is constructed using this algorithm.</p> <p>Plug an algorithm into this spot to override the "To Do information" algorithm on installation options or the system default "To Do information" if no such algorithm is defined on installation options.</p>
To Do Monitor	Optional	Algorithms of this type are executed by the To Do Monitor background process and may be used to periodically review a To Do entry and perform actions, if needed. Refer to Monitoring a To Do Entry for more information.
To Do Post-Processing	Optional	Algorithms of this type may be used to validate and/or further process a To Do entry that has been added or updated.
To Do Pre-Creation	Optional	Algorithms of this type are called when a To Do entry is being added. Refer to Refining a To Do Entry's Details at Creation Time for more information. To Do Type pre-creation algorithms override the Installation level pre-creation algorithms.

Implementing The To Do Entries

To enable the To Do entries visible in the To Do Type page, you must configure the system as follows:

- Define the To Do roles associated with each To Do type and link the appropriate users to them. Once you have defined the roles appropriate for your organization's To Do types, remove the reference to this system default role **F1_DFLT**. Refer to [To Do Entries Reference A Role](#) for more information.
- For any To Do Type that is provided for a specific background process, the To Do simply needs to reference the appropriate Creation Background Process. When the background process is scheduled, To Dos are created based on the logic of the related background process. This applies to [To Dos Created for Object-Specific Error Conditions](#) and [Dedicated To Do Background Processes](#).
- For any To Do Type that is provided for creation by an algorithm or other process, there may be configuration required to populate that To Do type as an algorithm parameter or as an attribute on a control table.

NOTE: Refer to the description of the To Do type for more information.

Background Processes

This chapter covers various topics related to background processes. Besides providing an overview of background process functionality, the various tools available within the application to define, submit and monitor background processes are covered.

NOTE: Your specific source application may have additional background process topics. Please refer to the documentation section that applies to your source application for more information.

Understanding Background Processes

This section describes various topics related to the background processes that perform many important functions throughout your product such as:

- Processing To Do Entries
- Monitor processes that select records in a given state to progress them to their next state in their lifecycle
- Processes that purge data
- Processes that extract data
- And many more...

Background Processing Overview

While the system relies on a scheduler to secure and execute its background processes, there are additional issues that you should be familiar with:

- Batch control records are used for the following purposes:
 - Define the code that executes the logic associated with the background process.
 - For processes that extract information, the batch control record defines the next batch number to be assigned to new records that are eligible for extraction. For example, the batch control record associated with the process that routes To Do entries to an external system defines the next batch number to be assigned to new To Do entries that are configured with this batch control. When this To Do external routing process next runs, it selects all To Do entries marked with the current batch number (and increments the next batch number).
 - The batch control record for each background process organizes audit information about the historical execution of the background process. The system uses this information to control the restart of failed processes. You can use this information to view error messages associated with failed runs.
 - Many processes have been designed to run in parallel in order to speed execution. For example, the process that applies updates for a migration data set import for CMA can be executed so that multiple "threads" are processing a different subset of records (and multiple threads can execute at the same time). Batch control records associated with this type of process organize audit information about each thread in every execution. The system uses this information to control the restart of failed threads. Refer to [Parallel Background Processes](#) for more information.
 - Some processes define extra parameters. These parameters are defined with the batch control. Default values may also be captured for each parameter. They will be used when the [background process is submitted on-line](#).

The following diagram illustrates the relationships that exist for batch control records.

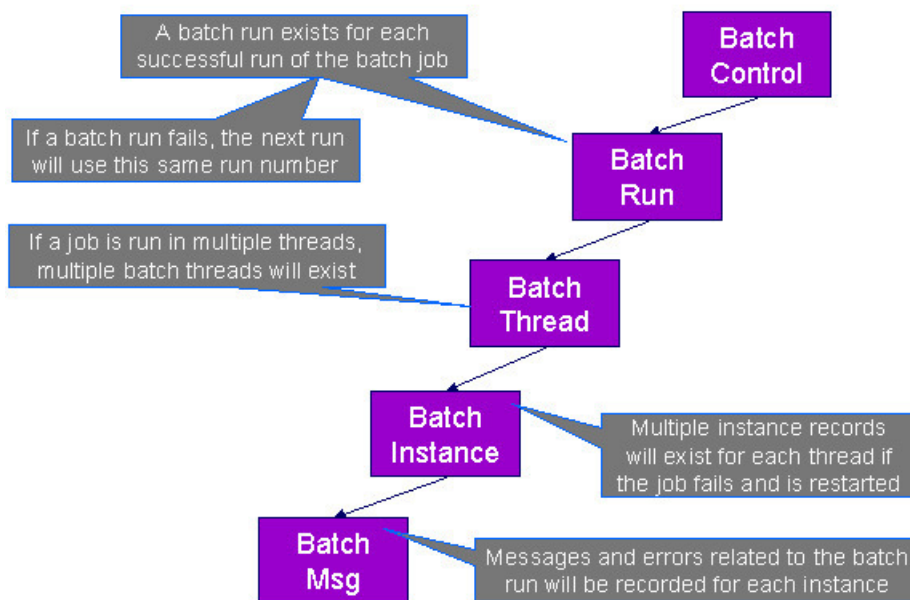

Results of each batch run can be viewed using the [Batch Run Tree](#) page.

Refer to [Batch Scheduler Integration](#) for information about the integration with the Oracle Scheduler.

Parallel Background Processes

Many processes have been designed to run in parallel in order to speed execution. This is referred to as running the process with multiple “threads”.

The system provides two strategies for distributing the data to the multiple threads.

- **Thread Level SQL Select.** This strategy is sometimes referred to as the “thread iterator” strategy. In this strategy, the batch job uses the primary key to figure out how to evenly distribute key ranges to each thread. Each thread is then responsible for selecting the records. In this strategy, the threads should also re-select the data periodically to release the cursor, which aids in performance. Note that this strategy is preferred but may only be used under the following conditions:
 - The data from only one maintenance object is being processed.
 - The primary key for the maintenance object is a single, numeric system generated key.

NOTE: Parameters may be used to override the low and high id. Refer to [Parameters Supplied to Background Processes](#) for more information.

- **Job Level SQL Select.** This strategy is sometimes referred to as the “standard commit” strategy. In this strategy, the keys for the records to be processed by the batch job are all selected first and stored in a temporary table. The batch job then supplies each thread with a range of keys that it should process. This strategy is used if multiple maintenance objects are being processed by the batch job; if the primary key of the maintenance object has multiple parts or if the primary key is non-numeric.

The multi-threading logic relies on the fact that primary keys for master and transaction data are typically system generated random keys. In addition, if the data is partitioned, it is expected to be partitioned based on the primary key.

NOTE: The detailed description in the metadata for each batch control provided with the system should indicate if it may be run in parallel. Note that the strategy used is not typically indicated in the detailed description.

NOTE: Overriding the thread ranges. Your implementation has the ability to override the thread ranges if certain data in your system takes longer to process. For example, imagine you have a single account in Oracle Utilities Customer Care and Billing that has thousands of service agreements (maybe the account for a large corporation or a major city). You may want to set up the thread ranges to put this large account into its own thread and distribute the other accounts to the other threads. To do this, you should create the appropriate batch thread records ahead of time in a status of **Thread Ready (50)** with the key ranges pre-populated. Note that the base product does not provide the ability to add batch thread records online. If you are interested in more information about this technique, contact Customer Support.

Optimal Thread Count

Running a background process in multiple threads is almost always faster than running it in a single thread. The trick is determining the number of threads that is optimal for each process.

NOTE: A good rule of thumb is to have one thread for every 100 MHz of application server CPU available. For example if you have four 450 MHz processors available on your application server, you can start with 18 threads to begin your testing: $(450 * 4) / 100 = 18$.

This is a rule of thumb because each process is different and is dependent on the data in your database. Also, your hardware configuration (i.e., number of processors, speed of your disk drives, speed of the network between the database server and the application server) has an impact on the optimal number of threads. Please follow these guidelines to determine the optimal number of threads for each background process:

- Execute the background process using the number of threads dictated by the rule of thumb (described above). During this execution, monitor the utilization percentage of your application server, database server and network traffic.
- If you find that your database server has hit 100% utilization, but your application server hasn't one of the following is probably occurring:
 - There may be a problematic SQL statement executing during the process. You must capture a database trace to identify the problem SQL.
 - It is also possible that your commit frequency may be too large. Commit frequency is a parameter supplied to every background process. If it is too large, the database's hold queues can start swapping. Refer to [Parameters Supplied to Background Processes](#) for more information about this parameter.
- It is normal if you find that your application server has hit 100% utilization but your database server has not. This is normal because, in general, all processes are CPU bound and not IO bound. At this point, you should decrease the number of threads until just under 100% of the application server utilization is achieved. And this will be the optimal number of threads required for this background process.
- If you find that your application server has not hit 100% utilization, you should increase the number of threads until you achieve just under 100% utilization on the application server. And remember, the application server should achieve 100% utilization before the database server reaches 100% utilization. If this proves not to be true, something is probably wrong with an SQL statement and you must capture an SQL trace to determine the culprit.

Another way to achieve similar results is to start out with a small number of threads and increase the number of threads until you have maximized throughput. The definition of "throughput" may differ for each process but can be generalized as a simple count of the records processed in the batch run tree. For example, in the Billing background process in Oracle Utilities Customer Care and Billing, throughput is the number of bills processed per minute. If you opt to use this method, we recommend you graph a curve of throughput vs. number of threads. The graph should display a curve that is steep at first but then flattens as more threads are added. Eventually adding more threads will cause the throughput to decline. Through this type of analysis you can determine the optimum number of threads to execute for any given process.

Parameters Supplied To Background Processes

This section describes the various types of parameters that are supplied to background processes.

General Parameters

The following information is passed to every background process.

- **Batch code.** Batch code is the unique identifier of the background process.
- **Batch thread number.** Thread number is only used for background processes that can be run in multiple parallel threads. It contains the relative thread number of the process. For example, if the billing process has been set up to run in 20 parallel threads, each of the 20 instances receives its relative thread number (1 through 20). Refer to [Optimal Thread Count for Parallel Background Processes](#) for more information.
- **Batch thread count.** Thread count is only used for background processes that can be run in multiple parallel threads. It contains the total number of parallel threads that have been scheduled. For example, if the billing process has been set up to run in 20 parallel threads, each of the 20 instances receives a thread count of 20. Refer to [Optimal Thread Count for Parallel Background Processes](#) for more information.
- **Batch rerun number.** Rerun number is only used for background processes that download information that belongs to given run number. It should only be supplied if you need to download an historical run (rather than the latest run).
- **Batch business date.** Business date is only used for background processes that use the current date in their processing. For example, a billing process may use the business date to determine which bill cycles should be downloaded. If this parameter is left blank, the system date is used. If supplied, this date must be in the format YYYY-MM-DD. Note: this parameter is only used during QA to test how processes behave over time.
- **Override maximum records between commits.** This parameter is optional and overrides each background process's Standard Commit. You would reduce this value, for example, if you were submitting a job during the day and you wanted more frequent commits to release held resources. You might want to increase this value when a background process is executed at night (or weekends) and you have a lot of memory on your servers.
- **Override maximum minutes between cursor re-initiation.** This parameter is optional and overrides each background process's Standard Cursor Re-Initiation Minutes. You would reduce these values, for example, if you were submitting a job during the day and you wanted more frequent commits to release held resources (or more frequent cursor initiations). You might want to increase these values when a background process is executed at night (or weekends) and you have a lot of memory on your servers.
- **User ID.** Please be aware of the following in respect of user ID:
 - Both the user submitting the job and the user ID recorded on the batch submission should have access to the application service for the batch control that secures execution.
 - Any batch process that stamps a user ID on a record it creates or updates uses this user ID in applicable processing.
 - This user ID's [display profile](#) controls how dates and currency values are formatted in messages.
- **Password.** Password is not currently used.
- **Language Code.** Language code is used to access language-specific control table values. For example, error messages are presented in this language code.
- **Trace Program Start, Trace Program Exit, Trace SQL and Trace Output.** These switches are only used during QA and benchmarking. If trace program start is checked, a message is displayed whenever a program is started. If trace program exit is checked, a message is displayed whenever a program is exited. If trace SQL is checked, a message is displayed whenever an SQL statement is executed. If trace output is checked, special messages formatted by the background process are written.

NOTE: The information displayed when the trace output switch is turned on depends on each background process. It is possible that a background process displays no special information for this switch.

Common Additional Parameters

Each batch control supports the definition of additional parameters. There are some additional parameters that are common to all batch processes or common to a specific type of batch process. The batch control should be delivered with the

appropriate additional parameters. However, when new additional parameters are introduced, existing batch controls may not be updated with the new additional parameter.

The following table highlights the common parameters that may be linked to a batch control. Note that for batch parameters, although there is a sequence number that controls the displayed order of the parameter, the batch process does not use the sequence to identify a particular parameter but rather uses the parameter name. In some cases multiple parameter names are supported (a 'camel case' version and an 'all caps' version).

Parameter Name	Description	Additional Comments
MAX-ERRORS / maxErrors	Each of the batch processes has, as part of its run parameters, a preset constant that determines how many errors that batch process may encounter before it is required to abort the run. A user can override that constant using this parameter.	The input value must be an integer that is greater than or equal to zero. The maximum valid value for this parameter is 999,999,999,999,999.
DIST-THD-POOL	Each batch process executes in a thread pool. This parameter is only necessary if the batch process should execute in a different thread pool than the default thread pool.	The default thread pool name is DEFAULT .
emailMode	When the batch job is submitted with an associated email address, the default logic is to send an email when the job completes regardless of success or failure. Use this parameter to limit the email based on the status of the job when it ends.	Valid Values <ul style="list-style-type: none"> • ERROR — send an email only when the job ends in Error status. • SUCCESS — send an email only when the job ends in successfully. • ALL — always send an email only when the job ends. (This is the default.)

The following parameters are only applicable to jobs that use the **Thread Level SQL Select** method of distributing work to threads as described in [Parallel Background Processes](#).

overrideLowIdValue	Specifies a new low id to use in calculating the range for a thread. The framework by default assumes that the Id is between 0's (e.g. 000000000) and 9's (e.g. 9999999999), but this parameter will override the low value.	The parameter value can be an actual number or it can be set to auto . If auto is configured, it is set to the lowest current value on the database table associated with the background process.
overrideHighIdValue	Specifies a new high id to use in calculating the range for a thread. The framework by default assumes that the Id is between 0's (e.g. 000000000) and 9's (e.g. 9999999999), but this parameter will override the high value.	The parameter value can be an actual number or it can be set to auto . If auto is configured, it is set to the highest current value on the database table associated with the background process.
idRangeOverrideClass	Use this parameter to specify a custom class to do thread range calculation. During batch execution, this override class is instantiated and the setter methods called to initialize the Ids as required. The low and high getter methods are called to retrieve the high and low ids to be used for the run.	The class name specified must implement interface <code>com.splwg.base.api.batch.BatchIdRangeOverride</code> .

The following parameters are only applicable to jobs that perform a single commit, for example for extract batch jobs.

numRecordsToFlush	This parameter defines how frequently to flush the Hibernate cache to prevent high heap consumption and Out Of Memory Errors.	
--------------------------	---	--

Specific Batch Parameters

Some background processes define additional parameters that are specific to their functionality. When a process receives additional parameters, they are defined and documented in the batch control entry in the application.

Indicating a File Path or File Name

Some of the system background processes use extra parameters to indicate a File Path and/or File Name for an input file or an output file. For example, most extract processes use File Path and File Name parameter to indicate where to place the output file.

For the file path parameter, refer to [Referencing URIs](#) for several points related to populating the file path and the supported syntax.

For the file name parameter, there are extract processes that support defining a file name that ends in ".zip" or ".gz", which will automatically result in writing the file with zip or gzip compression (based on the suffix). Similarly, there are upload processes that support decompression of files using the appropriate method based on the file name ending in ".zip" or ".gz". If the extract or upload process supports compression / decompression, it should be indicated accordingly in the description of the File Name parameter. If a batch control doesn't explicitly indicate that it supports compression or decompression in its description, the assumption should be that it is not supported.

In addition, there are extract and import processes that support automatic signing, encryption and decryption of the file content using PGP standards. File names ending in .pgp will be parsed to determine whether encryption, signing, compression or a combination of the three applies. If the file has a .pgp extension and requires decryption or signature verification, a runtime error will be issued if no encryption or signing key ring parameters are supplied.

Encrypting and Signing Files

Some files created by data export related batch processes, may need to be encrypted and/or digitally signed for security purposes. Similarly, batch upload processes may need to verify the signature and/or decrypt the content of the file being imported.

New batch parameters control whether encryption or digital signing applies to files extracted or uploaded by the process.

Extract Process Encryption Parameters

Parameter Name	Description	Additional Comments
encryptExternalKey	Use this key ring parameter to configure the external key provided by the recipient of the file.	If populated, the batch output file will be encrypted using a runtime generated key. The generated key will be encrypted using the active public key stored on the key ring. The recipient will use their private key to decrypt the generated key so the file may be decrypted. Only external public key rings may be used.
encryptSignatureKey	Use this key ring parameter to configure the internal key used to sign the file.	If populated, the batch output file will be signed using the active private key stored on the key ring. The assumption is that the corresponding public key has been shared with the recipient. Only internal file encrypting / signing key rings may be used.

Upload Process Encryption Parameters

Parameter Name	Description	Additional Comments
<code>decryptInternalKey</code>	Use this key ring parameter to configure the internal key to be used to decrypt the file to be uploaded.	If populated, the generated key received with the input file will be decrypted using the active private key stored on the key ring. The data is then decrypted using the generated key. Only internal file encrypting / signing key rings may be used.
<code>decryptSignatureKey</code>	Use this key ring parameter to configure the public signature key provided by the sender of the file.	If populated, the input file signature will be verified using the active public key stored on the key ring. Only external key rings may be used.

You may use the Batch Control Query portal to find all batch controls supporting these options.

Refer to [File Encryption and Signing Keys](#) for more information on maintaining internal and external encryption keys.

Manifest File

Batch processes that create files, for example data export related batch processes, may create one or more files in each processing thread. External applications that consume these files need to process them only when the entire batch process is successfully completed. To automate the consumption of such files, the external application may leverage a function to be triggered upon the creation of a manifest file to process all the files referenced by the manifest. The manifest file includes details such as content hash value, file size information etc that assist in confirming that file content is completed and has not been tampered with prior to processing the files.

The following sections provide additional information about manifest files.

The Manifest Option Batch Parameter

Manifest file creation is supported on certain base product extract related batch controls only. These batch controls include the **Manifest Option** batch parameter that controls whether a manifest file should be created or not upon successful completion of the batch process. You may use the Batch Control Query portal to find all batch controls supporting this option.

Manifest File Information

Manifest file content is provided in JSON format and includes the following information:

- The version of the manifest details structure.
- The batch control code, run number and rerun number identifying the batch run producing the files
- Total number of files created by the batch run.
- Total number of records processed by the batch run.
- The manifest creation timestamp in ISO format.
- The previously completed batch run number, if any.
- The manifest file produced by the previously completed batch run, if any. This may be used to ensure files are processed in a proper order and assist in detecting potential situations of missing files.
- A list of files created by the batch run that includes the following details for each file: the file's name, its size in bytes and the SHA-256 hash value of the file's content.

The manifest file name is constructed as follows:

```
[batch control]_[batch run number]_[batch rerun number]_manifest.json
```

The following is an example of the manifest file structure.

```
{
  "version": 1,
  "batchCode": "HD-PDE",
  "batchRunNumber": 106,
  "batchRerunNumber": 0,
  "totalFiles": 3,
  "recordsProcessed": 10,
  "timeStamp": "2020-05-02T16:55:43.000353Z",
  "previousBatchRunNumber": "105",
  "previousManifestFileName": "HD-PDE_105_0_manifest.json",
  "fileDetails": [
    {
      "fileName": "SOME_FILE_NAME_001.json.gz",
      "fileSize": 1543,
      "hashAlgorithm": "SHA-256",
      "hashValue": "ff7d4e466f93cad4a18ab009080916baff631e03b728e2f2684c4a4f92ccbe1"
    },
    {
      "fileName": "SOME_FILE_NAME_002.json.gz",
      "fileSize": 1182,
      "hashAlgorithm": "SHA-256",
      "hashValue": "78869e7ce971f28a70f5b35693a05726ba66109fecf492edb60291a62aeb1ba9f"
    },
    {
      "fileName": "SOME_FILE_NAME_003.json.gz",
      "fileSize": 1182,
      "hashAlgorithm": "SHA-256",
      "hashValue": "78869e7ce971f28a70f5b35693a05726ba66109fecf492edb60291a62aeb1ba9f"
    }
  ]
}
```

Verifying The Manifest File

The **Verify Manifest File** web service may be used by an external system to validate that the manifest file it has received for a specific batch run is not corrupted or tampered with. The service returns the manifest file name and the hash value of its content for the requested batch run allowing the caller to compare their file details with the returned values.

Sharing Customer Exported Data

Some data export related batch processes support an option that streamlines the process by which customer extracted data may be routed to and shared with Oracle so it can be uploaded to Oracle's data lake for analytic purposes. These batch controls include the **Copy to Oracle** batch parameter that controls whether a copy of the exported file should be sent to Oracle's data lake. You may use the Batch Control Query portal to find all batch controls supporting this option.

NOTE: The batch parameter is set to not share any content by default. Customers may opt in to share their data with Oracle by submitting such a batch process with the parameter explicitly set to do so.

NOTE: This option is only available in a cloud installation.

Processing Errors

When a background process detects an error, the error may or may not be related to a specific object that is being processed. For example, if the program finds an error during batch parameter validation, this error is not object-specific. However, if the program finds an error while processing a specific bill, this error is object-specific. The system reports errors in one of the following ways:

- Errors that are not object-specific are written to the error message log in the [Batch Run Tree](#).
- Some batch processes create entries in an "exception table" for certain object-specific errors. For example, an error detected in the creation of a bill in Oracle Utilities Customer Care and Billing may be written to the bill exception table. If an error is written to an exception table, it does not appear in the batch run tree. For each exception table, there is an associated to do entry process that creates a To Do Entry for each error to allow a user to correct the problem on-line.
- For some background processes, errors that do not result in the creation of an exception record may instead generate a To Do entry directly. For these processes, if you wish the system to directly create a To Do entry, you must configure the To Do type appropriately. Refer to [To Do entry for object-specific errors](#) for information about configuring the To Do type. If the background process detects an object specific error and you have configured the system to create a To Do entry, the error is not written to the batch run tree. If you have configured your To Do type to not create To Do entries for certain errors, these errors are written to the [batch run tree](#).

NOTE: Some processes create exceptions and To Do entries. It is possible for a background process to create entries in an exception table and create To Do entries directly, depending on the error. Consider batch billing in Oracle Utilities Customer Care and Billing; any conditions that cause a bill or bill segment to be created in **error** status result in a record added to the bill exception table or the bill segment exception table. However, any object-specific error that is not related to a specific bill or bill segment or any error that prevents a bill or bill segment from being created may result in a To Do entry for the object-specific error.

Error Post-Processing Logic

The product supports executing one or more algorithms when a batch process encounters an error that causes execution to stop. This allows for some special processing to occur to handle the failure of the batch job. Algorithms for this plug-in spot receive the batch control, batch run number, batch processing business date, number of threads and the list of the ad hoc parameters of the batch job.

NOTE: This plug-in spot is available for all Java based batch programs. For programs of type **Java (converted)**, the individual batch programs need to explicitly support this plug-in spot. Unless otherwise noted, assume that a **Java (converted)** program does not support it.

The following are some examples of functionality that may be executed when a batch job fails:

- Another object or record that is monitoring the batch job may have its status updated to reflect the batch status.
- An outbound message service may be invoked to perform a task related to the failure.

Note that the units of work for all threads are committed prior to executing the error post-processing logic.

Post-Processing Logic

The product supports executing one or more algorithms after all the threads of a given batch job have completed. This allows for some special processing to occur at the end of a batch job. Algorithms for this plug-in spot receive the batch control, batch run number, batch processing business date, number of threads and the list of the ad hoc parameters of the batch job.

NOTE: This plug-in spot is available for all Java based batch programs. For programs of type **Java (converted)**, the individual batch programs need to explicitly support this plug-in spot. Unless otherwise noted, assume that a **Java (converted)** program does not support it.

The following are some examples of functionality that may be executed at the end of a batch job:

- Another dependent batch job can be kicked off. Note that this use case is only needed when the multiple dependent jobs are not part of a scheduler (which can also detect the successful end of one batch job so as to submit the next job).

- Statistics for the batch run may be analyzed and based on results, a To Do Entry may be sent to an administrator.
- If the current batch job is processing a large number of child records in multiple threads, a parent record could be updated to a different status or with some other audit information.

Note that the units of work for all threads are committed prior to executing the post-processing logic. The algorithm should perform standard error handling. If an error occurs in one of the post-processing algorithms, the overall batch job's status is set to Error so that it can be re-submitted to retry the logic in the finalize step.

Timed Batch Processes

Most batch jobs are submitted via a batch scheduler. In the absence of a scheduler, a batch control may be configured as "timed" triggering the framework to monitor and schedule these batch jobs as defined by the timer interval. The timer interval defines the desired interval between starts (in seconds). The system schedules new batch runs at each interval if the last instance of the job has completed.

When configuring a batch control as "timed", other default information must be provided, including the User ID and Language to use for submitting the job and the email address for notification, if desired.

Timed batch controls also include an Active setting, allowing for an implementation to temporarily stop further executions of the batch job (but retain the other timer settings).

Timed jobs are controlled by the default threadpool and not by a scheduler. When the **DEFAULT** threadpoolworker starts it will start executing any job for a Batch Control configured as **Timed** with the Timer Active set to **Yes**. This is whether the batch daemon or batch server is enabled or not.

Monitor Background Processes

In many areas of the system, functionality is driven from business object configuration as a BO driven record progresses through its lifecycle. Refer to [Business Object Lifecycle](#) for details. As part of that functionality, it is possible that a background process, called a [monitor batch process](#), is used to execute functionality for the record. A single program is provided for the BO monitor functionality. The product also provides a batch control template (**F1-MNTPL**) that should be used as a starting point. Parameters are used to limit the records processed by maintenance object and other optional parameters that may further limit the records. The product typically provides at least one monitor batch control for each maintenance object that supports a configurable lifecycle on its business object.

This topic highlights the parameters supported by the monitor batch job. Not all parameters are applicable to all maintenance objects and therefore may not be configured on a given base monitor batch control.

Parameter Name	Description	Comments
maintenanceObject	Maintenance Object	For most base delivered batch controls, this parameter is delivered already populated with the value of the maintenance object value. Note that it is supported to leave this value blank, at which point, the program will determine the maintenance object (objects) to process by looking for an MO that refers to this batch control record as an option.
isRestrictedByBatchCode	Restrict by Batch Code	Set this to true to indicate whether the process should only select records that explicitly refer to this batch control on its current BO state. This is also referred to as "deferred" mode. If set to false , the program includes all records that refer to the current batch control in its BO state <u>and</u> records that don't refer to any batch control in its current state (but monitor algorithms exist in the current state). This is commonly referred to as "periodic" mode. Note that if the value is not set at all, the program will determine whether to run it as "deferred" or "periodic" based

Parameter Name	Description	Comments
		on whether the batch code is configured on the MO option as a State Monitor Process ("deferred") or a Periodic Monitor Process .
restrictToType	Restrict by Related Type	This parameter is only applicable to maintenance objects that have a related 'type' object and the maintenance object has configured an option indicating the field for the related type column. This parameter may be used to limit the processing to records that are in the indicated type.
restrictToBusinessObject	Restrict by Business Object	This parameter may be used to limit the processing to records that are in the indicated business object.
restrictToBOStatus	Restrict by Status	This parameter may be used to limit the processing to records that are in the indicated status.
restrictToDate	Restrict By Date	Enter a valid date on the record's primary table to limit processing to records that are have a value in this field that is on or before the batch business date. Optionally, enter "+" or "-" followed by a number to shift the comparison date to the batch business date plus or minus the given number. For example, entering REVIEW_DT -3 will retrieve all records whose review date is on or before the batch business date minus 3 days.
sampleRecordNumber	Sample Record Number	This is not a commonly used parameter. It is only applicable when the monitor is used for a business use case that supports processing a subset of the records during a testing phase. For example, if the process is validating a large number of records, it may be an option to only validate every 100 records to determine if there are repeated validation errors that may indicate a common problem that may be solved to fix many errors.

Also note that when submitting a monitor process with multiple [parallel threads](#), the program will use a **Thread Level SQL Select** strategy unless any of the following are true (in which case it will use the **Job Level SQL Select** strategy:

- The input maintenance object is left blank and the program finds more than one maintenance object that refers to this batch control in its options.
- A single MO is applicable but it has a multi-part primary key.
- A single MO is applicable and it has a single primary key, but it is a user defined key instead of a system generated key.
- The sample record number parameter is populated.

Plug-in Driven Background Processes

Although the product is delivered with a rich library of background processes, implementations may have business requirements that require new processes to be introduced. It is possible for an implementation to write a background process from scratch using a base process as a template. However, the product also provides base background processes that call algorithms to do the work that is needed. These are called plug-in driven background processes. There are three major types of plug-in driven batch processes:

- Processes that act on records that are stored in the database in the system. These types of processes require SQL to select the records along with the logic to process the records.
- Processes that extract information to a file. These types of processes require SQL to select the records along with the logic to select the information and return it such that the process can write the information based on various settings.

- Processes that import data from a file and store new records in the system as a result. These types of processes require an algorithm that is able to map the data from the file to appropriate new records in the system

The subsequent sections provide more detail about the three types of plug-in driven background processes.

Ad-hoc Processes

A process that retrieves records in the system and does some action on them requires an algorithm to select the records to be processed and another algorithm to process the records. We refer to this type of process as an Ad-hoc Process. The base batch control Plug-in Driven Generic Template (**F1-PDBG**) may be used as a template.

The base processes implement standard background process functionality including parallel background process logic and the ability to create To Do entries for errors. This allows for an implementation to take advantage of the pre-built support and provide plug-ins that include the logic that is unique to the specific use case.

The following sections provide more information about the functionality for ad-hoc processes. Note that extract processes share some of the same functionality. Refer to [Extract Record Processing](#) for additional information specific to extract processes.

Select Records Algorithm

The first important algorithm to design when implementing a plug-in driven batch process is the Select Records algorithm, plugged in on the [batch control](#) page. This algorithm type must define the first parameter as the SQL. The batch job will directly access the SQL parameter value in the metadata (rather than invoking the algorithm). All other parameters are available for the algorithm to use for its own logic.

In addition, when invoking the algorithm, it must return the strategy to use (**Thread Level SQL Select** or **Job Level SQL Select**). Refer to [parallel background processes](#) for more information about the two strategies and when to use each. When choosing the **Thread Level SQL Select** strategy, the algorithm should return the name of the primary key in the Key Field parameter. In addition, the SQL should include a **BETWEEN** clause that includes the bind variables for the low and high ID for the ranges. See below for the bind variable syntax.

If the SQL statement includes variables that are determined at execution time, it must use bind parameters. Bind parameters are referenced in the SQL statement using a colon and a parameter name (for example **:parameter**). There are some variables provided by the system that are populated by the batch job at execution time. These have **f1_** as its prefix.

The system supports the following pre-defined bind parameters:

- **:f1_lowID** and **:f1_highID** - these should be used in the **BETWEEN** clause for the **Thread Level SQL Select** strategy. The batch job will substitute the appropriate ID range as required.
- **:f1_batchCode** and **:f1_batchNumber** - these are common attributes of the batch control that are referenced on a record for selection purposes. Note that the batch run number is set according to whether the batch job is a re-run of a previous run or not.
- **:f1_businessDate** - the batch job will populate the input batch business date, if populated otherwise the current date.

NOTE: The system supports both "f1." and "f1_" as a prefix for the bind variables. However, the "f1." prefix will result in an error if the SQL security property setting is turned on. As such, the underscore syntax is recommended. The period syntax remains for backwards compatibility.

For any other custom parameters, the Select Records algorithm may return one or more sets of field name / variable name / value where the variable name matches a bind variable in the SQL. The field name provides information about the length that assists the SQL binding logic to properly substitute the values. Note that the variable name cannot start with **f1.** as its prefix. The batch job will use the value returned by the algorithm to set the bind parameter in the SQL statement. Also note that the logic binds all variables as a string, so for date variables the SQL must include the "TO_DATE" function.

The plug in spot receives a list of the ad hoc parameters for the batch job as name / value pairs. If the list includes parameters whose values are to be used in selecting records, your algorithm may be used to identify the relevant batch parameter passed as input and populate the field name and output bind variable appropriately.

The product provides a base algorithm type for this plug-in spot that simply defines a parameter for the SQL. It also includes parameters for the strategy and the key field name. This algorithm type may be used by any custom batch process where the SQL does not rely on any special bind variables that must be determined. Simply create an algorithm for the algorithm type and provide the appropriate SQL. Refer to the algorithm type **Select Records by Predefined Query (F1-PDB-SR)** for more information.

Process Records Algorithm

The other important algorithm to design when implementing a plug-in driven batch process is the Process Record algorithm, plugged in on the [batch control](#) page. This algorithm is called for each record selected for the process. It receives all the information that was selected from the Select Records plug-in.

For the ad-hoc processing batch process, algorithms plugged into this spot are responsible for doing the work for each record based on the desired logic.

For the extract batch process, algorithms plugged into this spot are responsible for returning the data that should be written to the file. Many of the parameters for this plug-in spot are only applicable to extract processes. Refer to [Extract Record Processing](#) for more information on the functionality specific to extract processes.

Also note that algorithms for this plug-in spot will be passed two Booleans, `isFirst` and `isLast`, to indicate if the current work unit is the first and/or last for that thread. This allows for the plug-in to do additional work if needed. Note that the `isFirst` indication is available for both types of batch processes, ad-hoc and extract. However, the `isLast` indication is only applicable for the file extract batch. For the ad-hoc batch process this value will always be set to **false**. Extracts will always execute in a single database transaction. In a single transaction run, any error causes the run to be aborted so that it restarts from the beginning when resubmitted. This is done to avoid partial files being written along with inaccurate setting of the `isLast` element.

Configuring a New Process

The following points summarize the steps needed to implement a new background process that acts on records in the system using plug-ins for the specific functionality:

- Verify the SQL that the background process should execute. Keep in mind that all the data selected in the SQL is available to pass to the plug-in that processes the records. If the performance of the background process is important, be sure to consult with a DBA when designing the SQL.
 - If the SQL does not require any custom variables to substitute at runtime, create an algorithm for the base algorithm type **F1-PDB-SR** and configure the SQL. In addition, configure the strategy and the primary key name (for the **Thread Level SQL Select** strategy).
 - If the SQL requires custom variables, a new [plug-in script](#) must be designed and coded to populate the variable names and values using the algorithm entity **Batch Control - Select Records**. Besides defining the variables, the algorithm must also indicate the strategy and the primary key name (for the **Thread Level SQL Select** strategy). Define the algorithm type for the newly created script. The first parameter of the algorithm type must be the SQL as illustrated in the base algorithm type. Note that the other parameters are available for use by this algorithm type if needed. Define the algorithm, populating the SQL as appropriate (using the custom variables).
- Design the logic required to process each record. If your edge product does not deliver a suitable plug-in, create a [plug-in script](#) where the algorithm entity is **Batch Control - Process Record**. Note that the plug-in receives all the information selected in the SQL defined in the Select Records plug-in. For an ad-hoc process, the algorithm should perform whatever process is required based on the business use case. Note that the background process is responsible for committing the records.

In either case, if a new processing script is required, define the algorithm type and algorithm for the newly created script.

- Create a batch control by duplicating the base template **F1-PDBG**. Plug in the algorithms created above and configure the parameters as appropriate. Note that you may configure custom ad hoc parameters on the batch control if required. Both base and custom batch parameter values are available to the Select Records and Process Records plug in algorithms.

Extract Record Processing

A process that selects records and produces output for each record to write to a file to integrate with external systems is called an Extract Process. The base batch control Plug-in Driven Extract Template (**F1-PDBEX**) may be used as a template.

FASTPATH: Please read the topic [Ad-hoc Processes](#). Its information about the Select Records plug-in and some of the information about the Process Record plug-in apply to extract processes. This topic focuses on aspects that are unique to extract processes.

The system provided process includes parameters to configure the file path and file name for the created file. The file path supports all the functionality described in the topic [Referencing URIs](#). The file name supports system substitution variables, such as run number, thread number, user and date / time. The process also supports compression if an appropriate extension is used. Refer to the File Name parameter description in the batch control for more information.

NOTE: Refer to [Flexible File Name / Writing Multiple Files](#) for information about support for substituting a business value into the file name.

For extract processes, the Process Record algorithm is responsible for returning the data that should be written to the file in one or more XML instances along with the schema name(s) that describes the XML instance(s). The program will write the data to the file as per the format indicated in the File Format batch parameter. By default the service uses the OUA format for date and time. To override this and use XSD format, configure the Date Time Format batch parameter to 'XSD'.

If an existing schema satisfies the output requirements, it may be used. Otherwise, you should define a data area to indicate the output format of the records as appropriate.

There are two options for designing and configuring the Process Record algorithm:

- Create a specific **Process Record** algorithm type that encapsulates the extract logic. The product provides a base algorithm type that illustrates the basic technique to follow. Refer to the algorithm type General Process - Sample Process Record Extract (**F1-GENPROCEX**) for more information.
- Create a file integration type that defines the records to be included in the extract and configure a plug-in driven batch control that references that integration type. Refer to [Extract Using File Integration](#) for more information about implementing this type of functionality.

Your specific edge product may provide other Process Record algorithm types out of the box. Use the algorithm type query and search for records for this algorithm entity.

Grouping by Record XML Node

When configuring an extract process that should produce the output in XML format, your Process Record plug-in may return multiple schemas with information that is all part of the same overall record. For example, the output could include account information and related service agreement details:

```
<account type="group"
  <accountId>1234567890</accountId>
  ...
</account>
<sa type="group"
  <saId>123457665</saId>
  ...
</sa>
<sa type="group"
  <saId>1234588913</saId>
  ...
</sa>
```

In this case, it may be desired to wrap all that information in a grouping XML tag so that all the information for one record is grouped together. Because the Process Record plug-in could be returning header or footer records that are not part of a given selected record's extract information, the batch process doesn't know what schemas returned by the Process Record

plug-in belong together logically. The output parameter 'record XML node' in the schema collection should be used to indicate the outer XML node to use to group related information together. For example:

```
<SchemaInstance>
<recordXMLNode>record</recordXMLNode>
<schemaName>CM-AccountRecord</schemaName>
<schemaType>F1DA</schemaType>
<data><account><accountId>1234567890</accountId>...</data>
</SchemaInstance>
<SchemaInstance>
<recordXMLNode>record</recordXMLNode>
<schemaName>CM-SAInfo</schemaName>
<schemaType>F1DA</schemaType>
<data><sa><saId>123457665</saId>... </data>
</SchemaInstance>
<SchemaInstance>
<recordXMLNode>record</recordXMLNode>
<schemaName>CM-SAInfo</schemaName>
<schemaType>F1DA</schemaType>
<data><sa><saId>1234588913</saId>... </data>
</SchemaInstance>
```

All schemas returned from a single call to the Process Record plug-in that have the same record XML node will be grouped in the written output within that XML tag, as per the example below:

```
<root>
<record>
<account>
  <accountId>1234567890</accountId>
  ...
</account>
<sa>
  <saId>123457665</saId>
  ...
</sa>
<sa>
  <saId>1234588913</saId>
  ...
</sa>
</record>
<record>
<account>
  <accountId>987654320</accountId>
  ...
</account>
<sa>
  ...
</sa>
</record>
</root>
```

Multi-threaded Extract

When extracting data, it's possible that the volume of data warrants running the job multi-threaded. In this case, a separate file is produced with the thread number included in the file name. You may proactively include the thread number as a substitution variable when indicating the file name. If not, the system appends the thread number.

As a convenience, the system supports concatenating the extract files produced by the various threads at the end. The system does this by finding files whose file names match except for the thread number. As such, the file name may not contain date or time if the concatenation parameter is true. Please note the following with respect to the concatenation feature:

- The content of each file is concatenated together "as is". If the individual files have header, footer or summary information, there is no logic to consolidate that information in the concatenated file. If you want a single header, footer or summary, you must run the extract single threaded.
- Concatenation is not supported if the file name indicates the zip compression should be used.
- The individual thread files are retained.

- Note that if the file format is XML, the files written for the individual threads will be written with an extension of ".tmp".

Skipping Records

By default, the extract process expects one or more schemas to be returned by each call to the Process Record plug-in. (Ideally when designing any process, the Select Records algorithm only selects records that should be processed and the Process Record algorithm does not need to confirm whether the record should be part of the processing or not.) If however there is a need to check a condition in the Process Record plug-in and it is found that no data needs to be extracted for this record, the process record algorithm should return the 'is skipped' output parameter to **true** so that the program doesn't write an empty row.

Note that the base process records algorithm for file integration types (**F1-FILEX-PR**) will set the 'is skipped' parameter to **true** if the file integration record extract record algorithm returns no data.

Configuring a New Process

The points documented in the topic related to [configuring a new adhoc process](#) with respect to the Select Records algorithm apply to extract processes.

For the Process Records algorithm, it is responsible for returning one or more schema instances populated with information that should be written to the file. If your edge product does not deliver a suitable plug-in, create a [plug-in script](#) where the algorithm entity is **Batch Control - Process Record**. Note that the plug-in receives all the information selected in the SQL defined in the Select Records plug-in.

Refer to [Configuring an Extract Process Using File Integration Type](#) for information on designing extracts using this configuration.

If a new processing script is required, define the algorithm type and algorithm for the newly created script. Create a batch control by duplicating the base template **F1-PDBEX**. Plug in the algorithms created above and configure the parameters as appropriate. Note that you may configure custom ad hoc parameters on the batch control if required. Both base and custom batch parameter values are available to the Select Records and Process Records plug in algorithms.

Extract Using File Integration

The product provides separate configuration that may be used to define how to extract the data and how to format it. This configuration provides more metadata related to defining how to get the data to extract and how to format the data. You may have many use cases where using this configuration rather than having all the logic directly in the Process Records algorithm is beneficial.

The configuration can support simple extracts, containing a single record type and possibly a header or footer record. It also supports more complex integrations, involving multiple record types and parent/child relationships between the records.

File Integration Type Configuration

The framework supplies two objects that work together to define the processing needed to create a specific type of extract:

- The file integration type which describes and classifies the extract configuration.
- The file integration record where the sequence, format and logic to extract the data required for a given record type are captured.

File Integration Type

The file integration type defines the integration classification. Currently, only **Extract** is supported. In addition, the file integration type can be assigned to a category. The category may be used to identify extracts with a common purpose or target such as collection agency referrals. Your edge product may deliver a number of categories or you may define your own.

The system provides a business object for extract file integration types (**F1-ExtractFileIntegrationType**) that is expected to be used for most use cases

File Integration Record

The file integration record is the object that is responsible for defining a record's format and capturing the record details. A separate integration record must be defined for each record type included in the extract.

The record sequence defines the order that records are processed by the system. The parent sequence defines the record type of which this record is a child. Child records may also be referenced as a parent of lower level child records. The base Process Records algorithm provided by the framework processes all child records of a record type before processing the next record type in sequence.

For extracts that are XML format, the system supports creating a grouping node surrounding all the output that belongs to the same entity. File integration records define a record XML node that will be used as the grouping node. Each record type in the list that belongs within the same group would indicate the same value in the record XML node. Refer to the [Grouping by Record XML Node](#) section for more details.

NOTE: The system does not support nested record XML nodes. All child records of a record type must define the same record XML node as the parent.

Each file integration record references a data area that defines the extract record's format, allowing the data to be extended. The **Extract Records** algorithms are responsible for populating the data area. The file integration record supports multiple extract processing algorithms so that the custom information can also be populated.

The system provides a business object for extract file integration records (**F1-ExtractFileIntegrationRec**) that is expected to be used for most extract record use cases.

Configuring an Extract Process Using File Integration Type

The following points summarize the additional steps needed to implement a new extract background process that uses a file integration type to define the specific functionality:

- Choose or create data area objects to define the extract record formats.
- Define the logic required to populate each extract record type. Your edge product may deliver suitable plug-ins or you may need to create a [plug-in script](#) where the algorithm entity is **File Integration Record - Extract Record**. Note that the Extract Record plug-in receives most of the information defined in the Batch Control - Process Records plug-in.
- Define the algorithm type and algorithm for each newly created script.
- Choose or create a category for the file integration type using lookup **FILE_INT_OBJ_FLG**.
- Create the file integration type and configure the file integration records using the defined data areas and algorithms.
- Create a batch control by duplicating the appropriate base template for an extract background process. Include the File Integration Type parameter on the batch control and reference the appropriate file integration type.
- Plug in a Process Records algorithm that reads the file integration type configuration and processes the record types. The system provides a base file integration record extraction algorithm (**F1-FILEX-PR**) that is expected to be used for most file integration plug-in extract processes.

Extending a File Integration Extract Process

Your edge product may deliver file integration types and batch controls designed for standard extract processes. However, extending the delivered extracts to add custom data is common practice for most implementations. You can customize the output from a delivered extract by:

- Identifying the record types that need additional details
- Creating a data area that defines the additional details and using that to extend the data area configured on the record type
- Creating a File Integration Record — Extract Record [plug-in script](#), algorithm type and algorithm that populates the extra details
- Adding the algorithm to the integration record's extract algorithms collection

In some cases, you may wish to extend the extract by adding additional record types. To do this, add your custom file integration records to the file integration type, following the steps described in [Configuring an Extract Process Using File Integration Type](#).

Flexible File Name / Writing Multiple Files

By default, the data is written to the File Name defined in the batch parameter. The file name supports several dynamic substitution variables as defined in the detailed description for the batch parameter in the Plug-in Driven Extract Template batch control (**F1-PDBEX**). Also refer to [Extract Record Processing](#) for information about the file name and multi-threaded processes.

The system also supports more advanced file creation for a single batch run. Consider the following use cases

- An extract is for data associated with multiple service providers where each service provider should receive its own file. In this use case, the unit of work is the service provider so a file is produced for each work unit.
- An implementation operates with multiple jurisdictions represented by CIS Division. A certain extract should result in a file per division so that each division only gets its relevant data.
- An extract of Person information should separate individual person data from business person data. In addition, for each person, the contact information should result in a separate file. In this use case, one unit of work includes data to be written to more than one file.

To support the above use cases, the Process Record algorithm supports returning the File Name in the output:

- The file name is included in the output Schema Instance group. You would populate this if you want the data for a specific Schema entry to go to this file name. In the person extract example above, the schema that includes the contact information would indicate the specific contact file.
- The file name is an output field outside the schema list. You would populate this if you don't have different files for different schemas but you still want to override the file name defined in the batch parameter. The service provider and division examples above would populate this parameter with the desired file name. The person extract example could populate this field for all the non-contact information.

The batch process checks the output after each call to the Process Records algorithm. For each schema, if there is a specific File Name associated with the schema, the data for that schema is written to that file. Otherwise, if the output file name is provided, the data is written to that file. Otherwise, the File Name in the batch parameter is used.

NOTE: Substitution Variables. After the call to Process Records, if there are any system variables in the file name, they are resolved at this time.

Managing File Names

This type of requirements means that the Process Record algorithm needs to provide a file name that has some business value to distinguish the individual files. For example, the service provider or the division or the person type value must be part of the file name. However, the recommendation is not to have the file name entirely determined by the algorithm. Rather the suggestion is that you still allow the user submitting the batch job to provide a desired file name as a batch parameter. That way, it can include any of the supported substitution variables for system information (such as batch run number, or date /time stamp) that ensure your files are unique for a given batch run. The algorithm can designate a substitution variable that it looks for to replace with the business value.

For example, using the files per division use case, imagine the user indicates the file name `EXTRACT_FILE_<DIV>_{BN}_{RN}_{TN}.csv`. The process record algorithm receives this parameter. It knows to look for "`<DIV>`" and replace it with the actual division. Imagine the division code is A100, it would return the file name `EXTRACT_FILE_A100_{BN}_{RN}_{TN}.csv` in its output, along with the data to write to that file for this unit of work.

For the person information use case above, where two files are written, the suggestion is to use the File Name parameter for one of the files, for example the person information file. An additional parameter should be used to define the second file, the contact information file. So the users submitting the batch job would define the following parameters:

Parameter Name	Description	Value	Comments
fileName	File Name	persons_<personType>_{BN}.txt	This is the file name parameter provided with the extract.
contactFileName	Contact File Name	contacts_{BN}.txt	This is a special parameter defined by the CM extract batch control.

The Process Record algorithm would look for the File Name parameter provided as input, find the text "<personType>" and replace it with the person type value and return that file name in the output. When building the list of schemas to return in the output, the one that includes the person contact information would include the file name found in the Contact File Name parameter provided as input.

Multiple Threads

This functionality works as expected with multiple threads. Based on the use case and the implementation of the Select Records algorithm, each thread could be producing files for the same business value. Let's use the division use case. Imagine an implementation has three divisions: A100, B200, C300. Now imagine that the extract is for financial information for an account. The select records algorithm should be threading by account id so that the data is evenly distributed across the multiple threads. But within each thread, accounts could be in any of the 3 implementation's divisions. So each thread could produce 3 files for each of the 3 divisions.

As described in [Multi-threaded Extract](#), the system supports an option to concatenate, allowing you to consolidate the files such that you have 3 complete files for the 3 divisions. The same features and limitations described in that topic apply for this use case.

Closing Files

An important consideration when using this functionality is that attention should be paid to how many files are open during the batch process. Each open file takes some memory to manage it. As such, the product has imposed a limit of only 10 open files (per thread) during the run of the batch job. When designing a batch to write to multiple files, the product strongly encourages you to design the process so that whenever possible, all the data for one file can be written and that file can be closed before going on to the next file.

Let's look at our examples.

- For the service provider example, the unit of work for the batch process is service provider. In this case, after each call to process records, the data can be written to the file and then the file can be closed.
- For the division example, the data selected should be threaded by the proper unit of work related to the purpose of the extract, such as Account or Asset. But the data should be ordered by division so that all the data for each division is processed before the next division's data. Each division's file can be closed once the next division's data starts getting processed.
- For the person extract example, the contact file is used for all the data so that file needs to remain open throughout the duration of the job. However, the person information gets segregated by person type. The Select Records could order the data by person type so that all the data for one type could be written and then all the data for the other type could be written. However, given that for any run no more than 3 files will ever be open, this use case is one where there is no need to actively manage closing files during the process.

How will the batch program know when to close a file? Since the batch program is agnostic and does not know what type of data is being processed nor when files should be closed, the Process Record algorithm should provide this information.

NOTE: The batch process will issue an error if Process Records indicates that the file to write to is one that was already closed. Reopening closed files is not allowed. The design of the process needs to be reviewed if this error is received.

To manage this, the batch process provides the Process Record algorithm with the list of open files (with the system substitution variables unresolved) and a Boolean to mark whether the file should be closed. To explain further, we'll use our examples.

File Per Division Example

This use case is that there are 4 divisions in the implementation: NORTH, EAST, SOUTH, WEST and that the data (account data) should be grouped in separate files by division.

The recommendation is that the Select Records algorithm selects the data ordered by Division.

The batch process passes to the Process Record algorithm the list of open files (there should be only be zero or one). In this case, the only indication that the data for one division is finished is if the Process Record algorithm sees that its data is for one division and the open file listed is for a different division. Each call should prepare its file name. Then it should see if its file name is in the list of open files. If not, it should indicate that the other open file should be closed. (Note that it doesn't need to add itself to the 'open list'. The batch program is only looking for entries marked as closed. It will ignore entries that are not marked as closed).

Assume the file name in the batch parameter is myFile_<DIV>_{BN}.txt

The data is sorted so that the accounts in the EAST division are processed first. Let's imagine this is a work unit that is also in the EAST division. It receives the file name and the list of open files.

```
...
<hard>
<batchParms>
  <BatchParm>
    <name>fileName</name>
    <value>myFile_<DIV>_{BN}.txt</value>
  </BatchParm>
  ...
</batchParms>
<openFiles>
  <OpenFile>
    <closeFile></closeFile>
    <fileName>myFile_EAST_{BN}.txt</fileName>
  </OpenFile>
</openFiles>
...
</hard>
```

The algorithm substitutes its division into the <DIV> portion of the file and populates that in the output. It then compares its file name with the current list of open files. It finds its file so it doesn't need to do anything else.

```
<hard>
...
<fileName>myFile_EAST_{BN}.txt</fileName>
...
<openFiles>
  <OpenFile>
    <closeFile></closeFile>
    <fileName>myFile_EAST_{BN}.txt</fileName>
  </OpenFile>
</openFiles>
...
</hard>
```

If we then imagine a call to the process records algorithm where the division is NORTH and it's the first entry for that division, here is what it receives:

```
<hard>
<batchParms>
  <BatchParm>
    <name>fileName</name>
    <value>myFile_<DIV>_{BN}.txt</value>
  </BatchParm>
  ...
</batchParms>
```

```

<openFiles>
  <OpenFile>
    <closeFile>true</closeFile>
    <fileName>myFile_EAST_{BN}.txt</fileName>
  </OpenFile>
</openFiles>
...
</hard>

```

The algorithm substitutes its division into the <DIV> portion of the file and populates that in the output. It then compares its file name with the current list of open files and doesn't find its file name. So it indicates that the existing open file should be closed.

```

<hard>
...
<fileName>myFile_NORTH_{BN}.txt</fileName>
...
<openFiles>
  <OpenFile>
    <closeFile>true</closeFile>
    <fileName>myFile_EAST_{BN}.txt</fileName>
  </OpenFile>
</openFiles>
...
</hard>

```

File Per Service Provider Example

In this use case, the unit of work is service provider and each service provider should have its own file. In this case, as the Process Record algorithm is preparing the data and the file name unique to its service provider, it can also indicate that the file can be closed. There is no need to wait for the next call to Process Record to indicate that the previous file can be closed. Let's assume the file name is MYFILE_<serviceProvider>_{BN}_{TN}.txt. Each call to Process Records will pass the batch parm file name and no open files.

```

<hard>
<batchParms>
  <BatchParm>
    <name>fileName</name>
    <value>MYFILE_<serviceProvider>_{BC}_{TN}.txt</value>
  </BatchParm>
  ...
</batchParms>
<openFiles>
  <OpenFile>
    <fileName></fileName>
    <closeFile></closeFile>
  </OpenFile>
</openFiles>
...
</hard>

```

The algorithm is processing data for service provider A100. It returns the following information related to the file name, namely the single File Name in the output related to this service provider and adds its file to the open file list and indicates that it should be closed. (Note that file-per-work-unit is the only known use case where the algorithm will know that it is the last entry for a file and to close itself.)

```

<hard>
...
<fileName>MYFILE_A100_{BC}_{TN}.txt</fileName>
...
<openFiles>
  <OpenFile>
    <closeFile>true</closeFile>
    <fileName>MYFILE_A100_{BC}_{TN}.txt</fileName>
  </OpenFile>
</openFiles>
...
</hard>

```

Multiple Open Files Example

This example assumes that the file names are defined as per the Managing File Names section above. We'll assume that the algorithm designer chose to not actively close the person information file since there are never more than three files open. Similarly, we'll assume that they chose not to order the data by person type. Here is what is passed in in the middle of the run:

```
<hard>
<batchParms>
  <BatchParm>
    <name>fileName</name>
    <value>persons_<personType>_{BN}.txt</value>
  </BatchParm>
  <BatchParm>
    <name>contactFileName</name>
    <value>contacts_{BN}.txt</value>
  </BatchParm>
  ...
</batchParms>
<openFiles>
  <OpenFile>
    <fileName>persons_P_{BN}.txt</fileName>
    <closeFile></closeFile>
  </OpenFile>
  <OpenFile>
    <fileName>persons_B_{BN}.txt</fileName>
    <closeFile></closeFile>
  </OpenFile>
  <OpenFile>
    <fileName>contacts_{BN}.txt</fileName>
    <closeFile></closeFile>
  </OpenFile>
</openFiles>
...
</hard>
```

An instance of one call to Process Records algorithm that has details for an individual ("P" person type).

```
<fileName>persons_P_{BN}.txt</fileName>
<fileOutput>
  <listValue>
    <SchemaInstance>
      <recordXMLNode>person</recordXMLNode>
      <schemaName>CM-PersonDetail</schemaName>
      <schemaType>FLSS</schemaType>
      <fileName></fileName>
      <data>LotsOfData</data>
    </SchemaInstance>
  </listValue>
  <listValue>
    <SchemaInstance>
      <recordXMLNode>person</recordXMLNode>
      <schemaName>CM-AddressDetail</schemaName>
      <schemaType>FLSS</schemaType>
      <fileName></fileName>
      <data>LotsOfData</data>
    </SchemaInstance>
  </listValue>
  <listValue>
    <SchemaInstance>
      <recordXMLNode></recordXMLNode>
      <schemaName>CM-ContactDetail</schemaName>
      <schemaType>FLSS</schemaType>
      <fileName>contacts_{BN}.txt</fileName>
      <data>LotsOfData</data>
    </SchemaInstance>
  </listValue>
</fileOutput>
```

This XML example illustrates the following points:

- There is an override file name in the fileName element.
- The first two schemas don't have any value in the fileOutput\listValue\SchemaInstance\fileName so they should be written to the file in fileName. Note that these two schemas also include a Record XML Node. That will ensure that if the output is XML format, the data from both of those schemas will be wrapped by the 'person' XML Node. This is not functionality related to this epic. It's just trying to illustrate multiple features.
- The third schema has an entry in fileOutput\listValue\SchemaInstance\fileName . So that data is written to a separate file.

Uploading Records

The base product provides a background process to upload data from a file. The batch control Plug-in Driven File Upload Template (**F1-PDUPL**) may be used as a template. The process includes parameters to configure the file path and file name for file to upload along with other parameters to control how to handle missing files and how to rename the file once processed. Refer to the description of the batch control and its parameters for more information.

This background process requires an algorithm plugged into the plug-in spot **File Upload**. This plug-in is called once for a given file. The batch process opens the file and passes to the algorithm the file reader element. The algorithm associated with the batch control is responsible for using provided APIs to read the content of the file and store the data in appropriate table(s) (for example, an appropriate staging table). The base provided process supports uploading multiple files and may be run mutli-threaded to process multiple files. Each file is processed by one call to the File Upload algorithm and supports a single commit for the records uploaded in a given file.

NOTE: Plug-in scripts written to implement this type of algorithm must use the Groovy script engine version as the APIs are not accessible using the XPath scripting language. Refer to [Additional Coding Options For Server Scripts](#) for more information.

Note that this step in the upload of data is only one part of a typical upload end-to-end process. This step is sometimes referred to in the product as "Process X". The goal of this step is to get records from a file into database records, with minimal validation and processing. The data should be stored in records that are then processed by a second step (often referred to in the product as the "upload" step, for example "Payment Upload"). The second step, independent of the plug-in driven batch process described here, is responsible for validating the data and should be able to be threaded by individual records and have proper error handling for individual records. Note that depending on the type of data being uploaded, the product may already supply appropriate tables that the plug-in driven upload process may populate. These could be staging tables, such as payment upload staging. Or they may be records with business objects that have a lifecycle designed to handle uploaded data, for example Business Flag. In such cases, the product will typically supply out-of-the-box background processes to validate and further process the data and finalize the upload. If the data to upload does not already have a base provided staging table, be sure to work with your implementation team to identify an appropriate table to use for the plug-in driven batch upload. In addition, confirm the design for the second step that is responsible for the detailed validation and finalization of the data.

The product supplies sample algorithms to illustrate calling the supplied APIs for processing different types of source data: comma delimited, fixed position and XML. In every case, the sample data supported by the upload uses 'degree day' information to illustrate the process. The system provides sample target records (based on the Fact maintenance object) in order to illustrate the step to store records based on the input data. Note that only sample plug-in scripts have been provided. No algorithm, algorithm type or batch control is configured to use the sample plug-in scripts. To view the scripts, navigate to the [Script](#) page, search for a Script Type of **Plug-in Script** and Algorithm Entity of **Batch Control - File Upload** and look for the 'Sample' scripts.

Note that the sample plug-in scripts provided by the product are supplied to illustrate use of the provided APIs. They should not be considered a template for how to implement a plug-in script for a real use case. The following highlight some points to consider when designing a file upload algorithm:

- **Error handling / resolution.** The sample plug-in scripts do some basic error handling related to the data to illustrate error handling. However, any errors found in this step require processing of the whole file to stop. As such, this plug-in should only report errors that are not possible to fix, but where the whole file should be rejected. If there are errors that can be adjusted in the data, then the recommendation is to not check for those errors at this step. Rather, this plug-

in should simply populate the appropriate staging tables and let the next step check for validity. As described above, the next step should include the ability to mark individual records in error, allowing for users to fix the data and retry.

- **Target tables.** The sample plug-in scripts use Fact as the target for the resulting insert statements. As mentioned above, the decision of where to store the uploaded data must be carefully considered. There may already be existing tables that are specific to a given use case. If the data being uploaded does not have existing tables to use, review the product to verify what existing tables may be useful, such as Inbound Sync Request or Service Task. Be sure that the tables chosen support error handling, either out-of-the box or via designing an appropriate business object with a lifecycle that supports an error status and the ability to resolve the error. Also note that the Sample Flat File Upload plug-in illustrates a header record / detail record scenario. In this case, the header record is linked to the child record via a CLOB element. This is not the recommended technique. In a real use case, the header record should be linked to the child record via a separate database column to allow for searching.

Configuring a New Process

The following points summarize the steps needed to implement a new file upload background process:

- Verify the details of the data in the upload file and map the data to fields in one or more appropriate tables in the system.
- Design the logic required for reading the record details and identifying each record to properly create the insert statements for storing the data. The sample plug-in scripts provided by the product illustrate using the various APIs available for use. Create a [plug-in script](#) where the algorithm entity is **Batch Control - File Upload**. Create an appropriate algorithm type and algorithm for this plug-in script.
- Create a batch control by duplicating the base template. Plug in the algorithm created above and configure the parameters as appropriate. Note that you may configure custom ad hoc parameters on the batch control if required. Both base and custom batch parameter values are available to the File Upload algorithm.

How to Re-extract Information

If you need to recreate the records associated with an historical execution of an extract process, you can - simply supply the desired batch number when you request the batch process.

How to Submit Batch Jobs

Most batch jobs are submitted via a batch scheduler. Refer to [Batch Scheduler Integration](#) for information about the integration with the Oracle Scheduler.

Batch jobs may be configured as **Timed**, which means they will automatically be run based on the timer frequency.

You can manually submit your adhoc background processes or submit a special run for one of your scheduled background processes using the online [batch job submission](#) page.

The system provides a [REST web service](#) (using the inbound web service **F1-SubmitJob**) to create a batch job submission request from an external system. Note that no parameter defaulting occurs when submitting a record using a web service. All the desired parameter values must be provided.

How to Track Batch Jobs

You can track batch jobs using the batch process pages, which show the execution status of batch processes. For a specified batch control id and run id, the tree shows each thread, the run-instances of each thread, and any messages (informational, warnings, and errors) that might have occurred during the run.

FASTPATH: For more information, refer to [Tracking Batch Processes](#).

How to Restart Failed Jobs and Processes

Every process in the system can be easily restarted if it fails (after fixing the cause of the failure). All you have to do is resubmit the failed job; the system handles the restart.

Assessing Level of Service

For some background processes, an implementation may wish to supply one or more algorithms that check some conditions to assess whether or not the process is performing as expected. An algorithm could be used to check the performance of the job to see if it is running as efficiently as expected. Or it could analyze the data processed by the background process to assess whether there may be some problem with the quality of the data.

The system provides a Level of Service plug-in spot on [batch control](#) to configure the appropriate algorithms for a given background process, if desired. Each algorithm is expected to return a value to indicate the 'level of service' determined along with a message indicating the reason for the value. The following Level of Service values are supported:

- **Normal.** Indicates that the algorithm did not detect any issues.
- **Warning.** Indicates that the algorithm found some issues that may or may not indicate a problem.
- **Error.** Indicates that the algorithm found some issues that should be investigated.
- **Disabled.** Indicates that the algorithm could not properly execute the level of service logic.

When viewing a [batch control](#) record, if there are any level of service algorithms configured, the logic is executed and the results are displayed. The level of service is also part of the [Health Check](#) service.

Defining Batch Controls

The system is delivered with all necessary batch controls. Implementations may define default values for parameters. In addition, implementations may define their own background processes.

To view background processes, open **Admin > System > Batch Control**.

Use the **Batch Control Query** portal to search for an existing batch control. Once a batch control is selected, you are brought to the maintenance portal to view and maintain the selected record.

Refer to [Background Processing Concepts](#) for more information.

CAUTION: Important! If you introduce a new batch process, carefully consider its naming convention. Refer to [System Data Naming Convention](#) for more information.

Description of Page

Enter an easily recognizable **Batch Process** and **Description** for each batch process.

Owner indicates if this batch control is owned by the base package or by your implementation (**Customer Modification**). The system sets the owner to **Customer Modification** when you add a batch control. This information is display-only.

Use the **Detailed Description** to describe the functionality of the batch process in detail.

Enter the **Application Service** that is used to provide security for submission requests for the batch control. The application service must have an Access Mode of **Execute**. Refer to [Granting Access To Batch Submission](#) for more information.

Use **Batch Control Type** to define the batch process as either **Timed** or **Not Timed**. A [Timed batch process](#) will be automatically initialized on a regular basis. A Not Timed process needs to be run manually or through a scheduler.

Use **Batch Control Category** to categorize the process for documentation purposes. The base values provided are as follows:

- **Ad Hoc.** Processes of this type are run on an ad hoc basis, only when needed. For example, if there is a process to do a mass cancel / correction of data, it would only be run when a situation occurs requiring this.
- **Extract.** Extract processes extract information that is interfaced out of the system. Processes of this type typically extract records marked with a given run number. If the requester of the process does not supply a specific run number, the system assumes that the latest run number should be extracted. If you need to re-extract an historical batch, you simply supply the respective run number when you request the batch process.
- **ILM. Information Lifecycle Management** jobs are crawler background processes that are associated with the ILM based storage solution.
- **Monitor.** Processes of this type are processes related to business objects with a lifecycle state that defines [monitor algorithms](#). The monitor process selects records in a given state and executes its algorithms, which may cause the record to transition to another state or may trigger some other logic to occur. Using configuration, the monitor process may target only specific records. Refer to [Monitoring Batch Processes](#) for more information. Note that these types of background processes can be considered a subset of **Process What's Ready**
- **Process What's Ready.** Processes of this type create and update records that are “ready” for processing. The definition of “ready” differs for every process. For example, a payment upload process creates payments for every record that is **pending**. An overdue event monitor activates pending overdue events that have reached their trigger date.
- **Purge.** Processes of this type are used to purge historical records from certain objects that generate a large number of entries and may become unwieldy over time.
- **To Do Entry.** Processes of this type are used to detect a given situation and create or complete a To Do Entry. Refer to [To Do Entries Created by Background Processes](#) for more information.
- **Upgrade.** Processes of this type are typically run only one time and are used to populate data in a table based on information that can be determined elsewhere in the system. These are processes that could have been done through an upgrade script, but perhaps due to data volume or timing, the upgrade logic warranted a separate stand-alone process.
- **Upload.** Processes of this type are used to upload data from a file into the system.
- The following categories are related to the data conversion / migration processes:
 - **Conversion.** Processes of this type are dedicated to converting or migrating data from external applications into the product.
 - **Object Validation.** Processes of this type are dedicated to validate data within objects for conversion or migration purposes.
 - **Referential Integrity.** Processes of this type are dedicated to validate referential integrity within objects for conversion or migration purposes.

NOTE: Additional categories may be introduced by your specific product.

If the batch process is Timed, then the following fields are available:

- **Timer Interval** is the number of seconds between batch process submissions. The system will start the next run this many seconds from the start time of the previous run.
- **User ID** is the ID under which the batch process will run.
- **Email Address** is the Email address to be used for notification if the batch process fails.
- **Timer Active** allows you to temporarily switch off the timer while retaining the other settings for the timed job.
- **Batch Language** is the language associated with the batch process.

Use **Program Type** to define if the batch process program is written in **Java** or **Java (Converted)**, meaning that the program has been converted into Java.

NOTE: **Java (Converted)** program types are not applicable to all products.

Use **Program Name** to define the Java class / program associated with your batch process.

NOTE: View the source. If the program is shipped with the base package, you can use the adjacent button to display the source code of this program in the [Javadocs](#) viewer.

Level of Service shows the output of the [level of service](#) algorithms for the batch control. If one algorithm is plugged into the Batch Control, the level of service lookup value along with a message indicating the reason for the output value is shown. If multiple algorithms are plugged in, the text **See Results for Details** is displayed. There is an icon provided to expand the details returned by each algorithm. If no level of service algorithm is found, then the value **Disabled** is shown with a message indicating that no algorithm is provided for this batch control.

The **Last Update Timestamp**, **Last Update Instance** and **Next Batch Nbr** are used for audit purposes.

Turn on **Accumulate All Instances** to control how this batch control is displayed in the [Batch Run Tree](#). If checked, the run statistics (i.e., "Records Processed" and "Records in Error") for a thread are to be accumulated from all the instances of the thread. This would include the original thread instance, as well as any restarted instances. If this is not turned on, only the ending (last) thread instance's statistics are used as the thread's statistics. This may be preferred for certain types of batch processes where the accumulation would create inaccurate thread statistics, such as those that process flat files and, therefore, always start at the beginning, even in the case of a restart.

The following fields are default values that are used when a batch job is submitted for the batch control:

- Use **Thread Count** to control whether a background process is run single threaded or in multiple parallel threads. This value defines the total number of threads that have been scheduled.
- Select **Trace Program Start** if you want a message to be written whenever a program is started.
- Select **Trace SQL** if you want a message to be written whenever an SQL statement is executed.
- Use **Override Nbr Records to Commit** to define the default number of records to commit. This is used as the default value for timed jobs as well as online submission of jobs that are not timed.
- Select **Trace Program Exit** if you want a message to be written whenever a program is exited.
- Select **Trace Output** if you want a message to be displayed for special information logged by the background process.

For more information about these fields, see [Batch Job Submission - Main](#)

The parameter collection is used to define additional parameters required for a particular background process. The following fields should be defined for each parameter:

Sequence. Defines the relative position of the parameter.

Parameter Name. The name of the parameter as defined by the background process program.

Description. A description of the parameter.

Detailed Description. A more detailed description of the parameter.

Required. Indicates whether or not this is a required parameter.

Parameter Value. The default value, if applicable. Any value entered here is displayed to a user when submitting a job through online [Batch Submission](#). Users may override the value before submitting the job. This includes resetting the value for an optional parameter. Regardless of how a batch job is submitted, if a value is not supplied for a required parameter, the default value define here, if found, is used. Optional parameters with no value supplied at submission time will not be defaulted to a value defined here. Note that an implementation may define a default value for base provided batch controls.

Security. Indicates whether the system should **Encrypt** the parameter value or not. A value of **Encrypt** means that the parameter value is stored in the database and written to the log files using encryption. In addition, the parameter is written to the log files with asterisks. The setting applies to values entered here as well as in the online [Batch Submission](#). If there is no need to secure the parameter value, use the default setting of **None**.

Owner Indicates if this batch process is owned by the base package or by your implementation (Customer Modification). The system sets the owner to **Customer Modification** when you add a batch process. This information is display-only.

Batch Control - Algorithms

Use this page to maintain a batch control's algorithms. Open this page using **Admin > System > Batch Control** and then navigate to the **Algorithms** tab.

Description of Page

The **Algorithms** grid contains algorithms that control important functions for instances of this batch control. You must define the following for each algorithm:

- Specify the **System Event** with which the algorithm is associated (see the table that follows for a description of all possible events).
- Specify the **Sequence Number** and **Algorithm** for each system event. You can set the **Sequence Number** to 10 unless you have a **System Event** that has multiple **Algorithms**. In this case, you need to tell the system the **Sequence** in which they should execute.
- **Owner** indicates if this is owned by the base package or by your implementation (**Customer Modification**).

The following table describes the **System Events**.

System Event	Optional / Required	Description
Error Post-Processing	Optional	Algorithms of this type are called if the batch process fails to complete due to an error. Multiple algorithms are allowed and are executed in sequence order. Refer to Error Post-Processing Logic for more information.
File Upload	Optional	Algorithms of this type are only applicable to plug-in driven background processes and are used to upload all records for a file. This is a single algorithm plug-in spot. If multiple algorithms are plugged into the batch control, the one with the highest sequence is used.
Level of Service	Optional	Algorithms of this type are called to determine the Level of Service provided by a batch control. Multiple algorithms are allowed. Refer to Assessing Level of Service for more information.
Post-Processing	Optional	Algorithms of this type are called after all threads are complete. Multiple algorithms are allowed and are executed in sequence order. Refer to Post-Processing Logic for more information.
Process Record	Optional	Algorithms of this type are only applicable to plug-in driven background processes and are used to process a specific record. This is a single algorithm plug-in spot. If multiple algorithms are plugged into the batch control, the one with the highest sequence is used.
Select Records	Optional	Algorithms of this type are only applicable to plug-in driven background processes and are used to define the SQL to use to select the records to process. This is a single algorithm plug-in spot. If multiple algorithms are plugged into the batch control, the one with the highest sequence is used.

NOTE: You can add new system events. Your implementation may want to add additional batch control oriented system events. To do that, add your new values to the customizable lookup field **F1_BATCH_CTRL_SEVT_FLG**.

Defining File Integration Types

This section describes the functionality supported for viewing and maintaining file integration types.

Refer to [Extract Record Processing](#) for an overview of the file integration type functionality provided with [plug-in driven background processes](#).

To view or add a file integration type, open **Admin > Integration > File Integration Type**.

Once a file integration type record has been selected, you are brought to the maintenance portal to view and maintain the selected record.

The **File Integration Records** zone lists the record definitions for this integration, in hierarchical order. Use the zone actions to add, maintain or view a file integration record. Press the **Record Layout** icon to view a pop-up display of the record's schema.

On-Line Batch Submission

The on-line [batch submission](#) page enables you to request a specific background process to be run. When submitting a background process on-line, you may override standard system parameters and you may be required to supply additional parameters for your specific background process. After submitting your background process, you may use this page to review the status of the submission.

The following topics further describe logic available for on-line submission of background processes.

Batch Submission Creates a Batch Run

When you request a batch job to be submitted from on-line, the execution of the desired background process will result in the creation of a batch run. Just as with background processes executed through your scheduler, you may use the [Batch Run Tree](#) page to view the status of the run, the status of each thread, the run-instances of each thread, and any messages that might have occurred during the run.

NOTE: Your on-line submission record is assigned a status value so that you may know whether your job has been submitted and whether or not it has ended, however, it will not contain any information about the results of the background process itself. You must navigate to the [Batch Run Tree](#) page to view this detail.

Jobs Submitted in the Background

When you save a record on the batch job submission page, the batch job does not get submitted automatically. Rather, it saves a record in the batch job table. A special background process will periodically check this table for pending records and will execute the batch job. This background process will update the status of the batch job submission record so that a user can determine when their job is complete.

NOTE: At installation time, your system administrator will set up this special background process to periodically check for pending records in the batch job submission table. Your administrator will define how often the system will look for pending records in this table.

It should be noted that this special background process only submits one pending batch job submission record at a time. It submits a job and waits for it to end before submitting the next pending job.

NOTE: If you request a batch job to be run multi-threaded, the special background process will submit the job as requested. It will wait for all threads to complete before marking the batch job submission record as **ended**. Refer to [Running Multi-threaded Processes](#) for more information.

Email Notification

If you wish the system to inform you when the background process completes, you may supply your email address. The email you receive will contain details related to the batch job's output; similar to the job results you would see from your batch scheduler.

The email includes information from the product installation to help users that may be working in and submitting background processes in more than one environment.

- It includes the product name and product version for the product in the [installed products](#) list that is marked as the one to display.
- If a domain name message is configured in the [installation messages](#), this information is also included.

NOTE: This assumes that during the installation process, your system administrator configured the system to enable email notification. Your administrator may also override the amount of detail included in the email notification.

NOTE: A batch control parameter may be used to indicate if the email should only be sent in the case of an error or success or both. Refer to [Parameters Supplied to Background Processes](#) for more information.

Running Multi-Threaded Processes

Many of the system background processes may be run multi-threaded. When submitting a background process on-line, you may also run a multi-threaded process. The fields Thread Count and Thread Number on the [batch submission](#) page control the multi-threaded process requests:

- To run a multi-threaded process, indicate the number of threads in **Thread Count** and enter **0** in the **Thread Number**. If a previous run ended with one or more threads in error, a new submission may be created to restart all the threads that were in error. This submission would result in new Batch Thread Instance records added for each thread that previously ended in error. Note that if the previous run was marked to "Do Not Restart", then a new submission will result in a new Batch Run.
- In the situation where a previous run resulted in one or more threads in error, you may use the Thread Number to indicate a specific thread to restart. This is only valid if there is a previous run found that is not marked "Do Not Restart". This will result in a new Batch Thread Instance created for the specific thread in the previous run.
- To run a process as a single thread, enter Thread Count = **1** and Thread Number = **1** (or **0**). This will execute the background process single-threaded.

NOTE: When running a multi-threaded process, the special background process will wait until all threads are complete before marking the batch job submission record as **Ended**.

Batch Jobs May End in Error

It is possible for your background process to end with an error. When this occurs, your batch job submission record will still be marked as **Ended**. You will need to navigate to the [Batch Run Tree](#) page to determine the status of the batch run.

Submitting Jobs in the Future

If you wish to request a batch job to be submitted in the future, you may do so when creating your batch job submission record by entering a future submission date. The special background process, which looks for pending records in the batch job submission table, will only submit batch jobs that do not have a future submission date.

Lifecycle of a Batch Job Submission

The following diagram illustrates the lifecycle of a batch job submission record.

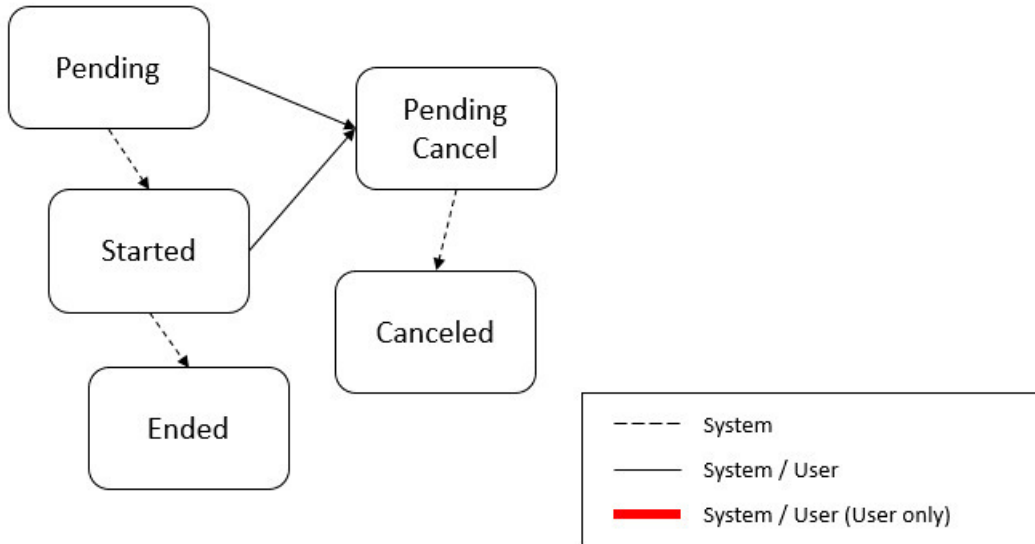

Pending – Records are created in **Pending** status. Records in this state are put in a queue to be submitted.

Started – Once a pending record has been submitted for processing, its status will be changed to **Started**.

Pending Cancel – Users may request the cancellation of a pending record to prevent the batch job from being submitted. In addition, users may request to cancel a started batch job that was not initiated by DBMS scheduler. The system will look for records in this status and look for batch runs that may need to be canceled for this batch job. Once it is confirmed that any batch runs are stopped, the status changes to **Canceled**.

Ended – When the batch job has finished processing, its status will be changed to **Ended**. Note that records in **Ended** status may have ended in error. Refer to [Batch Jobs May End in Error](#) for more information.

Granting Access To Batch Submission

Every batch control must reference an [application service](#). When you link a batch control to an application service, you are granting all users in the group the ability to submit the associated batch job for execution.

FASTPATH: Refer to [The Big Picture Of Application Security](#) for information about granting users access rights to an application service.

When the batch control is added to the batch job table, the system checks if both the user submitting the job and the user ID recorded on the batch submission record have access rights. Application security does not apply when viewing a batch control or an associated batch run.

NOTE: Base batch controls will be associated with base owned application services by default. Implementations will need to ensure the appropriate user groups are linked to these application services.

Batch Job Submission - Main

This page allows you to submit a batch job on-line. Navigate to this page using **Menu > Tools > Batch Job Submission**.

Description of Page

The **Batch Job ID** is a system generated random number that identifies a particular submission.

To submit a batch job, choose the **Batch Code** for the process you wish to submit.

The following parameters are provided with each background process:

Thread Number should typically be set to 0. Refer to [Running Multi-threaded Processes](#) for situations where populating a value other than 0 are warranted.

Thread Count is used to control whether a background processes is run single threaded or in multiple parallel threads. It contains the total number of threads that have been scheduled. For example, if the process has been set up to run in 20 parallel threads, each of the 20 instances receives a thread count of 20. Refer to [Running Multi-threaded Processes](#) for more information about populating this field.

NOTE: Not all processes may be run multi-threaded. Refer to the description of a batch control to find out if it runs multi-threaded.

Batch Rerun Number is only used for background processes that download information that belongs to given run number. It should only be supplied if you need to download an historical run (rather than the latest run).

Batch Business Date is only used for background processes that use a date in their processing. In Oracle Utilities Customer Care and Billing, for example, a billing process can use the business date to determine which bill cycles should be downloaded. If this parameter is left blank, the system date is used at the time the background process is executed.

NOTE: Saving a record on this page does not submit the batch job immediately. A special background process will run periodically to find pending records and submit them. Depending on how often the special process checks for pending records and depending on how many other pending records are in the 'queue', there may be a slight lag in submission time. If the desired execution date/time is close to midnight, it is possible that your batch job will run on the day after you submit it. If you have left the business date blank in this case, keep in mind that your business date would be set to the day after you submit the job.

Override Nbr Records To Commit and **Override Max Timeout Minutes**. These parameters are optional and override each background process's Standard Commit Records and Standard Cursor Re-Initiation Minutes. (Each background process's Standard Commit Records / Standard Cursor Re-Initiation Minutes should be documented in the detailed description of the batch control record). Note that Max Timeout Minutes corresponds to the Cursor Re-initiation Minutes.

FASTPATH: Refer to [Parameters Supplied to Background Processes](#) for more information.

User ID is the user ID associated with the run of the background process. It may differ from the user who submitted the batch, as described below. Refer to [Parameters Supplied to Background Processes](#) for more information about the significance of the user id.

NOTE: This field defaults to the id of the current user.

Language is used to access language-specific control table values. For example, error messages are presented in this language code.

If you wish the system to notify you when the batch job is complete, enter your **Email ID**. Refer to [Email Notification](#) for more information.

NOTE: This field defaults to the email address for the current user, if populated on the [user](#) record.

The **Desired Execution Date/Time** defaults to the current date and time. Override this information if you wish the background process to be executed at some future date and time. Refer to [Submitting Jobs in the Future](#) for more information.

The **Batch Job Status** indicates the current status of the batch job. Refer to [Lifecycle of a Batch Job Submission](#) for more information.

The **Submission Method** indicates how the batch job was initiated. Valid methods include:

- **Online** - populated when a user manually creates or manually duplicates a batch job submission.
- **Generated** - populated by algorithms that submit a batch job and by 'initiator' batch jobs that submit other batch jobs.
- **Scheduled** - populated by the DBMS scheduler. Note that for other schedulers, it is not advised to use this value as there may be logic and validation related to records created with this value that may not apply to other schedulers.
- **Timed** - populated by the batch daemon that submits timed batch jobs.
- **Other** - populated when no other value is provided.

Additional values may be added by your implementation. Refer to the lookup **SUBMIT_METH_FLG** for a list of the submission methods supported by your system.

The **Submission User** indicates who initiated the batch job. This value is not populated for timed batch jobs or batch jobs submitted via a scheduler. It is only displayed if the field is populated.

The **Program Name** associated with the batch control code is displayed.

The following trace parameters may also be supplied to a background process and are only used during QA and benchmarking.

- **Trace Program Start** Turn on this switch if you wish a message to be written whenever a program is started.
- **Trace Program Exit** Turn on this switch if you wish a message to be written whenever a program is exited.
- **Trace SQL** Turn on this switch if you wish a message to be written whenever an SQL statement is executed.
- **Trace Output** Turn on this switch if you wish a message to be displayed for special information logged by the background process.

NOTE: The information displayed when the trace output switch is turned on depends on each background process. It is possible that a background process displays no special information for this switch.

NOTE: The location of the output of this trace information is defined by your system administrator at installation time.

If additional parameters have been defined for this background process on the Batch Control page, the **Parameter Name**, **Description**, **Detailed Description** and an indicator of whether or not the parameter is **Required** are displayed.

If a default parameter value is configured on the batch control configuration, that value is shown and may be overridden. Confirm or enter the appropriate **Parameter Value** for each parameter. Note that if the parameter value is configured to be Encrypted on the batch control configuration, the value here will be shown encrypted.

Once you have entered all the desired values, **Save** the record in order to include it in the queue for background processes.

If you wish to duplicate an existing batch job submission record, including all its parameter settings, display the submission record you wish to duplicate and use the **Duplicate and Queue** button. This will create a new Batch Job Submission entry in pending status. The new submission entry will be displayed.

If you wish to cancel a **Pending** or a **Started** record that does not have the **Scheduled** submission method, use the **Cancel** button. The button is disabled for all other status values.

Tracking Batch Processes

The topics in this section cover the tools provided for reviewing the status and performance of batch processes. Refer to [Defining Batch Controls](#) for more information on how batch control codes are defined.

Batch Run Tree

The batch run tree pages show the execution status of a selected batch process. For a specified batch control id and run id, the tree shows each thread, the run-instances of each thread, and any messages (informational, warnings, and errors) that might have occurred during the run.

Batch Run Tree - Main

This page allows you to view the status of a specific execution of a batch job. Navigate to this page using **Menu > Tools > Batch Run Tree**.

Description of Page

Select a **Batch Control** process and **Batch Number** to view information and statistics on the batch run's "threads". The following points should help understand this concept:

- Many batch jobs cannot take advantage of your hardware's processing power when they are run singularly. Rather, you'll find that a large percentage of the CPU and/or disk drives are idle.
- In order to minimize the amount of idle time (and increase the throughput of your batch processes), we allow you to set up your batch processes so that multiple instances of a given batch job are executed at the same time. For example, in Oracle Utilities Customer Care and Billing when you schedule the **billing** process, you can indicate that multiple parallel instances should be executed (rather than just one instance). You'd do this so that the processing burden of creating bills for your customers can be spread over multiple processes.
- We refer to each parallel execution of a batch process as a "thread".
- Statistics and information messages are displayed in respect of each thread. Why? Because each thread is a separate execution and therefore can start and end at different times.

The **Start Date/Time** and **End Date/Time** of the batch run are shown.

The tree includes a node that displays the total number of records processed for the batch run, the total number of records in error for the batch run and the batch run elapsed time. The elapsed time is the longest elapsed time among the batch thread(s). The message is red if there are any records in error. If the application properties file has been configured with the location of the log files and the log files associated with the batch run are still available, the links **Download stdout** and (if applicable) **Download stderr** are visible. Clicking either link allows you to view or save the log files. Note that the logs here are only related to the processing that occurs before the thread execution.

NOTE: Compression. The log files are compressed and include a *.gz extension. Different browsers treat this type of file differently. Some browsers may automatically decompress the file as part of the download and they are viewable in any text viewer by changing the extension to one the text viewer recognizes. However, some browsers download the compressed file and a user will need to unzip the file prior to viewing.

NOTE: Security Access. The 'download' hyperlinks are only visible for users that have security access to the **Download** access mode for the batch run tree application service.

Within each thread, a node appears for each batch instance for the thread. A thread will only have more than one instance in the case of a thread that ended in error where a user subsequently restarted the run. The **Start Date/Time** and **End Date/Time** of the batch run are shown, if populated.

The messages that appear under a thread instance show the start and end times of the execution instance. If errors are detected during the execution of the thread, these error messages may also appear in the tree. Refer to [Processing Errors](#) for information about the types of errors that appear in the batch run tree.

If the background process has been enabled to create [To Do entries for object specific errors](#), information about the To Do entries are displayed in the tree. This information is not displayed for each thread, but rather all the To Do entries created for the batch run are grouped together. The To Do entries are grouped by their status.

If the log files associated with the batch thread are still available, the links **Download stdout** and (if applicable) **Download stderr** are visible. Clicking either link allows you to view or save the log files. The above notes about file compression and security access for downloads applies to these files as well.

Batch Run Tree - Run Control

By default, if a batch process fails, it will restart. This tab allows you to modify the restart status of a failed run.

Navigate to this page using **Menu > Tools > Batch Run Tree** search for the desired batch control and then navigate to the **Run Control** page.

Description of Page

On the main page, you must select a **Batch Control**, **Batch Number**, and **Batch Rerun Number** to view a tree of the batch run. On this page, the following information is displayed:

- **Last Update Timestamp** contains the date and time the most recent batch run started or completed.
- **Batch Business Date** is the business date that was supplied to the background process (this date is used as the "system date" by the process).

Run Status indicates the status of the batch run. Valid values are: **In Progress**, **Error**, and **Complete**.

If the **Run Status** is **Error**, the system will attempt to restart this run when you attempt to execute the **Batch Control**. In most situations, this is exactly what you want to happen. However, there are rare situations where you do not want the system to execute a given batch run (e.g., if this run is somehow corrupt and you cannot correct the data for whatever reasons). If you want the system to skip the execution of a batch run (and proceed to the next run), turn on **Do Not Attempt Restart**.

Batch Day Tracking

The batch day tracking pages provide information to quickly determine the status and performance of the daily batch workload for a selected business date. The portals contain zones to provide details about run status and individual thread performance to assist in detecting data and performance issues with individual batch runs.

Batch Day Dashboard

This portal provides a high level summary of the status, duration and other details of the batch jobs that ran on a given business date. An implementation may introduce additional zones to this portal as needed.

Use **Menu > Dashboards > Batch Day Dashboard** to navigate to the portal.

Batch Runs By Business Day

This zone provides a summary by business date of the number of batch runs completed, in error, and in progress, together with the earliest start time and latest end time of the jobs on that day. The zone is sorted in descending order by business date.

NOTE: For performance reasons, the zone is configured to restrict the number of rows retrieved by the query. The 'Results' number will indicate how many rows have been retrieved. Use the Next and Previous buttons to retrieve additional dates or return to a prior set of dates.

The following filters are provided:

- **Batch Business Date** allows you to select a particular business date.
- **Process Date** allows you to restrict the batch runs included in the summary to those where the processing date is within the start and end dates for the run.
- **Exclude Reruns** allows you to exclude batch reruns from the summary.

NOTE: The values selected in these filters will be applied as hidden filters to the other zones in the portal.

When a specific business date is broadcast from the summary, the following zones will appear as part of the portal's **Main** tab page.

Batch Day By Status

This zone summarizes the batch runs for the business date by their status, displayed in the form of a pie chart. Selecting a specific slice of data on the chart broadcasts its value to the other zones on the portal allowing them to filter their data accordingly. Use the **Reset** action to reset the filter set by this zone.

Batch Day By Category

This zone summarizes the batch runs for the business date by their batch category, displayed in the form of a pie chart. Selecting a specific slice of data on the chart broadcasts its value to the other zones on the portal allowing them to filter their data accordingly. Use the **Reset** action to reset the filter set by this zone.

Batch Jobs Summary

This zone displays details of the individual batch runs for the broadcast business date. The zone is sorted by batch control, batch run number and batch rerun number.

NOTE: For performance reasons, the zone is configured to restrict the number of rows retrieved by the query. The 'Results' number will indicate how many rows have been retrieved. Use the Next and Previous buttons to retrieve additional rows or return to a prior set of rows.

The following filters are provided:

- **Batch Control** allows you to select a particular batch control to review. This filter supports wildcard searching.
- **From Start Date/Time** restricts the batch runs displayed to those where the start date time is on or after this date and time.
- **To Start Date/Time** restricts the batch runs displayed to those where the start date time is on or before this date and time.
- **From End Date/Time** restricts the batch runs displayed to those where the end date time is on or after this date and time.
- **To End Date/Time** restricts the batch runs displayed to those where the end date time is on or before this date and time.
- **Batch Control Type** restricts the batch runs displayed to the selected type.

The following columns are displayed initially:

- **Batch Control** is the batch control ID of the batch run.
- **Description** is the description of the batch control. Click the hyperlink to navigate to the [Batch Run Threads](#) portal.
- **Batch Run** is the run number of the batch job. Click the hyperlink to navigate to the [Batch Run Tree](#).

- **Status** is the status of the batch run.
- **Start Date/Time** is the start time of the run.
- **End Date/Time** is the end time of the run. The current date and time may be displayed if the batch job is still in progress.
- **Duration** is the time taken for the run, formatted as Days:Hours:Minutes:Seconds.
- **Threads** is the total threads for the batch run.

Click the **Column Configuration** icon  in the zone header to show the [Column Configuration Area](#) in which additional columns can be added to the results. The additional columns include the following:

- **Batch Category** is the category of the batch run.
- **Batch Control Type** is the type of the batch run.
- **Do Not Attempt Restart** indicates whether the run has been marked not to be restarted.
- **Rerun Nbr** is the rerun number of this batch job.

Batch Run Threads

This portal provides details and analysis of the threads for a given batch run. It is accessed via a link from the batch jobs summary zone on the [Batch Day Dashboard](#). An implementation may introduce additional zones to this portal as needed.

The following zones will appear as part of the portal's **Main** tab page

- **Thread Summary.** This zone displays details of the individual threads for the batch run in context. It can be filtered by thread status.
- **Threads by Status.** This zone displays a count of the number of threads by status for the selected batch run, in the form of a pie chart.
- **Threads by Volume.** This zone displays a count of the records processed and records in error for each thread in the selected batch run, in the form of a bar chart.
- **Threads by Elapsed Time.** This zone displays the elapsed time for each thread in the selected batch run, in the form of a horizontal bar chart.
- **Threads by Records Per Second.** This zone displays the number of records processed per second for each thread in the selected batch run, in the form of a horizontal bar chart.

The Big Picture of Requests

Requests enable an implementer to design an ad-hoc batch process using the configuration tools.

An example of such a process might be to send an email to a group of users that summarizes the To Do entries that are assigned to them. This is just one example. The request enables many types of diverse processing.

Request Type Defines Parameters

For each type of process that your implementation wants, you must configure a request type to capture the appropriate parameters needed by the process.

Previewing and Submitting a Request

To submit a new request, go to **Menu > Tools > Request** in add mode. You must select the appropriate request type and then enter the desired parameter values, if applicable.

After entering the parameters, the following actions are possible:

- Click **Save** to submit the request.
- Click **Cancel** to cancel the request.
- Click **Preview** to see a sample of records that satisfy the selection criteria for this request. This information is displayed in a separate map. In addition, the map displays the total number of records that will be processed when the request is submitted. From this map you can click **Save** to submit the request, **Back** to adjust the parameters, or **Cancel** to cancel the request.

When a request is saved, the job is not immediately submitted for real time processing. The record is saved with the status **Pending** and a monitor process for this record's business object is responsible for transitioning the record to **Complete**.

As long as the record is still **Pending**, it may be edited to adjust the parameters. The preview logic described above may be repeated when editing a record.

The actual work of the request, such as generating an email, is performed when transitioning to **Complete** (using an enter processing algorithm for the business object).

To Do Summary Email

The base product includes a sample request process that sends an email to users that have incomplete To Dos older than a specified number of days.

The following configuration tasks are required to use this process:

- Define an Outbound Message Type. The business object usually defined for the Outbound Message Type is **F1-EmailMessage**.
- Define an External System that contains the Outbound Message Type in one of its steps. In the configuration determine if the communication is through SOA, batch, or real-time processing method when sending the email notification. Refer to [Outbound Messages](#) for more information about configuration needed for the different processing methods.
- Create a Request Type that includes the Outbound Message Type and the corresponding External System.
- Create a Request for the created Request Type.

Defining a New Request

To design a new ad-hoc batch job that users can submit via Request, first create a new Request Type business object. The base product BO for request type, **F1-TodoSumEmailTyp**, may be used as a sample.

The business object for the request includes the functionality for selecting the records to process, displaying a preview map for the user to review, and for performing the actual processing. The base product BO for request, **F1-TodoSumEmailReq**, may be used as a sample. The following points highlight the important configuration details for this business object:

- Special BO options are available for request BOs to support the Preview Request functionality.
 - **Request Preview Service Script**. This script retrieves the information that is displayed when a user asks for a preview of a request.
 - **Request Preview Map**. This map displays the preview of a request.

- The enter algorithm plugged into the Complete state is responsible for selecting the records that satisfy the criteria and processing the records accordingly.

Setting Up Request Types

Use the Request Type portal to define the parameters to capture when submitting a request. Open this page using **Admin > General > Request Type**.

This topic describes the base-package zones that appear on the Request Type portal.

Request Type List. The Request Type List zone lists every request type. The following functions are available:

- Click a **broadcast** icon to open other zones that contain more information about the request type.
- Click **Add** in the zone's title bar to add a new request type.

Request Type. The Request Type zone contains display-only information about a request type. This zone appears when a request type has been broadcast from the Request Type List zone or if this portal is opened via a drill down from another page. The following functions are available:

- Click **Edit** to start a business process that updates the request type.
- Click **Delete** to start a business process that deletes the request type.
- Click **Deactivate** start a business process that deactivates the request type.
- Click **Duplicate** to start a business process that duplicates the request type.
- State transition buttons are available to transition the request type to an appropriate next state.

Please see the zone's help text for information about this zone's fields.

Maintaining Requests

Use the Request transaction to view and maintain pending or historic requests.

Open this page using **Menu > Tools > Request > Search**. This topic describes the base-package portals and zones on this page.

Request Query. Use the query portal to search for an existing request. Once a request is selected, you are brought to the maintenance portal to view and maintain the selected record.

Request Portal. This portal appears when a request has been selected from the Request Query portal. The following base-package zones appear on this portal:

- **Actions.** This is a standard actions zone.
- **Request.** The Request zone contains display-only information about a request. Please see the zone's help text for information about this zone's fields.
- **Request Log.** This is a standard log zone.

Attachments

Some implementations may require that attachments be available from the application. These attachments can be stored in the Attachment table and then linked to other objects if applicable.

Attachment Overview

The following topics provide additional information regarding attachment functionality.

Attachment Types

The system supports several different attachment content types, for example:

- PDF Document
- Excel Spreadsheet
- Jpeg Image
- Text Document

The attachment data itself may be text or binary. When storing the data in the application however, it is stored as text information only. As a result, the upload of an attachment that is a binary type requires a conversion prior to storing the data. When viewing the attachment, the data is converted again for display.

Each type of attachment is defined using an attachment business object. The business object includes configuration defining the supported file extensions, whether the data is binary or not and the content type that represents the type of data for the attachment.

NOTE: To view the attachment business objects provided with the base product, navigate using **Admin > System > Business Object > Search** and search for business objects related to the Maintenance Object for Attachments (**F1-ATCHMT**).

Owned Attachments

Attachments can be either 'owned' or 'common'. An owned attachment is one that is related to a specific record. For example, the specific test results for a given device can be uploaded and linked to that device or to its test records. These types of attachments are typically uploaded and maintained via the object that owns it.

Common Attachments

Common attachments are ones that are uploaded independent of any transaction in the system. They can be used for general system or company information. Or they can be linked to more than one transaction. For example, instructions for performing a certain type of task can be uploaded as an attachment and linked to a task type where those instructions are relevant. These types of attachments are uploaded and maintained in the central Attachment portal. Objects that may refer to the attachments may link the attachments via characteristics or some other appropriate mechanism.

Emailing Attachments

The system supports a business service that may be used by system processing to send an email. The business service **F1-EmailService** supports receiving the IDs of one or more attachments as input parameters.

Refer to [Sending Email](#) for more information.

External Reference

Attachment records may be added from an external system in which case, the external system could have a reference ID to capture. The attachment allows for including an external reference ID when adding an attachment internally.

Malware Scan

The system provides a plug-in spot where you can configure a step to scan attachment for malware. If an algorithm is provided, it is called every time attachment content is added.

Configuring Your System for Attachments

In order to link attachments to objects in the system, there may be some configuration or implementation required to support the link. It is possible that one or more objects in your product already support attachments out of the box. Consult the product documentation for the specific object for confirmation. For objects in the system that do not support attachments out of the box, the following sections provide some guidelines for enabling support for attachments. Contact product support for more information.

Supporting Common Attachments

The attachments themselves are created / uploaded using the attachment portal. Refer to [Maintaining Attachments](#) for more information.

If your implementation has a use case where one or more common attachments may be linked to an object (and the object does not already support this functionality), the object may need to be extended to capture the attachments.

- If the object includes a characteristic collection, this is a recommended way to capture attachments. A characteristic type should be defined for each type of attachment. The characteristic type should be a foreign key type and should reference the Attachment FK reference. The characteristic entity collection should include the object that the common attachment will be linked to.
- Most characteristic collections are sequence based characteristics and would support multiple entries for the same characteristic types, if multiple attachments are applicable.
- If the object to support the attachments is governed by a business object, the implementation must extend the business object to define one or more appropriate elements used to capture the attachments. If only one attachment of a certain type is allowed, a single flattened characteristic may be used. If multiple attachments of a certain type are allowed, the BO schema may define a “flattened list” exposing the sequence and the characteristic type.
- If the object is maintained on a “fixed page” with a generic characteristic collection, no additional configuration is needed to allow users to link attachments to that object.

Supporting Owned Attachments

When creating an attachment for a specific record, the attachment itself captures the information about the related record, namely its maintenance object code and its primary key. For these types of attachments, no configuration is needed on the related business object to capture the attachments, as was the case with common attachments.

However, it is recommended to configure the user interface of the related object so that the owned attachments can be viewed and maintained from that page. To do this, you may use the generic attachment zone provided by the product: **F1-ATTCHOWN**.

Note that your product may already have support for viewing and maintaining owned attachments on one or more of its base delivered portals.

Configuring Size Limit

The system allows for configuration of a size limit for uploading attachments. This is optional but the recommendation is to set this to a reasonable value so as to limit the ability to upload unreasonably big files. To configure this, navigate to [Feature Configuration](#). Search for an existing feature configuration with the Feature Type **General System Configuration**. If one does not exist, create a feature configuration of this type. Select the **Maximum Attachment Size** option and define an appropriate value.

Defining a New Attachment Type

As mentioned, the product provides support for several content types. If your implementation needs to support attachments for a content type not currently supported, create a new business object copying the configuration of an existing attachment business object.

Configure the following option types for the BO:

- **Binary** indicates whether the attachment data must be converted from binary format. Binary attachments are stored in the database as text, and are then converted back to the original format when retrieved.
- **Content Type** represents the browser's mime type of the attachment.
- **Supported File Extension** specifies the valid file extensions for the content type.

Once the business object is defined, it is ready for use.

Supporting File Name Exceptions

By default, the system prevents attachment file names from having special characters. If there is some reason that an implementation needs to define an attachment with special characters, there is a system property setting that may be configured to relax this validation. Contact your system administrator for support.

Enabling Malware Scan

The product provides a malware scan algorithm in the base product that uses ClamAV. ClamAV itself is not provided as part of the product. To use the base algorithm, your implementation needs to get ClamAV and define system properties for the host and port where ClamAV may be called. The algorithm, called **F1-ATCHM-WS** should be plugged into the [installation options - algorithms](#) collection using the system event **Attachment Malware Scan**

If your implementation wants to use a different algorithm for malware scanning, you may deliver your own algorithm and plug it into the installation algorithm collection.

Maintaining Attachments

This section describes the functionality supported for viewing and maintaining attachments.

Navigate using **Admin > General > Attachment**. You are brought to a query portal with options for searching for common attachments.

Once an attachment has been selected, you are brought to the maintenance portal to view and maintain the selected record.

NOTE: The base search options for the attachments query only support searching for common attachments. Owned attachments may also be viewed on the attachment maintenance portal, but a user may only drill into the attachment maintenance from the maintenance portal of the “owning” entity.

The Attachment zone provides basic information about an attachment, including the ability to upload the file and to view an uploaded file. Viewing an attachment will typically launch a download of the attachment file, following standard browser behavior.

Adding Attachments

Common attachments may be added from the attachments portal (or via the standard menu path). In addition, your product may support attachments associated with specific records (“entity owned attachments”) which may also provide the capability to add attachments.

In both cases, when adding an attachment, you are prompted for the file to upload. Once the file is chosen, the system determines the appropriate business object to associate with the attachment based on the file extension. Typically one and only one business object is found at which point you are prompted to provide the Attachment Name. (Your specific product may also require additional information at this time). Fill in the details and save.

Please note the following:

- If no business object is found for the uploaded file’s file type, an error is issued. This type of file is not currently supported as an attachment.

- If multiple business objects are found, the user must choose the appropriate one. This should be rare.

Monitoring and Analytics

This chapter describes various tools provided in the product to support system monitoring including tools related to reporting, monitoring and analytics.

Reporting Tool Integration

This section describes how to configure your third party reporting tool and how to define your reports in the system to enable users to submit reports online.

The Big Picture Of Reports

The topics in this section describe the approach for designing and defining your system reports. Note that the product includes an out-of-the-box integration with BI Publisher. However it is possible to use the reporting objects to integrate with a different third party tool.

Integration with BI Publisher

Your DBMS, your product, and BI Publisher can work together to produce reports. You may choose to use a different reporting tool, but this may not be a trivial effort. This section provides high-level information about some of the business requirements that are being solved with the reporting solution.

Multi-Language and Localization Support

The integration supports a multi-language implementation and supports different localization settings.:

- All labels, headings and messages are defined using field and message meta-data in the application, which support multiple languages.
- The appropriate font, size, and layout are based on the requested report and the user's language.
- Dates and numbers are formatted as per the user's display profile.
- Currency based numbers are formatted as per the currency definition from the product

Requesting Reports from The System

Although reports are rendered in your reporting tool, users must be able to request ad-hoc reports from within the system (assuming users have the appropriate security access).

- The prompts for the input parameters must be shown in the user's language
- Users should be able to use the standard search facilities to find parameter values
- Plug-ins can be optionally used to cross-validate input parameters
- Application security must authorize ad-hoc report requests

Overview of the Data - BI Publisher

The following diagram provides an overview of where data is stored for your reports for integration with BI Publisher.

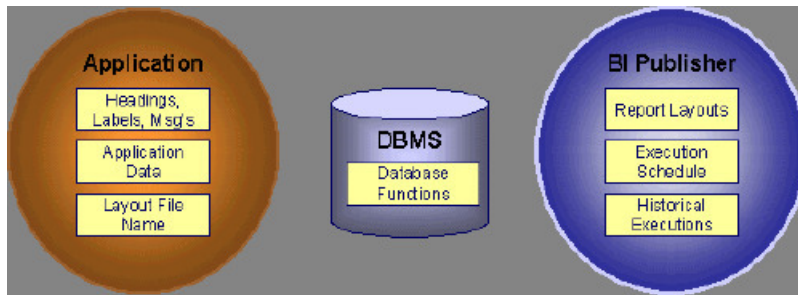

Figure 5: Application and BI Publisher

The application contains:

- The application data that appears on your reports.
- The language-specific headings, labels and messages on your reports.
- The layout file name to be used for the report.

BI Publisher contains:

- How your reports look.
- Information about scheduled reports and reports that have already run.

The DBMS contains the SQL used to retrieve the data on your reports (residing in database functions).

NOTE: BI Publisher can be configured to retrieve data via a service call. Because every business object can be read via a service call, elements that reside in an XML based column can be displayed on reports produced using BI Publisher. See your product's *Installation Guide* or *Optional Products Installation Guide* for information on this configuration.

How To Request Reports

A user may request an ad hoc report from within your product:

- A [report submission](#) page enables a user to choose the desired report and enter the parameter values for the report
- The user must be granted security access to the report
- The request is passed to the reporting tool real time. Refer to [Configure The System to Invoke BI Publisher](#) for more information.
- The reporting tool generates the report and displays it in a new browser window

The reporting tools' scheduler creates reports (as per your schedule). This function is entirely within the reporting tool. No scheduling functions reside within your product.

A user can request an ad-hoc report from within the reporting tool. Note, the user's ID must be supplied as a parameter to the report in order for the user's profile to be used to format dates and numbers

Viewing Reports

As described above, ad-hoc reports requested from within your product are displayed immediately after they are generated in a new browser window

If your reporting tools supports it, the [Report History](#) page may be configured to open tool's report execution history page and request a view of this report.

NOTE: The [Report History](#) page currently does not display historical reports for BI Publisher.

Configuring The System To Enable Reports

Configuring BI Publisher Reports

This section contains topics specific about configuring the product to interoperate with BI Publisher.

Configure the System to Invoke BI Publisher Real-time

The base product provides an [installation algorithm](#) plug-in spot called Reporting Tool. This plug-in spot should contain an algorithm that invokes the third party reporting tool real-time.

For BI Publisher, the system provides an algorithm type called **F1-BIPR-INV**, which invokes BI Publisher.

These algorithms rely on information defined in the [Reporting Options](#) table: the reporting server, reporting folder and the user name and password for accessing the reporting tool. The values in the reporting options should have been set up when the system was installed. Contact your system administrator if there are any problems with the values defined on the reporting options.

To use the algorithm types to invoke BI Publisher, perform the following steps:

- Create an [algorithm](#) for the appropriate algorithm type.
- On the [installation options](#), add an entry to the algorithm collection with an algorithm entity of **Reporting Tool** and indicate the algorithm created in the previous step.

Batch Scheduling in BI Publisher

For many of your reports, you probably want the report to be produced on a regular basis according to a scheduler. The reporting solution relies on the BI Publisher software to provide the batch scheduler functionality. Refer to BI Publisher documentation for details about configuring the batch scheduler.

Defining Reporting Options

The reporting options are provided as a mechanism for defining information needed by your reporting solution. The base product uses the reporting options to define information needed to access the reporting tool from within the system using the algorithm defined on the installation option.

Navigate to this page using **Admin > Reporting > Reporting Options**.

Description of page

Reporting Folder defines the shared folder where reports are stored.

Reporting Server From Browser defines the URL of the web application where the reporting tool is installed. For example, using BI Publisher, the format is: `http://<BI Publisher Server>:<port>`.

NOTE: Customize Options. The reporting options are customizable using the Lookup table. This field name is **RPT_OPT_FLG**. The reporting options provided with the system are needed to invoke the reporting tool. If your implementation requires other information to be defined as reporting options, use the lookup table to define additional values for the reporting option flag.

Where Used

This information is used by the reporting tool algorithm on the [installation option](#) to invoke the reporting tool software.

Implementations may use reporting options to record other information needed for their reporting tool.

Defining Report Definitions

For each report supplied by your installation, use the report definition page to define various attributes of the report.

Report Definition - Main

Navigate to this page using **Admin > Reporting > Report Definition**.

CAUTION: Important! If you introduce new report definitions, you must prefix the report code with **CM**. If you do not do this, there is a slight possibility that a future release of the application could introduce a new system report with the name you allocated.

Description of page

Enter an easily recognizable **Report Code** and **Description** for each report. Use the **External Reference ID** to define the identifier for this report in your external reporting tool.

Define an [application service](#) to enable users to request submission of this report online or to view report history for this report. Once you define an application service for each report, use [application security](#) to define which users may access this report.

NOTE: Access Mode. The access mode for application services related to reports must be set to **Submit/View Report**.

If you have more than one parameter defined for your report and you wish to perform cross-validation for more than one parameter, provide an appropriate **Validation Algorithm**.

Enter a **Long Description** to more fully describe the functionality of this report. This information is displayed to the user when attempting to submit the report online or when viewing history for this report.

For BI Publisher, if you want to use one of the sample reports provided by the system, but with a different layout, indicate the layout to use for the report in the **Customer Specific Font/ Layout** field and BI Publisher uses this information instead. The name for base report layout is <report code>_Base. For example, a base layout for CM_TODO is named CM_TODO_Base.

Report Definition - Labels

Navigate to this page using **Admin > Reporting > Report Definition** and go to the **Labels** tab.

NOTE: Company name and logo. Note the company name used as a title in the sample reports is defined as a message on the [installation options](#). For information about installing the company logo, refer to your product's *Installation Guide* or the *Optional Products Installation Guide*.

Description of Page

In order to provide multi-language capability for each report, the labels used for the report must support multiple language definitions. For each label used by your report, indicate a unique **Sequence** and the **Field** used to define the **Label**. The label defined here should be the same label that is defined in your report layout defined in the external reporting tool.

When rendering an image of the report, the external reporting tool retrieves the appropriate label based on the language used for the report.

Report Definition - Parameters

Navigate to this page using **Admin > Reporting > Report Definition** and go to the **Parameters** tab .

Description of Page

The **Parameters** scroll contains one entry for every parameter defined for the report. The following fields display:

Parameter Code is the identifier of the parameter. This must correspond to the parameter definition in the reporting tool.

Required indicates that a value for the parameter must be defined when submitting the report.

Sort Sequence must match the parameter order defined in the reporting tool's report. It is also used when displaying the list of parameters on the [report submission](#) page.

Characteristic Type indicates the characteristic type used to define this parameter.

Default Value is option and if populated is displayed to the user when the report is chosen on the [report submission](#) page.

Description is a brief description of the parameter. This description is used when displaying the parameter on the [report submission](#) page.

Long Description is a detailed description of the parameter. This description is used on the [report submission](#) page when the user requests more information for a given parameter.

Sample Reports Supplied with the Product

Depending on your specific product, there may be sample reports provided that your organization may use as they are or as a starting point for creating a [new report](#). The following sections provide an overview of the sample reports along with instructions on how to use one of the sample reports in your implementation environment.

How to Use a Sample Report Provided with the System

If you would like to use any of the sample reports, you need to perform some steps to be able to execute them in an implementation environment. This section walks you through the steps needed.

Steps Performed at Installation Time

Refer to the *Installation Guide* or *Optional Products Installation Guide* for instructions for setting up and configuring your product and reporting tool to use the sample reports provided with the system. The following steps are described there.

- Setting up the stored procedures used by the sample reports.
- Defining the company title and logo used by the sample reports. Note the company name used as a title in the sample reports is defined as a message on the [installation options](#).
- Defining a user for integration with your product.
- Publishing the sample reports in BI Publisher.

Contact your system administrator to verify that the above steps have occurred.

How To Define A New Report

Use a Sample Report as a Starting Point

- Make a copy of the report and save it in an appropriate directory. Prefix the new report name with **CM**.
- Review the stored procedure(s) used for this report. Refer to the installation guide for information about where the stored procedures should be defined. If you want to change the data that is being accessed, copy the stored procedure, prefixing the new stored procedure with **CM**. Make the appropriate changes in the new version of the stored procedure. Contact your database administrator to find out the procedure for creating a new stored procedure.

NOTE: Performance considerations. When designing a stored procedure, you must consider the performance of the report when executed. Consult your database administrator when designing your database access to ensure that all issues are considered.

NOTE: Defining Messages. The stored procedures provided with the system use messages defined in message category 30. If your new stored procedures require new messages, use message category 90000 or greater, which are reserved for implementations.

- Review the parameters used by the report. Make appropriate changes to the parameters required by the report. This affects how you define your report. Refer to [Designing Parameters](#) for more information.
 - Determine whether or not you require cross validation for your report parameters. If any cross validation is necessary, you should design an appropriate validation algorithm to be executed when requesting a report in your product. Refer to [Designing Validation Algorithms](#) for more information.
-

NOTE: Cross Validation for On-line Submission Only. The cross validation algorithm is only executed for ad-hoc report submissions via your product. If you submit this report through your reporting tool, this algorithm is not executed.

- Review the labels used by the report. Labels and other verbiage are implemented in the sample reports using a reference to the field table in the system. This enables the report to be rendered in the appropriate language for the user. For any new report label you require, you must define a new field entry. Refer to [Designing Labels](#) for more information.
- Review the layout of the report and make any desired changes based on your business needs.

When you have finished designing and coding your new report in your reporting tool, you must do the following in order for it to be usable:

- Publish the report in BI Publisher. Refer to the documentation for this products for details about publishing a report. Refer to [Publishing Reports in BI Publisher](#) for configuration information specific to publishing a report for integration with your product.
- Define the report. Refer to [Designing Your Report Definition](#) for more information.

Publishing Reports in BI Publisher

Please refer to the documentation for BI Publisher for more information about publishing a report in this system. The remaining topics in this section provide information about settings needed to ensure that the report is accessible using BI Publisher.

BI Publisher Database Access

When publishing a report in BI Publisher, you are asked for database logon information. The logon user name and password must be the user name and password that has access to the database functions related to this report in your database.

Verify BI Publisher User Access Rights

To verify the user's access rights to folders in BI Publisher:

- Open the BI Publisher Enterprise Security Center.
- Check that the role for the user has access to the appropriate report folders.

For more information, refer to the "Understanding Users and Roles" section in the Oracle Business Intelligence Publisher User's Guide.

Designing Your Report Definition

When adding a new report, you must define it in the system to allow users to request ad-hoc reports from on-line and to take advantage of the multi-language provisions in the system. The following topics illustrate the steps to take to correctly configure your report definition.

Designing Main Report Definition Values

Refer to field description section of the [report definition](#) main page for information about defining general information about the report.

For the validation algorithm, preliminary steps are required. Refer to [Designing Validation Algorithms](#) for more information.

For the application service, preliminary steps are required. Refer to [Designing Application Services](#) for more information.

Designing Characteristic Types

The parameter tab on the report definition page uses [Characteristic Type](#) to define the report parameters. For each report parameter that you plan to use, you must define a characteristic type.

You do not need a unique characteristic type for each report parameter. For example, if Start Date and End Date are parameters your report, only one **Report Date** characteristic type needs to be defined. This characteristic type would be used on both date parameters.

Each characteristic type to be used as a report parameter must indicate a characteristic entity of **Report**.

To illustrate the characteristic type definitions, let's look at the sample report Tax Payables Analysis. It needs the following parameters: From Date, To Date, GL Account Type Characteristic Type and Account Type value.

NOTE: Account Type Parameters. The tax payables report must find general ledger entries that have posted to a certain distribution code. In order to find the appropriate distribution code, the report expects each distribution code to be defined with a characteristic indicating its GL account type (for example, **Revenue**, **Asset**, etc.) The report needs to know the characteristic type used to define this entry.

To support the required parameters, the following characteristic types are needed.

Char Type	Description	Type	Valid Values	Char Entities
CI_DATE	Date Parameter	Ad-hoc	(Uses validation algorithm to validate proper date entry)	Report
CI_CHTYP	Characteristic Type	FK Reference	CHAR_TYP	Report
CI_GLTY	GL Account Type	Pre-defined	A- Asset, E- Expense, LM- Liability/miscellaneous, LT- Liability/taxes, R-Revenue	Distribution Code, Report

Highlights for some of the above settings:

- We have defined a characteristic type for defining a characteristic type. This is to allow the user to indicate which Char Type on the Distribution Code is used for the GL account type. This is an FK reference type of characteristic.
- The GL account type characteristic type is referenced on both the Distribution Code entity and the report entity.

Designing Parameters

Your report definition parameters collection must define a unique parameter entry for each parameter sent to the reporting tool. The sequence of your parameters must match the sequence defined in your reporting tool.

Continuing with the Tax Payables Analysis report as an example, let's look at the parameter definitions.

Parameter Code	Description	Char Type	Default Value
P_FROM_DT	From Date	CI_DATE	N/A
P_TO_DT	To Date	CI_DATE	N/A
P_CHAR_TYPE	Account Type Characteristic	CI_CHTYP	CI_GLTY
P_TAX_ACCTY_CHAR	Account Type Char Value for Tax Related GL Account	CI_GLTY	LT-Liability/taxes

Highlights for some of the above settings:

- The from date and to date parameters use the same characteristic type.
- The characteristic type parameter is defined with a default value pointing to the GL account type characteristic type.
- The GL account type parameter defines the liability/taxes account type as its default value.

NOTE: User Id. The sample reports provided by the system pass the user id as the first parameter passed to the reporting tool. It does not need to be defined in the parameter collection for the report.

Designing Validation Algorithms

When designing your report definition, determine if cross validation should occur for your collection of parameters. In the Tax Payables Analysis report, there are two date parameters. Each date parameter uses the characteristic type validation algorithm to ensure that a valid date is entered. However, perhaps additional validation is needed to ensure that the start date is prior to the end date. To do this, a validation algorithm must be designed and defined on the report definition.

The system provides a sample algorithm **RPTV-DT** that validates that two separate date parameters do not overlap. This algorithm should be used by the Tax Payables Analysis report.

If you identify additional validation algorithm, create a new [algorithm type](#). Create an [algorithm](#) for that algorithm type with the appropriate parameter values. Plug in the new validation algorithm to the appropriate report definition.

Designing Application Services

[Application services](#) are required in order to allow a user to submit a report on-line or to view history for a report. Define an application service for each report and define the user groups that should have submit/view access to this report.

Update [report definition](#) to reference this application service.

Designing Labels

The system supports the rendering of a report in the language of the user. In order to support a report in multiple languages, the verbiage used in the report must be defined in a table that supports multiple languages. Some examples of verbiage in a report include the title, the labels and column headings and text such as "End of Report".

The system uses the [field](#) table to define its labels.

NOTE: Report Definition. This section assumes that your new report in the reporting tool has followed the standard followed in the sample reports and uses references to field names for all verbiage rather than hard-coding text in a single language.

For each label or other type of verbiage used by your report, define a field to store the text used for the verbiage.

- Navigate to the field page using **Admin > System > Field**.
- Enter a unique **Field Name**. This must correspond to the field name used in your report definition in the reporting tool and it must be prefixed with **CM**.
- Define the **Owner** as **Customer Modification**.
- Define the **Data Type** as **Character**.
- **Precision** is a required field, but is not applicable for your report fields. Enter any value here.
- Use the **Description** to define the text that should appear on the report.
- Check the **Work Field** switch. This indicates to the system that the field does not represent a field in the database.

Update the [report definition](#) to define the fields applicable for this report in the **Labels** tab.

If your installation supports multiple languages, you must define the description applicable for each supported language.

Service Health Check

The system provides a plug-in spot on [Installation](#), called Health Check. The algorithms plugged in here are used to check various system conditions and return details to help assess the health of the system.

What Information is Checked?

Each algorithm is responsible for checking one type of health check condition. The condition should be defined as a valid health component type (as defined in the **HEALTH_COMP_FLG** lookup). The algorithm may check conditions across many records (referred to as Health Components) and return a status and details for each health component. For example, if the algorithm is checking the level of service for batch programs in the system, the batch control is the health component in this case. The algorithm should gather the level of service results for each batch program and return the collection of information to the calling program.

The algorithms for the plug-in spot should return the following information for each health component.

- The **Health Component Detail** should be populated with information specific to the object that was checked. For example, if the algorithm is checking batch control level of service, this will have the Batch Control code. In addition, for enabling display for details of each health component type, the algorithm should populate the maintenance object code and primary key field and value details along with the navigation option.
- The **Health Component Status Flag** and **Health Component Status Description** should be populated with a valid status code and description appropriate for the condition being checked. This information could differ based on the health component type as each health component type may have its own unique status values.
- The **Health Component Status Reason** is meant to provide supporting information about the health component's status value. For example, if the component provides an error type of status, this could have the status reason.
- The **Health Component Response** is used to map the status value of the health component to a standard value defined in the lookup **HEALTH_RESPONSE_FLG**. The values are a subset of HTTP response codes. The supported values are **All Checks Successful** (200); **Non-Critical Function Degraded** (203), **No Content** (204) and **One or More Critical Functions Degraded** (500).
- The **Response Details** list is provided for health components that check several conditions as part of the health check. Each condition could return its own status. In this situation, the algorithm should use the response details list to record the individual responses and populate the overall Health Component Status Flag, Description and Reason with summary information. The suggestion is to do the following:
 - Set the status flag and response based on the details of the individual responses. Refer to the batch level of service information below for an example of this logic.

- When the response list is populated, the health check user interface will show the overall Status Reason text along with an icon to expand the details. The suggestion is to populate this field with text like "See Results for Details".

The system provides an algorithm that checks the **Batch Level of Service** health component type. This health component type finds all the batch controls that are configured with at least one [level of service](#) algorithm and invokes the algorithms for each batch control. The business service populates the output for this health service for each batch control as follows:

- The **Health Component Detail** is populated with the Batch Control code and description. In addition, the navigation information for being able to drill into the batch control are provided and used to build the column as hypertext.
- The **Status** is populated based on whether the batch control has one algorithm or multiple. If there is one algorithm, the Level of Service lookup value returned by the algorithm is returned. If there are multiple, the system determines an overall status based on the detailed status values from each algorithm. If any algorithm returns Error, that value is returned. Otherwise, if any return a Warning, that value is returned. Otherwise Normal is returned.
- The **Status Reason** is populated based on whether the batch control has one algorithm or multiple. If there is one algorithm, the expanded text of the status reason returned by the algorithm is returned. If there are multiple, the text from message category / message number 11002 / 22001 is returned (**See Results for Details**)
- The **Response** is populated based on the value of the overall Level of Service status. It is set to **All Checks Successful** (200) when the Level of Service is **Normal** or **Disabled**; **Non-Critical Function Degraded** (203) when the Level of Service is **Warning** and **One or More Critical Functions Degraded** (500) when the Level of Service is **Error**.

How are the Algorithms Called?

These algorithms are called by a business service provided by the product **F1-HealthCheck**.

That service calculates an overall Health Response value based on all the details returned by all the algorithms. The values described above for the **HEALTH_RESPONSE_FLG** are the ones used.

Also note that the system provides [Inbound Web Services](#) for this business service for both SOAP and REST service calls allowing external systems to use a web service to retrieve this information.

Health Check Configuration

To enable your system to display health check information, navigate to the [Installation Options - Algorithms](#) collection and add an entry for the **Health Check** system event for each health check algorithm provided by the product that your product would like to include in your system health check assessment.

Viewing Health Check Results

The product provides a portal that allows a user to view the detailed results of the [health check](#) business service.

Navigate using **Admin > System > Health Check** to view this portal.

The zone on the portal displays the following:

Overall Response is the HTTP response code returned by the business service.

The grid displays the detail of each individual component checked as part of the system health check. Refer to [Service Health Check](#) for more information about the details returned.

Introducing Health Check Conditions

If your implementation would like to check a condition for system health that is not already provided by your product, here are the steps required:

- Define a new value in the Health Component Type lookup (**HEALTH_COMP_FLG**).

- Provide a new algorithm type, plug-in script and algorithm for the Health Check system event that checks the condition that you wish to check. Refer to the [Service Health Check](#) topic for the information that each algorithm should be supplying for the condition. Note that if you follow the pattern of the system delivered Batch Control - Level of Service algorithm, your algorithm may be designed to check conditions across many records of the same type and gather all the results.
- Plug this new algorithm into the [Installation Options - Algorithms](#) collection using the **Health Check** system event.

Measuring Performance

Many implementations need the ability to track and view the performance of key system processes against a defined target level. The framework provides objects to allow an edge product or an implementation to calculate and display performance measures against a desired target for one or more use cases. The topics in this section provide information about what is supplied in the framework and guidelines for implementing a specific use case for batch processes. Your product may supply out of the box support for additional use cases. Refer to your product documentation for more information.

Understanding Performance Targets

The following are examples of use cases that would be well suited for tracking as performance targets:

- Track and view the duration of key batch processes, either individually or as a group, and how they relate to a defined target.
- Monitor used and free space on a database against critical levels.
- Check the performance of individual user interface zones against a defined performance expectation
- Compare the number of web service requests made to an application against a threshold where performance may be of concern.

Framework provides functionality to define and categorize performance targets and link them to objects such as business services, zones and portals. This supports the calculation and display of the metrics against desired results.

In addition, Framework supplies out of the box support for batch process performance targets. Individual edge applications may supply more specific functionality for other use cases, if applicable.

Ideally, users should have the ability to view these performance targets on a dashboard that groups related measures. Framework provides the necessary components to achieve this for batch process performance targets.

The following sections highlight functionality supported for performance targets in the framework. Refer to the edge application product documentation for more details of other supported use cases.

Performance Target Objects Overview

The setup of a performance target involves a unique combination of configuration data and processing logic that calculates and displays a specific measure.

The framework performance target functionality is supported by a combination of inter-related objects, as shown below. Some of these objects will be generic for use in all performance targets while some are specific to a functional area such as batch processes.

- **Maintenance Objects** for capturing performance target types and performance target instances.
- **Extendable Lookups** to define performance target categories and performance target metrics.
- **Business Services** to calculate known metrics for a group of performance targets, such as for batch processes.
- **UI Maps** to interpret the performance calculation results and display them in charts that show the comparison to the target.

- A **Zone** that serves as a template for system duplication to create specific zones related to each performance target. The zone invokes a business service to perform calculations and display performance measures in the related UI map.
- **Business Objects** to capture configuration data for a specific performance target instance and its related objects.
- Functionality to create **Zone instances** for specific performance targets based on the associated template zone.

Each edge application will deliver the following to compliment the objects delivered by the framework:

- **Portals** to group related performance target zones.
- Specific entries for the performance target category **Extendable Lookup** .

The following sections describe the combined use of these objects for performance targets in more detail.

Calculating and Displaying Performance Targets

Performance targets are intended to be displayed in a portal using an explicit object zone. The zone parameters define both the business service used to calculate the performance metrics and the UI map that displays the results. While an individual performance target needs to reference a zone with a unique configuration that calculates a particular metric, those zones will be based on a template zone which defines the core parameters.

Framework provides a base Batch Performance Target Metric Template zone (**F1-PERFBA**) for batch process performance targets. Refer to this zone and its parameters for more information about the batch performance zone configuration and the related business service and UI map.

Performance Target Metrics and Metric Types

The framework supports two types of metrics for performance monitoring:

- **Value based metrics** are used to record results against a specific numeric target.
- **Time based metrics** are used to track the results against a specific date and time target.

The list of valid metrics for a given performance target category and its associated performance target types is maintained using an extendable lookup. Framework uses the base business object Batch Performance Target Metric (**F1-BatchPerfTargetMetric**) to define batch process metric values. Refer to this lookup for the supported batch process metrics.

NOTE: While users are not prevented from adding new values to the lookup, the list is not intended to be extendable as new values will not be recognized by the business service that performs the base batch performance calculation logic.

Your edge product or implementation may supply other extendable lookup business objects for additional performance measurement use cases, if applicable.

Performance Target Categories and Types

There are key configuration details required by all performance targets. These are defined on two related objects.

Performance Target Categories

Target categories define the template zone and security setting for a group of performance measures. The list of valid categories is maintained using an extendable lookup.

The framework product supplies the business object Performance Target Category (**F1-PerformanceTargetCategory**) for this functionality. Refer to the business object description and configuration for more information.

Performance Target Types

Target types define the related performance target business object and the display portal for a group of performance measures. In addition, a target type references a target category which defines the associated zone details.

The framework product supplies the business object Performance Target Type (**F1-PerformanceTargetType**) for this functionality. Refer to the business object description and configuration for more information.

The framework does not deliver any standard type or category values for batch processing performance targets. Refer to your specific edge application products to verify if any standard values are delivered for the batch processes within your applications. Edge applications may also supply standard categories and types for additional performance target use cases.

Performance Targets Define Specific Metrics

Although the types of measures and the business services and UI maps that govern how they are calculated and displayed are defined using separate objects, a **performance target** record defines the additional configuration needed to measure a specific metric and compare the result to a desired value.

There are key configuration details required by all performance target instances. These include a reference to the metric being measured, the desired target value or time, the desired result for the target and the unique zone by which this performance target will be monitored.

NOTE: The performance target maintenance object has a direct foreign key link to the extendable lookup business object and value that define the performance metric. This is an unusual pattern as extendable lookup values are normally recorded only in an object's schema. The pattern has been adopted to allow the description of the metric to be displayed in the performance target maintenance portal.

A given **performance target type** may require additional details for its calculations. For example, the framework batch process performance target defines additional details to restrict the measurement to specific batch processes that have executed within a given time frame. These details are configured on the performance target business object. Refer to the embedded help text on the business objects supplied by the framework and your edge applications for more information.

The **performance target type** also defines the business object to use when creating the resulting performance target record.

Objects Linked to a Performance Target

Some performance measures such as batch process metrics, derive the data for the calculation from objects within the system. The performance target can be linked to one or more related objects to define the specific data sources included in that target metric. For example, when creating a batch process performance target, the framework supports linking specific batch codes to the performance target to indicate the group of batch processes that are included in the measure.

The performance target business object may be configured to allow only relevant objects types to be linked to a performance target record. Refer to the base Batch Performance Target business object (**F1-BatchPerformanceTarget**) for an example.

Creating Performance Target Zones

Once a performance target and its objects have been defined, a unique zone needs to be created to display and monitor the specific target.

The framework functionality for batch performance targets implements the zone creation via the related business object lifecycle. When a performance target is added, status enter plug-ins are responsible for generating the new zone using the template zone and prefix configured on the target category (or the override values) and adding the zone to the portal configured on the target type. When a performance target is inactivated, an enter plug in is responsible for removing the zone from the portal.

NOTE: While the template zone associated with the performance target category may be overridden, the zone generation algorithm makes certain assumptions about the zone type and parameters. In particular, the logic expects to configure a zone parameter that references the performance target code as input to the business service responsible for calculating the metrics.

Refer to the base Batch Performance Target business object (**F1-BatchPerformanceTarget**) for details of the lifecycle and the enter plug-ins responsible for performance target zone creation.

Setting Up Performance Target Configuration

The following topics highlight the general configuration steps required to use performance target functionality. Your particular product or implementation may supply additional functionality to support specific use cases for performance targets. Refer to your product's documentation and the library of business objects supplied for performance target in your system for more information.

Performance Target Category Lookup

Refer to [About Performance Targets](#) for an overview of performance target functionality.

Each Performance Target Type is associated with a unique Performance Target Category. The categories are defined as an extendable lookup.

Navigate to the [Extendable Lookup](#) portal. Search for and select the **Performance Target Category** business object. Define values that are appropriate to the categories your implementation is assigning for the performance target types in use. In some cases, an edge application may already have delivered the appropriate performance target category for your use

Refer to the embedded help for more information about configuring this object.

Defining Performance Target Types

Refer to [About Performance Targets](#) for an overview of performance target functionality.

To maintain the performance target types applicable to your product or implementation, open **Admin > Reports > Performance Target Type**.

This is a standard [All-in-One portal](#).

The information captured on the performance target type depends on the business objects supported by your product or implementation. Refer to the embedded help text for more information.

Maintaining Performance Targets

This section describes the functionality supported for viewing and maintaining performance targets.

Refer to [About Performance Targets](#) for an overview of performance target functionality.

Navigate using **Main > Reporting > Performance Target**. This is an [All-in-One portal](#) and includes the standard List and display zones for a performance target.

For information about the data defined on the performance target, refer to embedded help.

Capturing Statistics

The product provides objects to allow for an edge product or an implementation to periodically calculate and capture statistics for one or more use cases. The topics in this section provide information about what is supplied in the framework and guidelines for implementing specific use cases.

Understanding Statistics

There are two objects that work together to capture the statistics related to a given business use case:

- The statistics control record which defines configuration related to capturing statistics. It also defines a category that is used to group similar types of statistics together.
- The statistics snapshot is the record where the actual calculated statistics are captured.

Statistics Control

The statistics control record defines whether or not statistics are automatically calculated and how frequently. In addition, you may control the retention policy of snapshot records. You may indicate that only the most recent snapshot is kept or all snapshot records are kept or that they are retained for a defined number of days.

The system provides a business object for statistics control (**F1-Statistics**) that is expected to be used for most use cases. Its lifecycle includes the support for periodic capturing of statistics snapshot records as well as on demand capture.

Statistics Snapshot

The statistics snapshot object is the object that is responsible for calculating and capturing the statistics details. A separate business object must be defined for each use case. The schema of the business object defines the details that are captured. In addition, it must include an algorithm as an enter plug-in on the **Complete** state that is responsible for capturing statistics.

The system provides a 'root' business object for statistics snapshot (**F1-SnapshotRoot**) which includes the lifecycle that statistics snapshot business objects should follow. No explicit statistics snapshot use case is provided by the Framework. Your specific product may supply some out of the box support for certain use cases, in which case specific statistics snapshot business objects are provided. Refer to your product specific documentation for more information.

Viewing / Reporting Statistics

The product provides the mechanism for defining statistics control and statistics snapshot records and viewing the data in basic format. If your product has provided support for specific use cases, there may also be additional portals used to display the statistics in a meaningful format. For example, the statistics snapshot may be capturing data that can be presented in graphical format. Additionally, if multiple historical statistics snapshot records are retained, a zone may be defined to graph changes over time.

Configuring Your System for Statistics

If your product provides statistics use cases that you are planning to implement, all that you need to do is configure the appropriate statistics control record and define the appropriate configuration for your business requirements. Refer to [Defining and Monitoring Statistics](#) for more information.

If your implementation has identified an additional use case where you would like to capture statistics, the following points highlight the steps needed to configure the system to support the use case.

- Determine whether an additional Statistics Category value is needed. This is captured on the statistics category record. Navigate to the [Lookup](#) page. Search for and select the **STAT_CATEGORY_FLG** field. Review the values and determine if additional values are needed.

- Define a new statistics snapshot BO. This should be a child BO of the base delivered BO (**F1-SnapshotRoot**). Its schema should define elements for the specific information that is captured by the statistics calculations. The schema should be designed in conjunction with an appropriate Enter Status algorithm for the **Complete** that calculates the statistics as appropriate for the business requirement.
- Once the snapshot business object is designed and implemented, configure the appropriate statistics control record.

Defining and Monitoring Statistics

Refer to [Understanding Statistics](#) for an overview of the statistics functionality.

To define and maintain statistics control records and view a list of the current snapshot records, open **Admin > Reporting > Statistics Control**.

This is an [All-in-One portal](#) and includes the standard List and display zones for a statistics control.

For information about the data defined on the statistics control, refer to embedded help.

Statistics Snapshot

If there are any Statistics Snapshot records for the statistics control, the **Statistics Snapshot List** zone displays a list of the most recent records. A user may drill into any of the records to view more detail. You are brought to a maintenance portal where you may view details about the calculated statistics. The information captured will be unique to the particular use case. Refer to the embedded help for more information.

Creating Cube Views

Many implementations require the ability to extract and analyze complex sets of data in a way that is simple to visualize and supports business or organizational decision making. A common model for performing this type of analysis is a multi-dimensional array, often referred to as a data cube. Cube views allow data to be represented in a way that provides the user with multiple perspectives of the results.

Although called a "cube", a cube view can have two, three or a higher number of dimensions. Each dimension represents some attribute in the database and the cells in the data cube represent a measure or value. For example, a cell could contain a count of the number of times that attribute combination occurs in the database, or the minimum, maximum, sum or average value of data related to that attribute. Queries are performed on the cube to retrieve information.

The framework provides objects to support the definition of data cubes and a flexible means of viewing them. The topics in this section provide information about what is supplied in the framework to assist in implementing a cube view. Your product may also supply out of the box support for relevant use cases. Refer to your product documentation for more information.

Understanding Cube Viewer

The framework provides a cube viewer portal which is intended to be used for most implementations of cube views. It supports a number of common actions and data representations.

NOTE: The choice of appropriate menu for the Cube Viewer portal will differ from product to product. Refer to your product specific documentation for more information on how to access the viewer.

The following sections describe the basic concepts and features of the cube viewer.

Cube Viewer Components

The base Cube Viewer interface is comprised of the following main areas:

1. The Toolbar
2. The Settings Area
3. The Filters Area
4. The Views Area

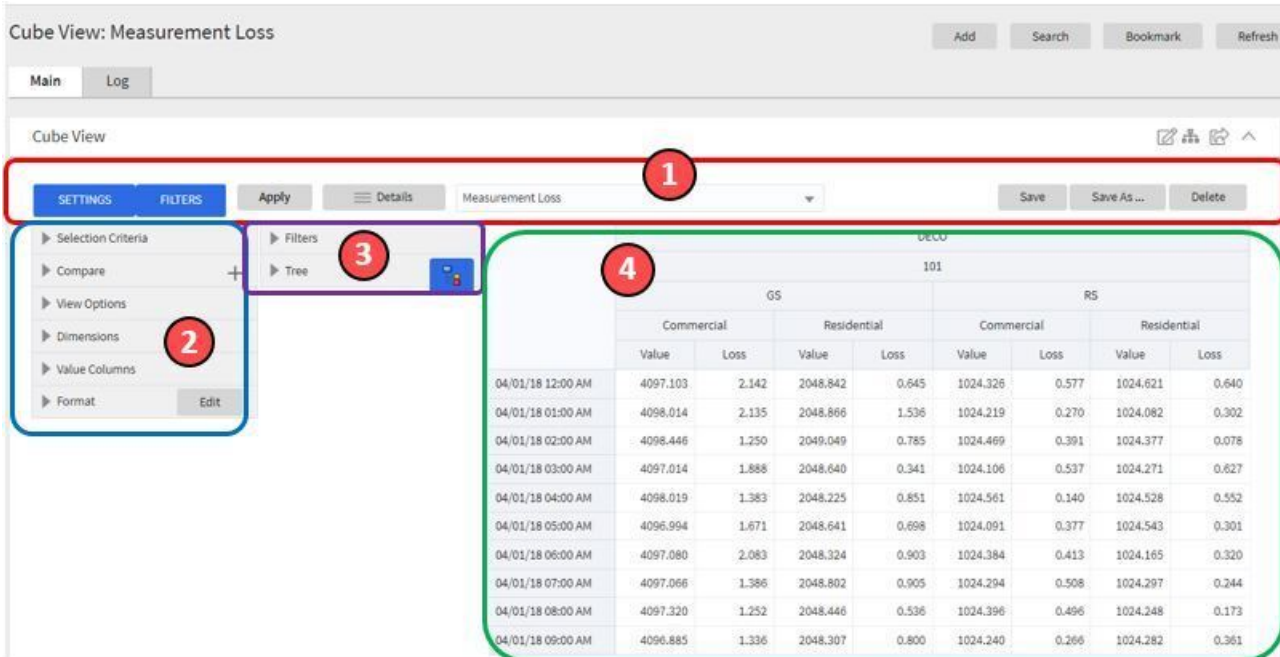

The next topics provide more information about each component.

The Toolbar

The following features are available on the Cube Viewer toolbar.

Settings and Filters Buttons

Click the **Settings** and **Filters** toggle buttons to collapse and expand the respective [Settings](#) or [Filters](#) areas.



Apply Button

Click the **Apply** button to apply any changes to the settings and display the new results in the views.



Details Button

Click the **Details** button to open a dialog box in which additional attributes of the current cube view can be viewed and updated. Refer to [Cube View Details](#) for more information about the attributes displayed.

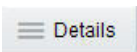

Cube View Dropdown

Click the **Cube View Dropdown** to open a list of cube views, of the same type as the current view, to which you have access. Selecting a cube view from the list will open that view. Use the search box to search for a view within the list using the cube view description.



Save, Save As and Delete Buttons

Click the **Save** button to save the current settings for the cube view. Click the **Save As** button to create a copy of the current cube view. Click the **Delete** button to delete the current cube view.

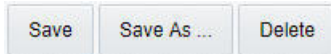

Cube View Details

Clicking the **Details** button on the cube viewer **Toolbar** allows you to maintain the following information for the cube view:

- The short **Description** for display in the viewer header and a more **Detailed Description** for capturing additional information about the cube view.
- An **Access Type** of shared, private or public.
- The **Access Group** that defines the group of users with access to the cube view. This field is only visible if the access type is shared.
- A specific **User** who has sole access to the cube view. This field is only visible if the access type is private.
- The **Row Functions** text box in which the functions to be applied to the values across the rows in the data grid are defined. Clicking anywhere in the box will display a list of supported functions to choose from.
- The **Column Functions** text box in which the functions to be applied to the values in the columns in the data grid are defined. Clicking anywhere in the box will display a list of supported functions to choose from.
- An **Inactivate** button. Click this button to deactivate this cube view.

The **Fixed Parameters** for the cube view are displayed but cannot be updated here. Refer to [Configuring Cube Types](#) for more information on cube view parameters.

The Settings Area

The Settings Area contains a number of sections whose inputs control various aspects of the current cube view.

Selection Criteria

Open the **Selection Criteria** section to enter filter values for the user parameters defined on this cube type. User parameters that have been configured as 'Save with Cube View' on the cube type will be saved when the cube view is saved.

Compare

Open the **Compare** section to enter one or more sets of criteria that are used to retrieve data sets for comparison to the data retrieved by the main Selection Criteria. Use the Add and Delete buttons to add or remove a set of criteria. The comparison values will be displayed side by side with the main cube values in the data views. Note that the pseudo dimension **Dataset** must be included as a dimension column in order to display comparison views.

View Options

Open the **View Options** section to access buttons that toggle on and off the display of the supported data view types. The buttons can be used to change the order in which the views are displayed, using drag and drop. Any changes made to the default button settings will be saved when the cube view is saved. Refer to the [Views Area](#) topic for more information on the available data views.



Dimensions

Open the **Dimensions** section to view the list of dimensions defined on this cube type, as well as the pseudo dimension **Dataset** and the date/time filter, if applicable. Use drag and drop to move a dimension into the list of **Columns** or **Rows** displayed in the data views. Moving a dimension into the **Unassigned** list will remove it from the data views.

Format

Click the Edit button on the **Format** section to open a dialog box in which conditional formatting, such as background or text color, can be defined for the values in the data grid. Refer to [Defining Conditional Formatting](#) for more information about the formatting controls.

NOTE: Changes made to the settings will only be reflected in the views when the **Apply** button is pressed, with the exception of the **View Options**, where changes are reflected immediately upon toggling or rearranging the buttons.

Defining Conditional Formatting

Clicking the **Edit** button in the **Format** section of the **Settings** area allows you to define formatting rules for the display of values in the cube view data grid. The rules are based on mathematical expressions or formulas which use the cube view values as variables.

The formulas must be expressed using the field names of the values for the cube, as used in the cube view query zone. A list displaying the **Column Name** and associated **Label** for each value configured in the cube view is provided, to assist in defining the formulas.

The following attributes need to be defined for each rule:

- The **Sequence** defines the order in which the formatting rules are evaluated.
- The **Active** check box indicates whether the rule should be applied or not.
- The **Formula** defines the mathematical expression that is evaluated to determine whether the formatting should be applied. The expression variables should reference the **Column Name** of the value.
- **Format** defines the formats to be applied to cells whose value meets the condition expressed in the formula. The formats include the **Background** and **Text** colors and whether the text should be in **Bold**.
- The **Stop If True** check box indicates whether to stop evaluating the remaining formulas in sequence if this formula evaluates to true.

The Filters Area

The Filters Area provides the ability to select and apply dimension filters to the current view.

The **Tree** section displays a hierarchical view of the dimension values in the current cube view. Clicking a value will cause it to be displayed in the **Filters** section and immediately applies that filter to the data in the currently selected views. To remove a dimension from the filters, click on the value in the **Filters** section.

The **Hierarchical Filtering** icon, , is used to toggle between hierarchical and non-hierarchical selection mode. In hierarchical mode, clicking a dimension value at any level in the tree will automatically populate the filters with the related higher level dimension values. In non-hierarchical mode, only the selected dimension value is added as a filter.



Use the expand and collapse icons, , to quickly expand the tree, one level at a time, below the currently selected dimension value or collapse the entire level.

The Views Area

This section describes the types of views supported by the Cube Viewer.

Data Grid

The **Data Grid** displays the cube view data set in the form of a pivot table. The fields that appear as rows and columns in the table are defined in the **Dimensions** section of the [Settings](#) area. The default aggregation function used for the values is sum. Additional functions can be defined in the details of the cube view. Refer to the description of the **Details** pop-up window in the [Toolbar](#) area for more information.

Raw Data

The **Raw Data** view displays the cube view data set as a flat table.

Line Chart

The **Line Chart** displays cube view data in a chart with a time sequence as the X-axis and value intervals as the Y-axis. Each line corresponds to a specific combination of the selected dimensions. This view is only visible if the cube view includes at least one date/time filter in the selection criteria. If the criteria include more than one date/time field, the first date/time filter in order is chosen for the time sequence.

Bar Chart

The **Bar Chart** also displays cube view data in a chart with a time sequence and value intervals. Each bar corresponds to a specific combination of the selected dimensions. This view is only visible if the cube view includes at least one date/time filter in the selection criteria. If the criteria include more than one date/time field, the first date/time filter in order is chosen for the time sequence.

Cube Configuration Components

Cube views are supported using a number of standard configuration components.

The system provides a business object for cube views (**F1-CubeView**) which is used to capture access controls and the settings, such as user parameter values, for a cube view instance. The business object also defines the portal navigation and the base display UI Map (**F1-CubeViewDisp**) and accompanying display map service script (**F1-CubeViewD**). The display map and service script together drive the functionality supported in the cube viewer.

NOTE: The system also supplies a UI map fragment (**F1-CubeViewProc**) which is used to display a cube view in a process flow panel. Refer to [Process Flows](#) for more information.

The system provides a portal for cube views (**F1CUVWM**) that can be configured on the appropriate menu item or other navigation path for your implementation. The portal is linked to the base cube view zone (**F1-CUBEVIEW**).

In addition, the system supplies a simple query by cube view information (**F1-CUBVIWQ1**) that is the single entry on a base multi-query zone (**F1-CUBVIWQ**). The multi-query zone is not linked to the base portal as the expectation is that implementations will need to create searches tailored to their specific use cases for cube views. The base multi-query provides a quick means of configuring a cube view search while in development mode.

Configuring Cube Types

Cube Types are used to capture the details that define the sourcing of the data for a cube view and parameters that control certain features of the cube viewer. These details include:

- The business service whose associated zone defines the query used to select and filter the data for the cube view.
- The user parameters that correspond to the filters for this cube type's business service and zone.
- The user parameter settings that determine whether a given filter value should be saved with the cube view and whether the value should be populated from global or portal context, if applicable.
- The fixed parameter values to be applied as hidden filters for cube views of this type.
- The results from the business service and zone to be used as dimensions in the cube view and those that are the cube view values.
- The dimension settings that determine the order in which the dimensions are displayed in the data grid, which dimensions are to be used as filters in the cube view and which dimensions are to be included in the cube view tree.
- The values settings that determine the default sequence in which the values are displayed in the data grid.
- The FK Reference used to navigate from the data grid to the underlying source data.

If your product provides business services that support cube views you plan to use, all you need to do is configure the appropriate cube type records. Refer to [Maintaining Cube Types](#) for more information.

If your implementation has identified additional cube views you need for data analysis, you will need to create a zone and business service that use specific techniques for defining the SQL to derive the source data for the view and for mapping the results. Refer to [Cube Type Advanced Topics](#) for more information

Maintaining Cube Types

Refer to [Creating Cube Views](#) for an overview of the cube viewer functionality.

To define and maintain cube type records, open **Admin > Analytics Configuration > Cube Type**.

This is an [All-in-One portal](#) and includes the standard list and display zones for a cube type.

For information about the settings defined on the cube type, refer to [Configuring Cube Types](#) and the embedded help.

Cube Type Advanced Topics

The following topics describe the technical models that need to be followed when creating a new cube type.

Designing Your Cube Type SQL

In order to support the base cube viewer, the SQL used in your cube type data explorer zone needs to be constructed with two main components. The first component creates a view of the data and its dimensions in a form that supports a tree-like structure and allows for the dynamic use of filters. The second component queries the filtered data set to provide the values to be displayed for each dimension.

The first component should contain the following queries:

- A sub-query constructed using a 'with' clause that builds a tree-like view of the cube's dimensions and optionally other columns used in the main SQL. This portion of the SQL must be enclosed within '/*>tree*/' and '/*<tree*/' hints and use the table alias **C_TREE**. The combination of the dimension columns should form a unique 'key' in the **C_TREE** data. Both the 'with' clause and the 'tree' portion within it may contain other supporting sub-queries.
- A sub-query which is the placeholder for filtered queries on the 'tree' data. It must use the table alias **C_FILTER** and take the form 'C_FILTER as (select * from C_TREE where l=1 and ROWNUM <= n)'. The value of 'n' should be set to limit the rows returned to a number that is manageable within the cube viewer.

The second component is the main query that retrieves the measures for the cube view dimensions. This query references **C_FILTER** as the subset of the **C_TREE** and joins with other tables if required to retrieve the numeric values. The first date or date/time result column of the main query (as specified in the zone configuration) designates a time-series column, which forms the time-series 'key' with the dimensions columns.

Defining Your Cube Type Business Service

The business service that identifies the zone for a cube type is also used to provide additional configuration options.

The business service schema should define meaningful element names for the parameters, dimensions and values. It should also define labels for those elements to be used by both the cube type and cube viewer user interfaces. The labels can be derived by mapping the element to a meta-data fields or by using the 'label=' syntax to define a text string directly in the schema definition. The 'required=true' syntax can be used to require a value to be entered for a user parameter on the cube viewer or for a fixed parameter on the cube type.

The user parameter elements are expected to be defined within a group in the schema called 'input' and the fixed parameters within a group called 'hidden'.

Product Use Metrics

The Product Use Metrics portal includes a zone (or zones) that are used to perform a business review of your organization's implementation of the product to confirm licensing / subscription compliance. The information visible on this portal will depend on the product or products installed by your organization.

To view this portal, open **Main > Dashboards > Product Use Metrics**.

For more information about what each zone on the portal is reporting, refer to the embedded help.

External Messages

This section describes mechanisms provided in the product that enable an implementation to configure the system to communicate with an external application.

Incoming Messages

This section provides information about support for incoming messages.

Inbound Web Services

Inbound web service functionality is provided to support receiving web service requests from an external system.

Understanding Inbound Web Services

The system supports communicating with the system via RESTful services or via SOAP services. In both cases, the system uses an object called inbound web service (IWS) to store the configuration. A web service class is used to distinguish whether the IWS is used for REST or SOAP. There is also a distinct business object for each web service class value because there is different configuration for each type of IWS.

For both types of inbound web service, the system supports the configuration of one or more operations per web service. Each operation defines the schema-based object to invoke to perform the desired function. An operation may refer to a Business Service, a Business Object, or a Service Script. If the IWS supports multiple operations, each operation can refer to the same or a completely different schema-based object from other operations within the IWS.

REST APIs may be secured by OAuth client credentials grant in a cloud installation. Refer to the Identity and Access Management chapter in the *Oracle Utilities Cloud Services Administration Guide* for more information.

The following topics provide more information about the different configuration of IWS based on whether it is SOAP or REST.

Inbound REST Web Services

The following topics provide more information about the product's support of REST services using IWS. Note that IWS REST records are marked with a REST engine version of 1.0 or 2.0. Version 2.0 is the version used for new services. Version 1.0 is introduced for backward compatibility. Some of the system behavior differs based on the version of the REST service. The sections below highlight cases where this occurs.

HTTP Method and Parameters

When defining operations for inbound REST web services, the product supports the HTTP methods of Get, Patch, Post, Put, and Delete. Note that the product's support of these various HTTP methods are a means of communicating the purpose of the web service to the outside world. However, the actual behavior of the REST web service is driven by the behavior of the underlying schema based object (business object, business service or service script). For example, you may configure the HTTP Method of "Put" for an operation that references a service script that just retrieves a record. The product is not able to detect this type of discrepancy. Configuration users should carefully consider the correct method to use based on the logic of that service.

For operations that reference a business object, the transaction type must be provided. The REST syntax doesn't support defining the transaction type at runtime. There are some basic validation checks in this case related to the transaction type and the HTTP method. For example, a Get method only makes sense with the Read transaction type.

NOTE: Using the transaction type **Change** requires all values to be passed in. Using the transaction type **Update** allows the web service to pass only the primary key and the values to be updated. All other elements will retain their existing values.

You may additionally define parameters. For each parameter, you define an external reference to the element, which is how this parameter is exposed to the external callers and is defined in the API specification. Each of these parameters is mapped to the XPath of the schema element from the underlying business object, business service or service script. For each parameter, you indicate if it is a **Path** parameter or a **Query** parameter.

- Path parameters are parameters that are part of the endpoint and are required. Each path parameter must be included in the operation's URI component surrounded by curly brackets.

- Query parameters are optional. They are not part of the endpoint but rather are included in the endpoint URL after a question mark, followed by name value pairs.

Refer to the URL section below for examples of path and query parameters in the sample URLs.

URL Composition

When building the endpoint URL for a REST service, there are three main parts that make up the full URL.

- The first part is the one that is environment specific. This will differ for an on premise implementation as compared to a cloud implementation. Both will have the host and the port and then additional components that identify the environment.
- The second part is a hard coded path designated by the product, namely "/rest/apis".

These two parts of the URL are defined in the substitution variable **F1_REST_BASE_URL**. This is defined when initializing your environment. Refer to the Server Administration Guide for more information.

The remaining part of the URL is built dynamically based on configuration for each IWS and its operations. The components are "/ownerURIComponent/resourceCategoryURIComponent/iwsURIComponent/operationURIComponent"

- The owner URI component is taken from the owner flag of the inbound REST web service. A special extendable lookup ([Owner Configuration for REST Services](#)) defines this component for each owner flag.
- Each Inbound REST Web Service must reference a [resource category](#). This category is used to associate related web services to a common category of resources. For multiple IWS records linked to the same resource category, external catalogues can use this information to group together related web services. The resource category is an extendable lookup and the URI component is an attribute of this record.
- Each REST IWS record defines a URI component that serves as an external identifier of this IWS record. The value must be unique within a given owner flag.
- Each operation must define the HTTP Method and optionally a URI component. When defining path parameters, the path parameters must be included in the URI component using curly braces.

In all cases, the URI component must begin with a slash (/).

The following are some examples of the dynamic portion of the URL for a REST service. The last example illustrates the use of a query parameter.

IWS Name URI Component	Owner URI Component	Resource Category URI Component	Operation HTTP Method URI Component	Dynamic URL Component	Run Time Example
c1rateCalculation /rateCalculation	C1 /customer	C1-RATES /rates	Post /	../customer/rates/ rateCalculation/	../customer/rates/ rateCalculation/
w1WorkActivity /workActivity	W1 /asset	W1-WORK /work	Get /{activityId}	../asset/work/ workActivity/ {activityId}	../asset/work/ workActivity/5798165498
w1WorkActivity /workActivity	W1 /asset	W1-WORK /work	Patch /scheduleWindow/ {externalSystem}/ {activityId}/ {windowStartDateTime}	../asset/work/ workActivity/ scheduleWindow/ {externalSystem}/ {activityId}/ {windowStartDateTime}	../asset/work/ workActivity/ scheduleWindow/ MY- COMPANY/5798165498/20190101
CM- AccountActivityHistory	CM /cm	CM-ACCT-INFO /accountInformation	Get /{accountId}	../cm/ accountInformation/ accountActivityHistory/ {accountId}	../cm/ accountInformation/ accountActivityHistory/123456789? activityId=5468976

IWS Name	Owner	Resource Category	Operation HTTP Method	Dynamic URL Component	Run Time Example
URI Component	URI Component	URI Component	URI Component		
/					
accountActivityHistory					

Payload Format

REST services support receiving a request payload in XML or JSON format and returns the payload in either XML or JSON. The default format returned depends on the value of the REST Engine Version.

- Version 2.0 services assume JSON format as the default. The default can be overridden by providing an accept header of **application/XML**.
- Version 1.0 services assume XML format as the default. The default can be overridden by providing an accept header of **application/JSON**.

Root Node for JSON Format

Version 2.0 services with the JSON formatted payload do not accept in the request or return in the response any root node around the payload. The following is an example of the response of a REST call for a version 2.0 service:

```
{
  "batchJobId": "string",
  "requestSuccessful": "string"
}
```

Version 1.0 services with the JSON formatted payload expect a root node in the request and return one in the response. The following is an example of the response of a REST call for a version 1.0 service:

```
{
  "F1CnclBatJob": {
    "batchJobId": "string",
    "requestSuccessful": "string"
  }
}
```

The Open API Specification visible on the inbound web service maintenance page displays the expected format based on the record's REST engine version when viewing the specification.

Data Type Format in JSON

In JSON format, strings are surrounded by quotes and numbers and Boolean data do not have quotes. All services for REST engine version 2.0 follow this standard. Originally services that are REST engine version 1.0 were incorrectly treating numbers and Boolean data as strings and returning the data with quotes. This has been corrected.

To accommodate any integration that may have worked around the behavior for version 1.0 services, the system provides the ability to identify inbound web services that are exceptions to this rule. For any inbound web service identified as an exception, the system continues to treat numbers and Boolean data as strings in JSON responses. To add one or more IWS records to the exception list:

- Go to [Feature Configuration](#).
- Look for an existing feature configuration with the feature type **External Messages**. If one does not exist, create one.
- Add an option for the option type **IWS JSON Data Type Exceptions**.
- In the option value, indicate the IWS record that is an exception. Note that multiple options for the option type may be added. Additionally, the option value supports a comma delimited list.

External Facing Schema

By default the schema of the underlying service (for example, service script, business object or business service) is also the schema for the REST inbound web service operation and acts as both its Request and the Response schema. The product

provides the ability to define an explicit schema for a REST inbound web service (IWS) operation, allowing a user to adjust the schema for an external facing consumer. The IWS operation schema also supports some special configuration that allows additional features to be defined only for the IWS operation schema.

The operation schema supports the following capabilities:

- Declaring whether an element belongs only to the request schema, only to the response schema, both (default) or excluded altogether. This is used to establish a clear separation between request and response schema definitions.
- Assign a different element name to an internal element. This allows the internal service element name to more closely align to internal references to the element, if needed. The external facing element name can be different allowing for a more readable schema.
- Introduce specialized elements that support links and other types of structural standards in a way that does not impact internal service processing.

Refer to [Web Service Schema Nodes and Attributes](#) for more information.

The REST servlet uses the request and response schemas to map elements to and from the internal schema.

NOTE: While the caller should only provide elements defined by the request schema, the application does not filter out extraneous elements. Assumption is that the internal service is designed to ignore such elements. However, only elements defined by the response schema are included in the response.

Dynamic Links

There are use cases where the published API includes a "_self" element that contain the endpoint URL of the GET operation related to the data returned in the response. Additionally, response payloads may include foreign keys and for those entities, the response includes a "_link" element that contains the endpoint URL of the GET operation for that entity (if it exists).

Syntax is provided in the REST inbound web service operation schema to support building the runtime endpoint URL for the _self and _link elements. Besides dynamically building the static portion of the URL based on the current environment details, it also builds the dynamic portion of the URL, substituting the URL components for the operation and substituting the path parameters. The syntax allows you to define a specific IWS Operation or allows you to reference a maintenance object and at runtime, the system determines the GET operation for the maintenance object and builds the URL accordingly.

Example of the syntax:

```
<_link getOperation="mo:'TO DO ENTRY';pk1:todoEntryId;"/>
```

Example of the runtime endpoint URL:

```
_link: "http://.../common/todos/todoEntries/28937296450934"
```

A GET operation may be associated with a maintenance object to denote that this is the default GET operation for the entity. A **GET Operation** option at the Maintenance Object and Business Object level may be used to override this default. If the entity is not associated with a business object or the latter is not associated with such option then the operation associated with the maintenance object (if any) is used.

Open API Specification Documentation

The following documentation information may be provided for an Inbound Web Service:

- Short and detailed description for each operation.
- Help text may be provided for individual elements. The same text can be shared across multiple elements across all operations of the Inbound Web Service. If an element is not associated with help text then its internal field's label is used instead.
- Sample request and response documents may be provided for each operation.
- Operations may be associated with a sequence number that controls the order in which they appear in the Open API Specification.

NOTE: Detailed descriptions and element related help text are not translated since the published catalogue for base product APIs is in English language only.

Inbound SOAP Web Services

For inbound SOAP web services, by default the system uses the Schema Name to dictate the Request and Response for the service. The API can be overridden with custom formats by specifying Request and Response XSLs to transform into the relevant schema formats. In addition, if desired, the Request and Response Schemas that document the expected message may be provided.

NOTE: The Request and Response Schema fields are not supported in a cloud implementation.

NOTE: The system supports defining the XSLs as a [managed content](#) record. For backward compatibility, the system supports defining the XSL as a file in the file system. This is a system wide setting, defined using a feature configuration option. The feature type is **External Messages** and the option type is **XSL Location**. Set the value to **F1FL** to support XSL in the file system. The file location is configured using a system property. To support the XSL in managed content, no option is needed as this is the default. You may explicitly define the value of **F1MC** if desired.

In addition, note that for business object based operations, when invoking the web service an action is required. This may be passed into the web service as part of the invocation or alternatively, the action may be defined when configuring the operation using the transaction type.

NOTE: Using the transaction type **Change** requires all values to be passed in. Using the transaction type **Update** allows the web service to pass only the primary key and the values to be updated. All other elements will retain their existing values.

Annotations Used for Security

When preparing to deploy inbound SOAP web services, the security aspects of the service must be decided. The product provides a default security policy that is applied when no other policy is defined: **@Policy(uri="policy:Wssp1.2-2007-Https-BasicAuth.xml", attachToWsdL=true)** which requires HTTP Basic over SSL and a WS-Security Timestamp.

If a different security policy is desired, the following options are available:

- Security policies may be attached to the Inbound Web Service via the Java Enterprise Edition (Java EE) Web Application Server. This allows for multiple policies to be attached as supported by the Java EE Web Application Server. In order to enable this capability, explicit system configuration is required so that the product does not assume the default security policy. See the subsequent bullets for more information.
- Define a system wide security policy using a feature configuration option. Find the [Feature Configuration](#) record for the **External Messages** feature type. (It may need to be defined if it does not exist). Choose the option type **Default security policy** and define an appropriate value. If your implementation wishes for the policies to be attached at the Java EE Web Application Server, define this option type with an option value of **<none>**.
- Attach a security policy to the IWS via a Web Service Annotation. The base product provides annotation types that support the standard WS-Policy (**F1POLICY**) and OWSM Security Policy (**F1-OWSM**). No base annotation is supplied by the product for either annotation type.

If your implementation wishes for the policy of a particular IWS to be attached at the Java EE Web Application Server, define a special annotation for the **F1POLICY** annotation type and configure the **uri** parameter value to **<none>**.

NOTE: Refer to WebLogic documentation for more information on supported security policies.

NOTE: In order to use the OWSM Policy, additional system configuration is necessary. Contact your system administrator to confirm if your implementation supports OWSM.

Inbound SOAP Web Service Deployment

A Inbound SOAP Web Service must be deployed to the Java EE Web Application Server in order for it to be available to the Web Service Clients to access the system. Refer to [Deploying SOAP Web Services](#) for more information.

Deploying XAI Inbound Service via IWS

For implementations using XAI inbound services for external messages, the product recommends moving to the inbound web service mechanism, which uses the Java EE Web Application Server to communicate with the product rather than the XAI servlet.

For XAI inbound services that use the **Business Adapter**, it is straight forward to move to IWS because the configuration is similar. In both cases, the service is configured to reference a business object, business service or service script. The associated WSDL for each record is similar. Changing the interface for the incoming message to use IWS instead of XAI inbound services is similar.

However, for XAI inbound services that use the **Core Adapter**, these services reference an underlying "page service" in the product. For these services, the Request and Response schemas for the XAI inbound service were created using the Schema Editor. In order to support calling an underlying "page service" in IWS, first a [business service](#) must be created to reference the page service (if one doesn't already exist). However, the resulting schema for the business service is different from the Request and Response schemas related to the XAI inbound service. Moving this functionality to IWS using business services requires changes to the format of the incoming messages.

Moving all incoming messages over to use IWS instead of XAI is the product recommendation. However, to aid in implementations that have many integrations in place using the XAI inbound services that use the **Core Adapter** (or any adapter whose message class is **BASEADA**), the product provides the ability to deploy these types of XAI inbound services to the Java EE Web Application Server along with the Inbound Web Services.

To take advantage of this capability, you must define a feature configuration option. Under the **External Messages** feature configuration type, the **Support XAI Services via IWS** is used to indicate if this feature is supported. Setting the value to **true** turns on the feature. If no option is defined for that option type, it is equivalent to setting the value to **false**.

When the system is configured to support XAI services via IWS, the [Inbound SOAP Web Service deployment](#) includes XAI inbound services (that are configured with an Adapter that references the **BASEADA** message class). The deployment portal will also include a zone showing the deployment status of these XAI Inbound Services.

NOTE: There is no support for XAI inbound services via REST, only via inbound SOAP web services.

Configuring Inbound Web Service Options

This topic describes the configuration needed for using inbound web services.

Configuring SOAP Inbound Web Service Options

This topics in this section describes the configuration needed for using inbound SOAP web services.

Technical Configuration

In order to use inbound web services, there are tasks a system administrator must perform.

Refer to the Server Administration Guide for technical details of each of these processes.

Maintaining Web Service Annotation Types

The product provides some base annotation types. Refer to the metadata for more information. If your implementation wishes to define additional annotation types, use the Web Service Annotation Type portal. Open this page using **Admin > External Message > Web Service Annotation Type**.

You are taken to the query portal where you can search for an existing web service annotation type. Once an annotation type is selected, you are brought to the maintenance portal to view and maintain the selected record.

NOTE: Use of custom policies should only be considered if the policies supplied by the Java EE Web Application Server are not sufficient for your implementation's needs.

CAUTION: Important! When adding new records, carefully consider the naming convention of the web service annotation type code. Refer to [System Data Naming Convention](#) for more information.

The **Web Service Annotation Type** zone provides basic information about the web service annotation type.

Please see the zone's help text for information about this zone's fields.

The system supports the ability for an IWS record to refer to multiple policies. In this situation, the annotation type for the policy should include a reference to a parent annotation type so that the system can properly build the array of annotations.

Maintaining Web Service Annotations

If your implementation wishes to define annotations, use the Web Service Annotation portal. Open this page using **Admin > Integration > Web Service Annotation**.

This is a standard [All-in-One portal](#).

CAUTION: Important! When adding new records, carefully consider the naming convention of the web service annotation code. Refer to [System Data Naming Convention](#) for more information.

Maintaining XAI Inbound Services

XAI Inbound Service is a legacy mechanism for exposing system services to external systems as web services. The current supported mechanism for defining web services is [Inbound Web Services](#), which should be used for any new web service.

Some framework based products and existing implementations may have existing XAI inbound services that may need to be viewed. For these services, the product supports deploying them as SOAP inbound web services for execution. Refer to [Deploying XAI Inbound Service via IWS](#).

The following sections describe basic information about the maintenance pages. Note that some of the information is related to legacy functionality that is no longer supported.

XAI Inbound Service - Main

To view an inbound service, open **Admin > XAI > XAI Inbound Service**.

Description of Page

XAI In Service Name is used in the system to identify the service. The service name is also the first XML element after the <Body> element in the XML request/response document. The **XAI Service ID** serves as the primary key.

Owner indicates if this XAI inbound service is owned by the base package or by your implementation (**Customer Modification**). This information is display-only.

The **Adapter** defines the interface with the target application server.

If adapter for this service invokes a system service, then the appropriate **Service Name** is visible.

If adapter is the **Business Adapter** then **Schema Type** and **Schema Name** reference the object to invoke.

Web Service Category is visible if the XAI inbound service is linked to one or more [web service categories](#).

Use the **Description** and **Long Description** to describe the service.

Check the **Active** switch if this service is enabled and available for execution.

Post Error is not applicable.

Trace is not applicable.

Debug is not applicable.

Schema Definitions

NOTE: Request Schema and Response Schema are not applicable to services invoking schema-based objects. They do not appear when the **Business Adapter** is used.

The next two properties define the request and response XML schemas. The schemas are SOAP compatible. The schema XML files are expected to be stored in the Schemas Directory on the Web server running the XAI server.

The **Request Schema** is the XML schema defining the service request. The request sent to the server must adhere to the schema definition.

The **Response Schema** is the XML schema defining the service response. The response generated by the XAI server corresponds to the response schema definition.

The same service may perform several actions on a business object. Use the **Transaction Type** to define the default action performed by a service. The transaction type can be provided when invoking a service, by dynamically specifying a transaction type attribute on the Service element of the XML request. This field may take the following values: **Read, Add, Change, Update, Delete, List** and **Search**.

NOTE: The difference between **Change** and **Update** is that for **Change**, all field values must be passed in with the request. Field values that are not passed in to the request are set to null. For **Update**, you need only pass the primary key field values and the values of the fields to be updated. All other fields retain their existing values.

Services, which perform a Search, may allow searching based on different criteria. When the Transaction Type value is **Search**, use the **Search Type** to define the default search criteria. The possible values are **Main, Alternate1, Alternate2, Alternate3, Alternate4, Alternate5** and **Alternate6**.

NOTE: This is a default definition only and it may be overridden at run time when the service is invoked. To override the search type at run time, you should specify the searchType attribute on the Service element of the XML request.

XSL Transformation Definitions

Sometimes, the XML request document does not conform to the request schema, or the response document expected by the service requestor is not the one generated by the adapter. In such cases the request and/or the response documents must be transformed. The XAI server supports transformation through XSL transformation scripts. Transformation scripts may be applied to the request before it is passed to the adapter or applied to the response document before it is sent to the service requestor.

The **Request XSL** is the name of the XSL transformation to be applied to the request document before processing it. The transformation is usually required when the incoming document does not correspond to the XAI service request schema therefore it has to be transformed before it can be processed by the adapter.

The **Response XSL** is the name of the XSL transformation to be applied to the response document when the requester of the service expects the response to have a different XML document structure than the one defined by the response schema for the service.

Click the **WSDL URL** hyperlink to launch a separate window that contains the WSDL definition for the inbound service. Note that the server name and port number for the URL are built using a setting in the common properties file using the XAI HTTP Caller URL setting.

Configuring REST Inbound Web Service Options

This topics in this section describes the configuration needed for using inbound REST web services.

Owner Configuration Lookup

Refer to [Inbound REST Web Service](#) for an overview of REST IWS functionality.

When generating the URL for a REST web service, part of the URL is taken from the owner of the Inbound REST Web Service record. The component to add to the URL is defined in this lookup using the URI Component field. The values are provided by the product.

To view the values, navigate to the [Extendable Lookup](#) portal. Search for and select the **Owner Configuration for REST Services** business object.

Resource Category Lookup

Refer to [Inbound REST Web Service](#) for an overview of REST IWS functionality.

Each Inbound REST Web Service is associated with a Resource Category. The categories are defined as an extendable lookup. The REST URL is built using a component from the IWS record's resource category.

Navigate to the [Extendable Lookup](#) portal. Search for and select the **Resource Category** business object. Define values as needed. Typically the category is related to a logical grouping of entities, or maintenance objects, referred to as a 'resource' in REST nomenclature. In some cases, an edge application may have already delivered appropriate resource categories for your use.

Populate the appropriate URI component to include when building the URL for IWS records linked to this resource category.

Maintaining Inbound Web Services

[Inbound Web Services](#) are used to define a specific message that your implementation will receive from an external system and provides configuration needed to process the inbound message.

The product provides support for REST and SOAP services and provides several inbound web services out of the box.

For inbound SOAP web services, by default no annotations are defined for the base inbound web services. You may modify the message options or the annotations for any base IWS record. In addition, you may define additional IWS records for other incoming messages supported by your implementation.

To view an inbound web service, navigate using **Admin > Integration > Inbound Web Service**. You are brought to a query portal with options for searching for inbound web services.

Once an inbound web service has been selected, you are brought to the maintenance portal to view and maintain the selected record.

CAUTION: Important! When adding new records, carefully consider the naming convention of the inbound web service code. Refer to [System Data Naming Convention](#) for more information.

The following zones may appear as part of the portal's **Main** tab page

- **Inbound Web Service.** This zone displays the configuration information for the record and its operations.

- **Operations.** This zone lists the operations defined for the selected inbound web service. The zone is only visible for a REST inbound web service. You may navigate to the Inbound Web Service Operation portal to further describe the operation's web service schema.
- **Help Text Fields.** This zone maintains help text information for fields across all operations of the selected inbound web service. The zone is only visible for a REST inbound web service.

Refer to [Inbound SOAP Web Services](#) for specific information about Operations for SOAP records.

Refer to [Inbound REST Web Services](#) for specific information about Operations for REST records.

Note that in addition to standard actions available on this portal, there is also a special **Add to Category** button in the page action area. Click this button to link an inbound web service to one or more [web service categories](#).

Maintaining Inbound Web Service Operations

This portal is used to maintain a REST inbound web service operation. You can access the portal from the **Operations** zone on the Inbound Web Service portal for a REST service.

Refer to [Inbound REST Web Services](#) for specific information about Operations for REST records.

The following zones may appear as part of the portal's **Main** tab page

- **IWS Operation.** This zone provides information about the selected operation.
- **Schema.** This zone describes the request and response schema as defined by the operation's web service schema. The zone is only visible when an operation schema is explicitly defined.
- **Schema Extensions.** This zone manages web service schema extensions that correspond to extensions made to the operation's internal schema. This zone is only visible if the underlying schema was extended using dynamic data area extension functionality. Each owner that extended the internal schema may provide web service schema information for their extension elements.
- **Options.** This zone lists various options for the operation such as request and response samples. The zone is visible when such options exist for the operation. Note that options are maintained as part of operation record.

The following zones may appear as part of the portal's **References** tab page

- **IWS Operation References.** This zone lists references to the current web service operation. The list includes other inbound web service operation records that reference the current operation via their web service schema. For a GET operation, the list also includes the maintenance object or business object that explicitly references the operation using a **GET Operation** option.

Web Service Schema Nodes and Attributes

A REST inbound web service (IWS) operation invokes a single schema based object, either a Business Object, a Business Service or a Service Script. The object has one schema which by default acts as both the Request and the Response schema. The product provides the ability to define an explicit schema for a web service operation that represents a view of the underlying internal schema for an external facing consumer. Note that the operation schema is a strict view of the internal schema and as such does not introduce structural changes.

While optional, defining an operation schema has the following benefits:

- Declaring the **usage** of an element as to whether it is part of the Request schema, Response schema, both or neither.
- Assigning an **external element name** to an internal element. Useful to avoid cloning of internal services for this purpose only.
- Better management and visibility of **GET operation** references.
- Support HATEOAS style structures outside of the internal schema. This allows for seamless internal processing.
- Providing help text for individual elements.

The following documentation is a complete list of the attributes available to you when constructing an IWS operation schema.

Contents

- [Operation Schema Definition](#)
- [Specialized Elements](#)
- [Open API Specification](#)

Operation Schema Definition

The following attributes defines the external facing operation schema that establishes the request and response schema for the operation.

Mnemonic	Valid Values	Description	Examples
usage=	"REQ"	<p>Indicates that the element should be included in the request schema only.</p> <p>When specified for a group or list element the value applies to the entire container. A specific element in the container may override the container default.</p>	<code><customerName usage="REQ" /></code>
	"RESP"	<p>Indicates that the element should be included in the response schema only.</p> <p>When specified for a group or list element the value applies to the entire container. A specific element in the container may override the container default.</p>	<code><customerId usage="RESP" /></code>
	"BOTH"	<p>Indicates that the element should be included in both request and response schema definitions. This is the default value</p> <p>When specified for a group or list element the value applies to the entire container. A specific element in the container may override the container default.</p>	<code><customerName usage="BOTH" /></code>
	"EXCL"	<p>Indicates that the element should not be included in either the request or the response schema definitions.</p> <p>When specified for a group or list element the value applies to the entire container. A specific element in the container may override the container default.</p>	<code><httpMethod usage="EXCL" /></code>
mapTo=	"internal element name"	Maps a web service element to an internal element. By default the internal element name is	<p>Internal schema element:</p> <code><todoPriority .../></code>

Mnemonic	Valid Values	Description	Examples
		<p>assumed to be the same as the web service element name. Use this attribute to assign an external facing element name in the operation schema and map it to a corresponding internal element.</p> <p>Note that this is not an XPath expression but rather a reference to a valid element name that corresponds to the structure of the expanded internal schema.</p> <p>The owner of the element must be the same as the owner of the web service schema. If an operation's underlying schema was extended (using dynamic data area extension) then the extending owner may only reference their elements on their web service schema extension for the operation.</p>	<p>Operation schema element:</p> <pre data-bbox="1141 233 1511 275"><priority mapTo="todoPriority" /></pre>
role=	"FKGP"	<p>Establishes a group structure that represents a foreign key to an entity.</p> <p>The element itself does not exist in the internal schema. It groups together the foreign key value element(s) along with a corresponding _link element that at run time provides the endpoint URL of that entity's GET operation. Consumers of the web service may use the link to get the data for the entity.</p>	<p>Internal schema element:</p> <pre data-bbox="1141 968 1273 989"><user .../></pre> <p>Operation schema group:</p> <pre data-bbox="1141 1047 1622 1152"><user role="FKGP"> <user> <_link getOperation="mo:'USER';pk1:us > </user></pre>
	"COLL"	<p>Establishes a group structure that represents a collection of entities that corresponds to an internal service list.</p> <p>The element itself does not exist in the internal schema. It groups together the internal list mapped to a _data element along with a corresponding _link element that at run time provides the endpoint URL for the collection's GET operation. Consumers of the web service may use the link to get a more detailed set of information for each entity in the list.</p>	<p>Internal schema element:</p> <pre data-bbox="1141 1404 1393 1530"><alerts type="list"> <alert/> <startDate /> <endDate /> <version /> </_data> </alerts></pre> <p>Operation schema group:</p> <pre data-bbox="1141 1589 1500 1757"><alerts role="COLL"> <_link getOperation="... " / > <_data mapTo="alerts"> <version usage="EXCL" / > </_data> </alerts></pre>

Mnemonic	Valid Values	Description	Examples
getOperation=	<p>"expression"</p> <p>Expression components:</p> <ul style="list-style-type: none"> • mo: '<maintenance object>'; • pk1: '<relative xpath to an element in the internal schema>; • pk2: '...;'; • pk3: '...;'; • pk4: '...;'; • pk5: '...;'; <p>Parameters pk2–5 are required to match the maintenance object's prime key definition.</p>	<p>By default all the elements in the referenced list are included in the operation schema. You may explicitly reference and define attributes for specific elements as needed.</p> <p>Only valid on <code>_self</code> and <code>_link</code> elements. The attribute is used to reference the default GET operation for an entity as defined by its maintenance object or business object.</p> <p>The application determines the GET operation to use as follows:</p> <ul style="list-style-type: none"> • If the entity's business object references an operation using the GET Operation option then it is used. • If the entity's maintenance object references an operation using the GET Operation option then it is used. • If a GET operation is found that references the maintenance object then it is used. <p>If a GET operation cannot be determined for the entity a standard text indicating that a link is not available is returned instead.</p>	<pre><_link getOperation="mo:'TO DO ENTRY';pk: ></pre>
	<p>"expression"</p> <p>Expression components:</p> <ul style="list-style-type: none"> • iws: '<inbound web service name>'; • operation: '<operation name>'; • parms: [<external reference as defined on the GET operation record>:<relative xpath of an element name in the internal schema that holds the value>; <another external reference name>:<another relative xpath>;...]; 	<p>Only valid on <code>_self</code> and <code>_link</code> elements. The attribute is used to reference a specific GET operation along with the information needed to compose its path parameters.</p>	<pre><_self getOperation="iws:'Fl- ToDoEntry'; operation:'getToDoEntry'; pa [ToDoEntryId:ToDoEntryId;]"/ ></pre>

Specialized Elements

The operation schema definition makes use of specialized element names in the style of the Hypermedia as the Engine of Application State (HATEOAS) standard. These elements should only be defined by the operation schema as they are not relevant to nor should be managed by the internal operation service.

The following list describes each element and how it is used.

Element Name	Description	Examples
<code><_self .../></code>	<p>Response payloads may include a "_self" element that contains the endpoint URL of the GET operation related to the entity returned in the response.</p> <p>This is an optional element and only one may exist in an operation schema.</p> <p>Refer to getOperation= schema definition attributes for more information.</p>	<pre><_self getOperation="mo:'TO DO ENTRY';pk1:ToDoEntry"> </_self></pre>
<code><_link .../></code>	<p>Response payloads may include foreign keys and for those entities, the response includes a "_link" element that contains the endpoint URL of the GET operation for that entity (if it exists).</p> <p>Refer to role= and getOperation= schema definition attribute for more information.</p>	<pre><_link getOperation="mo:'TO DO ENTRY';pk1:ToDoEntry"> </_link></pre>
<code><_data .../></code>	<p>Provides a standard reference to a list of entities in the internal schema.</p> <p>Refer to role="COLL" schema definition attribute for more information.</p>	<pre><alerts role="COLL"> <_link getOperation="... "/> <_data mapTo="alerts"> </_data> </alerts></pre>

Documentation Attributes

The following attributes provide additional documentation for individual elements that is included as part of the web service's Open API specification.

Mnemonic	Valid Values	Description	Examples
helpText=	"help text field name"	<p>Associates an element with a specific help text record defined for the Inbound Web Service. If the element is included in both request and response schema the same help text is used in both.</p> <p>If this attribute is not specified, and a single Help Text Field record exists for the Field associated with the internal element, that help text record is used. If more than one such Help Text Field record exists the one</p>	<pre><ToDoEntryId usage="BOTH" helpText="TD_ENTRY"> </ToDoEntryId></pre> <p>In this example the inbound web service defines a help text field name "TD_ENTRY" that provides help text for this element. The same help text is included for the element in both request and response schema.</p>

Mnemonic	Valid Values	Description	Examples
		<p>where the help text name is the same as the Field name is used.</p> <p>Note that an internal element is associated with a Field name via the mdField= attributes, if any, else via the mapField= attribute.</p> <p>No valid for _self and _link elements.</p>	
helpTextResponse=	"help text field name"	<p>Associates an element that is included in both request and response schema with a specific help text record to be used in the context of the response schema.</p> <p>Follows same rules as the helpText= attribute.</p>	<pre><todoEntryId usage="BOTH" helpText="TD_ENTRY"></pre> <p>In this example the inbound web service defines the following help text records:</p> <ul style="list-style-type: none"> • Help text field name "TD_ENTRY" describes the element sent in the request schema. • Help text field name "TD_ENTRY_RESP" describes the element populated in the response schema.

Deploying Inbound SOAP Web Services

Once an Inbound SOAP Web Service is defined it is not automatically available to the Web Service Clients to access the system. The Deployment Status and the Active flag (set to true) indicate whether a Web Service is available or not. The last step is to deploy the Inbound SOAP Web Services to the Java EE Web Application Server. This deployment phase has a number of steps that are automatically performed when a deployment is initiated:

- The Web Service files are generated and policies are attached.
- The WSDL is generated with appropriate annotations and enumerations.
- The necessary Java stub code to implement the Web Service in the Java EE Web Application Server is generated and compiled.
- The Web Services are built into a valid Web Application Archive (WAR) file.
- Optionally, the newly created Web Services WAR file is deployed to the Java EE Web Application Server. This can also be done manually for clustered deployments, if desired.

There are two methods available for deploying inbound SOAP web services:

- Deployment at the command line using the **iwdeploy[.sh]** command as outlined in the Server Administration Guide. This method is recommended for native installations and production implementations.
- Deployment using the Inbound Web Service Deployment portal. This method is only supported in development (non-production) environments.

Inbound Web Service Deployment Portal

To use the online Inbound Web Service Deployment portal, navigate using **Admin > Integration > Inbound Web Service Deployment**.

The following sections describe the base zones that are provided on the portal.

Deploy Inbound SOAP Web Services

The Deploy Inbound SOAP Web Services zone provides information about the last deployment. If the region is a development (non-production) region you may use the **Deploy** button to deploy or re-deploy inbound web services. All inbound web services whose Active switch is Yes will be deployed. All whose active switch is No will be undeployed.

NOTE: When an Inbound SOAP Web Service is deployed, the value of its service revision field is captured. Certain changes to configuration will require re-deployment to take effect. When any of the following changes occur, the IWS service revision value is incremented. This will cause the deployment status to show **Needs Deployment**.

- Active switch is changed
- An Annotation is added or removed
- An Operation is added or removed.
- The Operation Name, Schema Type / Schema Name, Request or Response Schema, Request or Response XSL for an Operation is changed.

NOTE: In addition, if the implementation supports XAI services deployed through IWS, the appropriate XAI inbound services will also be deployed or undeployed as required.

Deployment Status

The Deployment Status zone displays a list of inbound SOAP web services in the product, including the deployment status.

The deployment status is determined by comparing the internal Service Revision field on each IWS against the value captured at the time of deployment.

- **Deployed.** Indicates that the IWS has been deployed and no changes have been detected to the configuration.
- **Needs Deployment.** Indicates that the IWS has never been deployed or has been deployed but in the meantime, changes have been detected to the configuration that require redeployment.
- **Undeployed.** Indicates that the IWS is marked as inactive and the IWS is not found to be deployed at this time.
- **Needs Undeployment.** Indicates that the IWS is marked as inactive but the IWS is found to be deployed at this time.

If the IWS has been deployed, the View column will include a **WSDL** link allowing you to launch a separate window to view the WSDL definition.

NOTE: For cloud installations, the system supports defining the WSDL URI via a substitution value defined for the token URI: @F1_BASE_IWS_URI@. The system will use this value per the functionality described in [URI Substitution](#). When no value is defined, the system uses a default URL, which is the appropriate URL for on-premise installations.

Use the broadcast button adjacent to any of the inbound web services listed in the zone to view the details of the IWS record. This causes the **Inbound Web Service** zone to appear. It is the same zone that appears on the [Inbound Web Service](#) maintenance portal.

XAI Inbound Service Deployment Status

The XAI Inbound Service Deployment Status zone is only visible if the feature configuration option **Support XAI Services via IWS** is configured on the **External Messages** feature type or if the system detects that there are XAI inbound services that have been deployed. (The latter condition is checked for the case where an implementation has XAI inbound services deployed and then chooses to discontinue using this functionality. After changing the feature configuration option to false, one more deployment is required to "undeploy" the XAI services.) The zone displays a list of XAI inbound services in the product that are related to page services. Refer to [Deploying XAI Inbound Service via IWS](#) for more information.

The deployment status is determined by comparing the record's Version field against the value captured at the time of deployment.

- **Deployed.** Indicates that the XAI inbound service has been deployed and no changes have been detected to the configuration.
- **Needs Deployment.** Indicates that the XAI inbound service has not been deployed or has been deployed but in the meantime, changes have been detected to the configuration.
- **Undeployed.** Indicates that the XAI inbound service is marked as inactive or the **Support XAI Services via IWS** is not set to **true** and the XAI inbound service is not found to be deployed at this time.
- **Needs Undeployment.** Indicates that the XAI inbound service is marked as inactive or the **Support XAI Services via IWS** is not set to **true** but the XAI inbound service is found to be deployed at this time.

XAI inbound service does not have the equivalent of a Service Revision field that inbound web service has, which is only incremented when changes are made to the record that impact deployment. For XAI inbound service, the version number on the record is used. This field is incremented when any changes are made, even ones that may not impact deployment. As a result, some XAI Inbound Services may indicate "Needs Deployment" in cases where a redeployment may not be necessary. The recommendation when this occurs is to simply Deploy again to be safe.

If the IWS has been deployed, the View column will include a **WSDL** link allowing you to launch a separate window to view the WSDL definition.

Guaranteed Delivery

There are alternatives for sending messages to the system besides using inbound web services. An external system may be able to send messages to the system in a generic manner where a new web service does not need to be defined for every new type of message. These types of messages may provide a payload (the message) and the service script or business service to invoke. An example of this type of communication is a message sent from a mobile application using RESTful operations.

The external system may have no mechanism for retrying failed messages. For this situation, the product provides an algorithm that may be used to capture incoming messages that should 'guarantee delivery'. A servlet processing this type of message may invoke the [installation algorithm](#) - Guaranteed Delivery, passing the details of the message and an indication if a response should be returned. The algorithm is responsible for storing the message information in a table so that it can be subsequently processed.

Outgoing Messages

"Outgoing messages" is the term used to describe messages that are initiated by our system and sent to an external system. Messages may be sent real time or near real time. The system provides the following mechanisms for communicating messages to external systems.

- **Outbound Messages.** This method allows implementers to use configurable business objects to define the message format and to use scripts to build the message. If sent near real-time the message is posted to the outbound message table waiting for Oracle Service Bus to poll the records, apply the XSL and route the message. If sent real time, the message dispatcher routes the message immediately.
- **Web Service Adapters.** Using a web service adapter, an implementation can consume a WSDL from an external system and create an "adapter" record that references the URL of the external system and creates appropriate request and response data areas to expose the payload information in a format understood by configuration tools. A script may then be written to build the request information and initiate a real-time web service call from within the system.
- **Send Email.** The system supplies a dedicated business service that may be used to send an email real-time from within the application.

All these methods are described in more detail in the following sections.

Outbound Messages

Outbound messages provide functionality for routing XML messages to an external system real-time or in near real time. In addition the functionality supports collecting related messages into a batch to then be sent to an external system as a consolidate XML message.

For each outbound message that your implementation must initiate you define a [business object](#) for the outbound message maintenance object. Using the business object's schema definition, you define the fields that make up the XML source field. These are the fields that make up the basis for the XML message (prior to any XSL transformation).

Each outbound message requires the definition of its schema by creating a business object whose schema describes the information that is provided to the external system. An XSL transformation may then be performed when routing the message to an external system.

For each external system that may receive this message, you configure the appropriate message XSL and routing information.

Because the outbound message type is associated with a business object, your implementation can easily create outbound message records from a script using the **Invoke business object** step type. Such a script would do the following:

- Determine the appropriate [outbound message type](#) and [external system](#) based on business rules
- Access the data needed to populate the message detail
- Populate the fields in the schema and use the **Invoke business object** script step type for the outbound message type's business object to store the outbound message.
- The resulting outbound message ID is returned to the script and the scriptwriter may choose to design a subsequent step to store that ID as an audit on the record that initiated this message.

The following topics provide more information about functionality supported by outbound messages.

Polling Outbound Messages Using OSB

If the outbound message that needs to be sent to an external system can be sent as an asynchronous message (in 'near real time'), the process initiating the outbound message should create a record in the outbound message staging table. Oracle Service Bus (OSB), is the recommended tool to use to process outbound messages in near real-time.

Outbound messages that should be processed by OSB should be configured with a processing method defined as **SOA** for the external system / outbound message type. No other information is required for defining outbound message types that are processed by OSB.

For the OSB part of the processing, the product provides a custom transport: OUAF Outbound Message that may be used by an implementation to define messages to process and how to process them. This transport processes outbound messages in order of the priority defined on the outbound message type.

This section provides an overview of steps required to develop OSB integrations for outbound messages created by your product.

Before developing OSB integrations, a developer should be familiar with OSB development such as creating proxy services, business services, and message flow/routing. These terms are defined as follows:

Proxy Service: In OSB, a Proxy Service is the entity that processes a given type of message and routes it to a Business Service. A separate proxy service should be defined for each type of outbound message. If a given outbound message type may be routed to different external systems, it is the responsibility of the proxy service to query the external system defined on the outbound message and invoke the appropriate business service (see below). If any transformation is required prior to routing a message to a business service, it is the proxy service's responsibility to perform the transformation.

Business Service: In OSB, a Business Service is an entity that receives a message from OSB and routes it to the appropriate destination. This should not be confused with the Business Service object provided in the product in the configuration tools.

FASTPATH: Refer to the technical reference paper *OSB Integration* for more information.

Batch Message Processing

Your implementation may be required to send messages to the same destination as a single XML file with multiple messages include. The following points describe this logic:

- The individual messages that should be grouped together must have a processing method of **batch** on the external system / outbound message type record. The appropriate batch code that is responsible for grouping the messages must also be provided.
- A separate "consolidated message" outbound message type should be configured for the external system with a processing method of **SOA**.
- When outbound message records are created for the individual messages, the batch code and current batch run number are stamped on the record.
- When the batch process runs it is responsible for building the XML file that is a collection of the individual messages. This batch process should include the following steps:
 - Format appropriate header information for the collection of messages
 - Apply the individual message XSL to each message before including the message
 - Insert a new outbound message for the external system with the "consolidated message" outbound message type.
- The consolidated message is ready to be processed by Oracle Service Bus.

NOTE: No process provided. The system does not supply any sample batch job that does the above logic.

Real Time Messages

The system supports the ability to make web service calls, i.e. sending real time messages, to an external system.

The system supports special functionality for sending an Email message real-time. Refer to [Sending Email](#) for more information.

For other types of real-time messages, the system also uses outbound message type and external system configuration to format and route the message. When defining the configuration for real time messages, an additional step is required to define the mechanism for routing the message using a message sender. The system supports routing messages via HTTP and via JMS. Note that for HTTP routing, the system also supports sending the message using a JSON format.

Just like near real-time messages, initiating a real-time outbound message may also be done from a script. When a real time message is added, the system immediately routes it to the external system. If the external system provided a response message back, the system captures the response on the outbound message. If the outbound message type for the external system is associated with a response XSL it is applied to transform the response. In this case the system captures the raw response as well on the outbound message. Note that the outbound message BO should be configured to capture a response XML in its schema.

Any error (that can be trapped) causes the outbound message to be in a state of **Error**. It is the responsibility of the calling process to check upon the state of the outbound message and take a programmatic action. When the outbound message state is changed back to **Pending** the message will be retried.

The base package provides two business services: Outbound Message Dispatcher (**F1-OutmsgDispatcher**) and Outbound Message Mediator (**F1-OutmsgMediator**) that further facilitate making web service calls. Both business services are similar, allowing the calling script to configure the following behavior (with differences noted):

- Whether or not exceptions encountered while sending the message are trapped. Trapping errors allows the calling script to interrogate any errors encountered and take some other programmatic action.

- Whether or not the sent message is persisted as an actual outbound message record.
 - If a persisted message is desired, the recommendation is to use the Outbound Message Dispatcher. This business service creates the message using standard BO processing, relying on the outbound message logic to route the message and store the record. The message is routed after the BO pre-processing algorithm and after the record is persisted but before the BO post-processing and audit plug-ins are executed. If you need to send the outbound message ID as part of the message, refer to [Capturing the Outbound Message ID in the Message](#) for more information.
 - If the message should not be persisted, then the recommendation is to use the Outbound Message Mediator. As mentioned, the Outbound Message Dispatcher creates the outbound message record, relying on the outbound message logic to route the message. If it should not be persisted, it is subsequently deleted. In contrast the Outbound Message Mediator executes the BO pre-processing algorithms and then routes the message explicitly without creating a message record. It is more efficient for scenarios that don't require persistence. Note that the Outbound Message Mediator also supports persistence, but it does so by creating the records without using BO processing. This is not recommended. The Dispatcher is the better option if persistence is desired.

Refer to the descriptions of the two business services for more information.

Designing the System for Outbound Messages

The following sections describe the setup required when using [Outbound Messages](#) to communicate with an external system. The configuration walks you through the steps to configure a single external system and all its messages.

Define the Outbound Message Business Object and Type

The product supplies many outbound message Business Objects along with Outbound Message Types for out of the box functionality.

In addition, implementations may need to define configuration for custom outbound messages. For each outbound message that must be sent to an external system, create a [business object](#) for the outbound message maintenance object. Using the business object's schema definition, your implementation defines the elements that make up the XML Source field (XML_SOURCE). These are the elements that are the basis for the XML message. XSL transformations may be applied to this XML source to produce the XML message.

If your integration is real-time and a response is expected, the Outbound Message business object should also map to the XML Response field (XML_RESPONSE).

- You may decide to capture the response as is and define the element as “raw”. For example

```
<responseDetail mapXML="XML_RESPONSE" type="raw"/>
```

In this scenario, a Response XSL may or may not be needed.

- Alternatively, if the details of the response are needed, you may define specific elements for the response. For this option, depending on how the integration is designed, a Response XSL may be needed to transform the response into the expected XML format.

Once you have your business object and schema, define an [outbound message type](#) for each unique outbound message.

Referencing an XSL

The system supports defining the XSLs as a [managed content](#) record. For backward compatibility, the system supports defining the XSL as a file in the file system. This is a system wide setting, defined using a feature configuration option. The feature type is **External Messages** and the option type is **XSL Location**. Set the value to **F1FL** to support XSL in the file system. The file location is configured using a system property. To support the XSL in managed content, no option is needed as this is the default. You may explicitly define the value of **F1MC** if desired.

Capturing the Outbound Message ID in the Message

If your integration would like to use the system generated Outbound Message ID as a unique identifier with the external system, the following configuration is needed:

- Define an element within the XML Source that should be populated with the system generated outbound message.
- Configure a BO Option on the outbound message's business object using the Option Type **Outbound Message ID XPath** and set the Option Value to the XPath of the element defined to capture the ID.

NOTE: This functionality is only applicable if the outbound message is persisted.

Support for Dynamic URLs

The product supports the ability to build a dynamic URLs. These are cases where the URL requires information determined at runtime. This is supported with a combination of BO schema definition, URL configuration and appropriate code when creating the outbound message. The following points highlight the steps needed to support this functionality.

- When defining the [Message Sender's](#) URL, use the syntax **\${pathParms}** in the location of the URL where runtime information must be inserted. For example: **http://[SERVER_NAME]:1000/rest/services/\${pathParms}**
- Include the data area **F1-OM-DynamicConfig** (Outbound message dynamic configuration) in the schema of the business object for the outbound message. This data area includes elements for **pathParms** and **queryParms**.
- In the code that creates the outbound message, populate the **pathParms** and if applicable **queryParms** elements with the appropriate information. The system will build the URL by plugging in the **pathParms** element value followed by a question mark, followed by the **queryParms** element value into the **\${pathParms}** location in the URL.

The following is an example of run time values.

```
<dynamicConfiguration>
  <pathParms>job/1234</pathParms>
  <queryParms>firstName=John&lastName=Doe</queryParms>
</dynamicConfiguration>
```

Add SOAP Header Parameters at Runtime

The product supports the ability to add SOAP header parameters to an external message at runtime. The following points highlight the steps needed to support this functionality.

- Include the data area **F1-OM-DynamicConfig** (Outbound message dynamic configuration) in the schema of the business object for the outbound message. This data area includes the element **soapHeaders**.
- In the code that creates the outbound message, populate the **soapHeaders** element with the self contained XML to add to the SOAP header section of the outgoing SOAP request.

Real-Time Message Configuration

Messages are routed to an external system real-time using the outbound message dispatcher or using the real-time send email business service. The system supports routing messages using HTTP and routing messages using JMS. In addition, there is a special type of message sender used for sending emails. The following sections highlights the supported real-time communication and the configuration needed for each.

Email Messages

For sending emails, the following configuration is needed:

- Define a [message sender](#) configured for email. Senders of this type should be configured with the **RTEMAILSNDR** class. The sender context is used to configure the connection information for the connecting to the SMTP server.

- This sender may be defined as the default email sender on the [message option](#) table. Alternatively, the message sender can be provided to the business service as input. Refer to [Sending Email](#) for more information.

Outbound Messages

For other outbound messages that are routed using the real-time outbound message dispatcher, a [message sender](#) must be configured to define how to route the message. The following points highlight more detail related to this configuration.

Determine the communication mechanism prior to configuring the sender.

- When routing the message using JMS, the following configuration must be defined
 - Define an appropriate [JNDI Server](#) that indicates where the JMS resources are located.
 - Define a [JMS Connection](#) to define additional configuration needed for the connection.
 - Define the [JMS Queue](#) or [JMS Topic](#) to define the queue or topic to use.
- When communicating using a JSON format, determine the method to use to convert the XML to JSON. The desired method is driven by how the request should be sent.
 - If choosing the **Base JSON Conversion** method, if XSL transformation needs to be applied prior to the conversion to JSON, then the target XML Request Schema must be defined (using a data area) so that the conversion logic knows the format of the XML it is converting. The XSL is applied to the outbound message's XML Source, resulting in the defined XML Request Schema, which is then converted to JSON. If XSL transformation is not required, then the outbound message's XML Source is converted to JSON.
 - If choosing the **Rootless JSON Conversion** method, the group element mapped to the XML source field is removed by the conversion, resulting in a rootless JSON request document.
 - If the XML source on the outbound message can be converted to JSON using an XSL, then the **XSL Transformation** method may be chosen.
 - You may also choose to convert the XML Source to JSON via the **Standard API Conversion** method (using a Jettison library). With this method, an XSL may optionally be provided. The conversion will be performed on the transformed XML.
 - For the response, if the outbound message BO defines detailed elements for the XML Response field, then the JSON should be converted to this format.
 - If your conversion method is **Base JSON Conversion**, then if the JSON response cannot be converted directly to the XML Response elements on the outbound message BO, then define a Response Schema (data area) that represents the results for the base JSON conversion. In addition, define an XSL that can transform the response from the converted XML to the XML format expected on the BO.
 - If your conversion method is **Rootless JSON Conversion**, the response document is assumed to be rootless. The group element mapped to the XML response field is added by the conversion process, resulting in a well formed XML response document.
 - If the conversion method is **Standard API Conversion** or **XSL Transformation**, the standard API is used to convert JSON to XML. An XSL may be defined to convert the response to the XML Response if needed.
 - If the outbound message BO defines a "raw" element to capture the response, then a response schema and XSL are not necessary. In this case, the system will perform a JSON to XML conversion using the **Standard API Conversion** method (regardless of the conversion method defined) and the result is captured in the XML response.
- For HTTP senders including JSON senders, the system provides the following support for sending messages secured by OAuth authentication:
 - Using Oracle Web Services Manager (OWSM). The system provides a pre-configured set of policies for OAuth (**F1-OAUTH**) using a special extendable lookup. Note that the values of this policy set defines a specific CSF key repository that the implementation should use for capturing its CSF keys. In addition, there is a substitution value defined for the token URI: @F1_OAUTH2_URI@. Configure the appropriate URI for this implementation as

described in [URI Substitution](#). By default the system does not support additional policy sets to be defined. If your implementation requires a different policy set, contact support.

- You may provide OAuth related settings as part of the [message sender](#) configuration for a REST API.

Define a [message sender](#) configured for each appropriate routing method. The invocation type should be configured as **Real-time**. For routing via HTTP, use the **RTHTTPSNDR** - HTTP sender class. For routing via HTTP with SOAP format automatically applied, use the **SOAPSNDR** - HTTP SOAP sender class. For routing via HTTP using JSON format, use the **RTJSONSNDR** - JSON sender class. For routing via JMS, use the **RTJMSQSNDR** - JMS queue sender class or **RTJMSTSNDR** - JMS topic sender class and configure the JMS Connection and JMS Queue or JMS Topic. Use the sender context to configure the required values for connecting to the appropriate destination.

NOTE: Refer to [Support for Dynamic URLs](#) for configuration needed to support dynamic URLs when sending an outbound message. There is specific configuration expected when defining the URL on the Sender in order to support dynamic URLs.

Configure the [external system](#) / outbound message type collection. The processing method defined for the external system / outbound message type must be **Real-time**.

Define the External System and Configure the Messages

Define an [external system](#) and configure the valid outgoing messages and their method of communication (processing method). Refer to [Outbound Messages](#) for more information.

Outbound Message Schema Validation

The outbound messages that are generated by the system should be well formed and valid so that they do not cause any issues in the external system. To ensure this validity you may configure the system to validate messages before they are routed to their destination. Note that the validation is applied just before communication with the sender and therefore after any Request XSL has been applied.

- Define a directory where the valid W3C schemas are located using the Message option **Outbound Message Schema Location**.
- Each [external system](#) message must indicate the appropriate W3C schema to use for validation.

You may turn on or off this validation checking using the Message option **Schema Validation Flag**.

This feature is not supported for cloud implementations.

Configuring the System for Outbound Messages

The following sections describe the setup required when using [Outbound Messages](#) to communicate with an external system.

JNDI Server

If using JMS to communicate outbound messages, define a new JNDI Server. Open **Admin > Integration > JNDI Server**.

Description of Page

Enter a unique **JNDI Server** and **Description**.

Indicate the Provider URL to indicate the location of the JNDI server. A variable may be used in place of all or part of the URL. The variable must be predefined in the substitution variable property file. The value here should enclose the variable name with @. Refer to [Referencing URIs](#) for more information.

Indicate the **Initial Context Factory**, which is a Java class name used by the JNDI server provider to create JNDI context objects.

JMS Connection

To define a JMS Connection, open **Admin > Integration > JMS Connection**.

Description of Page

Enter a unique **JMS Connection** and **Description**.

Indicate the **JNDI Server** to be used. Refer to [JNDI Server](#) for more information.

Use the **JNDI Connection Factory** to indicate the lookup keyword in the JNDI server used to locate the JMS connection.

Where Used

JMS Queue

To define your JMS Queue values, open **Admin > Integration > JMS Queue**.

Description of Page

Enter a unique **JMS Queue** and **Description**.

Enter the **Queue Name** as defined in the JNDI server. This is the JNDI lookup name identifying the queue.

Use the **Target Client Flag** to indicate whether or not the target client is **JMS** or **MQ**.

Select the **JNDI Server** where the queue is defined. Refer to [JNDI Server](#) for more information.

JMS Topic

To define your JMS Topic values, open **Admin > Integration > JMS Topic**.

Description of Page

Enter a unique **JMS Topic** and **Description**.

Select the **JNDI Server** where the topic is defined. Refer to [JNDI Server](#) for more information.

Enter the **Topic Name** as defined in the JNDI server. This is the JNDI lookup name identifying the topic.

Message Sender

The topics in this section describe the maintenance of a message sender

Message Sender - Main

To define a new sender, open **Admin > Integration > Message Sender**.

Description of Page

Enter a unique **Message Sender** and **Description**.

CAUTION: Important! When adding new records, carefully consider the naming convention of the message sender code. Refer to [System Data Naming Convention](#) for more information.

Set **Invocation Type** to **Real-time**.

Indicate the **Message Class** for this sender, which indicates the method used to route the message. The valid sender classes are as follows:

Message Class	Description
RTEMAILSNDNR	Email sender.
RTHTTPSNDR	HTTP sender.
RTJMSQSNDR	JMS queue sender.
RTJMSTSNDR	JMS topic sender.
RTJSONSNDR	HTTP JSON sender.
SOAPSNDNR	HTTP SOAP sender.

Indicate whether or not this sender is currently **Active**.

For JMS related senders, indicate whether the **MSG Encoding** is **ANSI message encoding** or **UTF-8 message encoding**. (Note that for all other types of senders, the Character Encoding context type is used to configure encoding.)

If the Message Class is one that connects to a JMS Queue or JMS Topic, indicate the appropriate **JMS Connection**

FASTPATH: Refer to [JMS Connection](#) for more information.

If the Message Class is one that connects to a JMS queue, indicate the name of the **JMS Queue** to define where the message is to be sent.

FASTPATH: Refer to [JMS Queue](#) for more information.

If the Message Class is one that connects to a JMS topic, indicate the name of the **JMS Topic** to define where the message is to be sent.

FASTPATH: Refer to [JMS Topic](#) for more information.

Message Sender - Context

The sender may require context information to define additional information needed by the system to successfully send outgoing messages. Open **Admin > Integration > Message Sender** and navigate to the **Context** page.

Description of Page

Define the **Context Type** and **Context Value**, which contain parameters for senders when more information is required. See below for the supported context values for different types of senders.

Email Sender Context

The email sender is used by the business service that [sends email messages real-time](#).

An email sender must point to the Message Class **RTHTTPSNDR**. In addition, the following context records should be defined for senders of this type.

Context Type	Description
SMTP Host name	The SMTP server host name.
SMTP Username	The user ID used to access the SMTP server.
SMTP Password	The password used to access the SMTP server.
Response Time Out	The amount of time the system should wait for a real time response.

HTTP Sender

An HTTP sender is one that sends messages to an HTTP server using the HTTP protocol. HTTP senders should reference a Message Class of **RTHTTPSNDR**, **RTJSONSNDR** or **SOAPSNDNR**.

Various parameters are required to establish a session with the target HTTP server. You specify these parameters by defining a collection of context values for the sender. A set of context types related to HTTP variables is provided with the product. The following section describes the context types and where appropriate, indicates valid values.

Before defining the HTTP sender, you need to find out how the HTTP server on the other side expects to receive the request, and in particular, to answer the following questions:

- What is the address of the HTTP server?
- Is the HTTP server using a POST or GET HTTP method?
- If the server is using POST, how are message contents passed? Does it use an HTTP FORM or does it pass the data in the body of an XML message?

Context Type	Description	Values
HTTP URL1 - URL9	<p>Used to construct the URL of the target HTTP server.</p> <p>Since the URL may be long and complex, you can break it into smaller parts, each defined by a separate context record. The full URL is built by concatenating the values in URL1 through URL9.</p> <p>You may use substitution variables when entering values for URL parts. Note that the substitution string @XMLMSG@ may be used for GET calls if an XSL has been applied to convert the message into HTTP GET parameters. It is useful if the HTTP Form is not applicable to the type of message.</p> <p>Refer to Support for Dynamic URLs for configuration needed to support dynamic URLs when sending an outbound message.</p>	
HTTP Method	<p>The HTTP method used to send the message.</p> <p>NOTE: The SOAP sender message class SOAPSNDR only supports the POST method.</p>	POST or GET
HTTP Transport Method	<p>Specifies the type of the message. You can either send the message or send and wait for a response.</p>	Send or sendReceive
HTTP Form Data	<p>Used when the message is in the format of an HTML Form (Content-Type: application/x-www-form-urlencoded).</p> <p>This context specifies the form parameters (data) that should be passed in the HTTP message. Since a form may have multiple parameters, you should add a context record for each form parameter.</p> <p>The value of a form parameter takes the format of x=y where x is the form parameter name and y is its value.</p> <p>If y contains the string @XMLMSG@ (case sensitive) then this string is replaced by</p>	

Context Type	Description	Values
	<p>the content of the service response XML message. The @XMLMSG@ string can be used in the HTTP Form Data or in the HTTP URL, but not in both.</p> <p>If a context record of this type is defined for a sender, the sender uses the HTML Form message format to send the message even if @XMLMSG@ is not specified in one of the context records.</p> <p>If a context record of this type is not defined for a sender, then the XML is sent with <code>Content-Type: text/plain</code>. When using POST it is put in the HTTP message body.</p> <p>Always required when using the GET method. If you are using the GET method and do not specify a Form Data context record, no message is transferred to the HTTP server.</p> <p>You may use substitution variables when entering values for Form Data.</p>	
HTTP Login User	The HTTP server may require authentication. Add a context record of this type to specify the login user to use.	
HTTP Login Password	The HTTP server may require authentication. Add a context record of this type to specify the login password to use.	
HTTP Header	<p>Sometimes the HTTP server on the other side may require the addition of HTTP headers to the message.</p> <p>For each HTTP header that has to be specified you should add a context record with a value having the following format <code>x:y</code> where <code>x</code> is the header name and <code>y</code> is the value for the header</p>	
HTTP Time Out	Indicates the amount of time to wait for a connection to be established with the remote system.	
Character Encoding	Indicates if the message should be encoded. The sender will add to the HTTP's content type header the string <code>; charset=x</code> where <code>x</code> is the value of this context and when sending the message it will encode the data in that encoding.	UTF-8 or UTF-16
Response Time Out	The amount of time the system should wait for the remote system to send a response.	
Sender Security Type	Indicate the desired security type to apply. (Note that additional security types are applicable only to the SOAP Sender. See below for more information.)	BASIC (HTTP Basic), TEXT (Username Token plain text), DIGEST - Username Token Digest, OWSM - OAuth Security via OWSM, OAUTH - OAuth Security.

OWSM Policy Set	Applicable only if the Sender Security Type is OWSM . Defines the policy set to apply.	Enter a valid value for the extendable lookup Set of Policies (F1-SetOfPolicies). The product provides the value F1-OAUTH that may be used here.
OAuth Grant Type	Applicable only if the Sender Security Type is OAUTH . Defines the OAuth specification method for acquiring an access token.	client_credentials
OAuth Access Token URL	Used to construct the URL of the target authorization server. You may use substitution variables to construct the URL.	
OAuth Client ID	The generated identifier for the current application in the external system's authorization server.	
OAuth Client Secret	The secret paired with the OAuth Client ID as provided by the external system's authorization server.	
OAuth Key Ring	Defines the key ring used to store the OAuth Client ID and secret provided by the external system's authorization server. If a key ring is specified, the OAuth Client ID and OAuth Client Secret context entries are not allowed.	
OAuth REST API Scope	The authorization level granted by the end point.	
OAuth Token Request Details in Body	By default, the authorization token request includes the Client ID and Secret information in the message header. This context type may be used to indicate that this information should be sent in the body of the request instead.	Set this to 'Y' to send the Client ID and Secret information as part of the body of the authorization token request.

Real-time HTTP Sender

The following context type is only applicable to senders with the **RTHTTPSNDR** message class.

Context Type	Description
Content Type	Populate a value here to override the Content-Type attribute in the HTTP header, which defaults to text/xml .

SOAP Sender

A SOAP sender is an HTTP sender that automatically adds support for the SOAP format. For this type of sender (message class of **SOAPSNDR**), besides the context values listed above, the following context entries may also be supplied.

Context Type	Description	Values
Message Namespace URI	Used to indicate a specific namespace to be included in messages for this sender. Note that this value is used only when the External Message link to this sender is configured with	

Context Type	Description	Values
	a Namespace Option of Configured on Sender .	
SOAP Insert Timestamp	Indicate whether a timestamp should be added. Default value is 'N'.	Y or N
SOAP Expiration Delay (in seconds)	Indicate an expiration delay to add to the timestamp. The default value is 60.	
Sender Security Type	Additional security types are supported for SOAP senders for specific third party integrations.	CIM - Uses an appropriate namespace and adds security information in the SOAP header specific to Landis+Gyr, MS_V30 - Uses an appropriate namespace and adds security information in the SOAP header specific to MultiSpeak v3.0, MS_V41R - Uses an appropriate namespace and adds security information in the SOAP header specific to MultiSpeak v4.1, ITRON - Uses appropriate SOAP header information security information in the SOAP header specific to Itron.

NOTE: Refer to [Add SOAP Header Parameters at Runtime](#) for information about dynamically including SOAP Header parameters when sending a message.

JMS Sender

A JMS sender is one that sends messages to a JMS queue or JMS topic. JMS senders should reference a Message Class of **RTJMSQSNDR** or **RTJMSTSNDR**, respectively.

The following parameters are used to connect to the JMS resource.

Context Type	Description	Values
JMS Message Type (Bytes(Y)/Text(N))	Indicates whether the data is sent as a bytes message or as a text message.	Y or N
JMS User Name	Enter the user name to connect to the JMS resource.	
JMS User Password	Enter the password to use to connect to the JMS resource.	
JMS Header	If JMS header values are required for the message, use this context type. For each JMS header that has to be specified, add a context record with a value having the following format x:y where x is the header name and y is the value.	

Defining Outbound Message Types

Refer to [Outbound Messages](#) for an overview of this functionality.

Use this page to define basic information about an outbound message type. Open this page using **Admin > Integration > Outbound Message Type**. You are brought to a query portal with options for searching for outbound message types.

NOTE: This page is not available if the **External Message** module is [turned off](#).

Once an outbound message type has been selected, you are brought to the maintenance portal to view and maintain the selected record.

The **Outbound Message Type** zone provides basic information about an outbound message type. Besides the code and description, the outbound message type captures the outbound message business object and the relative priority of the outbound message. The priority is only applicable if the [outbound message is processed using OSB](#). In addition, if the outbound message type is linked to any web service categories, they are displayed.

CAUTION: Important! When adding new records, carefully consider the naming convention of the outbound message type code. Refer to [System Data Naming Convention](#) for more information.

Note that in addition to standard actions available on this portal, there is also a special **Add to Category** button in the page action area. Click this button to link an outbound message type to one or more [web service categories](#).

The **External System Links** zone is visible if the outbound message type is linked to any external systems.

External Systems

Use this page to define an external system and define the configuration for communication between your system and the external system.

External System - Main

Open this page using **Admin > Integration > External System**.

NOTE: This page is not available if both the **External Message** and the **Open Market Interchange** modules are [turned off](#).

Description of Page

Enter a unique **External System** and **Description**.

CAUTION: Important! When adding new records, carefully consider the naming convention of the external system code. Refer to [System Data Naming Convention](#) for more information.

Use the field **Our Name In Their System** to specify the identity of your organization (i.e., your external system identifier) in the external system.

NOTE: The workflow process profile and notification download profile are only applicable to products that support workflow and notification. They are not visible in the product if the **Open Market Interchange** module is [turned off](#).

If this external system sends inbound communications through notification upload staging, the type of workflow process that is created is controlled by the sender's **W/F (Workflow) Process Profile**.

If you send notifications to this external system, select a **Notification DL (download) Profile** that is used to define the configuration of the outgoing messages.

NOTE: The remaining fields are not visible if the **External Message** module is [turned off](#).

Set **Usage** to **Template External System** for external systems whose outbound message type configuration is inherited by other external systems.

If the outbound message type configuration should be inherited from a template external system, define the **Template External System**. If this field is specified, the outbound message type collection displays the data defined for the template system as display-only.

The **Outbound Message Type** accordion contains an entry for every type of outbound message defined for this external system. For each type of outbound message identify its **Outbound Message Type**.

Define the **Processing Method** for messages of this type. Valid values are **Batch**, **Real-time**, **SOA** and **XAI**.

Define an appropriate **Message Sender** if the processing method is **XAI** or **Real-time**.

Namespace Option is used when your message should include a namespace in the resulting XML. The valid options are **Standard Namespace** and **Configured on Sender**. If the value is Standard Namespace, the system will generate a namespace for the resulting WSDL with the following value: **http://ouaf.oracle.com/outbound/AAA_BBB**, where AAA is the external system code and BBB is the outbound message type code. If the value is Configured on Sender, then the value of the namespace is taken from the sender context with context type **Message Namespace URI**.

Define an appropriate **Batch Control** if the processing method is **Batch**.

If the message sender is one with a message class of **RTJSONSNDR**, indicate the **JSON Conversion Method**. The valid values are **Base JSON Conversion**, **Standard API Conversion** and **XSL Transformation**. Refer to [Real Time Message Configuration](#) for more information about these methods and the additional configuration that may be applicable.

If the **JSON Conversion Method** is **Base JSON Conversion**, the **Request Schema** is enabled. Populate a data area that defines the schema for the XML format to convert the outbound message's BO schema to prior to performing the JSON conversion. Refer to [Real Time Message Configuration](#) for more information.

The **Message XSL** is the schema used to transform information from the format produced by the system to a format understood by the sender, who receives a message of this type. This is not applicable for Processing Method of **SOA**. Refer to [Referencing an XSL](#) for information about configuring where the XSL is defined.

Enter the file name of the appropriate **W3C Schema** if you want to validate the message built for outbound messages for this external system / outbound message type prior to being routed to their destination. Refer to [Outbound Message Schema Validation](#) for more information. This is not applicable for Processing Method of **SOA**. This feature is not available for cloud implementations.

If the **JSON Conversion Method** is **Base JSON Conversion**, the **Response Schema** is enabled. Populate a data area that defines the schema for the XML format that the JSON message is initially converted to. The XML is then converted to BO XML. Refer to [Real Time Message Configuration](#) for more information.

Response XSL will only be displayed when the processing method is **Real-time**. Refer to [Real Time Messages](#) for more information on how it is used. Refer to [Referencing an XSL](#) for information about configuring where the XSL is defined.

External System - Template Use

If you are viewing an external system whose usage is a **Template External System**, use this page to view the other external systems that reference this one. Open this page using **Admin > Integration > External System** and then navigate to the **Template Use** tab.

Description of Page

The tree shows every external system that references this external system as its template.

Message Option

The Message Option page defines various system settings used by the system when processing external messages.

To define options for your environment, open **Admin > Integration > Message Option**.

Description of Page

The following options are supported.

Option	Description	Option Name
Default Email Sender	This is the default Message Sender used for sending e-mails when no explicit Message Sender is specified.	defaultEmailSender
Default User	The default user is used by the system to access your product when no other user is explicitly specified.	defaultUser
Email Attachment File Location	This is the default location of e-mail attachment files. If not specified, the e-mail service provided with the product assumes a full path is provided with each attachment file.	emailAttachmentFileLocation
Email XSL File Location	This is the default location of e-mail XSL files. If not specified, the e-mail service provided with the product assumes a full path is provided to an XSL file as part of an e-mail request.	emailXSLFileLocation
Messages Language	The default language to use for the messages.	language
Outbound Message Schema Location	Enter the full path of the virtual directory where valid W3C schemas are stored if your implementation wants to validate outbound message schemas . For example: http://localhost/cisxai/schemas.	xaiOuboundSchemaLoc
Schema Validation Flag	Enter Y to turn on schema validation for outbound messages . Enter N to turn this off.	xaiSchemaValidationCheck

Note that the following options are no longer applicable.

Option

To Do Type for Inbound JMS Message Errors

To Do Type for Outbound Message Errors

XSD Compliance

Managing Outbound Messages

Use this page to view information about outbound messages.

Outbound Message - Main

Open this page using **Menu > Integration > Outbound Message**.

Description of Page

Outbound Message ID is the system-assigned unique identifier of the outbound message. These values only appear after the outbound message is added to the database.

The **Processing Method** indicates whether this record will be processed by a **Batch** extract process or **Real-time**. (The value of **XAI** is no longer supported). The value defined on the external system / outbound message type collection populates this value.

When records are created with a processing method of **Batch**, the system sets Extract to **Can Be Extracted**. Change the value to **Not to be extracted** if there is some reason that processing should be held for this record.

For records with a processing method of **Batch**, **Batch Control** indicates the process that will extract this record. This value is populated based on the on the external system / outbound message type's value. **Batch Number** indicates in which batch run this record was extracted or will be extracted.

The **Retry Count** is no longer applicable..

The **Creation Date** indicates the date that this record was created.

The status is no longer applicable.

Outbound Message - Message

Use this page to view the XML source used to build an outbound message. Open this page using **Menu > Integration > Outbound Message** and then navigate to the **Message** tab.

Description of Page

The **XML Source** is displayed.

If a message XSL is defined on the external system / outbound message type record linked to this outbound message, the **Show XML** button is enabled. Click this button to view the XML that is a result of applying the Message XSL to the XML source.

Outbound Message - Response

Use this page to display the XML response. Open this page using **Menu > Integration > Outbound Message** and then navigate to the **Response** tab.

Description of Page

The **XML Response** and optionally the **XML Raw Response** is displayed.

XML Response displays the response data from the system called by the real-time message. If a response XSL is defined on the external system / outbound message type record linked to this outbound message, a transform is performed and the XML Raw Response displays the original, unchanged response.

Web Service Adapters

The base product provides a configuration object called Web Service Adapter that is used to help build configuration objects to allow for functionality in the system to initiate a web service call from within the system. A Web Service Adapter provides the following functionality:

- WSDL (web service description language) import. An implementer can use the WSDL import functionality to read the details of a WSDL into the system
- Internal API generation. The system generates internal data areas that have two main purposes: they provide the API for custom code to define the appropriate input and they provide output data for the web service call using Oracle Utilities Application Framework schema language. In addition, the web service dispatcher uses element mapping defined in the data areas to transform the internal XML into the structure expected by the external system as described in the WSDL.
- Defines the URL needed to perform the web service call at runtime.

Understanding Web Service Adapters

The following topics describe the system functionality in more detail.

Importing a WSDL

Configuring a Web Service Adapter starts by identifying the WSDL (the web service description language document used to define the interface) that will be provided by the external system. The following steps describe the base product functionality provided to allow a user to import a WSDL.

- Navigate to the **Web Service Adapter** page in add mode and select the appropriate base business object.
- Enter a meaningful Web Service Name and appropriate descriptions.
- Provide the URL of the given WSDL.

- Click **Import** to retrieve the details of the WSDL. The system then parses the WSDL details and populates the WSDL Service Name, WSDL Source, WSDL Port, URL and a list of Operations (methods) defined in the WSDL.
- Determine which Operations should be **active** based on the business requirements for invoking this web service. **Active** operations are those that the implementation is planning to invoke from the system. These require appropriate request and response data areas generated for them. The following section provides more information about that.
- Specify the appropriate Security Type to configure the type of security to use when invoking this web service.
- Click Save.

At this point, a web service adapter record is created in pending status. The next step is to generate the request and response data areas for the operations configured as active.

Generating Request and Response Data Areas

Each **active** operation for the web service adapter requires a pair of data areas, request and response, that represent the request and response XML messages for the operation.

The base product provides steps to generate the data areas as follows:

- As described in the Importing a WSDL section above, the operations listed in the WSDL are generated for the web service adapter and the implementer should indicate which operation to activate.
- After saving the **pending** web service adapter, the display lists all the active operations and for each one includes a **Generate** button.
- After clicking **Generate** for an operation, a window appears where the names of the new Request and Response Data Areas may be defined. Click **Save** to generate the data areas.

The generated data areas provide the API for the implementer to use when implementing the web service call in an appropriate algorithm or service in the system. The data areas contain the appropriate mapping from the elements that the implementer works within the code that invokes the web services and the WSDL definitions.

To facilitate generating the request and response data areas, the base product invokes a special business service used to create the appropriate mapping. The business service is defined as a BO option on the Web Service Adapter business object. This allows an implementation to provide a custom business service to further enhance the request and response mapping where appropriate.

NOTE:

Generated data areas. It is possible to edit and modify the generated data areas after they are created. An implementer can change element names or remove unneeded elements if desired. Manually changing the generated data areas must be done only when absolutely necessary. This is because the system is not able to validate manual changes and issues with the data areas would only be detected at run time.

Activating Web Service Adapters

The business objects provided by the base package for web service adapters include a simple lifecycle of **Pending** and **Active**. Configure the web service adapter and its data areas while in **Pending** status and activate it when it is ready to be implemented in the appropriate system functionality.

Invoking Web Services

To make a call to a web service using a web service adapter, the system has provided a Web Service Dispatcher business service (**F1-InvokeWebService**) to submit a web service call. The calling program is responsible for retrieving all the information to correctly populate the request data required by the web service call before invoking the business service.

NOTE:

Refer to the detailed description of the business service for more information.

Limitations

The following points highlight limitations associated with the types of web services that the system supports:

- It is possible for one WSDL document to contain definitions for several web services. The system currently supports only one port or service per WSDL document.
- It is possible for a WSDL to support multiple message patterns. The system currently supports only request / response.

Setting Up Web Service Adapters

Use the Web Service Adapter portal to define the configuration needed to communicate with an external system using a web service call. Open this page using **Admin > Integration > Web Service Adapter**. You are brought to a query portal with options for searching for web service adapters.

Once a web service adapter has been selected, you are brought to the maintenance portal to view and maintain the selected record.

The **Web Service Adapter** zone provides basic information about the web service annotation type.

Please see the zone's help text for information about this zone's fields.

FASTPATH: Refer to [Understanding Web Service Adapters](#) for information about common web service adapter functionality.

Sending Email

The framework provides the ability to initiate an email from within the system. The following topics highlight the functionality available.

- Sending email "real time" using a specific business service. The framework provides a business service **F1-EmailService** that supports sending an email. The schema supports elements for all the information required to create an email real time. The SMTP information (host, user name and password) may be provided or may be defined on a message sender, that may be provided as input. In addition, the business service supports using a default message sender defined as a [message option](#). Review the business service schema for information about the input elements.

NOTE: Retry setting. An option in the system properties file allows your implementation to configure the number of times to retry (if any) if the SMTP server is unavailable. Refer to the server administration guide for more information.

- The business service supports sending attachments. The may either reference attachments from the file system (file name and content ID) or reference attachment records captured in the system's attachment table. Note that attachments in the file system are not supported in a cloud implementation.

NOTE: Validating attachments. If a Validate Email Attachment algorithm is plugged into the [installation record](#), it is called to validate the attachments supplied, if applicable.

- Using an outbound message to send an email. This option allows for different variations as described in [Outbound Messages](#).
 - Some emails may be created en masse (for example a large group of emails routed to users for a given set of To Do entries). In this case, the records can be created in the staging table for processing using OSB.
 - Messages may still be sent real time using one of two business services described in [Real Time Messages](#). This option is an alternative to the dedicated email service described above when aspects of the outbound message functionality

are needed, such as the ability to instantiate a record as an audit or to include additional logic via BO plug-ins as part of sending the email.

Web Service Category

The product provides the ability to categorize web services that are defined in the system. The term web services refers to Outbound Message Types, Inbound Web Services, and for those implementations where they are applicable, XAI Inbound Services.

A given web service may be linked to more than one category. The product supplies web service categories and most base delivered web services are configured with appropriate categories. Implementations may define new categories and may link custom web services to base delivered categories or to custom categories. In addition, implementations may link additional categories to base delivered web services. However, implementations may not remove base delivered web services from base delivered categories.

If your implementation uses the [Integration Cloud Service Catalog](#), the integration provides the categories for each web service that is sent to the catalog.

The web service category portal supports adding and removing web services from the category. In addition, the [Outbound Message Type](#) portal and [Inbound Web Service](#) portal each provide a page action button to **Add to Category**.

Defining Web Service Categories

Refer to [Web Service Category](#) for an overview of this functionality.

Use this page to define basic information about a web service category. Open this page using **Admin > Integration > Web Service Category**. You are brought to a query portal with options for searching for web service categories.

NOTE: This page is not available if the **External Message** module is [turned off](#).

Once a web service category has been selected, you are brought to the maintenance portal to view and maintain the selected record.

The **Web Service Category** zone provides basic information about a web service category.

CAUTION: Important! When adding new records, carefully consider the naming convention of the web service category code. Refer to [System Data Naming Convention](#) for more information.

Once a web service category exists, an **Add Web Services** zone is provided to find and select web services to link to the web service category.

When viewing a category that already has web services linked to it, they are visible in the zone **Included Web Services**. This zone allows a user to remove a customer owned web service from the list.

JMS Message Browser

The JMS Message Browser portal allows you to select a JMS queue and view messages currently in the queue.

In order for a JMS queue to be available on the portal, a [message sender](#) must be defined that is configured for the appropriate JMS queue with the credentials to connect to the queue.

- If your organization sends real-time outgoing messages to a JMS queue, this configuration would exist as per the details in [Real-Time Message Configuration](#).
- If inbound web service messages are routed to the system via a JMS queue, no configuration is needed in the system. However, if you would like to view the messages in the queue in the JMS message browser portal, configuration for the JMS queues as described for outgoing messages is required.

Navigate to the portal using **Main > Integration > JMS Message Browser**.

The JMS Senders zone provides a list of configured message senders eligible for selection.

The JMS Message List zone is visible for the JMS Sender broadcast from the first zone. This zone supports selecting one or more records to delete from the queue. Use the message selector to limit the results to messages that satisfy the message selector. This uses standard JMS API message selector functionality. Refer to the zone embedded help for information about the supported syntax.

The JMS Message Details zone displays a message broadcast from the list zone.

Oracle Integration Cloud Catalog

Oracle Integration Cloud (OIC) is an offering that serves as integration infrastructure for Oracle cloud solutions. The product provides an adapter for OIC to streamline integration between your edge application and OIC.

The product provides a mechanism (referred to as an adapter) for OIC to retrieve the REST catalog and another to retrieve the SOAP catalog from a given product. The expectation is that a given implementation would use either REST or SOAP and not both, but for those implementations that do support both classes of web services, OIC can retrieve both catalogs.

For the SOAP catalog, the adapter retrieves the name, the source system, the WSDL location and namespace for each web service.

For the REST catalog, the adapter retrieves the name, the source system and the OpenAPI specification for each web service.

It is possible that not every web service supported by an edge product is managed by OIC. In order to only include the appropriate web services in the adapter, configuration is needed to identify which web services to include.

The web service catalog is used to identify the records that should be retrieved by the adapter. Separate catalogs exist for REST and for SOAP

- For SOAP inbound messages, the system supports both the use of [inbound web services](#) and XAI inbound services that are [deployed via IWS](#). Each IWS or XAI inbound service that should be included in the catalog must be flagged in the SOAP catalog. Note that only [deployed](#) services are returned to the catalogue.
- For REST inbound messages, each IWS that should be included in the catalog must be flagged in the REST catalog.
- For outbound message, the system requires the creation of an External System that includes each outbound message type that the external system receives. For outbound messages that are integrated through OIC, the external system itself will represent OIC. Rather than identifying each outbound message type to include in the catalog, only the external system needs to be flagged. The adapter will return web service information for all the outbound message types configured for the external system. If an implementation supports both REST and SOAP, separate external systems should be created to separately group the REST and SOAP outbound messages.

NOTE: The subordinate catalog functionality is no longer applicable and will be removed in a future release.

FASTPATH: Refer to [Maintaining the Web Service Catalog](#) for more information.

Web Service Catalog Configuration

The topics in this section describe the configuration needed in your edge application to integrate with OIC.

Web Service Catalog Master Configuration

The **Service Catalog Configuration** ([master configuration](#)) record defines several system wide settings related to integrating with the service catalog.

It includes configuration for the WSDL base URL for the SOAP catalog. Note that this element supports the functionality described in [Referencing URIs](#). Note that for the REST catalog, the system will use the URL defined in the substitution variable **F1_OPEN_API_BASE_URL**

The subordinate server section is no longer applicable and will be removed in a future release.

For more information about specific fields in the master configuration, refer to the embedded help.

Maintaining the Web Service Catalog

Refer to [Oracle Integration Cloud Catalog](#) for an overview of web service catalog functionality.

To add or remove services that are reported to the OIC catalog, navigate to the portal using **Admin > Integration > Web Service Catalog**.

The Catalog by Class zone provides the list of classes (REST and SOAP). Broadcast the web service class that you want to work with.

The Catalog zone provides a list of services that are currently in the catalog based on the web service class chosen. Users may use this zone to remove services from the catalog.

The Candidate Services zone provides a list of external systems and inbound web services that are not currently linked to the catalog. Users may use this zone to add services to the catalog. The inbound web services will be limited to those with the same web service class as the one broadcast. All external systems are shown regardless of the web service class because there is no web service class configuration on external systems.. The expectation is that implementers will create the external system to include either only REST or only SOAP services and will know which external system to include in which catalog. For the SOAP web service class, if XAI inbound services are applicable, they are also visible.

NOTE: For inbound SOAP web services and XAI inbound services, they may be selected for the SOAP catalog at any time. However, only [deployed](#) services are returned to the catalog by the OIC adapter.

XAI Documentation Note

The XAI functionality is legacy functionality and not recommended for new implementations. The help topics are no longer provided.

Integrations

This chapter provides high level information about product integrations supported for all products that use Oracle Utilities Application Framework.

Creating Application Links in External Applications

When integrating Oracle Utilities applications with other external applications, you can create links from external applications to specific portals and pages within the Oracle Utilities applications (also known as "deep linking"). These links typically leverage Business Process Assistant (BPA) scripts to help navigate the user to the appropriate target portal or page and to make provided parameter values available for use on the portal or page.

NOTE: This technique may also be used within the product to launch a new browser tab from within the application when it's important to maintain the current screen. For example, launching the GIS Viewer in Oracle Utilities Work and Asset Management by creating a new browser tab.

To do this, parameters are added to the application URL by appending a question mark (?) to the end and using the syntax "key=value". If you require more than one parameter, use an ampersand (&) to separate each key=value pair. There are

several predefined parameter key values recognized by the application. In addition, specific parameters understood by the script may be provided. The following list highlights the predefined parameters.

- **location=<navigation key>** - If the exact page to launch is known, the navigation key value of that page can be part of the URL using 'location='. For example, if an approval process has sent an email to a user to approve an adjustment, the link configured in the email may include the adjustment's navigation key.
- **script=<BPA script name>** - In almost every use case, a script is needed to help navigate to the correct page and display the correct information. Even if a location is known and provided in the URL, if there is context data provided as a parameter, it is the responsibility of a script to move that parameter data from the URL into the page data model, so that the page can access the information and display the correct record. In cases where the target page is dynamic based on information provided by parameters, the script may be used to determine what page to launch.
- **portal=true** - When using the location parameter where the target page is a portal page and passing context data, use this parameter. This allows the system to know that the parameter data must be pushed into portal context.
- **initNav=false** - By default, if a script is provided but the location attribute is not provided, the system navigates to the user's home page prior to executing the script. If the script itself includes a step to navigate to a target page as one of its initial steps, the navigation to the home page is unnecessary and may degrade performance. This optional attribute may be included in the URL to bypass the home page.

NOTE: The system still requires a page to be launched for technical reasons. A blank portal with no zones is used for this purpose. Users may see this portal (called **Launching Application**) briefly before the navigation initiated by the script. In addition, this is the portal that the user will remain on if there are any errors in the script or if the script does not navigate anywhere.

- **minDashboard=true** - This option minimizes the dashboard area as part of launching the application. (The user will be able to maximize the dashboard themselves if needed). You would use this option to potentially improve the speed at which the application is launched. Whether this is useful will depend on the use case. If the reason for launching the application is to bring the user to a specific record to view details about that record, the dashboard may be providing valuable information about the record. In this case, it may be correct to display the dashboard by default (and not include this parameter in the URL). On the other hand if the use case is that a user is already in the application and clicks a link that opens a new browser tab to show the user specific detail about a chosen record, while keeping the original page open on the first tab, the dashboard may contain the same information already visible on the original tab. In this case, minimizing the dashboard may be beneficial.

For example, the following URL illustrates launching the script **CM-StopAutoPay** for a given account, assuming the application URL for launching the system is `http://system-server:1234/cis.jsp`:

- **`http://system-server:1234/cis.jsp?script=CM-StopAutoPay&ACCT_ID=1234512345&location=accountMaint`**

It doesn't matter in which order the parameters are provided. The system processes them in the correct order. For example, the following examples are processed by the system in the same way:

- **`http://system-server:1234/cis.jsp?ACCT_ID=1234512345&script=CM-StopAutoPay&location=accountMaint`**
- **`http://system-server:1234/cis.jsp?ACCT_ID=1234512345&location=accountMaint&script=CM-StopAutoPay`**

These parameters are kept in a common area accessible by any script for the duration of the session. To use these parameters on a script you may reference the corresponding **%PARM-<name> global variables**. In this example, after the system is launched any script may have access to the above account ID parameter value by means of the **%PARM-ACCT_ID** global variable. Also note, these parameters are also loaded into temporary storage (to continue the example, there would also be a temporary storage variable called **ACCT_ID** that holds the passed value).

Determining the Application URL

When building the link from within application logic, the service script **F1-EnviURL** may be used to retrieve and build the application URL information.

Navigate to a Given Record's Maintenance Portal

The product provides a script **F1-GotoPrtl** (Navigate to portal for an MO and key values) that may be used for any use case that simply navigates to the maintenance page for a given record and displays that record. This script is only applicable to records that are governed by a business object (and define a navigation option as a BO option). It requires the parameters **mo=** with the maintenance object code of the record and the parameters **pkValue1=** through **pkValue5=** for providing the key values. It looks up the appropriate portal navigation option from the record's BO, populates keys into the 'page data model' and navigates to the portal.

It is also recommended to include the **initNav=false** attribute when building a URL with this script. The example below navigates to the appropriate Migration Data Set portal for the given ID's business object.

- <http://system-server:1234/cis.jsp?script=F1-GotoPrtl&pkValue1=1234512345&mo=F1-MIGRDS&initNav=false>

LDAP Integration

Organizations commonly use a Lightweight Directory Access Protocol (LDAP) security repository as a source of security credentials. The system provides support for importing users and groups from an external LDAP repository into the product to populate Users and User Groups in the system. Once imported, all user and group functions are available. You can resynchronize your LDAP users and groups at any time.

NOTE: Import only. The system currently supports importing LDAP information. Exporting users and groups from the system to LDAP is not provided.

NOTE: Additional configuration. When importing new users and / or groups, additional configuration is needed in the base product. For example, after importing a new user group and its users, the user group configuration should be updated to define the valid application services for the user group. After importing a new user, additional configuration may be needed on the user such as valid To Do Roles, valid Home Page, etc.

FASTPATH: Refer to [Defining Security and User Options](#) for more information about the application security and what it controls.

This section the functionality provided in the framework application that supports LDAP. Refer to the *LDAP Integration* technical reference paper for more information about typical steps related to the full integration.

LDAP Integration Overview

This topic provides a high level overview of the integration process.

At a high level, the base product provides a process to import user group and / or user definitions from and LDAP repository. This is a one way integration.

- When importing a user, if it is not already found in the system, it will be added; otherwise its attributes will be updated according to the imported information.
- When importing a user group, if it is not already found in the system, it will be added; otherwise its attributes will be updated according to the imported information.
- When importing a user, its user group links will be updated as per the information in the import file. In addition, if there are any user groups linked to the user that are not found in the system, they will be added (however, the other users linked to that group in the LDAP repository will not be added as part of this step).
- When importing a user group, its user links will be updated as per the information in the import file. In addition, if there are any users linked to the user group that are not found system, they will be added (however, the other user groups linked to that user in the LDAP repository will not be added as part of this step).

- The import will not cause any deletions of the User or User Group to occur.

A Batch Process Initiates the Import

A batch process is used to initiate the import of information from the LDAP repository. **F1-LDAP** may be submitted ad hoc or may be set up in a scheduler to periodically re-sync the information from the LDAP repository into the application.

The batch process uses parameters to define how to connect to the LDAP repository. In addition, parameters are used to indicate which user or group is being imported.

Adjusting Data to Import

The system provides several mechanisms for adjusting data that is being added to the system:

- There is an **LDAP Import Preprocess** algorithm plug-in spot on the [installation](#) record. Algorithms plugged in here are called by the batch process prior to the add or update of any records. It may be used to make adjustments to the data before doing updates in the application.
- Specifically for creating or updating Users, the **F1-IDMUser** business object is used to add and create the user. The standard BO Preprocessing algorithm plug-in spot may be used to adjust data prior to creation.
- The LDAP mapping file supports some attributes to perform simple modifications to data.
 - The **transform** attribute supports values to truncate values or to convert data to upper case.
 - The **autoGenerate** attribute is specific to the User ID field. Setting this to true will trigger code that will automatically populate the User ID based on the user's name. Refer to [LDAP Mapping](#) for more information.

Performing Additional Processing After Import

The system provides a plug-in spot on the [installation](#) record called **LDAP Import**. Algorithms plugged into this spot are called after users or user groups have been added or updated. It may be used to perform any extra processing that may need to be executed.

In addition, for any additional processing related to the creation or update of a User, the standard [Business Object plug-ins](#) may be used for the **F1-IDMUser** business object which the LDAP batch process uses to create or update users.

Configuring LDAP Integration

To interface the LDAP based security repository with the authorization component of the Oracle Utilities Application Framework product the following must be performed:

- The location and port number of the LDAP based security repository must be defined to in the JNDI Server.
- The LDAP based security repository must be mapped to the Oracle Utilities Application Framework security model. This mapping is expressed as an XML file containing the LDAP query, rules and defaults used in the transformation.
- The mapping file must be configured on the **F1-LDAP** batch job.

Define the JNDI Server

The first step in the configuration process is to define the location of the LDAP based security repository server so that the interface can connect to the physical attributes of the interface. This is done by creating a [JNDI Server](#).

NOTE: The LDAP server is strictly not a JDNI source but is treated as a JNDI source for the integration.

Enter a reasonable JNDI Server name and description.

Populate the **Provider URL** using the format **ldap://<hostname>:<portnumber>** where **<hostname>** is the host of the LDAP server and **<portnumber>** is the port used for the interface.

For the **Initial Context Factory**, the interface uses the standard `com.sun.jndi.ldap.LdapCtxFactory` provided with java for the LDAP interface. If your vendor supplies a custom context factory it may be used. Refer to the documentation provided with your LDAP based security repository for further information.

Define Mapping

The critical component of the interface is a file that describes the mapping between the LDAP based security repository and the system's security model. This file contains the mapping, rules and queries used by the LDAP batch program to provide the interface. The LDAP batch job includes the reference to the mapping file as a parameter. Refer to [LDAP Mapping](#) for more information on defining the mapping file.

Configure LDAP Batch Process

At this point, many parameters for the **F1-LDAP batch control** can be updated with system wide configuration.

- JDNI Server, User and Password may all be configured appropriately. Note that it is recommended that the **Security** setting for the Password be set to **Encrypt**.
- The **LDAP Configuration File** should be populated with the name and location of the LDAP Mapping file.
- If the LDAP service has any limitation to the number of objects that may be imported, configure the **LDAP Query Page Size** parameter to enable querying.

NOTE: Group and User Parameters. The assumption is that the Group or User input parameters are specific to a given import request and as such would not be populated as part of a configuration step.

NOTE: L2 Cache. The LDAP Import batch process requires the L2 Cache to be disabled since it needs to perform some updates in the outside of the worker threads. Any environment using LDAP Import must set `spl.runtime.batch.L2CacheMode=OFF` in the `threadpoolworker.properties` file. It is recommended to run the LDAP import in its own dedicated threadpoolworker.

LDAP Mapping

An LDAP repository consists of multiple entries. Each entry represents an object in the directory that is identified by a Distinguished Name (DN) and may contain one or more attributes. In a typical LDAP repository there is usually an entry for users and an entry for groups. The connection between users and groups may be implemented in two different ways:

- The users belonging to a group are defined in a special multiple-value attribute on the Group entry.
- The groups to which a user belongs are defined in a special multiple-value attribute on the User entry.

The mapping between LDAP security objects and base security objects is stored in an XML document that can be processed by the LDAP import batch job. As part of setting up your system for LDAP import, you need to define this mapping. The base package provides a sample mapping file called `ldapdef.xml` that can be used as a starting point and changed per your business requirements and your particular LDAP repository.

Once you have defined the mapping XML document, this is configured as a parameter in the **F1-LDAP** batch job.

The XML structure:

- The **LDAPEntry** element maps the LDAP entries to system objects (User or Group). The mapping file must contain one and only one LDAPEntry element for User and one for Group.
- The **LDAPCDXAttrMapping** element within the LDAPEntry element maps attributes in the LDAP entry to attributes in the system object.
- The **LDAPEntryLinks** element describes objects linked to the LDAP entry. When mapping the user entity you need to describe how the groups the user belongs to are retrieved. When mapping the group entity you need to describe how the users contained in the group are retrieved.

The following table describes the attributes to define for each element.

Element	Attribute	Description
LDAPEntry	name	The name of the LDAP entry: - Group - User
	baseDN	The base distinguished name in LDAP for this entry.
	cdxEntity	The name of the base product entity to which the LDAP entry is mapped: - Group - User
	searchFilter	An LDAP search filter that is used to locate LDAP entries. A %searchParm % string in that filter is replaced by the value from the user or group parameter from the F1-LDAP batch job submission.
	Scope	Sets the scope of the search. Valid values are: - onelevel (the value normally used) - subtree
LDAPCDXAttrMapping	ldapAttr	The name of the LDAP attribute to be mapped. Note that this may be referenced more than once to allow one LDAP element to map to multiple base product elements. For example, if an email address should be used both for the Login ID and the Email Address.
	cdxName	The name of the base product attribute to be mapped. For User, this is the element within the F1-IDMUser business object. For Group, this is either the 'group' or the 'description'.
	default	The default value that will be assigned to the element referenced in the cdxName attribute when one of the following occurs: - The LDAP attribute contains a null or empty value - The LDAP attribute does not exist or is not specified. Default values are applied only when creating a new entity and are not applied to updated entities.
	autoGenerate	Set this to true in order to turn on auto generation of the user ID. If this is true, the system will define the user id as <first initial of first name>+<last name> all uppercase, to a maximum of 8 digits. If an existing user is found for the generated ID, a number will replace the eight digit (or be appended to the end). The system will increment the number until a unique ID is found.
	transform	Use this attribute to indicate if a transformation of the data should occur. Valid values: uppercase truncate . Note that this attribute should not be used in conjunction with the autoGenerate attribute.
LDAPEntryLink	linkedToLDAPEntity	The name of the linked entity (User or Group). Use User when describing the Group entity. Use Group when describing the User entity.
	linkingLDAPAttr	The multiple-value attribute name on the LDAP entity that contains the linked entity.
	linkingSearchFilter	The search filter to be applied to retrieve the list of linked objects, for example: (&!(objectClass=group)(memberOf=%attr%)) The search filter may contain the string % attr % that acts as a substitution string and is replaced at run time by the value of the attribute named "attr" of the imported entity. If the LDAP entry you are describing is a Group and the string is %name%, it is replaced by the value of the "name" attribute of the group you are importing. If the LDAP entry you are describing is a User and the string is %dn%, it is replaced by the "dn" attribute of the User you are importing.
	linkingSearchScope	Sets the scope of the search. Valid values are: - onelevel (the value normally used) - subtree

Sample Mapping

The following XML describes a sample mapping. The example makes the following assumptions:

- The base product attribute **displayProfileCode** is defaulted to "NORTHAM" when adding a new user.
- The LDAP Group entry contains the list of users belonging to the group in the **departmentNumber** attribute.
- The groups to which a user belongs are retrieved by applying a search filter.

```
<LDAPEntries>
  <LDAPEntry name=" User" baseDN="ou=people,dc=example,dc=com" cdxEntity="
  user" searchFilter=" (&(objectClass=inetOrgPerson)(uid=%searchParm%))">
    <LDAPCDXAttrMappings>
      <LDAPCDXAttrMapping ldapAttr="uid" cdxName=" user" />
      <LDAPCDXAttrMapping ldapAttr="cn" cdxName="externalUserId" />
      <LDAPCDXAttrMapping cdxName="language" default=" ENG" />
      <LDAPCDXAttrMapping ldapAttr="givenName" cdxName="firstName"/>
      <LDAPCDXAttrMapping ldapAttr="sn" cdxName=" lastName"/>
      <LDAPCDXAttrMapping cdxName="displayProfileCode" default="NORTHAM" />
      <LDAPCDXAttrMapping cdxName="toDoEntriesAge1" default="30" />
      <LDAPCDXAttrMapping cdxName="toDoEntriesAge2" default="90" />
      <LDAPCDXAttrMapping cdxName="userEnable" default="ENBL" />
    </LDAPCDXAttrMappings>
    <LDAPEntryLinks>
      <LDAPEntryLink linkedToLDAPEntity="Group" linkingLDAPAttr="departmentNumber" />
    </LDAPEntryLinks>
  </LDAPEntry>
  <LDAPEntry name="Group" baseDN="ou=people,dc=example,dc=com" cdxEntity="
  Group" searchFilter=" (&(objectClass=organizationalUnit)(ou=%searchParm%))">
    <LDAPCDXAttrMappings>
      <LDAPCDXAttrMapping ldapAttr="name" cdxName="Group" />
      <LDAPCDXAttrMapping ldapAttr="description" cdxName=" Description" default="Unknown" />
    </LDAPCDXAttrMappings>
    <LDAPEntryLinks>
      <LDAPEntryLink linkedToLDAPEntity="User" linkingSearchFilter="
      (&(objectClass=inetOrgPerson)(departmentNumber=%distinguishedName%))"
      linkingSearchScope="onelevel" />
    </LDAPEntryLinks>
  </LDAPEntry>
</LDAPEntries>
```

Oracle Identity Manager Integration

The *Oracle Identity Manager* product allows a site to centralize their user definitions and password rules to manage and deploy across the enterprise set of products. When an employee joins an organization, changes their name or departs an organization their security presence across an enterprise must be appropriately managed. Oracle Identity Manager allows for users to be provision and managed in a central location.

An integration is provided to allow the ability to create, maintain and remove users in the identity management product and sync those changes to the users defined in the application. The following sections provide additional details about the integration with respect to configuration steps required in an Oracle Utilities Application Framework based product. For more information about the configuration required in the identity management product, refer to the *Identity Management Suite Integration* technical reference paper.

In order to use this functionality, [feature configuration](#) options for the **External Messages** feature type must be configured.

- Set option type **Support SPML Deployment in IWS** to **true**.
- Set option type **Default SPML service security policy** to an appropriate value per your implementation rules.

Template User Functionality

The user object in this product captures configuration used to control access but also preferences. The identify management product allows for extending the configuration to capture user configuration that is specific to this product. However, it does

not support providing searches or dropdowns to select valid values. For example, to define the user's Home Page requires the reference to a navigation option. To set up your business process such that the home page is configured when defining the user in the identity management product dictates that the security user types in the correct navigation option reference.

On the other hand, to define a minimal amount of user information in the identity management product may result in a two step process for defining users: first define them in the identity management product with the basic authentication details and setting system defaults for some important fields, then after submitting the new user to be added to this product, navigate to the [user](#) page in this product and fill in all the configuration that is specific to this product.

The product provides support for defining a template user that can facilitate the definition of users and reduce some of the challenges listed above. The concept is as follows:

- Define a template user for each broad category of users in the system. For example, Oracle Utilities Mobile Workforce Management may define the following template users: Dispatcher, Mobile Worker, System Administrator and Contractor. Each user would define the typical configuration for users of that type including the home page, the user groups, the To Do roles, the portal preferences, etc.
- When extending the configuration in the identity manager product, simply map the information that is unique to a user and in addition, define a field for the template user. For example, you may choose to only capture the Name (first and last), Email address and User IDs for the user along with its Template User (which is mapped to a user characteristic). Additional fields may be included for capture in the identity management product when defining new users as per an implementation's business needs. For example, if the organization covers multiple time zones, perhaps it is easier to define the user's time zone when defining the user in the identity management product.
- When the new user is uploaded to the system, the interface uses the user BO **F1-IDMUser** to create the user. The BO includes a preprocessing algorithm that looks for the existence of a template user (sent as a characteristic of type **F1-TMUSR**). All the information from the template user will be copied onto the new user record except for the information passed in from the identity manager. The template user is captured on the newly created user via a characteristic for information / audit purposes.
- Once the new user is created, its configuration can now be adjusted, if applicable. Note that the template user is only a tool used when adding a user. Updates to the template user will not "ripple" to all the other users that were created based on this template.

Configuring Template Users

Before configuring template users, all the administrative control tables that are part of User configuration must be defined, including time zones, display profiles, To Do roles, data access roles and user groups.

The next step is to define the user configuration for your system users. During this exercise, you will find that you have broad categories of users. But you will also see that within a given category of user there may be variations in the user privileges and preferences. For example, perhaps there are supervisors within the Mobile Worker role that have more security privileges than a typical Mobile Worker. In addition, there may be variations based on the attributes of the users themselves. For example, maybe your organization exists in multiple time zones and some of your workers are in one time zone and some are in the other.

At this point your security users that are designing their user provisioning procedures must decide the following:

- What information about a new user will be captured in the identity system (besides the expected information like Name, Email and the User IDs)? For example, for the case of multiple time zones, maybe the best solution is to capture the time zone when defining the user.

What information is defined on the template user and how many template users should be created to reduce the need for manual steps or additional data captured in the identity management system? In the case of multiple time zones, proliferating the template users to have one set for one time zone and another set for the other time zone may not make sense since this is one field that is different. However it may be reasonable to create additional templates in the case of variations in the levels of privileges for workers of a different category. So rather than template users for Dispatcher, Mobile Worker, System Administrator and Contractor, your organization may have template users for Dispatcher, Mobile Worker, Mobile Worker (Supervisor), System Administrator, Contractor (Short Term) and Contractor (Long Term).

What information is must be configured one the User record in the application after the user is added? If only a small number of users have a variation from other users, it may be that the easiest way to deal with those variations is to simply update those user records manually. Using the above examples:

- If your organization covers 2 time zones but only a small group of people work in one of the time zones whereas the bulk of the users are in the other time zone, the simplest procedure may be to define the template users for the main time zone and use that for the creation of all users. Then for the small group of users in the separate time zone, navigate to the User page to adjust the time zone after the record is added.
- If only a small number of Mobile Workers are supervisors with separate privileges, rather than defining a special template user for those type of workers, the simpler procedure may be to use the Mobile Worker template and then navigate to the User page to add the additional privileges to the supervisor users after the record is added.

To create a template user, navigate using **Admin > Security > User**.

- Define a User ID that will become the template user reference in the identity management system.
- Be sure to choose a **User Type** of **Template User**.
- Define all the information that should be copied onto a new user that references this user as a template user. Note that **Bookmarks** are not included in the data that is copied from a template user.

NOTE: There is configuration needed in Oracle Identity Management to capture the template user and any other information that the implementation has chosen to define in the identity management product when provisioning a new user. Refer to the *Identity Management Suite Integration* technical reference paper for more information.

User Redirection

The product allows an implementation to support the ability for a customer to authorize a customer service representative (CSR) to view the customer's account information in a customer facing portal (Digital Self Service), to see exactly what the end customer is seeing/experiencing.

When the request for the CSR to view the customer information is received, the following steps occur:

- The security server for the customer facing portal is contacted to obtain a temporary grant code.
- The redirection response returns the grant code and the URL of the target customer facing portal.
- The browser redirects to the user to this URL with the grant code, which is further authenticated and automatically exchanged for an authorization token, allowing the CSR to log in.

Standard security measures with private/public key encryption using JSON Web Tokens (JWT) ensures that only the implementation's enterprise application is allowed to communicate with the implementation's customer facing portal server. The system also provides a plug-in spot to allow for additional information, such as the customer's name and email address, to be included in the call to the security server.

This feature works in conjunction with functionality provided by the enterprise customer application. Refer to the documentation for that product for information about how this feature is supported.

NOTE: The product has been designed to potentially support other types of redirection besides the mentioned use case by adding another entry in the Redirection Target lookup (F1_REDIRECTION_TARGET_FLG). However, the internally provided services work specifically for the Digital Self Service use case. There is no guarantee that they would work for a different redirection use case. Please contact product support if your implementation would like to implement a different redirection scenario.

Redirection Security Context Plug-in

The product supports a plug-in spot to allow for the system to populate additional keys and values to add to the JWT (JSON Web Token) when calling the external security service.

In addition, the product provides an Extendable Lookup BO **Redirection Security Context (F1-RedirectionSecurityContext)** to define the key mnemonic values. For an enterprise product or implementation to populate additional keys, use the extendable lookup to define the key mnemonics. Then provide an algorithm that uses the available information about the customer and populates the security context keys and values by determining the related data in the system.

Master Configuration

The master configuration **Redirection Targets Configuration (F1-RedirectionTargetsConfig)** defines the information needed to contact the security server to obtain a grant code. It also defines the redirection URL.

Build an Anchor Hyperlink

The service script **Return a Hyperlink to the Redirect Servlet for a given Target (F1TargetLink)** is provided to allow for a link to be placed on a UI map or in a zone to initiate the redirection request. Refer to the service script detailed description in the metadata for more information.

Batch Scheduler Integration

The Oracle Database includes an enterprise wide scheduler to simplify the scheduling of background processes. The scheduler is implemented by the *DBMS_SCHEDULER* package. The product provides an integration with the Oracle Scheduler to facilitate scheduling background processes shipped with the product.

At a high level, the integration with the Oracle DBMS Scheduler supports the following entities:

- **DBMS Program.** A program should be defined for each Batch Control that needs to be scheduled by the DBMS scheduler. A program would typically invoke a batch job, but it could be configured to set certain options instead.
- **DBMS Chain.** A Chain defines a series of steps with dependency rules between them. A step references a program, with the program performing the actual work for that step. A rule is attached to each step to identify its dependent steps and the condition for when that step should be executed. For example, in a chain consisting of STEP_A and STEP_B, where STEP_B can only start if STEP_A was successful, the rule for STEP_B to start would specify a condition of "STEP_A SUCCEEDED".
- **DBMS Schedule.** A predefined frequency for jobs that need to be run periodically, for example, nightly jobs.
- **DBMS Job.** Defines a plan to perform a specific program or a chain periodically on a specific schedule or ad-hoc.

The product provides a set of business services to maintain these entities as well as submit jobs, manage submissions and report on past submissions. Refer to business services that start with the prefix "F1-DBMS" for more information.

NOTE: For details on the integration, refer to the *Server Administration Guide* which contains the API. In addition, refer to the technical reference paper *Oracle Scheduler Integration* that provides guidelines for using this integration.

Data Synchronization

Your implementation may need to communicate certain data to external systems. This may be part of a data warehousing requirement or an integration effort. The synchronization process has two main parts. First, the change to the data must be detected and captured. Once that is accomplished, the next step is to manage the communication of that change to the external systems involved. The changes must be captured in chronological order so as to avoid systems going out of sync.

Understanding Data Synchronization

The product supports various options for managing an ongoing synchronization of an entity to an external system. While each integration involves unique business rules, in many cases the process is quite similar and involves the following overall steps:

- When an entity is added, changed or deleted logic determines whether the change is eligible for synchronization and if so a sync request record is initiated to manage the synchronization process. The base product uses the **Audit** plug-in spot on the maintenance object to allow for such logic to be performed when a change is detected to a record for that MO. The framework calls the algorithm defined on this plug-in spot in the event a change to the MO has been detected. Refer to the description of the plug-in spot on [Maintenance Object - Algorithms](#) for more information about when this plug-in is called.
- The processing of the sync request is deferred to batch so that the communication with the external system does not impact the updating transaction. It also ensures that the data being shared with the external system is fully committed to the database.
- When processed, sync request logic manages the following aspects of the process:
 - Determines whether the synchronization is still needed and if not discards the request.
 - Prepares the outbound message with the entity's synchronization details and sends it to the external system.
 - Manages errors and retry attempts as needed.

The following sections describe the various data synchronization options supported by the product.

Accumulative Data Synchronization

The product supports a data synchronization method by which several changes made to an entity may be accumulated and sent together as a single message to the external system.

The following points describe the functionality at a high level:

- When an entity is added, changed or deleted, a snapshot of the entity's data from before the change is captured on one or more sync requests, one for each external system the data needs to be interfaced to. The before-update snapshot is used as a base line for detecting all changes made since then at the time of sending the message to the external system.
- Sync requests are processed by the next monitor batch process.
- The processing of the sync request typically involves business rules that compare the before-update snapshot with the current content of the entity to detect all change made. If changes were made, logic may decide to proceed with the sending the synchronization message otherwise the request is discarded. These rules are also responsible for handling any errors encountered while communicating with the external system and manage retry attempts as needed.

This functionality is supported by logic supplied in the base business object Sync Request (**F1-SyncRequest**). Note that each edge application delivers an appropriate child business object for this BO for each specific synch scenario supported in that product. Some of the functionality below is accomplished using configuration on the parent BO delivered by the framework while other functionality may be delivered by the child BO. In addition, there may be more complex use cases supported by your specific product integration. Refer to your specific application's library of Sync Request business object along with the documentation related to your specific product integration for more information.

The following sections describe key aspects of this data synchronization approach.

Capturing the Change

The base product provides a change data capture (MO Audit) algorithm **F1-GCHG-CDCP** that may be used by maintenance objects that need to be synchronized by this method. This algorithm creates a Sync Request record for the changed record, capturing the MO code and the primary key, if it doesn't find an existing sync request for the same record (and the same business object) in the initial state. The sync request business object used is the one defined in the **Sync Request BO** option on the MO for the record that was changed. If more than one such option exists then multiple sync requests are created.

Your specific product may also introduce additional Audit algorithms to cater for more sophisticated examples.

When creating the sync request record, typically the Sync Request BO will have a pre-processing plug-in that captures a snapshot of the record's data prior to its change. This will be used in subsequent steps to verify that the external system needs to be notified of the change.

Confirming that a Sync is Needed

Once a sync request is captured, there are several steps performed prior to any information being sent to the external system.

NOTE: This section only highlights key steps. Please refer to the business object configuration, its lifecycle and algorithms for a thorough picture of the full functionality..

- When a Sync Request record is created, its initial state (**Pending**) is configured to be processed by a batch monitor. That way, records are added to the sync request table throughout the day but all are processed together. The MO audit algorithm ensures that a new sync request is not created if a Pending record already exists for a given MO / PK combination (for the same business object). However, it is possible that a record for that MO / PK exists in a subsequent “non-final” (such as **Awaiting Acknowledgement**). This state includes a monitor algorithm to check for that condition and to skip transitioning if another record exists. This is done to ensure that the existing record is fully processed before this new record is processed.
- The next state of the lifecycle is **Determine if Sync Needed**. This step uses an algorithm to take a snapshot (called the ‘final snapshot’) of the data and compare it against the initial snapshot taken when the record was created. Based on the logic of the algorithm, it may decide to proceed (transition to **Send Request** or to discontinue (transition to **Discarded**.

Communicating to the External System

Once it is confirmed that the sync should occur, a message must be sent to the external system. The following points highlight the basic functionality.

- An algorithm linked to the **Send Request** state. The expectation is that this algorithm creates an outbound message that routes the information to the external system appropriately. The algorithm must determine the external system and outbound message type to use. Business objects for Sync Request support BO options to define the external system and outbound message type to use for this algorithm.
- Once the outbound message is triggered, the record transitions to the **Awaiting Acknowledgement** status. This state is used to hold the sync request from further state transitions until an acknowledgement is received from the external system. Note that this step relies on implementation of a response mechanism from the external system. It is recommended to implement a response as this helps control the chronological flow of information. The product supplies the business service **F1-UpdateSyncRequest** that transitions the sync request to either the next default state (in this case the **Synchronized** state) if a positive acknowledgement is received; or the state associated with the Rejection transition condition (in this case the **Error** state) if a negative acknowledgement is received. In addition, this state may be configured with a monitor algorithm that detects that a timeout limit has been reached.
- For records that enter the **Error** state, it is recommended to configure an algorithm that creates a To Do entry to alert someone of the problem. Refer to the integration documentation for more information. The state is already preconfigured with an algorithm to complete To Dos when exiting the state.
- The final state **Synchronized** is used to mark the successful synchronizations. However, for more complicated use cases, this state may be used to trigger some additional action. Refer to the documentation for your specific product integration for more information.

Generic Data Synchronization

The product supports a generic data synchronization method by which each change to an eligible entity triggers a synchronization flow that communicates details about the entity to one or more external systems.

The following points describe the functionality at a high level:

- The integration of a specific entity (maintenance object) and an external system is enabled and configured using a **Data Synchronization Control** (F1-DataSyncControl) extendable lookup record.
- Rules supporting the integration reside in a **synchronization script** referenced on the control record.

- When an entity is added, changed or deleted, a sync request may be initiated for each integration according to business rules defined by the corresponding synchronization script.
- Sync requests are processed by the next monitor batch process.
- When the sync request is processed, data is synchronized to the external system according to business rules defined by the corresponding synchronization script.

This functionality is supported by logic supplied in the base business object Generic Data Sync Request (**F1-GenericDataSync**). This business object does not need to be extended to support specific integration rules as these rules reside in the synchronization script associated with each integration's data synchronization control record.

The following sections describe key aspects of this data synchronization approach.

Data Synchronization Control

The **Data Synchronization Control** (F1-DataSyncControl) extendable lookup defines the configuration needed to support an ongoing data synchronization of an entity to an external system. The configuration defines the entity's maintenance object, the external system it is synchronized with and references a synchronization script that manages the specific synchronization rules for this integration. An integration is considered enabled when its corresponding control record is in active status.

The data synchronization script is called in the following modes:

- When the entity is added, changed or deleted, the script is called in **Check** mode to determine whether a sync request should be created for the changed entity and a specific external system.
- When the sync request is processed, the script is called in **Process** mode to prepare and send the outbound message to the external system. Alternatively the script may request to discard the request or indicate that it should be processed later. The latter may be used when there is a need to wait until certain conditions are met before sending the message to the external system.

Note that the configuration for a maintenance object and a specific external system may be overridden by another configuration defined with a higher sequence number.

Confirming that a Sync is Needed

The base product provides a change data capture (MO Audit) algorithm **FIONGDATASYN** that may be used by maintenance objects that need to be synchronized by this method. The algorithm consults the synchronization script associated with each active integration control record configured for the entity as to whether the external system needs to be notified for this change. Once confirmed, the algorithm creates a Sync Request record for the changed record, capturing its MO code and the primary key, along with the corresponding external system.

Note that the decision as to whether to create a sync request or not is controlled by the integration specific synchronization script while the creation of the sync request is the responsibility of the audit algorithm. As such, the same sync request BO is used for all integrations, with no provision for capturing integration specific details.

It is recommended to design the synchronization script to only approve the creation of a synchronization request when it is needed. This prevents unnecessary creation of sync requests that would otherwise be discarded when eventually processed.

Managing the Synchronization Process

Once a sync request is captured, there are several steps performed prior to any information being sent to the external system.

NOTE: This section only highlights key steps. Please refer to the business object configuration, its lifecycle and algorithms for a thorough picture of the full functionality..

- When a Sync Request record is created, its initial state (**Pending**) is configured to be processed by a batch monitor. That way, the changes that triggered the request are fully committed before being communicated to an external system.

- When the sync request record is processed, a monitor algorithm calls the synchronization script associated with the corresponding integration's control record to manage the synchronization process. The synchronization script may indicate either of the following:
 - The request is not yet ready to be processed, i.e. it should remain in its current status and get processed again by the next batch run.
 - The request should be canceled. This indication results in the transition of the record to the **Canceled** status.
 - The request was successfully processed. The synchronization script has prepared the outbound message and routed the information to the external system appropriately. This indication results in the transition of the record to the **Sent** status.
- If an error occurs while processing the request, a To Do Entry is raised to capture the error details and the record is set to the **Error** status. Retry processing of the sync request continues with each batch process until the request is either sent or canceled.

Communicating to the External System

Typically the communication with an external system is finalized when the message is successfully sent and successfully processed by the external system. Depending on the specific integration, the message may not be processed right away by the external system but rather queued and processed later. In this situation, the sync request may need to be further acknowledged as successfully processed (set to the **Acknowledged** status) upon an explicit response mechanism from the external system. The product supplies the web service **F1-UpdateAndTransitionSyncRequest** that may be used to process such acknowledgements.

Maintaining Sync Requests

The system provides a Sync Request portal that is used to view the in progress or completed sync request records.

The menu location of the portal depends on your specific edge product. It may be in a Data Synchronization menu or perhaps in the Batch menu. You are brought to a query portal with options for searching. The options may differ based on your specific product.

Once a sync request has been selected, you are brought to the maintenance portal to view and maintain the selected record.

An **Actions** zone may appear to display specific actions. Alternatively, the actions may be displayed directly in the display area of the **Sync Request** zone.

The **Sync Request** zone provides basic information about the sync request record.

Depending on your specific product additional zones may appear.

Operational Analytics

The framework provides several building blocks and tools that the edge applications may use to implement analytic reports directly from the operational application using Oracle Utilities Analytics Visualization product (referred to in this section as the analytics visualization product). The following sections provide more information about this functionality.

Understanding Operational Analytics

The following sections describe the type of configuration supported in your product to integrate with the analytics visualization product. Refer to the Oracle Utilities Analytics Visualization documentation for more information.

Direct Data Access

The analytics visualization product's canvases report directly off of the operational system (with the exception of batch run analytics) thus eliminating the need of an ETL process. Selected tables and views have been designated as dimensions and facts for the purpose of generating the Start Schemas used by these canvases.

Batch Run Analytics

There is a high volume of batch run data in the operational system that changes frequently and is recorded in a complex set of relationships. The product provides snapshot tables to capture only the batch run and thread data required for analytics. Using these tables for batch subject areas both improves performance and supports extracting the data for upload to other environments.

The snapshot tables are populated in increments. The **Batch Run Analytics Snapshot Update** and the **Batch Thread Analytics Snapshot Update** processes are run on an ongoing basis; each snapshot update selects only the batch runs and threads not yet included in the snapshot. Parameters are supplied to restrict the selected data to a range of months, to support the initial uptake of data. It is recommended that batch run data is updated before the batch thread data, as only threads with corresponding records in the batch run snapshot will be added. Refer to batch controls **F1BRANSN** and **F1BTANSN** for more information.

The **Batch Run Analytics Data Export** and **Batch Thread Analytics Data Export** processes are provided to extract the batch data in increments for upload to other environments. These processes assume that a **Data Export Control** exists for each of the snapshot maintenance objects, to capture the date of the previous extract as a reference point for selecting the next set of records. Refer to batch controls **F1BRANEX** and **F1BTANEX** for more information.

NOTE: As at this time, the analytics views have not been amended to reference the batch snapshot tables. The batch processes **F1BRANSN** and **F1BTANSN** are provided to allow the tables to be populated ahead of the introduction of new batch views in a future release.

Calendar and Time Dimensions

Analytic reports rely on calendar and time dimensions to support various hierarchical grouping by date and time.

The Calendar dimension provides a level-based definition of the standard calendar and fiscal calendar in a flattened representation that is commonly used in data warehouses. This is necessary to enabling customers to group by calendar week, months, quarter and fiscal calendar period, quarter and fiscal year etc. Note that fiscal information about a specific date is optional and sourced from your edge application specific accounting calendar

In the same way, the Time dimension provides a level-based definition of each minute in a day, supporting reports that group by hours, AM/PM etc.

NOTE: Calendar dimension records are generated by a batch process; one record for each date in a specified period of time. You need to run the **Generate Calendar Dimension** batch process on an ongoing basis to cover the standard and accounting calendar days needed to support your business. Refer to **F1-BICDD** batch control for more information.

NOTE: Time dimension records are also generated by a batch process; one record for each minute in a day. You need to run the **Generate Time Dimension** batch process once to generate all the records. Refer to **F1-BITMD** batch control for more information.

Bucket Configuration

The analytics visualization product provides support for defining a set of ranges, each representing a bucket for which extracted measures can be grouped and classified under the relevant bucket. The framework product provides support for viewing and defining the buckets. Refer to [Bucket Configuration](#) for more information.

Analytics Attribute Mapping

The product supports mapping of characteristics to user defined fields associated with dimensions in the analytics visualization product. Each characteristic table that is associated with a dimension table is provided with pre-generated user defined fields identified by unique column sequence numbers in the analytics visualization product. The mapping of characteristics to dimension user defined fields is maintained directly on the dimension portal. You may also review these mappings using the [Analytics Attribute Mapping](#) portal.

Logical Dimension

The Element Name of a foreign key field to a dimension represents a distinct logical version of the dimension. This allows for different logical dimensions to be based on the same dimension table. For example, a "Location" dimension may be referenced as a "Main Location" on one fact and also as an "Alternate Location" on the same or other fact. While both elements refer to the same dimension as foreign keys, each represent a distinct logical dimension via their element names. In the same way, while each date field is implicitly considered as a foreign key to the Calendar dimension, each distinct element name establishes a unique logical dimension. For example, a "Start Date" element name and an "End Date" element name are distinct logical dimensions of the underlying Calendar dimension.

Some logical dimensions may represent an aggregated or summarized form of another logical dimension. They are also known as "shrunk" dimensions. For example, the "Calendar Month Dimension" view is an aggregated dimension of the Calendar dimension. Establishing a link between a summarized dimension and its detailed dimension allows the analytics visualization tool to drill from one fact to another for performance reasons when they are indirectly linked via the same logical dimension but at different aggregation levels. For example, "Fact A" represents daily records and "Fact B" aggregates the same measures at a monthly level. Associating the "month" field in "Fact B", which is a foreign key to the "Calendar Month Dimension" view, with the logical dimension name of the "date" field in "Fact A" allows analytic queries to use "Fact B" for queries at the monthly level or above which perform better than performing them on the more granular "Fact A".

Analytics Configuration

Depending on which product or products you have installed, there may be some configuration needed for the analytics visualization product. Refer to [Defining Analytics Options](#) for more information.

Calendar and Time Dimensions

This portal is used to view generated calendar and time dimension records.

Refer to [Understanding Operational Analytics](#) for an overview of operational analytic functionality.

Navigate using **Admin > Analytics > Calendar and Time Dimensions**.

The following zones may appear as part of the portal's **Main** tab page:

- **Calendar Dimension.** This zone lists most recent calendar dimension records. You may filter the list to review records generated up to a specific date.
- **Calendar Date.** This zone provides information about a selected calendar date.
- **Time Dimension.** This zone lists all time dimension records.

Maintaining Bucket Configurations

Several key performance indicators in the analytics product look at measurement values (for example: the age of an asset or the age of debt) classified into a number of pre-defined groups also known as buckets. The overall metric can then be reported by the different buckets and allow various analyses.

For example, the age of an asset can be classified into the following buckets:

- Less than 6 Months
- 6-12 Months
- One Year and Older

The age of debt, also known as arrears can be classified onto the following buckets:

- 0-30 Days
- 30-60 Days
- 60-90 Days
- 90+ Days

The definition of the buckets is extracted to the Business Intelligence data warehouse, to be used as dimensions.

Bucket Definition Considerations

Each type of bucket is defined using a bucket configuration Business Object. The bucket definition considerations and/or rules will vary based on the bucket configuration business object used. The business objects available are driven by your specific product. For a list of available bucket configurations business objects, navigate to the business object page and view the business objects for the Bucket Configuration maintenance object.

Setting Up Bucket Configurations

To maintain the bucket ranges for the bucket configuration(s) applicable to your product, open **Admin > Analytics Configuration > Bucket Configuration**.

You are taken to the query portal where you can search for an existing bucket configuration. Once a record is selected, you are brought to the maintenance portal to view and maintain the selected record.

NOTE: Your specific product may also include an Analytics Configuration portal that displays the list of existing and potential bucket configuration records, allowing you to drill into this page to view the record in detail.

The **Bucket Configuration** zone provides basic information about the bucket configuration.

For more information about the elements supported refer to the zone's help or to the relevant analytics integration documentation for your product.

Defining Analytics Options

Refer to [Understanding Operational Analytics](#) for an overview of the operational analytics functionality.

Your specific product may require some system wide configuration to be defined when using operational analytics.

Navigate to the [Extendable Lookup](#) portal. Search for and select the **Analytics Options** business object.

Use the embedded help to review information about the options to define.

Defining Analytics Tables

This portal is used to search for Analytics Table definitions. An Analytics Table record exists for each table or view in the operational system that represent dimension and fact tables in the Operational Analytics product.

Refer to [Understanding Operational Analytics](#) for more information.

You can access the portal from the **Admin Menu > Analytics Configuration > Analytics Table**. You are brought to a query portal with options for searching for a specific record. Once a record has been selected you are brought to its maintenance portal to view and maintain the selected record.

Defining Analytics Dimensions

This portal is used to maintain metadata for Analytics Dimension tables. A dimension record exists for each table in the operational system that represents a dimension table in the Operational Analytics product.

Refer to [Understanding Operational Analytics](#) for more information.

You can access the portal from the **Admin Menu > Analytics Configuration > Analytics Table**. You are brought to a query portal with options for searching for a specific record. Once a dimension record has been selected you are brought to this portal to view and maintain the selected record.

The following zones may appear as part of the portal's **Main** tab page

- **Analytics Table.** This zone provides information about the selected dimension record.
- **Fields.** This zone lists all the fields that define the dimension table. Fields may be selected from the dimension's underlying operation table using the **Excluded Fields** zone or added as computed fields.
- **Dimensions.** This zone lists dimension tables that this dimension references via foreign key constraints.
- **Referenced By.** This zone lists dimension and fact tables that reference this dimension via foreign key constraints.
- **Characteristic Mapping.** This zone manages characteristic mapping extensions for the dimension. Refer to [analytics attribute mapping](#) for more information.
- **Excluded Fields.** This zone lists fields from the dimension's operational table that are not included in the dimension table.

NOTE: The ability to introduce custom analytics dimensions is currently not supported.

Defining Analytics Facts

This portal is used to maintain metadata for Analytics Fact tables. A fact record exists for each table or view in the operational system that represents a dimension table in the Operational Analytics product.

Refer to [Understanding Operational Analytics](#) for more information.

You can access the portal from the **Admin Menu > Analytics Configuration > Analytics Table**. You are brought to a query portal with options for searching for a specific record. Once a fact record has been selected you are brought to this portal to view and maintain the selected record.

The following zones may appear as part of the portal's **Main** tab page

- **Analytics Table.** This zone provides information about the selected fact record.
- **Fields.** This zone lists all the fields that define the fact table. Fields may be selected from the fact's underlying operation table or view using the **Excluded Fields** zone or added as computed fields.
- **Dimensions.** This zone lists dimension tables that this fact references via foreign key constraints.
- **Excluded Fields.** This zone lists fields from the fact's operational table or view that are not included in the fact table.

NOTE: The ability to introduce custom analytics facts is currently not supported.

Defining Analytics Attribute Mapping

This portal maps extensions to user defined fields provided for tables associated with an analytics dimension table that capture well defined extension data. A common example of this type of data are characteristics.

These mappings may be directly maintained on the operational [Analytics Dimension](#) portal. Refer to [Understanding Operational Analytics](#) for more information.

If your system is integrated with the Oracle Utilities Analytics product refer to [Understanding Analytics Integration](#) for more information about ETL based characteristic mapping.

You can access the portal from the **Admin Menu > Analytics Configuration > Analytics Attribute Mapping**. You are brought to a query portal with options for searching for a specific mapping record. Once a record has been selected you are brought to the this portal to review the information for the selected record.

The **Analytics Attribute Mapping** zone on the portal's **Main** tab page provides information about the mapping record.

NOTE: For characteristic mapping, only **Adhoc** and **Pre-defined** characteristic types are supported.

NOTE: For the product provides support for identifier mapping for operational analytics in this release but only the metadata definition is supported. The support for these types of attributes in the operational analytics product is in a future release.

Analytics Integration

The framework provides several building blocks and tools that the edge applications may use to implement integration with the Oracle Utilities Analytics product (referred to in this section as the analytics product). The following sections provide more information about this functionality.

Understanding Analytics Integration

The following sections describe the type of configuration supported in your product to integrate with the analytics product. Refer to the Oracle Utilities Analytics documentation for more information.

Master Configuration

Edge applications that include an integration to the analytics product typically include a master configuration record that captures information needed for the extract, load and transformation step, such as extract parameters. These records are provided by the specific edge products and may be viewed and maintained on the [master configuration](#) portal.

Note that your specific edge application may deliver an **Analytics Configuration** portal that displays the information from the master configuration record along with other analytics related configuration.

Bucket Configuration

The analytics product provides support for defining a set of ranges, each representing a bucket for which extracted measures can be grouped and classified under the relevant bucket. The framework product provides support for viewing and defining the buckets. Refer to [Bucket Configuration](#) for more information.

ETL Based Characteristic Mapping

The product provides objects to allow mapping configuration of characteristics in the product to user defined fields on dimensions in the analytics product. The mapping is used by the extract process to populate target user defined columns with corresponding characteristic data.

This type of mapping relies on configuration in the Allowed Target Dimensions [extendable lookup](#). The extendable lookup is used to define each Target Table in the analytics product that has one or more user defined fields that may be populated with characteristic values. It also defines the valid characteristic entities that may act as the source for the characteristic data.

NOTE: The framework does not provide any values in this lookup, but edge products that support mapping provide values in this lookup. Please refer to your specific product's integration chapter and refer to the Oracle Utilities Analytics documentation for more information.

Refer to [Defining Analytics Attribute Mapping](#) for more information.

Change Data Capture Using Sync Request

Depending on the specific edge application and version you are using, there may be components of the integration that use Sync Request for the change data capture step. If that functionality applies to your implementation, the following points highlight how to get more information:

- Refer to the administration guide for Oracle Utilities Analytics to confirm if your product integration is using Sync Request for any change data capture functionality.
- Review the Sync Request Business Objects provided by your product for analytics integration.
- Refer to [Data Synchronization](#) for a high level understanding of the process.

Business Flags

It is possible that information detected in one product may be useful or even critical to share with another product. The framework provides functionality for receiving information from an external system that acts as a type of flag or alert that may need investigation. This allows any system to store detected business flags in a common way and share that information with one or more other systems.

Understanding Business Flags

The following is an example of a use case for business flags. Imagine that DataRaker highlights potential theft of service at a certain location. That product may initiate a business flag alert to various products owned by the implementation with a recognized "standard name" for the business flag, such as "TAMPER".

- If Oracle Utilities Meter Data Management receives this business flag, it may initiate a service investigation monitor.
- If Oracle Utilities Mobile Workforce Management receives this business flag, it may initiate a service investigation activity.
- If Oracle Utilities Customer Care and Billing receives this business flag, it may initiate a hold on billing for that location.

Note that the framework product supplies basic functionality to support logic that is common to all edge applications that implement business flag functionality. However it is the individual edge applications that supply more specific functionality (business objects and algorithms) for specific use cases, if applicable.

The following sections highlight functionality supported for business flags in the framework. Refer to the edge application product documentation for more details for supported use cases.

Standard Name

To ensure that Business Flags are universally understood across all edge applications and to simplify integration each Business Flag will have a Standard Name. This is a name that is used by all the products when sending information to each other. That way, if DataRaker product sends Oracle Utilities Meter Data Management a "TAMPER" business flag, it should result in the same functionality as when Utilities Customer Care and Billing sends a "TAMPER" business flag.

Standard Names are defined using an extendable lookup. In addition to common extendable lookup fields, the standard name also references a category and a class. The lookup also supports defining one or more external names, for cases where information is communicated from an external system that does not send the expected Standard Name.

The framework delivers the class values but does not deliver any standard names or category values. Refer to your specific edge application products to verify if any standard names or categories are delivered. Your implementation may configure appropriate standard names and categories based on your business rules.

Business Flag Type Defines Behavior for a Standard Name

Although the definition of the business flag standard names should be universally understood by the various integrated products that support them, each individual product defines what should occur when a business flag with a given standard name is created. This is configured using a business flag type. Only one active business flag type may exist for a given standard name. Business flags that are received from an external system will define the standard name, but will not have knowledge of the specific business flag types defined. The business flag type is determined based on the standard name.

The business flag type defines the business object to use when creating the resulting business flag record. The business object defines the lifecycle of a resulting business flag record.

Business Flag Type Algorithms

The business flag type includes support for algorithms. This allows for an implementation to define a common business object that may be used for different business flag types (if a common lifecycle is followed) but allow for different functionality to kick in depending on the business flag type.

The product supplies a plug-in spot for **Additional Processing** that may be invoked by a business flag that enters the Additional Processing state. Refer to your product's library of business objects to determine if there is an Additional Processing state that supports calling algorithms on the business flag type.

Objects Linked to a Business Flag

There are two types of links between an object in the system and a given business flag.

Affected Entity

Each business flag is associated with a single record in the system that is considered the “affected entity” or the entity that the business flag is associated with. The affected entity is defined by the specific business objects designed for the use cases supported by your edge product. For example, many utility base products may configure service point as the affected entity for its business flag use cases. Each business flag created is linked to a specific service point. Linking a specific entity to each business flag allows for algorithms to trigger functionality for that entity such as an investigation order. In addition, algorithms may be implemented in other business process areas that look for the existence of a business flag and act accordingly.

Related Objects

The business flag supports linking one or more related objects to a business flag to make it easier to trigger functionality or for impacted business processes to look for business flags. For example, when creating a business flag for a given service point, it may be useful to link all the accounts that are currently linked to the service point. Then, if an account oriented process should check for a business flag, it can look directly for a business flag linked to the account in its related object.

Impacted Business Process

The product supplies support for associating one or more impacted business processes to a business flag type. This configuration is used when functionality for that business process is impacted in some way based on the existence of a business flag of a given type. For example, maybe some process is put on hold when a certain type of business flag exists.

Note that configuring a business process on business flag type is not enough to trigger any impact on that business process when a business flag exists. There must also be some logic implemented in the business process functionality itself that knows to look for a business flag for a given record that is configured to impact the business process.

The definition of the business process is at the discretion of the edge application that supplies functionality to support this. For example, the business process could be defined as something broad such as “billing” or could be something more granular such as “billing estimation”. The system supplies an extendable lookup to use for configuring the supported business processes. Refer to the values of the business process extendable lookup in your edge application or to the edge application specific Business Flag documentation for more information about supported business processes.

Dates

A business flag supports two dates: a Business Flag Date/Time and a Business Flag **End** Date/Time

- The business flag date / time is required for all business flags. For some types of business flags only one date is needed.
- For business flags that have a start and end period, the business flag date/time acts as the start date and the other field is the end date.

For a business flag that has a date range, it may be important for functionality implemented for [impacted business processes](#). How the process treats the date will depend on its functionality.

- For some processes, the business flag is essentially expired after the end date has passed. This applies to impacted processes that are only looking at the current status of data in the system. For example, collection processing could be held if there is a business flag currently in effect (where the current date is within the date range). It would never look at historical business flags.
- For some processes where historical data may be relevant, a business flag effective during that same historical period may impact the process. For example if a business flag denotes an outage event for a given time period, perhaps estimated consumption should never be calculated for that time period.

Note that because business flags have a status, the design for the lifecycle of the business objects for the above effective dated use cases must carefully consider the states. For business flags that are considered expired after the end date passes, the BO lifecycle may be designed to transition to a final state after that date such that the record is no longer included in active processing. For business flags that continue to impact processing for a historic period, the BO lifecycle may be designed to remain in a non-final state such that it is clear that the record is still applicable.

Creating Business Flags

Business flags may be created in a system for one of the following reasons:

- A message is received from an external system that initiates the creation of a business flag. In this case, logic in the external system has detected some situation that this product is being alerted about.
- Business logic in this product detects a situation that should be investigated or should act as a flag. In this scenario, there may not be any integration needed depending on the business rules.
- Business logic in this product detects a situation that another integrated product should be alerted about. In this scenario, the business flag record is used to send out information to the integrated product.
- A user manually creates a business flag based on knowledge of the affected entity. For example, a customer service representative may create a business flag as a result of contact with the customer.

Creating a Business Flag from a Web Service

The system supplies both a REST and SOAP inbound web service that may be used for an external system to initiate (or update) a business flag. The REST service is **F1-BusinessInsights**. The SOAP service is **F1-BusinessFlagSync**. In both cases, the web service invokes a "driver" service script whose ultimate responsibility is to determine the appropriate Business Flag Type based on the standard name or external standard name, and therefore the appropriate business object for

the new business flag. Because different products may have different logic related to creating a business flag, the service script calls another service script linked to the maintenance object using the Business Flag Sync MO option.

The "driver" service script includes a "contextData" group, which in turn references the data area **F1-BusinessFlagContext**. This data area is to allow for an external system to provide additional information for a given business flag use case. For any integration that requires additional information to be passed in from the external system, a separate data area should be used to define the additional elements; and that data area should refer to **F1-BusinessFlagContext** as its extended data area.

The framework does not supply a Business Flag Sync service script, however individual edge applications supply a service script based on the use cases it supports out of the box.

NOTE: For products that are continuing to use XAI for external messages, the product also includes an XAI inbound service for the same Business Flag Sync Driver service script. Note that the product recommendation is to discontinue use of XAI and use [inbound web services](#) instead.

Error Handling

If there is a problem in trying to create a business flag based on incoming information, the Business Flag Sync Driver service script creates a special business flag record using the Business Flag Error Business Object. This is also configured on the maintenance object as an option. The framework product supplies the business object Business Flag Error (**F1-BusinessFlagError**) for this functionality. Refer to the business object description and configuration for more information.

Confidence

There may be use cases where a condition is suspected, but not confirmed. The originating system should be able to assign a "confidence" level to the business flag.

For example, Oracle Utilities Analytics Insights or other machine learning platforms will aggregate and analyze large amounts of data to identify potential insights that need investigation. These platforms can initiate a business flag with a **Suspected** confidence.

An application receiving this business flag may adjust the confidence to either **Confirmed** or **Rejected**.

- Setting the confidence to **Confirmed** is the equivalent of a true positive.
- Setting the confidence to **Rejected** is the equivalent of a false positive.

Note that the application that receives a business flag is responsible for acting on the value based on business rules. Any updates to the confidence can be communicated to the other products that received the same business flag, if desired.

Additionally, creating a business flag in the application with a confidence of **Missed** provides a way to denote a missed insight. This is the equivalent of a false negative.

Because a utility implementation may have multiple applications installed that support business flags, the following guidelines are suggested for designing where the confidence flag should be updated.

- If Oracle Utilities Service Order Management is implemented, it has the responsibility of updating the confidence flag and communicating the update to other products.
- Otherwise, the assumption is that Oracle Utilities Customer Care and Billing owns field work orchestration and that it will have the responsibility for updating the confidence flag and communicating the update to other products.

No product logic is provided to enforce the above suggestions, however, the business objects supplied by the different edge applications will support the recommended implementation.

Business Flag Updates from External System

When the product that is responsible for updating the Confidence flag makes a change, it should initiate an outbound message to alert other products. On the receiving side, the same inbound web service and Business Flag Sync service script is responsible for the update. Refer to [Creating Business Flags](#) for more information.

Setting Up Business Flag Configuration

The following topics highlight the general configuration steps required to use business flag functionality. Your specific product may supply additional functionality to support specific use cases for business flags. Refer to your specific product's documentation and the library of business objects supplied for Business Flag in your product for more information.

Standard Name Category Characteristic Type

Define one or more categories for grouping your standard names into logical business groupings.

Navigate to the [Characteristic Type](#) page. Search for and select the Business Flag Category characteristic type (**F1–BUSFC**).

Define desired category values and descriptions to be used for the standard names.

Standard Name Lookup

Navigate to the [Extendable Lookup](#) portal. Search for and select the **External Insights Standard Name** business object.

Define values that are recognized in the external systems that your implementation is receiving business flag details from.

Define a **Category** for the standard name that is appropriate for your product. Note that the category does not have to be in sync with standard name definitions in external products.

Select a **Class** for the standard name that is appropriate for its usage.

Refer to the embedded help for more information about configuring this object.

Business Process Lookup

If your specific product supports configuring business processes that may be impacted by the existence of a business flag, they are defined as an extendable lookup.

Navigate to the [Extendable Lookup](#) portal. Search for and select the **Business Process** business object.

Integration Configuration

The following points highlight configuration required to support receiving business flag information from an external source:

- Define a record for each [External System](#) that the product may be receiving business flag records from. This should be a value known by the external system and provided when new business flags are sent to this product.

When this product should initiate business flag information to be sent to an external system, configure one or more [Outbound Message Type](#) records. For each one, update the External System to configure how each outbound message type is communicated to the external system.

Defining Business Flag Types

Refer to [About Business Flags](#) for an overview of business flag functionality.

To maintain the business flag types applicable to your product, open **Admin > Integration > Business Flag Type**.

This is a standard [All-in-One portal](#).

The information captured on the business flag type depends on the business objects supported by your product. Refer to the embedded help text for more information.

Maintaining Business Flags

This section describes the functionality supported for viewing and maintaining business flags.

Refer to [About Business Flags](#) for an overview of business flag functionality.

Navigate using **Main > Integration > Business Flags**. You are brought to a query portal with options for searching for business flags.

Once a business flag record has been selected, you are brought to the maintenance portal to view and maintain the selected record.

The **Business Flag** zone provides basic information about a business flag. Refer to the embedded help for more information.

Market Transaction Management

This section describes various entities and aspects involved in the configuration and maintenance of market transactions. The framework product supplies basic functionality to support the objects related to market transaction management. However more specific functionality (business objects and algorithms) for specific use cases are supplied by the edge applications.

Understanding Market Transaction Management

Several objects are provided to support market transaction management.

- **Market Message Type.** This object is used to define the different types of market messages, both inbound and outbound and to define the appropriate market message Business Object to use when creating objects of this type.
- **Inbound Market Message.** This object captures the instance of a market message received from an external source.
- **Outbound Market Message.** This object captures the instance of a market message that will initiate a message to an external source.
- **Market Process Type.** This object is used to define configuration related to processes that may be initiated to support steps that should be execute to support an inbound or an outbound market message. It defines the market process Business Object to use when creating market processes of this type. It may also define one or more market process event business objects to initiate events that are generated to support steps within the market process.
- **Market Process.** This object captures the instance of a market process that may be created to carry out business logic related to a specific inbound or an outbound market message.
- **Market Process Event.** This object is used to orchestrate individual events that may occur to support steps in a given market process.
- **Market Configuration.** This object may be used to capture configuration needed to support market transactions. Each type of configuration should use a Business Object to define what information needs to be captured. Each type of configuration may define up to five key fields that may be used to uniquely identify an individual configuration instance.

Configuring Market Transaction Management

The following sections describe market transaction management configuration options.

Defining Market Configurations

Each market configuration is used to define one or more options for a given type of configuration (based on a delivered business object).

The product defines a generic set of portals, described here, that may be used to define any type of market configuration. However, it may be that your implementation includes more specific configuration portals for certain types of market configurations.

Open this page using **Admin > Market Transaction Management > Market Configuration**.

You are brought to the **Market Configuration Query** where you need to search for the market configuration (i.e., its business object).

Once you have found the appropriate market configuration, select the value and you are brought to a standard [All-in-One](#) portal that lists the existing values for the market configuration. The standard actions for an All-in-One portal are available here.

Defining Market Message Types

Refer to [Understanding Market Transaction Management](#) for an overview of market messaging functionality.

Open this page using **Admin > Market Transaction Management > Market Message Type**.

This is a standard [All-in-One](#) portal.

The information captured on the market message type depends on the business objects supported by your product. Refer to the embedded help text for more information.

Defining Market Process Types

This page is used to define market process types which control behavior of the resulting market processes and the valid market process events that could be triggered as a market process progresses through its lifecycle.

Refer to [Understanding Market Transaction Management](#) for an overview of market messaging functionality.

Open this page using **Admin > Market Transaction Management > Market Process Type**.

This is a standard [All-in-One](#) portal.

The information captured on the market process type depends on the business objects supported by your product. Refer to the embedded help text for more information.

Maintaining Market Transactions

The following sections describe various pages available to view and work on market transactions.

Maintaining Market Processes

Refer to [Understanding Market Transaction Management](#) for an overview of market messaging functionality.

Open this page using **Main > Market Transaction Management > Market Process**. You are brought to a query portal with options for searching for market processes.

Once a market process record has been selected, you are brought to the maintenance portal to view and maintain the selected record.

The **Market Process** zone provides basic information about a market process. Refer to the embedded help for more information.

Related Objects

The related object tab includes several zones that display various objects that may be related to the market process.

Related Market Messages and Processes

This zone displays any entries in the related object collection that are outbound market messages, inbound market messages or market processes.

Related Processes

This zone displays market processes that are linked to this market process using the explicit related process table. The market processes linked here are marked either as a parent, a child or a sibling market process.

Other Related Objects

This zone displays market process events linked to this market process. In addition, the zone displays any miscellaneous objects that are linked to the market process in the related objects collection, besides outbound market messages, inbound market messages and market processes.

Maintaining Market Process Events

Refer to [Understanding Market Transaction Management](#) for an overview of market messaging functionality.

You can view this page when drilling into a market process event from the [Market Process](#) related objects tab.

Once a market process record has been selected, you are brought to the maintenance portal to view and maintain the selected record.

The **Market Process Event** zone provides basic information about a market process. Refer to the embedded help for more information.

Related Objects

The related object tab includes a zone that displays all entries in the market process event's related object collection.

Maintaining Market Messages

Refer to [Understanding Market Transaction Management](#) for an overview of market messaging functionality.

Open this page using **Main > Market Transaction Management > Market Message**. You are brought to a query portal with options for searching for market messages. Both inbound market messages and outbound market messages may be queried here.

Once a market message record has been selected, you are brought to the appropriate maintenance portal (inbound market message or outbound market message) to view and maintain the selected record. The inbound market message portal and the outbound market message portal have similar portal tabs and zones.

The **Market Message** zone provides basic information about the market message. Refer to the embedded help for more information.

Related Objects

The related object tab includes several zones that display various objects that may be related to the market process.

Related Market Messages and Processes

This zone displays any entries in the related object collection that are outbound market messages, inbound market messages or market processes.

Other Related Objects

This zone displays any miscellaneous objects that are linked to the inbound / outbound market message in the related objects collection, besides outbound market messages, inbound market messages and market processes.

Content Migration Assistant (CMA)

This chapter describes the Content Migration Assistant (CMA), a facility to enable the export of data from one environment to another.

CAUTION: This chapter is intended for users responsible for creating environments for testing.

Understanding CMA

The Content Migration Assistant (CMA) provides implementers with a flexible, extensible facility for migrating data from one environment to another (e.g., from a development environment to a production environment). Data is exported from the source system to a file. The file can then be checked in to a version control system for reuse, or can be immediately imported into the target system and applied.

NOTE: As used in this chapter, *source* systems are those on which export-related activities are conducted and *target* systems are those on which migration updates are to occur.

The following points highlight some common use cases for using this tool:

- Seeding a newly created environment with configuration data. For example, if you are creating test environments, you can import configuration data from a development environment. In this case, you will probably set up a "copy all configuration" type of migration. Another use case is if you want to troubleshoot an issue in production, you may want to copy all production configuration to a test environment.
- Updating an existing test environment with new configuration or updates to configuration from a development environment. In this case your set of objects will be more targeted and you are doing more of an incremental migration.
- Promoting tested configuration to your production environment.
- Migrating selected master and transaction entities from one environment to another for testing purposes.

Here are key aspects of the import process that apply to all cases:

- When records exist in both the target and the source, the CMA tool will fully **replace** the object with the version from the source. Special consideration should therefore be given to records whose **primary key is system generated** to ensure the correct entity is being replaced.
- While typically the source version of an object is applied directly onto the target environment, CMA does provide a way to [Adjust Imported Data](#).
- The import process **does not handle deletion** of records in the target environment. When importing records from a source environment to a target environment, the import process for the migrated records is able to identify objects to add and objects to change. There is no mechanism for indicating that records in the target environment should be deleted. The absence of those records in the import is not enough because the migration may be only importing a subset to add or update. If data on the target system must be deleted, users must delete the records in the target accordingly. Note that CMA does orchestrate the deletion of child rows of an object as a result of a comparison. This is only applicable to child records that are owned by the implementation.

Configuration steps are mainly used to define the data to migrate at the source system but also involve tasks to be performed at the target environment. Note that the products provide base delivered configuration that may be used as is or used as a template for building more specific configuration for a given implementation. At a high level, configuration tasks involve the following entities:

- System wide settings are defined in the **Migration Assistant Configuration** master configuration record.
- Each type of record that may be copied requires a **Migration Plan**. The migration plan is used to identify the maintenance object (MO) for the record (using a business object) and allows for instructions to specify related records that may be included in the migration.
- A **Migration Request** is used to define the data to include in a given migration export.

Refer to [CMA Configuration](#) for more information.

Once you have a migration request defined to include desired data to export, the next steps are to export from the current environment and import to the target.

- The **Export** process includes all the steps needed to select records to be exported from the source environment and create the export file. For more information, refer to [Exporting a Migration](#).
- The file created by the export, which is a BINARY file, needs to be transferred from the export directory to the import directory. The transfer needs to be done in such a way as to preserve the file structure. Refer to [Additional Migration Considerations](#) for more information.
- The **Import** processes include all the steps needed to read an imported file, compare the data in the file to the data in the target, review the proposed changes and apply the updates. For more information, refer to [Importing and Applying a Migration](#).

The topics in this section provide a general understanding of the Content Migration Assistant (CMA) tool.

Types of Migrations

The Content Migration Assistant is used for two general types of migrations: wholesale and targeted. The following topics provide some additional information about these concepts.

Wholesale Migrations

Wholesale migrations are used when migrating all the configuration and/or administrative data from one environment to another. For example, a wholesale migration might be used when migrating administrative data from a development or test environment to a production environment.

A wholesale migration may be comprised of one or more migration requests that in total include all the administrative data to move. Migration plans used in wholesale migrations may be designed to omit subordinate instructions related to explicit foreign keys that are identified through constraints as they are not needed, assuming that the data they are referring to will also be included in the migration.

With the ability to group migration requests, the expectation is that implementations follow these guidelines:

- Multiple migration requests using the Criteria-based or Entity List migration request classes are used to group information logically together to allow for more reuse.
- A Group migration request is used for the export. This allows for one data set to export and one data set on the import side, simplifying the process. Note that depending on the amount of data, this may be a large import set to process. An implementation may find it easier to create multiple migration requests that break down the process into several steps.

You should consider that the framework product provides base migration requests and your specific edge product may provide base migration requests as well that may or may not include framework migration plans. Using the product provided migration requests is beneficial with respect to maintenance. As features are added to the product (including new administrative maintenance objects), any impact on CMA should be included in the product owned migration requests. If your implementation introduces new custom administrative maintenance objects that should be included in CMA, then custom migration plans and a custom migration request should be added. Your implementation can build a Group migration request that includes the base migration request and your custom migration requests to have a consolidated export.

NOTE: Refer to [Framework Provided Migration Objects](#) for information about migration requests provided in the framework product. Refer to your specific product's documentation for information about additional base provided migration requests.

Targeted Migrations

A targeted migration refers to migrating a specific subset of data from one environment to another. Migration plans used in targeted migrations are designed to be self-sufficient and include all necessary subordinate instructions needed to ensure that the exported entity can be imported without encountering referential integrity errors. With this type of migrations, any relationship explicitly excluded from the migration plan assumes the related entity already exists in the target environment. Examples of targeted migrations include:

- Migration of a new portal, its zones, and its application service.
- Migration of all outbound message types.
- Migration of selected accounts and their related master and transactional entities to a lower environment for testing purposes.

Migrating Configuration Data

A main use of CMA is to migrate configuration data, where the source environment is considered a kind of system of record and the target environment is getting updates based on changes to the source environment. Alternatively you may be seeding a new environment. The expectation is that the target record is updated to look like the source record.

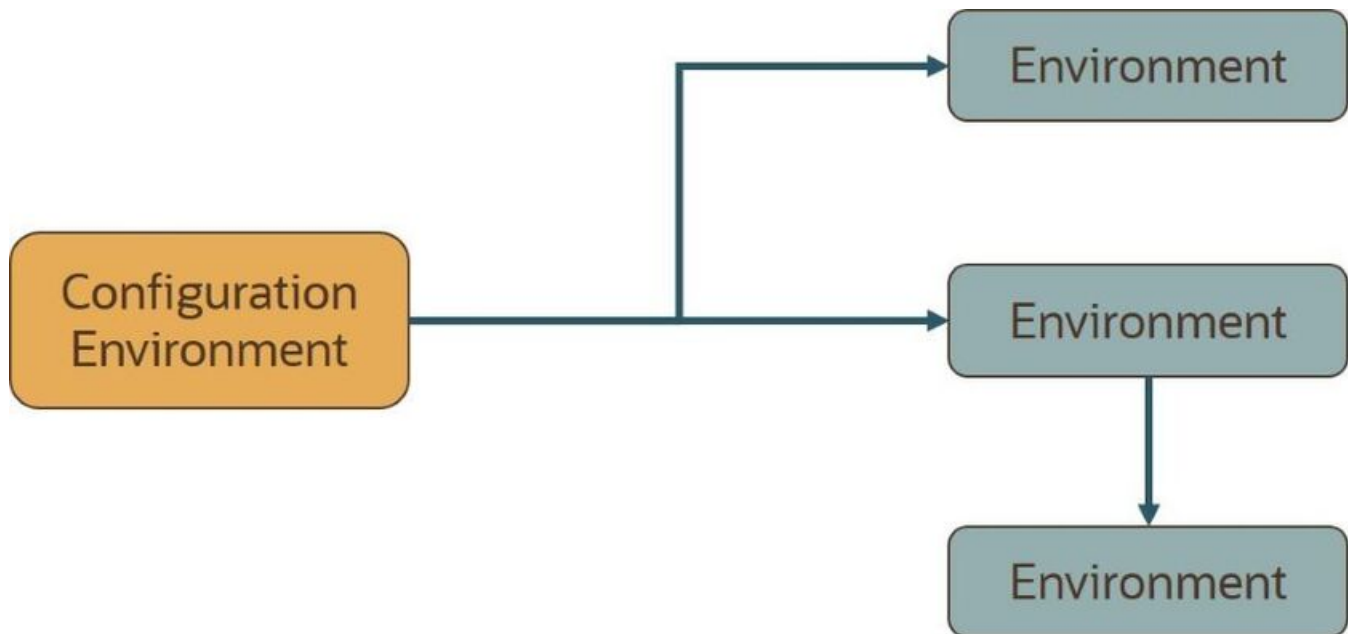

Configuration data may include a mixture of records that have an owner flag and ones that do not. The comparison step of the import process will generate appropriate insert or update SQL statements for the following data found in the export:

- Configuration data in a maintenance object with no owner flag. This is purely implementation data.
- Configuration data in a maintenance object with owner flag, where the owner is **Customer Modification**. For example, implementer-specific business objects.
- Configuration data in a maintenance object with owner flag, where the main record is owned by the product but where a child record exists with an owner of **Customer Modification**. For example, implementer-specific algorithms added to a base owned business object.

- Customizable fields in a record that is owned by the product. For example, the priority of a based owned To Do type.

Migrating Business Data

CMA may be used to perform a targeted migration of selected master entities and their related transactional data from one environment to another. For example, migrating a subset of accounts and their related data for testing purposes.

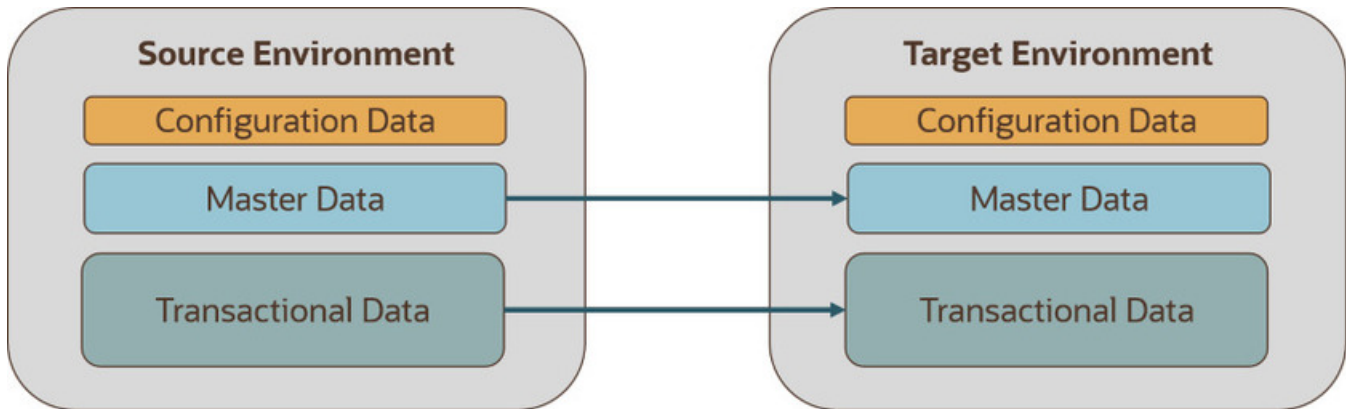

The following points highlight key differences between business data and configuration data that call for special considerations when designing your business data migrations:

- Migration of business data typically involves a much higher number of records in a data set compared with a configuration-only data set. While there is no explicit limit to the size of a data set, some reasonable limit has to be assumed.
- Having large sets of entities depend on relatively few entities in the same data set significantly slows the import process. This situation occurs when mixing configuration data, master data and high volume transaction data in a single migration. We therefore recommend designing separate migrations for these data classes. Refer to the **Reduce Dependency Between Migration Objects** section below for more information.
- All business entities have a system generated key. Refer to [Data with System Generated Primary Keys](#) for more information.

The following sections expand on topics and concepts related to business data migration.

Reduce Dependency Between Migration Objects

CMA leverages the application's referential integrity and business rules to ensure entities remain compliant and valid when imported into another environment. These rules are there to prevent an entity from being imported when any of the entities it references do not exist in the target environment. When both the referencing entity and the entity it references are part of the same data set they establish a **dependency** that dictates the sequence in which these entities should be processed in order to be successfully imported. Note that the tool supports even the more complex and rare situations wherein the dependency between entities is cyclical, i.e. entity A (directly or indirectly) refers to entity B while entity B (directly or indirectly) refers back to entity A, for which sequential processing is not enough to guarantee a successful import.

The tool uses foreign key relationships between entities in the same data set to identify sets of dependent entities and group them into separate migration transaction records. Note that these foreign keys are defined in the application's **data model** repository and not at the database level for greater flexibility. The larger the migration transaction the more complex the process is to successfully import all its objects. So while the tool is designed to support all types of dependencies (sequential and cyclical), handling very large sets of dependent objects may incur a significant performance cost.

While configuration entities tend to be highly inter-dependent, the total number of entities that comprise the entire set of configuration objects is relatively small. Therefore, the impact on performance such dependencies have when importing a configuration-only data set is negligible. On the other hand, configuration entities tend to be referenced on many master and transaction entities as they control many aspects of the latter's business rules. As such, mixing configuration and business

data in the same data set is likely to form extremely large sets of business entities that dependent on a small number of configuration entities. It is therefore strongly recommended to import or set up configuration data in the target environment prior to importing business data into it.

In a similar way, some transactional data tends to be of a much higher volume compared to the master data entities they reference. Here too, it is strongly recommend to migrate master data entities prior to their high volume related transactional data. For example, many interval measurement records (transaction data) reference the same measuring component (master data). Migrating a large volume of measurement data along with their measurement component would result in a very large migration transaction that may take long to import. Importing the measurement components prior to migrating their interval measurements will eliminate unnecessary dependencies within the measurements only data set and significantly improve the performance of the overall process.

Reasonable Data Volume

The overall volume of all business entities to migrate in a single data set should be reasonably sized. For example, importing several hundreds of accounts and their related master and transactional data is considered a reasonable size. Migrating too much data may reach physical and performance limitations of the tool.

You may use any supported migration request methods for describing the entities to export. If you opt for an Entity List migration request, consider using the [Collect Entity](#) dashboard zone to build the list of entities as you browse them on their respective portals.

Single Source of Data

CMA uses an entity's prime key to determine if it is new to the target environment and therefore should be added or refers to an existing record and therefore needs to be replaced with the new version. All business entities have system generated keys, which are environment specific. It is therefore possible to have different entities in separate environments having the same prime key. When migrating entities whose keys are system generated, it is strongly recommended to migrate data to a target environment from a single source environment and avoid creating such entities in the target environment using the application. This practice ensures that prime keys for an imported entity are always in sync with their source environment. Refer to [Data with System Generated Primary Keys](#) for more information and considerations.

No Deletion

CMA does not handle deletion of entities of any kind, whether they are configuration or business entities. If a test needs to be repeated using an initial snapshot of the data, you should restore your target environment to a backup taken before test data was imported and import the latest version of the test data. If there is no need to delete previously imported entities, you may keep reloading test data from a single source environment as needed.

Bulk Import Mode

By default, the import process creates a migration object for each imported entity. This allows for granular reporting and error handling at the entity level. When importing a high volume data set of business entities, this granular management has a performance toll. In this situation, you may want to use the **Bulk Import** option on the migration data set import request. In this mode, a single migration object record is created for multiple entities of the same maintenance object. In the same way, a single migration transaction record is created for multiple logical transaction groups. Using this option reduces the migration object management effort throughout the process and thus results in better performance.

Note that each entity is still individually compared and validated, as in regular import processing, but if one entity is invalid the entire migration object is not applied hence impacting all entities grouped together with it. Bulk import mode is useful when importing a large set of data from a validated data source such that almost no errors are anticipated.

This option is only supported for master and transaction maintenance objects, i.e. it is not applicable to configuration migrations.

Insert Only Mode

By default, the comparison step of the import process needs to determine whether the imported entity is new and therefore should be added, represents a change to an existing entity and should be updated or the entity is unchanged. When importing a high volume data set of business entities that are all new to the current environment, this check is time consuming and can be avoided. In this situation, you may use the **Insert Only** option on the migration data set import request to indicate that all imported entities are assumed to be new additions to the current environment. By doing so, the import process avoids unnecessary steps to determine whether the entity should be added or updated and thus contributes to a faster import process.

This option is only supported for master and transaction maintenance objects, i.e. it is not applicable to configuration migrations.

Separate Batch Processes for Managing Business Migration Objects

By default, the same import related batch processes manage configuration and business data migrations. Typically, business data migrations involve high volume of records compared to much lighter configuration data sets. Processing them together by the same batch process may slow down the performance of configuration migrations, preventing them from completing faster and more frequently. The issue mainly affects test-like environments where mixed data class migrations are more common: configuration data is imported from a lower environment and large test data is imported from a higher environment. You may adjust the base product's configuration in such environments to benefit from separating the import processes for configuration and business data.

Note that the ability to separate import processes applies to migration objects only because of their volume. Migration data set and transaction records are of low volume and as such remain managed by the same batch processes.

Designated batch processes are provided for importing migration objects containing business data but they are not used by default:

- F1-MGOPB - Migration Object Monitor (Business)
- F1-MGOAB - Migration Object Monitor (Business) - Apply

Follow these steps to use these separate designated batch processes for business data:

- Update the **Migration Object Business Data** (F1-MigrObjectBus) business object to reference the business data related batch controls on the following statuses:
 - **Pending, Error Applying, Needs Review** - Migration Object Monitor (Business) - F1-MGOPB
 - **Approved** - Migration Object Monitor (Business) - Apply - F1-MGOAB
- If your organization uses event driven job submissions for CMA batch processes then refer to [Running Batch Jobs](#) for additional configuration steps.

Data with System Generated Primary Keys

For records with system generated keys, there is an issue if the target environment already has a record with the same key but doesn't represent the same record. The tool shouldn't be just updating that target record with the view of the source in case this will break foreign key relationships that exist in the target.

The tool provides support for administrative data with system-generated primary keys. The logic relies on the maintenance object to use a method that looks at other attributes of the record (considered a "logical key") to detect whether the record being migrated already exists in the target region or not. The examples in this section are based on the Attachment maintenance object. Common attachments are considered administrative data. The attachment MO uses the file name and the creation date as the "logical key".

Imagine a common attachment for the "standard rate codes" file exists in a source region with the key 123456789. The table below highlights possible situations at the target region and actions supported in CMA.

Scenario	Target Situation	Action	Comments
1	No matching record	Record can be added with key 123456789.	
2	Record exists with key 123456789 and logic confirms that it is also the "standard rate codes" attachment.	Record can be updated.	
3	Record exists with key 123456789, but logic detects that it is not the "standard rate codes" attachment.	Record is not updated. An error is issued.	The system cannot update this record because it's not the right attachment record.
4	The system detects that another attachment record exists for the "standard rate codes" attachment with a different ID.	Record is not updated. An error is issued.	Assumption is that the record was created directly in the target or was copied from a different source.

The use cases described in scenarios 3 and 4 above would require key mapping to keep track of the id from the source to the id in the target so that any other records from the source that reference this key as a foreign key would be updated as part of the migration. This functionality is not supported.

Scenarios 1 and 2 above are supported for maintenance objects that use the method to detect the logical key.

NOTE: If a maintenance object with a system generated key does not supply a method to detect the logical key, CMA will update an existing record with the same ID. For maintenance objects in the framework that provide this method, refer to [Framework Provided Migration Configuration](#). For your specific edge application, refer to the CMA addendum for information about support for data with system generated keys.

The product recommends that an implementation establishes a migration strategy such that records with system generated keys are always created in the same region and always follow a standard migration path for promoting the data from this source region to other regions. Following this strategy, you would minimize or eliminate the possibility that a record for the same logical key is created in multiple places such that different IDs would be generated as described by scenario 4 above.

MOs with a Mixture of Administration and Non-Administration Data

There are some MOs that contain a mixture of master or transaction data and administrative data. The Attachment is an example of this. The product supports common attachments and owned attachments. Owned attachments are records that are specific to its owner. The owner could be master or transaction data and its attachments are therefore considered master or transaction data. Owned attachments are not candidates for migration using CMA. Common attachments on the other hand are considered administrative data and may be candidates for migration using CMA. For these use cases, an implementation may follow the suggested strategy of only creating the administrative data in one region so that IDs for common attachments are not reused. However, it is reasonable and expected that owned attachments are being created in the target region and may receive a system generated key that matches the key of a common attachment from the source region.

To try to minimize this issue, the system includes special logic to be used by any MO that may contain administrative data mixed in with master or transaction data. This special logic generates the key of an administrative record with a zero (0) in the middle of the key and ensures that the keys for master and transaction data do not include a zero in this spot. For maintenance objects in the framework that use this method, refer to [Framework Provided Migration Configuration](#). For your specific edge application, refer to the CMA addendum for information about additional maintenance objects that may be in this category.

Importing Data that References a User

Although the tool supports copying users from one environment to another, the assumption is that it will be more common for implementations to define their valid users for each environment separately. In fact, the default CMA configuration for copying security configuration assumes that users are not being copied.

There may be times were a record is being copied from one environment to another where a user is referenced on the record but that user is not valid in the target environment. For example, if a batch control is configured as Timed with a user referenced, if this batch control is copied to another environment, what should happen if that user is not found? You may not want that user defined in the target environment. To handle this, the product provides support for a Default User that you can define in the [migration assistant configuration](#). If this default user is configured then any time the CMA import

process recognizes that a record references a User and the user does not exist in the target environment, it updates the record to instead refer to the default user.

NOTE: Please note that if you are trying to copy entities that includes valid users, you should ensure that all the users are copied to the target environment first. Otherwise, the entity will be updated to refer to the default user, which may not be your intention.

NOTE: If you copy records that reference a User within an XML field or CLOB, the CMA input tool is not able to detect that. A pre-compare algorithm is recommended if this use case exists in your implementation.

Additional Considerations

The following sections describe some additional considerations for CMA.

File Transfer Considerations

When moving the export file between systems, use the binary transfer option of whatever tool you use to move the file so that line-end characters are not converted from Linux-style to Windows-style or vice versa.

It is recommended to avoid using 'txt' for the export file's extension (defined in the [master configuration](#)). That file extension by default implies a non-binary file and tools that perform file transfer may treat this as a non-binary file unless explicitly stated. The recommendation is to define 'cma' as the extension. This is not a recognized file extension and most file transfer tools will transfer the file as is.

Note that if the file gets converted, there are two likely outcomes - either a numeric conversion error, or a buffer under-run error may be received when attempting to import the file.

Multi-Language Environment Considerations

If your implementation uses a language other than English, it means that migrated administration objects may have multiple language rows (because English is always enabled). There are some important points with respect to multiple languages and CMA:

- As described in [User Language](#), there are steps to follow when supporting an additional language. The steps outlined in that topic highlight that for system data, translation of the strings may be provided via a language pack provided by the product or may be the responsibility of your implementation. In either case, this effort is non-trivial and will have its own established plan. The expectation is that the translation of the system data is applied for each region at your implementation site. CMA should not be used to create a new language in a target region.
- For administrative / control data that your implementation develops as part of your project, the expectation is that descriptions for your supported language are entered in the region that is considered the source region used to promote changes to regions in the "chain". For example, control data is entered in a development region and promoted to a test with the supported language enabled in both regions.
- What if you export data from a region with more languages enabled than your target? This scenario is perhaps a case where the source region is a type of test or playpen region where the additional language is enabled for other purposes. In this case, if the language code doesn't exist at all in the target region, the import will produce an error given that the code is invalid. If the language code exists but is not enabled, this will cause the extra language rows to be inserted in the target region, but will not cause any issues. They are simply ignored.
- What if you export data from a region with fewer languages enabled than your target? In this situation, the import process will only create language rows for the languages that were copied from the source. It will not automatically create language rows in the target as part of the import. For this situation, the recommendation is to run the **New Language** batch program (**F1-LANG**) that creates any missing language entries.

Versions and CMA

This topic addresses two separate version related topics with respect to using CMA between two environments.

- Different versions of the application
- Different CMA file format versions

Different Versions of the Product

CMA was developed with the main requirement of copying data between two environments that are on the same version of the product. For example, copying configuration data from a development environment to a test environment on the same product version.

In general, there isn't anything about how CMA functions that would limit your ability to copy data between two different versions of the product. However, it's possible that your product has enhanced the functionality of a specific object to add or remove columns or change the type of data captured in those columns or has change validation around how data should be captured.

Our products follow strict standards for upgrading clients to ensure backward compatibility. Upgrade scripts in the blueprint process know what was changed from one release to another and update the data accordingly where applicable. When using CMA to move data from one version of the product to another, you are bypassing these upgrade scripts. It means your data is not being adjusted as expected. It's not recommended unless you are certain that the data of an object from one version is compatible in the other version. The following points highlight this in more detail.

- For objects whose structure and rules have not changed between the two versions, there should be no issues.
- For objects that have changed between the two versions, there are scenarios that may cause additional steps.
 - If the target environment is a later version and includes a new optional column on an object that was not present in the source, the import should go through without any issues.
 - If the target environment is a later version and includes a new required column on an object that was not present in the source, a 'pre-compare' algorithm could be used to populate the new required value. Your implementation can provide this algorithm to populate the data according to your business rules.
 - If the target environment is an earlier version than the source, we cannot guarantee that there won't be specific issues encountered with specific objects.

File Format Version

If your implementation has decided that you are going to use CMA across product versions, given all the cautions described in the previous section, this section provides information on the rare case where CMA has a change in who it writes the export file.

When creating the export file, the format of the file is specific and the CMA import step knows how to read the file. It is rare, but there are times when the product makes an enhancement to CMA that requires a change in the structure of the export file at which point the 'version' of the CMA file is incremented.

The CMA file format version has no impact to migrations that are exported and then imported into the same version of Oracle Utilities Application Framework. However, if your implementation has different environments on different versions of the product where the CMA file format is also different, then the system has functionality to cater for these differences.

- If you are exporting data from a lower file format version to a higher file format version, there is nothing special that you need to do. The export step captures the file format version and the import step reads this information and processes the file accordingly.
- If you are exporting data from a higher file format version and the product currently supports exporting to a lower file format version, at export time you are prompted for the earlier file format version. You may indicate that you want the earlier file format version when creating the migration data export.

NOTE: The product supports exporting to an earlier file format version for a reasonable amount of time, but not in perpetuity. If you don't see any option in the user interface to export to an earlier file format, it means that it is not supported in that release.

CMA Configuration

The following sections describe tasks required for CMA configuration.

Master Configuration - Migration Assistant

The **Migration Assistant Configuration** [master configuration](#) record defines system wide configuration used in both the source environment and the target environment.

As described in [Importing Data that References a User](#), if you have records being imported that may reference a user does not exist (and shouldn't exist) in the target environment, define a Default User here.

In both the source environment and the target environment, the system needs to know the location of the export directory and the import directory along with the expected file suffix. For these fields, implementations may also rely on the system defaults. If no Migration Assistant Configuration record is found, the system assumes that there is an entry defined in the system's substitution variable list for **F1_CMA_FILES**. Further it defaults the values as follows:

- Export directory is the value for this variable plus "**\export**".
- Import directory is the value of this variable plus "**\import**".
- File suffix is set to **cma**

Refer to [Referencing URIs](#) for more information about the substitution variable list.

For additional information about specific fields in the master configuration, refer to the embedded help.

NOTE: This record can be updated at any time to change details. The new configuration takes effect on all subsequent exports and imports.

Migration Plans

A migration plan defines one or more types of objects that are eligible for migration. It is essentially a set of instructions describing how the data to be exported is structured, allowing objects to be migrated together as a logical unit to ensure consistency and completeness.

The migration plan is always related to a given maintenance object, defined using its primary instruction. Multiple migration plans may exist for a given maintenance object if there are different requirements for migrating records in that MO under different circumstances. For each migration plan, you decide if additional data should be included as part of an object using subordinate instructions. For example, when copying a single algorithm type, should the system only copy that algorithm type record, or should it also copy all its algorithms and its related script (if applicable)? Refer to [Types of Migrations](#) for more information.

The following topics describe defining a migration plan as well as other topics for a migration plan.

Defining a Migration Plan

To view or define a migration plan, navigate using **Admin > Implementation Tools > Migration Plan**.

Use the **Migration Plan Query** portal to search for an existing migration plan. Once a migration plan is selected, you are brought to the maintenance portal to view and maintain the selected record.

CAUTION: Important! If you introduce a new migration plan, carefully consider its naming convention. Refer to [System Data Naming Convention](#) for more information.

The following points provide information about defining **Instructions** for a migration plan.

The **Instruction Sequence** uniquely identifies the instruction. The recommendation is to use increments of 10 to allow insertion of other instructions in the future.

Select **Primary** for the first **Instruction Type**. All migration plans must contain one and only one primary instruction. All subsequent instructions require a **Subordinate** instruction type. In this case, the **Parent Instruction Sequence** must be entered. This number, used to maintain the defined relationships in the exported data, must match an instruction sequence number at a higher level in the hierarchy.

The instruction **Description** provides a business description of the instruction.

Select a **Business Object (BO)** to define the type of object from which data will be derived.

NOTE: Though BOs are specified in each instruction, it's important to understand that each BO is used only for filtering purposes. The migrated data set comprises the complete contents of the *maintenance object* that the business object structure is defined against. For a more detailed explanation of this, see [Understanding the BO Filtering Process](#).

NOTE: Refer to [Identifying Tables to Exclude From Migrations](#) for information about defining child tables to always exclude from a migration.

Traversal Criteria is used to define the relationship between each of the objects in a migration plan. The system provides three options to define how the child object is connected to the parent object so the system knows how to traverse from one object to another. **Traversal Criteria Type** options are **Constraint**, **SQL** and **XPath**. The following points explain each option:

- **Constraint** allows you to select a table constraint that represents a given record's relationship to another record in the system via a foreign key constraint defined in the meta-data. If **Constraint** is selected, the following additional fields are enabled:
 - **Constraint ID** is a unique identifier for the constraint. The search will show the valid table constraints for the MO of the instruction's BO and the MO of the parent instruction's BO.
 - **Constraint Owner** is used to define the owner of the constraint. This is populated automatically when selecting a constraint from the search.
- **SQL** lets you specify SQL join criteria between the parent instruction's object and the child object in the **SQL Traversal Criteria**. The syntax of the the traversal criteria is a WHERE clause (without including the word WHERE). When referring to a field on the parent instruction's object, use the syntax `#PARENT.TABLE_NAME.FIELD_NAME`. When referring to a field on the current instruction's object, use the syntax `#THIS.TABLE_NAME.FIELD_NAME`. For example, the following statement is used on a migration plan for Business Object, where the parent instruction is the BO and the subordinate instruction is used to reference the UI Map that is referred to as a BO option with the option type "F1DU":

```
#PARENT.F1_BUS_OBJ_OPT.BUS_OBJ_OPT_FLG = 'F1DU' AND @trim(#THIS.F1_MAP.MAP_CD) = @trim(#PARENT.F1_BUS_OBJ_OPT.BUS_OBJ_OPT_VAL).
```
- The **XPath** option lets you apply syntax in an XPath expression referencing elements in the instructions' referenced business objects. This is entered in the **XPath Traversal Criteria**. For example, the display map collection statement in the SQL example noted above would be written as follows in XPath: `#this/mapCd = #parent/businessObjectOption/businessObjectOptionValue AND #parent/businessObjectOption/businessObjectOptionType = 'F1DU'`. This technique allows foreign key references that are mapped inside an XML column to be referenced.

NOTE: The #parent expressions may access elements that are stored in an XML column and described using mapXML and mdField. However, the #this expressions must refer to fields available in the business object using the mapField reference.

Defining **Next Migration Plan** provides the ability to indicate that in addition to copying the object defined in the instruction, any additional instructions included in that referenced migration plan will also be included in an export.

The **Algorithms** grid contains algorithms associated with each instruction. You must define the following for each algorithm:

- Specify the **System Event** with which the algorithm is associated (see the table that follows for a description of all possible events).
- Specify the **Sequence** and **Algorithm** for each system event. You can set the **Sequence** to 10 unless you have a **System Event** that has multiple **Algorithms**. In this case, you need to tell the system the Sequence in which they should execute.

System Event	Optional / Required	Description
Pre-Compare	Optional	Algorithms of this type may be used to adjust the data after it is moved to the target system. These may only be defined on the primary instruction. Refer to Adjusting Imported Data for more information.
Import	Optional	Algorithms of this type are no longer supported.

Understanding the BO Filtering Process

Migration plan instructions require the definition of a business object to provide CMA with information about the record related to the instruction.

If the business object is the physical business object for the maintenance object, then CMA assumes that the instruction applies to all records that satisfy the traversal criteria. CMA recognizes the physical BO by comparing the BO to the value defined in the maintenance object option. If the business object defined is not the physical BO, then CMA will limit the records in the instruction to those that explicitly reference this BO or reference a child of this BO as its [identifying BO](#) value. (In other words, this BO must be in the parentage hierarchy of the records to be included in the instruction.)

NOTE: Unlike Bundling, CMA does not use the BO schema to drive what data is copied for a given record. The BO is only used as a filtering mechanism for selecting records. Refer to [Identifying Tables to Exclude from Migration](#) for information about how to ensure a child table is not included in a migration.

For example, if you define a migration plan for Master Configuration and use the physical business object for the instruction (**F1-MstCfgPhysicalBO**) then all master configuration records are considered for the instruction. If instead the business object you define is Migration Assistant Configuration (**F1-MigrationAssistantConfig**) then only the record related to this business object is included in the instruction.

Migration Plans for Objects with XML-Embedded Links

When migrating objects where foreign key references are captured in the object's XML based field, subordinate instructions are needed to define the foreign key references in order for CMA to understand the relationships. This is in contrast to direct foreign keys where CMA can determine the relationships using constraints. The instructions provide two purposes. Defining instructions ensures that the related objects are included in the migration, if appropriate. If you know that the related objects are included because of other criteria, the instructions allow CMA to group related objects into transactions. This helps in the apply process at import time to ensure that related objects are grouped together. However, the apply process includes iterative steps to try to overcome dependencies like this so defining the instructions is not critical for this purpose.

The following are options for creating migration plans with XML-embedded links:

- One option is to use the specific logical (business) BO in the primary instruction to define the object you are copying. With this option, the subordinate instructions may use XPath criteria to define the related foreign key. When this approach is used, a separate Migration Plan must be created for each logical BO. (Refer to [Understanding the BO Filtering Process](#) for more information.) This option would only be used in isolated cases.
- Another option is to create a migration plan that uses the Physical BO as the primary instruction, and then include a subordinate instruction for the real logical BO, using SQL Traversal to join the object to itself by its primary key. Note that with this technique, the records that reference the logical BO will still only be included in the export file once. At this point further subordinate instructions may use XPath notation to define the foreign key data. Using the physical BO as the primary instruction ensures that all records in the MO are considered. The subordinate instructions with the logical BO and XPath notations will only apply to the records that are applicable to that BO. This option is useful for MOs that have a small number of logical business objects with disparate foreign keys.
- Another option is to use the physical BO in the primary instruction and use raw SQLs in the subordinate instruction's traversal criteria to identify the foreign keys using substring commands. A separate Subordinate Instruction is needed for each SQL corresponding to each element occurrence. Using this technique has the same advantages of the previous in that all records for the MO are included in the migration. However, this technique may be useful for maintenance objects with a larger number of business objects expected where each has one or more foreign keys. It's especially useful if many business objects reference the same foreign key. Then only one instruction is required for that foreign key. Note that a single migration plan may use this technique and the XPath technique for different elements.

A migration request may have multiple migration plans for the same maintenance object. That allows for some flexibility and long term maintainability in that the above techniques may be used in multiple migration plans. Consider the following example:

- A product provides base business objects with foreign keys defined in the XML field and provides the appropriate migration plan with instructions. An implementation extends this business object or perhaps creates their own business object for the same maintenance object and includes different additional foreign keys in the XML. Rather than duplicating the base migration plan and adding additional instructions for the additional foreign keys, the implementation can create a second migration plan for the MO with the additional foreign keys defined. A migration request should be defined to include both migration plans. In this case if the implementation has only one custom BO, they can choose to use the custom BO as the primary instruction as described above in the first option.

Defining a Migration Request

Migration Requests are used to define the data to be included in a migration. To view or define a migration request, navigate using **Admin > Implementation Tools > Migration Request**.

Use the **Migration Request Query** portal to search for an existing migration request. Once a migration plan is selected, you are brought to the maintenance portal to view and maintain the selected record.

There are three types or classes of migration request. The system provides a base business object for each along with a migration request class, which matches the business object. The subsequent sections provide more information about each class of migration request.

Note that all migration requests support defining a Category, which allows implementers to categorize the migration request.

In addition, all classes of migration request include the following zones:

- **Migration Request** This zone contains display-only information about the selected record. Please see the zone's help text for information about this zone's fields.
- **Referencing Migration Requests** This zone is only visible if the displayed migration request is included in a Group migration request. It lists each group migration request that includes it.

Other zones may appear for specific classes of migration requests. See the following sections for more information.

Criteria-based

This type of migration request defines a set of migration plans to be logically included together as part of a migration. For each migration plan, selection criteria is defined to indicate which records for each MO should be included. Selection may be defined using SQL, an algorithm or explicit primary key values.

- For selection using SQL Statement, refer to the embedded help for examples.
- For selection using Algorithm, the algorithms that are eligible to be plugged in here are those valid for the **Migration Request - Select** system event.
- For selection using Specific Keys, the primary key (1 through 5) must be explicitly specified. Multiple rows are allowed.

Entity List

This type of migration request allows the user to choose explicit MO / prime keys. The MOs that are eligible are those that are configured with a **Default Migration Plan** option. Although the user is managing MO / PKs, the migration instructions are still defined with a migration plan. The system maps the migration instructions in a similar way to a **Criteria-based** migration requests that use a Specific Key selection type. Note however that it will create a separate migration instruction for each MO / PK combination. It does not try to group all PKs for the same MO / migration under one migration instruction.

For this type of migration request, a user adds a migration request record with its description and other main information. Then, a special zone **Add Entities** is provided to find and select records based on a selected maintenance object and add to the migration request. The user is prompted to provide a reference and comments, if desired. If the category selected is one that requires a reference, then this will be validated. Alternatively, you may also use the [Collect Entity](#) dashboard zone to add specific entities as you review them on their respective maintenance portals.

When maintaining a migration request with existing entities, they are visible in the zone **Migration Request Entities**. This zone allows a user to remove the entity from the list.

Group

This type of migration request points to other migration requests. This allows you to define separate migration requests that represent logical groupings of migration plan instructions for ease of maintenance, but to combine all the separate migration requests into a single "grouped" migration request for streamlined export / import purposes.

The CMA export process will build an extract that includes the union of all the objects that qualify for the export and group them together based on their relationships.

Identifying Tables to Exclude From Migrations

Some maintenance objects that are eligible to be migrated may include child tables that should not be included in the migration. For example, if an object includes log tables, the entries in the log should reflect the actions on the object in that system, and will be different between the source system and the target system. If you have a custom Maintenance Object that includes tables you don't wish to migrate (such as a log table), use the **Non-Migrated Table** option on the MO to specify this table. All child records for this table will also be ignored during migration.

Another use case to consider is a child "many-to-many" table that connects two administrative objects and exists in the maintenance object of both tables. The child table may be in both MOs for convenience sake, but it may be that one MO is considered more of a "driver" object and the other more of a subordinate. If you are doing a migration where you want to copy a subset of objects, you may want to only copy the driver object and its children and their data but not their children. For example, a To Do Type includes a collection of valid To Do Roles and in turn the To Do Role refers to its To Do Types. If an implementation wants to copy a single To Do and include all its related information, including its To Do Roles, it does not want the migration of each To Do Role to in turn copy all its To Do Types (and their data).

NOTE: The MO option must be set in both the Source and Target systems for a given MO.

Configuring Custom Objects for Migration

During the implementation and extension of the product, new custom administrative maintenance objects may be introduced. If your implementation would like to migrate records in those maintenance objects using the Content Migration Assistant, additional steps must be performed, which are highlighted in the following sections.

Physical Business Object

As described in [Understanding the BO Filtering Process](#), the migration plan requires a business object for its instruction. The business object is used to identify the records eligible for inclusion in the migration. Assuming your custom tables use one or more "logical" business objects for their processing, your implementation must decide if these business objects are appropriate for use by the migration plans, or if a physical BO is warranted. If so, [create an appropriate physical BO](#).

Review MO Option Configuration

The following points highlight maintenance object (MO) configuration that should be reviewed or updated to support CMA:

- If a physical BO was created (above), link it to the MO as an option using the appropriate option type.
- Be sure that your MO defines an appropriate [FK Reference](#) and includes an Option on the MO that identifies the FK Reference. This is used by various portals and zones for CMA when showing detail about records being imported into the target region. Also be sure that this FK reference defines an Information program.
- As described in [Identifying Tables to Exclude From Migrations](#), an MO option is used to identify child tables for an MO that should never be included in a migration. If your custom maintenance object includes a standard Log table, then the recommendation is to list that table as an excluded table. Depending on the specific design of the maintenance object, there may be other child tables to define.

Characteristic Type Configuration

The CMA import process will attempt to create a log record for any administrative object that includes a log table. If your implementation has introduced any custom administrative tables that you plan to include in a migration request and it includes a log table, you must, to ensure that the log creation is successful, add your log table as a valid characteristic entity to the characteristic type **F1-MGO** (Migration Object).

Navigate to [Characteristic Type](#) and select the characteristic type **F1-MGO**. Navigate to the **Characteristic Entity** tab and add a row to include the characteristic entity for your custom maintenance object's log table.

Standard CMA Configuration

Create one or more migration plans for the new object, depending on the type of data in the maintenance object and the types of migrations you envision:

- If you have implemented only one "logical" business object used to define the data in the MO, then a single migration plan that references the this BO (or the maybe the MO's physical BO) is appropriate.
- If you have implemented more than one "logical" business object, would the data for multiple business objects get copied together? Then perhaps a single migration plan that references the MO's physical BO is appropriate.
- Are there additional foreign keys defined using mapXML in the business object(s) for the MO? If so, then it is recommended to include sub-instructions to define the links. At this point, if multiple "logical" BOs exist, your implementation may choose to define all the additional elements in the same migration plan or choose to define separate migration plans for each logical BO.
- Your implementation may decide to define more than one migration plan for the same type of record based on the types of migrations you plan to include. For example, you may decide to include a migration plan that copies only the records in this maintenance object. You may decide to define another migration plan that copies the records in this MO along

with related records in another MO (for a special type of migration). Having said that, be sure to design the migration plan with reuse in mind to minimize maintenance efforts.

In order to support **Entity List** migration request, a default migration plan must be defined as an option on the maintenance object. This should be a single migration plan that supports all types of business objects for the MO.

If your implementation has a template migration request to use for migrations, include the new migration plan(s) as appropriate.

CAUTION: Important! New migration plans and migration requests should follow naming conventions. Refer to [System Data Naming Convention](#) for more information.

The CMA Execution Process

The following diagram illustrates a high-level view of the Content Migration Assistant execution process. The subprocesses illustrated here are described in more detail in the following sections.

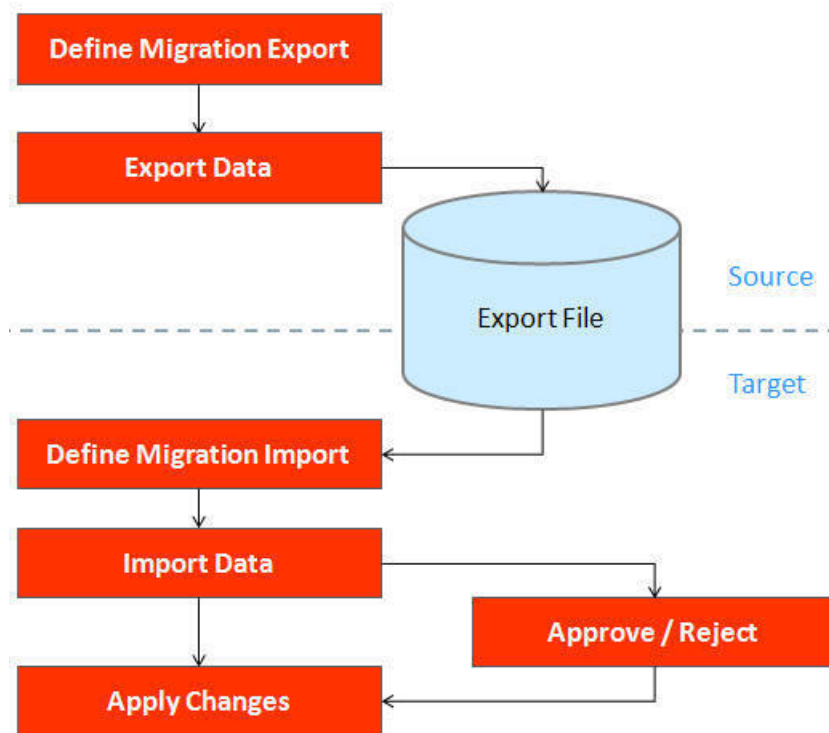

Exporting a Migration

The migration export process begins in the source environment by defining a **Migration Data Set Export**, which specifies a defined **Migration Request** and provides a file name and description for the export file. After the data set is defined and saved, the **Migration Data Set Export Monitor** batch job can be submitted generate the export file. The lifecycle of the Migration Data Set Export business object includes algorithms that select the appropriate records according to the migration request, determine dependencies between records to build groupings of related objects and create the export file.

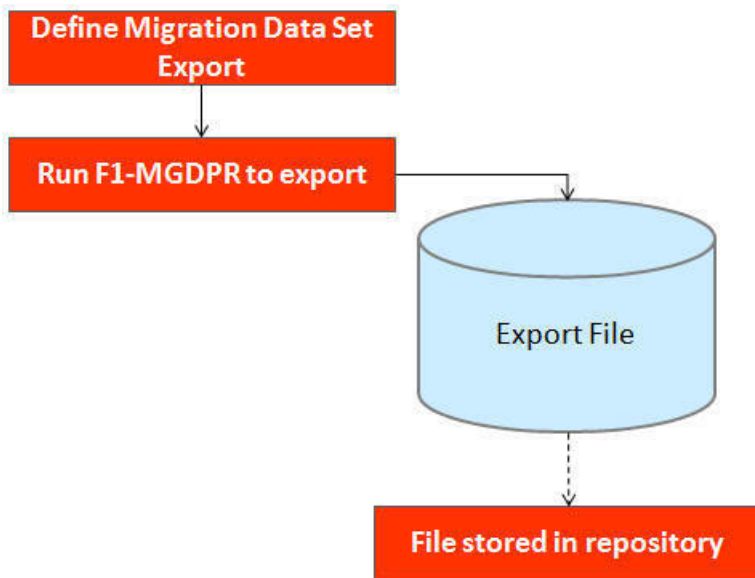

The following topics provide more detail about this process.

Migration Data Set Export

To migrate data from one region to another, define a **Migration Data Set Export**. This establishes the export file name and identifies the migration request.

To view an existing migration data set export, navigate using **Admin > Implementation Tools > Migration Data Set Export**. Use the query criteria to locate the desired data set.

Note that you can also initiate the creation of an export data set from the [Migration Request](#) portal using the **Export** button.

The export requires the name of an existing **Migration Request**.

Enter a unique **File Name** for the export. Do not use spaces in the name, and do not enter the file extension or a path. The output location and file extension of the intended export file, which should appear in the **Export Directory** and **File Suffix** labels, are defined as described in the topic [Migration Assistant Configuration](#).

Enter an **Export Description** to provide information about the purpose of the export. Note that this field is not language enabled.

The **Source Environment Reference** is for information purposes. It should be populated with text that provides a meaningful description of the source environment. The default value is the URL of the source environment.

The **Migration File Version** is only visible if the product currently supports creating a file in an earlier [file format version](#). If this element is visible and you are planning to import the file in a target environment that uses an older migration file format version, indicate the lower file format version that you wish the export to use.

Export Lifecycle

The following diagram describes the lifecycle of a Migration Data Set Export (data set).

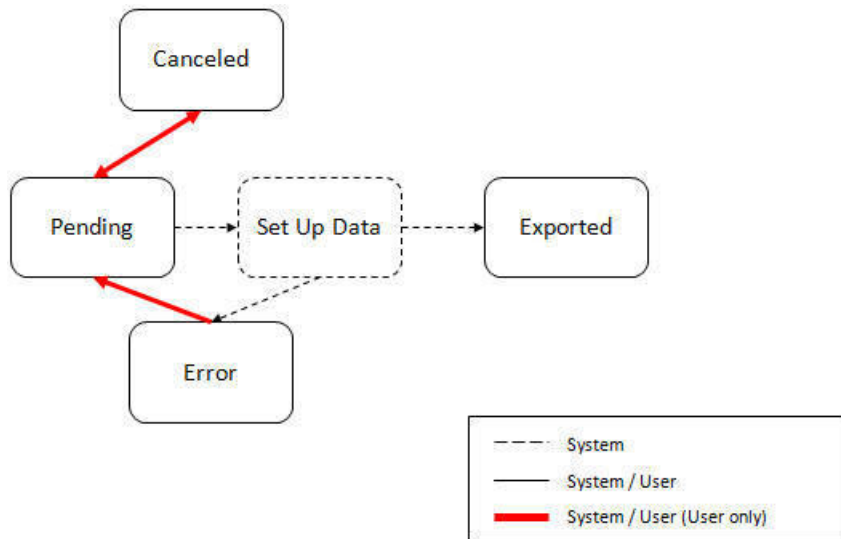

The following points describe the lifecycle.

- The data set is created in **Pending** status.
- A user may choose to temporarily **Cancel** a pending data set to prevent it from being processed. The user can later return it to the Pending state when desired.
- The record remains in Pending until its monitor batch job is submitted. The **Migration Data Set Export Monitor** (F1-MGDPR) selects pending records and transitions them to **Set up data**. Refer to [Running Batch Jobs](#) for more information.
- Set up data is a transitory state that includes the algorithm that does the work of determining the objects to include in the export and group related objects together into a transaction. If everything is successful, the export file is written to the appropriate file location and the record transitions to **Exported**. If an error is detected, the process stops and the record transitions to **Error**.
- If a record is in error and it is possible to correct the error, the record may be transitioned back to Pending to try again.

When the process is marked as **Exported**, the export file can be imported into the target system.

NOTE: The export process creates a file, providing the benefits of having a standalone file. It can be stored in a version control system for audit purposes or provided to others for import purposes.

CAUTION: Under no circumstances should exported data files be edited manually. Doing so could cause data corruption when the file content is applied to the target environment.

NOTE: The export functionality is supported using the business object **Migration Data Set Export** (F1-MigrDataSetExport). The expectation is that implementations will use the delivered base business object and its logic and will have no reason to implement a custom business object for the CMA export process.

Importing and Applying a Migration

The import process is broken down into four general steps: Import, Compare, Approve, Apply. The following points provide an overview of the steps.

- **Import.** The first step covers importing the file and creating appropriate Migration Import records in the target environment to facilitate the subsequent steps.

- **Compare.** The compare step reviews each object that is in the import file and compares the object in the import against the equivalent record in the target environment. The comparison step results in noting which objects are unchanged, which are new (and the appropriate SQL to insert them) and which objects are changed (and the appropriate SQL to update them). Based on user configuration at import time, the objects that qualify for the import may be in a state that requires review or may be pre-approved.
- **Approve.** Once the comparison is complete, the user should review the results. There may be records marked for review. All of these records must be approved or rejected before the import can proceed. Users may choose to suppress individual SQL statements for a given object that is approved. When the user is satisfied with the results of the comparison and has completed the review, the import is marked to proceed to the Apply step. Optionally, a migration import may be configured to automatically apply.
- **Apply.** This is the final step and is the step where the records in the target environment are added or updated. Because of potential high volumes of data and because of possible dependencies between records, this step supports two levels of attempting to apply the records. There is an apply step at the object level and an apply step at the transaction level. This will be described in more detail below.

Import Step

The import process starts with verifying the import directory configured as described in the following topic [Master Configuration - Migration Assistant](#) and ensuring that the exported file is located in that directory. Then, in the target environment, a **Migration Data Set Import** record should be created. The user indicates the file name.

In addition, the user decides what the default status should be for resulting objects.

- The **Default Status for Add** sets the default status for objects that are determined to be *new* during the import comparison process. The default is to automatically set new objects to **Approved** status. Other options are to set any new objects to **Rejected** or **Needs Review** status.
- The **Default Status for Change** sets the default status for objects that are determined to be *changed* during the import comparison process. As with new objects, the default for changed objects is **Approved**, with **Rejected** or **Needs Review** options available.

The user may also configure the **Automatically Apply** flag to **Yes**. This allows for use cases where the migration is repetitive and has been tested and the user feels that there is no need for manual approval. Note that when configuring this setting, neither of the Default Status values may be set to **Needs Review** and at least one must be set to **Approved**.

The file to import contains a list of all the objects included in the export. Any objects that the export step determined to be related have been grouped into “transactions”. Once the Migration Data Set Import is created, the next step is for the system to read in the file and create Migration Transactions and Migration Objects.

By default, the import step creates a Migration Object for each entity in the file. When importing a high volume data set of business entities, the user may request to import entities in bulk mode for performance reasons. In this mode, a single Migration Object record may contain multiple entities from the file. If at least one of the entities included in the migration object record is new and the remaining ones are either new or unchanged then the **Default Status for Add** setting applies to it. If at least one included entity is determined to be changed then the **Default Status for Change** applies to the record. Refer to [bulk import mode](#) for more information.

The following is a portion of the Migration Data Set Import lifecycle as it pertains to the import step.

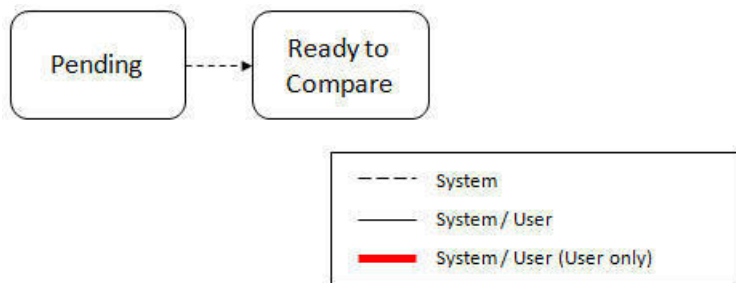

The following points describe the lifecycle.

- The data set is created in **Pending** status.
- The record remains in Pending until its monitor batch job is submitted. The **Migration Data Set Import Monitor** (F1-MGDIM) selects pending records and transitions them to **Ready to Compare**. Refer to [Import Process Summary](#) and [Running Batch Jobs](#) for more information.

The Ready to Compare state has an algorithm that is responsible for reading the related import file and creating the migration transactions and migration objects. The data set remains in this state until the comparison step is complete.

NOTE: A user may choose to **Cancel** a data set. Refer to [Cancelling a Data Set](#) for more information.

The following diagram highlights the relationships of the resulting migration import records.

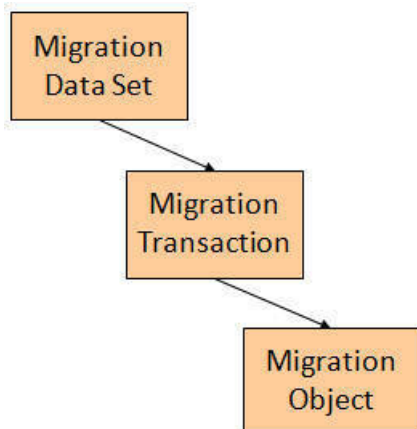

The migration transaction and migration object each have their own lifecycle that will help manage the subsequent compare and apply steps. At the end of the import step, the status values of the three types of records are as follows:

- Migration Data Set Import is in the **Ready to Compare** state.
- Migration Transaction is in the **Pending** state.
- Migration Object is in the **Pending** state.

NOTE: The import functionality is supported using business objects supplied by the base product. The expectation is that implementations will use the delivered base business objects and their logic and will have no reason to implement a custom business objects for the CMA import process. The base business objects are **Migration Data Set Import** (F1-MigrObjectImport), **Migration Transaction** (F1-MigrTransactionImport) and **Migration Object** (F1-MigrObjectImport).

Compare Step

The import step results in the creation of one or more migration objects. Typically, one migration record is created for each record selected in the export based on the export's migration request and its configuration. Related objects are grouped together in migration transactions.

When importing a high volume data set of business entities, the user may request to import entities in bulk mode for performance reasons. In this mode, a single Migration Object record may contain multiple entities from the file. Refer to [bulk import mode](#) for more information.

The next step in the import process is the Comparison step. In this step, the data captured by the import file for each object is compared to the view of that object in the target environment.

To cater for a possible large volume of objects, the comparison is done via a batch monitor. To aide in performance of the process, the monitor is performed on the migration objects so that it can be run multi-threaded. Once the objects are

finished with the comparison, the migration transactions and the migration data set should be updated with an appropriate overall status before continuing to the next step. As a result, the comparison actually requires three steps: Migration Object Comparison, Migration Transaction Status Update and Migration Data Set Export Status Update. The steps are explained in detail in the following sections.

NOTE: Refer to [Running Batch Jobs](#) for more information about streamlining the various steps in the process.

Migration Object Compare

This is the main step of the comparison. The **Migration Object Monitor** (F1-MGOPR) selects pending migration object records and transitions them to **Comparing**. This is a transitory state that includes the algorithm that does the work of comparing. There are various possible outcomes that could occur based on the logic in the algorithm. The following diagram illustrates a portion of the migration object lifecycle that pertains to comparison.

NOTE:

When using [separate batch processes for business data](#) the **Migration Object Monitor (Business)** process (F1-MGOPB) works in the same way to compare business migration objects.

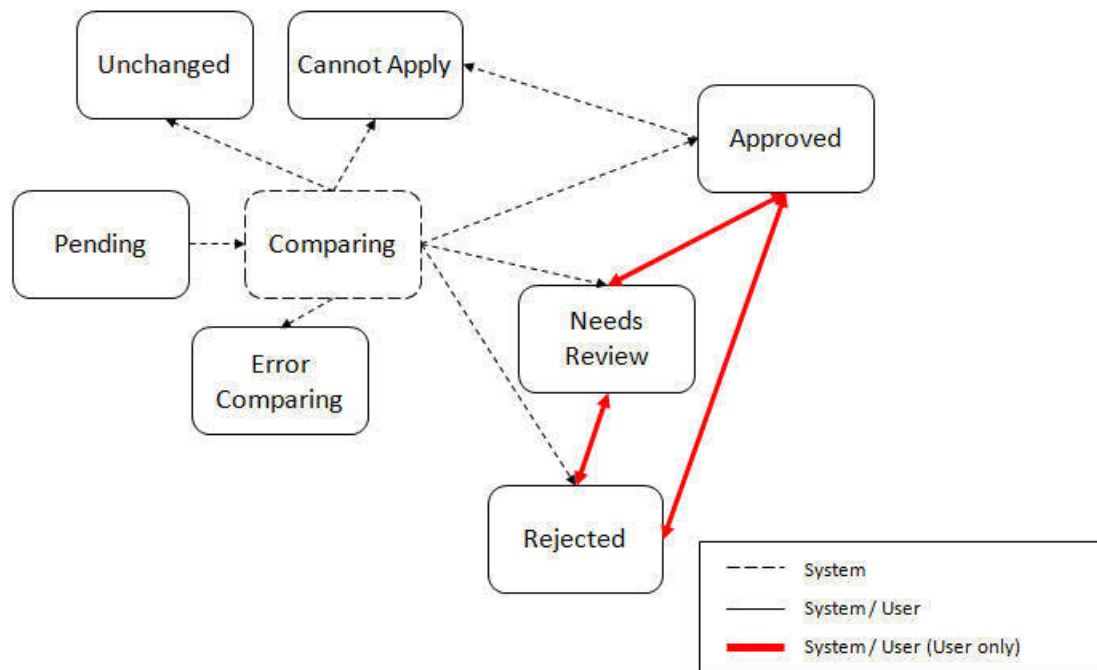

The following points describe the lifecycle.

- When **Pending** records are selected by the monitor batch job, it transitions to **Comparing**. If the migration object refers to one or more pre-compare algorithms, they are executed to [adjust the data prior to comparison](#). Then algorithm will determine the appropriate next state by comparing the source data to the target data.
- Entity related notes:
 - If the record in the migration object is found in the target environment and the data is exactly the same, the record transitions to **Unchanged** (with the object action value also set to **Unchanged**).
 - If the record in the migration object is found in the target environment and the data is different, the algorithm sets the object action value to **Change** and generates the appropriate SQL to be used later in the Apply step to update the record. It then transitions to **Approved**, **Needs Review** or **Rejected** based on the Default Status For Change setting captured on the Data Set.

- If the record in the migration object is not found in the target environment, the algorithm sets the object action value to **Add** and generates the appropriate SQL to be used later in the Apply step to insert the record. It then transitions to **Approved**, **Needs Review** or **Rejected** based on the Default Status For Add setting captured on the Data Set.
- When the import is performed in **bulk mode** each included entity is compared separately but the overall status of the record is set as follows:
 - If all included entities are unchanged then the migration object record transitions to **Unchanged** (with the object action value also set to **Unchanged**).
 - If all included entities are either unchanged or changed then the object action value is set to **Change**, corresponding SQLs are generated for the changed entities only and the migration object transitions based on the Default Status For Change setting captured on the Data Set.
 - If all included entities are either unchanged or new then the object action value is set to **Add**, corresponding SQLs are generated for the new entities only and the migration object transitions based on the Default Status For Add setting captured on the Data Set.
 - If some of the included entities are new and some changed then the object action value is set to **Mixed Actions**, corresponding SQLs are generated for the each entity and the migration object transitions based on the Default Status For Change setting captured on the Data Set.
- If there is any issue with attempting to parse the object data from the import, the record transitions to **Error Comparing**.
- If there is any reason that the imported object is not valid for import, the record transitions to **Cannot Apply**. The log will be updated with the error that caused the record to transition to this state. An example is that perhaps the record was exported in a different version of the product and has additional elements that are not recognized in this version.

NOTE: Refer to [Cancelling a Data Set](#) for information about cancelling a data set and its impact on its related objects.

Migration Transaction Status Update

After the import step, the migration transaction remains in the Pending state until all its objects have completed the comparison step. At that point, the status of the transactions should be updated based on the results of their objects. The **Migration Transaction Monitor** (F1-MGTPR) selects pending migration transaction records and runs its monitor algorithms. There are various possible outcomes that could occur based on the logic in the algorithms. The following diagram illustrates a portion of the migration transaction lifecycle that pertains to comparison.

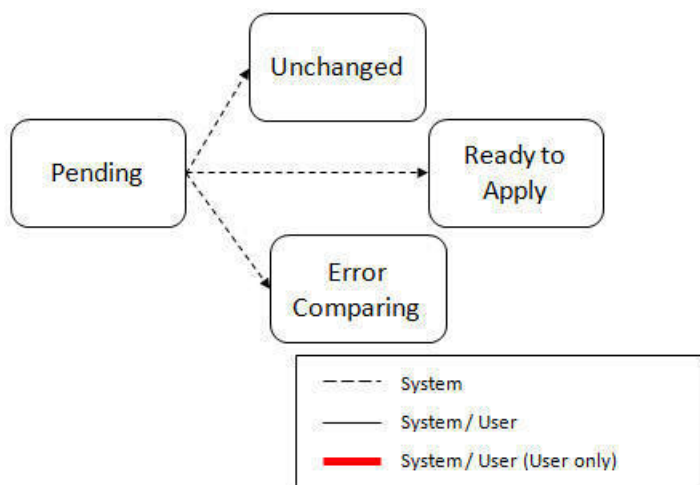

The following points describe the lifecycle possible next states after Pending.

- If any related migration object is in the Error Comparing state, the transaction transitions to **Error Comparing**.
- If all related migration objects are in the Unchanged state, the transaction transitions to **Unchanged**.
- Otherwise, the transaction transitions to **Ready to Apply**. This means that at least one object is in an “apply-able” state.

The transaction remains in the **Ready to Apply** state until a user has approved the data set to move to the Apply step and the transaction's related objects have attempted to apply themselves. This is described in more detail below.

NOTE: Refer to [Cancelling a Data Set](#) for information about cancelling a data set and its impact on its related objects.

Migration Data Set Import Status Update

Once all the objects and all transactions have been updated via the previous two steps, the migration data set export must be updated based on the results of their transactions. The **Migration Data Set Import Monitor** (F1-MGDIM) selects Ready to Compare data sets and runs its monitor algorithms. Note that this is the same monitor process that is used to select Pending data sets. There are various possible outcomes that could occur based on the logic in the algorithms. The following diagram illustrates the portion of the migration transaction lifecycle that pertains to comparison.

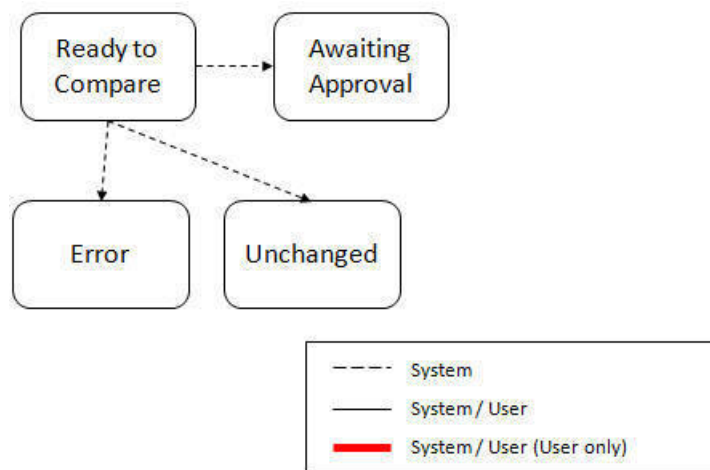

The following points describe the lifecycle possible next states after Ready to Compare.

- If any related migration transactions is in the Error Comparing state, the data set transitions to **Error**.
- If all related migration transactions are in the Unchanged state, the data set transitions to **Unchanged**.
- Otherwise, the transaction transitions to **Awaiting Approval**. This means that there are no errors and at least one object is in an “apply-able” state.

The data set remains in the **Awaiting Approval** state until a user decides that the data set and all its records are ready to progress to the Apply step.

NOTE: A user can choose to cancel a data set at any time while it is in progress. Refer to [Cancelling a Data Set](#) for more information.

Approval Step

Once the comparison is complete and the data set transitions to the Awaiting Approval state, a user needs to progress the data set to **Apply Objects** to trigger the Apply step. The following points describe steps a user may take during the approval step.

- If the data set configuration for the Default State for Add and Change was set to **Approved**, then any migration object that is determined to be eligible for the Apply step will be in the Approved state. In this situation, a user may want to review the data set and its transactions and objects to see verify that the results make sense. At that time, the user is able to move an object to Needs Review or Rejected as appropriate.
- If the data set configuration for the Default State for Add and Change was set to **Needs Review** for either option, then each migration object in the Needs Review state must be reviewed and the user must either Reject or Approve each object before moving to the Apply step.

- If the data set configuration for the Default State for Add and Change was set to **Rejected** for either option, the assumption is that the rejected records don't need to be reviewed. But if a user finds a rejected record that shouldn't be rejected, it may be transitioned to Approved (or Needs Review) as appropriate.

A user has the option to mark one or more SQLs within a migration object to be suppressed. In this case, if the migration object is approved, then only the SQLs that are not marked as Suppressed will be applied. This option is useful when importing a record that has many child records. It may be that the user wants to only include a subset of the child records. This may be done by suppressing the child records that should not be included.

Once the user is comfortable with the data set's results and no more objects are in the Needs Review state, the user should transition the record to **Apply Objects**. This will initiate the Apply step.

Alternatively, if the Automatically Apply flag was set to **Yes** when creating the import record, the import data set will progress from **Awaiting Approval** to **Apply Objects**. Refer to [Import Process Summary](#) for more information.

NOTE: Refer to [Maintaining Import Data](#) for details about the pages provided to help the user review a data set and its transactions and objects to help in the approval step.

NOTE: A user can choose to cancel a data set at any time while it is in progress.

Apply Step

The apply step is the step where records in the target environment are added or updated. Like the comparison step, the apply step is actually multiple steps to optimally handle high volume and dependencies between records as smoothly as possible.

NOTE: Refer to [Running Batch Jobs](#) for more information about streamlining the various steps in the process.

Before explaining the apply steps in detail, the following points highlight the type of data that may be included in a given data set.

1. Records that have no foreign keys and therefore no dependencies on other records. Examples: Message, Display Profile.
2. Records that have foreign keys that may already be in the target. Examples: Algorithms for existing algorithm types, To Do Roles for existing To Do Types.
3. Records that have foreign keys that are new records but also part of the migration. CMA detected the relationship at export time and grouped the objects in the same transaction. Example: Script-based Algorithm Type where the script is also in the migration.
4. Records that have foreign keys that are new records but also part of the migration. CMA did not detect the relationship. This may occur if the referenced foreign key is in a XML or parameter column and the migration plan did not include an instruction to explicitly define the relationship. Example, a Zone that references a visibility script.
5. Records that have circular references where both records are new and are part of the migration. CMA detected the relationship at export time and grouped the objects in the same transaction. Example: plug-in Script for a BO plug-in spot. The script references the BO and the BO references an algorithm for the script's algorithm type. Another example is when the same record is maintained by multiple maintenance objects and therefore exists in multiple migration objects.

To handle high volume data, the first step in the apply process is to perform the apply logic at the migration object level via a multi-threaded batch job. This should result in all records in categories 1 and 2 above being applied successfully.

For records in categories 3 and 4 above, if a record with a foreign key is added or updated before its related record, the validation will fail. However, if the related record is added first and then the record referring to it is added, validation will pass. The tool handles these dependencies as follows:

- Dependency between master and transaction entities is typically hierarchical and in most cases straight-forward. The tool leverages that knowledge to orchestrate the processing of objects in an optimal way that follows their dependency order

as much as possible. Note that relationship between entities could be complex and this approach does not eliminate all processing order related errors but rather significantly reduce them.

- Dependency between configuration entities is more complex and inter-twined and therefore migration objects are not ordered, i.e. the multi-threaded batch process may not process records in the desired order.
- To overcome the potential issue of processing order related errors, the Apply step has special functionality, described in detail below.

For records in category 5 above, the circular reference will mean that the apply process at the object level will not successfully add or update these records. The apply process at the transaction level will cover these records. This is described in detail below.

Apply Objects

Once the Data Set is in the state of **Apply Objects**, the **Migration Object Monitor - Apply** process (F1-MGOAP) runs to attempt to apply the objects.

NOTE:

When using [separate batch processes for business data](#) the **Migration Object Monitor (Business)- Apply** process (F1-MGOAB) works in the same way to apply business migration objects.

The background process in conjunction with the Apply algorithm have special functionality to ensure records in categories 3 and 4 (above) successfully apply during this step:

- The **Migration Object Monitor - Apply** process is a special one that continually re-selects records in the **Approved** state until there are no more eligible records to process.
- When an error is received in the Apply Object algorithm, the algorithm increments an "iteration count" on the migration object record. If the iteration count does not exceed a maximum count (noted in the algorithm), the object remains in the **Approved** state and is eligible to be picked up for processing again. If the iteration count exceeds the maximum defined in the algorithm, the record transitions to the **Error Applying** state.

NOTE: When submitting this Apply batch job, be sure to set the number of threads to a number that does not exceed the number of threads supported by the thread pool worker. Doing this will cause the 'excess' threads to wait for the supported number of threads to finish.

The following diagram is the portion of the migration object lifecycle that pertains to the Apply step.

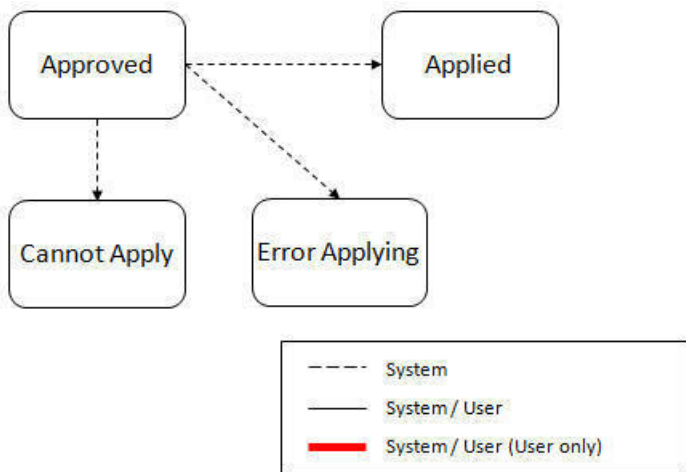

At the completion of the Apply monitor process, typically the objects will be in the **Applied** state or the **Error Applying** state. The records in the Error Applying state are in that state for one of two reasons.

- They are in category 5 described above where the records have a circular reference with another record. For this scenario, the Apply Transactions step described below should successfully apply the records.
- There is some other error that is unrelated to the records in the current migration. In this case, manual intervention may be required. Refer to the [Resolving Errors](#) section below for more information.

As shown in the diagram, the Apply Objects algorithm may also detect a reason that the object cannot be applied. This may occur if the object in the target environment has been updated since the comparison step, making the SQL captured at that point no longer applicable. If this occurs, after the current migration is fully applied, the original file may be imported again, and new comparisons can be generated and applied.

Apply Transactions

Ideally, after the Apply Objects step, all the objects are **Applied** or are in **Error Applying** due to the "circular reference" situation. The typical next step is to turn over responsibility to the transactions. The migration transactions can then attempt to apply their objects in bulk.

In order to ensure that multiple background processes are not trying to select migration objects to run the Apply step, the Transactions are only eligible to attempt to "apply my objects" if the Data Set is in the **Apply Transactions** state.

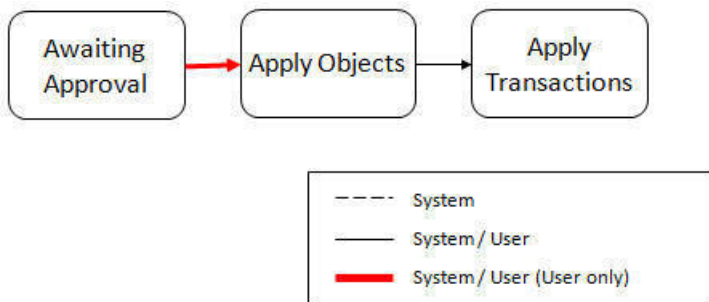

A monitor algorithm (executed by the data set monitor batch process) on the Apply Objects state checks to see if all migration objects are no longer **Approved** or the count of records in **Error Applying** does not exceed a configured limit. If so, it automatically transitions the record to the **Apply Transactions** state.

If the number of objects in **Error Applying** exceeds a configured limit, the monitor algorithm does not automatically transition the record. In that case, a user must determine if the large number of errors can be resolved or manually transition to **Apply Transactions** (despite the large number of errors). The [Resolving Errors](#) section below describes alternative steps that the user may take if there are errors.

Once the Data Set is in the state of **Apply Transactions**, the **Migration Transaction Monitor - Apply** process (F1-MGTAP) runs. It attempts to apply the transaction's objects. If no migration objects are in error, the migration transaction simply transitions to **Applied**. If any of the migration objects are in **Error Applying**, the background process and the Apply algorithm have special functionality to try to overcome dependencies in migrated objects:

- The Apply algorithm selects all migration objects in error and performs all their SQL, then validates all the records. If there are objects in the transaction with circular references, they should pass validation at this point.
- Because there may still be some dependencies across transactions, similar error handling described in the Apply Objects step occurs here. When an error is received in the Apply Transaction's Object algorithm for any of the objects in the transaction, the algorithm increments an "iteration count" on the migration transaction record. If the iteration count does not exceed a maximum count (noted in the algorithm), the transaction remains in the **Ready to Apply** state and is eligible to be picked up for processing again. If the iteration count exceeds the maximum, the record transitions to the **Error Applying** state. Note that if any objects in the transaction are in error, none of the objects are applied. They all remain in error.
- The **Migration Transaction Monitor - Apply** process is a special one that continually re-selects records in the **Ready to Apply** state until there are no more eligible records to process.

NOTE: When submitting this Apply batch job, be sure to set the number of threads to a number that does not exceed the number of threads supported by the thread pool worker. Doing this will cause the 'excess' threads to wait for the supported number of threads to finish, erasing the benefit of the iteration processing.

The following diagram is the portion of the migration transaction lifecycle that pertains to the Apply step illustrating the points above.

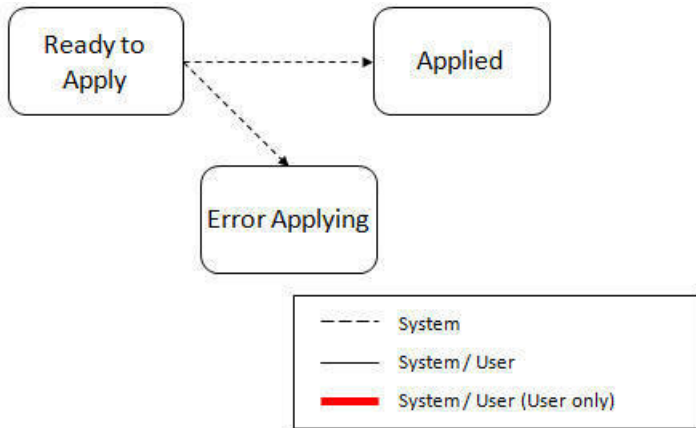

If at the end of the transaction level Apply process there are transactions in error (and therefore there are still objects in error), a user must review the errors and determine how to fix them. Refer to the [Resolving Errors](#) section below for more information.

Resolving Errors

As mentioned in the previous sections, errors may be received after the Apply Objects process runs. If the number of records in error is below a certain limit (and the data set monitor batch job is submitted to execute the monitor algorithms) the system will automatically transition the data set to the **Apply Transactions**. If the monitor batch job is not run or if the number of objects in error exceeds a certain limit, a user must make the decision after viewing the errors in the Objects in Error zone on the [Migration Data Set Import](#) portal.

- If the errors appear to be dependency related, the user can decide to let the "transactions apply their objects" and transition the data set to **Apply Transactions**, described above.
- If the errors appear to be related to an outside issue that can be manually resolved, the user may choose to fix the issue and redo the Apply Objects step.
- The user may also decide to reject one or more objects to remove them from the migration.

After the Apply Transactions step, if there are still errors, a user must review the records and determine how to proceed. Errors are visible in the **Transactions in Error** zone on the [Migration Data Set Import](#) portal.

- The user may decide to reject one or more objects to remove them from the migration.
- The user may manually resolve an issue external to the migration and then decide to do one of the following:
 - Redo the **Apply Objects** step. This is recommended if there are a large number of Objects still in error and not a large number of dependencies expected. The benefits of running the Apply Objects multi-threaded will ensure that the process runs efficiently.
 - Redo the **Apply Transactions** step.

Because the objects and transactions are in Error Applying, in order to "retry" the Apply step after manually fixing an error, the system needs to move the records back to the state that allows them to be picked up by the appropriate Apply process. For migration objects, records need to be moved back to **Approved**. For migration transactions, records need to be moved back to **Ready to Apply**. The following points describe the Retry logic for migration objects.

- If a user decides to **Retry Objects** (using an action button on the Migration Data Set Import page), the data set transitions to the **Retry Objects** state. At this point the Migration Object monitor must be run.
- The monitor on the **Error Applying** state for the objects detects that the data set is in the state of **Retry Objects** and that triggers the transition back to **Approved**.
- The next step is to transition the data set from **Retry Objects** to **Apply Objects**. This may be done manually or by running the Migration Data Set Import monitor process.
- Now the objects are eligible to be picked up by the object level Apply process.

Analogous logic exists for the migration transactions.

- If a user decides to **Retry Transactions** (using an action button on the Migration Data Set Import page), the data set transitions to the **Retry Transactions** state. At this point the Migration Transaction monitor must be run.
- The monitor on the **Error Applying** state for the transactions detects that the data set is in the state of **Retry Transactions** and that triggers the transition back to **Ready to Apply**.
- The next step is to transition the data set from **Retry Transactions** to **Apply Transactions**. This may be done manually or by running the Migration Data Set Import monitor process.
- Now the transactions are eligible to be picked up by the transaction level Apply process.

The retry logic may also occur when transitioning between the Apply Objects and Apply Transactions depending on whether or not there are errors. The following scenario highlights this point.

- After the **Apply Objects** step there are objects in **Error Applying**. The data set transitions to **Apply Transactions** and the Apply step is done at the transaction level.
- After the **Apply Transactions** step there are transactions in **Error Applying**.
- User chooses to try to apply objects again (by clicking **Retry Objects**). The steps outlined above for retrying objects are followed at this point.
- After the apply objects, user may choose to retry objects again (after fixing errors if applicable).
- At some point the user will transition to **Apply Transactions** again. If there are transactions in **Error Applying**, the system will automatically transition the data set to **Retry Transactions** and the steps outlined above for retry transactions are followed.

Finalize Apply Step

Once all the migration objects for a migration transaction are in a final state (**Applied**, **Rejected** or **Cannot Apply**), the migration transaction transitions to the **Applied** state. Once all the migration transactions are in the **Applied** state, the Migration Data Set record transitions to the **Completed** and the import is complete.

NOTE: To review the full lifecycle for each record, refer to the Business Object - Summary tab in the application metadata for the base business objects **Migration Data Set Import** (F1-MigrObjectImport), **Migration Transaction** (F1-MigrTransactionImport) and **Migration Object** (F1-MigrObjectImport).

Adjusting Data Prior to Comparing

There are reasons that the data you are importing requires some adjustment before applying it in the target environment. In such cases, an algorithm plugged into the [migration plan](#) primary instruction may be used to adjust the data when importing. This algorithm is executed by the comparison algorithm before any comparison is performed. Algorithms of this system event receive the view of the source record (being imported) and the view of the existing record in the target region, if it exists. The data is provided using the physical BO of the migration plan's maintenance object. The algorithm may make changes and pass a new view of the record that should be used for the comparison. This system event supports multiple algorithms that are executed in sequence. Each algorithm receives the original record's data, the target record's data (if applicable) and the 'new' view of the data (as populated by previous algorithms, if any). The final 'new' view of the data is used for the object comparison. The system includes the algorithms linked to the primary instruction of the migration

plan from the source environment. If the system finds any additional pre-compare algorithms linked to the migration plan's primary instruction in the target system, those algorithms are also executed.

FASTPATH: Refer to [Base Business Objects](#) for more information about physical BOs.

Some examples of records that may require import algorithms.

- Batch Control references its next batch sequence number along with snapshot information like the last run date / time. This information is only relevant with respect to its environment. The instruction for a batch control can include an algorithm to not overwrite the batch sequence number when copying a batch control.
- Some products include administrative objects that reference a master data object. Master data objects are not copied as part of CMA. An import algorithm may be used to adjust the referenced master data foreign key when importing, for example to reset it (or not overwrite when updating). If the algorithm knows how to find the appropriate master data record to link, that may also be included.
- If you are importing data that from a source environment on a lower version, if the object you are importing has been enhanced in the latest release with a new required field, you may need to provide an algorithm to populate data in that field.

Note that it is possible to use the algorithm to "reset" the source data as a way of indicating that the record should not be imported. For these situations, the migration object comparison step will transition the record to **Unchanged** and will use an object action value of **Canceled**. (Note that object action is a simple lookup value. The record is not transitioned to the **Canceled** BO state as to reserve that status for user initiated cancellations of the object or one of its parent records). This technique not expected to be used often because ideally using appropriate selection criteria at export time should ensure that the only records exported are those that should be imported.

NOTE: Legacy 'Import' system event. The system originally provided an Import system event / plug-in spot. The purpose of algorithms for this plug-in spot were similar in that they were meant to adjust imported data prior to adding or updating. The algorithms were executed in the Apply step. The logic does not allow for easily interacting with the record using a BO. This makes it difficult to use a plug-in script as the plug-in type. In addition, it is difficult to update elements in an XML column. The support for the plug-in spot will be removed in a future release. Algorithms to adjust the data should be using the pre-compare system event.

Import Process Summary

The following table summarizes the steps required to complete the import process from start to finish. Note that this section **only a summary** and assumes that you are familiar with the details described in the previous sections. It highlights what steps are manual and what steps are performed by a batch monitor process. For each step, the table highlights the Next Action sequence that would occur. For the Apply steps, there are two parts where multiple next actions are possible based on whether there are errors and the user's decision on how to resolve the error. Refer to [Resolving Errors](#) for more information. The possible next actions have the same sequence with a letter following the sequence highlighting the action to take based on the results of the previous step.

NOTE: When running the Apply batch jobs, be sure to set the number of threads to a number that does not exceed the number of threads supported by the thread pool worker.

Also note that a sequence and action marked in bold is considered the "normal path".

When using [separate batch processes for business data](#) any reference to a migration object monitor batch process applies also to the business data related batch controls.

Step	Seq	Action	Manual / Batch	Portal - Action	Batch Control	Record Impacted - Resulting Status	Next Action Sequence
Import	10	Create Import record	Manual	Migration Data Set Import - Add		Migration Data Set Import - Pending	11
	11	Import file	Batch		F1-MGDIM - Migration Data Set Import Monitor	Migration Data Set Import - Ready to Compare Migration Transaction - Pending Migration Object - Pending	20
Compare	20	Migration Object Compare	Batch		F1-MGOPR - Migration Object Monitor [When using separate business data processes submit also F1-MGOPB (Migration Object Monitor (Business))]	Migration Object - Approved, Needs Review, Rejected, Unchanged or Error Comparing	21
	21	Migration Transaction status update	Batch		F1-MGTPR - Migration Transaction Monitor	Migration Transaction - Ready to Apply, Unchanged or Error Comparing	22
	22	Migration Data Set Import status update	Batch		F1-MGDIM - Migration Data Set Import Monitor	Migration Data Set Import - Awaiting Approval, Apply Objects (if configured for Automatic Apply), Unchanged or Error	30
Approval	30	Review comparison results, approve / reject as needed (This step is skipped if the data set is configured for Automatic Apply)	Manual	Migration Data Set Import, drill in to the Transactions / Objects as necessary.		Migration Object - Approved or Rejected (no records should be in Needs Review) Migration Data Set Import - Apply Objects	40
Apply	40	Apply Objects	Batch		F1-MGOAP - Migration Object Monitor - Apply [When using separate business data processes submit also	Migration Object - Applied or Error Applying	41 Appropriate next action is based on error review, if applicable.

Step	Seq	Action	Manual / Batch	Portal - Action	Batch Control	Record Impacted - Resulting Status	Next Action Sequence
					F1-MGOAB (Migration Object Monitor (Business) - Apply)]		
	41a	Migration Data Set Import status update - auto transition to Apply Transactions. Only applicable if the number of migration objects in Error Applying is below a threshold	Batch		F1-MGDIM - Migration Data Set Import Monitor	Migration Data Set Import - Apply Transactions	42
	41b	Migration Data Set Import status update - manual transition to Apply Transactions. Occurs if user reviews errors and determines that they may be resolved in the Apply Transaction step.	Manual	Migration Data Set Import - click Apply Transactions			
		System detects that all the transactions are in the Ready to Apply state and proceeds to the Apply Transactions state.				Migration Data Set Import - Apply Transactions	42
		System detects that there are transactions in the Error Applying state and transitions instead to the Retry Transactions state.				Migration Data Set Import - Retry Transactions	45
	41c	Migration Data Set Import status update - manual transition to Retry Objects. Occurs if user reviews errors and decides to fix an external error and wants	Manual	Migration Data Set Import - click Retry Objects		Migration Data Set Import - Retry Objects	44

Step	Seq	Action	Manual / Batch	Portal - Action	Batch Control	Record Impacted - Resulting Status	Next Action Sequence
		to try the batch level Apply again at the object level.					
	42	Apply Transactions	Batch		F1-MGTAP - Migration Transaction Monitor - Apply	Migration Transaction - Applied or Error Applying Migration Object - Applied or Error Applying	43 Appropriate next action is based on error review, if applicable.
	43a	Migration Data Set Import status update - auto transition to Completed Applicable if all transactions are Applied	Batch		F1-MGDIM - Migration Data Set Import Monitor	Migration Data Set Import - Completed.	N/A
	43b	Migration Data Set Import status update - manual transition to Retry Objects. Occurs if user reviews errors and decides to fix an external error and wants to try the batch level Apply again at the Object level.	Manual	Migration Data Set Import - click Retry Objects		Migration Data Set Import - Retry Objects	44
	43c	Migration Data Set Import status update - manual transition to Retry Transactions. Occurs if user reviews errors and decides to fix an external error and wants to try the batch level Apply again at the Transaction level.	Manual	Migration Data Set Import - click Retry Transactions		Migration Data Set Import - Retry Transactions	45
	44	Migration Objects status update from Error Applying back to Approved. Occurs if user chose to Retry Objects.	Batch		F1-MGOPR - Migration Object Monitor [When using separate business data processes submit also F1-MGOPB (Migration	Migration Object - Approved	

Step	Seq	Action	Manual / Batch	Portal - Action	Batch Control	Record Impacted - Resulting Status	Next Action Sequence
					Object Monitor (Business))]		
		Migration Data Set Import status update from Retry Objects to Apply Objects	Batch		F1-MGDIM - Migration Data Set Import Monitor	Migration Data Set Import - Apply Objects	40
	45	Migration Transactions status update from Error Applying back to Ready to Apply. Occurs if user chose to Retry Transactions or if the user transitions to Apply Transactions and the system detects that there are Transactions in the Error Applying state.	Batch		F1-MGTPR - Migration Transaction Monitor	Migration Transaction - Ready to Apply	42
		Migration Data Set Import status update from Retry Objects to Apply Objects	Batch		F1-MGDIM - Migration Data Set Import Monitor	Migration Data Set Import - Apply Transactions	42

The following table summarizes the batch monitor jobs that are used in the import process. You can see that there are special monitor processes for the Apply step for both the Object and Transaction. However, for all other states that have monitor logic, the standard monitor process for that MO is used.

Batch Control	Description	Comments
F1-MGDIM	Migration Data Set Import Monitor	Processes data set records in the following states: <ul style="list-style-type: none"> • Pending • Ready to Compare • Apply Objects • Retry Objects • Apply Transactions • Retry Transactions
F1-MGTPR	Migration Transaction Monitor (Deferred)	Processes transaction records in the following states: <ul style="list-style-type: none"> • Pending • Error Applying
F1-MGTAP	Migration Transaction Monitor - Apply	Processes transaction records in the Ready to Apply state where the data set is in the Apply Transactions or Canceled state. <p>NOTE: Be sure to set the number of threads to a number that does not exceed the</p>

Batch Control	Description	Comments
		number of threads supported by the thread pool worker.
F1-MGOPR	Migration Object Monitor	Processes object records in the following states: <ul style="list-style-type: none"> • Pending • Needs Review (check for Data Set cancellation) • Error Applying
F1-MGOPB	Migration Object Monitor (Business) Applicable only when separate business data processing is enabled.	Similar to F1-MGOPR (Migration Object Monitor) but restricted to business data migration objects.
F1-MGOAP	Migration Object Monitor - Apply	Processes object records in the Approved state where the data set is in the Apply Objects or Canceled state. NOTE: Be sure to set the number of threads to a number that does not exceed the number of threads supported by the thread pool worker.
F1-MGOAB	Migration Object Monitor (Business) - Apply Applicable only when separate business data processing is enabled.	Similar to F1-MGOAP (Migration Object Monitor - Apply) but restricted to business data migration objects.

Refer to [Running Batch Jobs](#) for more information about managing the batch jobs, including ways to automate the above steps.

Canceling a Data Set

A user may choose to **Cancel** a data set to prevent it from being processed at any point during the process.

If related migration transactions or migration objects have already been created, they will not be canceled as part of the data set getting canceled (due to possible high volumes of related records). They will be canceled the next time an appropriate monitor batch process runs. The child records checks to see if the data set has been canceled prior to any state transition.

Additional Note Regarding Imports

The following points describe miscellaneous comments related to Migration Import.

- CMA relies on the fact that database referential integrity constraints are not in place, and that the SQL statements can be run in any order within the transaction. Any archiving solution that requires referential integrity constraints (such as Information Lifecycle Management) would not be possible on this data. Given that CMA migrations comprise administrative data and not transactional data, this should be a reasonable exception.
- The validation that is performed is only via the **Page Validate** service. BO validation algorithms are not executed. Page validation does not include validation of the business object against the schema (for example, for required fields, field sizes, etc.).
- If multiple migration requests are exported at the same time, on the import side, you should consider importing, reviewing, and applying an entire file/data set before moving on to the next one. The reason is that if objects are included in more than one file, two sets of "inserts" will be generated, but only the first will succeed. The second will cause the object to transition to "Cannot Apply". If instead you wait until the first file is completed before importing the second, the second data set will not generate any SQL for the object, since it has already been inserted. It's a matter of efficiency: If you first import all files and then try to apply all, you'll have to identify the duplicated object as an error and then mark the object as rejected before applying the transaction. This may also be avoided by using a Group migration request to include all objects in one file rather than multiple files.

- The system provides an algorithm to purge "unchanged" migration objects for a given migration data set. This may be plugged in as a BO exit algorithm on the **Ready to Compare** state for the Migration Data Set Import business object (**F1-MigrDataSetImport**).

The following points describe miscellaneous comments related to importing a business data set in [bulk mode](#).

- The number of entities included in each migration object is captured on the migration object record.
- The comparison step only generates SQLs for new or changed entities. SQLs are not generated for unchanged entities.
- Searching for migration objects based on their included entities is only supported for entities that were determined as new or changed. In other words, this type of search by included entities is only possible after the comparison step is performed.

Caching Considerations

There are two important caching considerations when using CMA to migrate administrative data.

- The "apply" batch processes update data. As described in [Batch Cache](#), if any batch job is updating data marked as "cached for batch" it must be run in a special thread pool. Contact your system administrator and ask for the name of a thread pool that has turned off caching. This thread pool name must be entered in the batch controls used for CMA processing in the **Thread Pool Name** parameter.
- After a successful migration, the target region now has new administrative data which needs to be part of various caches. It is recommended to flush the server cache (which will trigger a 'global' flush of the cache). If the thread pool workers in the target region are configured to refresh their caches when a global flush is requested, then this is the only step required. If not, then the **F1-FLUSH** batch job should also be submitted to refresh the caches used in batch processing.

FASTPATH: Refer to [Caching Overview](#) for more information.

FASTPATH: Refer to [Running Batch Jobs](#) for more information about running CMA batch jobs.

Maintaining Import Data

This section describes the portals provided to add, view and maintain migration import data.

Migration Data Set Import

Use the Migration Data Set Import portal to view and maintain migration data set import records. Refer to [Importing and Applying a Migration](#) for an overview of the import process.

Navigate using **Admin > Implementation Tools > Migration Data Set Import**. You are brought to a query portal with options for searching for import data sets. In addition, the query provides an option to specifically search for data sets that have either objects in error or transactions in error. Once a data set has been selected, you are brought to the maintenance portal to view and maintain the selected record.

The following zones are visible on the **Main** tab:

- **Migration Data Set Import.** This zone contains display-only information about the selected record. Please see the zone's help text for information about this zone's fields.
- **Entity Summary.** This zone provides a summary count of all migration objects included in the current data set across the various statuses.

The following zones are visible on the **Transactions** tab:

- **Migration Data Set Transactions in Error.** This zone is only visible if there are transactions for this data set in a non-final state that have errors. It indicates the error for each transaction. A user may use this zone to review errors

after the monitor batch job to apply transactions completes. The errors received when attempting to apply objects at the transaction level may differ from those received when attempting to apply objects at the object level. A transaction log is created for each object error received and these exceptions are shown in this zone.

NOTE: Refer to [Apply Step](#) for more information about resolving errors.

- **Migration Data Set Transactions.** This zone is visible once the [Import Step](#) has occurred and lists all the transactions that are related to the data set. To see more information about a specific migration transaction, click the hypertext for its ID. This brings you to the [Migration Transaction](#) portal.

The following zones are visible on the **Objects** tab:

- **Migration Data Set Objects in Error.** This zone is only visible if there are objects for this data set in a non-final status that have errors. It indicates the error for each object. A user may use this zone to review errors after the monitor batch job to apply objects completes. Using the error information shown, the user can choose to drill into the record to transition it to **Error Applying** or choose to manually fix the cause of the errors and click **Retry Objects**. The user may also choose to select one or more records to **Reject**.

NOTE: Refer to [Apply Step](#) for more information about resolving errors.

- **Migration Data Set Impacted Object Summary.** This zone is visible once the [Import Step](#) has occurred and lists the objects that are related to the data set. To see more information about a specific migration object, click the hypertext for its ID. This brings you to the [Migration Object](#) portal. A user may choose to update the status of one or more records by checking the records and clicking **Approve**, **Reject** or **Needs Review** accordingly.

Migration Transaction Portal

This page appears after drilling into a specific migration transaction from the migration data set portal or from the migration object portal.

Refer to [Importing and Applying a Migration](#) for an overview of the import process.

The following zones are visible on the main tab:

- **Migration Transaction.** This zone contains display-only information about the selected record. Please see the zone's help text for information about this zone's fields.
- **Migration Transaction Objects.** This zone lists the objects that are related to the data set. To see more information about a specific migration object, click the hypertext for its ID. This brings you to the [Migration Object](#) portal. A user may choose to update the status of one or more records by checking the records and clicking **Approve**, **Reject** or **Needs Review** accordingly.
- **Entity Summary.** This zone provides a summary count of all migration objects included in the current transaction across the various statuses.

Migration Object Portal

This page appears after drilling into a specific migration object from the migration data set portal or from the migration transaction portal.

Refer to [Importing and Applying a Migration](#) for an overview of the import process.

The **Migration Object** zone contains display-only information about the selected record. Please see the zone's help text for information about this zone's fields.

The **Migration Object - List of SQL Statements** zone lists the SQL statements that have been generated as a result of the comparison step. A check mark in the Suppressed checkbox indicates that the SQL for that row will not be applied during the apply step.

The **Migration Object - Algorithms** zone displays any pre-compare algorithms that are associated with the migration plan for this migration object.

Running Batch Jobs

There are several batch jobs that are part of the CMA process, especially the import step (which are highlighted in [Import Process Summary](#)). And in some cases, a single batch jobs may process multiple states in the same business object lifecycle. Implementations must decide the best way to manage the batch job submission depending on how they plan to work.

- **Batch scheduler.** If an implementation wishes to put these batch jobs in the batch scheduler, a given job may need to be included several times to manage progressing the records to completion.
- **Timed Batches.** The batch controls can be configured as timed batches so that they run every N minutes based on the setting. This allows for the batch jobs to run periodically and process whatever is ready. A user doesn't have to manually submit a batch request. Navigate to the [Batch Control](#) page and select the appropriate batch controls. For each one, change the Batch Control Type to **Timed**. Fill in the additional information that appears for timed batches.
- **Event Driven.** The system provides BO enter plug-in algorithms and batch control post processing plug-in algorithms that automatically submit the appropriate next batch job for that step in the process. This allows for as much automation as possible for the steps that don't require user input. Note that configuration is required because the BOs / batch controls are not configured for this scenario by default. The following table highlights the BO and status where an algorithm may be plugged in and the name of the algorithm to use.

Business Object	Status	Algorithm
Migration Data Set Export	Pending	F1-MGDPR-SJ (Submit Migration Data Set Export Monitor).
Migration Data Set Import	Pending	F1-MGDIM-SJ (Submit Migration Data Set Import Monitor).
	Ready To Compare, Retry Objects	F1-MGOPR-SJ (Submit Migration Object Monitor). When using separate batch processes for business data add also this algorithm: F1-MGOPRB-SJ (Submit Migration Object Monitor (Business)).
	Apply Objects	F1-MGOAP-SJ (Submit Migration Object Apply Monitor). When using separate batch processes for business data add also this algorithm: F1-MGOAPB-SJ (Submit Migration Object Monitor (Business)).
	Apply Transactions	F1-MGTAP-SJ (Submit Migration Transaction Apply Monitor).
	Retry Transactions	F1-MGTPR-SJ (Submit Migration Transaction Monitor).

The following table highlights the batch controls where an algorithm may be plugged in and the name of the algorithm to use.

Batch Control	Algorithm
F1-MGTPR (Migration Transaction Monitor)	F1-MGDIM-NJ (Submit Migration Data Set Import Monitor).
F1-MGTAP (Migration Transaction Monitor - Apply)	F1-MGDIM-NJ (Submit Migration Data Set Import Monitor).
F1-MGOAP (Migration Object Monitor - Apply) When using separate batch processes for business data update also this batch control:	F1-MGDIM-NJ (Submit Migration Data Set Import Monitor).
F1-MGOAB (Migration Object Monitor (Business) - Apply)	
F1-MGOPR (Migration Object Monitor) When using separate batch processes for business data update also this batch control:	F1-MGTPR-NJ (Submit Migration Transaction Monitor).

- **Manual submission.** The user managing the CMA import process submits the appropriate batch jobs on demand when a particular step is ready. Navigate to [Batch Job Submission](#), select the appropriate batch control and fill in the parameters as needed.

Note that for the CMA batch processes used to migrate administrative data, there are multiple important caching considerations. Refer to [Caching Considerations](#) for more information.

CAUTION: Be sure that the Thread Count set when submitting the batch job does not exceed the number supported by the thread pool. Otherwise the extra threads will wait until the supported number of threads are finished, possibly resulting in a large number of errors in the Apply steps.

Refer to the parameter descriptions in the batch control metadata for more information about filling in the parameters.

For additional details on submission controls, refer to the topic [Batch Job Submission - Main](#) in the Batch Jobs section.

CMA Reference

This section provides additional reference information.

Framework-Provided Migration Configuration

This topic describes special information relating to migration objects provided for use by CMA in the product. Additional objects may be provided by your specific product. Any special information for objects is provided separately in each product's documentation.

The following points highlight some information about Framework-provided migration requests. Navigate to the migration request page in the application to view the details of all provided objects.

- Several base migration requests are supplied to logically group system and administrative tables. For example, there is a migration request for Framework System Configuration **F1-SystemConfig** where most system configuration objects are included. There is another one provided for CMA related configuration objects.
- The system supplies a group migration request **F1-FrameworkConfig** (Framework Configuration), which includes several other migration requests. The expectation is that this migration request includes all the typical objects that are included in a wholesale migration. Your specific product may include this migration request into its own group migration request to support a wholesale migration of all the framework and product administrative tables. An implementation may choose to build a custom group migration request. In this case, review the various migration requests provided by base to see if any may be included as components for the custom migration request. Then any new migration plans added to the base migration request in future releases are automatically included in future migrations.
- There are several different security related migration requests that include different combinations of migration plans to support multiple possible business requirements related to security migration. Note that the security migration request included in the above mentioned group migration request is the one that does not include users. If your implementation wants to copy users to a target environment, refer to [Importing Data that References a User](#) for some considerations.

NOTE: Refer to your specific product's CMA documentation for its recommendation on which migration requests to use for a full migration of framework and product administrative tables.

The following points highlight some information about the Framework-provided migration plans. Navigate to the migration plan page in the application to view the details of all provided objects.

- Fields and characteristic types are not migrated with an object (like a business object or a data area) unless specifically indicated.

- The **Application Service** used by an object is migrated only if it is CM-owned.
- The **Batch Control** object optionally references a User (for 'timed' batches). Refer to [Importing Data that References a User](#) for some considerations about copying the user. Also note that when running a batch job, snapshot information is captured on the batch control. Updates like this increment the version number. If a batch control record is part of the migration and the comparison step has detected a change to the batch control, the Apply step will error out for this batch control if a batch job is submitted between the compare and apply step.

NOTE: CMA batch controls that are part of the import step are executing and as such, the system does not include these records in a migration. If your implementation changes default parameters for any of the batch controls, the recommendation is to manually make those changes to the target region.

- The base migration plans for MO and BO include instructions to copy option types that use foreign key references to refer to other objects. Note that the data stored in the options are not validated, so defining these instructions is not required when doing wholesale migrations. However, including subordinate instructions for foreign key references is useful for targeted migrations to ensure that the related data is included in the migration. If you add additional MO or BO option types that use foreign keys and you want to support targeted migrations, you must create custom migration plans and requests for MO and BO, respectively to include these referenced objects in the migration plan. Note that you do not need to duplicate the instructions in the base migration plans. You may define the additional migration plans to only have the additional custom option types. When submitting a migration request for MO or BO you must include both the base migration plans and the custom migration plans in the request.
- For scripts, schema-based objects and zones, the migration plans provided by the product migrate, through constraints, some of the typical associated data with them. However, data specified through alternate formats (such as through **Edit Data** steps in scripts, referenced in schemas for schema-based objects, or data from mnemonics in zone parameters, etc.) are not identified and combined in the same transaction. The iterative processing functionality of the import step should resolve any timing issues that may result in validation errors for these types of objects.
- There are two migration plans for **Scripts**. The migration plan **F1-ScriptOnly** migrates just the script and its **Application Service** (provided the Application Service is CM-owned). The migration plan **F1-Script** includes most related objects, but does not migrate any objects referenced in the edit data area steps. It does not move the **Function** maintenance object. It may be included in any appropriate custom targeted migration request where scripts and related data should be migrated.
- If your implementation includes a **Feature Configuration** setting for the **F1_DBCONINFO** entry that will be included in a migration request, be sure that the import user on the target region has the appropriate security rights to this entry (**Administrator** access mode for the Feature Configuration application service (**CILTWSDP**)).
- The common attachments in the Attachment maintenance object may be considered administrative data to include in a migration. Because this MO has a system generated key, as described in [Administrative Data with System Generated Primary Keys](#), it uses a logical key of the file name and the creation date to determine if the record exists in the target environment. In addition, this MO contains administrative data (common attachments) and non-administrative data (owned attachments). To try to minimize the possibility of key "collision", new common attachments receive a generated key that includes a zero in the middle whereas owned attachments receive a generated key that does not have a zero in the middle.
- The Menu maintenance object has a user defined key, however, its menu lines and menu items have system generated keys. To avoid the possibility of overriding a menu line or menu item incorrectly, the menu MO will check the menu line's menu name in the source and target to be sure they match and will check the menu item's menu line in the source and target to be sure they match otherwise an error will be issued in the comparison step.
- For the system messages, the product provides three different migration plans.
 - Message Category and its Messages (F1-MessageCategory). This migration plan is included in the **F1-SystemConfig** migration request.
 - Message Category (F1-MessageCategoryOnly). This migration plan is provided to support a targeted migration where an implementation has created a custom message category and wants to move it but doesn't want to move all its messages.

- Message (F1-Message). This migration plan is provided to support a targeted migration where only specific messages within a message category should be migrated.
- For lookup values, the product provides two different migration plans.
 - Lookup Field and its Values (F1-Lookup). This migration plan is included in the **F1-SystemConfig** migration request.
 - Lookup Value (F1-LookupValue). This migration plan is provided to support a targeted migration where only specific lookup values within a lookup field should be migrated.
- There are some system data objects where no information in a base delivered record may be modified by an implementation. For these records, the base delivered migration requests include selection criteria to only select CM-owned records (because the base records will always exist in the target region assuming both regions have the same release). An example is Algorithm Type. The **F1-SystemConfig** migration request only includes CM-owned algorithm types. However, many system data objects support custom changes to one or more fields, for example the Zone object allows an implementation to override the zone text or certain parameters. Other system data objects support custom additions to a collection. For example, the Maintenance Object allows an implementation to add algorithms or options. For the migration plans related to these system data objects, all records are included in the base delivered migration requests to allow for any customized configuration to be migrated. It means that during the Import / Compare step many base delivered objects that are not customized will be marked **Unchanged**.
- Many of the integration related maintenance objects that include references to environment-specific data, such as Message Senders. This data should be migrated with extreme care. When appropriate, consider taking advantage of URI substitution. Refer to [Referencing URIs](#) for more information.

Facts

Fact is an optional configuration tool for simple workflow-type business messages or tasks. The base package does not provide a dedicated Fact user interface because fact is generic by design. Implementations configure their own user interface to visualize the desired custom business process. The topics in this section describe the generic Fact entity and how it can be customized.

Fact Is A Generic Entity

The Fact maintenance object is a generic entity that can be configured to represent custom entities and support automated workflows for a variety of applications. Each fact references a business object to describe the type of entity it is. A status column on the fact may be used to capture its current state in the processing lifecycle controlled by its business object.

The maintenance object also supports a standard characteristic collection as well as a CLOB element to capture additional information.

Fact's Business Object Controls Everything

A fact's business object controls its contents, lifecycle and various other business rules:

- Its schema defines where each piece of information resides on the physical Fact maintenance object.
- It may define a lifecycle for all fact instances of this type to follow. Each fact must exist in a valid state as per its business object's lifecycle definition.
- It may define validation and other business rules to control the behavior of facts of this type.

FASTPATH: For more information about business objects, refer to [The Big Picture of Business Objects](#).

Fact Supports A Log

The Fact maintenance object supports a log. Any significant event related to a Fact may be recorded on its log. The system automatically records a log record when the fact is created and when it transitions into a new state. In addition, any custom process or manual user activity can add log entries.

FASTPATH:

Refer to [State Transitions Are Audited](#) for more information on logging.

Conversion

This section describes the overall conversion process and the tools provided to support it.

Understanding The Conversion Process

When you're ready to convert data from your legacy system, you will have analyzed your processing requirements according to your business and organizational needs and set up the control tables accordingly. After the control tables are set up, you are ready to load data into the system from your legacy system.

There are two table owners in the system database. We refer to the first owner as **staging** and the second owner as **production**. The staging owner is linked to the tables into which you insert your pre-validated data. The production owner is linked to the tables used by your production system.

NOTE: It's important to notice that **control tables exist only in production**. In staging, they exist as views to the production schema. Refer to [Multiple Owners In A Single Database](#) for more information about table ownership.

The conversion effort involves several steps as illustrated in the following diagram:

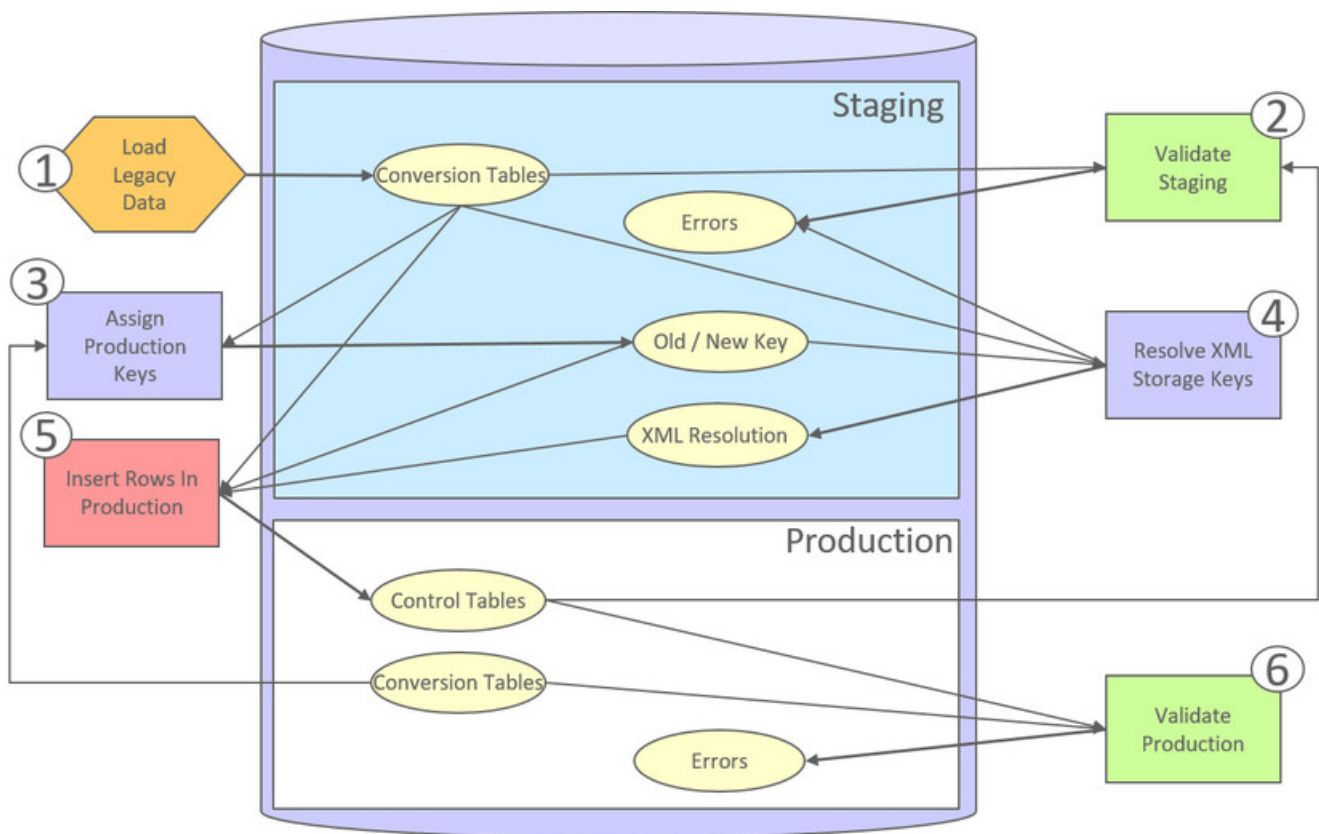

The following points briefly outline each of the above tasks:

- **Load Legacy Data.** During this step, your legacy data is loaded into the system. Notice that you are not migrating this data directly into production. Rather, your rows are loaded into tables that are identical to the production tables; they just have a different owner. Mapping legacy data into the system is probably the most challenging part of the conversion process because the system is a normalized database (and most legacy applications are not).
- **Validate Staging.** During this step, the system validates the data you loaded into the staging tables. Note that validation rules validate your staging data using the control tables that have been set up in production.
- **Assign Production Keys.** During this step, the system allocates random, clustered keys to the rows in the staging database.
- **XML Resolution.** During this step, the system resolves legacy keys that may be mapped to an XML storage field with new values that were assigned in the key assignment step.
- **Insert Rows Into Production.** During this step, the system populates your production tables with rows from the staging. When the rows are inserted, their prime keys and foreign keys are reassigned using the data populated in the key assignment and XML resolution steps.
- **Validate Production.** During this step, you rerun the object validation processes, but this time against production. We recommend performing this step to confirm that the insertion programs have executed successfully.

NOTE: Additional steps may be needed to support specific data conversion requirements. Refer to your product's documentation for additional conversion related information.

This section further discusses concepts and guidelines related to the conversion process.

Conversion Entities

Conversion is enabled for selected master and transaction maintenance objects. In the same way, only a subset of a maintenance object's tables are enabled for conversion.

The following is provided for each maintenance object that supports conversion:

- An [entity validation](#) batch control. This batch process validates data in staging and can also be run to validate data in production.
- A [key assignment](#) batch control for each **table** that is eligible for conversion and has a system-generated key.
- An [XML resolution](#) batch control if the maintenance object has at least one table that includes an XML storage field.
- An [insertion to production](#) batch control for every **table** of the maintenance object that is eligible for conversion.

You may review the conversion configuration provided for an entity and more using the [Conversion Entity Dashboard](#) portal.

Conversion Steps

The following sections provide more details about the steps in the conversion process.

NOTE: Additional steps may be needed to support specific data conversion requirements. Refer to your product's documentation for additional conversion related information.

Load Legacy Data Into Staging Tables

This section provides some high level discussion about mapping and loading legacy data to the system's staging tables.

Mass Load Utility

Unless in a Cloud installation, you can use any method you prefer to load data from your legacy application. However, we recommend that you investigate your database's mass load utility (as opposed to using insert statements) as the mechanism to load the staging tables. In addition, we strongly recommend that you disable the indexes on these tables before populating these tables and then enable the indexes after populating these tables.

NOTE: In a Cloud installation, refer to the "Data Conversion Support for Cloud Implementations" for more information about the various tools provided to support database related conversion tasks.

Populating Keys

Some tables in the staging database have keys that are system-assigned random numbers. Special consideration should be given when populating these keys. Refer to [A Note About Keys](#) for more information on how to properly populate these tables. Those tables that don't have system-assigned random numbers have keys that are a concatenation of the parent's prime-key plus one or more additional fields.

Populating Characteristic Tables

There are many maintenance objects that include a characteristic table used to capture miscellaneous information about the object. Most of these tables include an indexed column used when searching by characteristic value called Search Characteristic Value. During conversion and depending on the type of characteristic, this column must be populated as follows:

- **Predefined.** Populate search characteristic value with the contents of the characteristic value column converted to upper case.

- **Ad hoc.** Populate search characteristic value with the first 50 bytes of the ad hoc characteristic value column converted to upper case.
- **Foreign key.** Populate search characteristic value by concatenating the values of each foreign key characteristic value column to a maximum of 50 bytes.

Validate Information In The Staging Tables

During the first validation step, the system validates the data you loaded into the staging tables. This section provides some high level discussion about the validation process.

A Batch Process Per Maintenance Object

Each of the maintenance objects that are eligible for conversion must be validated using its respective entity validation conversion batch process. These are classic background processes that can also be run against production data.

These processes are multi-threaded and have no dependency on other processes.

Validation Mode

By default, each entity is fully validated for schema as well as entity validation rules, at the maintenance object and business object level. The batch process performs the same business rules that are used to validate data added by users in your production system. You may restrict the batch process to perform schema validation only or entity validation rules only using a batch parameter. This may be useful in identifying common data issues in preliminary runs.

Random Sample Mode

By default all records are selected for validation. The "Process Every Nth" batch parameter allows you execute this process in a random-sample mode to highlight pervasive errors. In this mode, you are actually telling the batch process to validate every N records.

We strongly recommend validating each entity in the following steps:

- Execute the validation batch process in random-sample mode.
- Review and correct the errors. Note, you can use the base package's transactions to correct an error if the error isn't so egregious that it prevents the object from being displayed on the browser.
- After all pervasive errors have been corrected; re-execute each object's validation batch process in all-instances mode to highlight elusive, one-off errors.

Reported Errors

Errors encountered during validation are logged onto the conversion Validation Error (CI_VAL_ERR) table. Note that at the start of this job, all rows in the conversion error table for the process maintenance object are deleted.

You can view errors highlighted by the validation process using the [Conversion Entity Dashboard](#) portal.

Recommendations To Speed Up Validation

The following points describe ways to accelerate the execution of the validation process:

- Ensure that statistics are recalculated after data has been inserted into the staging tables.
- Execute the process multi threaded.
- Execute shorter running validation processes (e.g., less records) first so that the error data can be analyzed while other processes are busy running.
- Remember that validation can be run in random-sample mode. We recommend running these batch processes using a large sample value for this parameter until the pervasive problems have been rectified.

NOTE: In a Cloud installation, refer to the “Data Conversion Support for Cloud Implementations” for more information about the various tools provided to support database related conversion tasks.

Another use for these programs

In addition to validating your objects after conversion or an upgrade, the validation programs have another use. Say for example, you want to experiment with changing the validation of a business entity and you want to determine the impact of this new validation on your existing records. You could change the validation and then run that entity’s validation batch process- it will produce errors for each record that fails the new validation.

Allocate Production Keys

During the key assignment step, the system assigns a new key for each legacy key for a table that its prime-key requires a system-generated random key. The conversion process allocates new prime keys to take advantage of the system's parallel processing and data-clustering techniques in the production system (these techniques are dependent on randomly assigned, clustered keys).

The topics in this section provides some high level discussion about the key assignment process and describe the background processes used to assign production keys to the staging data.

The Old Key / New Key Table

It's important to understand that the system does not overwrite the prime-keys on the rows in the staging database, as this is a very expensive IO transaction. Rather, a series of tables exist that hold each row's old key and the new key that will be assigned to it when the row is [transferred into the production database](#). We refer to these tables as the "old key / new key" tables.

The convention "<1st letter of owner flag>K_<table_name>" is used to denote the old key / new key table name. For example, the old key / new key table for CI_ACCT is called CK_ACCT.

The insertion batch process that transfers the rows into the production database use the new key for the main record of the key along with any other record where this key is a foreign key. In the same way, the XML resolution process resolves conversion foreign keys residing in XML storage fields and replaces them with their corresponding new keys from these table.

A Batch Process Per Table

A key assignment batch process is provided for each table that has a system-generated key and belongs to a maintenance objects that is eligible for conversion. The batch process is responsible for populating the corresponding old key / new key table (i.e., you don't have to populate these tables). These processes are single threaded. Refer to a table’s corresponding key assignment batch process for more information.

Key Assignment Dependencies

Most tables with system-generated keys do not inherit part of their key from another table’s key. Their corresponding key assignment batch process have no dependencies and can therefore be executed in any order you please.

Some tables inherit part of their key from another table’s key. Key assignment batch processes for such tables must be executed in key inheritance order. In other words, the key assignment process for a table should be run after the process that generates keys for the entity it depend on. The [Conversion Entity Dashboard](#) portal displays key inheritance dependency information if any exist for a conversion entity.

NOTE:

You may run multiple key assignment batch process in parallel as long as they are independent with respect to key inheritance.

Iterative Conversions

Rather than perform a "big bang" conversion (one where all records of an entity are populated at once), some implementations have the opportunity to go live on subsets of their entity base. If this describes your implementation, please be aware that the system takes into account the existing prime keys in the production database before it allocates a new key value. This means when you convert the next subset of customers, you can be assured of getting clean and unique keys.

Key assignment logic creates the initial values of keys by a manipulation of the sequential row number, starting from 1. After any conversion run, a subsequent conversion run will start with that row number again at 1, and the possibility of duplicate keys being assigned will be higher. The key assignment batch process allows you to specify a starting value for that row number. The purpose of this parameter is to increase the value of row number by the given value, and minimize the chance of duplicate key assignment. This parameter is only used if you are performing conversions where data already exists in the tables in the production database.

Run Type

Key assignment is performed in two steps:

- **Initial Key Generation.** The system allocates new keys to the rows in the staging tables (i.e., it populates the respective old key / new key table).
- **Duplicate Key Resolution.** The system reassigns keys that are duplicates compared to production.

By default, both steps are performed at the same run but you have the option to run them separately by indicating which step to run via a batch parameter. The proper use of this parameter will greatly speed up the key assignment step as described under **Recommendations To Speed Up Key Generation** section.

Recommendations To Speed Up Key Generation

The following points describe ways to accelerate the execution of the key generation programs.

- For a non-Cloud installation:
 - Make the size of your rollback segments large. The exact size is dependent on the number of rows involved in your conversion. Our research has shown that processing 7 million rows generates roughly 3GB of rollback information.
 - Setup the rollback segment(s) to about 10GB with auto extend to a maximum size of 20GB to determine the high water mark
 - A next extent value on the order of 100M should be used.
 - Make sure to turn off all small rollback segments (otherwise Oracle will use them rather than the large rollback segments described above).
 - After the key assignment programs execute, you can reclaim the space by:
 - Keep a low value for the "minimum extent" parameter for the rollback.
 - Shrink the rollback segments and the underlying data files at the end of the large batch jobs.
- Compute statistics on the old key / new key tables after every 50% increase in table size. Key generation is performed in tiers or steps because of the inheritance dependency between some tables and their keys. Although key generation for the inheritance dependency tier currently being processed is performed by means of set-based SQL, computation of statistics between tiers will allow the database to compute the optimum access path to the keys being inherited from the previous tier's generation run.
- Optimal use of the **Run Type** batch parameter.
 - Before any key assignments, alter both the "old key" F1_CX_ID index and the "new key" CI_ID index on the old key / new key tables to be unusable.
 - Run all key assignment batch processes in tiers, submitting each job to only perform the **Initial Key Generation** step.

- Rebuild the indexes on the old key / new key tables. Rebuilding the indexes using both the PARALLEL and NOLOGGING parameters will speed the index creation process. Statistics should be computed for these indexes.
- Run all key assignment batch processes in the current tier that were previously run in initial key generation mode, to perform the **Duplicate Key Resolution** step. This will reassign all duplicate keys.

NOTE: In a Cloud installation, refer to the “Data Conversion Support for Cloud Implementations” for more information about the various tools provided to support database related conversion tasks.

XML Resolution

Most system-generated foreign keys are stored in physical fields and characteristic tables and as such their legacy value is replaced with its corresponding new key as part of the insertion to production process. Rarely, maintenance objects may store system-generated foreign keys in an XML storage field, i.e. a field defined with the data type of CLOB or XML. This step is only applicable to such maintenance objects.

During this step, the system resolves convertible system-generated foreign keys that may reside in XML storage fields you may have loaded into the staging tables. This section provides some high level discussion about the XML resolution process.

The XML Resolution Table

It's important to understand that the system does not overwrite the prime-keys on the XML storage fields in the staging database, as this is a very expensive IO transaction. Rather, a corresponding XML resolution table exists for each table that defines an XML resolution field to capture each row's resolved XML storage content, i.e. the content with all the old keys replaced with the new assigned keys.

The convention "<1st letter of owner flag>R_<table_name>" is used to denote the XML resolution table name.

The [insertion](#) batch process that transfers the rows into the production database replaces each XML storage field with its resolved value from the corresponding XML resolution table.

A Batch Process Per Maintenance Object

Each of the maintenance objects that are eligible for conversion and support XML storage fields is provided with an XML resolution batch process. These batch processes must be run to resolves foreign keys that may reside in these XML storage fields.

These processes are multi-threaded and must be executed after the key assignment step has completed and before inserting data to production.

XML Resolution Eligibility

Not all maintenance objects that support XML storage fields actually store convertible system-generated foreign keys in their XML storage field. If none of the business objects associated with the maintenance object involve mapping of such foreign keys to an XML storage field then XML resolution is not needed for any row in the maintenance object. The XML resolution batch process detects such situation and completes right away without storing any rows in any of the maintenance object's XML resolution tables.

NOTE: If the XML resolution batch process detects that the maintenance object is eligible, the maintenance object must reference a physical BO. If a product delivered business object supports system-generated foreign keys in an XML storage field, the product should be supplying a physical BO. If your implementation has system-generated foreign keys in an XML storage field in a custom business object for a maintenance object where the product has not supplied a physical BO, you must [create a physical BO](#) and link it to the maintenance object.

Only Resolved Values Are Captured

XML storage fields typically store large amounts of data. To avoid capturing the same XML content redundantly, the system only stores values in the resolved XML storage fields if the resolved value is different than the original value, i.e. at least one key was resolved.

If for a given record the resolved XML content is the same as the original content then the following rules apply:

- If this is the primary table of the maintenance object a record is inserted into its corresponding XML resolution table for that record with no value in the XML storage field.
- If this is a child table of the maintenance object then no record is inserted into the corresponding XML resolution for that record.

Reported Errors

Errors encountered during XML resolution are logged onto the conversion Validation Error (CI_VAL_ERR) table. Note that at the start of this job, all rows in the conversion error table for the process maintenance object are deleted.

You can view errors highlighted by the XML resolution process using the “Validation Error Summary” page.

Insert Production Data

The topics in this section describe the background processes used to populate the production database with the information in the staging database.

A Batch Process Per Table

An insert to production batch process is provided for each table of a maintenance objects that is eligible for conversion.

The batch process is responsible for transferring to production all the rows from the staging table while replacing all references to old keys with their corresponding new keys as follows:

- Keys residing in prime keys, foreign key fields and characteristics are resolved using the corresponding [old key / new key](#) tables.
- Keys residing in generic foreign key reference tables where each row represents a reference to an entity’s maintenance object and prime key values are also resolved using the corresponding [old key / new key](#) tables. Note that all entities referenced this way must either be convertible or view of production. A reference to an entity that is explicitly marked as not convertible is not supported as it cannot be resolved.
- Keys residing in XML storage fields are resolved using the corresponding [XML resolution](#) tables.

NOTE: Foreign keys residing in any other form of storage are not resolved. For example, any references stored in raw elements, log records, or any other field that is not used as an XML storage field.

All insertion batch processes are independent and may run concurrently. Also note, all insertion batch processes can be run in many parallel threads as described in the next section (in order to speed execution).

Recommendations To Speed Up Insertion

The following points describe ways to accelerate the execution of the insertion batch processes:

- Before running the first insertion batch process:
 - Rebuild the index on the prime key on the old key / new key table.
 - Re-analyze the statistics on the old key / new key table.
 - Alter all indexes on the production tables being inserted into to be unusable.

- After the insertion programs have populated production data, rebuild the indexes and compute statistics for these tables.

NOTE: In a Cloud installation, refer to the “Data Conversion Support for Cloud Implementations” for more information about the various tools provided to support database related conversion tasks.

Validate Production

During this step, you rerun the [object validation batch processes](#), but this time in production. We recommend rerunning these batch processes to confirm that the insertion batch processes have executed successfully. We recommend running these batches in random sample mode (e.g., validate every 1000th object) rather than conducting a full validation in order to save time. However, if you have time, you should run these processes in full validation mode (to validate every object).

A Note About Keys

The prime keys of the tables in the staging database are either system-assigned random numbers or they aren't. Those tables that don't have system-assigned random numbers have keys that are a concatenation of the parent's prime-key plus one or more additional fields. Every table whose prime key is a system-assigned random number has a related table that manages its keys; we refer to these secondary tables as "key tables".

The following points provide more information about the key tables:

- Key tables are used by programs that allocate new keys. For example, before a new key is allocated, the key assignment program checks the corresponding key table to see if it exists.
- Key tables only have two columns:
 - The key of the object.
 - An environment ID. The environment ID identifies the database in which the object resides.
- Key tables are named the same as their primary table with a suffix of "_K". For example: The key table for CI_ACCT is CI_ACCT_K.
- The key table for a table whose prime key is a system-assigned is defined on its table definition record.
- When you populate rows in tables with system-assigned keys, you must also populate a row in the related key table. For example, if you insert a row into CI_ACCT, you must also insert a row into CI_ACCT_K. The environment ID of these rows must be the same as the environment ID on this database's [installation record](#).
- When you populate rows in tables that reference this record as a foreign key, you must use the appropriate key to ensure the proper data relationships. For example, if you insert a row in CI_SA for the above account, the ACCT_ID column must contain the temporary account key.
- When you insert rows into your staging database, the keys do not have to be random, system-assigned numbers. They just have to be unique. A later process, [Allocate Production Keys](#), will allocate random, system-assigned keys prior to production being populated.

Multiple Owners In A Single Database

The conversion process relies on the following table owner configuration in the system database:

- The production owner is linked to the tables used by your production system. These tables have an owner ID of CISADM.
- The staging owner is linked to the tables into which you insert your pre-validated data. These tables have an owner ID of CISSTG.

The staging owner schema is almost identical to the production schema, with the following exceptions:

- Control tables are not actual tables in staging but rather views to the corresponding tables in production.

- Conversion specific tables designed solely to support the conversion process exist only in the staging schema. For example, tables that manage key assignment and XML resolution.

This section provides some high level concepts related to these table owners.

Validation Always Uses Production Control Data

When the validation batch processes run against your staging data, they validate the staging data against the production control tables (and insert errors into the staging error table). This means that the SQL statements that access / update entities needs to use the staging owner whereas the SQL statements that access control tables need to use the production owner. But notice that when these same validation batch processes run against production, the SQL statements will never access the staging owner. Rather, they all point at the production owner.

This is accomplished as follows:

- A separate application server must exist for each owner. Each application server points at a specific database user ID.

NOTE: In a Cloud installation, the application server may only point to a specific database user ID at any point in time. Refer to the “Data Conversion Support for Cloud Implementations” for more information about switching owners.

- The database user ID associated with the staging owner uses CISSTG as the owner for the master and transaction tables, but it uses CISADM as the owner of the production control tables.
- The database user ID associated with the production owner uses CISADM as the owner for all tables.

You may wonder why we went to this trouble. There are several reasons:

- We wanted to reuse the validation logic that exists in the programs that validate your production data. In order to achieve this, these programs must sometimes point at the staging owner, and other times they must point at the production owner (and this must be transparent to the programs otherwise two sets of SQL would be necessary).
- We wanted to let you use the application to look at and correct staging data. This can be accomplished by creating an application server that points at your staging database with the ownership characteristics described above.
- We wanted the validation programs to be able to validate your production data (in addition to your staging data). Why would you want to validate production data if only clean data can be added to production? Consider the following scenarios:
 - After an upgrade, you might want to validate your production data to ensure your pre-existing user-exit logic still works.
 - You may want to conduct an experiment of the ramifications of changing your validation logic. To do this, you could make a temporary change to user exit logic (in production) and then run the validation jobs on a random sample basis.
 - You forget to run a validation program before populating production and you want to see the damage. If you follow the instructions in this document, this should never happen. However, accidents happen. And if they do, at least there's a way to determine the ramifications.

Only Validation Can Work In Both Owners

While the redirection of owner ID's is a useful technique for the validation batch processes, it cannot be used by the key assignment and production insert batch processes? Why, because these processes have to access the same tables but with different owners at the same time. They also need to reference conversion specific tables that do not exist in production. For example, the batch process that inserts rows into a table in production must select rows from the staging version of that table, resolve keys from the conversion old key / new key mapping tables and insert the resolved records into the production version of that same table

This is accomplished as follows:

- In staging, a view to production exists for each eligible to conversion table. These views have hard-coded the database owner to point to production. For example, there is a view called CX_PER that points at person table in production.

- The key assignment and insertion programs use these views whenever then need to access production data.

Conversion Entity Dashboard

This portal provides an overview of a maintenance object's conversion configuration along with information related to its current status and progress within the overall conversion process.

Refer to [Understanding Conversion](#) for more information.

You can access the portal from the **Admin Menu > Implementation Tools > Conversion Entity Query**. You are brought to a query portal with options for searching for a specific maintenance object that is eligible for conversion. Once a maintenance object has been selected you are brought to the conversion entity dashboard portal to review the information for the selected record.

The following zones may appear as part of the portal's **Main** tab page.

- **Tables.** This zone provides information about tables that belong to the maintenance object and are marked as eligible for conversion.
- **Batch Controls.** This zone lists the conversion batch controls defined for the maintenance object in the order they should be executed within the conversion process along with current execution details if any.
- **Error Summary.** This zone provides a summary of all conversion errors related to the maintenance object.
- **Duplicate Keys.** This zone lists duplicate legacy keys that need to be resolved by the key assignment conversion process.

The **Errors** tab page provides a query zone that allows you to review conversion errors related to the maintenance object by various criteria.

Data Export

This section describes concepts and tools related to the various types of data export methods supported by the product.

Understanding Data Export

The application supports the following classes of export methods for a maintenance object:

- **Generalized.** This method may be used for maintenance objects that are low to medium in volume and update activity. Most maintenance objects are eligible for this method.
- **Specialized.** This method should be used for maintenance objects that are high in volume or very frequently updated.

This section discusses concepts and guidelines related to data export features.

Generalized Data Export

The generalized data export method provides a file-based export of data in JSON format. Exporting the data of a maintenance object using this method involves an initial export of the entity's entire data followed by an ongoing export of changes as they are made over time. These processes are illustrated in the following diagram:

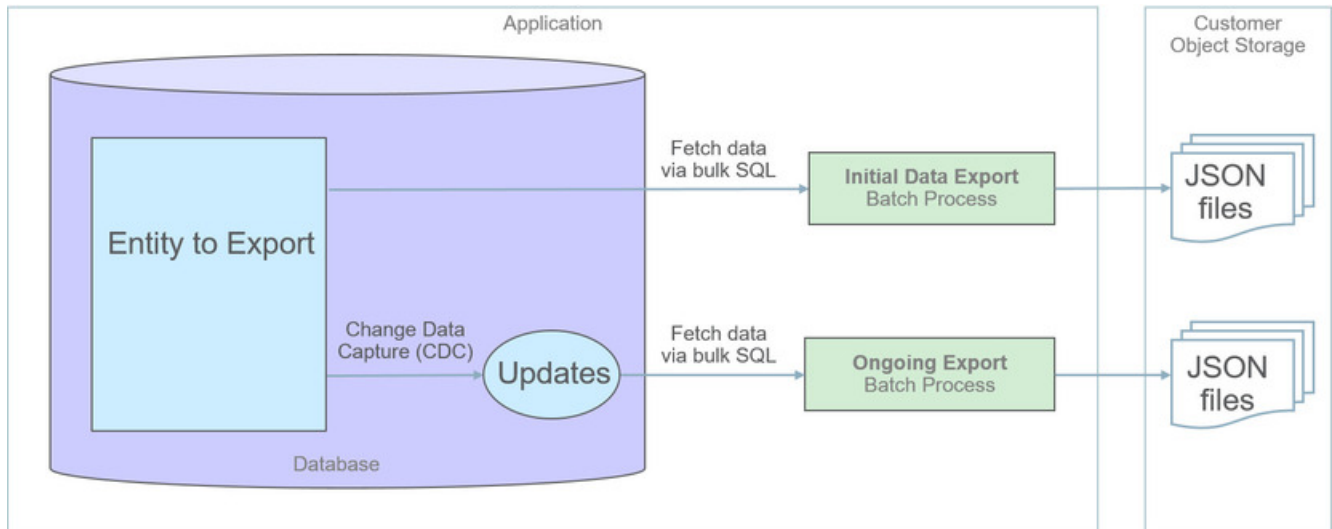

The overall process involves the following steps:

- Enable entities for export in the [Generalized Export Dashboard](#) portal. You may enable many entities at once. This step also allows you to enable ongoing export of these entities.
- Submit the Generalized Initial Export Initiator (**F1-GEXPI**) batch process to export the current content of all enabled entities. This step submits a separate batch process for each entity you have enabled for export.
- Schedule the Generalized Ongoing Export (**F1-GEEXO**) batch process to run periodically.

The following sections further discuss concepts and guidelines related to the generalized data export method.

Eligibility

While most entities are eligible for generalized data export, not all of them are. Here are a few of the common reasons for that:

- The entity manages extremely high volume of data. Tracking changes to such entity would double the volume of managed data and impact overall performance.
- The entity is updated very frequently. Tracking these events may impact overall performance.
- The entity is used by the product's infrastructure and operational processes. These entities are maintained differently and cannot be subject to the generalized data export methods.

By default a maintenance object is eligible for the generalized data export method unless explicitly marked otherwise by the **Data Export Class** option. The option may be used to mark an entity as either not allowed for any type of export or allowed for a [specialized](#) export only. The lack of such explicit option means the maintenance object is eligible for the generalized export.

CAUTION: If an entity is explicitly marked as not eligible for generalized data export there is a good reason for that and its configuration should not be changed.

One Method Fits All

The generalized data export method is designed to accommodate many eligible maintenance objects in a generic way that must also take performance considerations into account. For this reason this method does not support entity specific filtering options nor custom rules of any kind.

The following rules apply to all entities that may be exported using this method:

- Entire data is exported.

- All fields on all tables that belong to the maintenance object are exported except for “key” and “log” tables if any.
- Maintenance object log tables typically do not contain useful business information and as such are omitted from export for performance and data volume reasons. However, there are entities for which log records provide analytical value. When applicable, use the **Export Log Tables** option to explicitly include log tables for a specific maintenance object.
- Same data structure and format is used for all entities. Refer to the **Record Format** section for more information.
- Data is exported to files only. Refer to the **Export To Files Only** section for more information.
- All changes are captured. It is not possible to exclude some changes from being tracked for ongoing export based on custom business rules.
- When data changes, a full snapshot of the data related to that entity is exported to avoid heavy data merging on the target side.
- When the entity is deleted, only the primary key of the entity is exported along with an indication that it is deleted.

NOTE: Export is not supported for entities that rely on the logical time zone functionality. This type of definition is not commonly used and includes maintenance objects that at least one of their fields is defined as stored in **Logical Standard Time**.

Export To Files Only

The immediate destination of both initial and ongoing export processes are files in a customer specified location. In a Cloud installation files are created in a customer owned Object Storage.

Based on your business requirements you may further consume these files by downstream applications such as data lakes etc.

Enabling Data Export

To enable data export for an eligible maintenance object a **Data Export Control** record needs to be created. The record keeps an indication of whether the initial export for the maintenance object has been completed or not and whether changes made to the entity should be tracked and exported on an ongoing basis. A designated portal allows you to enable the generalized data export for many maintenance objects at once as well as monitor their current export status at a glance. Refer to [Generalized Export Dashboard](#) portal for more information.

CAUTION: Enabling and disabling entities for export should only be made via the Generalized Export Dashboard or the Data Export Control portals to ensure the configuration is valid and complete.

CAUTION: When applicable, ongoing data export should be enabled before submitting the initial export batch process for the entity. This ensures that changes made during the initial export are properly tracked.

Ongoing export options are cached in various online and batch caches. In order for these options to take effect and track entity changes made by any online or batch process, the various caches must be properly flushed when these options are changed. Using the designated portals to enable entities for export triggers a 'global' flush of the caches. If the batch thread pool workers are configured to refresh their caches when a global flush is requested, then this is the only step required. If not, then the **F1-FLUSH** batch job should also be submitted to refresh the caches used in batch processing. Refer to [Caching Overview](#) for more information.

Initial Data Export

Each maintenance object that is eligible for the generalized data export method is associated with an initial data export batch control that is referenced on the maintenance object using the **Export Batch Control** option. The same common batch program is used by all these batch controls to export the entire data of an entity to files. The process is multi-threaded and

produces one file per thread by default. An optional batch parameter allows for multiple smaller files to be generated per thread by setting a limit on the number of records written to each file. Refer to the **File Size** section for more information.

Instead of manually submitting the generalized initial export batch process for each maintenance object you have enabled for export, submit the **F1-GEXPI** Generalized Initial Export Initiator batch process to automatically submit them all at once.

The initial export process for each maintenance object updates the corresponding data export control record for the maintenance object to indicate that the process has started and updates it again upon completion. This allows you to view the overall status of the initial export across all enabled entities on the [Generalized Export Dashboard](#) portal.

Note that the initiator batch process only submits batch processes for enabled maintenance objects that according to their data export control record their initial export has not started yet. If you need to export one or more entities again, reset the initial export status indication on their data export control records and submit the initiator batch process again.

The initial export file name is constructed as follows:

```
INIT_EXPORT[_file prefix(optional)]_[maintenance object]_[batch run]_[thread]_[thread count]_[timestamp]
[_file sequence].json.gz
```

The "file sequence" part of the file name is used only when more than one file is created per thread. The sequence suffix is populated starting from the second file as follows `_2`.

Refer to any of the individual generalized initial export batch controls and the initiator batch control for more information.

Restricting Initial Export By Date

By default, the Initial Data Export batch process exports the entire data for an entity. In some situations, typically around high volume historical data, there may be a need to restrict the export to more recent data, for example the last few months of data.

The initial export batch process supports an optional batch parameter **Restrict By Date** that can be used to limit the scope of data to export. The parameter references a date field and a requested time frame in terms of number of days prior to business date. Refer to the **F1-GEIXP** Generalized Initial Export Template batch control for more information.

CAUTION: Excluding records from export should be carefully considered as this may result in data discrepancies when the excluded data is referenced on other exported entities.

NOTE: The option is only applicable to specific entities that have a qualifying reference date and the time frame for export may vary for each customer. Therefore, the new parameter is not added to any base product Initial Export batch control aside of the template batch control for documentation purposes. You may clone the base product batch control for a specific entity and add the parameter as per your business needs.

Ongoing Data Export

Data changes are tracked by the Capture Change for Ongoing Export (**F1-MO-REGCHN**) Maintenance Object Audit algorithm. The algorithm records the prime key of a changed entity in a designated **Data Export Update** table that serves as a queue of changed entities to export. The queue is later on consumed by the ongoing data export batch process.

NOTE: The Maintenance Object Audit plug-in spot is capable of tracking changes made to the entity by any layer of the application. Making changes using direct SQL would bypass this mechanism and therefore should be avoided.

The audit rule is added to a maintenance object when the ongoing data export option on its corresponding data export control record is enabled. In the same way the audit rule is removed from the maintenance object when the ongoing export option is disabled.

NOTE: The ongoing export option has to be enabled on the data export control record for the entity before it is initially exported. This ensures changes made while the initial export process is in progress are not missed.

Unlike the initial export batch process that requires a batch control to be defined for each eligible maintenance object, a single batch process is used to export ongoing changes made to all entities.

The following describes the ongoing export batch process at a high level:

- All changes queued in the Data Export Update table are exported to a designated ongoing export file. Refer to the **Managing a Large Backlog** section for more information.
- A full snapshot of the data related to the changed entity is exported to avoid heavy data merging on the target side.
- Once exported, records are deleted from the Data Export Update table.

The process is multi-threaded and a separate file is produced for each thread by default. An optional batch parameter allows for multiple smaller files to be generated per thread by setting a limit on the number of records written to each file. Refer to the **File Size** section for more information.

NOTE: It is important to schedule the ongoing export batch process to run frequently enough to avoid accumulating a high volume of records in the Data Export Update table. The smaller the table is kept the faster it is for the change data capture mechanism to add records to it.

The ongoing export file name is constructed as follows:

```
INC_EXPORT_[batch run]_[thread]_[thread count]_[timestamp]_[file sequence].json.gz
```

The "file sequence" part of the file name is used only when more than one file is created per thread. The sequence suffix is populated starting from the second file as follows _2.

Refer to Generalized Ongoing Export (**F1-GEEEXO**) batch control for more information.

File Size

The initial export batch process produces a single file per thread by default. For some high volume entities this may result in files that are too large to manage. To produce multiple and smaller files for a specific entity, limit the number of records written to each file by setting the corresponding parameter on the initial export batch control defined for the entity. The same parameter may be provided when submitting the Initial Export Initiator batch process, in which case the initiator value is used only when a corresponding value has not been defined on the entity's specific batch control record.

In the same way, the ongoing export batch process produces a single file per thread by default. To produce multiple and smaller files, limit the number of records written to each file by setting the corresponding parameter on the batch control.

To avoid the creation of too many files by a single batch run, the system sets a maximum limit of around 500 files per run. When the requested number of records per file is determined to cause the number of generated files to exceed the system limit, the actual value used is adjusted to meet the system limit.

Managing a Large Backlog

When a large backlog of changes accumulates in the ongoing export queue for some reason, the next batch takes longer to export which delays the downstream import step. A better option is for the backlog to be cleared in smaller "chunks", allowing the downstream process to import them as they are made available.

You may limit the number of records the batch process exports using the **Thread Processing Limit** batch parameter. When specified, the number of records exported by each thread is capped by the specified limit, leaving the remaining records to be consumed by subsequent batch runs. Instead of waiting for the next scheduled batch run, a new batch process may be automatically submitted, if explicitly requested to do so using the **Automatic Backlog Clearance** batch parameter.

It is important to ensure that the backlog clears gradually and that the queue resumes its normal size in a timely manner. The processing limit must therefore be set with an appropriate value that would promote proper clearance of the queue. To do so, at least 20% of the queue, and no less than 100,000 records, must be consumed by each batch run across all threads. If the specified limit does not meet the minimum clearance requirement then the processing limit is adjusted accordingly.

Record Format

Data is fetched and exported directly from the database in bulk read operations for performance reasons. For that reason, the structure used does not reflect the logical data model of the entity but rather its physical list of tables. Data for a given instance is organized by tables followed by rows in each table and for each row its list of fields in JSON format.

The following describes the format and structure used:

```
{
  "OBJ": "<mo name>",
  "TIMESTAMP": "<export time in ISO format for example 2019-07-25T11:06:04.740615Z>",
  "PK1": "<mo pk1 value>",
  "PK2": "<mo pk2 value if any>", # PK2-5 should only be included when applicable
  "PK3": "<mo pk3 value if any>",
  "PK4": "<mo pk4 value if any>",
  "PK5": "<mo pk5 value if any>",
  "DELETED": true, # should only be included when the entity is deleted
  "DATA":
  {
    "<MO table name 1>":
    [
      {<name value pairs of all fields in row 1 in that table>},
      {<name value pairs of all fields in row 2 in that table>},...
      {<name value pairs of all fields in row n in that table>},...
    ],
    "<MO table name 2>":
    [
      {<name value pairs of all fields in row 1 in that table>},
      {<name value pairs of all fields in row 2 in that table>},...
      {<name value pairs of all fields in row n in that table>}
    ],...
    "<MO table name n>":
    [
      {<name value pairs of all fields in row 1 in that table>},
      {<name value pairs of all fields in row 2 in that table>},...
      {<name value pairs of all fields in row n in that table>}
    ]
  }
}
```

Notes about field values and formats:

- All fields for a row are included even when the field is empty or null.
- All string values are trimmed of excess trailing spaces but if a field is empty it exported as an empty string "" and not null.
- An empty array is used for a table node when no records exists for the entity in the table.
- Date/time information is converted to UTC time zone and exported in ISO format for example 2019-07-25T11:06:04.740615Z.
- Deletes have an explicit indicator in the header.

Order of Consuming Files

It is important to apply all the initial export files for a maintenance object before applying ongoing change files to ensure data consistency.

The following is a recommended procedure for consuming generalized data export files:

- Apply all initial data export files before ongoing export files.
- Apply initial files for a maintenance object in run number order.
- Apply ongoing export files in run number order.
- If a new initial export is available the file consumption procedure should be changed temporarily as follows:
 - Stop consumption of ongoing export files.

- Apply the new initial export files.
- Resume consumption of ongoing export files.

Recover from a Lost Ongoing Export File

The ongoing export batch process keeps a backup of all entity keys, that were exported on a specific batch run, in a designated backup table. In rare situations where an ongoing export file is deleted or becomes corrupted before it gets processed, the backup table may be used to identify the missing changes and export them again.

Use the Restore Generalized Export Keys (**F1-GERST**) batch process to recover from this situation. The process identifies the entities that were exported during a specified batch run and adds them back to the ongoing changes queue from the backup table. The entities would then be exported again when the next ongoing export runs. This method does not restore the exact content of the original file that was lost as it cannot be reproduced. Instead, the process ensures that the entities that were included in the lost file would be exported again.

NOTE: Backup records follow a weekly retention policy for performance reasons. They are meant to support near future situations of file recovery and are not an historical change data capture log.

Specialized Data Export

Several performance considerations are called for when exporting the data of a high volume entity or an entity that is updated in extremely high frequency. The generalized method does not fit such entities and a specific batch process is designed for each, aiming to achieve an optimal export method for the entity. The initial run of the process exports the entity's existing data while subsequent runs of the same process exports data incrementally, i.e. it exports records that were added or updated since the previous run based a timestamp field. The overall process is illustrated in the following diagram:

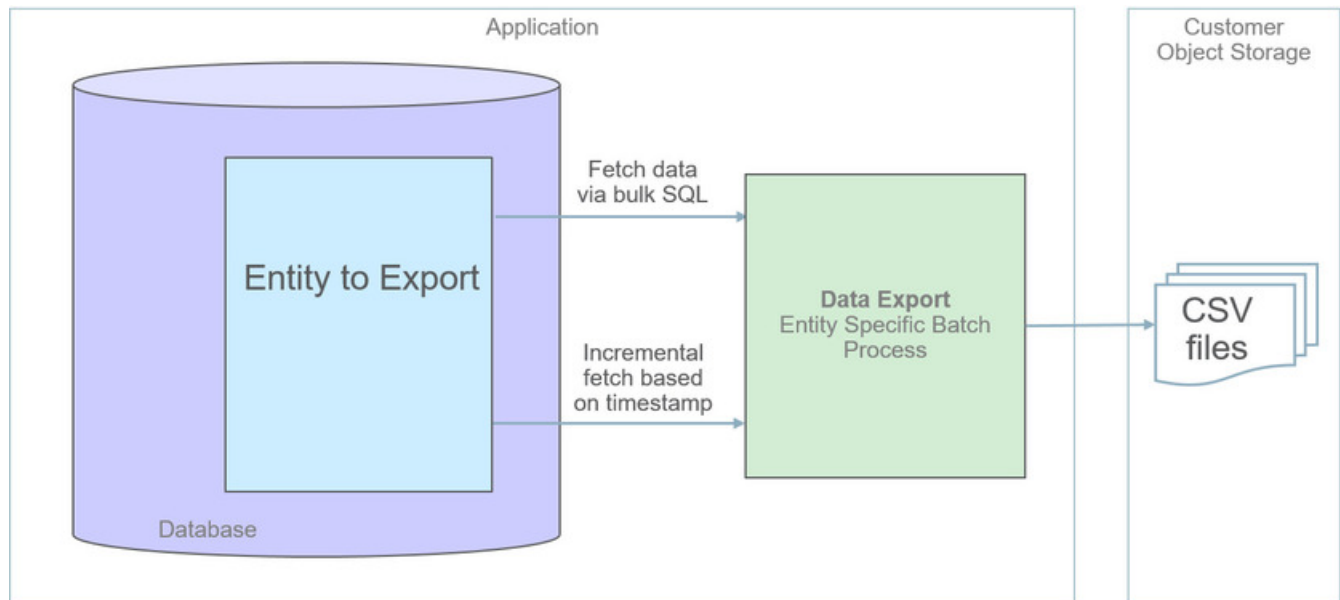

The following sections further discuss concepts and guidelines related to the specialized data export method.

A Specific Process For Each Entity

A maintenance object that is designed to be exported using the specialized method is explicitly marked as such by the **Data Export Class** option and its specific batch process is defined using the **Export Batch Control** option.

All specialized batch processes are designed to export the data in a CSV format as it produces smaller files in size compared to more verbose formats. Refer to each batch process for more information about specific export considerations and parameters.

Enabling Data Export

To enable data export for a maintenance object a specialized type of [Data Export Control](#) record needs to be created. The record serves as an indication that such entity should be exported and keeps track of the date and time through which data has been exported so far, allowing subsequent export run to only export incremental changes.

Incremental Data Export

The specialized export method tracks changes incrementally from prior export run and does not use a change data capture mechanism. It therefore relies on a timestamp field on the primary table of the maintenance object to indicate when data was added or changed. Only entities that were added or changed since the previous export run are exported with each subsequent run. The date and time through which data has been exported is recorded for each maintenance object on its corresponding Data Export Control record.

Order of Consuming Files

Specialized data export files should be consumed in run number order to ensure a consistent and chronological uptake of data.

Defining Data Export Control

This portal is used to maintain Data Export Control records. These records capture your organization's export settings and current export state for a selected maintenance object. For a generalized export it keeps an indication as to whether the initial export for the maintenance object has been completed or not and whether changes made to the maintenance should be tracked and exported on an ongoing basis. For a specialized data export it keeps the date/time through which data was exported.

Refer to [Understanding Data Export](#) for more information.

You can access the portal from the **Admin Menu > Implementation Tools > Data Export Control**. You are brought to a query portal with options for searching for a specific record. Once a data export control record has been selected you are brought to the maintenance portal to view and maintain the selected record.

The **Data Export Control** zone provides information about the selected record.

Generalized Export Dashboard

The number of maintenance objects that are eligible for generalized export is large. This portal allows you to easily select and enable export for many eligible entities at once as well as review the current export state of those already enabled at a glance.

Refer to [Generalized Data Export](#) for more information about the generalized data export method.

You can access the portal from the **Admin Menu > Implementation Tools > Generalized Export Dashboard**.

The following zones may appear as part of the portal's **Main** tab page.

- **Export Entities.** This zone lists entities for which generalized data export control settings have already been set.
- **Eligible Entities.** This zone lists entities that are eligible for the generalized data export method and for which such settings have not yet been set.

Customer to Meter Administrative User Guide

Customer to Meter Overview

Customer to Meter Overview

Oracle Utilities Customer to Meter is a next generation customer service and billing application that incorporates a modern meter data management system. This system is designed to scale with mass smart meter volumes while handling the complexity associated with a utility's processes across multiple types of service, operating divisions, and jurisdictions. The new application components allow for traditional scalar meter functionality that is equivalent to prior versions of Oracle Utilities Customer Care and Billing; so, it can accommodate the many types of utility environments, and evolve with the business to include more advanced digital requirements.

The roles for each application area in Oracle Utilities Customer to Meter are defined as follows:

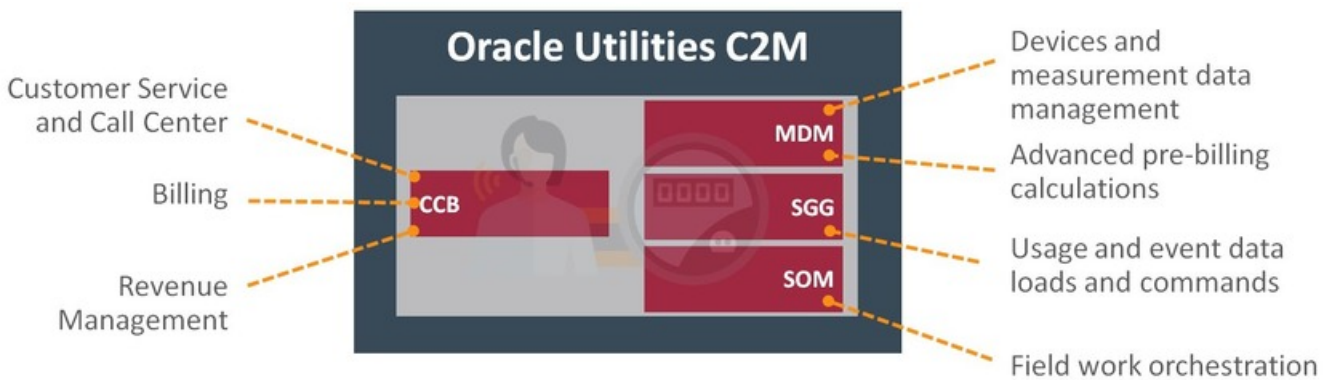

The application components have internal integration for master, admin, and transactional data. The primary transactions between them are for bill determinant processing with MDM and service order processing with SOM. These transactional processes can be initiated by the CCB solution, or from other external systems.

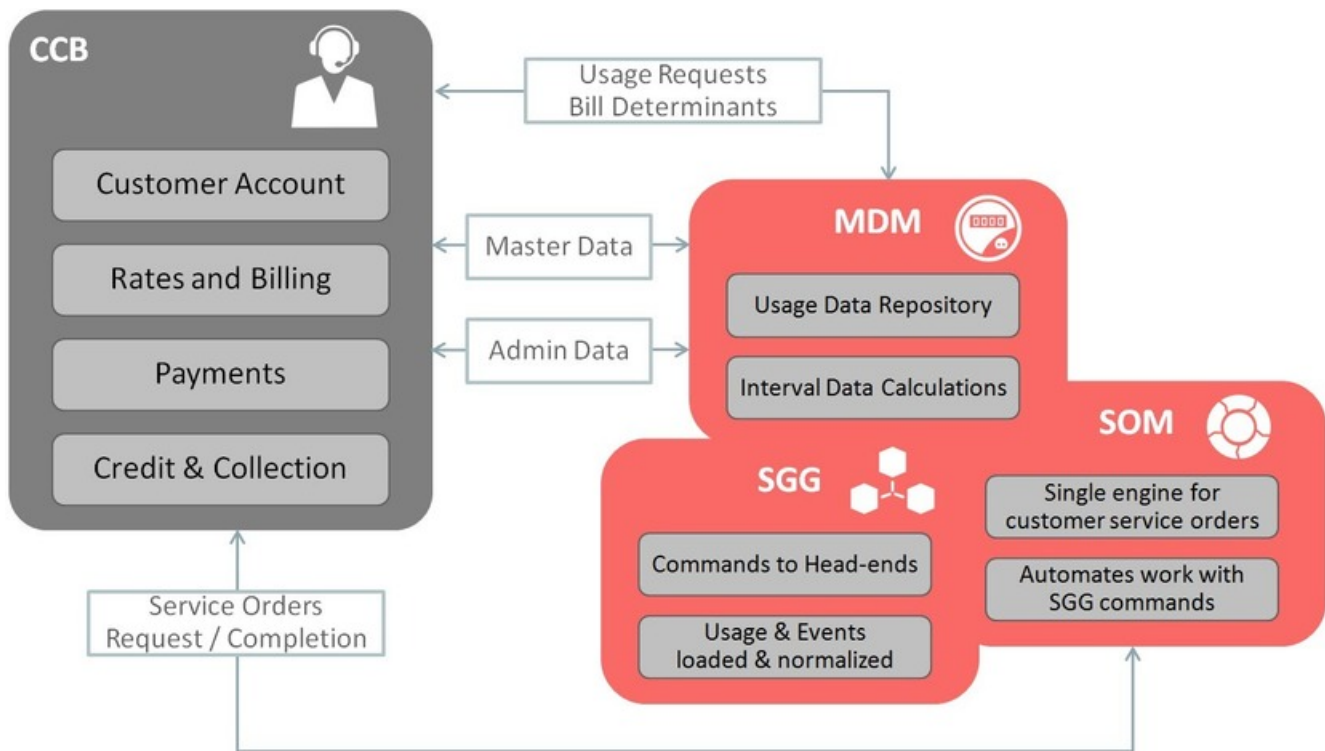

In addition, Oracle Utilities Customer To Meter can also include asset management functionality via Oracle Utilities Operational Device Management which provides the ability to handle large volumes of assets and to manage the receipt, installation, maintenance, tracking and removal of those assets.

Best Practices

Performance Recommendations

Partitioning and Data Removal

- Implement Partitioning:** Partitioning is essential to manage the large amounts of data coming into Meter Data Management. Customers will have significant performance problems without partitioning. Partitioning is required for good performance and to organize the data so old data can easily be dropped from the database. Customers need historic partitions (for conversion and replacement reads) and future partitions.
 - Cloud Implementations: Customers should run 'Add Partition' jobs, **F1-ILMAD** and F1-ILMSV (for sub-partitions, if needed) on a regular basis to ensure that new partitions are created regularly.
 - On-Premise Implementations: Please refer to the *Oracle Utilities Meter Data Management Database Administration Guide* for partitioning guidelines for on-premises implementations.
- Implement Compression:** Compression is essential to reduce the size of the database. For standard hardware we recommend Advanced Compression. For engineered systems that use Oracle Exadata, we highly recommend HCC (Hybrid Columnar Compression) this reduces the overall database by approximately 50%.
 - Cloud Implementations: Customers should use the “ILM Automation – Non-Measurement Compression” (F1-ILMNC) batch process to will change the compression level from Advanced to Hybrid Columnar for non-Measurement data at least two months old, which can result in significant disk space savings. Use the following

parameters when running this batch process: Owner, MO (optional), DOP (Degree of Parallelism), Estimated Time Limit (How long job can run until it will not compress another partition). In larger databases this can run for several days a month.

- On-Premise Implementations: Please refer to the *Oracle Utilities Meter Data Management Database Administration Guide* for compression guidelines for on-premises implementations.
- **Setup Information Lifecycle Management (ILM):** – The Information Lifecycle Management processes mark items eligible to be removed and update partitions to segregate the data that can be removed. Customers need to define the “ILM Configuration” default retention periods (via the ILM Master Configuration). The retention period should be defined for all ILM objects. Important note, completed IMDs (Initial Measurement Data records) are no longer needed and can be removed shortly after being imported. Removing IMDs after 3 months will reduce the compressed DB by about 50%. There will be savings from other ILM objects too - including Activities and To Do Entries .ILM Crawlers are provided for low volume transactions. High Volume transactions are marked as eligible for archiving automatically.
- Cloud Implementations: Run the ILM Crawlers Batch Job (batch controls by object) and once the data is aged request Cloud Operations to move the partitions to Object Storage.
- On-Premise Implementations: Please refer to the *Oracle Utilities Meter Data Management Database Administration Guide* and [Information Lifecycle Management](#) for ILM guidelines for on-premises implementations.

Device Channels to Process

Oracle does not recommend customer process all channels of data that Meter Data Management can derive.

- Oracle does not recommend utilities hard-code devices with time of use periods (e.g.: on-peak, off-peak). Hard-coded time of use periods will likely require reprogramming in the future when those periods change. Meter Data Management can easily calculate time of use values from interval data.
- Oracle does not recommend customers hard-code demand channels (such as channel used to measure kW), since these must be reset every bill cycle. Demand can be derived from kWh interval data.
- Likewise, Oracle does not recommend customers hard-code channels for Power Factor since that can be derived from kWh and kAVRh interval data.

Data Conversion

- Only convert essential data. Only convert objects that are essential to running the business.
- Pay careful attention to measurement data. Measurement data is very, very large and may take weeks to convert. Consider this: if it takes one hour to load measurements every day, how long will it take to load 5 years of measurements? Although conversion jobs are faster than regular data loading, measurement conversion still takes time. Here are a few measurement best practices:
 - Projects are encouraged to only convert the minimum amount of measurement data required.
 - If historical measurements are required, try to limit the amount of data converted. The best practice is to convert 13 months of consumption to support VEE.
 - Only convert channels absolutely required, usually billing channels, and don't convert other interval data if not needed.
 - Measurement data values should be converted directly into the Measurement table and not use the IMD and VEE processes.
 - **Do not convert Initial Measurement (IMDs).** Completed IMDs are not needed for any Meter Data Management processes.
 - Remember that billing quantities will likely also be stored in the customer information system, so confirm that the measurement data is required before conversion.

Initial Measurement Loading Recommendations

- When processing payloads using middleware implementations, keep the number of devices to 1,000 per file for optimum usage and event processing through Oracle Service Bus. A lower number of devices, per file, will take more time for processing. A higher number of devices, per file, leads to high growth in garbage collection leading to waits and results in lower throughput. Please note, the optimum number of transactions per file may vary by head-end system.
- Initial measurement payloads should have very selective criterion to get to the exact measuring component (MC). In an ideal case, it should be the MC identifier along with device serial number. If this is not provided, then the UOM/TOU/SQI configured on the MC type is used to retrieve the exact business object (BO) from the Service Provider which might have the same values for multiple channels.
- Populating the raw data section of the IMD record will reduce overall throughput. Avoid retaining “raw” data in Smart Grid Gateway payload processing whenever possible.
- Payload processing (in which usage and event data are loaded into the system) should be run separately from measurement processing (in which VEE is performed and final measurements are created). Do not run these processes simultaneously.
- Load initial measurements and perform VEE processing every 4 to 6 hours to optimize performance.
- The duration of individual initial measurements (IMDs) within a payload should be no shorter than the time elapsed between when payloads are collected and delivered (with a minimum of 4 to 6 hours per initial measurement). For example if your system is collecting and delivering measurements three times a day, the duration of individual initial measurements should be approximately eight hours.
- Avoid loading large numbers of initial measurements for a single device configuration in a single payload.
- We recommend configuring a monitor process on the Pending status of the Initial Load initial measurement business objects so that the VEE and measurement creation processes can be deferred to batch processing.
 - Deferring processing has the following additional benefits:
 1. It can ensure chronological processing for scalar reads which provides more efficient processing. Processing scalar reads out of order can result in additional work as reconciliation initial measurements will be created and processed to true up the consumption calculations.
 2. It can ensure measuring components are processed in order based on their relationships. For example, if a scalar channel is configured as the check channel for an interval channel, the scalar channel will be processed first so that its data is available for sum checks and any interval gap filling required.
 - Configuring deferred processing involves adding the “IMD Monitor – Physical Devices” Batch Control as the Monitor Process on the Pending status to the following business objects:
 - D1-InitialLoadIMDInterval
 - D1-InitialLoadIMDScalar
 - When initial measurement processing is deferred it will be necessary to schedule the “IMD Monitor – Physical Devices” Batch Control to run more frequently. It should be scheduled such that it runs with a higher thread count immediately after the Itron Scheduled Reads cycle has completed and with fewer threads throughout the rest of day to pick up any other initial measurements that might be received (such as those received via On Demand Read commands).

VEE Recommendations

- The High-Low VEE Rule is very “heavy” in terms of performance. This rule has an intensive hit on performance of the Initial Measurement loading process. Customers are encouraged to use the Usage High-Low rule, which has a less significant performance impact. If the VEE rule version is being used, the historic pre window should be set as low as possible based on business needs.

- Each VEE Rule included in VEE processing can have an impact on overall performance. The table below summarizes the relative costs in terms of performance for several commonly used VEE Rules. Using this table when designing your VEE groups and rules can help identify potential performance challenges.
- For example, using "Minimal Impact" rules will likely have little to no significant impact on performance, while using several "Moderate Impact" rules could result in performance challenges, and using the High Low Check rule is very likely to introduce noticeable impacts to VEE processing performance.

Relative Cost	VEE Rules
Minimal Impact (0% - 5%)	Interval Interpolation Interval Replacement Rule Interval Size Validation Interval Spike Check Negative Consumption Check Scalar Replacement Rule UOM Check
Moderate Impact (5% - 20%)	Final Measurement Validation Interval Adjustment From Scalar Interval Averaging Multiplier Check Scalar Calculation From Interval Scalar Proration Sum Check
Significant Impact (20%)	High/Low Check

- Consumption sync processes should only be run on devices where the difference in consumption is outside the defined tolerance as dictated by the sum check tolerance. In a production environment, running consumption sync for two percent of devices or less is advisable.
- For cloud implementations, custom rules must be written using Groovy or Oracle Utilities Application Framework scripting.
- Run performance testing on all configuration changes performed that impact portions of Oracle Utilities Meter Data Management with high transactional processing.
- Any VEE Rules, whether provided as part of base product or custom developed, should be configured to query no more than 30 cumulative days of historical data (i.e. High/Low) to help optimize the data loading process
- A good way to troubleshoot a VEE Rule is to use the Trace section of the IMD Log. When an IMD is in Pending status, the **Trace On** button can be used to trace all VEE Rules fired during IMD processing. Once processing is complete, view the Log tab of the IMD and review the results in the **IMD Trace Log** section. For any custom developed VEE Rules, the average run time should be no longer than the average run time of other base product VEE Rules. Also, the impact of different configuration can be checked through this method as well.
- Load initial measurements and perform VEE processing every 4 to 6 hours to optimize performance.

Measurement Processing Recommendations

- Payload processing (in which usage and event data are loaded into the system) should be run separately from measurement processing (in which VEE is performed and final measurements are created). Do not run these processes simultaneously.
- When performing Periodic Estimation for the first time, avoid running estimation for large numbers of devices for a long periods of time. The Smart Meter State Monitor Process (D1-SMMTR) used to initiate periodic estimation is designed to perform estimations for a small number of devices per run, not the entire meter population in the system.

Usage Transaction Recommendations

- Usage transactions should NOT be used as an extraction tool to perform the mass export of measurement data.
- Saving derived interval data and sending the data to an external system via the "Save Interval Vector" and "Extract Interval Data" options on the "Vector and Service Quantity Math" and "Get Interval Data" usage calculation rules can have a noticeable impact on usage transaction processing. Usage transaction processing can be improved by up to 45% if extraction of interval data is eliminated. Use of these options should be limited to situations in which they are absolutely required.
- Use the Usage High Low rule instead of the VEE High Low rule where possible.
- For Outbound Messages, the schema extraction for usage transactions should be converted into a RAW string operation to allow for more efficient Pre-Processing logic.

User Interface Recommendations

- For better performance, user interface zones should be initially collapsed when not required for 90% or more of business processes. The initial state of zones (collapsed or not) can be controlled via the "Portal Preferences" tab on the **User** portal.
- The number of records returned to the user interface for a zone should be limited to 50 rows when building custom zones against large transactional tables.
- UI Map schemas should be specific to the displayed data. This will make sure that application will not visit all the elements that are not required for display.
- A good way to troubleshoot a screen in the user interface is to go to the **Preferences** in the top right hand corner of the application and choose the **Portal Preferences** tab. Choose the appropriate portal and set all zones to "Initially Collapsed". Next, navigate back to the screen that has performance issues, expand the zones one by one, and measure the execution time of each zone. This should be an accurate step-by-step representation of the full screen execution. This testing is especially important for **custom** user interfaces.
- For optimal user interface performance, Oracle Utilities Meter Data Management users should ensure their computer set to **high performance mode** so all CPU resources are used. Also, check if allocating additional memory through your browser's default settings helps improve performance.

Exception Handling Recommendations

- Don't create To Do entries unless they are absolutely required
- Use the VEE Exception Handler (D1-VEERuleExceptionHandler) and Usage Exception Handler (D2-UsageRuleExceptionHandler) rules to limit the number of To Do entries created by VEE and usage rule processing.
- Do not create To Do entries for exceptions for which Service Investigative Orders are being creative.
- Purge To Do data on a regular basis (see [Partitioning and Data Removal](#))

SQL Recommendations

- Avoid making unbounded SQLs statements with no boundary condition on date columns.
- Reduce CLOB searches and use physical columns wherever possible.
- Implement caching to pre-fetch data instead of issuing multiple SQLs.

Custom Rules and Processes

- When creating custom rules and processes, don't use plug-in scripts for high volume transactions. Use Groovy or Java (on-premises implementations only).

Cloud Services

- Java is not allowed in cloud service environments, so implementations are encouraged to use Groovy when creating custom VEE and or usage calculation rules. Training regarding using Groovy with Oracle Utilities Application Framework applications can be found in the [Oracle Utilities Learning Subscription](#) available from Oracle University.

Testing Recommendations

- "Day in the Life" performance testing with production-level data volumes should be performed on a Test Environment before going live.

Java Recommendations — On-Premises Implementation Only

1. For areas where the transactional volume is high (such as Initial Measurement), use Hibernate SQL for non-CLOB fields whenever possible as opposed to reading entire Business Object. If a CLOB field must be retrieved, then either Entity or Lite BO should be used. Reading the full Business Object should be used as the last resort for high volume areas. This process should be considered for updating data as well when it provides the same functionality as updating the Business Object. These methods should only be considered if BO level validations, pre-processing, and post-processing aren't required.
2. For a simple SQL select statement needed in Java (not many joins and no complex logic), using Hibernate SQL provides a benefit over using a Business Service and a Zone since the entities are cached for Hibernate SQL.
3. "Lite" Business Objects are provided as a way to access the main fields for a BO without pulling back all of the information. Retrieving less information will speed up the process for reading the BO.

Referencing Master Data by Identifiers

Understanding Referencing Master Data by Identifiers

There are many places within admin configuration where direct references to master data can be made. Since master data relies on system generated keys this configuration often breaks once migrated to a new environment since the master data referenced does not exist in the target environment. To alleviate this issue, in each of these instances, a user defined identifier can be used instead of the system generated keys.

This has an added benefit for installations that support multiple time zones by enabling the identification of the master data to not only search by the user defined identifier but also the time zone of the instance data. This is advantageous because it allows one set of admin configuration to satisfy master data in multiple time zones since things like TOU Maps and profile measuring components will be identified at run time using the identifier and time zone.

The following types of data can be referenced by an identifier on admin configuration:

- **Device:** can be referenced by a device identifier type. An example of this can be seen on the Specification Lookup (D1-SpecificationLookup) extendable lookup.
- **Measuring Component:** can be referenced by a measuring component identifier. When multiple time zone support is enabled the measuring component's time zone will also be evaluated. There are two major patterns for this:

- *Profile Factors*: The profile factor itself will reference the measuring component by identifier and then the admin configuration will point to the profile factor. An example of this is the profile factor list on interval measuring component types.
- *Direct Measuring Component references*: An example of this is the Final Values Overlay Profile (D1-FinalValuesOverlayProfile) extendable lookup.
- **TOU Map**: can be referenced by the TOU map template code. The appropriate TOU map is then found by searching for the appropriate TOU map that references a TOU map type for the supplied TOU map template. When multiple time zone support is enabled the TOU map type time zone will also be evaluated. An example of this is the default TOU map that can be configured in the display profile of a measuring component type.

During execution the identifier supplied will be used to find the appropriate master data entry. The following validation will occur:

When multiple time zone support is off: the search must find one and exactly one master data entry for the identifier type and value.

When multiple time zone support is on: the search must find one and exactly one master data entry for the identifier type, identifier value, and time zone. Note: some installations may want to use master data across time zones, this can still be achieved by supplying one and only one master data entry for the identifier type and value:

When the search fails to find the master data for the identifier type, identifier value, and time zone and there is only one entry for the identifier type and value that master data will be used (thus allowing one master data entry to be used across time zones)

When the search fails to find the master data for the identifier type, identifier value, and time zone and there are multiple entries for the identifier type and value an error will be encountered.

Recommendations for Creating an On-Premises Production Environment

Oracle recommends that you do not clone the demonstration environment as a basis for a new production environment. The demonstration environment typically includes transactional data that will be irrelevant to your production environment and can cause unexpected issues if it is not purged correctly. The recommended process is to start a new production environment from a new installation and migrate "clean" system data (such as business objects and algorithms) and administrative data (such as sample activity types or other administrative entities) from the demonstration and/or test or development environments as applicable.

Your implementation can use bundling and/or the Content Migration Assistant to move system and administrative data. Instructions for using these tools are contained in the [Bundling](#) and [Content Migration Assistant](#) sections in the Oracle Utilities Application Framework *Administrative User Guide*.

Contact [Oracle customer support](#) if further assistance is required.

Additional Resources

How to Get Support

Oracle is deeply committed to technical support services for its products. The Oracle Support online portal provides a reliable, easy-to-use method for obtaining technical support for Oracle Utilities Meter Data Management. To register as a new user for Oracle Support, go to <https://support.oracle.com> and follow the steps shown on the screen.

Oracle policies for standard technical support services are available at <http://www.oracle.com/us/support/policies/index.html>.

Knowledge Base Articles

Once you have access to Oracle Support, finding Knowledge Base articles is an easy process.

1. Log in to <https://support.oracle.com>.
2. Select the **Knowledge** tab at the top of the Oracle Support portal.
3. Under the Knowledge Base section, type "**Oracle Utilities Meter Data Management**" as the product.
4. Enter key search topics into the **Enter search terms** box.
5. Click **Search**.

The search results will display all knowledge articles stored on Oracle Support related to Oracle Utilities Meter Data Management for your key topics.

Important Articles

While there is a vast library of important Knowledge Base articles on Oracle Support, the list below highlights a few of the key knowledge articles that should be helpful if you're looking for additional detailed information about Oracle Utilities Meter Data Management:

Article Name	Knowledge Base Article Number
Information Center: Meter Data Management and Smart Grid Gateway Version 2	1907636.2
Related Measuring Component Consumption Sync Technical Reference Paper	1672461.1
Overview and Guidelines for Managing Business Exceptions and Errors (this document was created by the CC&B team but pertains to MDM as well)	1628358.1

Support Hot Topic Emails

Oracle Support provides a way to receive daily or weekly updates on new information posted for Oracle Utilities Meter Data Management.

1. Log in to <https://support.oracle.com>.
2. Select the **Settings** tab at the top of the Oracle Support portal. (Note: this tab may be hidden for you and may require clicking a dropdown on the right side of the tabs)
3. Once on the Settings screen, choose the **Hot Topics E-mail** from the set of options on the left.
4. Under Delivery Options, choose **Send With Selected Options**.
5. Choose your delivery frequency: either Daily or Weekly.
6. Add content which interests you: there are a number of options available. To subscribe to updates for Oracle Utilities Meter Data Management, hit the **Add...** button under Selected Products. Enter "Oracle Utilities Meter Data Management" for the Product then choose the types of information for which you'd like to receive an email.
7. Make sure you click **Apply** at the bottom once you've made all of your selections.

Embedded Help

Oracle Utilities Meter Data Management, like all Oracle Utilities Application Framework applications, provides extensive internal documentation. For example, detailed descriptions of system objects are included in the objects' maintenance portals. The lifecycle of each business object is described on the Lifecycle tab and depicted in flow diagrams on the Summary tab. This information is extremely useful for implementers and system administrators.

Embedded help is provided for all non-obvious fields in most portals and zones. If a field has associated help text, a question mark icon appears next to the field when the zone is displayed.

Leveraging Demonstration Data

One of the best ways to understand Oracle Utilities Meter Data Management is through a thorough review of the demonstration data (also referred to as "demo data") provided by Oracle. The demo data for Oracle Utilities Meter Data Management provides the following:

- An overall view of how to implement the product for common needs
- Examples of the productized solutions to solve key utility scenarios
- Some examples of adding "customer modifications" on top of Oracle Utilities Meter Data Management

This demo data can be downloaded along with the Oracle Utilities Meter Data Management. It's recommended that this be installed into an isolated environment for reference purposes separate from other development or testing environments.

Once installed, the demo data scenarios can be found in two places within Oracle Utilities Meter Data Management:

- A zone named **Demo Scenarios** is shown in the right side Dashboard. This provides a quick method to link to the 360 Degree View for the specific demo meter.
- An extendable lookup named **Demo Scenarios Catalog** describes each of the scenarios in detail. This matches the scenarios displayed in the Demo Scenarios zone.

NOTE: Oracle recommends that you do not clone the demonstration environment as a basis for a new production environment. The demonstration environment typically includes transactional data that will be irrelevant to your production environment and can cause unexpected issues if it is not purged correctly. The recommended process is to start a new production environment from a new installation and migrate "clean" system data (such as business objects and algorithms) and administrative data (such as sample activity types or other administrative entities) from the demonstration and/or test or development environments as applicable. Instructions for using these tools are contained in the [Bundling](#) and [Content Migration Assistant](#) sections in the Oracle Utilities Application Framework *Administrative User Guide*.

Customer User Groups

A number of Customer User Groups have been established (one in the United States and others internationally) that are specific to sharing best practices and learnings about Oracle Utilities Meter Data Management and Oracle Utilities Smart Grid Gateway (SGG). If you're interested in participating in a Customer User Group, contact the appropriate Product Manager.

Customer To Meter Configuration

Oracle Utilities Customer to Meter employs functionality from Oracle Utilities Customer Care and Billing, Oracle Utilities Meter Data Management, and (optionally) Oracle Utilities Operational Device Management. While much of the configuration of the application is very similar to that used with the individual applications, the merging of functions requires some configuration that is unique to Customer To Meter.

This chapter describes topics specific to configuring Customer To Meter to support a seamless integration between Customer Care and Billing, Meter Data Management, and Operational Device Management functionality.

Cross Product Configuration Master Configuration

The Cross Product Configuration master configuration provides a single point of access for configuration information related to consolidated data maintenance, data mapping, and other master configurations used with Customer To Meter.

To open the master configuration, select **Admin, General, Cross Product Configuration**. The master configuration opens in the **Cross Product Configuration** portal.

The **External System** field references the external system used for communication between Customer Care and Billing, Meter Data Management, and Operational Device Management including data synchronization requests, Service Order Management (SOM) queries, etc.

Consolidated Maintenance

The **Consolidated Maintenance** section documents objects that use some form of consolidated maintenance in Customer To Meter.

Merged Maintenance references the extendable lookup used to configure [Merged Maintenance](#). Click **Joint Maintenance Lookup** to view values for this extendable lookup.

The **Consolidated Maintenance Objects** table lists objects that use [Master Data Synchronization](#) and [Data Audit Maintenance](#) for consolidated maintenance. Click on an object's name to view its maintenance object.

Customer and Device Value Mapping

The **Customer and Device Value Mapping** section lists objects used to map data between Customer Care and Billing and Meter Data Management.

SA Type Mapping references the extendable lookup used to map Customer Care and Billing service agreement (SA) types to Meter Data Management usage subscription types. Click **C2M SA Type Mapping Values** to view values for this extendable lookup.

The table lists fields that use [Lookup Value Mapping](#) to map values between Customer Care and Billing and Meter Data Management. Click the Description link to view and/or edit mapping values for a specific field. A plus sign (+) indicates that mapping values have not been defined for that field. Click the icon to configure values for that field.

Device and Asset Value Mapping

The **Device and Asset Value Mapping** section lists objects used to map data between Meter Data Management and Operational Device Management.

The table lists fields that use [Lookup Value Mapping](#) to map values between Meter Data Management and Operational Device Management. Click the Description link to view and/or edit mapping values for a specific field. A plus sign (+) indicates that mapping values have not been defined for that field. Click the icon to configure values for that field.

Related Master Configurations

The **Related Master Configurations** section lists other master configurations used with Customer To Meter, including:

- Master Data Synchronization Configuration
- Seeder Sync Request Master Configuration
- Service Order Management Master Configuration
- Service Order Management Integration

Click the **Master Configuration** link to view a specific master configuration.

Customer to Meter Consolidated Maintenance and Data Mapping

Oracle Utilities Customer to Meter uses data from Oracle Utilities Customer Care and Billing, Oracle Utilities Meter Data Management, and (optionally) Oracle Utilities Operational Device Management. This chapter describes how data used by these applications can be maintained through a consolidated maintenance process, and how data in each application is mapped to similar data in other applications..

There are several types of consolidated maintenance and data mapping used by Customer to Meter, including:

- **Merged Maintenance:** maintenance of data in applications through use of a single portal.
- **Master Data Synchronization:** master data used by the applications is kept synchronized when data is created or updated.
- **Data Audit Maintenance:** creating specific types of Meter Data Management data triggers creation of corresponding Customer Care and Billing data via Audit algorithms
- **Lookup Value Mapping:** lookup values used by one application are mapped to corresponding values in other applications via extendable lookups
- **Transactional Data Mapping:** creating specific types of transactional data in one part of Customer to Meter triggers the creation of corresponding transactions in other parts.

Merged Maintenance

Merged maintenance allows data in multiple product—specific maintenance objects to be updated via a single maintenance portal.

Administrative Data Merged Maintenance

Merged maintenance is used with several types of administrative data in Customer Care and Billing and Meter Data Management that are used in nearly identical ways in both applications. These include:

- Service Type
- SP Type (Service Point Type)
- Service Quantity Identifier
- Time of Use
- Unit of Measure

When a user creates or updates data of these types, the maintenance portal displays a superset of data elements from product-specific business objects based on a “superset” service script (defined in the Joint Maintenance Lookup extendable lookup (see below)). When the data is saved, the corresponding maintenance objects in Customer Care and Billing, Meter Data Management, and Operational Device Management are updated. For example, when a user navigates to the **Unit of Measure** portal and selects a record to update, the portal displays a combination of data from the X1-UnitOfMeasure and D1-UnitOfMeasure business objects. When the user saves the data, the changes are saved to both the UOM Customer Care and Billing maintenance object and the D1_UOM Meter Data Management maintenance object.

NOTE: Service Point Types (asset location types) are also used by Operational Device Management.

Service Point Merged Maintenance

In addition to the above types of administrative data, Customer to Meter service points are also maintained through merged maintenance. Service point merged maintenance does NOT make use of a “superset” service script, but does use product-specific business objects. Oracle Utilities Customer to Meter service points (asset locations in the case of Operational Device Management) are maintained through these product-specific business objects and extendable lookups.

The Customer to Meter base package uses the following service point business objects:

- Meter Data Management: X1D-ServicePoint
- Customer Care and Billing: X1-ServicePoint
- Operational Device Management: W2-ServicePoint

When a Customer to Meter service point is created or updated, the “Maintain CCB Service Point” (X1-CCBSPMNT) and “Maintain ODM Service Point” (X1-ODMSPMNT) Pre-Processing algorithms on the X1D-ServicePoint business object uses the C2M Mapping Field Values (X1-CCBMDM-MDMCCB-Lookup) and ODM-MDM Mapping Field Values (X1-ODMMDM-MDMODM-Lookup) extendable lookups to map lookup values between Customer Care and Billing and Meter Data Management and between Meter Data Management and Operational Device Management, and creates or updates an instance of the X1-ServicePoint and W2-ServicePoint business objects (which are used to update the their corresponding maintenance objects).

NOTE: Customer to Meter service point types should reference the “Service Point — MDM” (X1D-ServicePoint) business object.

Joint Maintenance Extendable Lookup

The specific business objects and service scripts used by merged maintenance are defined in the Joint Maintenance Lookup (X1-JointMaintenance) extendable lookup. Records in this extendable lookup define the superset script that contains the union of the elements of the objects that exist in Customer Care and Billing and Meter Data Management, as well as the corresponding product-specific business objects.

Merged maintenance lookup values are defined by the following:

- **CCB Maintenance Object:** the unique identifier for the joint maintenance lookup value
- **Superset Script:** the superset script that contains the union of the elements of the objects that exists in Customer Care and Billing and Meter Data Management. Used for administrative data maintenance only.
- **CCB Business Object:** the business object used to update the Customer Care and Billing maintenance object
- **MDM Business Object:** the business object used to update the Meter Data Management maintenance object
- **ODM Business Object:** the business object used to update the Operational Device Management maintenance object

Customer To Meter Master Data Synchronization

This section describes the master data synchronization processes supported by Oracle Utilities Customer to Meter.

In Customer to Meter, Customer Care and Billing information is generally considered the data of record for account, customer, or service agreement-related data. Synchronizing master data between Customer Care and Billing tables and Meter Data Management tables ensures that all account, customer, and service point-related data is correct and up to date before usage transaction calculations are performed. Master data synchronization ensures that when specific types of Customer Care and Billing data are created or updated, corresponding Meter Data Management data is also created or updated.

Initial master data synchronization is performed via a data conversion and migration process. [Initial Master Data Conversion](#) for more information.

The table below summarizes the types of data ongoing master data synchronization supported in Customer to Meter:

When Customer Care and Billing data of this type is created and/or updated:	Master Data Synchronization creates and/or updates this type of Meter Data Management data:
Bill Cycle / Bill Cycle Schedule	Bill Cycle / Bill Cycle Schedule
Contract Option	Dynamic Option
Contract Option Event	Dynamic Option Event
Person	Contact

When Customer Care and Billing data of this type is created and/or updated: **Master Data Synchronization creates and/or updates this type of Meter Data Management data:**

Service Agreement	Usage Subscription
-------------------	--------------------

For example, when a Customer Care and Billing Service Agreement is created, the synchronization process creates a corresponding Meter Data Management usage subscription.

NOTE: Master data synchronization is a one-way process. When Customer Care and Billing data is created or updated, corresponding Meter Data Management data is created or updated, but changes made to Meter Data Management data are NOT synchronized to the Customer Care and Billing data. As a general rule, changes to the types of data outlined above should be made in the Customer Care and Billing entities instead of their Meter Data Management counterparts.

The Customer to Meter synchronization process is based on the [Data Synchronization](#) functionality of the Oracle Utilities Application Framework, and is supported through a set of maintenance objects, master configurations, business objects, and service scripts.

Maintenance Objects

Customer to Meter supports master data synchronization for the following maintenance objects.

Customer Care and Billing Maintenance Object	Meter Data Management Maintenance Object
BILL CYCLE (Bill Cycle)	D1-BILLCYCLE (Bill Cycle)
CONTRACT OPT (Contract Option)	D1-DOP (Dynamic Option)
CONTRACT OPT (Contract Option Event)	D1-DOPEVT(Dynamic Option Event)
PERSON (Person)	D1-CONTACT (Contact)
SA (Service Agreement)	D1-(Usage Subscription)

Master Configurations

The following master configurations are used to configure the sync process between Customer Care and Billing data and Meter Data Management data:

Master Configuration	Name / Description
Master Data Synchronization Configuration	Lists all foreign key references that need resolution. Each one should reference the view that contains the external key / production key cross-reference. If initial synchronization process are also configured for data conversion in addition to the ongoing synchronization process, two views are specified. For entities that undergo the ongoing synchronization, an external system / ID type mapping is specified to cater for entities that might be synchronizing from more than one external system.
Seeder Sync Request Master Configuration	Lists the maintenance objects (contact, usage subscription, etc.) that require synchronization. Each references the synchronization business object that needs to be instantiated when processing a synchronization request for that maintenance object. For maintenance objects that undergo both initial and the ongoing synchronization, two business objects are specified.

Outbound Data Synchronization Business Objects

When data is created for one of the above Customer Care and Billing maintenance objects, an outbound synchronization request is created to create the appropriate Meter Data Management data.

Synchronization of Customer Care and Billing data and Meter Data Management data uses the following outbound synchronization business objects:

Data Sync	Object Name	Business Object
Bill Cycle/Schedule > Bill Cycle/Schedule	MDM2 Bill Cycle Sync Request	C1-MDM2BillCycleSyncRequest
Contract Option > Dynamic Option	MDM2 Contract Option Sync Request	C1-MDM2ContractOptSyncRequest
Contract Option Event > Dynamic Option Event	MDM2 Contract Option Event Sync Request	C1-MDM2ContrOptEvtSyncRequest
Person > Contact	MDM2 Person Sync Request	C1-MDM2PersonSyncRequest
Service Agreement > Usage Subscription	MDM2 SA Sync Request	C1-MDM2SASyncRequest

Inbound Data Synchronization Service Scripts

When outbound synchronization requests enter the “Send Request” state, Enter algorithms invoke service scripts to create corresponding inbound data synchronization requests.

Synchronization of Customer Care and Billing data and Meter Data Management data uses the following inbound data synchronization service scripts:

Data Sync	Name	Service Script
Bill Cycle/Schedule > Bill Cycle/Schedule	Bill Cycle Inbound Sync Request	X1-InBCSynSS
Contract Option > Dynamic Option	Inbound Dynamic Option Sync	X1-InSyDyOp
Contract Option Event > Dynamic Option Event	Inbound Dynamic Option Event Sync	X1-InSyDyOpE
Person > Contact	Inbound Contact Sync	X1-InSyCont
Service Agreement > Usage Subscription	Inbound Usage Subscription Sync	X1-InSyUS

Inbound Data Synchronization Business Objects

When outbound synchronization requests enter the “Send Request” state, service scripts create corresponding inbound data synchronization requests. Master data synchronization uses **ongoing synchronization requests** to continuously keep Meter Data Management data synchronized with corresponding Customer Care and Billing data. Ongoing synchronization requests can be used to maintain contacts, usage subscriptions, dynamic options, and bill cycles.

Ongoing synchronization of Customer Care and Billing data and Meter Data Management data uses the following data synchronization business objects:

Data Sync	Ongoing Synchronization Object Name	Business Object
Bill Cycle/Schedule > Bill Cycle/Schedule	Inbound Bill Cycle Sync Request	D2-InboundBillCycleSyncRequest
Contract Option > Dynamic Option	Dynamic Option Ongoing Sync Request	D2- OngoingSyncRequestDynOpt
Contract Option Event > Dynamic Option Event	Dynamic Option Event Ongoing Sync Request	D2- OngoingSyncRequestDynOptEvt
Person > Contact	Contact Ongoing Sync Request	D1-OngoingSyncRequestContact
Service Agreement > Usage Subscription	Usage Subscription Ongoing Sync Request	D2-OngoingSyncRequestUS

Example Synchronization Process Steps

This section provides an overview of the processing that takes place when an ongoing synchronization request is sent. For each step in the process, the table below provides a brief description of the processing that takes place, and lists the specific objects involved.

Step	Process	Objects
1	Data in Customer Care and Billing is created or changed, triggering a synchronization request. For example, a service agreement is updated, and the corresponding usage subscription must be updated.	
2	An outbound synchronization request is created.	Outbound Synchronization Request business object: C1-MDM2SASyncRequest
3	When the synchronization requests enters the "Send Request" status, an Enter algorithm invokes the inbound synchronization service script to create an inbound sync request.	Inbound Synchronization Service Script: X1-InSyUS
4	The service script creates the appropriate inbound synchronization request. In this case, it's an ongoing synchronization request.	Inbound Synchronization Request business object: D2-OngoingSyncRequestUS
5	For ongoing synchronization requests, the following steps are performed by Enter algorithms on the synchronization request business object lifecycle states: <ul style="list-style-type: none"> • Data Transformed/Basic Schema Validated • Determine Sync Request BO • Setup Transformed Data • Pre-Added • Sync Request Pre-Add Data • FKs Resolved • Resolve Keys - Ongoing Sync • Updating • Sync Request Update Data 	Setup Transformed Data Algorithm: D1- SETTRANDT Sync Request Pre-Add Data Algorithm: D1-SR-PREADD Resolve Keys - Ongoing Sync Algorithm: D1-RESKEYFAL Sync Request Update Data Algorithm: D1- SR-UPDDAT

Initial Master Data Conversion

This section describes the initial master data conversion processes supported when migrating data from Oracle Utilities Customer Care and Billing to Oracle Utilities Customer to Meter.

Initial data conversion facilitates creation of data in Meter Data Management and Operational Device Management based on corresponding data in Customer Care and Billing. After creating master data (and its corresponding administrative data) in Customer Care and Billing, batch processing can be used to create corresponding master data (and its corresponding administrative data) in Meter Data Management and Operational Device Management. The table below lists the specific types of master data that can be converted using this process.

Customer Care and Billing Data	Meter Data Management / Operational Device Management Data
Service Point	Service Point (Node)
Person	Contact
Service Agreement	Usage Subscription
Meter	Device (Asset)
Item	Device (Asset)
Service Point Item History	Install Event (Asset Disposition)
Service Point Meter History	Install Event (Asset Disposition)
Meter Reads	Measurements
Interval Profile	Measuring Component
Contract Options and Contract Option Events	Dynamic Options and Dynamic Options Events

CCB/MDM/ODM Data Migration Master Configuration

In addition to the above listed master data, the initial data conversion process also converts various administration data from Customer Care and Billing to Meter Data Management and Operational Device Management. The CCB/MDM/ODM Data Migration Master Configuration is used to identify how specific types of administration data are to be migrated, including:

- **Interval Meter Types:** a list of Customer Care and Billing interval meter types that will be converted to Meter Data Management device types
- **Interval Profile Types:** a list of Customer Care and Billing interval profile types that will be converted to Meter Data Management measuring component types
- **Tracked and Item Types:** a list of Customer Care and Billing meter types and item types that will be tracked as assets and components in Operational Device Management
- **Out of Service Location Type:** the Out of Service Location Type used in creating Out of Service Location for meter and item data migration
- **Out of Service Location:** the Out of Service Location used on assets created from retired Customer Care & Billing meters
- **Service Agreement Types Pivot to Bill Determinants:** Allows you to navigate to the Service Agreement Type portal, to review and manually update the **Special Role** flag to “Bill Determinants Required” for those service agreement types that should be pivoted to require bill determinants (in other words, those that require service quantities created by Meter Data Management usage transactions).
- **Inflight FA Configuration:** options related to field activity related administration data, including whether or not to create Service Order Management field activity data, whether or not to include a Field Activity Type Profile on service point types, and mapping of Customer Care and Billing field activity types to Service Order Management field task types.

Refer to the embedded help for each of the above for more information about each.

Interval Profile Migration

The **Interval Profile** section of the master configuration should be configured to define the specific business objects to use when creating measuring component types and measuring components based on interval profiles. Interval profile measuring components should be created as "standalone" measuring components, Options include the following (values in parentheses are recommended settings):

- **Measuring Component Type BO:** Defines the measuring component type business object to use when creating measuring component types based on interval profile types (D1-StandaloneIntrvlMCType).
- **Sub Type/Measuring Component BO Mapping:** Maps Interval Profile Sub Types to specific measuring component business objects (D1-StandaloneInterval).
- **Migrate SA Profile:** Indicates if SA Profiles should be migrated.
- **Interval Profile Relationship Type Mapping:** Maps CCB Interval Profile Relationship Types to MDM Direct Channel Relationship Types (Standalone Data Request)

Data Conversion Batch Controls

Batch controls perform processing for data conversions, including such as allocating keys to data, resolving foreign keys, and loading data.

The table below lists the batch controls used for each type of data:

Customer Care and Billing Data	Meter Data Management Data	Batch Job
Administrative Data	Administrative Data	Migrate Admin Data (X1-MIGAD)
Service Point	Service Point	Migrate Service Point (X1-MIGSP)
Person	Contact	Migrate Person (X1-MIGP)
Service Agreement	Usage Subscription	Migrate Service Agreement (X1-MIGSA)
Meter	Device	Migrate Meter (X1-MIGMT)
Item	Device	Migrate Item (X1-MIGIT)
Interval Profile	Measuring Component	Migrate Interval Profile (X1-MIGIP)
SP Item History	Install Event	Migrate SP Item History (X1-MIGSI)
SP Meter History	Install Event	Migrate SP Meter History (X1-MIGSM)
Meter Reads	Measurements	Migrate Meter Reads (X1-MIGMR)
Contract Options	Dynamic Options	Migrate Contract Options (X1-MIGCO)

Processing Modes

The data conversion batch controls listed above include parameters to control the manner in which data conversion processing is performed. These parameters include the following:

- **Low ID Override Value:** Used to specify an ID value to override the low ID in the thread ID range calculation. This, along with the High ID Override Value, can be used to limit the number of records processed by each batch run.
- **High ID Override Value:** Used to specify an ID value to override the high ID in the thread ID range calculation. This, along with the Low ID Override Value, can be used to limit the number of records processed by each batch run.
- **Mode:** Used to specify whether the batch process will Insert or Delete data.
- **Migration Option:** Used to specify the type of data migration being processed, One Time Migration or Staggered. Staggered mode inserts an ad hoc characteristic that is used to detect if the record has been changed since its initial creation (used by the “Delete” mode).

For implementations with relatively small data volumes, in which data conversion can be performed in a single set of batch processes, these jobs can be run in the “Insert” Mode using the “One Time Migration” Migration Option.

For implementations with larger data volumes, in which data conversion might require running multiple instances of each batch process, the Mode and Migration Option parameters can be used to adopt a “staggered” approach to migrating the data. This mode allows identification of data that may have been updated since its initial creation which can be deleted, and then re-inserted. Running batch processing in staggered mode involves running a series of batch process runs, as follows:

1. Mode: Insert / Migration Option: Staggered — This performs the initial data conversion/migration, and flags records with an ad hoc characteristic noting the record’s version at the time of the migration, which is used to detect if the record has been changed since its initial creation.
2. Mode: Delete — This removes records that have changed in production (by comparing the versions recorded in the ad hoc characteristic) as well as records that have been deleted in production.
3. Mode: Insert / Migration Option: Staggered — This re-inserts records deleted in the previous step, including those that have changed in production since the initial migration, and inserts new records that were added in production since the initial migration.

Batch Process Sequence

The table below lists the sequence in which these migration batch processes should be executed.

Sequence	Maintenance Object
1	Admin
2	Item
3	Meter
4	Interval Profile and Interval Profile Data (see Interval Profile Migration and Converting Interval Profile Data Sets for more information.)
5	Service Point
6	Service Point Item History
7	Service Point Meter History
8	Person
9	Contract Option
10	Service Agreement
11	Meter Read

Operational Device Management Data Synchronization

This section describes the master data synchronization processes used to synchronize data between Oracle Utilities Operational Device Management and Oracle Utilities Meter Data Management, including:

- Asset and Device Synchronization
- Install Event and Asset Disposition Synchronization
- Contact and Contact Type Synchronization
- Manufacturer Synchronization
- Field Task Type and Asset Activity Type Synchronization

Asset and Device Synchronization

When assets are created (or updated) in Operational Device Management, a related Meter Data Management device is created / updated. This synchronization is performed in a manner very similar to the process outlined in [Customer To Meter Master Data Synchronization](#). The primary difference in how asset-device synchronization works is that instead of triggering the process based on the Asset maintenance object, the synchronization is triggered via the Generic Change Data Capture (W1-GCHG-CDCP) Audit algorithm on the parent business object (W1-TrackedAsset) of the following asset business objects:

- Item (W1-Item)

- Smart Meter (W2-SmartMeter)
- Analog Meter (W2-ManualMeter)
- Communication Component (W2-CommunicationComponent)

For asset-device synchronization, the specific synchronization objects used include the following:

- **Outbound Data Synchronization Business Object:** MDM Asset Synchronization Request (W1-MDMAssetSyncRequest)
- **Inbound Data Synchronization Service Script:** Inbound Device Sync (X1-InSyDvc)
- **Inbound Data Synchronization Business Object:** Device Ongoing Sync Request (D1-OngoingSyncRequestDevice)

Install Event and Asset Disposition Synchronization

When a device is installed at a service point, the disposition of its related asset is updated to “Installed”. The update to the device’s install event triggers the update to the asset disposition, changing its **Status** and **Asset Disposition** to “Installed” and its **Location** to the service point with an effective date matching the install event’s **Installation Date/Time**. This synchronization is performed in a manner very similar to the process outlined in [Customer To Meter Master Data Synchronization](#). In this case, the synchronization is triggered via the Generic Change Data Capture (W1-GCHG-CDCP) Audit algorithm on the Install Event maintenance object (D1-INSTLEVT).

For install event / asset disposition synchronization, the specific synchronization objects used include the following:

- **Outbound Data Synchronization Business Object:** ODM Install Event Sync request (D1-InstallEventSyncRequest)
- **Inbound Data Synchronization Service Script:** Inbound Asset-Node Sync (X1-InSyAstNd)
- **Inbound Data Synchronization Business Object:** Asset-Node Ongoing Sync Request (W1-OngoingSyncRequestAssetNode)

Contact and Contact Type Synchronization

Contacts in Operational Device Management can be associated to asset locations (service points). Operational Device Management contacts are created when a Meter Data Management service point has a contact associated with it via the Maintain ODM Service Point (X1-ODMSPMNT) algorithm on the Service Point - MDM (X1D-ServicePoint) business object (see [Service Point Merged Maintenance](#) for more information about how service points are maintained).

Operational Device Management contacts and contact types are maintained via Pre-Processing algorithms on the following Meter Data Management business objects:

Meter Data Management Business Object	Pre-Processing Algorithm	Operational Device Management Business Object
Business (D1-Business)	Maintain ODM Business (X1-MNTODMBUS)	Business (W1-Business)
Person (D1-Person)	Maintain ODM Person (X1-MNTODMPER)	Person (W1-Person)
Contact Type (D1-ContactType)	Maintain ODM Contact Type (X1-MNTODMCTY)	Contact Type (W1-ContactType)

NOTE: Out of service locations reference Meter Data Management contacts.

Manufacturer Synchronization

When manufacturers are created or updated in Operational Device Management, corresponding data is created or updated in Meter Data Management.

When a manufacturer is created or updated in Operational Device Management, a corresponding Meter Data Management manufacturer is created / updated. This synchronization is performed via the Manufacturer Joint Maintenance (X1-MAINTMANF) Post-Processing algorithm on the W1-Manufacturer business object.

NOTE: Operational Device Management is considered the “system of record” for manufacturers and models in Customer To Meter.

Field Task Type and Asset Activity Type Synchronization

When Field Task Types are created in Service Order Management (as values for the Field Task Type extendable lookup), corresponding Operational Device Management Asset Activity Types are created. This synchronization is performed via the Maintain MDM/SOM field task type to a corresponding ODM activity type (X1-MNTFLDTSK) Post-Processing algorithm on the D1-FieldTaskTypeLookup business object.

Asset activity types created in this manner are based on the Service Order Management Activity Type (W1-SOMActivityType) business object. The **Activity Business Object** for these asset activity types is Service Order Management Activity (W1-SOMActivity).

Lookup Value Mapping

Oracle Utilities Customer to Meter service points and other records reference field and lookup values from Oracle Utilities Customer Care and Billing, Oracle Utilities Meter Data Management, and Oracle Utilities Operational Device Management. This section describes how field and lookup values used by Customer Care and Billing are mapped to similar field and lookup values used by Oracle Utilities Meter Data Management, and how field and lookup values used by Oracle Utilities Operational Device Management are mapped to similar field and lookup values used by Oracle Utilities Meter Data Management

Customer Care and Billing / Meter Data Management Mapping

Mapping of field and lookup values between Oracle Utilities Customer Care and Billing and Oracle Utilities Meter Data Management is supported through the use of two extendable lookups:

- **C2M Mapping Field List** (X1-CCBMDM-MDMCCB-MappingField): used to capture the fields that require translation mapping between Customer Care and Billing and Meter Data Maintenance maintenance objects in Customer to Meter. Values in this extendable lookup are identified by a field or lookup used by Customer Care and Billing, such as Disconnect Location (DISCON_LOC_CD) or Life Support / Sensitive Load (LS_SL_FLG).
- **C2M Mapping Field Values** (X1-CCBMDM-MDMCCB-Lookup): used to capture the mapping values for the fields and lookups defined in the C2M Mapping Field List extendable lookup. Values in this extendable lookup are identified by a Customer Care and Billing field or lookup defined in the C2M Mapping Field List extendable lookup. Each value also defines the specific value mappings for the field or lookup.

Examples

Value Mappings for the Disconnect Location (DISCON_LOC_CD) field include the following:

CCB Value	MDM Value
Disconnected at meter	Device
Disconnected at pole	Source

Value Mappings for the Activity Type (FA_TYPE_CD) lookup include the following:

CCB Value	MDM Value	MDM Value 2
Start Service	Enable Service	
Stop Service	Disable Service	
Re-read meter	Field Activity	Read Meter

Value Mappings for the Life Support / Sensitive Load (LS_SL_FLG) lookup include the following:

CCB Value	MDM Value
None	Not on life support
LS/SL	On life support

Operational Device Management / Meter Data Management Mapping

Mapping of field and lookup values between Oracle Utilities Operational Device Management and Oracle Utilities Meter Data Management is supported through the use of two extendable lookups:

- **ODM—MDM Mapping Field List** (X1-ODMMDM-MDMODM-MappingField): used to capture the fields that require translation mapping between Operational Device Management and Meter Data Management maintenance objects in Customer to Meter. Values in this extendable lookup are identified by a field or lookup used by Meter Data Management, such as the Life Support / Sensitive Load (LIFE_SUPPORT_SENS_LOAD_FLG) or Ok to Enter (OK_TO_ENTER_FLG).
- **ODM—MDM Mapping Field Values** (X1-ODMMDM-MDMODM-Lookup): used to capture the mapping values for the fields and lookups defined in the C2M Mapping Field List extendable lookup. Values in this extendable lookup are identified by a Operational Device Management field or lookup defined in the ODM—MDM Mapping Field List extendable lookup. Each value also defines the specific value mappings for the field or lookup.

Examples

Value Mappings for the Life Support / Sensitive Load (LIFE_SUPPORT_SENS_LOAD_FLG) lookup are as follows:

ODM Value	MDM Value
Life Support/Sensitive Load	LS/SL
None	None

Value Mappings for the Ok to Enter (OK_TO_ENTER_FLG) field are as follows:

ODM Value	MDM Value
No	False
Yes	True

Data Audit Maintenance

Different functions in Customer Care and Billing and Meter Data Management use similar types of data when calculating usage and billing charges, and it's critical that the data be consistent between the applications. For example, both Usage Rules in Meter Data Management and Calculation Rules in Customer Care and Billing make use of TOU Groups, TOU Map Templates, TOU Map Types, etc., and when calculating usage and billing charges for an account, the data used by both systems should be effectively identical. The process of maintaining similar sets of data usable by each system is called Data Audit Maintenance.

When specific types of Meter Data Management data is created or updated, Audit algorithms create or update corresponding Customer Care and Billing data. For instance, when a TOU Map Type usable by Meter Data Management Usage Rules is created, data auditing creates a similar TOU Map Type usable by Customer Care and Billing Calculation Rules.

Data audit maintenance is used with several types of Meter Data Management data in Customer to Meter, including:

- TOU Group
- TOU Map Template

- TOU Map Type
- TOU Map
- Device Type (Item Type)

The table below outlines the business objects and algorithms used by data audit maintenance:

Data Type	Business Object	Audit Algorithm
TOU Group	D2-TOUGroup	Maintain CCB TOU Group (X1-MCCBTOUGP)
TOU Map Template	D2-TOUMapTemplate	Maintain CCB TOU Map Template (X1-MCCBTOUTM)
TOU Map Type	D2-TOUMapType	Maintain CCB TOU Map Type (X1-MCCBTOUMT)
TOU Map	D2-TOUMap	Maintain CCB TOU Map (X1-MCCBTOUMP)
Device Type (Item Type)	D1-ItemType	Maintain CCB Item Type (X1-MCCBITEMT)

Refer to the Business Object and Algorithm portals to view additional details regarding these audit algorithms.

Other Data Auditing

In addition to the objects listed above, Customer To Meter uses data auditing with other objects in Customer Care and Billing to ensure that changes to data reflected in related data in Meter Data Management. These objects use Audit algorithms on their maintenance objects to capture any changes and update the corresponding data. The objects that make use of this approach include the following:

- **Account:** When service agreement-related account data is changed in Customer Care and Billing, the audit algorithm creates a Service Agreement outbound data synchronization request to captures the change and update the corresponding usage subscription in Meter Data Management.
- **Premise:** When a Customer Care and Billing premise is changed, the audit algorithm updates the address information in the service point in Meter Data Management.

The table below outlines the data types, maintenance objects, and algorithms used by these.

Data Type	Maintenance Object	Audit Algorithm
Account	ACCOUNT	C2M Account Change Data Capture (SA-Based) (X1-ACCTDCSA)
Premise	PREMISE	Update MDM SP from CCB Premise (X1-UPSPFRPR)

Refer to the Maintenance Object and Algorithm portals to view additional details regarding these audit algorithms.

Transactional Data Mapping

Certain types of transactional data created in Customer Care and Billing result in related transactional data in Meter Data Management (and vice-versa). This section describes these transactional mappings.

Usage Requests / Usage Transactions

Customer Care and Billing creates usage requests during the billing process to request usage calculations in Meter Data Management. These requests in turn create Meter Data Management usage transactions, which perform the usage calculations.

Customer Care and Billing usage requests use the following business objects:

- MDM Cyclical Usage Request (C1-UsageRequestCyclicalBilling): Used with usage requests created from the cyclical or batch billing process.

- MDM Non-Cyclical Usage Request (C1–UsageRequestNonCyclical): Used with usage requests created from non-cyclical or online bill generation.
- MDM Usage Request (C1–UsageRequest): Parent business object that defines the lifecycle for Cyclical and Non-Cyclical usage requests.

When a usage request enters the “Send Request” state, the “Send Usage Request Message to MDM” (X1–SENDUSGR) Enter algorithm invokes the “Usage Transaction Request Inbound” (X1–UsgTrRqIn) service script which uses the Usage Transaction Seeder (D1–UsgTranSeeder) business object to create a usage transaction.

When a Meter Data Management usage transaction enters a “Subsequent Correction” state, the “X1–SEND-SUBC” Enter algorithm invokes the “Call Subsequent Correction Notification” (X1–SendSubC) service script to process a corrected read notification for Customer Care and Billing by finding the account associated with the corrected read and creating an off cycle bill generator to handle associated correction processing.

Refer to [The Big Picture of Usage Requests](#) for more information about usage requests and usage transactions.

Field Activity Requests / Service Order Activities

Customer Care and Billing creates Field Activity Requests to initiate service orders to perform tasks at a service point. Most field activity requests are created:

- When a customer service representative starts or stops service at a premise. When this happens, the system automatically creates field activity requests for each service point.
- When service is cut due to lack of payment or reconnected for sufficient payment or arrangement.

When Customer Care and Billing creates a field activity request, a corresponding Service Order Activity is created to orchestrate the various activities required to fulfill the service order by continuously monitoring the status of the service point, device installation, and related measurements. This orchestration can include field activities to instruct a field crew to install, remove, or exchange a meter, as well as eligible smart meter command activities to connect or disconnect the meter, etc.

Service Order Field Activities are specific activities that typically exist only in Service Order Management and not Customer Care and Billing. However, field activity remarks notification, appointment notification (if required by the service order field activity), a missed appointment (which can create an adjustment) and create customer contact actions can be invoked in Customer Care and Billing when triggered from service order field activities.

Refer to [Understanding Service Order Management](#) for more information about service order activity processing.

Other Transactional Data

Data synchronization of interval register data, interval profiles, and field activities is performed via a data conversion and migration process. See [Transactional Data Conversion](#) for more information.

Transactional Data Conversion

This section describes transactional data conversion processes supported when migrating data from Oracle Utilities Customer Care and Billing to Oracle Utilities Customer to Meter or Oracle Utilities Customer Cloud Service, including conversion of interval register data, interval profiles, and “inflight” field activities.

Converting Interval Register Data

Interval register data from Oracle Utilities Customer Care and Billing can be converted into Measurement data for use in Customer to Meter (and Customer Cloud Service).

Note: Refer to **Maintaining Interval Data** and **Maintaining Interval Data** in the *Oracle Utilities Customer Care and Billing Administrative User Guide* for more information about interval register data in Oracle Utilities Customer Care and Billing.

Interval Registers should have been migrated to Interval Measuring Components as part of the Initial Master Data Conversion process (see [Initial Master Data Conversion](#)). Once the registers have been converted, register reads (also known as Register Data Sets) can be converted to measurement data.

A batch control (see below) is used to convert register read data from Interval Register reads to the Customer to Meter (Customer Cloud Service) Measurement table. Processing can be defined for a specified year and month range, and optionally for a range of Register IDs.

Processing Notes:

- Only Register Data Sets with a status of "Complete" will be converted. Data sets that have 'No Data' will be excluded from the conversion.
- No validation is performed on the interval data. All the interval data is assumed to be valid.
- If the **Data Set Type** is not defined for the register data set, the converted measurements will have a Condition of "Regular".
- Register data sets with a **Data Set Type** of "Estimated" will result in measurements with a Condition of "Estimated".
- If overlapping register data sets are processed, the values from the data set with the latest Set Data Time are selected for the conversion.
- The conversion process will not fill-in data for periods without interval data.

Creation of records in the Measurement table is performed via an Insert Select of the Interval Register Data, for a month's worth of data at a time, which will be immediately committed.

Conversion should only be run for a given range of Register IDs for a given date range once. Attempting to convert the Register IDs for the same date range multiple times can result in errors.

Interval Register Data Conversion Batch Control

The Migrate Register Data Set (X1-MIGRD) batch control performs processing for interval register data conversion.

The registers to be converted for each batch run can be defined using the Register ID Low and Register ID High parameters. To process data for a single register, you can set both of these parameters to the same Register ID. If neither parameter is defined, the process will convert data for all registers.

The batch process can convert up to 1 year of data at a time, the specific year is designated by the Year parameter. The Start Month and End Month parameters can be used to further limit the time range for the conversion.

This batch control uses the following parameters:

- **Register ID Low:** Optional. Used to specify an ID value to override the low ID in the thread ID range calculation. This, along with the Register ID High be used to limit the number of records processed by each batch run. If not specified, the process will convert data for all registers whose ID is lower than the Register ID High parameter (if defined).
- **Register ID High:** Optional. Used to specify an ID value to override the high ID in the thread ID range calculation. This, along with the Register ID Low, can be used to limit the number of records processed by each batch run. If not specified, the process will convert data for all registers whose ID is higher than the Register ID Low parameter (if defined)
- **Year:** The year for which data will be converted. (Required)
- **Start Month:** The start month of the time range for which data will be converted. (Required)
- **End Month:** The start month of the time range for which data will be converted. (Required)

Examples:

To convert data for all registers from the year 2020, you would set the parameters as follows:

- Year: 2020
- Start Month: 01
- End Month: 12

To convert data for all registers for the months of January through May of 2020, you would set the parameters as follows:

- Year: 2020
- Start Month: 01
- End Month: 05

To convert data for registers whose IDs range from 10001000 to 10009000 for from the year 2020, you would set the parameters as follows:

- Register ID Low: 10001000
- Register ID High: 10009000
- Year: 2020
- Start Month: 01
- End Month: 12

To convert data for registers whose IDs range from 1001000 to 1009000 for the months of January through May of 2020, you would set the parameters as follows:

- Register ID Low: 10001000
- Register ID High: 10009000
- Year: 2020
- Start Month: 01
- End Month: 05

Converting Interval Profile Data Sets

Interval profile data sets from Oracle Utilities Customer Care and Billing can be converted into measuring components and measurement data for use in Customer to Meter (and Customer Cloud Service).

Note: Refer to **Maintaining Interval Data** and **Maintaining Interval Profile Data** in the *Oracle Utilities Customer Care and Billing Administrative User Guide* for more information about interval profile data in Oracle Utilities Customer Care and Billing.

Interval Profiles should have been migrated to Interval Measuring Components as part of the Initial Master Data Conversion process (see [Initial Master Data Conversion](#)). Once the profiles have been converted, profile data can be converted to measurement data.

A batch control (see below) is used to convert interval profile data to the Customer to Meter (Customer Cloud Service) Measurement table. Processing can be defined for a specified year and month range, and optionally for a range of Register IDs.

Processing Notes:

- Only Profile Data Sets with a status of "Complete" will be converted. Data sets that have 'No Data' will be excluded from the conversion.
- No validation is performed on the interval profile data. All the interval profile data is assumed to be valid.
- If the **Data Set Type** is not defined for the profile data set, the converted measurements will have a Condition of "Regular".
- Profile data sets with a **Data Set Type** of "Estimated" will result in measurements with a Condition of "Estimated".
- If overlapping profile data sets are processed, the values from the data set with the latest Set Data Time are selected for the conversion.
- The conversion process will not fill-in data for periods without interval data.

Creation of records in the Measurement table is performed via an Insert Select of the Interval Profile Data, for a month's worth of data at a time, which will be immediately committed.

Conversion should only be run for a given range of Profile IDs for a given date range once. Attempting to convert the Profile IDs for the same date range multiple times can result in errors.

Data Conversion Batch Control

The Migrate Interval Profile Data Set (X1-MIGID) batch control performs processing for interval profile data set conversion.

The profiles to be converted for each batch run can be defined using the Interval Profile ID Low and Interval Profile ID High parameters. To process data for a single interval profile, you can set both of these parameters to the same Interval Profile ID. If neither parameter is defined, the process will convert data for all interval profiles.

The batch process can convert up to 1 year of data at a time, the specific year is designated by the Year parameter. The Start Month and End Month parameters can be used to further limit the time range for the conversion.

This batch control uses the following parameters:

- **Interval Profile ID Low:** Optional. Used to specify an ID value to override the low ID in the thread ID range calculation. This, along with the Interval Profile ID High be used to limit the number of records processed by each batch run. If not specified, the process will convert data for all interval profiles whose ID is lower than the Interval Profile ID High parameter (if defined).
- **Interval Profile ID High:** Optional. Used to specify an ID value to override the high ID in the thread ID range calculation. This, along with the Interval Profile ID Low, can be used to limit the number of records processed by each batch run. If not specified, the process will convert data for all interval profiles whose ID is higher than the Interval Profile ID Low parameter (if defined)
- **Year:** The year for which data will be converted. (Required)
- **Start Month:** The start month of the time range for which data will be converted. (Required)
- **End Month:** The start month of the time range for which data will be converted. (Required)
- **Clear Measurements:** Flag indicating whether or not to delete existing measurements within the date range

Examples:

To convert data for all interval profiles from the year 2020, you would set the parameters as follows:

- Year: 2020
- Start Month: 01
- End Month: 12

To convert data for all interval profiles for the months of January through May of 2020, you would set the parameters as follows:

- Year: 2020
- Start Month: 01
- End Month: 05

To convert data for interval profiles whose IDs range from 10001000 to 10009000 for from the year 2020, you would set the parameters as follows:

- Interval Profile ID Low: 10001000
- Interval Profile ID High: 10009000
- Year: 2020
- Start Month: 01
- End Month: 12

To convert data for interval profiles whose IDs range from 100100 to 100900 for the months of January through May of 2020, you would set the parameters as follows:

- Interval Profile ID Low: 10001000
- Interval Profile ID High: 10009000
- Year: 2020
- Start Month: 01
- End Month: 05

Converting Field Activities

Completed and inflight (activities that are in the "Pending" state) customer event orchestration events and field activities from Oracle Utilities Customer Care and Billing can be converted into corresponding field activity requests and service order activities and service order field activities for use in Customer to Meter (and Customer Cloud Service).

NOTE: Refer to **Service Orders** in the *Oracle Utilities Customer Care and Billing Administrative User Guide* for more information about field activities Oracle Utilities Customer Care and Billing. Refer to [Service Orders](#) in the *Business User Guide* for more information about service order activities and service order field activities in Customer to Meter and Customer Cloud Service.

A batch control (see below) is used to create new field activity requests and corresponding Service Order Management activities. Processing can be defined for a specified date range and optionally for activities of a specific status, and/or a range of field activity IDs.

Administration Data

Before this conversion process can be run, the Migrate Admin Data (X1-MIGAD) batch process must be run. Note that the **Inflight FA Configuration** section of the CCB/MDM/ODM Data Migration master configuration must be configured to map Customer Care and Billing field activity types to Field Task Types before the Migrate Admin Data batch process is run. See [Initial Master Data Conversion](#) for more information about the CCB/MDM/ODM Data Migration master configuration.

The Migrate Admin Data process performs the following field activity related steps:

- Creates Customer Care and Billing field activity types used as customer event orchestration in Service Order Management (such as SOM-STRT (Start Service), SOM-STOP (Stop Service), and so on).
- Creates Service Order Management service order activity types and service order field activity types (Enable Service, Disable Service, Field Activity, and so on).
- Creates a "Service Order Management Profile" (SOM) Field Activity Type Profile mapping Customer Care and Billing field activity types for customer event orchestration events, such as Enable Service, Disable Service, Back to Back, Cut for Non Payment and Reconnect for Payment to corresponding Service Order Management orchestration activity types
- Creates and/or updates the Field Activity Type Value in the C2M Mapping Field Values extendable lookup mapping Customer Care and Billing customer event orchestration field activity types to corresponding Service Order Management orchestration activity types
- Copies the CCB FA Cancel Reason to MDM FA Cancel reason extendable look-up
- Copies the CCB FA Reschedule Reason to MDM FA reschedule reason extendable look-up
- Creates outbound and inbound communication types (Field Activity Outbound Communication Type and Field Activity Inbound Communication Type).

The following administration data and configuration must be in place before the conversion process can be run:

- Customer Care and Billing field activity types for customer event orchestration events, such as Enable Service, Disable Service, Back to Back, Cut for Non Payment and Reconnect for Payment have been created and configured on the Field Activity Type Profile. This is done by the Migrate Admin Data batch process (see above).
- Meter Data Management/Service Order Management service order activity types have been created and mapped to the corresponding Customer Care and Billing customer event orchestration field activity types in the Field Activity Type value of the C2M Mapping Field Values extendable lookup (accessible from the **Customer and Device Value Mapping** section of the Cross Product Configuration master configuration). This is done by the Migrate Admin Data batch process (see above).
- Customer Care and Billing field activity types for specific tasks (such as "Reread meter") are mapped to the corresponding field task types (such as "Read Meter") in the Field Activity Type value of the C2M Mapping Field Values extendable lookup (accessible from the **Customer and Device Value Mapping** section of the Cross Product Configuration master configuration).

Processing Notes

- The Customer Care and Billing field activity will be identified as either an orchestrator or specific field activity via its relationship to the service agreement/service point or a severance event.
- Existing Customer Care and Billing field activities in the "Pending" and "Completed" states will be recreated and used linked to service order activities. This is important for inflight field activities created using Customer Care and Billing field activity templates and steps, which are retained because they provide a link to the field work application.
- When converting activities in the "Completed" state, only the service order activity or service order field activity will be created. The process does not create child activities or communications. For example, if converting a completed "Start Service" field activity, the result will be an "Enable Service" service order activity, but not its children service order field activities or outbound communications.
- The original Customer Care and Billing field activity will be captured on the corresponding service order activity and/or service order field activity to ensure a record of the original field activity that resulted in the creation of the new service order activity.
- The service order management communication business objects and algorithms have been updated to accommodate existing inflight Customer Care and Billing field activities. This includes providing for identifying outbound communications created based on the original Customer Care and Billing field activity, as well as receiving inbound communications and status updates based on the original Customer Care and Billing field activity.
- Customer Care and Billing field activities in the "Cancelled" and "Held" states will not be converted. If the batch process is submitted for Customer Care and Billing field activities in the "Held" state, the "Held" field activities will be deleted. Also, the conversion process will convert Customer Care and Billing field activities of types without a corresponding service order management activity type.

Conversion of field activities can be performed using a "staggered" approach by converting different type of field activities based on field activity status at different stage in the implementation. For instance, performing conversion of completed field activities first (though some implementations may opt not to migrate historical completed field activities at all), since these are static data, following by conversion of inflight field activities. In addition to status, field activity conversion may be staggered by field activity Id range or field activity Date range.

Data Conversion Batch Control

The Migrate Field Activity (X1-MIGFA) batch control performs processing for field activity conversion.

Field activities are converted based on their Status, and by date range. In addition, field activities to be converted for each batch run can be defined using the Low FA Id Override Value and High FA Id Override Value parameters. For instance, to convert a single activity, you can set both of these parameters to the same ID. If neither parameter is defined, the process will convert all field activities of the specified status for the specified date range.

This batch control uses the following parameters:

- **Low FA Id Override Value:** *Optional.* Used to specify an ID value to override the low ID in the thread ID range calculation. This, along with the High FA Id Override Value be used to limit the number of records processed by each batch run. If not specified, the process will convert all field activities whose ID is lower than the High FA Id Override Value parameter (if defined).
- **High FA Id Override Value:** *Optional.* Used to specify an ID value to override the high ID in the thread ID range calculation. This, along with the Low FA Id Override Value, can be used to limit the number of records processed by each batch run. If not specified, the process will convert all field activities whose ID is higher than the Low FA Id Override Value parameter (if defined)
- **FA Status (C/P/H):** The status ("Completed", "Pending", or "Held") for which field activities will be converted. (Required)
- **Start FA Date:** The start date of the time range for which field activities will be converted. (Required. If not provided defaults to earliest date)
- **End FA Date:** The start month of the time range for which field activities will be converted. (Required. If not provided defaults to the business date)

Examples:

To convert all Pending field activities for the month of July 2022, you would set the parameters as follows:

- FA Status (C/P/H): P
- Start FA Date: 2022-07-01
- End FA Date: 2022-07-31

To convert all Completed field activities for the months of April through June 2022, you would set the parameters as follows:

- FA Status (C/P/H): C
- Start FA Date: 2022-04-01
- End FA Date: 2022-06-30

To convert Pending field activities whose IDs range from 10001000 to 10009000 for the month of July 2022, you would set the parameters as follows:

- Low FA Id Override Value: 10001000
- High FA Id Override Value: 10009000
- FA Status (C/P/H): P
- Start FA Date: 2022-07-01
- End FA Date: 2022-07-31

To convert Completed field activities whose IDs range from 10001000 to 10009000 for the months of April through June 2022, you would set the parameters as follows:

- Register ID Low: 10001000
- Register ID High: 10009000
- FA Status (C/P/H): C
- Start FA Date: 2022-04-01
- End FA Date: 2022-06-30

Customer To Meter Table Setup Sequence

This section provides guidelines for setting up control tables and administrative data used with Oracle Utilities Customer To Meter.

Customer Care and Billing Control Table Setup Sequence

The topics in this section describe the order in which the control tables should be set up.

Core Control Table Setup Sequence

To implement the system, you must set up your organization's business rules in "control tables". Setting up these tables is time-consuming because we allow you to tailor many aspects of the system to meet your organization's requirements. We strongly recommend that you take the time to document how you plan to set up all of these tables before you use the following roadmap to enter the core control data. Time spent understanding the interrelationships between this data will reap the rewards of a clean system that meets your current and long term needs.

While we describe the transactions and options in more detail in other sections of this manual, use the following chart (and the remaining sections of this chapter) as your roadmap. Here we list the order in which you perform tasks and the pages you'll use to set up your system. The order is important because some information must exist before other information can be defined (i.e., many dependencies exist).

NOTE: Auto setup. The Auto Setup column in the following table contains suggestions to save you time. It also indicates if a control table contains information when the system is installed.

NOTE: You don't have to set up every control table. You need only set up those control tables that govern functions that are applicable to your organization.

Function	Menu	Auto Setup
Global Context		
Algorithm	Admin, Algorithm. You will need to set up an algorithm that populates global context values. The global context is used by various zones in the system to display relevant data. This algorithm is plugged-in on the installation record .	
Accounting Environment		
Country and State	Admin, Country	
Currency Codes	Admin, Currency Code	USD is automatically populated
Accounting Calendar	Admin, Accounting Calendar	
GL Division	Admin, General Ledger Division	
Security Environment		
Application Service	Admin, Application Service	All base package transactions are automatically populated
Security Type	Admin, Security Type	

User Group	Admin, User Group Note, you won't be able to set up users at this point	One user group, ALL_SERVICES, is automatically setup. It references all other application services and a single user called SYSUSER.
Language	Admin, Language	ENG is automatically populated
Display Profile	Admin, Display Profile	Two display profiles are automatically setup: NORTHAM displays currencies and dates in a classic American format; EURO displays information in a classic European format
Data Access Role	Admin, Data Access Role	
Access Group	Admin, Access Group	
User	Admin, User	SYSUSER is automatically set up. Note that you may import your users (and user groups) from an external source .
Return to User Group	You must return to your user groups and define all of their users	
Customer Class Environment		
Customer Class	Admin, Customer Class. At this point, you'll only be able to set up your customer class codes. You will return to these customer classes throughout the setup process to populate additional information.	
Financial Transaction Environment		
Work Calendar	Admin, Work Calendar	
CIS Division	Admin, CIS Division	
Revenue Class	Admin Revenue Class	
Algorithm	Admin, Algorithm. You will need to set up the algorithm that constructs a distribution code's corresponding GL account when it is interfaced to the general ledger	
Distribution Code	Admin, Distribution Code	
Bank and Bank Accounts	Admin, Bank	
Billable Charge Template	Admin, Billable Charge Template. Note, if you want the system to default service quantities onto billable charges created using this template, you must setup the appropriate unit of measure code, time-of-use code and/or service quantity identifier.	
Billable Charge Upload Line Type	Admin, Billable Charge Line Type	
Algorithm	Admin, Algorithm. You will need to set up several algorithms. These algorithms: 1) retrieve a bill segment's consumption, 2) calculate a bill segment's bill lines, 3) construct a bill segment's financial transaction, 4) cancel previously estimated bill segments	

Bill Segment Type	Admin, Bill Segment Type
Algorithm	Admin, Algorithm. You may want to set up an algorithm that formats the Bill Segment information that is displayed throughout the system for a specific Bill Segment Type. This algorithm is plugged-in on the Bill Segment Type.
Algorithm	Admin, Algorithm. You will need to set up the algorithm that constructs a payment segment's financial transaction
Payment Segment Type	Admin, Payment Segment Type
Algorithm	Admin, Algorithm. You will need to set up the algorithm that constructs an adjustment's financial transaction
Algorithm	Admin, Algorithm. Several plug-in spots are available to perform additional logic when processing adjustments. For example, if you have the system calculate adjustments, you must set up an adjustment generation algorithm. Refer to Adjustment Type for other available plug-in spots that may be used by your implementation.
Algorithm	Admin, Algorithm. You may want to set up an algorithm that formats the Adjustment information that is displayed throughout the system for a specific Adjustment Type. This algorithm is plugged-in on the Adjustment Type .
Algorithm	Admin, Algorithm. You may want to set up an algorithm that formats the Adjustment information that is displayed throughout the system. This algorithm is plugged-in on the installation record .
Adjustment Type	Admin, Adjustment Type
Adjustment Type Profile	Admin, Adjustment Type Profile
Approval Profile	Admin, Approval Profile. Note, an approval profile references a To Do type and one or more To Do Roles; these must be set up before you can set up the approval profile. After the approval profile(s) are set up, they must be referenced on the adjustment types that they govern.
Cancel Reason - Bill	Admin, Bill Cancel Reason
Cancel Reason - Payment	Admin, Payment Cancel Reason
Cancel Reason - Adjustment	Admin, Adjustment Cancel Reason
Tender Type	Admin, Tender Type
Tender Source	Admin, Tender Source
A/P Request Type	Admin, A/P Request Type

Issuing Center	Admin, Issuing Center. You will need to set up issuing centers if your organization assigns document numbers to bills.
Installation	Admin, Installation Options - Framework and Admin, Installation Options. Many fields on the installation record impact the financial transaction environment. Refer to the description of the Billing and Financial Transaction tabs and the Messages tab in the Framework page for more information.
Algorithm	Admin, Algorithm. You will need to set up an algorithm that distributes payments.
Algorithm	Admin, Algorithm. You will need to set up an algorithm that handles overpayment situations.
Algorithm	Admin, Algorithm. You may need to set up an algorithm if specific customers can have individual bill due dates.
Algorithm	Admin, Algorithm. You may need to set up an algorithm if you want the system to delete bills that contain only information about historical payments.
Algorithm	Admin, Algorithm. You may need to set up an algorithm if you want the system to levy a non-sufficient funds charge if a payment is canceled due to non-sufficient funds.
Algorithm	Admin, Algorithm. You will need to set up an algorithm that formats the bill information that is displayed throughout the system. This algorithm is plugged-in on the installation record .
Algorithm	Admin, Algorithm. You will need to set up an algorithm that formats the payment information that is displayed throughout the system. This algorithm is plugged-in on the installation record .
Algorithm	Admin, Algorithm. You will need to set up an algorithm that defaults the amount when a payment is manually added. This algorithm also calculates the amount of an automatic payment for a bill for an account with an active auto pay option. This algorithm is plugged-in on the installation record .
Algorithm	Admin, Algorithm. Refer to Customer Class for other available plug-in spots that may be used by your implementation to perform additional logic when processing payments and bills.
Return to Customer Class	Admin, Customer Class. You will need to plug-in the algorithms defined above on your customer classes.

Budget Environment

Algorithm	Admin, Algorithm. You will need to set up several algorithms at this time: How To Calculated The Recommended Budget Amount, How To Periodically True Up A Customer's Budget Amount, The Circumstances When The System Should Highlight A Customer As Having An Anomalous Budget.
-----------	--

Budget Plan	Admin, Budget Plan
-------------	--------------------

Algorithm	Admin, Algorithm. Budget eligibility is set at the SA type level. You will need to set up an override budget eligibility algorithm if some service agreements for an SA type are not eligible for budget based on certain conditions.
-----------	---

Customer Environment

Account Management Group	Admin, Account Management Group. Note, you will probably have to set up To Do Type and To Do Roles before you can setup account management groups. Refer to Assigning A To Do Role for more information on how account management groups may be used to define an entry's role.
--------------------------	---

Account Relationship	Admin, Account Relationship Type
----------------------	----------------------------------

Alert Type	Admin, Alert Type
------------	-------------------

Bill Message	Admin, Bill Message
--------------	---------------------

Algorithm	Admin, Algorithm. If you have software that's capable of reconstructing an image of a bill in a PDF (for the purpose of online display), you will need to create an algorithm that formats the extract records that are sent to your bill image software.
-----------	---

Bill Route Type	Admin, Bill Route Type
-----------------	------------------------

Contract Quantity Type	Admin, Contract Quantity Type
------------------------	-------------------------------

Algorithm	Admin, Algorithm. If you have software that's capable of reconstructing an image of a letter in a PDF (for the purpose of online display), you will need to create an algorithm that formats the extract records that are sent to your letter image software.
-----------	---

Letter Template	Admin, Letter Template
-----------------	------------------------

Customer Contact Class	Admin, Customer Contact Class
------------------------	-------------------------------

Customer Contact Type	Admin, Customer Contact Type
-----------------------	------------------------------

Conservation Programs	Admin, Conservation Program. You will need to set up conservation programs if your organization provides rebates to customers based on eligibility and verification of newly
-----------------------	--

	purchased appliances and hardware that are rated to conserve the demand for energy.
Algorithm	Admin, Algorithm. You may need to set up the algorithms that determine if person ID's are in a predefined format.
Person Identifier Type	Admin, Person Identifier Type
SICs	Admin, SIC Code
Tax Exempt Type	Admin, Tax Exempt Type
Algorithm	Admin, Algorithm. You may need to set up the algorithms that determine if phone numbers are in a predefined format.
Phone Type	Admin, Phone Type.
Person Relationship Type	Admin, Person Relationship Type.
Algorithm	Admin, Algorithm. You will need to set up an algorithm that formats the person information that is displayed throughout the system. This algorithm is plugged-in on the installation record .
Algorithm	Admin, Algorithm. You will need to set up an algorithm to validate a person's name. This algorithm is plugged-in on the installation record .
Algorithm	Admin, Algorithm. You can override the system's standard account information string by setting up an algorithm that produces this string of information. This algorithm is plugged-in on the installation record .
Algorithm	Admin, Algorithm. If you have software that's capable of reconstructing an image of a bill in a PDF for the purpose of online display, you will need to create an algorithm that renders this PDF. This algorithm is plugged-in on the installation record .
Installation	Admin, Installation Options. Many fields on the installation record impact the Customer Environment. Refer to the description of the Main , Person , and Account tabs for more information.
Statements	
Algorithm	Admin, Algorithm. If you have software that's capable of reconstructing an image of a statement in a PDF (for the purpose of online display), you will need to create an algorithm that formats the extract records that are sent to your statement image software.
Statement Route Type	Admin, Statement Route Type
Statement Cycle	Admin, Statement Cycle

Algorithm	Admin, Algorithm. If you have software that's capable of reconstructing an image of a statement in a PDF for the purpose of online display, you will need to create an algorithm that renders this PDF. This algorithm is plugged-in on the installation record .
<hr/>	
Automatic Payment (EFT) Environment	
Algorithm	Admin, Algorithm. You will need to set up an algorithm to create automatic payments. This algorithm is plugged-in on the installation record .
<hr/>	
Tender Source	Admin, Tender Source Note: earlier, you created tender sources for the remittance processor and your cash drawers. At this point, you'll need to add at least one tender source for automatic payments. Why? Because automatic payments get linked to a tender control (which, in turn, gets linked to a tender source) when they are interfaced out of the system.
<hr/>	
Algorithm	Admin, Algorithm. You will need to set up the appropriate automatic payment date calculation algorithm to populate the extract, GL interface and payment dates on automatic payments.
<hr/>	
Auto Pay Route Type	Admin, Auto Pay Route Type
<hr/>	
Tender Type	Admin, Tender Type Note: earlier, you created tender types for things like cash, checks, etc. At this point, you'll need to add a tender type for each type of automatic payments (e.g., direct debt, credit card, etc.).
<hr/>	
Work Calendar	Admin, Work Calendar. You need only set up additional work calendars if the auto pay sources (i.e., the financial institutions) have different working days than does your organization
<hr/>	
Algorithm	Admin, Algorithm. If you need to validate the customer's bank account or credit card number, you will need to set up the appropriate validation algorithms.
<hr/>	
Auto Pay Source Type	Admin, Auto Pay Source Type
<hr/>	
Algorithm	Admin, Algorithm. You may need to set up an algorithm if your customers can define a maximum withdrawal limit on their autopay options.
<hr/>	
Return to Customer Class	Admin, Customer Class. You should plug-in the Autopay Over Limit Algorithm in each appropriate customer class.
<hr/>	

Deposit Environment

Algorithm	Admin, Algorithm. You will need to set up several algorithms at this time: The Definition Of A Good Customer, When To Refund A Deposit To A Customer, When To Recommend An Additional Deposit, How / When To Calculate Interest, How To Generate The Recommended Deposit Amount.
Deposit Class	Admin, Deposit Class
Non Cash Deposit Type	Admin, Non Cash Deposit Type
Field Work Environment	
Field Activity Type and Steps	Admin, Field Activity Type
Field Activity and Field Order Cancellation Reason	Admin, Fieldwork Cancel Reason
Field Activity Type Profiles	Admin, Field Activity Type Profile
Algorithm	Field activities for Start/Stop will only be created if the SA Type linked to the service point has a SASP field work creation algorithm. Refer to the SA Type section below.
Algorithm	Admin, Algorithm. If you have software that's capable of reconstructing an image of a field order in a PDF for the purpose of online display, you will need to create an algorithm that renders this PDF. This algorithm is plugged-in on the installation record .
Credit & Collections Environment (if you collect on overdue bills (as opposed to overdue debt), you will NOT set up these tables; refer to Overdue Processing - Set Up Tasks for the list of control tables required to collect on overdue bills)	
Algorithm	Admin, Algorithm. You may need to set up algorithms if you have non-standard collection events.
Collection Event Type	Admin, Collection Event Type
Algorithm	Admin, Algorithm. You may need to set up a collection process cancellation algorithm if your organization allows individual service agreements to be removed from a collection process if they are paid (rather than performing cancellation based on all SAs in a debt class).
Collection Process Template	Admin, Collection Process Template
Collection Class	Admin, Collection Class
Algorithm	Admin, Algorithm. You will need to set up several algorithms at this time: Collection process cancellation criteria, Severance process cancellation criteria, and Override arrears due to pay plans.

Debt Class	Admin, Debt Class
Write Off Debt Class	Admin, Write Off Debt Class
Algorithm	Admin, Algorithm. You will need to set up Collection Condition algorithms.
Collection Class Control	Admin, Collection Class Control
Algorithm	Admin, Algorithm. You may need to set up algorithms if you have non-standard severance events.
Severance Event Type	Admin, Severance Event Type
Algorithm	Admin, Algorithm. You may need to set up a severance process cancellation algorithm if your organization allows a severance process to be canceled when the related service agreement is paid (rather than performing cancellation based on all SAs in a debt class).
Severance Process Template	Admin, Severance Process Template
Algorithm	Admin, Algorithm. You will need to set up several algorithms at this time: How to refer debt to a collection agency, How to transfer debt to another active service agreement, How to write down small amounts of debt, and How to refund credit balances to a customer.
Algorithm	Admin, Algorithm. You may need to set up algorithms if you have non-standard write-off events.
Write Off Event Type	Admin, Write Off Event Type (Note, you'll have to wait until you have defined your SA Types before you can set up the Write Off Events because SA Type is a necessary parameter to write off debt).
Write Off Process Template	Admin, Write Off Process Template
Write Off Control	Admin, Write Off Control
Collection Agency	Admin, Collection Agency. Note, each collection agency references a person therefore you must set up a person for each agency before you can enter collection agency information.
Algorithm	Admin, Algorithm. You may need to set up algorithms if you have special logic that should be executed when a pay plan is canceled.
Pay Plan Type	Admin, Pay Plan Type
Payment Method	Admin, Payment Method
Third Party Payor	Admin, Third Party Payor. Note, you must create an account before you can create a third party payor.

Installation	Admin, Installation. Several fields on the installation record impact the Credit & Collections Environment.	
Algorithm	Admin, Algorithm. You will need to setup an algorithm that's called when a user write-off debt real time.	
Return to Customer Class	Admin, Customer Class. You should plug-in the Autopay Over Limit Algorithm in each appropriate customer class.	
Services and Characteristics		
Service Type	Admin, Service Type	
Algorithm	Admin, Algorithm. If you have ad hoc characteristic types, you may need to set up the algorithms that control how they are validated	
Foreign Key Reference	Admin, FK Reference. If you have foreign key characteristic types, you may need to set up foreign key references to control how the user selects the characteristic values (and how the foreign key values are validated).	All base package FK references are automatically populated
Characteristic Type and Values	Admin, Characteristic Type	
Meter and Item Environment	Refer to the Meter Data Management Configuration Setup Sequence for control tables used with Meter Data Management, and configure the control tables as specified in this section.	
Premise and Service Point Environment		
Premise Type	Admin, Premise Type	
Algorithm	Admin, Algorithm. You will need to set up an algorithm to format the standard premise info that appears throughout the system. This algorithm is plugged-in on the installation record .	
Algorithm	Admin, Algorithm. You will need to set up an algorithm that formats the service point information that is displayed throughout the system. This algorithm is plugged-in on the installation record .	
Algorithm	Admin, Algorithm. You may need to set up the algorithms that determine if geographic ID's are in a predefined format.	
Geographic Type	Admin, Geographic Type	
Service Point Type	Admin, SP Type. [Note - you won't be able to define the SP Type's SA Types until after you define the SA Types or the FA Type Profiles until after you define the Field Activity Type Profiles.]	
Bill and Service Cycle Environment		
Bill Cycle, Bill Cycle Schedule	Admin, Bill Cycle	
Bill Period, Bill Period Schedule	Admin, Bill Period	

Rate Environment

Frequency	Admin, Frequency	
Service Quantity Identifier	Admin, Service Quantity Identifier	
Algorithm Type	Admin, Algorithm Type. If you create new pre-processing calculation rules, you must set up an algorithm type for each such rule (the algorithm type defines the types of parameters that are passed to the calculation rule).	All base package algorithm types are automatically populated
Bill Factor	Main, Rates, Bill Factor	
Algorithm Type	Admin, Algorithm Type. If you create new Register Rules you must set up an algorithm type for each such rule (the algorithm type defines the types of parameters that are passed to the register rule).	All base package algorithm types are automatically populated
Rate	Main, Rates, Rate Schedule	
Calculation Group	Main, Rates, Calculation Group	
Algorithm	Admin, Algorithm. If you use algorithms to dynamically change step boundaries, calculate prices, or implement calculation rule eligibility rules, you must set up these algorithms.	
Calculation Rule	Main, Rates, Calculation Rule	
Bill Factor Value	Main, Rates, Bill Factor Values	
Bill Factor Interval Values	Main, Rates, BF Interval Values	
Item Type SQ Estimate	Admin, Item Type SQ Estimate	
Degree Day	Admin, Degree Days	
Late Payment Environment		
Algorithm	Admin, Algorithm. You will need to set up the algorithm that determine if customers in a customer class are eligible for late payment charges	
Algorithm	Admin, Algorithm. You will need to set up the algorithm that levies late payment charges for customers in a customer class	
Return to Customer Class	Admin, Customer Class. You will need to plug-in the late payment charge algorithms set up above.	
SA Configuration		
Algorithm	Admin, Algorithm. You will need to set up the algorithms that determine: <ul style="list-style-type: none">• How to calculate the late payment charge amount for service agreements of a given type• Special criteria to be tested before a service agreement is severed.	

- How to create field activities for service agreements of a given type.
- Special processing that should take place prior to the completion of a bill that references service agreements of a given type.
- Special processing that should take place during completion of a bill that references service agreements of a given type.
- Special processing that should take place when service agreements of a given type are created.
- Special processing that should take place when a financial transaction is frozen for service agreements of a given type.

Algorithm	Admin, Algorithm. You may want to set up an algorithm that formats the SA information that is displayed throughout the system. This algorithm is plugged-in on the installation record .
Algorithm	Admin, Algorithm. You may want to set up an algorithm that formats the SA information that is displayed throughout the system for a specific SA Type. This algorithm is plugged-in on the SA Type .
Algorithm	Admin, Algorithm. If you want a Control Central alert to highlight when the current account has any stopped service agreement(s), you will need to set up the algorithm that does this. This algorithm is plugged-in on the installation record .
Service Agreement Type	Admin, SA Type
Terms and Conditions	Admin, Terms and Conditions
SA Type Start Options	Admin, SA Type Start Option
Update SP Types with initial SA types and with FA Type Profiles	Admin, SP Type
SA Relationships	
SA Relationship Type	Admin, SA Relationship Type
Service Provider	Admin, Service Provider. Note, you must create a person before you can create a service provider. If you have financial relationships (you bill for them or they bill for you), you must also create an account and a financial settlement service agreement before you can create the service provider.
SA Type / SA Relationship	Admin, SA Type SA Relationship Type
Service Provider.	Admin, Service Provider. Note, you must create a person before you can create a service provider.

Sales and Marketing

Order Hold Reason	Admin, Order Hold Reason
Order Cancel Reason	Admin, Order Cancel Reason
And more...	Refer to Campaign and Package Setup Sequence for additional setup requirements
Service Credit Membership	
Algorithm	Admin, Algorithm. You may need to set up algorithms for the service credit membership type and service credit event type to control behavior for the service credit membership and its events.
Credit Unit	Admin, Credit Unit. If your service credits record non-monetary units.
Service Credit Membership Type	Admin, Service Credit Membership Type
Service Credit Event Type	Admin, Service Credit Event Type
Membership Inactive Reasons	Admin, SC Membership Inactive Reason
Wrap Up	
Algorithm	Admin, Algorithm. You will need to set up the algorithms that determine: #x2022; Special alerts on Control Central (assuming you have special alerts)
Installation Options	Admin, Installation Options - Framework and Admin, Installation Options. At this point, it's a good idea to double-check everything on the installation record.
Postal Default	Admin, Postal Code Default

If you have cash drawers you will also need to set up the following information:

- Create a person / account to which you will link your over / under service agreement. Refer [How To Get An Unbalanced Tender Control In Balance \(Fixing Over/Under\)](#) for more information.
- Create a service agreement to which your over/under payments will be linked. This service agreement will reference your over / under SA type. Refer to [Over / Under Cash Drawer Segmentation](#) for more information.

If you upload payments from an external source (e.g., a remittance processor or lock box), you must set up the following information:

- Create a person and account to which the system will link payments with invalid account. Refer to [Phase 3 - Create Payment Events, Tenders, Payments and Payment Segments](#) for information about the process that books invalid payments to this account. Refer to [How To Transfer A Payment From One Account To Another](#) for how a user transfers the payment from the invalid account to the correct account (once known).
- Create a service agreement for this account. This service agreement will reference your payment suspense SA type. The system needs this service agreement so that it can distribute the invalid account's payment (and this is necessary so that cash will reflect the payment). Refer to [Payment Upload Error Segmentation](#) for more information.
- Update the tender source associated with the respective source of payments to indicate the service agreement created in the previous step should be used for payments with invalid accounts. Refer to [Setting Up Tender Sources](#) for more information.

- Because the payment upload process simply books payments that reference invalid accounts to the account associated with the suspense service agreement on the payment's tender source, this account should belong to a customer class with the appropriate payment distribution algorithms. This may entail creating a new customer class that will only be used on suspense accounts. This customer class would need the following algorithms:
- We'd recommend using a simple payment distribution algorithm like PYDIST-PPRTY (distribute payment based on SA type's payment priority).
- We'd recommend using an overpayment distribution algorithm like OVRPY-PPRTY (distribute overpayment to highest priority SA type).

The remaining sections describe additional control tables that must be set up for specific functional areas.

Cross-Reference To The Remaining Chapters

The table in the previous section describes the order in which you should enter your control tables. These tables are described at length in the following chapters.

- Refer to [Defining General Options Addendum](#) and [Defining General Framework Options](#) for a discussion of the control tables associated with general functionality (e.g., country codes, state codes, etc.).
- Refer to [Defining Financial Transaction Options](#) for a discussion of the tables affecting your financial transactions (e.g., bill segment types, payment segment types, etc.)
- Refer to [Defining Customer Options](#) for a discussion of the control tables affecting persons, accounts and service agreements.
- Refer to [Defining Service Order Options](#) for a discussion of the control tables affecting fieldwork.
- Refer to [Defining Credit and Collections Options](#) for a discussion of the control tables affecting your collection activities.
- Refer to [Defining Device Options](#) for a discussion of the control tables affecting your meters and items.
- Refer to [Defining Device Installation Options](#) for a discussion of the control tables affecting your premises and service points.
- Refer to [Defining Cycles and Schedules](#) for a discussion of the control tables affecting your cyclical processes.
- Refer to [Rates](#) for a discussion of the control tables affecting your rates.
- Refer to [Defining SA Type Options](#) for a discussion of the control tables affecting your service agreement types.
- Refer to [Defining Background Process](#) for a discussion of the control tables affecting your background processes.
- Refer to [Defining Algorithms](#) for a discussion of the control tables affecting the algorithms referenced on many control tables.
- Refer to [Defining SA Relationships](#) for a discussion of the control tables affecting the relationships between service providers.
- Refer to [Statements](#) for a discussion of the tables affecting the statement setup options for your customers.
- Refer to [Defining Service Credit Options](#) for a discussion of the tables affecting the service credit membership setup options for your customers.

Open-Item Accounting Table Setup Sequence

Open-item accounting tables need only be set up if your organization practices [Open Item Accounting](#). Refer to [Setting Up The System To Enable Open Item Accounting](#) for a description of the tables that must be set up to enable this functionality.

Fund Accounting Table Setup Sequence

Fund accounting tables need only be set up if your organization practices [Fund Accounting](#). Refer to [Setting Up The System To Enable Fund Accounting](#) for a description of the tables that must be set up to enable this functionality.

Payment Event Distribution Table Setup Sequence

Payment event distribution tables need only be set up if your organization opted to use the distribution rules method to create payment events. Refer to [Setting Up The System To Use Distribution Rules](#) for a description of the tables that must be set up to enable this functionality.

Loans Table Setup Sequence

Loans need only be set up if your organization offers [loans](#) to your customers. Refer to [Setting Up The System To Enable Loans](#) for a description of the tables that must be set up to enable this functionality.

Quotes Table Setup Sequence

Quotes need only be set up if your organization sends quotes to customers or prospects. Refer to [Defining Quotation Options](#) for a description of the tables that must be set up to enable this functionality.

Non-Billed Budget Table Setup Sequence

[Non-Billed Budgets](#) need only be set up if your organization allows your customers to pay set amounts at specified intervals (e.g. every two weeks). Refer to [Setting Up The System To Enable Non-Billed Budgets](#) for a description of the tables that must be set up to enable this functionality.

Scripting Table Setup Sequence

Scripts need only be set up if your organization opts to create [scripts](#) to step your users through business processes. Refer to [Defining Script Options](#) for information about scripting and the tables that must be set up to enable this functionality.

Reports Setup Sequence

In order to use the reporting tool, you will need to set up reporting options. Refer to [Configuring The System To Enable Reports](#) for more information.

External Messages Setup

To configure the system to communicate with an external system, refer to [External Messages](#).

Case Management Setup Sequence

Case management options need only be set up if your organization uses cases to manage issues. Refer to [Setting Up Case Types](#) for more information.

Umbrella Agreement Management Setup Sequence

Umbrella agreement management options need only be set up if your organization uses umbrella agreements to manage contracts. Refer to the integration documentation for more information.

Outage Management Setup Sequence

Outage management options need only be set up if your organization interfaces with Oracle Utilities Network Management System. Refer to the integration documentation for more information.

Prepaid Metering Setup Sequence

Prepaid metering options need only be set up if your organization offers prepaid metering service to your customers. Refer to [Defining Prepaid Metering Options](#) for more information.

Zone Set Up

Most zones are delivered with the base-package and do not require any configuration. However, some zones are only available if configured by your implementation. Refer to [Configuring Zones](#) for more information.

To Do Options Setup

Refer to [Setting Up To Do Options](#) for more information on how to configure the system to match your organization's To Do management needs.

Meter Data Management Configuration Setup Sequence

This section provides the suggested order for the setup of Meter Data Management and Smart Grid Gateway administrative data.

	Entity	Description
1	Feature Configuration	These are options that can be set to impact system processing. Typically these have wide ranging impact across several modules (e.g., multi-time zone support)
1	Country	Your organization's country.
1	Currency	Your organization's native currency.
1	Display Profile	Controls how dates, times, and numbers displayed.

1	Language	The language to use for this implementation.
1	Time Zone	Your organization's base time zone.
1	Work Calendar	The work calendar for your organization, which identifies your public holidays.
2	Installation Options	Control various global aspects of the system.
2	To Do Role	Used to associate users with To Do entries.
2	To Do Type	Used to define types of To Do Entries.
3	User	Defines a user's user groups, data access roles, portal preferences, default values, and To Do roles.
3	User Group	A group of users who have the same degree of security access.
3	Service Type	Defines specific types of service for which usage can be recorded and captured (electric, gas, steam, etc.).
4	Division	Delineates between different operating companies within a large conglomerate of utilities.
4	Unit of Measure	Quantities measured and recorded by the system (CCF, KWH, KW, etc.).
4	Service Quantity Identifier	Used to further distinguish between measured quantities that have identical UOM/TOU combinations.
4	Time of Use	Modifiers for a given unit of measure that indicate a period of time during which a quantity has been used (On- Peak, Off-Peak, etc.).
4	Factor	Centrally stored sets of values for use in validation rules, bill determinants calculations, and other processes.
4	Market	Defines jurisdictions or regulatory environments in which a Service Point participates.
4	Measurement Cycle	Defines the schedule for manual meter reading of devices at Service Points in that cycle
4	Measurement Cycle Schedule	Define the dates on which devices are scheduled to be read for a given measurement cycle.
4	Outbound Message	Defines messages sent to external systems.
4	Processing Timetable Type	Defines types of schedules that can be referenced by different processes and objects.
5	External System	Defines External Systems with which Oracle Utilities Meter Data Management should be able to communicate.
6	Head End Systems External Applications Market Participants	External entities that serve various roles relative to the application (head-end systems, billing systems, market participants, outage management systems, etc.).
6	Contact Type	Defines properties of a class of entities (businesses, persons).
7	Activity Type	Defines properties common to a specific type of activity.
7	Communication Type	Define properties common to a specific type of communication.
7	Service Task Type	Defines specific types of tasks performed by external users (self-service meter reads, self-service outage notifications, etc.)

7	Dynamic Option Type	Defines information common to dynamic options of a specific type.
7	Manufacturer	Individual companies that makes devices. Manufacturers also reference models.
7	Exception Type	Defines properties common to VEE Exceptions of a specific type.
8	VEE Group	Collections of VEE Rules that are applied to initial measurement data.
9	VEE Rule	Standard and custom VEE Rules that perform checking and/or manipulation of initial measurement data.
10	VEE Eligibility Criteria	Dictates whether a VEE Rule can execute based on a set of defined criteria.
11	Measuring Component Type	Defines the most important properties of a measuring component.
11	Measuring Component Comparison Type	Defines details by which measuring component data can be compared to determine the days that most closely resemble a specific day being evaluated.
12	Device Configuration Type	Defines properties of Device Configurations of a given type.
13	Device Type	Defines information about a class of devices.
14	Service Point Type	Defines specific types of points at which service is delivered.
14	Service Point Quantity Type	Defines types of quantities that can be stored for a service point.
14	Usage Subscription Quantity Type	Defines types of quantities that can be stored for a usage subscription.
15	TOU Group	Used to limit the set of Time Of Uses that are usable in a TOU schedule.
16	TOU Map Template	Schedules used for TOU map data generation.
17	TOU Map Type	Define important properties of TOU maps of a given type.
18	Usage Transaction Exception Type	Defines properties common to Usage Transaction Exceptions of a specific type.
18	Usage Calculation Group	Collections of usage calculation rules that are applied to measurement data to calculate bill determinants for Usage Subscriptions.
19	Usage Calculation Rule	Defines rules that perform calculations on measurement data to generate bill determinants and other values used by external systems.
20	Usage Calculation Rule Eligibility Criteria	Dictates whether a usage calculation rule can execute based on a set of defined criteria.
21	Usage Subscription Type	Defines collections of properties common to a set of Usage Subscriptions.
22	Data Source	Defines the source of data for dynamic aggregation, such as measurement data from usage subscriptions linked to a service point, badged or unbadged items, or measuring component sets
22	Dynamic Aggregation Measuring Component Type	Define the most important properties of a measuring component used with dynamic aggregation.
22	Measuring Component Set	Define the dimensions and criteria by which dynamic aggregation will be performed.
22	Aggregation Group	Define the ordering of a series of related aggregations based on a set of configured measuring component Sets.

23	Settlement Subscription Type	Defines collections of properties defining a class of settlement subscriptions.
23	Settlement Unit	Defines the “lowest common denominator set” of dynamic aggregation dimensions.
23	Settlement Calculation Group	Defines collections of settlement calculation rules that are used to perform settlement calculations, including calculating service point quantities, totaling consumption and usage for settlement units, application of losses, and allocation of unaccounted for energy (UFE).
23	Settlement Calculation Rule	Defines rules that perform settlement calculations, including calculating service point quantities, totaling consumption and usage for settlement units, application of losses, and allocation of unaccounted for energy (UFE).
23	Settlement Item Type	Defines specific types of end-customer settlement accounts.
23	Market Contract Type	Defines specific types of market contracts used in settlement processing.
23	Market Product Set	Defines the highest level grouping for a set of market products that will be processed together.
23	Market Product Type	Define types of products used in settlement processing.
23	Attribute Data Snapshot	Define types of attribute data snapshots used in settlement processing.
23	Measurement Data Snapshot	Define types of measurement data snapshots used in settlement processing.
24	Processing Methods	Control various behaviors for external applications, head end systems, and market participants within the system such as which message is sent, how an external value is translated, among others.
24	Master Configuration	Configuration that applies to series of modules that acts as a central point of configuration rather than embedding repetitive configuration throughout a set of algorithms.
24	Information Lifecycle Management	Information Lifecycle Management (ILM) is designed to address data management issues, with a combination of processes and policies so that the appropriate solution can be applied to each phase of the data’s lifecycle.
24	Analytics	Defines the extract parameters, the bucket configurations and configuration snapshots used for extracting data for Oracle Utilities Analytics

Operational Device Management Table Setup Sequence

This section provides the suggested order for the setup of Operational Device Management administrative data.

Sequence	Entity	Description
1	Configuration Type	Defines the information required for various asset configurations with other assets, components, firmware, and other data.
1	Service History Questions	Used to guide workers through corrective and preventive inspection processes as part of an asset’s service history.

1	Service History Type	Defines the main attributes for service history of a certain type. Types might include maintenance, inspection, service, test, measurement, and so on.
2	Asset Location Type	Defines the details of asset or component locations of a certain type. Valid types of asset locations can include service points, other locations for installed assets, or any other location as defined by your organization.
2	Out of Service Location Type	Defines attributes of types of locations where assets that are out of service are stored and maintained. Examples of out of service locations include warehouses, storerooms, and repair shops.
2	Organization	Used for categorization and reporting for locations.
2	Configuration	Documents and manages valid setups for assets and components. This includes a specification for each asset or component in the configuration as well as the valid value for each parameter, such as the firmware version of each asset.
3	Out of Service Location	Defines physical locations where assets are stored or repaired such as a storeroom, warehouse, or service facility. When assets are changed to statuses such as "In Repair" or "Pending Disposition" the asset location is typically moved to an out of service location.
3	Configuration Reports	Provides a summary of currently installed configurations.
4	Asset Type	<p>Defines the attributes for assets and components of a certain type, including information such as the valid location types and service history types for the assets and whether or not such assets can have attached components.</p> <p>When setting up Asset Types, asset type codes should match corresponding device type codes in Meter Data Management (see Meter Data Management Table Setup Sequence).</p>
5	Asset Activity Type	<p>Defines the attributes for asset activities of a certain type, including scheduling information, exception handling, attachments, and related completion event types.</p> <p>NOTE: Asset activity types are automatically created when Service Order Management Field Task Types are created (values for the Field Task Type extendable lookup).</p>
5	Asset Completion Event Type	Define various processes or events to be executed when completing an asset activity such as asset replication, service history creation, attachment creation, and activity creation.
5	Asset Inbound Communication Type	Defines the information required for the system to receive messages from external systems.

Understanding Online / Batch Loaders

Online / Batch Loaders enable the quick loading of data into the system. Data can be loaded for any business object as it uses the business object's schema to load data into the application.

Note: We recommend that this process not be used to load data for objects maintained through merged maintenance, such as Service Type, Unit of Measure, Service Quantity Identifier, Time of Use, Service Point Type, or Service Point as this process may not properly populate data for all maintenance objects supported by merged maintenance.

Two types of loaders are supported:

- **Online Loaders** easily upload smaller amounts of data. Use this type of upload process when uploading small numbers of records or data for business objects without complex lifecycles and business object rules such as Organizations. The data is loaded through the user interface to create the target objects.
- **Batch Loaders** should be used for larger volumes of data and for complex business objects such as Assets. Batch loaders load data from files on the server or attachments. Batch loaders use a two-step process that first creates the inbound sync request and uploads the file to a staging table and secondly, uploads the sync request from the staging table to either create the target objects or create another dedicated inbound sync request that handles the complexity of a particular object.

Processing uses the creation of a request type to facilitate the upload process:

- For online request types, the actual data is stored within and processed by the request.
- For batch request types, two options for batch load are supported; from a file located on the server or from an attachment in the application. Either the file name (file on server) or the attachment id (attachments) is stored on the request, the data is loaded into the generic inbound sync requests, and the request acts as a header record for all the generic inbound sync requests.

A csv file is the format used for loading data (see **Creating CSV Files**, below). The loader has very strict requirements as to the format of the file. Please see the embedded help in the **Data** section on the Online Loader Request business object for details and additional tips.

Creating CSV Files

While data can be manually entered into the system, the most efficient method for uploading the data is to use one of the CSV data templates already available for all appropriate business objects.

The first step is to create a .csv file (comma delimited) from the business object of the portal being loaded.

The following is an example using Organization (W1-Organization):

1. Navigate to **Admin**, select **Location**, select **Organization**, and then select **Search**.
2. Search for and select a record.
3. Expand the **Record Information** section and click the "Organization" **Business Object** link to navigate to the **Business Object** portal.
4. Click the **View Schema** link on the **Main** tab and then copy the elements from the business object to a CSV file to create your data.

1	Sequence	Primary Key	Field 01	Field 02	Field 03
2	1	Organization	Organization Type	Disposition	description
3	2	nodeId	nodeType	nodeDisposition	description
4	3		Group	W1AC	Group 1
5	4		Group	W1AC	Group 2

Notes:

- Columns in the top row match the elements in the list of the request business object (header).
- The row with the lowest sequence number (1) is the description of xpaths to help users read the file and is ignored by the processing.
- The business object processing treats the row with the second lowest sequence number (2) not as data, but as the xpath to move data to the target business object, in this case, W1-Organization.
 - Note that the configuration of some business object mean that this cell may start with a “+” sign. Also note that the file always treats this cell as a formula and adds an “=” sign to the front of the data string, as indicated by “#NAME?” (For example: =+nodeId/nodeType). You must reformat the cell to “Text” and remove the “=” sign.
- Rows with sequence number three (3) and up are treated as data.
- For objects where the primary key is a system generated ID (such as the case with Organization), the Primary Key column cells blank.

Note: When adding records that reference look up values use the lookup field value, not the description. For instance, the Disposition field references the NODE_DPOS_FLG lookup, for which the "Active" field value is "WIAC". For fields that reference other objects, use the code, not the description.

Other Formatting Issues

The following information addresses known formatting issues in working with the CSV data template:

- Dates need to be formatted as yyyy-mm-dd (2020-10-27).
- Date and Time should be formatted as yyyy-mm-dd-hh.mm.ss.
- Columns based on lookup values that have leading zeroes will need to match the values in the CSV file.
- A link needs to be created when you want to include the “parent”, which has a system generated ID, in the same file with the “child”. For example, if you want to populate the Parent Organization’s ID in the same file, you would need to insert a link (for example, @3, which is the @ symbol plus the Sequence #) in the row where the system generated ID would reside.
- If multiple rows contain the same Primary Key, only the last row is loaded. All values for the Primary Key need to be on the same row.

Initiating Requests

There are two steps involved in loading data using this process: creating the request type and the request.

Creating Request Types

1. Navigate to **Admin**, select **General**, select **Request Type**, and then select **Add**. The **Select Business Object** screen opens.
2. Select the request type business object that corresponds to your request type (“Online Loader Request Type” or “Batch Loader Request Type”) from the **Request Type Business Object** drop-down list and click **OK**. The **Online Request Type** or **Batch Request Type** screen opens (based on the business object selected).
3. Enter a code and meaningful description for the request type in the **Request Type** and **Description** fields. For example, "Online Loader Request Type" or "Batch Loader Request Type".
4. Enter a **Detailed Description** (optional).
5. For request types based on the Batch Loader Request Type business object, specify whether or not the contents from the attachment record will be deleted once the upload is finished (Yes or No) in the **Deleted Attachment Upon Finish** drop-down list.
6. Click **Save**.

Creating Requests

Online Requests

1. Navigate to **Menu**, select **Tools**, select **Request**, and then select **Add**. The **Select Type** screen opens.
2. Select your online loader request type and then click **OK**. The **Online Loader Request** screen opens.
3. Select the business object for your loader in the **Business Object** field.
4. Select your CSV file to upload or enter the data directly into the **Data** section and then click **Save**. Note: If examples of online requests are already available in your system, search for the appropriate request, click **Edit**, and either use the existing data if it applies, or click **CSV File To Upload** to upload your already formatted and populated CSV file. You can also click **Download To CSV File** and manually populate the data into the file and then click **CSV File To Upload** to upload the file. Your request will open in the **Request** zone in the "Created" state.
5. Click **Load Data** in the **Record Actions** section to submit the request. If successful, the status of the request will be "Loaded". Check the **Request Log** for requests that do not transition to a "Loaded" status. You will need to click **Back to Created** to reset the request back to the "Created" status and click **Edit** to fix the issue before resubmitting the request.

Batch Requests

1. Navigate to **Menu**, select **Tools**, select **Request**, and then select **Add**. The **Select Type** screen opens.
 2. Select your batch loader request type and then click **OK**. The **Batch Loader Request** screen opens.
 3. Select an external system from the **External System** drop-down list.
 4. Select the business object for your loader in the **Business Object** field.
 5. Enter a commit frequency in the **Commit Frequency** field.
 6. Enter the **File Name** or search for and select the **Attachment** that should be in the request and click **Save**.
- For **Batch File Upload** — The Filename is specified in the request. Comma delimited files should be uploaded to or available on the server. Run the W1-GBUPL batch job to create the sync request. Parameter File Name and File Path should match the file name and path of the file. Once the job has ended and the request is loaded, run the F1-SYSRQ batch job to process the created sync request.
 - For **Batch Attachment Upload** — The Attachment ID is specified in the request. Comma delimited file is uploaded as an attachment. Run the W1-GAUPPL batch job to create the sync request. Parameter Request ID should match the created request. Once the job has ended and the request is loaded, run the F1-SYSRQ batch job to process the created sync request.
 - Use the following parameters when running the F1-SYSRQ batch job:
 - Maintenance Object: F1-SYNCREQIN
 - Restrict by Batch Code: True
 - Restrict by Business Object: W1-GenericDataLoaderSync
 - Restrict by Status Code: PENDING

Customer To Meter Batch Processing

This section provides guidelines for configuring batch processing with Oracle Utilities Customer To Meter.

Batch Process Dependencies

The contents of this section illustrate the periodicity and dependencies between the various background processes described above.

Batch Schedulers and Return Codes

If you use a batch scheduler (e.g., Control-M, Tivoli) to control the execution of your batch processes, it will be interested in the possible values of each process's return code. The return code is a number that indicates if the process ended successfully. All product processes will return one of the following return code values:

- 0 (zero). A value of zero means the batch process ended normally.
- 2. A value of 2 means the batch process detected a fatal error and aborted.

The Nightly Processes

The following diagram illustrates the dependencies between the batch processes.

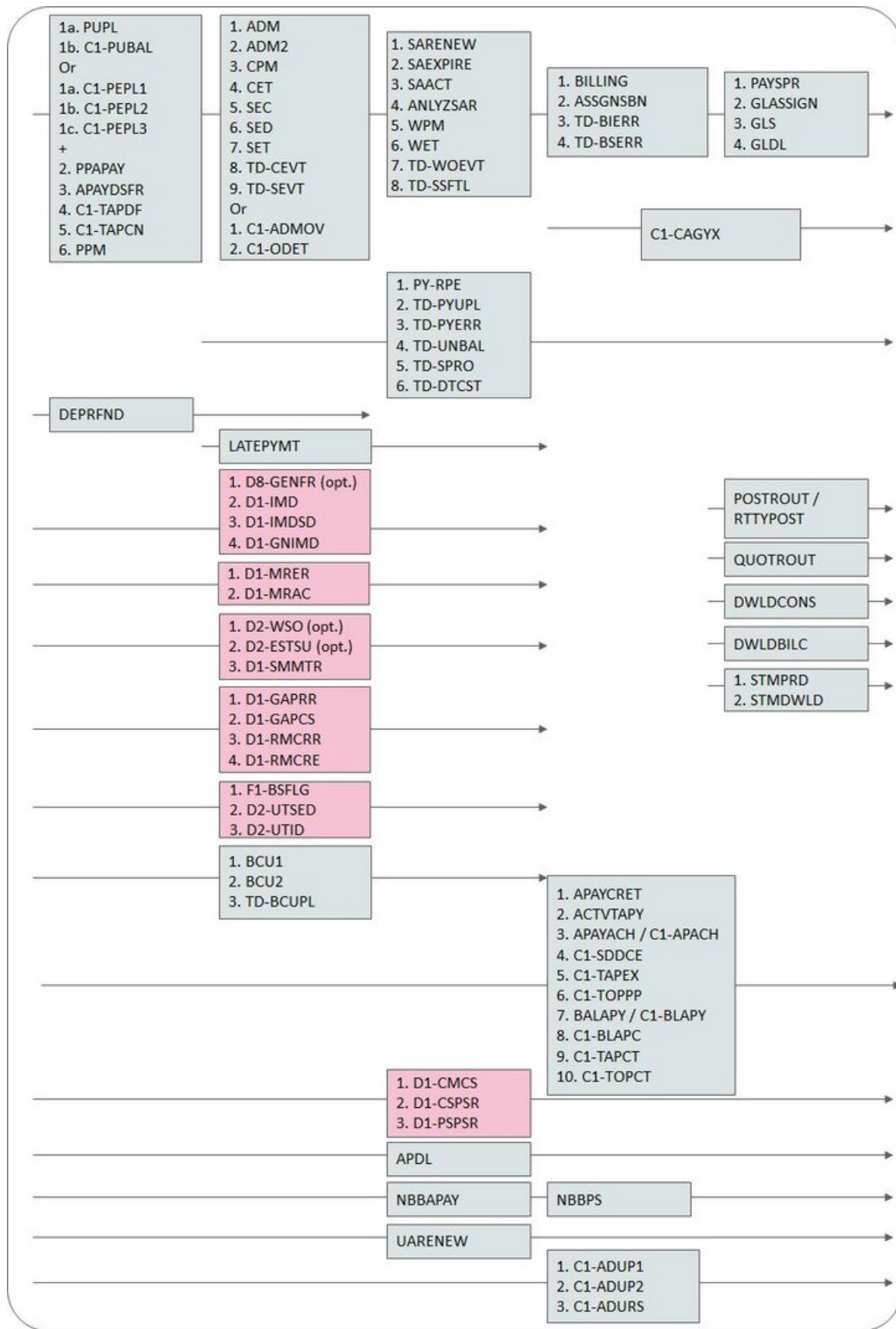

The mnemonics in the boxes refer to the individual batch processes described above. When a box contains multiple processes, these processes must be run sequentially. When multiple boxes exist on a timeline, all processes in an earlier box must execute before the subsequent box is executed. Those timelines that appear beneath the Main Job Stream's timeline indicate when the timeline's respective processes can be executed in respect of the Main Job Stream.

The following diagram illustrates the daily batch processes for which there are no dependencies.

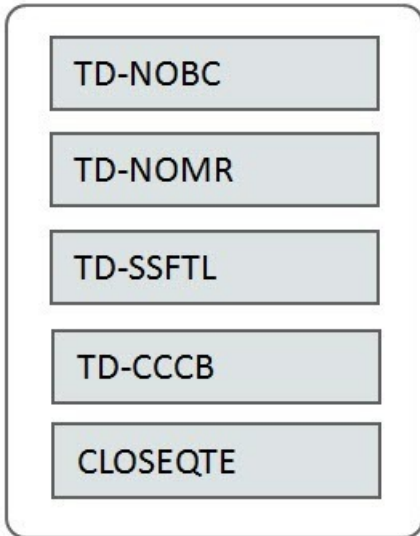

The mnemonics in the boxes refer to the individual batch processes described above.

NOTE:

No dependencies exist. As you can see, there are no dependencies between the boxes (meaning they may be run in parallel).

The Ongoing or Hourly Processes

The following diagram illustrates the dependencies between the ongoing or hourly batch processes.

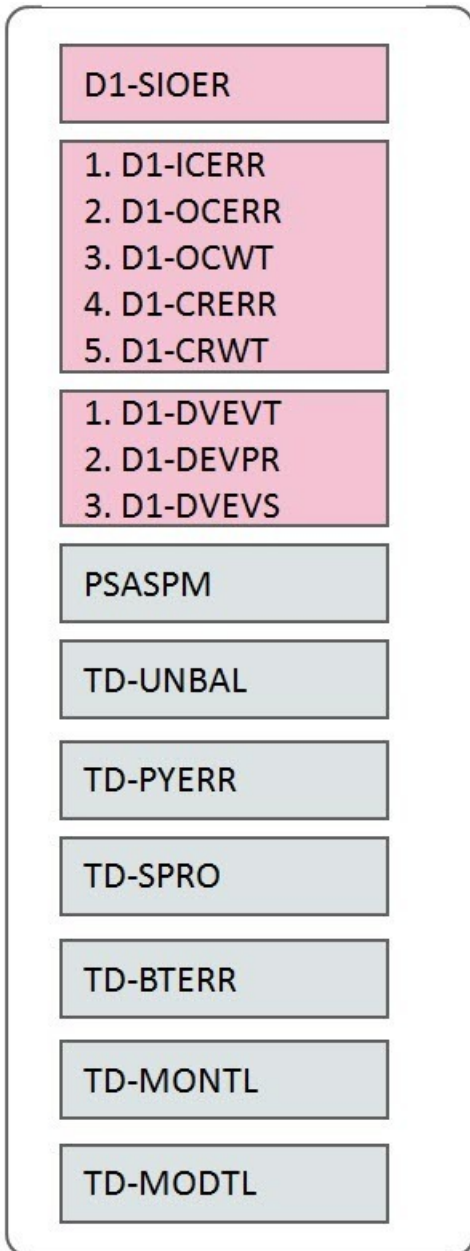

The mnemonics in the boxes refer to the individual batch processes described above. When a box contains multiple processes, these processes must be run sequentially.

NOTE:

No dependencies exist. As you can see, there are no dependencies between the boxes (meaning they may be run in parallel).

Throughout the course of the day, you will likely want to run jobs to bring measurement and event data in from the various metering / head-end systems and other external systems. To accompany this, you should consider running the following batch processes:

- **Ongoing Master Data Sync Processing**

With the Oracle Utilities Customer to Meter deployment, data synchronization is used to keep certain objects synchronized. Refer to the C2MIntegration section for further details. Cleaning out synch staging records in error by running D1-SIOER may be necessary.

- **Command Processing**

If using Oracle Utilities Smart Grid Gateway to process device commands, it's important to keep communications flowing to and from smart meters to provide the most accurate picture of the state of a given meter. This would include:

- Retrying inbound communications in error (D1-ICERR)
- Retrying outbound communications in error (D1-OCERR)
- Processing outbound communications waiting for a response (D1-OCWT) to see if they should be timed out.
- Processing command request activities in error (D1-CRERR) and those that are waiting (D1-CRWT)

NOTE: Base package business objects for communications and command activities are designed to trap any processing errors encountered and transition the object into an Error state. To deal with unexpected errors that can't be trapped, which could leave communications / command activities in unmonitored states, implementations can choose to configure their own batch controls based on the delivered D1-ACTVY and D1-COMM batch controls, restricting records processed by business object or maintenance object as needed

- **Initial Measurement Processing**

For initial measurement processing, the following batch processes should be scheduled on an ongoing basis per business requirements:

- Processing initial measurements in the pending state (D1-IMD).
- Processing initial measurements seeders in error (D1-IMDSD).
- Processing initial measurements in the exception state (D1-GNIMD).

These processes are also highlighted in the Nightly Processes stream to reflect the need to bring in as much measurement data as possible prior to running billing, both up-to-date data from late-reporting meters and corrected readings from the head-end system.

- **Event Processing**

The base package is configured such that device events are processed immediately upon receipt, since they might need to be sent to some other application such as an outage system. This can be changed by configuring a monitor process on the device event business object to stop records in a specified state, and then use a batch process to process the events all at once. Beyond this type of batch-oriented processing for events, other event processing could include:

- Re-processing device event "seeders" in error (D1-DVEVS)
- Processing all device events that can come in as pairs (D1-DEVPR)
- Picking up device events for processing if they've stopped in any state (D1-DVEVT)

If device events are configured to be held from being sent onto downstream applications, such as to prevent "flicker" outage events (an outage event and a restore event received in rapid succession) from being sent, device event monitoring (D1-DEVPR and D1-DVEVT) should be set up to be run periodically to ensure timely transmission of events.

The Letter Processes

To extract information for your various letters, only one background process, LTRPRT, is required regardless of the different types of letters you have. This process simply calls an algorithm plugged-in on the respective letter template to construct its flat-file content.

The following diagram illustrates the dependencies for the letter background process. While this process should be run at least on a daily basis, you may want to consider running it more frequently (depending on how frequently you produce letters).

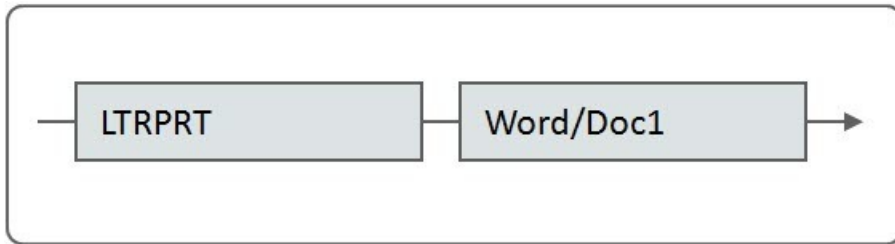

The mnemonics in the boxes refer to the individual batch processes described above. When a box contains multiple processes, these processes must be run sequentially. When multiple boxes exist on a timeline, all processes in an earlier box must execute before the subsequent box is executed.

The Periodic Processes

The following diagrams illustrate the dependencies between the periodic background processes. You may want to consider running these processes more or less frequently than suggested (depending on business requirements).

Periodic Processes: Weekly

The following processes should be run roughly once a week, or as per business requirements.

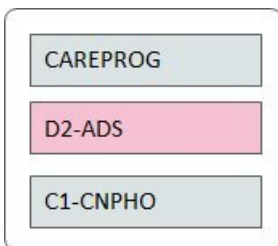

Periodic Processes: Monthly

The following processes should be run at least once a month, or as per business requirements.

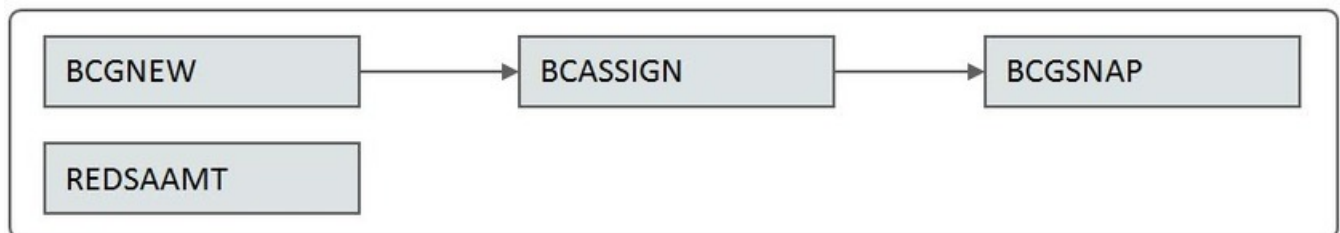

Periodic Processes: Annually

The following processes should typically be run once a year, or as per business requirements.

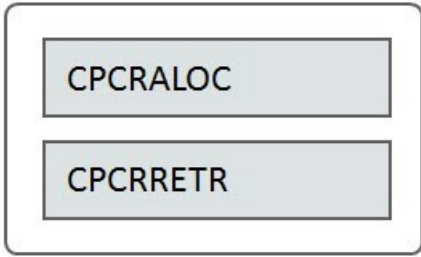

Periodic Processes: Per Business Requirements

The following processes should be run as frequently as dictated by business requirements.

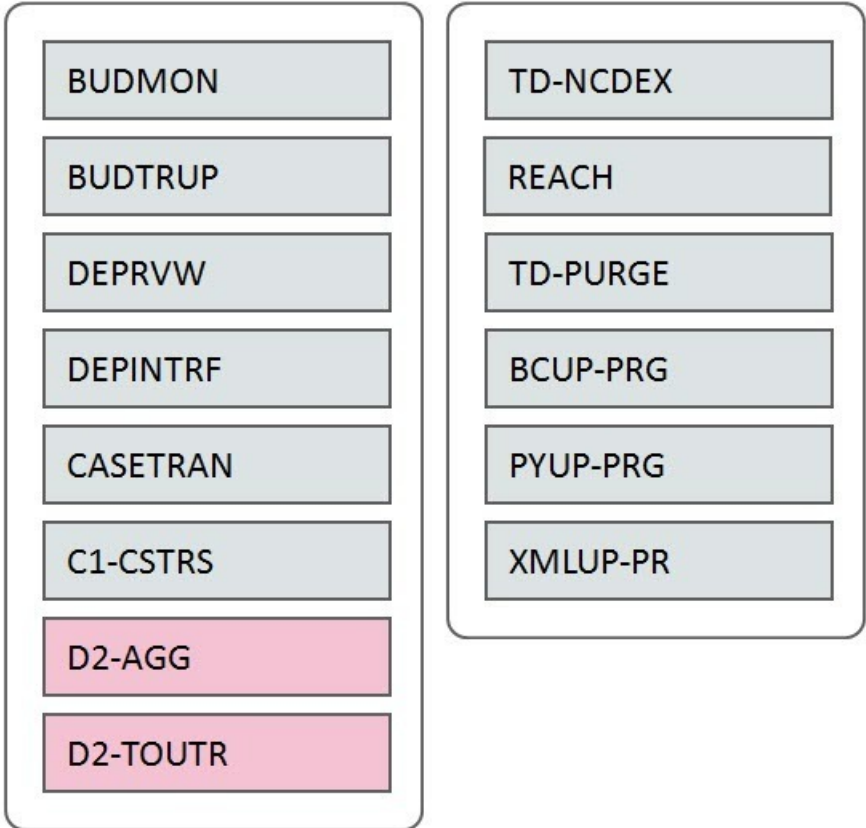

The mnemonics in the boxes refer to the individual batch processes described above.

NOTE:

Few dependencies exist. As you can see, there are few dependencies between the boxes (meaning they may be run in parallel).

TOU Map Data Generation

TOU map data must be in place for all TOU maps used in usage calculations. Generation of this data is performed using the “Time of Use Map Data Generation Monitor” batch control (D1-TOUTr). This process can be performed for long time periods, such as a year, generating data for all time-of-use maps for the entire following year, or it could be done more frequently, such as whenever schedules are updated via the TOU map templates

Defining General Options

This section describes control tables that are used throughout Oracle Utilities Customer Care and Billing.

Defining Installation Options

The topics in this section describe the various installation options that control various aspects of the system that are specific to the Oracle Utilities Customer Care and Billing product.

FASTPATH:

Refer to [Installation Options - Framework](#) for options that are common to products on the same framework.

Installation Options - Main

Select **Admin > General > Installation Options** and use the **Main** page to define system-wide installation options.

Description of Page

Use **Quick Add Tender Type** to define the tender type [defaulted on payments added using the Payment Quick Add transaction](#).

Use **Starting Balance Tender Type** to define the tender type of the starting balance recorded on your tender controls (this will almost always be the tender type associated with "cash"). This value is used during tender control balancing as a separate balance is required for each tender type in order to balance a tender control. Refer to [The Lifecycle Of A Tender Control](#) for more information.

FASTPATH:

For more information, refer to [Setting Up Tender Types](#).

Turn on the **Create Field Activity Start Stop** if field activities should be created when a start or stop is recorded (as opposed to shortly before the start/stop date). You might want to turn this switch off if it's possible for the state of the service point (or its meter / item) to change between the time service is requested and the actual service date. Why? Because the state of the service point and the state of its meter / item affects the type of field activity that is created. For example, if a customer wants to start service and there is no meter at the metered service point, an "install meter" field activity is created. However, if by the time the install date comes around, a meter has been installed by some other means; this field activity is inappropriate. This is why you might want to setup the system to wait until shortly before the service date to create the field activity (i.e., it reduces the likelihood that an inappropriate field activity is created). Refer to [Starting Service and Field Activities](#) for more information.

If you use orders to create new customers, define the **Campaign** that should be defaulted on orders created when the order transaction is opened for a new customer. Refer to [Real time Marketing of Services to a New Customer](#) for more information.

Use the **Premise Geo Type** to indicate whether at least one geographic identifier (e.g., GPS coordinate) is Required or Optional on a premise. Refer to [Defining Geographic Types](#) for more information.

The **Alternate Representation** flag should be set to None unless your organization uses multiple character sets for a person's main name and / or a premise's address. Alternate representations are typically only used in countries where multiple character sets are used. For example,

- In Hong Kong, a person's name may be written in both Chinese characters and in English.
- In Japan, a person's name may be written in both Kanji and Katakana.

In both of the above situations, users need to be able to use both representations to find a customer or a premise.

NOTE:

Spouses. If your organization doesn't use multiple character sets, you might want to consider using this functionality for spousal relationships. For example, rather than setup a person for each party in a spousal relationship, you could simply define one party using the person's main name and the spouse using the alternate name. While this is a bit of a "hack", it might be sufficient for your implementation as it will be much easier for an end user to use.

Alerts that should appear adjacent to a person's name or address. If your organization doesn't use multiple character sets, you might want to consider using this functionality to implement critical person or premise alerts. For example, if you have a customer who's supported by a specific account representative, you could enter the account rep's name as the person's alternate name. If you do this, the account rep's name would appear in parenthesis following the customer's name. In addition, you can search for the customers supported by the account rep on Control Central by entering the account rep's name. This is a bit of a "hack", but it might prove useful for a variety of functions.

If your organization uses alternate representations of person name or address, set this flag to one of the following values:

- Use a value of Address if you only use alternate representations for premise addresses.
- Use a value of Name if you only use alternate representations for a person's primary names.
- Use a value of Name & Address if you use alternate representations for both premise addresses and person names.

The following points describe the ramifications of this flag in the system:

- If you support alternate representations of a person's primary name,
- The name grid on [Person - Main](#) allows you to specify an Alternate name for the person.
- If you use the base package name formatting algorithm, a person's name will be shown throughout most of the system in the format AAA (BBB), where AAA is the person's primary name and BBB is the person's alternate name. Note, this format does not apply to names that appear in search results (i.e., the alternate name is not concatenated to the main name in search results; however you can search for information using the alternate name).
- Most of the system's person name-oriented searches will allow users to use both a person's primary and alternate names to search for information.
- If you support alternate representations of a premise's address,
- A new tab is available on the [Premise](#) page that allows a user to define an alternate address for a premise.
- If you use the base package address formatting algorithm, a premise's address will be shown throughout most of the system in the format AAA (BBB), where AAA is the premise's primary address and BBB is the premise's alternate address.
- Most of the system's premise-oriented searches will allow users to use both a premise's primary and alternate addresses to search for information.

If the CTI Integration flag has been enabled, set the **CTI Integration** flag to Yes if your organization integrates with an external computer telephony integration (CTI) system that supports a "get next caller in the queue" function.

The **Control By CIS Division** flag affects system behavior in many areas. This flag should be set if your business operates in different jurisdictions and CIS Division is used to delineate accounts and premises that users can access. When this flag is set, all users must be associated with at least one CIS division. See [Users and CIS Division](#) for more information.

The following system behaviors are affected by this flag:

- On Person, CIS Division is presented and is required when adding an account. Customer class is defaulted after CIS Division is set.

- On Order, CIS Division is presented when a new account is being added and is required. Customer class is defaulted after CIS Division is set..
- On Person, Order, Account and Premise, the list of CIS Divisions that can be chosen is restricted to the CIS Divisions associated with the user. The user's primary CIS Division is defaulted.
- On Account, CIS Division is presented before customer class. Customer class is defaulted after CIS Division is set.

The **Premise/SP Search** flag is used to provide access security to premises and service points that are not linked to an account.

- When the flag is set to Not Restricted, access to premises and service points that are not linked to an account is not secured.
- When the flag is set to Restricted by CIS Division, access to premises and service points that are not linked to an account is secured by the user's CIS Divisions. If the premise has a CIS Division, then only users that have access to that CIS division can access that premise or its service points. See Users and CIS Division for more information. Premise and service points belonging to premises without a CIS Division are not secured. A Premise Type setting can control whether premises of that type require a CIS Division.

NOTE: Premises and service points that are linked to an account are secured by the account access group

WARNING:

In order to improve response times, installation options are cached the first time they are used after a web server is started. If you change this field's option and you don't want to wait for the cache to rebuild, you must clear the cached information so it will be immediately rebuilt using current information. Refer to [Caching Overview for information](#) on how to clear the system login cache (this is the cache in which installation options are stored).

Installation Options - Person

Select **Admin > General > Installation Options** and use the **Person** page to define person-specific installation options.

Description of Page

Use the **Person ID Usage** to indicate whether or not at least one form of identification is Required or Optional when a new person is added. If required, indicate when the identifier is required based on the person's association with account(s).

Each form of identification has an identifier type. For persons that are humans (as defined by the person type), the system defaults the identifier type defined in **Identifier Type (Person)**. For persons that are businesses (as defined by the person type), the system defaults the identifier type defined in **Identifier Type (Business)**.

The **Use Name Separator** and **Person Name Separator Character** are used when formatting person names for persons (not businesses). The person name format algorithm type (NMFMT-VALFMT) that is provided with the system uses these settings.

Installation Options - Account

Select **Admin > General > Installation Options** and use the **Account** page to define account-specific installation options.

Description of Page

When a new account is added, the system requires it have a customer class. If the main customer linked to the account is a human (as defined by the customer's person type), the system defaults the customer class defined in **Customer Class (Person)**. For persons that are businesses (as defined by the person type), the system defaults the customer class defined in **Customer Class (Business)**. For more information, refer to [Setting Up Customer Classes](#).

In addition to requiring a customer class when a new customer is added, the system also requires a "main customer" (i.e., a reference to a person who is identified as the main customer for the account). Enter the default **Account Relationship Type Code** to be used to define the main customer relationship. For more information, refer to [Setting Up Account Relationship Codes](#).

Enter the default **Bill Route Type** to be used to define how bills should be routed to a customer. For more information, refer to [Setting Up Bill Route Types](#).

Enter the default **Quote Route Type** to be used to define how quotes should be routed to a customer. For more information, refer to [Setting Up Quote Route Types](#).

If the number of pending start and pending stop service agreements exceeds the **Start Stop Detail Threshold** for an account, it is considered a large account for start stop purposes. Refer to [Start/Stop Maintenance](#) for more information.

Installation Options - Billing

Select **Admin > General > Installation Options** and use the **Billing** page to define billing-specific installation options.

Description of Page

The **Bill Segment Freeze Option** controls when a service agreement's balance and the general ledger is affected by bill segments and certain types of adjustments. Refer to [Preventing SA Balances And The GL From Being Impacted Until Bill Completion](#) to understand the significance of this option.

The **Accounting Date Freeze Option** controls how the accounting date defined on financial transactions is populated. Refer to [Forcing The Freeze Date To Be Used As The Accounting Date](#) to understand the significance of this option.

Define the **Rollover Threshold Factor** used by billing to determine if a register's consumption is sensible. This value is used as follows:

- Whenever billing calculates a meter's register's consumption, it compares it to a value equal to X times the register's maximum capacity (where X is the Rollover Threshold Factor).
- If consumption exceeds this value, a bill segment error is generated. If this consumptive value is correct, a user will need to override the consumption value billed on the bill segment (billing will never use such a read).

Define the **Minimum Amount for Final Bill**. If a final bill is less than this amount, the bill is still produced; it's just not printed.

Typically, the system sets a bill's Bill Date equal to the date on which it is completed. If you want to be able to specify a bill's Bill Date when you complete a bill, turn on **User Can Override Bill Date**. You would only want to override the bill date if you are setting up sample bills from historical period whose bill date needs to reflect the respective historical period.

Turn on **Use High Low Failures on Bill** if the system should mark meter reads that fail high / low checks as billable. Turn off this switch if such reads should not be used by billing. Users may override this default value on a specific read. Refer to [Validations](#) for more information.

Base Time is used by billing algorithms to determine the effective start and end times for a given period. The **Start Day Option** further defines how to use the base time, indicating whether the base time is for the Current Day or for the Previous Day.

Turn on **Use Alternative Bill ID** if your implementation uses assigned document numbers or sequential bill numbers. In the **Alternative Bill ID Option** list:

- Select **Document Numbers** if you require a system-assigned document number for each bill in addition to the Bill Id, which is a system-assigned random number used as the bill's primary identifier. Refer to [Document Numbers](#) for more information.
- Select **Sequential Bill Numbers** if you require a system-assigned unique sequential number for each bill in addition to the Bill Id, which is a system-assigned random number used as the bill's primary identifier. Refer to [Sequential Bill Numbers](#) for more information

NOTE:

Document Number Algorithms. In addition to turning on **Use Alternative Bill ID** and specifying the **Alternative Bill ID Option**, the Document Number and Document Number Details algorithms must be enabled on the [Installation](#) record. These algorithms contain the logic used by the system to assign a document number to a bill.

The **Bill Correction** option lets you control whether your implementation uses Credit Notes or Correction Notes. Select the **Credit Note** option if you require bill segment cancellation details to be presented to the customer on a separate bill (referred to as a credit note). Refer to [Credit Notes](#) for more information. Select the **Correction Note** option if you require bill segment cancellation details and bill segment rebill details to be presented to the customer on a separate bill (referred to as a correction note). Refer to [Correction Notes](#) for more information.

NOTE:

Credit Notes or Correction Notes. The Bill Correction option on the Installation record controls whether Credit Notes or Correction Notes are allowed. If your implementation uses Correction Notes, the override label on the following should be customized accordingly:

Lookup value CRNT on the customizable lookup field TXN_FLTR_TYPE_FLG (this lookup value is used on the Match Event Page and Account Bill History transactions)

Lookup value CR on the customizable lookup field PYCAN_SYS_DFLT_FLG (this lookup value is used on the Pay Cancel Reason transaction)

Metadata field CR_NOTE_FR_BILL_ID (this field is used on the Bill Search Page)

The **Autopay Creation Option** controls when automatic payments are created, distributed, and frozen. This option allows you to control when automatic payments will affect customer's balances and when their financial impact affects the general ledger. Refer to [How And When Are Automatic Payments Created](#) to understand the significance of this option.

Installation Options - C&C

Select **Admin > General > Installation Options** and use the **C&C** page to define credit and collections-specific installation options.

Description of Page

When you look at an account or service agreement's debt, the system shows the respective age of each piece of outstanding debt. The **Oldest Bucket Age (Days)** defines the debt age after which the system groups all outstanding debt together. For example, if this field is 180:

- The exact age of each element of debt that is less than 180 days old would be shown as a separate line item in the aged debt information.
- All debt older than 180 days would be amalgamated into a single "bucket".

Oldest Bucket Age (Days) also has another use - it defines the age of financial transactions that are considered by the background process that marks old debt as "redundant". This batch process is referred to by the batch code of REDSAAMT.

WARNING:

If you change the value of **Oldest Bucket Age (Days)** after debt has been marked as "redundant" by REDSAAMT, the system will NOT re-age the old debt (i.e., once a financial transaction has been marked as "redundant", it is "redundant" forever).

Enter what you consider to be an excellent credit rating in **Beginning Credit Rating**. Collection events can cause an account's credit rating to decrease. When an account's credit rating falls below a certain level, different collection processes may ensue.

Use **Beginning Cash-Only Score** to define the cash-only score for accounts with a perfect payment history (i.e., one without non-sufficient funds). When you cancel a payment tender and use a cancellation reason marked as NSF, the system will cause the account's cash-only score to increase by the value on the payment cancellation reason.

Use **Credit Rating Threshold** to define when an account's credit rating becomes risky. When an account's credit rating falls beneath the Credit Rating Threshold, the system will:

- Assuming you've enabled the Control Central alert algorithm, C1-CRRT-ACCT, an alert displays when an account's credit rating falls below the credit rating threshold on the installation record. This algorithm is plugged-in on the [installation record](#).
- Subject the account's debt to different collection criteria. For more information, refer to [Designing Your Collection Class Control Overrides](#).

Use **Cash-Only Threshold** to define the number of cash-only points a customer must have before the system warns the CSR accepting payments that the account is cash-only.

Installation Options - Financial Transaction

Select **Admin > General > Installation Options** and use the **Financial Transaction** page to define financial transaction installation options.

Description of Page

Use **GL Batch** to define the batch process that is used to interface your financial transactions to your general ledger. The process is snapped on FT download records by the GLS background process.

Use **A/P Batch** to define the batch process that is used to interface your check requests (initiated with adjustments with an adjustment type that reference an A/P request type) to you accounts payable system.

Use **Fund Accounting** to indicate if [fund accounting](#) is Practiced or Not Practiced at your organization.

Use **Alternate Currency** to indicate if your organization accepts customer payments in currencies other than the account's currency.

FASTPATH:

Refer to [Alternate Currency Payments](#) to understand the significance of this option.

Installation Options Framework - Algorithms

Select **Admin > General > Installation Options - Framework** and use the **Algorithms** page to define specific system events.

The following table describes each **System Event**.

System Event	Optional / Required	Description
Account Information	Optional	We use the term "Account information" to describe the basic information that appears throughout the system to describe an account. The data that appears in "account information" is constructed using this algorithm. Plug an algorithm into this spot to override the system default "Account information".
Adjustment Information	Optional	We use the term "Adjustment information" to describe the basic information that

appears throughout the system to describe an adjustment. The data that appears in "Adjustment information" is constructed using this algorithm.

Plug an algorithm into this spot to override the system default "Adjustment information".

Note: This algorithm may be further overridden by an "Adjustment information" plug-in on the Adjustment Type. Refer to [Adjustment Type](#) for how algorithms of this type are used.

Appointment Information	Required	We use the term "Appointment information" to describe the basic information that appears throughout the system to describe an appointment. The data that appears in "appointment information" is constructed using this algorithm.
Auto Pay Creation	Required if you allow customers to pay automatically	This algorithm is executed to create automatic payments whenever the system creates automatic payments. Refer to How And When Are Automatic Payments Created for the details.
Bill Cycle Selection	Optional	This algorithm is only used if your organization has specific rule for assign a bill cycle to an account. This plug-in spot is invoked by the SA Activate/Stop common routine. The spot is called right after the system has updated the account.
Bill Information	Required	We use the term "Bill information" to describe the basic information that appears throughout the system to describe a bill. The data that appears in "bill information" is constructed using this algorithm.
Bill Segment Information	Optional	We use the term "Bill segment information" to describe the basic information that appears throughout the system to describe a bill segment. The data that appears in "bill segment information" is constructed using this algorithm.
Case Information	Optional	We use the term "Case information" to describe the basic information that appears throughout the system to describe a case. The data that appears in "case information" is constructed using this algorithm. Plug an algorithm into this spot to override the system default "Case information". Note: This algorithm may be further overridden by a "Case information" plug-in on the Case Type. Refer to Case Type for how algorithms of this type are used.

Collection Agency Referral Information	Optional	<p>We use the term "Collection Agency Referral information" to describe the basic information that appears throughout the system to describe a collection agency referral.</p> <p>Plug an algorithm into this spot to override the system default "collection agency referral information".</p>
Collection Process Information	Optional	<p>This algorithm displays additional information related to a collection process in a special field on the collection process main page.</p>
Control Central Alert	Optional	<p>These algorithms produce the alerts shown on the Alert Zone. Additionally, system-generated alerts can be show on the alert zone if enabled. (See the Alert Zone for more information and the list of system-generated alerts.)</p>
Credit Rating 'Created By' Information	Required	<p>The data that appears in the credit rating "created by" information is constructed using this algorithm.</p> <p>Refer to Account - C&C for more information about the credit rating.</p>
Credit Rating History Information	Optional	<p>We use the term Credit Rating History information to describe the basic information that appears throughout the system to describe a credit rating history entry.</p> <p>Plug an algorithm into this spot to override the system default "credit rating history information".</p>
Digital Signature	Optional	<p>This algorithm is only used if your organization generate and store digital signatures for each bill.</p> <p>Refer to Digital Signatures for the details.</p>
Document Number	Optional	<p>If document numbers have been enabled on the installation record, this algorithm type assigns a document number to a bill or payment event.</p>
Document Number Details	Optional	<p>If document numbers have been enabled on the installation record, this algorithm type is responsible for returning the details used to construct the document number.</p>
Determine Open Item Bill Amounts	Required if you use overdue functionality to collect on bills	<p>This algorithm is responsible for determining the unpaid amount of an open-item bill. It can also be used to return the unpaid amount for a specific SA on a bill.</p>
Document Sequence Number	Optional	<p>If document numbers have been enabled on the installation record, this algorithm type is responsible for generating document sequence number only.</p>

FA Additional Information	Optional	<p>This algorithm displays additional information related to a field activity in a special field called Additional Info on the field activity main page.</p> <p>For example, contact information linked to the field activity's field order may be displayed.</p>
FA Information	Required	<p>We use the term FA information to describe the basic information that appears throughout the system to describe a field activity. The data that appears in "FA information" is constructed using this algorithm.</p>
Item Information	Required if you have items	<p>We use the term "Item info" to describe the basic information that appears throughout the system to describe an item. The data that appears in "Item info" is constructed using this algorithm.</p>
Meter Information	Required if you have meters	<p>We use the term "Meter info" to describe the basic information that appears throughout the system to describe a meter. The data that appears in "Meter info" is constructed using this algorithm.</p>
Meter Read High Low Limits	Not used with Customer To Meter	
Online Bill Display	Optional	<p>This algorithm constructs or retrieves a PDF that contains the image of a bill. This algorithm is executed when the Display Bill button is clicked on the Bill page. Refer to Technical Implementation of Online Bill Display for more information.</p>
Online Field Order Display	Optional	<p>This algorithm constructs a PDF that contains the image of a field order.</p>
Online Letter Display	Optional	<p>This algorithm constructs or retrieves a PDF that contains the image of a letter. This algorithm is executed when the Display Letter button is pressed on the Customer Contact portal. Refer to Technical Implementation of Online Letter Display for more information.</p>
Online Quote Display	Optional	<p>This algorithm constructs a PDF that contains the image of a quote. This algorithm is executed when the Display Quote button is pressed on Quote - Main. Refer to Technical Implementation of Online Quote Display for more information.</p>
Online Statement Display	Optional	<p>This algorithm constructs a PDF that contains the image of a statement. This algorithm is executed when the Display Statement button is pressed on Statement - Main. Refer to Technical Implementation of Online Statement Display for more information.</p>

Override Proration Factors	Optional	This algorithm is only used if your organization has unusual rate proration requirements that necessitate the overriding of the base package proration logic. For example, you may have certain calculation rules whose charges should never be prorated. Refer to Overriding Proration Factors for more information.
Override Seasonal Proration	Optional	This algorithm is only used if your organization has unusual method of determining the seasons for your calculation rules. For example, you may determine the seasonal boundaries for a calculation rule based on the scheduled meter read date associated with the bill cycle.
Payment Amount Calculation	Required	This algorithm is executed to calculate the amount of an automatic payment for a bill for an account with an active auto pay option. Refer to How And When Are Automatic Payments Created for more information on automatic payments. This algorithm is also executed to default the amount of a manually added payment. Refer to How To Add A New Payment Event for more information on adding a payment manually.
Payment Event Information	Optional	We use the term "payment event information" to describe the basic information that appears throughout the system to describe a payment. The data that appears in "payment information" is constructed using this algorithm.
Payment Information	Required	We use the term "payment information" to describe the basic information that appears throughout the system to describe a payment. The data that appears in "payment information" is constructed using this algorithm.
Person Information	Required	In most parts of the system, a person's Main name is displayed to describe a person. However, several transactions do not use this method. Rather, these transactions call the algorithm that's plugged into this spot to construct the person's name. Refer to the description of the Alternate Representation flag on the Main tab for a list of these transactions and for the rationale behind this algorithm.
Person Name Format	Required	The format of names entered on Person - Main and Order - Main is validated using this algorithm.

Premise Information	Required	We use the term "premise info" to describe the basic information that appears throughout the system to describe a premise. The data that appears in "premise info" is constructed using this algorithm.
SA Information	Optional	We use the term "SA information" to describe the basic information that appears throughout the system to describe a service agreement. The data that appears in "SA information" is constructed using this algorithm. Plug an algorithm into this spot to override the system default "SA information". Note: This algorithm may be further overridden by an "SA information" plug-in on the SA Type. Refer to SA Type - Algorithms for how algorithms of this type are used.
Severance Process Cancellation	Optional	This algorithm is executed to perform additional processing when the system cancels a severance process. Note: This algorithm is executed before the Severance Process Template - Post Cancel Algorithm is executed. Canceling a severance process on-line manually does not execute this algorithm.
SP Information	Required	We use the term "SP info" to describe the basic information that appears throughout the system to describe a service point. The data that appears in "SP info" is constructed using this algorithm.

Defining Customer Languages

As described under [Defining Languages](#), you define the language in which each user see the system. In addition to defining each user's language, the system allows you to define each customer's preferred language. For example, one customer can receive bills in English whereas another customer could receive their bills in Chinese.

Each customer's language is defined by the [language code](#) on their [person record](#). Bills, adjustments and other system-generated records will then be done in the language of the main customer of the account. In addition, the language code is passed on to all customer-facing interfaces, such as letter requests and bill print.

NOTE:

You can define Rates in multiple languages - when a bill is generated, the line-item descriptions are generated and stored in the account's main customer's language of choice. Anyone who subsequently views these bills can only see the descriptions in that language.

To support bills and other correspondence, you must also provide translations of standard bill stock and letters. This must be handled by your printing software vendor.

Defining Accounting Calendars

Accounting calendars determine the accounting period to which a financial transaction will be booked. The following points describe how the system determines a financial transaction's account period:

- Every financial transaction references an accounting date and its service agreement
- Every service agreement references a service agreement type
- Every service agreement type references a GL division
- Every GL division references an accounting calendar
- The accounting calendar contains the cross-reference between the accounting date specified on the financial transaction and related accounting period in your general ledger

WARNING:

This information must be the same as the information in your financial database.

To add or review an accounting calendar, choose **Admin > General > Accounting Calendar > Search**.

Description of Page

Enter a unique **Calendar ID** and **Description** for the calendar.

Enter the **Number Of Periods** for the calendar. Don't count the adjustment period, if you use one, or any special "system" periods.

Specify the **Fiscal Year**, each **AccountingPeriod** in that year, a **Period Description**, the **Begin Date** and the **End Date**.

When you enter begin and end dates, you can define monthly calendar periods or any fiscal period that matches your accounting calendar (weekly, bimonthly) as long as the begin and end dates of successive periods do not overlap. Every day of the year must be included in a period; do not leave gaps between period dates.

For each fiscal period, enter the **Open From Date** and **Open To Date**. These dates define when that particular business dates are open for posting financial transactions to that fiscal period. For example, you might calculate a bill on Sept 1 for usage recorded on 31 August. To post this financial transaction in the August period, you must keep it open through Sept 1.

As time passes, you will need to return to this transaction to manually enter ensuing years. You can enter several years at a time or incorporate the task into end-of-year system maintenance.

Defining General Ledger Divisions

There are two types of Divisions referenced in the system: a CIS Division and a GL Division. This is a rather powerful structure, but it can be confusing.

- General Ledger divisions typically comprise individual entities (e.g., companies) in your general ledger. You must set up a GL division for each such entity. The GL division's sole purpose in the system is to define the accounting period associated with financial transactions linked to service agreements associated with the GL division (service agreements are associated with GL divisions via their SA type). The system cares about accounting periods in order to prevent a user from booking moneys to closed periods. It also uses accounting periods when it produces the flat file that contains the consolidated journal entry that is interfaced to your general ledger (refer to [The GL Interface](#) for more information).

NOTE:

When determining how many GL Divisions you need, be sure to consider your general ledger and how your chart-of-accounts is structured. You will typically have one GL division for each "company" in your general ledger.

- A CIS division is typically associated with a jurisdiction. The definition of a jurisdiction is a geographic-oriented entity with unique business rules. For example, if you conduct business in California and Nevada, and each state has different collection rules, you will need a separate jurisdiction for each state. You must set up a CIS division for each jurisdiction in which you conduct business.
-

FASTPATH:

Refer to [Setting Up CIS Divisions](#) for information about CIS Divisions.

To define a general ledger division, select **Admin > General > General Ledger Division**.

Description of Page

Enter a unique **GL Division** for the general ledger division.

Enter a **Description** of this general ledger division.

Define the accounting **Calendar ID** that controls how to convert an FT's accounting date into an accounting period. Refer to [Defining Accounting Calendars](#) for more information.

You may define a **Currency Code** for the GL division. Note that the system does not use this currency code.

Defining Banks & Bank Accounts

The topics in this section describe how to maintain your implementation's bank accounts.

Bank - Main

To review Banks choose **Admin > Financial > Bank > Search**.

Description of Page

Enter a unique **Bank** and **Description** for the bank.

The **Bank Accounts** collection displays the bank accounts currently linked to this bank code. Use the drill down button to view more details or to modify the bank account details. Alternatively, you may navigate to the Bank Account tab and scroll to the desired bank account.

Bank - Bank Account

To review Bank Accounts for a Bank, choose **Admin > Financial > Bank > Search** and then navigate to the **Bank Account** page.

Description of Page

Use the **Bank Accounts** tab to define the attributes of each bank account. For each account, enter the following information:

- Enter a **Bank AccountKey** to identify an Account at a Bank. You may have more than one account at a given bank, and you may have accounts at more than one bank. This code will allow the system to easily identify a specific account.
- Enter a **Description** to appear on prompt lists, inquiries, and reports.
- Enter the **Account Number**, **Check Digit** and if needed, the **Branch ID** of the bank where the account is held.

- Enter the **CurrencyCode** for the currency in which the account is denominated.
- Use **DFI ID** to define the Depository Financial Institution ID that is interfaced to the automatic payment-processing agent as part of the automatic payment interface.
- Enter the **Distribution Code** to be used for cash GL distributions when a payment is frozen or canceled.

Defining Issuing Centers

This section provides information about defining issuing centers that are used to assign document numbers to bills and payment events. An issuing center should be configured for each location that issues bills. The installation record Document Number and Document Number Details algorithms contain the logic used by the system to assign a document number to a bill. To set up an issuing center, open **Admin > General > Issuing Center > Add**.

FASTPATH:

Refer to [Document Numbers](#) for information about document number assignment.

NOTE:

This section is only relevant for some organizations. The information in this section is only relevant if your organization indicated on the installation record that it uses document numbers as an alternative bill id. If your organization does not use document numbers as an alternative bill id, then no other setup is required.

The topics in this section describe the base-package zones that appear on the Issuing Center portal.

Actions

This is a standard [actions zone](#).

If the issuing center is in a state that has valid next states, buttons to transition to each appropriate next state are displayed.

Issuing Center List

The Issuing Center [List zone](#) lists every issuing center. The following functions are available:

- Click a [broadcast](#) button to open other zones that contain more information about the adjacent issuing center.
- Click the Add link in the zone's title bar to add a new issuing center.

Issuing Center

The Issuing Center zone contains display-only information about an issuing center, including its current and historic branches. This zone appears when an issuing center has been broadcast from Issuing Center List zone or if this portal is opened via a drill down from another page.

Please see the zone's help text for information about this zone's fields.

Issuing Center Log

This is a standard [log zone](#).

Defining Service Tasks Options

This section describes concepts and procedures related to service tasks.

About Service Tasks

Service tasks are records that can be used to perform a variety of tasks. Examples include:

- Task-related records performed by users of other Oracle Utilities applications, such as Oracle Utilities Customer Self Service.
- Task-related records performed by Oracle Utilities Customer Care and Billing to manage specific processing, such as net energy metering true-ups, or prepaid billing to create bill segments for smart meter prepaid service agreements.

The main attribute used to define a service task is service task type. The service task type defines properties common to specific types of service tasks.

For more information, see [Searching and Viewing Service Tasks](#).

About Service Task Types

Service task types define properties common to specific types of service tasks. Service task types represent different types of tasks that can be performed by:

- Users of other Oracle Utilities applications, such as Oracle Utilities Customer Self Service. An example of a service task includes self service meter reads, in which users enter their own meter reads via the Customer Self Service application.
- Oracle Utilities Customer Care and Billing to manage specific processing. Examples include net energy metering true-ups, or prepaid billing to create bill segments for smart meter prepaid service agreement.

Service task types can be defined by the following attributes:

- **Service Task Type:** the name of the task type.
- **Service Task Type Business Object:** the business object that defines the behavior of the service task type.
- **Service Task Business Object:** the business object instantiated when service tasks of this type are created.
- **Service Task Class:** the category used to define service task types for reporting purposes (self-service, miscellaneous, etc).
- Other data based on the specific type of service task (such as minimum days in true-up period, billing frequency, or default payment method.)

For more information about defining service task types, see [Defining Service Task Types](#).

For more information about the service task types delivered with the application, see [Base Package Service Task Types](#).

Defining Service Task Types

To maintain existing service task event types, select **Admin > Customer > Service Task Type**, then use standard actions to edit, duplicate, or delete a service task type.

To define a new service task type, follow these steps:

1. Select **Admin > Customer > Service Task Type**.
2. Enter a name and a meaningful description for the service task type.
3. If needed, select the business object to use when creating service tasks of this type.
4. Select the service task class applicable to service tasks of this type, if applicable.
Some service tasks types used solely by Oracle Utilities Customer Care and Billing have a default class of **Miscellaneous**.
5. Enter a detailed description for the service task type.
6. Complete the remaining fields and sections, as needed.
7. If applicable, select a To Do type and corresponding To Do role to use when creating To Do entries related to service tasks of this type.
8. Click **Save**.

This service task type can now be used when service tasks are received from other Oracle Utilities applications, such as Oracle Utilities Customer Self Service, or service tasks created specifically by Oracle Utilities Customer Care and Billing. For more information about service task types, see [About Service Task Types](#).

For more information about the service task types delivered with the application, see [Base Package Service Task Types](#).

Base Package Service Task Types

This section provides descriptions of the service task types provided with the base package.

Service Task Type	Business Object	Detailed Description	Related Transaction Business Object
Appointment Notification Task Type	C1-NotifyAppointmentTaskType	This business object is used to capture the information to use in appointment notification processing.	Appointment Notification Task
Create Customer Contact Task Type	C1-CreateCustContactTaskType	This business object is used to capture the information to use in create customer contact task processing.	Customer Contact Request Task
Direct Debit Task Type	C1-DirectDebitMandateTaskType	This business object defines configuration information that is used for processing Single Euro Payments Area (SEPA) direct debit transactions.	Direct Debit Mandate Task
FA Completion Task Type	C1-FACompletionTaskType	This business object captures the attributes used in field activity completion task processing.	FA Completion Task
Field Activity Remark Task Type	C1-FieldActivityRemarkTaskType	This business object is used to capture the information to use in create field activity remark task processing.	Field Activity Remark Task
Form Task Type	C1-FormTaskType	This business object captures attributes relevant for a particular	Form Task

form type to be used when a self-service customer creates a form.

Missed Appointment Notification Task Type	C1-NotifyMissedApptTaskType	This business object is used to capture the information to use in missed appointment processing.	Missed Appointment Notification Task
Notification Task Type	C1-NotifyTaskType	This business object captures information about a notification that is made available for sign-up by self-service users.	Notification Preferences
Net Energy Metering Task Type	C1-NEMTrueUpTaskType	This business object is used to maintain the various configuration options that are used by the true up monitor (TUM) business object's algorithms. It defines the length of the true up period as well as the adjustments types used during the true up process. For true up reversals, the adjustment cancel reason to use is also captured here.	True Up Monitor Task
Outage Call Type	C1-OutageCallType	This business object defines the behavior of an outage call type used to support trouble calls captured in CCB and integrated to NMS.	Outage Call
Payment Arrangement Task Type	C1-PATaskType	This business object defines the expected behavior for when a self-service user requests a payment arrangement.	Payment Arrangement Task
PPB Payment Notification Task Type	C1-PPBPaymentNotifyTaskType	This business object captures information about the Prepaid Billing Payment Request notification that is made available for sign-up by self-service users.	Notification Preferences
Prepay Biller Task Type	C1-PrepayBillerTaskType	This business object defines the behavior of a prepay biller task type used in smart meter prepay billing.	Prepay Biller Task
Product Offer Publish	C1-ProductOffer	This business object contains the product offer elements that are relevant when publishing product offers to Siebel Energy. It is used to read product offer information when building the initial and final snapshots for the sync request.	Not defined
Product Offer Task Type	C1-ProductOfferTaskType	This business object is used to define the behavior of a product offer. Product offers are configured in CCB and published to Siebel Energy.	Not defined

SA Creation Rule Publish	C1-SACreationRule	This business object contains the SA creation rule elements that are relevant when publishing product offers to Siebel Energy. It is used to read SA creation rule information when building the initial and final snapshots for the sync request.	Not defined
SA Creation Rule Task Type	C1-SACreationRuleTaskType	This business object defines the behavior of the SA creation rules for a product offer. Each SA creation rule indicates the type of service agreement to create for the product offer.	Not defined
Service Request Task Type	C1-ServiceRequestTaskType	This business object is used as a parent service task type business object for service request related task types such as appointment notification, missed appointment and customer contact creation requests.	Not defined
Siebel Customer Maintenance Task Type	C1-CustomerMaintenanceTaskType	This business object is used in the Siebel integration. When a customer maintenance request is received from Siebel, an inbound service determines the service task type to use for the event.	Siebel Customer Maintenance Task
Start/Stop Task Type	C1-StartStopTaskType	This business object defines the expected behavior for when a self-service user requests to start, stop or transfer service.	Start/Stop Request Task

Defining Customer Questions

A customer question is used to capture specific information related to a request. For example:

- A customer can be asked questions about a service call being reported.
- A customer can be asked one or more questions during a start, stop or transfer service request.

The responses to customer questions are captured on the Response object that is linked to either a customer service request or a service task.

You can access the portal from **Admin > General > Customer Question**. You are brought to a query portal with options for searching for a specific question. Once a question is selected, you are brought to the maintenance portal to view and maintain the selected record.

The following zones appear as part of the portal's **Main** tab page:

- **Customer Question:** This zone provides information on question and answers. Refer to the zone's embedded help for more details.
- **Service Code List:** This zone displays a list of associated service codes. It is hidden if no service code is associated to the current question.

System-Wide Options

Installation Options - Framework

Configuring Installation Options - Framework

Installation options define the individual applications installed on your system and identify algorithms used to implement core system functions. These options also define global parameters such as the administrative menu style (alphabetical or functional), the country, language, currency code, as well as the base time zone to use for this implementation.

Installation options are stored in the installation record for your system. Use the Installation Options - Framework portal to configure these options. This portal is part of the OUAF and is described in detail in the Framework documentation.

Base Time Zone

The time zone setting of the Installation Options - Framework determines the time zone for all date/times stored within the system. Each date/time, based on the configuration of that field, is stored in either standard or legal time within this base time zone.

Refer to the [Glossary of Terms](#) in the *Oracle Utilities Meter Solution Business User Guide* for definitions Standard Time and Legal Time

Note: The installation record does not dictate the server time zone, but rather must match it.

Installation Algorithms

Installation algorithms implement global system functions and can be customized for each implementation. The base package supports the following installation options for Meter Data Management-related system events:

- **Geocoding Service:** Responsible for geocoding an address (converting an address to a geocode latitude/longitude pair).
- **Global Context:** Sets global contexts (displayed in the Global Context dashboard zone) based on the value of existing global contexts. For example, if the Service Point is specified, this algorithm sets the Device by finding the most recently installed Device on the service point. It then sets the Measuring Component by finding the most effective Device Configuration and retrieving any measuring component linked to it. It then sets the Usage Subscription by finding the most recent active usage subscription linked to the service point. The contact is set by finding the main contact for the usage subscription.

Additional detail on how global context is populated can be found in the detailed description of the D1-GBCTX-DF Algorithm Type.

- **To Do Pre-creation:**
 - In Meter Data Management, the D1-TDPRCRE (To Do Precreation) algorithm associates a To Do entry via characteristics to the related the related Device, Measuring Component, Service Point, Contact, Usage Subscription, Activity Type and Activity based on the drill keys of the To Do entry.
 - In Customer to Meter, the following algorithms are used to associate a To Do Entry via characteristics with related objects:
 - C1-TDCR-CHAR (Link Account/Premise/Person/SA/SP to To Do)
 - C1-TDCR-DFRL (Default To Do Role via Account/Premise)
 - D1-TDPRCRE (To Do Precreation)
 - X1-TDPRCRE (Customer to Meter To Do Pre-Creation)

NOTE:

Additional detail on how the To Dos are associated to related data can be found in the detailed descriptions of these algorithms type.

See [Installation Options](#) in the Oracle Utilities Application Framework *Administrative User Guide* for related information on the installation portal.

Feature Configurations

Configuring Feature Configurations

Some of the features in Oracle Utilities Application Framework based applications are configured by populating options on a "feature configuration". For example, if your implementation uses Oracle Utilities Customer Care and Billing's batch scheduler, you must populate a variety of options on the batch scheduler's feature configuration.

NOTE: Refer to [Defining Feature Configurations](#) in the Oracle Utilities Application Framework *Administrative User Guide* for additional information.

Oracle Utilities Meter Data Management uses the following types of feature configurations (please note that more information can be found on each of these options by viewing their detailed description in the Feature Configuration portal):

Measurement Data Options

Measurement Data Options are used to define behavior related to periodic estimation of initial measurement data, including:

- **No of Hours in Past to Retrieve Last Usable Measurement:** This option is leveraged by scalar periodic estimation to restrict how far into the past it will search for existing measurements when the last contiguous measurement is being initialized on the measuring component. This is to ensure that the first time scalar period estimation is executed on a large number of measuring components that have not been initialized for periodic estimation the system does not execute a large number of unbounded queries into the past which would result in poor performance.

Business Intelligence Configuration

Business intelligence configuration is used to define external data source indicators used when Oracle Utilities Meter Data Management is integrated with Oracle Utilities Business Intelligence. External data source indicators allow business intelligence extracts to properly link the external identifiers to the source external system. The Value of the Data Source Indicator option should match the Environment ID on the Installation Option of the external system.

General System Configuration

This feature configuration is owned by Oracle Utilities Application Framework but there are several important option types that have been created specific to Oracle Utilities Meter Data Management:

- **Multi Time Zone Support:** By default the system assumes an installation operates within a single time zone. In order to enable multiple time zone functionality this option must be defined and set to "DIYS".
- **CCB Link URL:** this option is used to provide the destination URL for hyperlinking into Oracle Utilities Customer Care and Billing.
- **Trace On Flag:** can be set to automatically trace any initial measurement being processed. Note: if the initial measurement has had trace explicitly turned off then no tracing will occur. This is useful for tracing initial measurements created through automated processes where you are unable to set the trace flag directly.

- **System Override Date:** this option type is provided by OUAF but it is highly useful in testing prior to production. When set it will override the system date/time for all users. The format must be entered as: YYYY-MM-DD. For example January 1st 2010 would be 2010-01-01.

NOTE:

Refer to [Configuring Multi-Time Zone Support](#) for additional information on setting up multi-time zone support.

Time Zones

Configuring Time Zones

To support businesses spanning across multiple time zones, the system stores all date and time information in a single common time zone known as the base time zone or the server time zone. Furthermore, date and time information is stored in either standard time (i.e. independent of any Daylight Savings Time adjustments, if applicable, in that time zone) or legal time (i.e. shifted according to Daylight Savings Time).

The system also allows data to be entered and displayed in a different time zone in legal time (i.e. adjusted for Daylight Savings Time, managing the conversion back and forth between the data entry time zone and the storage time zone).

Entities associated with a physical location such as measurements (initial and final), measuring components, device configurations, devices, installation events, service points, and usage subscriptions are entered and displayed in the specific time zone where they occur, the entity time zone. The rest of the application uses the base time zone to display date and time information.

When configuring time zones the following fields are of high importance:

- **Time Zone Name:** identifies the Olson time zone and as such defines the appropriate offset from Greenwich Mean Time as well as the schedule for shifting into and out of Daylight Savings Time.
- **Default Time Zone Label:** will be appended to date times that do not fall within Daylight Savings Time
- **Shifted Time Zone Label:** will be appended to date times that do fall within Daylight Savings Time

NOTE: The server time zone must be correctly specified on the installation options record for the system to work properly.

For additional information see [Defining Time Zones](#) in the *Oracle Utilities Application Framework Administrative User Guide*.

Configuring Multi-time Zone Support

As a default the system assumes operations are in a single time zone. This has a few high level impacts:

- All master data must have a time zone that is equal to the base time zone. As such all master data will have the same time zone and that time zone will be the base time zone
- Certain logical complexities are avoided during high volume processing given the knowledge that all master data time zones are equal to the base time zone.

If your implementation resides within multiple time zones then the Multi Time Zone Support feature configuration must be enabled. Doing so will allow master data to be defined with any time zone configured in the system. It will also enable logic to convert time zones between the master data time zones and the base time zones.

You can access the feature configuration portal from the **Admin > General > Feature Configuration**.

From the list of results returned select the feature name for the feature type General System Configuration. For the option type Multi Time Zone Support supply "D1YS" as the value to turn multiple time zones on.

Refer to [Multiple Time Zone Support](#) for information about how functional processing is impacted by multiple time zone support.

Defining Financial Transaction Options

Bills, payments and adjustments share one very important trait - they affect how much your customers owe. This section explains the financial design of the system and describes how to set up the tables that control the financial impact of these transactions.

NOTE:

The tables in this section are the first of many that must be set up before you can create bills and apply payments. In this section, we limit the discussion to those tables that control the financial impact of bills, payments and adjustments. In later sections, we describe the tables that control other billing-related functions like meter reading and rates. It is only after all of these tables are set up that you will be able to generate the various financial transactions.

The Financial Big Picture

This section provides an overview of the relationship between an account and the various financial transactions that influence how much a customer owes.

WARNING:

If your organization practices cash accounting for payables (i.e., you only pay the taxing authority when you get paid), refer to [Payables Cash Accounting](#). If your organization practices open-item accounting (i.e., payments must be matched to bills), refer to [Open Item Accounting](#).

Bills, Payments & Adjustments

The following diagram illustrates the relationship between an account and its financial transactions:

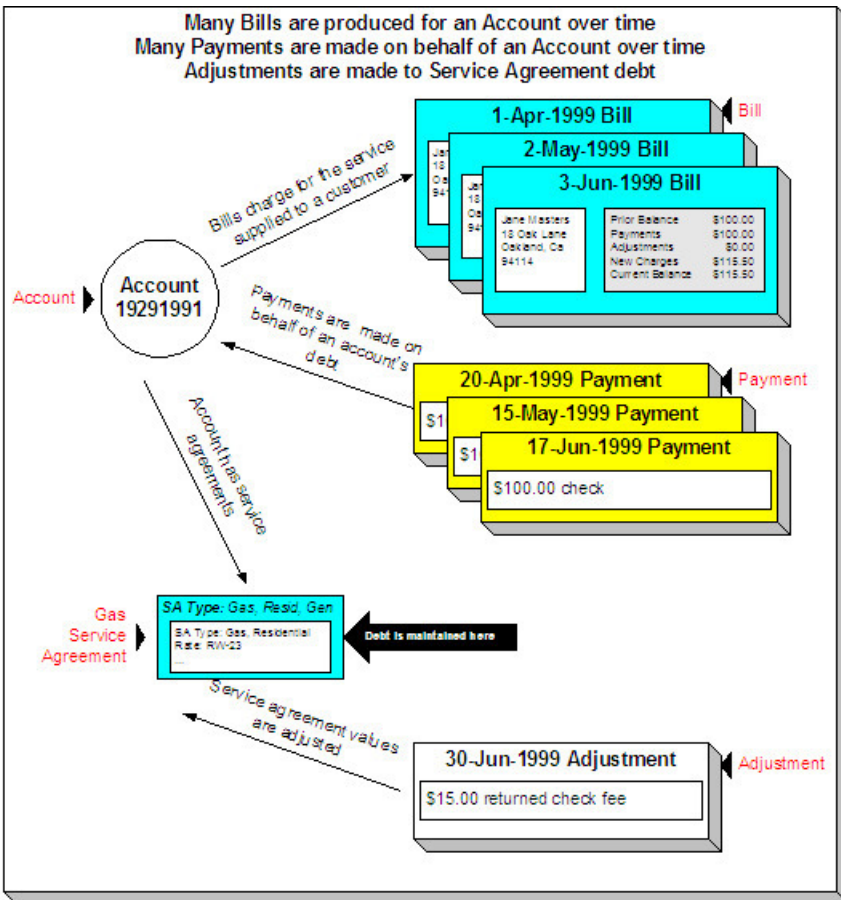

The following concepts are illustrated above:

Bills are produced for accounts Over time, many bills may be produced for an account. For more information about a bill, see [Bill Details](#).

Payments are made for accounts Over time, many payments may be applied to an account's debt. For more information about a payment, see [Payment Details](#).

Service agreements have debt The system maintains debt on each individual service agreement. An account's debt is the sum of its service agreements' debt.

Service agreements are adjusted Over time, the debt that is stored on an account's service agreement(s) may be adjusted. For more information about an adjustment, see [Adjustment Details](#).

Bill Details

The following diagram illustrates the relationship between an account and its bills:

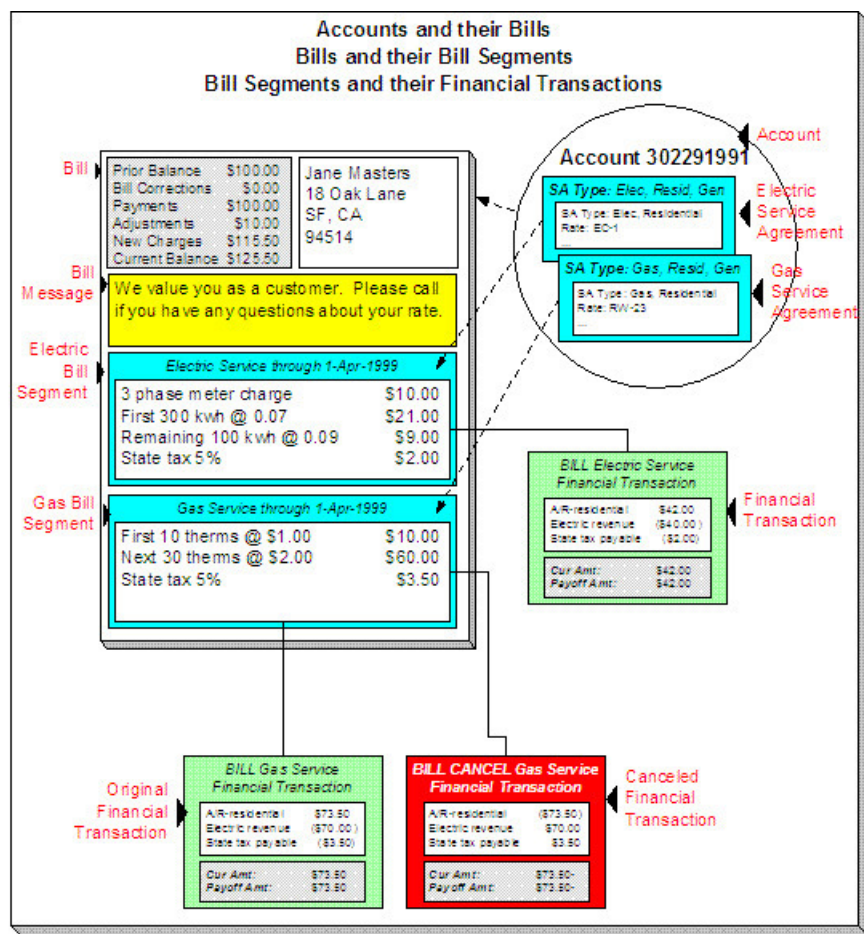

The following concepts are illustrated above:

A bill is produced for an account Over time, many bills are produced for an account. Bills charge for the services supplied to a customer. The above illustration shows a single bill.

Bills contain bill segments A bill typically contains one bill segment for every active service agreement linked to its account. The only time this is not true is when service agreements for different frequencies exist. For example, an account with a monthly and a quarterly service agreement will only have 4 bills a year that contain both bill segments; the other months' bills will contain a single bill segment for the monthly service agreement.

Bill segments contain calculation details A bill segment contains information showing how the segment was calculated and how it should be printed on the customer's bill.

A bill segment has a financial transaction A bill segment has a related financial transaction. A financial transaction contains the financial effects of the bill segment on the service agreement's current and payoff balances and on the general ledger.

Canceling a bill cancels the financial tran. If the bill segment is eventually cancelled, another financial transaction will be linked to the bill segment to reverse its original financial transaction. The cancellation financial transaction appears on the next bill produced for the account as a bill correction.

Payment Details

The following diagram illustrates the relationship between an account and its payments:

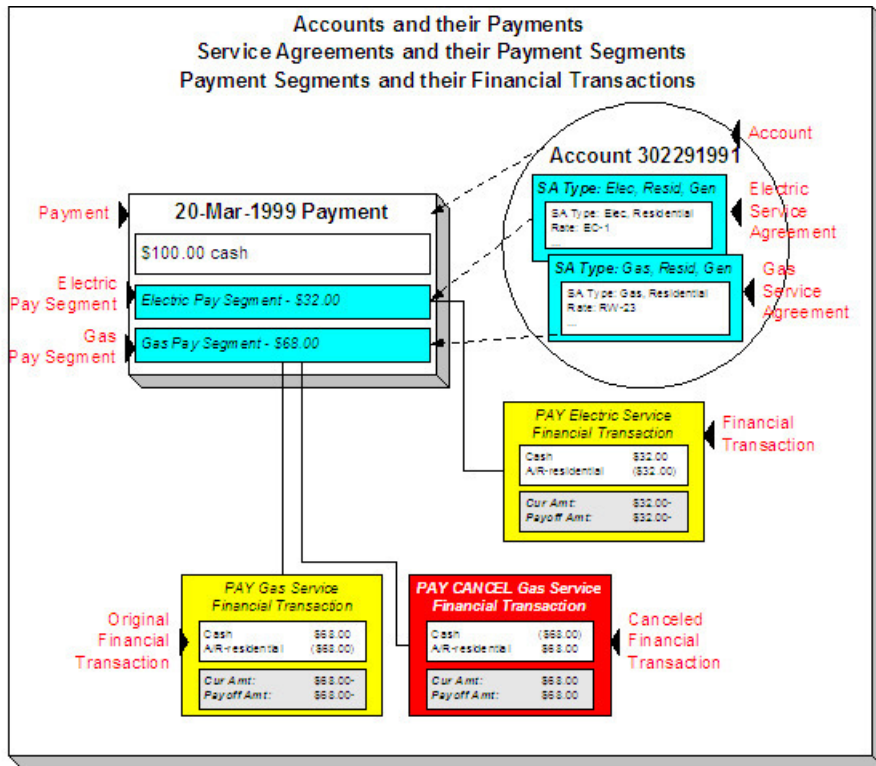

The following concepts are illustrated above:

Payments are made for accounts Over time, many payments may be applied to an account's debt. The above illustration shows a single payment.

Payments contain payment segments A payment contains one payment segment for every service agreement to which the payment is distributed. For a customer who pays in full, the number of payment segments will coincide with the number of bill segments on the bill being paid.

A pay. segment has a financial transaction A payment segment has a related financial transaction. A financial transaction contains the financial effects of the segment on the service agreement's current and payoff balances and on the general ledger.

Canceling a payment cancels the fin. tran. If the payment is eventually cancelled, another financial transaction will be linked to the related payment segment(s) to reverse their financial effect. The cancellation financial transaction appears on the next bill produced for the account as a negative payment.

FASTPATH:

A payment cannot be applied to an account's debt without an associated payment event. Refer to [The Big Picture of Payments](#) for more information.

Adjustment Details

The following diagram illustrates the relationship between an account and its adjustments:

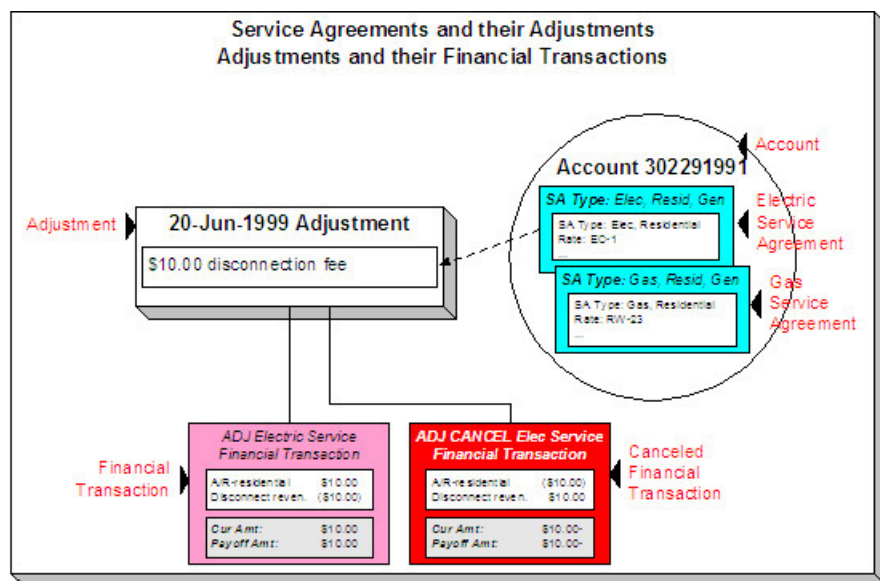

The following concepts are illustrated above:

Service agreements have adjustments Over time, a service agreement may have many adjustments. The above illustration shows a single adjustment to one of the account's service agreements.

An adjustment has a financial transaction An adjustment has a related financial transaction. The financial transaction contains the financial effects of the adjustment on the service agreement's debt and on the general ledger.

Canceling an adjust. cancels the fin. tran. If the adjustment is eventually canceled, another financial transaction will be linked to the adjustment to reverse its financial effect. The cancellation financial transaction appears on the next bill produced for the account as an adjustment.

Current Amount versus Payoff Amount

A financial transaction contains two very important attributes: payoff amount and current amount. These attributes contain the grand total of how much the customer owes.

- Current amount contains how much the customer THINKS THEY OWE.
- Payoff amount contains how much the customer REALLY OWES.

You may be wondering when these two values can be different? Well, for most financial transactions, these values are the same. These values differ under the following situations:

- When a bill segment charges a customer for a charitable contribution, payoff amount will be zero because the customer doesn't really owe anything (they don't have to contribute if they don't want to). Current amount will be equal to the agreed charitable contribution amount (the customer thinks they owe the contribution).
- When a bill segment charges a customer for a deposit, payoff amount will be zero because the customer doesn't really owe anything (billed deposits are typically not viewed as being a receivable). Current amount will be equal to the amount billed (the customer thinks they owe the deposit amount).
- When a bill segment charges a customer who participates in a levelized payment program (e.g., budget billing or non-billed budgets) the two "amounts due" will contain different values. Payoff amount is equal to how much the customer really owes for the service they consumed; current amount is equal to how much they think they owe in accordance with their monthly budget.

A perhaps easier way to view these two attributes is to consider payoff amount as the "cash out amount", i.e., the amount the customer would owe the utility if they wanted to clear up all debt. The current amount contains the amount the customer

thinks they owe. If you're still struggling with the difference, think about your monthly Visa bill: it contains a monthly minimum payment and the total amount owed. The minimum payment is the current amount; the total amount owed is the payoff amount.

The topics in this section provide more information about these two fields.

What Controls What Gets Booked To Current And Payoff Amount?

As described in [Bill Details](#), every bill segment has a sibling financial transaction. The financial transaction defines the bill segment's affect on current and payoff amounts due. The system populates these two fields as per the Financial Transaction Algorithm defined on the bill segment's bill segment type.

FASTPATH:

For more information, refer to [Billing - Current Balance versus Payoff Balance](#) and [Designing and Defining Bill Segment Types](#).

As described in [Payment Details](#), every payment segment has a sibling financial transaction. The financial transaction defines the payment segment's affect on current and payoff amounts due. The system populates these two fields as per the Financial Transaction Algorithm defined on the payment segment's payment segment type.

FASTPATH:

For more information, refer to [Payment - Current Balance versus Payoff Balance](#) and [Setting Up Payment Segment Types](#).

As described in [Adjustment Details](#), every adjustment has a sibling financial transaction. The financial transaction defines the adjustment's affect on current and payoff amounts due. The system populates these two fields as per the Financial Transaction Algorithm defined on the adjustment's adjustment type.

FASTPATH:

For more information, refer to [Adjustments - Current Balance versus Payoff Balance](#) and [Setting Up Adjustment Types](#).

Arrears

The system keeps track of the age of each customer's debt to the day. For example, if a customer hasn't paid their last two bills, the customer's aged debt might look as follows:

- \$124.50: 22 days old
- \$213.41: 51 days old

Please be aware that it is the current balance (i.e., what the customer thinks they owe) that is aged. Also keep in mind that the moment an FT is frozen, it impacts a customer's current balance.

The system represents aged debt in a variety of ways of the various transactions in the system. On the [Current Customer Zone](#) and the [Financial Information Zone](#) arrears are shown in a colorful bar (where each color corresponds to different aged buckets):



Whereas on [Service Agreement - Main](#), aged debt is shown in a grid:

Debt Class Arrears

Days Old	Arrears Amount
4	\$99.45
32	\$76.36

The grid method is used on many pages throughout the system. The following rows *may* appear in the grid:

- A row labeled New Charge highlights all debt that hasn't started aging yet. For example, if you've created a late payment charge and it hasn't appeared on one of the customer's bills, it will be classified as a New charge until the next bill is completed for the customer (unless a user overrides the late payment charge's arrears date by drilling into the financial transaction).
- A row with a label containing n Future (where n is the number of days) appears if there is "future debt". Future debt is very rare and can only exist if a debit financial transaction has a future arrears date. Financial transactions can receive a future arrears date if a bill is completed with a future date or if a user overrides a financial transaction's arrears date with a future date).
- A row that contains a number (and nothing else) represents debt that has started aging. The number is the age of the respective debt. In the above example, the customer has 1 day old debt, and debt that is more than 150 days old. Notice that the 150 day old debt is prefixed with a +. This means that the related debt is more than 150 days old. This age limit is controlled by a field on [Installation Options - CC](#) called "Oldest Bucket Age". This field limits the number of days the system will age debt. For example, if you set this field to 150, the system will never age an FT more than 150 days (and all debt that's older than 150 days will be classified as 150 day old debt). Also note, the aged debt bar that appears on [Current Customer Zone](#) only ages debt a maximum of 60 days.
- A row with a label of Disputed appears if the account is an [open-item](#) customer and this customer has [disputed](#) financial transactions.

FASTPATH:

Refer to [Financial Transactions And Aged Debt](#) for more information.

GL Accounting Information

Be aware that if payoff amount is non-zero, the financial transaction has general ledger detail lines.

There are unusual financial transactions whose payoff amount is zero, but still affect the general ledger:

- Bill segments for company usage do not impact payoff amount (because your organization doesn't really owe itself anything). However, the GL is affected.
- Payment segments for charitable contributions (created when your customers contribute extra money to a charity) do not impact payoff amount. Why? Because payoff amount is never debited when a charitable contribution is billed (the customer doesn't truly owe you for this receivable). It's only when the customer pays the contribution that the GL is impacted (debit cash, credit charitable contribution payable).
- If the SA has a special role of Loan, the financial transaction algorithms supplied with the base package transfer the current amount between the long-term receivables and the short-term receivables in the GL. This allows the general ledger to differentiate between unbilled loan receivables (long term) and billed loan receivables (short term). Refer to [Payoff Balance and Current Balance for Loans](#) for more information.

The effect on your GL is controlled by the financial transaction algorithm defined on your bill segment and payment segment types.

FASTPATH:

Refer to [The GL Interface](#) for how GL account information is interfaced to the general ledger.

A Complicated Example

The financial ramifications of a revolving charge account are predictable (if you're an accountant). The following table outlines the different financial events and their impact on the general ledger, arrearage history, and the amounts due (both current and payoff).

Event	GL Accounting	Arrearage Rule	Effect On Payoff Amt	Effect On Current Amt	Payoff Balance	Current Balance
Merchandise purchased	A/R 1000 Revenue <1000>	n/a (current amount is zero)	+1000	0	1000	0
Monthly bill	A/R 10 Int. Rev <10>	\$120 aged accordingly	+10	+120	1010	120
Payment received	Cash 120 A/R <120>	\$120 relieved accordingly	-120	-120	890	0

The following points describe the events in the above table:

- **Merchandise purchased.** When a customer purchases an air conditioner:
 - The system generates an adjustment to book the purchase.
 - The customer doesn't really think they owe the entire \$1,000 (because they've purchased it on credit), therefore no moneys are booked to current amount. However, if the customer wanted to cash out, they would owe your organization \$1,000, therefore the entire amount of the purchase is booked to payoff amount.
 - Because no money was booked to current amount, this event has no impact on the arrearage history.
- **Customer billed.** Monthly, the system calculates how much the client owes. In this example, interest is calculated to be \$10 and the minimum monthly payment is set at \$120.
 - The interest is posted to the GL, but principal isn't since it was booked when the merchandise was purchased.
 - The customer really thinks they owe the minimum payment amount, \$120. Therefore, current amount is affected. However, if the customer were to cash out, they would owe your organization \$1,000 + \$10 (the interest); therefore payoff amount is affected by only \$10.
 - Because current amount changed by \$120, arrearage history is affected accordingly.
- **Payment received.** With any luck, the client will pay the \$120 that was billed (note, they could obviously pay more).
 - The payment has a normal affect on the GL (debit cash, credit A/R).
 - The amount the customer thinks they owe decreases by \$120, therefore current amount is affected by the payment amount. And, if the customer was to cash out, they would owe the utility \$120 less, therefore payoff amount is affected by the payment amount.
 - Because current amount changed by \$120, arrearage history is affected accordingly.

Financial Transactions Created Between Bills

The following diagram illustrates how frozen financial transactions (FT's) accumulate between bills and are swept onto the next bill produced for the account (when the bill is completed). This example assumes

After the last bill is completed, the account's service will have no unbilled financial transactions

SA Type: Elec, Resid, Gen No unbilled financial transactions	SA Type: Gas, Resid, Gen No unbilled financial transactions
---	--

When an account is levied a late payment charge, FT's are created and linked to the account's service

SA Type: Elec, Resid, Gen ADJ Electric Service Cur Amt: \$10.00 Payoff Amt: \$10.00	SA Type: Gas, Resid, Gen ADJ Gas Service Cur Amt: \$5.00 Payoff Amt: \$5.00
--	--

When a payment is applied to the account's debt, two FT's are created and linked to the account's service

SA Type: Elec, Resid, Gen ADJ Electric Service Cur Amt: \$10.00 Payoff Amt: \$10.00	SA Type: Gas, Resid, Gen ADJ Gas Service Cur Amt: \$5.00 Payoff Amt: \$5.00
PAY Electric Service Cur Amt: \$32.00- Payoff Amt: \$32.00-	PAY Gas Service Cur Amt: \$68.00- Payoff Amt: \$68.00-

When a bill is generated for an account, two bill FT's are created and added to the account's service

SA Type: Elec, Resid, Gen ADJ Electric Service Cur Amt: \$10.00 Payoff Amt: \$10.00	SA Type: Gas, Resid, Gen ADJ Gas Service Cur Amt: \$5.00 Payoff Amt: \$5.00
PAY Electric Service Cur Amt: \$32.00- Payoff Amt: \$32.00-	PAY Gas Service Cur Amt: \$68.00- Payoff Amt: \$68.00-
BILL Electric Service Cur Amt: \$42.00 Payoff Amt: \$42.00	BILL Gas Service Cur Amt: \$73.50 Payoff Amt: \$73.50

When a bill is generated for account, it sweeps all unbilled FT's onto itself

Prior Balance	\$100.00
Bill Corrections	\$0.00
Payments	\$100.00
Adjustments	\$15.00
New Charges	\$115.50
Current Balance	\$130.50
...	

When any type of financial transaction is frozen, it impacts the related service agreement's **current and payoff balances**. If you do not want adjustments and bill segments to affect the customer's balance until they appear on the customer's next bill, refer to [Preventing SA Balances And The GL From Being Impacted Until Bill Completion](#).

Notice the balances in the financial summary of the above bill:

- The **Prior Balance** is the ending balance from the customer's prior bill.
- The **Bill Corrections** portion is blank. It contains a value if you cancel / rebill a bill segment that appeared on an earlier bill.
- The **Payments** portion shows payment financial transactions (both new payments and cancellations) that have been created since the last bill.
- The **Adjustments** portion shows adjustment financial transactions (both new adjustments and cancellations) that have been created since the last bill.
- The **New Charges** portion shows bill financial transactions that were created when the bill was created.
- The **Current Balance** is the total amount owed.

FASTPATH:

If you practice [Open Item Accounting](#), refer to [Open Item Versus Balance Forward Accounting](#) for more information about financial transactions and bills.

Financial Transactions And Aged Debt

The system keeps track of how old a service agreement's current balance is in order to determine if the customer is in arrears (and therefore credit and collections processing should start).

A financial transaction (FT) impacts the related service agreement's current and payoff balances the moment it is frozen. However, some types of frozen FTs have no impact on a customer's aged debt until the next bill is completed for the account associated with the service agreement.

As described in the previous section, a frozen financial transaction (FT) waits in limbo until the customer's next bill is produced. This limbo period could be several weeks if the customer is billed infrequently. When the customer's next bill is completed, all such frozen FT's are linked to the bill. It is important to stress the following in respect of these FT's:

- If the FT decreases the amount of debt, the customer's aged debt is affected immediately regardless of whether the FT appears on a bill.
- If the FT increases the amount of debt, the amount the customer owes from an aged debt perspective may or may not be affected by the FT. There is a switch on an FT called New Charge that controls the arrears behavior.
 - If this switch is on, the amount of debt will be reflected as a "new charge" when you look at the customer's aged debt. This amount will remain classified as a "new charge" until the FT is swept onto a bill. The moment the FT is swept onto the customer's bill, the debt starts aging. This logic exists because you probably don't want to start aging an FT until the customer has actually seen it.
 - If this switch is off, the date on which the FT starts aging must be defined in the Arrears Date field. The Arrears Date is used to compute how many days old the debt is.

NOTE:

Aged debt limitations. It's important to be aware that there's a field on [Installation Options - CC](#) called "Oldest Bucket Age" that limits the number of days old the system will age debt. For example, if you set this field to 360, the system will never age an FT more than 360 days (and all debt that's older than 360 days will be classified as 360 day old debt). Also note, the aged debt bar that appears on [Control Central - Account Information](#) only ages debt a maximum of 60 days.

FASTPATH:

If you practice [Open Item Accounting](#), refer to [Open Item Versus Balance Forward Accounting](#) for information about how open-item FT's affect aged debt.

Preventing SA Balances And The GL From Being Impacted Until Bill Completion

It's important to understand that when any type of financial transaction is frozen, the related service agreement's balance is affected. For example:

- When a payment is frozen, the customer's balance is reduced.
- When an adjustment is frozen, the customer's balance is impacted.
- When a bill segment is frozen, the customer's balance is increased (typically).

For payments, there is no issue. However, for bill segments and certain types of adjustments, you may NOT want the customer's balance to be impacted until the next bill is completed. Consider the following scenarios:

- Late payment charges:
 - You can setup the system to create a late payment charge (i.e., an adjustment) say 5 days after an unpaid bill is due.
 - If the related adjustment is frozen, the customer's balance will be impacted. However, its impact will not affect [aged debt](#) until the next bill is completed. In other words, the amount of the frozen adjustment segment will appear as a "New Charge" until the bill is completed.
- Batch billing:
 - If a customer has multiple service agreements, it's possible for one of the service agreements to have a bill segment that's in error and the other service agreement's bill segment to be error-free.
 - If this happens and you have setup the bill cycle schedule to freeze bill segments if they're error-free, then you could have one bill segment frozen and another in error.
 - The frozen bill segment will impact the customer's balance. However, its impact will not affect [aged debt](#) until the bill is completed (and a bill cannot be completed until all of its bill segments are error-free). In other words, the amount of the frozen bill segment will appear as a "New Charge" until the bill is completed.

WARNING:

We'd like to stress that while a frozen financial transaction impacts a customer's balance the moment it is frozen, the amount of the financial transaction appears as a "New Charge" when viewing a customer's [aged-debt](#). This amount will remain classified as a "New Charge" until the next bill is completed (i.e., the customer's debt doesn't start aging until the next bill is sent to the customer).

While [aged-debt](#) isn't impacted by frozen FT's, the general ledger is. This is because a financial transaction is marked for [interface](#) to the general ledger when it is frozen. This can be problematic if you have a long period between FT freeze and bill completion (you could impact the general ledger but not impact the customer's balance). If this is unacceptable, you can setup the system to not allow certain types of FT's to be frozen until the next bill is completed. This means that neither the customer's balance nor the general ledger will be impacted until bill completion time. To do this:

- Choose the Freeze At Bill Completion option on [Installation Options - Billing](#).
- Examine each of your [adjustment types](#). Select Freeze At Bill Completion for those that should not impact the customer's balance or the general ledger until the next bill is completed. Select Freeze At Will for those that should impact the customer's balance and the GL when they are frozen. Typically, the only adjustment types for which you'd choose Freeze At Will option are those that cause a customer's balance to be reduced, those that are used to refund money to a customer, and those that are created at bill completion. Adjustment types for adjustments created during bill completion (e.g., by a bill completion algorithm) must have their adjustment freeze option set to Freeze At Will. Otherwise (i.e., if the option is Freeze At Bill Completion) they will not be frozen until a subsequent bill is completed.

Please be aware of the following in respect of the Freeze At Bill Completion options:

- If you turn on Freeze At Bill Completion on [Installation Options - Billing](#):
 - Users will not be allowed to freeze bill segments online. This means that the freeze button will be disabled on [Bill - Main](#), [Bill - Bill Segments](#) and [Bill Segment - Main](#).
 - The Billing background process will not freeze bill segments until all segments on a bill are error free (and permission has been granted on the bill cycle schedule to complete bills).
 - Bill segments will exist in the freezable state until the bill is completed.
- If you turn on Freeze At Bill Completion on [Adjustment Type - Main](#):
 - Users will not be allowed to freeze adjustments of this type online. This means that the freeze button will be disabled on [Adjustment - Main](#).

- Background processes that create adjustments will not freeze this type of adjustment. Rather, the adjustments will be frozen when the next bill is completed.
- Adjustments of this type will therefore exist in the freezable state until the next bill is completed.

NOTE:

Alerts highlight freezable FT's. Please be aware that messages appear in the [Account Information - Financial Information Zone](#) and in the [Dashboard - Financial Information Zone](#) to highlight the existence of freezable financial transactions.

Please be aware of the following in respect of the Freeze At Will options:

- If you turn on Freeze At Will on [Installation Options - Billing](#):
 - Users will be allowed to freeze bill segments online. This means that the freeze button will be enabled on [Bill - Main](#), [Bill - Bill Segments](#) and [Bill Segment - Main](#).
 - The Billing background process will freeze bill segments when the individual segment is error-free (and permission has been granted on the bill cycle schedule to freeze bill segments).
 - Bill segments will exist in the frozen state regardless of whether the bill is completed.
 - The frozen bill segment's FT will be interfaced to the GL when the interface next runs.
 - All adjustment types must be also be set to Freeze At Will (otherwise they wouldn't get frozen).
- If you turn on Freeze At Will on [Adjustment Type - Main](#):
 - Users will be allowed to freeze adjustments of this type online. This means that the freeze button will be enabled on [Adjustment - Main](#).
 - Background processes that create adjustments will freeze this type of adjustment.
 - Adjustments of this type will exist in the frozen state prior to bill completion.
 - The frozen adjustment's FT will be interfaced to the GL when the interface next runs.

Forcing The Freeze Date To Be Used As The Accounting Date

Every financial transaction references an accounting date. The accounting date controls the accounting period to which the financial transaction is booked as described below:

- Every financial transaction references an accounting date and a service agreement
- Every service agreement references a service agreement type
- Every service agreement type references a GL division
- Every GL division references an [accounting calendar](#)
- The accounting calendar contains the cross-reference between the accounting date specified on the financial transaction and the related accounting period in your general ledger

The accounting date is populated on financial transactions when they are initially generated. The following points describe the source of the accounting date:

- The user who creates or cancels a bill segment online defines the accounting date as part of the generation/cancel dialog (note, the current date defaults).
- Bill segments that are produced by the [BILLING](#) background process have their accounting date defined on the [bill cycle schedule](#) that caused the bill to be created.

- The user who creates or cancels an adjustment online defines the accounting date as part of the generation / cancel dialog (note, the current date defaults).
- Payments are unusual in that their financial transaction is only created when they are frozen (rather than when the payment is first distributed amongst the account's service agreements). At payment freeze time, the accounting date is set to the current date.

For payments, there is no issue because the accounting date is only populated on the financial transaction when a payment is frozen. However, for bill segments and adjustments, your business practice may dictate that the freeze date should be used as the accounting date rather than the original accounting date. Alternatively, your business practice may dictate that the accounting date that's originally stamped on bill segments / adjustments should be used (unless this associated period is closed at freeze time). It's really a question of the interpretation of the local accounting rules. After you've decided on your approach, populate the **Accounting Date Freeze Option** on [Installation Options - Billing](#) with one of the following values:

- Choose Always change if the accounting date on your financial transactions should be populated with the freeze date (i.e., the current date when the financial transaction is frozen).
- Choose Change if period is closed if the accounting date defined when the financial transaction is generated should be used (unless the associated accounting period is closed).

Please be aware of the following in respect of your choice:

- If you choose Always change:
 - When a user freezes a bill segment online, they will be prompted to supply an accounting date. The current date will default, but the user can override this value.
 - When a user freezes an adjustment online, they will be prompted to supply an accounting date. The current date will default, but the user can override this value.
 - The **BILLING** background process will use the current business date as the accounting date on bill segments that it freezes.
 - Also note, if you have chosen the Freeze At Bill Completion **Bill Segment Freeze Option** on the [installation record](#), bill segments and certain types of adjustments are frozen when a bill is completed. This means that the accounting date on the related financial transactions will be set to the completion date (because the completion date is the freeze date with this setting). Refer to [Preventing SA Balances And The GL From Being Impacted Until Completion](#) for more information.
- If you choose Change if period is closed:
 - When a user freezes a bill segment online, they will only be prompted to supply an accounting date if the related accounting period is closed (because the accounting period closes after the bill segment is generated but before it's frozen). The current date will default, but the user can override this date.
 - When a user freezes an adjustment online, they will only be prompted to supply an accounting date if the related accounting period is closed (because the accounting period closes after the adjustment is generated but before it's frozen). The current date will default, but the user can override this date.
 - The **BILLING** background process will use the accounting date defined on the related bill cycle schedule as the accounting date on the bill segments that it creates and freezes.

NOTE:

The above installation option only controls the final accounting date for GL recording purposes. Rate and bill factor value selection based on accounting date uses the date as initially determined.

How Late Payment Charges Get Calculated

Late payment charges are system-generated adjustments used to penalize a customer for late (or no) payments. This section describes how to set up the tables that control how and when late payment charges are generated. The following points describe how and when late payment charges are calculated.

- When a bill is completed, the system marks it with the date on which late payment charges will be calculated if the bill is not paid.
 - This date is calculated by adding grace days to the bill's due date. Grace days are defined on the account's [Customer Class / Division](#).
 - This date will be zero if the account's [Customer Class / Division](#) indicates the account is not eligible for late payment charge processing.
- The late payment charge background process (referred to by the batch ID of [LATEPYMT](#)) selects all bills on or after their late payment charge date.
 - For each such bill, the system determines if its account satisfies the late payment charge eligibility criteria defined on the account's [Customer Class / Division](#). The eligibility criteria are defined in an algorithm and can therefore be as flexible as required.
 - If an account is eligible for late payment charges, the system checks each of the account's service agreements to determine if it is eligible for late payment charges (as defined on the service agreement's [SA Type](#)).
 - If a service agreement is eligible for late payment charges, the system calls the SA type's late payment charge calculation algorithm. This algorithm should calculate the late payment charge amount, if applicable and return the calculated amount and an appropriate adjustment type to use. If this algorithm returns this information, an adjustment is generated to levy the late payment charge.

FASTPATH:

Refer to [Setting Up Customer Classes](#) for more information about how to set up an account's due days and grace period. Refer to [SA Type - Main Information](#) for more information about enabling late payment charges calculations for your service agreements.

You can update the **Late Payment Charge Details** section on the Bill - Main Information page to indicate if and when late payment charges may be levied. For more information, see [Bill - Main Information](#).

Service Agreement Type Controls Everything

The previous section illustrated three important concepts:

The true financial impact of the three financial events - bills, payments, adjustments - is at the service agreement level, not at the account level. This means that bills and payments are meaningless on their own. It's the service agreements' bill segments, payment segments and adjustments that affect how much a customer owes.

- Every bill segment, payment segment, and adjustment has a related financial transaction. These financial transactions contain the double-sided journal entries that will be interfaced to your general ledger. They also contain the information defining how the customer's debt is affected by the financial event (i.e., current amount and payoff amount).
- A single bill can contain many bill segments, each of which may have a different frequency. For example, a bill could contain future charges, monthly retroactive charges based on measurement cycle, quarterly charges that must end on a quarter-end boundary.

You control the financial effects of the various financial events using a single field on the service agreement. This field is called the service agreement (SA) Type. In this section, we describe many of the tables that must be set up before you can create a SA type.

NOTE:

Foreshadowing. You will notice that we don't explain how to set up SA types in this section. This is because SA type controls numerous aspects of a service agreement's behavior in addition to its financial behavior. The non-financial

aspects are discussed in later chapters. It's only after you have set up all of the control tables in this manual that you'll be able to finally define your SA types. Refer to [Setting Up SA Types](#) for more information.

WARNING:

Take the time to define how you will record the various financial events in your general ledger before you attempt to set up these control tables. If you have simple accounting needs, this setup process will be straightforward. However, if you sell many services and use sophisticated accounting, this setup process will require careful analysis.

Understanding CIS Divisions

There are two types of Divisions referenced on a SA type: a CIS Division and a GL Division. This is a rather powerful structure, but it can be confusing.

- General Ledger divisions typically comprise individual entities (e.g., companies) in your general ledger. You must set up a GL division for each such entity. The GL division's sole purpose in the system is to define the accounting period associated with financial transactions linked to service agreements associated with the GL division (service agreements are associated with GL divisions via their SA type). The system cares about accounting periods in order to prevent a user from booking moneys to closed periods. It also uses accounting periods when it produces the flat file that contains the consolidated journal entry that is interfaced to your general ledger (refer to [The GL Interface](#) for more information).
- A CIS division is associated with a jurisdiction. The definition of a jurisdiction is a geographic-oriented entity with unique business rules. For example, if you conduct business in California and Nevada, and each state has different collection rules, you will need a separate jurisdiction for each state. You must set up a CIS division for each jurisdiction in which you conduct business.
- CIS division is also referenced on service agreement, premise and account.
 - The CIS division on SA is actually part of the SA's SA type. Because SA type controls many business rules, all business rules that are on the SA type can be thought of as being defined for a given jurisdiction and SA type combination. For example, you could define your valid rates for electric residential service in California which differ from the valid rates for electric residential service in Nevada. Refer to [Defining Service Agreement Types](#) for more information. In addition to controlling the business rules defined on the SA's SA type, the SA's CIS division also controls the type of collection criteria used to determine if and how to collect overdue debt. Refer to [Setting Up Collection Class Control](#) for more information.
 - The CIS division on premise defines the jurisdiction in which the premise is located. This jurisdiction controls the types of service agreements that can be associated with the premise's service points (e.g., you can only link California-oriented service agreements to premises governed by the California jurisdiction). You can also set up your field activity types to execute special algorithms when a field activity is completed at a service point located in specific jurisdiction.
 - The CIS division on account when combined with the account's customer class defines the jurisdiction that governs financial business rules (e.g., the bill's due date, when and how late payment charges are calculated, etc.). Refer to [Setting Up Customer Classes](#) for more information about these rules. The CIS division on account can also play a part in the addressee of To Do entries associated with the account. To assign To Do entries to a role based on the division, simply link the To Do type to the division. Refer to [To Do Entries Reference A Role](#) for more information.

CIS Division Overrides

Some configuration values in the system, such as those defined on the installation record, are global and applied to the entire system. CIS Division allows some of these values to be specified by CIS division, overriding the system-wide default configuration. The system processes check the CIS Division for the override before checking the default configuration. CIS Division allows for overrides to be specified for **customer class** (by person and business), and **credit rating** and **cash-only** beginning and threshold values.

The bill route type and quote route type are used to define the background process and extract algorithm for each route type. CIS Division allows overrides to be specified for the extract batch control and/or extract algorithms. These can be defined for any or all each bill route types and quote route types. While bill route type and quote route type allow many of each type to be configured, one of each type is defaulted from the installation record. This override allows CIS Division specific value for a common route type.

Users and CIS Division

When the installation option Control By CIS Division flag is set, it is necessary to associate the system users with CIS Division. This feature is applicable if your organization expects users to work on designated CIS Divisions only (as opposed to allowing users to serve customers across all CIS Divisions). Users can be associated with CIS Division(s) even if the above flag is not set. Some system functions take advantage of this such as defaulting CIS Division on control central searches. User - CIS Division is maintained in the user portal.

To navigate there, select **Admin > User > Search** and navigate to the **Miscellaneous** page.

How Does the System Use User CIS Division

Refer to [Installation Options – Main](#) for information on how this is used in conjunction with the Control By CIS Division and Premise/SP Search flags

The user's CIS Divisions are used in some circumstances to restrict case type and customer contact type by CIS Division.

The user's Primary CIS Division is used to default the CIS Division on the Control Central search that is provided with the system.

Restricting CIS Division

CIS Division appears through much of the system. The primary objects that reference a CIS Division are account, service agreement, and premise. It is also referenced on secondary objects such as orders and on pages that interact with the primary objects such as start/stop and payment arrangement.

A flag on CIS Division, Restrict to Account CIS Division, can be used to restrict service agreements and premise to the account's CIS Division. It is important to note that it is the account's CIS Division that matters. When this flag is set, many of the system pages default CIS Division and restrict the user for changing the value. The following rules are enforced in addition to the visible changes:

- Service agreement's CIS Division must match its account's CIS Division.
- Account CIS Division cannot be changed if the account has non-canceled service agreements.
- Account Protect CIS Division switch is turned on and is protected. This is done because the switch becomes irrelevant since all service agreements match the account's CIS Division and the account CIS Division would not change.
- When starting service, only premises that match the account CIS Division or do not have a CIS Division maybe chosen. This rule is applied when choosing a premise via start/stop or order.
- While most SA/SPs are created by the system when service is started, it is possible to manually maintain SA/SPs. When searching for a service point from Service Agreement - SA/SP, the search is limited to SPs whose premise matches the account CIS Division or does not have a CIS Division.
- As mentioned, this setting applies to the account CIS Division. When changing a premise's CIS Division, the system checks all accounts ever linked to the premise, to see if any of the accounts' CIS Division has set the Restrict to Account CIS Division option to **Restricted**.

NOTE: The Premise to Account association is checked through the relationship from Premise to Service Point to SA/SP to Service Agreement to Account.

- If the Account's CIS Division is set to restrict the CIS Division, then the Premise's CIS Division is restricted to remain the same as the Account's CIS Division. It can also be set to blank unless the premise type requires it.
- The characteristic premise on a service agreement is restricted to premises linked to the account if the service agreement requires an SP. For other service agreements the premise search is restricted to the account CIS Division.

WARNING: Do not turn on this flag without reviewing your existing data to ensure that it adheres to the rules enforced when the flag is set. The above rules are enforced on not just current data, but historic data as well such as closed service agreements. It is intended to ensure a consistency over the life of the objects associated with the CIS Division. This flag is configurable for each CIS Division, but consider the implications of setting it on some, but not all CIS Divisions.

Using CIS Division for Operational Segmentation

CIS Division is found throughout many of the entities in the system and there are many configuration settings related to CIS Division. When these configuration settings are used in conjunction with each other, it is possible to operate distinct business entities or jurisdictions that are segmented by CIS division. The following summary describes the different settings and uses of CIS Division that you can configure if your organization operates in multiple jurisdictions and needs to segment data and business processes by CIS Division. Details about each of these can be found in the section of the document where the functionality is configured.

Associate CIS Divisions with Users

CIS Divisions can be associated with users and one can be denoted as the primary.

Control By CIS Division

Setting the Control By CIS Division flag on the installation record drives many system changes. On the account it makes CIS Division required. The flag drives functionality changes on other pages such as person, premise, and order.

Premise/SP Access

Setting the Premise/SP Search flag on the installation record restricts access to premise and SPs not link to an account. The access is restricted to the user's CIS Division(s).

CIS Division

CIS Division provides the configuration of a work calendar, default customer classes for persons and businesses, credit rating and cash only beginning and threshold values, and To Do role assignment for each CIS Division. Additionally, bill route type, quote route type, and auto pay route type configuration can be overridden.

Restrict CIS Division

The Restrict to Account CIS Division flag is a setting on CIS Division. It is used to ensure that service agreements and premises match the account CIS Division and is a main component of segmenting data by CIS Division.

Customer Class

Customer class is used to default collection class on accounts.

Customer Class Control

Customer Class Control defines many business rules directly or through algorithms. These rules are specified per CIS Division. As noted above, Customer Class can be defaulted from CIS Division so there is a lot of flexibility in the configuration of these two entities. Some of the business rules are defaults such as access group and budget plan. Others such as payment distribution and billing days until due define the rule that apply to the account Customer Class/CIS Division combination.

SA Type

CIS Division is part of the SA Type key. SA Type defines the valid values for SAs of that type and also defines attributes such as debt class and write off debt class for of SAs of that type.

Collections

As noted above, Collection Class is defaulted on the account from customer class and SAs inherit their debt class from their SA Type. Collection Class Controls are defined for the unique combination of collection class and debt class. Collection class controls define the business rule and collection processes. Through configuration, collection rules can be defined for specific CIS Divisions.

Write Off

As noted above, collection class is defaulted on the account from customer class and SAs inherit their write off debt class from their SA Type. Write off controls are defined for the unique combination of collection class and write off debt class. Write off control define the business rule and write off processes. Through configuration, write off rules can be defined for specific CIS Divisions.

Premise Type

Premise Types can control if CIS Divisions are required, optional or not allowed for premise of that type. When starting service, if the premise has a premise type, only SA Types with the same CIS Division as the premise that are identified to start for SP Types for SPs at the premise will start. This allows more generic SP Types that start SA Types specific for the premise CIS Division.

Restricting Types by CIS Division

Adjustment type, budget plan, bill cycle, case type, and customer contact type allow a CIS Division to be specified if the type is used for a specific CIS Division. Types without a CIS Division are not restricted.

Background Processing By CIS Division

Batch billing and the collection, severance, and write off background processes can all be configured to select records by CIS Division. See [Choosing Which Records Are Selected](#) for more information

Setting Up CIS Divisions

This portal is used to display and maintain CIS Divisions.

Refer to [Understanding CIS Divisions](#) for more information.

You can access the portal from **Admin > General > CIS Division**.

The following zones may appear as part of the portal's **Main** page:

- **CIS Division List:** This zone lists all CIS division records. Broadcast a record to display the details of the selected record.
- **CIS Division:** This zone provides information about the selected CIS Division.

Setting Up Revenue Classes

Every service agreement references a service agreement (SA) type. Amongst other things, the SA type defines a service agreement's revenue class. The revenue class is used when the service agreement's rate books revenue to different GL distribution codes based on the service agreement's revenue class.

FASTPATH:

See [Designing Calculation Groups and Rules](#) for more information about how revenue class is used to determine the GL revenue accounts referenced on a bill. See [Revenue Segmentation](#) for more information about how revenue class affects the number of SA types you will need.

To set up revenue classes, choose **Admin > Financial > Revenue Class**.

Description of Page

Enter an easily recognizable **Revenue ClassID** and **Description** for every revenue class.

Setting Up Distribution Codes

Distribution codes simplify the process of generating accounting entries by defining valid combinations of chart of account field values.

FASTPATH:

Refer to [The Source Of GL Accounts On Financial Transactions](#) for more information about the accounting entries associated with bills, payments and adjustments.

To set up distribution codes, open **Admin > Financial > Distribution Code > Add**.

Description of Page

Enter a unique **Distribution Code** and **Description** for the distribution code.

If this distribution code is a holding account used for payables cash accounting, check the **Use For Non-Accrual Accounting** switch and select the accounting method from the **Accounting Method** list. Select the priority level for the distribution code from the **Accounting Priority** list and enter the actual payable **Accounting Code**. The system will transfer monies from the holding account to the distribution code when the cash event occurs. Transfers will occur based on priority and debt age. For more information, refer to [Payables Cash Accounting](#) and [Deferred Accrual Accounting](#).

Define the **GL Account Algorithm** used by the system when it interfaces financial transactions that reference this distribution code to your general ledger (refer to [GLDL - Create General Ledger Download](#) for more information about the download process). The logic embedded in this algorithm constructs the actual GL account number. If you haven't done so already, you must set up this algorithm in the system. To do this:

- Create a new algorithm (refer to [Setting Up Algorithms](#)).
- On this algorithm, reference an Algorithm Type that constructs your general ledger account number.

The **Write Off Controls** control how the system writes off debt associated with the distribution code. Refer to [The Ramifications of Write Offs in the General Ledger](#) for an explanation of how these fields are used at write-off time.

- Define the **Division** and **SA Type** of the service agreement to which bad debt associated with this distribution code should be transferred at write-off time. Note: only SA Types with a special role of Write Off may be selected.
- When the system transfers debt to the write-off service agreement defined above, the distribution code defined on this **Division / SA Type** will be debited unless you turn on the **Override Switch**. When this switch is turned on, the system overrides the distribution code of the transfer to side of the adjustment with the distribution code associated with the debt being written off. You'd typically turn this switch on for liability distribution codes because you want to debit the original liability account when the debt is written off. Note: if this switch is on the system also overrides the characteristic type / value with the respective value associated with the debt that is being written off.

Use the **GL Account Details** scroll to define how the system constructs the GL account associated with the distribution code when it interfaces the financial transaction to your general ledger. For each distribution code, enter the following information:

- Enter the **Effective Date** of the following information.

- Define whether, on the **Effective Date**, the following information is Active or Inactive. The system will only use effective-dated information that is Active.
- Enter the **GL Account** that the general ledger uses to process financial transactions tagged with this distribution code.
- Enter the **Statistics** that should be passed to the general ledger during the GL interface for this **GL Account**. For example, if this **Distribution Code** is used to record electric, residential revenue, the **Statistics** would be kWh if you record the number of kWh in you general ledger along with the dollar value of the revenue.
- If you have configured your installation options to indicate that **fund accounting** is practiced, define the **Fund** associated with this distribution code. If your installation options indicate that fund accounting is not practiced, the field is not visible.
- Use the characteristics grid to define characteristic values for the **Distribution Code**. This grid supports all standard characteristic types (such as, Adhoc, Predefined, File Location, and Foreign Key) from the **Distribution Code GL Account Characteristics** table. To modify a characteristic, simply move to a field and change its value. The following fields display:
 - **Characteristic Type**. Indicate the type of characteristic.
 - **Characteristic Value**. Indicate the value of the characteristic.

NOTE:

You can only choose characteristic types defined as permissible on the distribution code record. Refer to [Setting Up Characteristic Types & Their Values](#) for more information.

Setting Up Billable Charge Templates

A user creates a billable charge whenever a customer should be levied an ad hoc charge. For example, you would create a billable charge to charge a contractor for the repair of a ruptured gas line.

NOTE:

Interfacing billable charges from an external system. In addition to being entered manually, billable charges can also be interfaced from an external system. You would interface billable charges if your organization provides "pass through" billing services for a service provider. Refer to [Uploading Billable Charges](#) for more information.

A billable charge must reference a service agreement. This service agreement behaves just like any other service agreement:

- **Bill segments are created for the service agreement.** Whenever billing is performed for an account with billable charge service agreements, the system creates a bill segment for each unbilled billable charge.
- **Payments are distributed to the service agreement.** Payments made by an account are distributed to its billable charge service agreements just like any other service agreement.
- **Overdue debt is monitored.** The credit and collections process monitors billable charge service agreements for overdue debt and responds accordingly when overdue debt is detected.

NOTE:

Rates can be applied to billable charges. Billable charges can be connected to a service agreement that also specifies a rate. The rate will be applied and lines added to the bill segment after the billable charge lines are added. For example, a rate can insert flat charges or be applied to service quantities associated with the billable charge.

Taxes on top of billable charges. Rates cannot be applied to billable charge lines. If you need to perform a calculation such as applying taxes on top of the existing lines, add a service quantity (SQ) that contains the taxable amount with an SQ identifier that describes it as a taxable amount. A calculation rule can apply the tax to this SQ.

FASTPATH:

Refer to [How To Create A One-Time Invoice](#) for instructions describing how to create a bill for a billable charge outside of the normal bill creation process.

Billable charge templates exist to minimize the effort required to create a billable charge for a customer. A billable charge template contains the default bill lines, amounts and distribution codes used to levy a one-off charge.

The information on the template may be overridden by a user when the billable charge is created. For example, you can create a billable charge template to levy tree-trimming charges. This template would contain the bill lines, amounts and distribution codes associated with a tree trimming activities. Then, when you trim a tree for a customer, a user can create a billable charge using the template and override the amount to reflect the actual amount (if it differs from the norm).

NOTE:

Templates aren't required. A billable charge can be created without a template for a truly unexpected charge.

After setting up the billable charge templates, you must indicate the SA types that can use each template. Obviously, only billable charge SA types (as defined on the SA type's special role) will reference billable charge templates.

Billable Charge Template - Main

Open **Admin > Billing > Billable Charge Template > Add** to define your billable charge templates.

Description of Page

Enter a unique **Billable Charge Template ID** and **Description** for the billable charge template.

Use **Description on Bill** to define the verbiage that should print on the customer's bill above the billable charge's line item details.

Use **Currency Code** to define the currency in which the billable charge's amounts are expressed.

Use the grid to define the line item details associated with the billable charge (note, the **Total Line Amount** field is automatically calculated. It is the sum of the **Charge Amount** on each of the Line Sequence items). The following fields are required for each entry in the grid.

Sequence Line sequence controls the order in which the line items appear on the bill segment.

Description on Bill Specify the verbiage to print on the bill for the line item.

Charge Amount Specify the default amount to charge for the line item.

Show on Bill Turn this switch on if the line item should appear on the customer's printed bill. It would be very unusual for this switch to be off.

Appears in Summary Turn this switch on when the amount associated with this line also appears in a summary line.

Memo Only, No GL Turn this switch on when the amount associated with this line does not affect the GL (or the total amount owed by the customer).

Distribution Code Specify the default distribution code associated with this line item.

If you use the drill down button on the left most column in the grid, you will be taken to the Line Characteristics tab with the selected line displayed.

FASTPATH:

For more information about creating a billable charge, refer to [Maintaining Billable Charges](#). For more information about billing billable charges, refer to [How To Create A One-Time Invoice](#).

Billable Charge Template - Line Characteristics

Open **Admin > Billing > Billable Charge Template > Search** and navigate to the **Line Characteristics** page to define your billable charge templates line characteristics.

Description of Page

The **Line Sequence** scroll defines the billable charge template line to which you wish to assign characteristic values.

The characteristics grid supports all standard characteristic types (such as, Adhoc, Predefined, File Location, and Foreign Key) from the Billable Charge Template Line Characteristics table.

To modify billable charge template line characteristics, simply move to a field and change its value. To add characteristics, press + to insert a row and then fill in the information for each field. The following fields display:

Characteristic Type The type of characteristic.

Characteristic Value The value of the characteristic.

Billable Charge Template - SQ Details

Open **Admin > Billing > Billable Charge Template > Search** and navigate to the **SQ Details** page to define your billable charge templates service quantities.

Description of Page

To modify a template's service quantity, simply move to a field and change its value. To add a new service quantity to the billable charge template, press the + button to insert a row and fill in the information for each field. The following fields display:

Sequence Specify the sequence number of the SQ.

UOM Select the unit of measure of this SQ. One or more of UOM, TOU, or SQ identifier must be selected.

TOU Select the time of use period.

SQ Identifier Select the SQ identifier.

Service Quantity Specify the number of units of this service quantity.

Designing and Defining Bill Segment Types

Every service agreement references a service agreement (SA) type. Amongst other things, the SA type references a bill segment type. The bill segment type controls how bill segments and their related financial transactions are created.

WARNING:

We strongly recommend understanding the concepts described in [The Big Picture of Billing](#) before setting up your bill segment types.

The topics in this section describe how to design and set up bill segment types.

What Do Bill Segment Types Do?

Bill segment types control how bill segments and their related financial transactions are created. The following illustration will help you understand how the system uses bill segment types during the bill segment creation process:

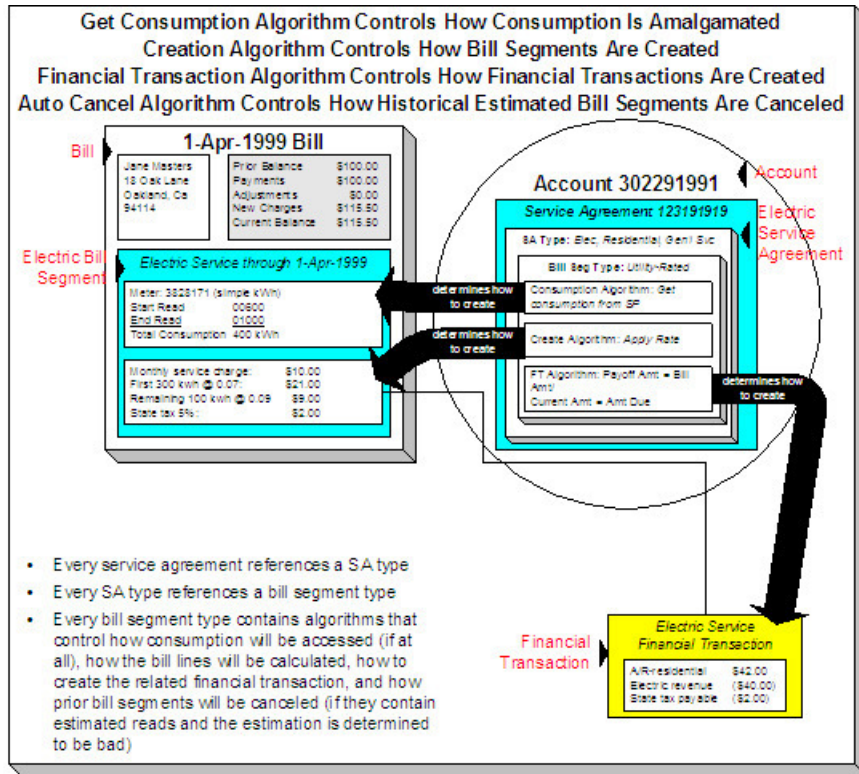

Designing Your Bill Segment Types

The following table contains a subset of the SA types listed under [Defining Service Agreement Types](#) and [Designing Your SA Types And Start Options For Sub SAs](#) and [Designing SA Types For Service Provider Financial Settlements](#). However, if you are reading this document from top to bottom, you probably don't know what your SA types are (they are only designed much later) and will have to forestall this task until that time.

We're going to cheat and assume you know what your SA types are and fill in the algorithms necessary to create bill segments for each SA type. After this table is complete, we will look for unique combinations of the 4 algorithms and create a bill segment type for each one.

NOTE:

Before you can fill in the columns for your own SA types, you should be comfortable with the descriptions of the algorithms described under [Setting Up Bill Segment Types](#).

Div.	Calculation	FT	Consumption	Auto Cancel
SA Type	Algorithm	Algorithm	Algorithm	Algorithm
CA/G-RES	Apply Rate To Usage Request	Payoff = Bill Amount / Current = Amount Due	Get Consumption Using Usage Request	NA - can't estimate consumption.
CA/G-COM	Apply Rate To Usage Request	Payoff = Bill Amount / Current = Amount Due	Get Consumption Using Usage Request	NA - can't estimate consumption.
CA/G-IND	Apply Rate To Usage Request	Payoff = Bill Amount / Current = Amount Due	Get Consumption Using Usage Request	NA - can't estimate consumption.

CA/CABLE	Apply Rate To Usage Request	Payoff = Bill Amount / Current = Amount Due	Get Consumption Using Usage Request	NA - can't estimate consumption.
CA/E-COY	Apply Rate To Usage Request	Payoff = 0 / Current = 0	Get Consumption Using Usage Request	NA - can't estimate consumption.
CA/E-RESU	Apply Rate To Usage Request	Payoff = Bill Amount / Current = Amount Due	Get Consumption Using Usage Request	NA - can't estimate consumption.
CA/E-COMU	Apply Rate To Usage Request	Payoff = Bill Amount / Current = Amount Due	Get Consumption Using Usage Request	NA - can't estimate consumption.
CA/WO-STD	N/A - non billable	N/A - non billable	N/A - non billable	N/A - non billable
CA/WO-LIA	N/A - non billable	N/A - non billable	N/A - non billable	N/A - non billable
CA/CHARITY	Recurring Charge	Payoff = 0 / Current = Bill Amount	N/A - no consumption is needed	N/A - no consumption is needed
CA/PA-REGU	Recurring Charge With Auto Stop	Payoff = 0 / Current = Bill Amount	N/A - no consumption is needed	N/A - no consumption is needed
CA/MERCH-I	Recurring Charge For Amount To Bill	Payoff = 0 / Current = Bill Amount	N/A - no consumption is needed	N/A - no consumption is needed
CA/DEP-I	Recurring Charge For Amount To Bill	Payoff = 0 / Current = Bill Amount	N/A - no consumption is needed	N/A - no consumption is needed
CA/ONETIME	Billable Charge	Payoff = Bill Amount / Current = Amount Due	N/A - no consumption is needed	N/A - no consumption is needed
CA/OVR UNDR	N/A - non billable	N/A - non billable	N/A - non billable	N/A - non billable
CA/E-SUB ENR	Apply Rate	Payoff = Bill Amount / Current = Amount Due		
CA/E-SUB BC	Billable Charge	Payoff = Bill Amount / Current = Amount Due	N/A - no consumption is needed	N/A - no consumption is needed
CA/E-FIN SETTL	N/A - non billable	N/A - non billable	N/A - non billable	N/A - non billable

Now, we'll extract unique combinations of the four algorithms and create a bill segment type for each.

Bill Segment Type	Calculation Algorithm	FT Algorithm	Consumption Algorithm	Auto Cancel Algorithm
BD RATED	Apply Rate To Usage Request	Payoff = Bill Amount / Current = Amount Due	Get Consumption Using Usage Request	NA - can't estimate consumption.
BILLCHRG	Billable Charge	Payoff = Bill Amount / Current = Amount Due	N/A - no consumption is needed	N/A - no consumption is needed
COMPUSAG	Apply Rate To Usage Request	Payoff = 0 / Current = Bill Amount	Get Consumption Using Usage Request	N/A - no consumption is needed
RECUR	Recurring Charge	Payoff = 0 / Current = Bill Amount	N/A - no consumption is needed	N/A - no consumption is needed
RECUR AS	Recurring Charge With Auto Stop	Payoff = 0 / Current = Bill Amount	N/A - no consumption is needed	N/A - no consumption is needed
RECURATB	Recurring Charge For Amount To Bill	Payoff = 0 / Current = Bill Amount	N/A - no consumption is needed	N/A - no consumption is needed
SUB RATE	Apply Rate	Payoff = Bill Amount / Current = Amount Due	Get Consumption From Master Bill Segment	N/A - rated sub service agreements are cancelled

when their master is canceled.

SUB BC	Billable Charge	Payoff = Bill Amount / Current = Amount Due	N/A - no consumption is needed	N/A - no consumption is needed
--------	-----------------	---	--------------------------------	--------------------------------

Just to make sure everything has been designed appropriately, we will return to our SA type samples and specify their respective bill segment types:

Div.	Calculation	FT	Consumption	Auto Cancel	Bill Segment Type
SA Type	Algorithm	Algorithm	Algorithm	Algorithm	
CA/G-RES	Apply Rate To Usage Request	Payoff = Bill Amount / Current = Amount Due	Get Consumption Using Usage Request	NA - can't estimate consumption.	BD RATED
CA/G-COM	Apply Rate To Usage Request	Payoff = Bill Amount / Current = Amount Due	Get Consumption Using Usage Request	NA - can't estimate consumption.	BD RATED
CA/E-RES	Apply Rate To Usage Request	Payoff = Bill Amount / Current = Amount Due	Get Consumption Using Usage Request	NA - can't estimate consumption.	BD RATED
CA/E-COM	Apply Rate To Usage Request	Payoff = Bill Amount / Current = Amount Due	Get Consumption Using Usage Request	NA - can't estimate consumption.	BD RATED
CA/G-IND	Apply Rate To Usage Request	Payoff = Bill Amount / Current = Amount Due	Get Consumption Using Usage Request	NA - can't estimate consumption.	BD RATED
CA/CABLE	Apply Rate To Usage Request	Payoff = Bill Amount / Current = Amount Due	Get Consumption Using Usage Request	NA - can't estimate consumption.	BD RATED
CA/E-COY	Apply Rate To Usage Request	Payoff = 0 / Current = Bill Amount	Get Consumption Using Usage Request	N/A - no consumption is needed.	COMPUSAG
CA/WO-STD	N/A - non billable	N/A - non billable	N/A - non billable	N/A - non billable	
CA/WO-LIA	N/A - non billable	N/A - non billable	N/A - non billable	N/A - non billable	
CA/CHARITY	Recurring Charge	Payoff = 0 / Current = Bill Amount	N/A - no consumption is needed	N/A - no consumption is needed	RECUR
CA/PA-REGU	Recurring Charge With Auto Stop	Payoff = 0 / Current = Bill Amount	N/A - no consumption is needed	N/A - no consumption is needed	RECUR-AS
CA/MERCH-I	Recurring Charge For Amount To Bill	Payoff = 0 / Current = Bill Amount	N/A - no consumption is needed	N/A - no consumption is needed	RECUR-AS
CA/DEP-I	Recurring Charge For Amount To Bill	Payoff = 0 / Current = Bill Amount	N/A - no consumption is needed	N/A - no consumption is needed	RECURATB
CA/ONETIME	Billable Charge	Payoff = Bill Amount / Current = Amount Due	N/A - no consumption is needed	N/A - no consumption is needed	BILLCHRG

CA/OVR UNDR	N/A - non billable	N/A - non billable	N/A - non billable	N/A - non billable	
CA/E-SUB ENR	Apply Rate	Payoff = Bill Amount / Current = Amount Due	Get Consumption From Master Bill Segment	N/A - rated sub service agreements are cancelled when their master is canceled.	SUB RATE
CA/E-SUB BC	Billable Charge	Payoff = Bill Amount / Current = Amount Due	N/A - no consumption is needed	N/A - no consumption is needed	SUB BC
CA/E-FIN SETTL	N/A - non billable	N/A - non billable	N/A - non billable	N/A - non billable	

And now you're ready to set up your bill segment types.

Setting Up Bill Segment Types

To set up bill segment types, open **Admin > Billing > Bill Segment Type > Add**.

Description of Page

Enter an easily recognizable **Bill Segment Type** and **Description** for every type of bill segment.

For each bill segment type, define the **Create Algorithm**. The logic embedded in this algorithm creates the bill segment. Refer to [Designing Your Bill Segment Types](#) for examples.

If you haven't done so already, you must set up this algorithm in the system. To do this:

- Create a new algorithm (refer to [Setting Up Algorithms](#)).
- On this algorithm, reference an Algorithm Type that creates a bill segment in the appropriate manner.

WARNING:

The **BS Create Algorithm** is a very important field as it controls how the system creates bill segments. There are some restrictions in respect of the values of certain fields on the SA type and the bill segment algorithm used on a SA type. Refer to [Require Total Amount Switch versus Bill Segment Creation Algorithm](#), [Allow Recurring Charge Switch versus Bill Segment Creation Algorithm](#), and [Rate Required Switch versus Bill Segment Creation Algorithm](#) for more information.

For each bill segment type, define the **Financial Algorithm**. The logic embedded in this algorithm constructs the financial transaction associated with the bill segment. Refer to [Designing Your Bill Segment Types](#) for examples.

If you haven't done so already, you must set up this algorithm in the system. To do this:

- Create a new algorithm (refer to [Setting Up Algorithms](#)).
- On this algorithm, reference an Algorithm Type that constructs the bill segment financial transaction in the appropriate manner.

FASTPATH:

For more information about current and payoff amounts, refer to [Current Amount versus Payoff Amount](#).

If the bill segment requires consumption (e.g., meter reads) to be retrieved, define the **Get Consumption Algorithm**. The logic embedded in this algorithm retrieves the consumption that is billed on the bill segment. Refer to [Designing Your Bill Segment Types](#) for examples.

If you haven't done so already, you must set up this algorithm in the system. To do this:

- Create a new algorithm (refer to [Setting Up Algorithms](#)).
- On this algorithm, reference an Algorithm Type that retrieves consumption in the appropriate manner.

The **Auto Cancel Algorithm** is used by the system when it detects that a prior bill segment contains an estimated read that meets certain conditions when a non-estimated read is used on the current bill.

Examples include:

- The prior bill segment contains a bad estimated read (by "bad" we mean that the current bill has a non-estimated reading that is less than the estimated end read on the prior bill segment).
- The prior bill segment contains an estimated read (there may be situations where you want to cancel an estimated bill segment when a non-estimated read is also higher than the end read on the prior bill segment. For example, when tiered rates may cause a customer to be penalized by consumption being charged at a higher rate).

For detecting a bad estimated read on the prior bill segment, if you haven't done so already, you must set up this algorithm in the system. To do this:

- Create a new algorithm (refer to [Setting Up Algorithms](#)).
- On this algorithm, reference an Algorithm Type that cancels bill segments that contain poorly estimated consumption.

For detecting an estimated read on the prior bill segment, if you haven't done so already, you must set up this algorithm in the system and configure a feature configuration option. To do this:

- Create a new algorithm for the Auto Cancel Algorithm.
- On this algorithm, reference an Algorithm Type that cancels bill segments that contain estimated consumption (refer to [Setting Up Algorithms](#)).
- Configure the **Always Call Auto Cancel** option type on the Financial Transactions Option feature configuration and set the option type value to 'Y'. For more information about Feature Configurations, see [Defining Feature Configurations](#).

Note that the **Auto Cancel Algorithm** is not used in Oracle Utilities Customer To Meter. The following features replace the algorithm:

- Usage Transaction Correction Processor
 - This is created during IMD processing when an anomaly is detected in the reads used in usage calculation. It sets the stage for sending the corrected read notification
 - The Usage Transaction Correction Processor monitor job (D1-UTCRN) must be scheduled after all IMD processing batch jobs.
- Corrected Reads Notification
 - The application may be configured to automatically process all corrected read notifications by submitting the Corrected Reads Notification monitor job (C1-TCRNB). Refer to the configuration guideline below for automating this process.
 - If manual rebill is preferred, billing user may navigate to the off cycle generator portal to search for a customer's corrected read notification, review and rebill them one at a time starting from the oldest bill segment.
- Final Measurement Replacement — It is recommended that this VEE rule be configured for IMD processing. It is used to reject small changes in reads, which in turn prevents the creation and sending corrected reads notification and subsequent re-bill that would have resulted to small net differences in charges.

The **Bill Segment Information Algorithm** is used by the system to format the bill segment information that appears throughout the system. If the information you'd like displayed differs for bill segment types, you must set up this algorithm in the system. To do this:

Designing and Defining Deposit Classes

If you bill for deposits, you must set up one or more deposit classes. If your company does not bill for deposits, you can skip this section.

FASTPATH:

We strongly recommend familiarizing yourself with the concepts described in [The Big Picture Of Deposits](#) before tackling the information in this section.

The topics in this section describe how to design and set up deposit classes.

What Do Deposit Classes Do?

A deposit class contains the business rules that govern:

- How and when deposit interest is calculated.
- How the recommended deposit amount is calculated.
- When a deposit will be automatically refunded to a customer.
- When the system will recommend a new or additional deposit.

When you link a deposit class to a SA type, you are indicating that the SA type's service agreements are governed by the deposit class' business rules.

In addition to linking a deposit class to the SA types used to bill for a deposit, you must also define a deposit class on SA types whose debt is covered by a deposit. Consider the following examples:

- Assume your company sells electricity, gas, and water; but deposits are only held only for electric service. In this situation, you'd need one deposit class - Electric - and you'd associate it with both the electric deposit SA type and the electric usage SA type(s) (the gas and water SA types would NOT reference a deposit class).
- If your company can apply a deposit to any type of debt, then you'd have just one deposit class - General Deposit. You'd link this deposit class to the deposit SA type, and to the other SA types whose debt is covered by the deposit.

NOTE:

Non-cash deposits. You can also use the system to manage non-cash deposits (e.g., letters of credit, surety bonds, 3rd party deposits). Non-cash deposits are held in respect of an account (and an account may have an unlimited number of non-cash deposits). Each non-cash deposit must reference a deposit class. Why? Because the system amalgamates cash and non-cash deposits when it determines if an account is holding an adequate deposit. Refer to [3rd Party Deposits](#) for more information.

Designing Your Deposit Classes

A deposit class contains the business rules that govern:

- How and when deposit interest is calculated.
- How the recommended deposit amount is calculated.
- When a deposit will be automatically refunded to a customer.
- When the system will recommend a new or additional deposit.

You will need multiple deposit classes if any of the above rules / conditions differ for different types of customers. For example, if residential customers use a different recommended deposit algorithm as compared to commercial customers, you'd need one deposit class for residential and another for commercial.

You will need additional deposit classes if your customers can have multiple deposits where each deposit is restricted to a specific type of debt. For example, if separate deposits are held for regulated and unregulated debt (and a customer could hold a combination of regulated and unregulated debt), you'd need one deposit class for regulated debt and another for unregulated debt.

We'll design deposit classes to satisfy the needs of a theoretical company to help you understand how to design your deposit classes. The following points describe the deposit requirements of our theoretical company:

- The recommended deposit amount is 2 times the average bill (averaged over the last 12 months). This is true regardless of the type of customer or debt.
- The system should automatically refund a deposit to a customer after:
 - The deposit has been held for at least 6 months; and
 - The account's credit rating is greater than the credit rating threshold defined on the installation record or the account's CIS Division (i.e., the credit rating is no longer considered bad)
- This is true regardless of the type of customer or debt.
- Interest is calculated every 6 months. The interest rate is defined using a bill factor (refer to [Setting Up Bill Factors](#) for more information). This is true regardless of the type of customer or debt.
- When it's time to refund a deposit, all outstanding debt will be paid off first. If any moneys remain, a check should be sent to the customer for the remainder. This is true regardless of the type of customer or debt.
- A customer could have both regulated and unregulated debt under a single account. When this happens, separate deposits will be held for each type of debt (where the regulated deposit can only be used to satisfy regulated debt and the unregulated deposit can only be used to satisfy unregulated debt).

You'd need the following deposit classes to satisfy the above requirement:

Deposit Class	Recommended Amount Rule	Auto Refund Condition	Interest Rules	Deposit Refund Method
Regulated	2 x Average Bill	Held for 6 months and credit rating is good	Simple interest every 6 months	Apply to outstanding debt first, refund remainder with a check
Unregulated	2 x Average Bill	Held for 6 months and credit rating is good	Simple interest every 6 months	Apply to outstanding debt first, refund remainder with a check

You may wonder why two deposit classes are needed when the rules are the same for both? Well, besides defining the applicable business rules for a deposit service agreement, a deposit class is defined on the SA types whose debt is covered by the deposit class' deposit. So, if you have two different types of debt where each type of debt can have its own deposit, you'd need at two deposit classes. Each deposit class would be associated with the service agreements that are being secured by the deposit.

Refer to [Setting Up Deposit Classes](#) for a description of the various algorithms defined in respect of a deposit class.

Setting Up Deposit Classes

In the previous section, *Designing Your Deposit Classes*, we presented a case study that illustrated a mythical organization's deposit classes. In this section, we explain how to maintain your Deposit Classes.

Deposit Class - Main

To set up deposit classes, select **Admin > Credit & Collection > Deposit Class > Add**.

Description of Page

Enter an easily recognizable **Deposit Class** and **Description**.

Use **Refund Description on Bill** to define the information that appears on the bill segment produced when it's time to refund the customer's deposit.

The remaining information on this page is used by the various deposit-oriented processes.

Refer to [Deposit Class - Good Customer](#) for information about the **Good Customer Algorithm**.

Refer to [Deposit Class - Recommendation](#) for information about the **Recommendation Algorithm** and **Review Tolerance Percentage**.

Refer to [Deposit Class - Refund Method](#) for information about the **Refund Method Algorithm**.

Refer to [Deposit Class - Refund Criteria](#) for information about the **Refund Criteria Algorithm**.

Refer to [Deposit Class - Refund Interest](#) for information about the **Interest Refund Algorithm** and **Months Between Interest Refund**.

Refer to [Deposit Class - Review Method](#) for information about the **Review Method Algorithm**.

Deposit Class - Good Customer

On [Deposit Class - Main](#) you must define the **Good Customer Algorithm** used by the system when it determines if a customer is considered good (the system recommends new / additional deposits for bad customers). Refer to [Deposit Review](#) for a description of the background process that reviews customers for adequate deposits.

If you haven't done so already, you must set up this algorithm in the system. To do this:

- Create a new algorithm (refer to [Setting Up Algorithms](#)).
- On this algorithm, reference an Algorithm Type that determines if a customer is considered good.

Deposit Class - Recommendation

On [Deposit Class - Main](#) you must define the **Recommendation Algorithm** used by the system when it calculates a customer's recommended deposit amount.

If you haven't done so already, you must set up this algorithm in the system. To do this:

- Create a new algorithm (refer to [Setting Up Algorithms](#)).
- On this algorithm, reference an Algorithm Type that recommends deposits.

The system uses the **Review Tolerance Percentage** to prevent the recommendation of small deposits by the Deposit Review background process. For example, if this field contains 10(%), the system would only recommend an additional deposit if the recommended amount was more than 10% of the existing deposit.

Deposit Class - Refund Method

On [Deposit Class - Main](#) you must define the **Refund Method Algorithm** used by the system when it refunds a deposit to the customer.

If you haven't done so already, you must set up this algorithm in the system. To do this:

- Create a new algorithm (refer to [Setting Up Algorithms](#)).

- On this algorithm, reference an Algorithm Type that refunds a deposit to a customer.

Deposit Class - Refund Criteria

On [Deposit Class - Main](#) you must define the **Refund Criteria Algorithm** used by the system when it determines if it should automatically refund a deposit to a customer. Refer to [Deposit Review](#) for a description of the background process that reviews deposits for refunds.

If you haven't done so already, you must set up this algorithm in the system. To do this:

- Create a new algorithm (refer to [Setting Up Algorithms](#)).
- On this algorithm, reference an Algorithm Type that determines if a customer qualifies for a deposit refund.

Deposit Class - Refund Interest

On [Deposit Class - Main](#) you must define the **Interest Refund Algorithm** to define how the system calculates interest and how it refunds the interest to the customer.

If you haven't done so already, you must set up this algorithm in the system. To do this:

- Create a new algorithm (refer to [Setting Up Algorithms](#)).
- On this algorithm, reference an Algorithm Type that calculates interest on a deposit.

Interest will be automatically calculated every X months where X is defined in **Months Between Interest Refund**. Refer to [Deposit Interest](#) for a description of the background process that calculates interest on deposits. Also note that interest is calculated when a [deposit service agreement is stopped](#).

Deposit Class - Review Method

On [Deposit Class - Main](#) you must define the **Review Method Algorithm** used by the system to determine what action to take if the system recommends a deposit (or additional deposit) amount for an account. Refer to [Review Deposits](#) for a description of the background process that reviews deposits for refunds. The algorithm supplied with the base product highlights new deposits and deposit amounts on the [Deposit Review](#) page.

If you haven't done so already, you must set up this algorithm in the system. To do this:

- Create a new algorithm (refer to [Setting Up Algorithms](#)).
- On this algorithm, reference an Algorithm Type that determines the review method the system uses if it recommends a deposit or additional deposit be applied to an account.

Setting Up Non-Cash Deposit Types

Non-cash deposit types are used to indicate the type of monetary instrument used for non-cash deposits. Refer to [Non-Cash Deposits](#) for more information.

To define your non-cash deposit types, select **Admin > Credit & Collection > Non-Cash Deposit Type**.

Description of Page

To modify a non-cash deposit type, move to a field and change its value.

To add a new non-cash deposit type, insert a row, then fill in the information for each field. The following fields display:

Non-Cash Deposit Type The unique identifier of the non-cash deposit type.

Description The description of the non-cash deposit type.

Review Before Expiration This switch indicates if the system will create a To Do entry when non-cash deposits of this type are close to expiration.

Third Party Deposit This switch indicates if the system requires a reference to a 3rd party's deposit service agreement for this type of non-cash deposit. Refer to [3rd Party Deposits](#) for more information.

Setting Up Payment Segment Types

Every service agreement references a service agreement (SA) type. Amongst other things, the SA type references a payment segment type. The payment segment type controls how payment segments and their related financial transactions are created. To set up payment segment types, open **Admin > Payment Segment Type**.

Description of Page

Enter an easily recognizable **Payment Segment Type** and **Description** for every type of payment segment.

FASTPATH:

For more information about the source of the distribution codes on financial transactions, see [The Source Of GL Accounts On Financial Transactions](#).

For each payment segment type, define the **Payment Segment Fin Algorithm**. The logic embedded in this algorithm constructs the actual financial transaction associated with the payment segment. Refer to [Examples of Common Payment Segment Types](#) for examples of how algorithms are used on common payment segment types.

If you haven't done so already, you must set up this algorithm in the system. To do this:

- Create a new algorithm (refer to [Setting Up Algorithms](#)).
- On this algorithm, reference an Algorithm Type that constructs the payment segment financial transaction in the appropriate manner.

FASTPATH:

For more information about current and payoff amount, see [Current Amount versus Payoff Amount](#).

Examples of Common Payment Segment Types

The following table shows several classic payment segment types used by many organizations:

Payment Segment Type	Payment Segment Financial Transaction Algorithm
Normal payment (if you practice accrual accounting). Refer to Accrual versus Cash Accounting for more information.	Payoff = Pay Amount / Current = Pay Amount (no cash accounting)
Normal payment (if you practice cash accounting). Refer to Accrual versus Cash Accounting for more information.	Payoff = Pay Amount / Current = Pay Amount (plus Cash Accounting)
Charity payment	Payoff = 0 / Current = Pay Amount (the GL is affected)

Designing And Defining Adjustment Types

A service agreement's debt may be changed with an adjustment. Every adjustment must reference an adjustment type. The adjustment type contains a great deal of information that is defaulted onto the adjustment, including whether the adjustment amount is calculated. It also controls many business processes associated with the adjustment. The topics in this section describe how to design and set up adjustment types.

What Do Adjustment Types Do?

An adjustment type contains the business rules that govern how its adjustments are managed by the system. Please refer to [The Big Picture Of Adjustments](#) for a complete description of how adjustment types impact the lifecycle of adjustments.

Setting Up Adjustment Types

The topics in this section describe how to set up adjustment types.

NOTE:

When a new adjustment type is added. When you introduce a new adjustment type, you must update one or more adjustment profiles with the new adjustment type. Why? Because adjustment profiles define the adjustment types that may be levied on service agreements (adjustment profiles are defined on SA types). If you don't put the adjustment type on an adjustment profile, the adjustment type can't be used on any adjustment.

Adjustment Type - Main

To set up adjustment types, open **Admin > Financial > Adjustment Type > Add.**

Description of Page

Enter a unique **Adjustment Type ID** and **Description** for the adjustment type.

If your implementation requires restricting the list of adjustments types that users are able to select by CIS Division, specify a **CIS Division** on the adjustment type.

The **AdjustmentAmount Type** indicates whether the adjustment amount is calculated or not. Select Calculated Amount when you want to use a rate to perform calculations to generate the adjustment amount otherwise select Non-Calculated Amount. Refer to [Setting Up Calculated Adjustment Types](#) for more information about calculated adjustments.

Enter the **Distribution Code** that references the GL account associated with the adjustment. For example, if this adjustment type is used to levy a charge for a bad check, the distribution code would reference the revenue account to which you associate such revenue. Note, the offsetting distribution code is kept on the SA type.

NOTE:

Distribution Code for Calculated Adjustments. Depending on the algorithm used for the [calculated adjustment](#), the distribution code may come from the adjustment type or the calculation lines of the algorithm. If the adjustment's

calculation algorithm gets the distribution code from the calculation lines, you do not need to specify a distribution code on the adjustment type.

FASTPATH:

For more information about the source of the distribution codes on financial transactions, see [The Source Of GL Accounts On Financial Transactions](#).

Enter the **Currency Code** for adjustments of this type.

Turn on **Sync. Current Amount** if adjustments of this type exist to force a service agreement's current balance to equal its payoff balance. These types of adjustments are issued before a service agreement's funds are transferred to a write-off service agreement. If this switch is on, choose an **Adjustment Fin Algorithm** that does not impact payoff balance or the GL, but does affect the SA's current balance (refer to ADJT-CA for an example of such an algorithm).

Enter a **Default Amount** if an amount should be **defaulted** onto adjustments of this type.

FASTPATH:

For more information about current and payoff amounts, refer to [Current Amount versus Payoff Amount](#).

If the AP Adjustment should be recorded in respect of the customer's 1099 amounts, indicate the **A/P 1099 Flag**. This would typically be used on the adjustment used to credit the deposit service agreement with accrued interest. The values of this field are Interest and Miscellaneous. This type of adjustment would also have an **A/P Request Type Code** selected, as 1099 reporting is handled in A/P.

Turn on **Print By Default** if information about adjustments of this type should print on the account's next bill.

Choose an **A/P Request Type Code** if this adjustment is interfaced to accounts payable (i.e., it's used to send a refund check to a customer). Refer to [A/P Check Request](#) for more information.

The **Adjustment Freeze Option** defines when adjustments can be frozen and therefore when a service agreement's balance and the general ledger are affected by an adjustment. Refer to [Preventing SA Balances And The GL From Being Impacted Until Bill Completion](#) to understand the significance of this option. Also note, if the **installation option's** Bill Segment Freeze Option is Freeze At Will, this field is defaulted to Freeze At Will and cannot be changed.

WARNING:

Adjustment types for adjustments created during bill completion (e.g., by a bill completion algorithm) must have their adjustment freeze option set to Freeze At Will. Otherwise (i.e., if the option is Freeze At Bill Completion) they will not be frozen until a subsequent bill is completed.

If adjustments of this type require approval, define an **Approval Profile**. For more information, refer to [The Big Picture of Adjustment Approvals](#).

Enter the verbiage to appear on the printed bill in **Description on Bill**.

Use the characteristics collection to define a **Characteristic Type** and **Characteristic Value** common to all adjustments of this type. These can be used for reporting purposes or in your algorithms.

Adjustment Type - Adjustment Characteristics

To define characteristics that can be defined for adjustments of a given type, open **Admin > Financial > Adjustment Type > Search** and navigate to the **Adjustment Characteristics** page.

Description of Page

Use the **Adjustment Characteristics** collection to define characteristics that can be defined for adjustments of a given type. Turn on the **Required** switch if the **Characteristic Type** must be defined on adjustments of a given type. Enter a **Characteristic Value** to use as the default for a given **Characteristic Type** when the **Default** switch is turned on. Use **Sequence** to control the order in which characteristics are defaulted.

Adjustment Type - Algorithms

To define algorithms for adjustments, open **Admin > Financial > Adjustment Type > Search** and navigate to the **Algorithms** page.

Description of Page

The grid contains **Algorithms** that control important adjustment functions. If you haven't already done so, you must [set up the appropriate algorithms](#) in your system. You must define the following for each algorithm:

- Specify the **System Event** with which the algorithm is associated (see the table that follows for a description of all possible events).
- Specify the **Sequence Number** and **Algorithm** for each system event. You can set the **Sequence Number** to 10 unless you have a **System Event** that has multiple **Algorithms**. In this case, you need to tell the system the **Sequence** in which they should execute.

The following table describes each **System Event**.

System Event	Optional / Required	Description
Adjustment Cancellation	Optional	When an adjustment is canceled an algorithm of this type may be called to do additional work. Refer to The Lifecycle Of An Adjustment for more information about canceling an adjustment.
Adjustment Freeze	Optional	When an adjustment is frozen an algorithm of this type may be called to do additional work. Refer to The Lifecycle Of An Adjustment for more information about freezing an adjustment.
Adjustment Information	Optional	We use the term "Adjustment information" to describe the basic information that appears throughout the system to describe an adjustment. The data that appears in "Adjustment information" is constructed using this algorithm. Plug an algorithm into this spot to override the "Adjustment information" algorithm on installation options or the system default "Adjustment information" if no such algorithm is defined on installation options.
Adjustment FT Creation	Required	Algorithms of this type are used to construct the actual financial transaction associated with the adjustment. The financial transaction controls the adjustment's affect on the service agreement's payoff and current balances. It also constructs the information that is

eventually interfaced to your general ledger. Refer to [Examples of Common Adjustment Types](#) for examples of how algorithms are used on common adjustment types.

Default Adjustment Amount	Optional	Algorithms of this type are used to default the adjustment amount. Refer to Default the Adjustment Amount for more information.
Determine SA	Optional	Algorithms of this type are used to find a service agreement for which the adjustment can be posted. This plug-in is used particularly during adjustment upload when a staging record does not identify the SA ID. Refer to Interfacing Adjustments From External Sources for more information.
Resolve Suspense	Optional	Algorithms of this type are used to automatically resolve adjustments that are in suspense. Refer to Suspense Adjustments for more information
Generate Adjustment	Optional	Algorithms of this type are used to calculate the adjustment amount if an adjustment type indicates that the adjustment amount is calculated. Refer to Setting Up Calculated Adjustment Types for more information.
Validate Adjustment	Optional	Algorithms of this type are used to validate information for the adjustment after it is generated.

Setting Up Calculated Adjustment Types

You can use an algorithm to calculate an adjustment amount for example if you need to calculate tax on a base amount or calculate a non-sufficient funds charge based on the customer's credit rating. Because the base package algorithm calculates adjustment amounts by calling the rate application, calculated adjustments are sometimes referred to as ratable adjustments.

NOTE:

Ratable Adjustments Appear Deceptively Simple. But, they are not. Calculated adjustments that use the base package algorithm have all the power and flexibility (and complexity) of the rate application. Anything that you can do with a rate can be applied to a calculated adjustment. For examples that illustrate the flexibility of the rate application (and therefore calculated adjustments), refer to [Rate Examples](#).

Adjustment types that indicate they are calculated have a generate adjustment algorithm. The base package algorithm defines the rate schedule used to calculate the adjustment as well as any UOM, TOU or SQI parameters.

To set up calculated adjustment types using the base package generate adjustment algorithm type:

- Define the rate that performs the calculations, including the rate schedule, calculation groups, and calculation rules. Refer to [Rates](#) for information.

NOTE:

If you create your own Generate Adjustment algorithm type, you may not need to set up a rate that performs the calculations. It depends on the needs of your algorithm type.

- Create a Generate Adjustment algorithm (refer to [Setting Up Algorithms](#)) that references the base package algorithm type that generates calculated adjustments (see the table above).
- If you want the generation algorithm's calculation lines to provide the distribution codes when the adjustment is posted to the GL, create an Adjustment Financial Transaction algorithm (refer to [Setting Up Algorithms](#)) that references an algorithm type that creates the adjustment's financial transactions using the calculation lines. A parameter of the adjustment financial transaction algorithm determines whether the distribution codes are taken from the adjustment type (AT) or calculation lines (CL). The system comes supplied with several sample algorithm types that create adjustment financial transactions.
- Create an adjustment type where the **Adjustment Amount Type** is Calculated Amount, the Generate Adjustment event references the generation algorithm created above, and the Adj. Financial Transaction event references the adjustment financial transaction algorithm created above.

Examples of Common Adjustment Types

The following table shows several classic adjustment types used by many organizations:

Adjustment Type	Typical Distribution Code	Default Amount	Financial Transaction Algorithm	Print On Bill	A/P Adjust-ment	1099
NSF	NSF revenue	Your NSF fee	Payoff = Current = Adj. Amt Refer to ADJT-NM for an example of such an algorithm type	Yes	No	No
LPC	Late payment charge revenue	N/A	Payoff = Current = Adj. Amt Refer to ADJT-NM for an example of such an algorithm type	Yes	No	No
CONNECT	Connection charge revenue	Your connection charge	Payoff = Current = Adj. Amt Refer to ADJT-NM for an example of such an algorithm type	Yes	No	No
CUSTREL	Customer relationship expense	N/A	Payoff = Current = Adj. Amt Refer to ADJT-NM for an example of such an algorithm type	Yes	No	No
ADDCHARG	Misc Revenue	N/A	Payoff = Current = Adj. Amt	Yes	No	No

			Refer to ADJT-NM for an example of such an algorithm type			
XFER	Balance transfer clearing	N/A	Payoff = Current = Adj. Amt Refer to ADJT-NM for an example of such an algorithm type	Yes	No	No
WO SYNC	N/A	N/A	Payoff = 0 / Current = Adj. Amt Refer to ADJT-CA for an example of such an algorithm type	No	No	No
REFUNDAP	A/P clearing	N/A	Payoff = Current = Adj. Amt Refer to ADJT-NM for an example of such an algorithm type	Yes	Yes	No
DPA FIX	N/A	N/A	Payoff = 0 / Current = Adj. Amt Refer to ADJT-CA for an example of such an algorithm type	Yes	No	No
CHARITFX	N/A	N/A	Payoff = 0 / Current = Adj. Amt Refer to ADJT-CA for an example of such an algorithm type	Yes	No	No
BUDG ON	N/A	N/A	Payoff = 0 / Current = Adj. Amt Refer to ADJT-CA for an example of such an algorithm type	Yes	No	No
BUDG OFF	N/A	N/A	Payoff = 0 / Current = Adj. Amt Refer to ADJT-CA for an	Yes	No	No

			example of such an algorithm type			
BUDG FIX	N/A	N/A	Payoff = 0 / Current = Adj. Amt Refer to ADJT-CA for an example of such an algorithm type	Yes	No	No
DEPOSREF	N/A	N/A	Payoff = 0 / Current = Adj. Amt Refer to ADJT-CA for an example of such an algorithm type	Yes	No	No
DEPOSIT	Interest expense	N/A	Payoff = Current = Adj. Amt. Refer to ADJT-NM for an example of such an algorithm type. Or Payoff Amt = Adj Amt / Current Amt = 0. Refer to ADJT-TA for an example of such an algorithm type. Use the first method if you want to have the interest reflected as a credit balance on the customer's bill. Use the second method if you roll the interest amount into the customer's existing deposit on hand.	Yes	No	Yes
DEPFXCR	N/A	N/A	Payoff = 0 / Current = Adj. Amt Refer to ADJT-CA for an	No	No	No

Setting Up Adjustment Type Profiles

Adjustment type profiles categorize your adjustment types into logical groups. When you link a profile to a SA type, you limit the type of adjustments to be linked to the SA type's service agreements. The creation of adjustment profiles and their linkage to SA types prevents inappropriate adjustments from being linked to your service agreements. More than one adjustment type profile may be linked to a SA type.

For example, you can create an adjustment type profile called Miscellaneous Fees and link to it the miscellaneous fee adjustment types. Then, you would link this profile to those SA types that are allowed to levy such fees.

NOTE:

Bottom line. An adjustment can only be linked to a service agreement if its adjustment type is part of an adjustment type profile that is valid for the service agreement's SA type. If an adjustment type is not linked to a profile, it could never be levied.

To set up adjustment type profiles, open **Admin > Financial > Adjustment Type Profile > Add.**

Description of Page

Enter a unique **Adjustment Type Profile** and **Description** for the adjustment type profile.

Indicate the **Adjustment Types** that are part of the profile.

Examples Of Common Adjustment Profiles

The following table shows several classic adjustment profiles used by many organizations (we've displayed some attributes from the adjustment type in the following table to help make it more understandable):

Adjustment Profile	Adjustment Type	Typical Distribution Code	Default Amount	Financial Transaction Algorithm
FEES	NSF	NSF revenue	Your NSF fee	Payoff Amt = Adj Amt / Current Amt = Adj Amt
	LPC	Late payment charge revenue	Your LPC	Payoff Amt = Adj Amt / Current Amt = Adj Amt
	CONNECT	Connection charge revenue	Your connection charge	Payoff Amt = Adj Amt / Current Amt = Adj Amt
MISCEXP	CUSTREL	Customer relationship expense	N/A	Payoff Amt = Adj Amt / Current Amt = Adj Amt
XFER	TRANSBAL	Balance transfer clearing	N/A	Payoff Amt = Adj Amt / Current Amt = Adj Amt
REFUND	REFUND	A/P clearing	N/A	Payoff Amt = Adj Amt / Current Amt = Adj Amt
DPA	ADJCURR	N/A	N/A	Payoff Amt = 0 / Current Amt = Adj Amt
	SYNCCURR	N/A	N/A	Payoff Amt = 0 / Current Amt = Adj Amt

CHARITY	CHAR FIX	N/A	N/A	Payoff Amt = 0 / Current Amt = Adj Amt
BUDGET	BUDG ON	N/A	N/A	Payoff Amt = 0 / Current Amt = Adj Amt
	BUDG OFF	N/A	N/A	Payoff Amt = 0 / Current Amt = Adj Amt
	BUDG FIX	N/A	N/A	Payoff Amt = 0 / Current Amt = Adj Amt
	FIX PAY	Customer relationship expense	N/A	Payoff Amt = Adj Amt / Current Amt = 0
DEPOSIT	DEPOSBILL	N/A	Your standard deposit amount	Payoff Amt = 0 / Current Amt = Adj Amt
	DEPOSINT	Interest expense	N/A	Payoff Amt = Adj Amt / Current Amt = Adj Amt
	SYNCCURR	N/A	N/A	Payoff Amt = 0 / Current Amt = Adj Amt
	ADJCUR	N/A	N/A	Payoff Amt = 0 / Current Amt = Adj Amt

The Big Picture Of Adjustment Approval

Some implementations require adjustments to be approved by one or more managers before they impact a customer's debt and the general ledger. For example, an adjustment used to rebate a credit balance may require managerial approval before the rebate is sent to the customer. The topics in this section describe how to set up the system to support the approval of adjustments.

Approval Is Controlled By Approval Profiles

An approval profile contains the rules that define if and how an adjustment is approved. If an adjustment type does not reference an approval profile, the related adjustments do not require third-party approval before they impact a customer's debt. If an adjustment type references an approval profile, the approval profile's approval hierarchy defines if the adjustment requires approval and who the authorized approvers are. For example, an approval profile can be configured with the following approval hierarchy:

- Adjustments < \$0 require approval by the "credit approvers role"
- Adjustments >= \$0 and <= \$10 do not require approval
- Adjustments > \$10 and <= \$100 require the approval of a user that belongs to the "level 1 approvers role"
- Adjustments > \$100 require two levels of approval: first a user that belongs to the "level 1 approvers role" must approve the adjustment; afterwards, the adjustment must be approved by a user that belongs to the "level 2 approvers role"

NOTE:

Transfer adjustments. The term "transfer adjustment" refers to two adjustments that are used to transfer moneys between two service agreements. The adjustment with the positive amount is considered to be the debit adjustment; the other adjustment is considered the credit adjustment. When a transfer adjustment requires approval, only one of the

adjustments needs to be approved. You control whether the debit side or the credit side of a transfer adjustment is used to control the approval process when you set up the approval profile.

Approval Profiles Can Be Linked To Multiple Adjustment Types

Approval hierarchies are frequently the same for many adjustment types. The system allows an approval profile to be linked to multiple adjustment types to simplify the definition and maintenance of the rules over time.

Adjustments Created In Batch Are Not Approved

The system assumes that no approval is necessary for adjustments created by batch processes even those whose adjustment type references an approval profile.

Approval Inserts A Step Into An Adjustment's Lifecycle

[The Lifecycle Of An Adjustment](#) explains how an adjustment is transitioned from the Freezable state to the Frozen state when it should impact the general ledger and the customer's balance. If an adjustment's adjustment type references an approval profile, the user cannot freeze the adjustment directly. Rather, the user must submit the adjustment for approval when it's ready and only when the last applicable approver approves the adjustment will it become Frozen.

NOTE:

Freeze during bill completion. You can configure the system to only freeze certain types of adjustments when the next bill is completed for the adjustment's account. When the last approver approves such adjustments, they remain in the Freezable. When the next bill is completed for the account, these adjustment become Frozen. Such adjustments that have not been approved at the time of bill completion will remain in the Freezable state. Refer to [Preventing SA Balances And The GL From Being Impacted Until Bill Completion](#) for more information.

Approval Requests Manage And Audit The Approval Process

Users submit an adjustment for approval using a dedicated button on the [Adjustment](#) page. When an adjustment is submitted for approval, the system creates an "approval request". The approval request determines if the adjustment requires approval and, if so, the list of approvers. If the adjustment does not require approval, the approval request is updated to indicate such and the adjustment is Frozen immediately (if freezing is allowed prior to bill completion). If the adjustment requires approval, the approval request's state becomes Approval In Progress and the approver(s) are notified.

NOTE:

Approval submission logic is customizable. The previous paragraph describes how the base-package works when an adjustment is submitted for approval. This logic resides in an algorithm that's plugged in on the C1-AdjustmentApprovalProfile business object in the Determine Approval Requirements system event. Your implementation can change this logic by developing a new algorithm and plugging it into this business object. If your logic is meant to supersede the base-package algorithm, remember to inactivate the base-package algorithm by adding an appropriate inactivation option to this business object.

To Do Entries Are Created To Notify Approvers

When an approval request detects an adjustment requires approval, it notifies the first approver by creating a To Do entry. The To Do entry is created using the To Do type and To Do role defined on the approval profile. All users who belong to the approving To Do role can see the entry. When a user drills down on an adjustment approval To Do entry, the [Adjustment - Approval](#) portal is opened. This portal contains summary information about the adjustment and the approval history of the adjustment. This portal is also where the user approves or rejects the adjustment.

When the first user in the To Do role approves an adjustment, the To Do entry is Completed and the approval request's audit log is updated. If there are no higher levels of approval required, the adjustment is Frozen (if freezing is allowed prior to bill completion) and the approval request is moved to the Approved state. If there are higher levels of approval required, a new To Do entry is created to the next To Do role in the approval hierarchy.

NOTE:

To Do entries can create email. A To Do entry can be configured to create an email message for every user in the To Do role to inform the user(s) of new adjustments requiring their attention. Refer to [To Do Entries May Be Routed Out Of The System](#) for the details.

Monitoring and Escalating Approval Requests

The base-package is supplied with an algorithm that your implementation can use to monitor approval requests that have been waiting too long for approval. This algorithm can complete the current To Do entry and create a new one for a different role when the timeout threshold defined on the algorithm's parameters is exceeded. If you've configured the system to send email for approval, this algorithm can also send x reminder emails (where x is defined on the algorithm's parameters) before the approval request is escalated to the new To Do role. Refer to C1-APR-TMOUT for more information about this algorithm. If you plan to enable this functionality, plug-in your configured algorithm on the Approval In Progress state on the C1-AdjustmentApprovalRequest business object.

Rejecting Deletes The Adjustment

When an adjustment is being approved, anyone with access to the adjustment can reject it by using the [Adjustment - Approval](#) portal. Users other than the current approver are allowed to reject an adjustment to allow an "in process" an adjustment to be withdrawn.

When an adjustment is rejected, the following takes place:

- The user is prompted for a reject reason.
- The approval request's audit log is updated with the reject reason and the approval request is moved to the Rejected state.
- The adjustment is deleted.

Designing Your Approval Profiles

The following points describe a recommended design process:

- Create logical groups of adjustment types where each group has the same monetary hierarchy and approvers. An approval profile will be required for each of these groups.

- The number of To Do types (if any) that need to be created is dependent on how the adjustment approval To Do entries should be organized on To Do lists. For example, if all approval request To Do entries can appear in the same To Do list, you can use the base-package adjustment approval To Do type. However, if your organization prefers each approval profile's To Do entries to appear in a distinct To Do list, a separate To Do type will be needed for each list. Note that the base-package is supplied with a To Do type called C1-ADAPP that should be used as the basis for any new approval request To Do type.
- The number of To Do roles is dependent on who approves your adjustments. At a minimum, you will require a separate To Do role for each level in your approval profiles. Remember that every user in a To Do role will see its entries (and receive email if you've configured the system to do such).
- Refer to [Monitoring and Escalating Approval Requests](#) for how to configure the system to escalate approval requests that have been waiting too long.
- If your implementation requires email notification when an adjustment requires approval, the following setup is required:
 - Set up an outbound message type, external system, and message sender. Refer to [To Do Entries May Be Routed Out Of The System](#) for the details.
 - Every To Do type referenced on your approval profiles should be configured as follows:
- Define the F1-TDEER batch process as the To Do type's routing process
- Set up an algorithm that references the C1-ADJAREQEM algorithm type and plug it in the External Routing system event.

Implementing Other Approval Paradigms

The above sections describe how the base-package adjustment approval process works. Because adjustment approval has been implemented using the C1-AdjustmentApprovalProfile and the C1-AdjustmentApprovalRequest business objects, your implementation can add additional business rules and change the approval user interface as required. Alternatively, if your implementation has a radically different approval process, you can create a different business objects with their own business rules. To learn how to do this, please enroll in the Configuration Tools training class.

Setting Up Approval Profiles

Approval profiles contain the rules that control how adjustments are approved. To set up an approval profile, open **Admin > Financial > Approval Profile > Add**.

FASTPATH:

Refer to [The Big Picture Of Adjustment Approval](#) for a detailed description of how approval profiles govern the adjustment approval process.

The topics in this section describe the base-package zones that appear on the Approval Profile portal.

Approval Profile List

The Approval Profile [List zone](#) lists every approval profile. The following functions are available:

- Click a [broadcast](#) button to open other zones that contain more information about the adjacent approval profile.
- Click the Add link in the zone's title bar to add a new approval profile.

Approval Profile

The Approval Profile zone contains display-only information about an approval profile. This zone appears when an approval profile has been broadcast from the Approval Profile List zone or if this portal is opened via a drill down from another page. The following functions are available:

- Click the **Edit** button to start a business process that updates the approval profile.
- Click the **Delete** button to start a business process that deletes the approval profile.
- Click the **Duplicate** button to start a business process that duplicates the approval profile.

Please see the zone's help text for information about this zone's fields.

Approval Profile's Adjustment Types

The Approval Profile's Adjustment Types zone lists every [adjustment type](#) that is governed by this approval profile. This zone appears when there is at least one adjustment type governed by the approval profile displayed in the Approval Profile zone:

To add an adjustment type to this list:

- Navigate to the Adjustment Type page and display the desired adjustment type.
- Specify the governing approval profile and update the adjustment type.

To remove an adjustment type from this list:

- Navigate to the Adjustment Type page and display the desired adjustment type.
- Change or remove its approval profile and update the adjustment type.

Designing and Defining Budget Plans

If you allow your customers to pay a budget amount each month (as opposed to their actual bill amount), you must set up one or more budget plans. If your company does not offer budget billing options, you can skip this section.

The topics in this section describe how to design and set up budget plans.

The Financial Impact Of Budget Plans

The only difference between a customer who participates in budget billing and one who doesn't is that budget billing customer have bill segments where payoff amount differs from current amount. Why? Because the payoff amount is the actual amount of the bill. The current amount is the amount the customer is expected to pay (i.e., their budget amount).

Let's run through an example of a customer on a budget to illustrate a service agreement where these two balances are not the same. The values in the payoff balance and current balance columns reflect the amount due after the financial transaction has been applied:

Date	Financial Transaction	Payoff Balance	Current Balance
1-Jan-19	Bill: \$125, Budget \$150	125	150
15-Jan-19	Payment: \$150	-25	0

2-Feb-19	Bill: \$175, Budget \$150	150	150
14-Feb-19	Payment: \$150	0	0
3-Mar-19	Bill: \$200, Budget \$150	200	150
15-Mar-19	Payment: \$150	50	0

FASTPATH:

For more information about current and payoff amounts, refer to [Current Amount versus Payoff Amount](#).

What Do Budget Plans Do?

A budget plan contains the business rules that govern:

- How the recommended budget amount is calculated.
- When and how a customer on an ongoing budget plan will have their budget amount periodically trued up.
- The conditions under which the system will highlight an existing budget amount as being anomalous with the customer's current use patterns.

You may have different budget plans for different customer segments. For example, customers with large bills may have their budget amount recalculated every month, whereas small customers may have their budget amount only recalculated annually. You define which budget plans govern a customer's bills via a **budget plan on the customers' accounts**. An account's initial budget plan is defaulted from its customer class. You may override an account's budget plan at will.

Designing Your Budget Plans

FASTPATH:

Refer to [Budget Billing](#) for background information about budget billing.

A budget plan contains the business rules that govern:

- How the recommended budget amount is calculated.
- When and how a customer on an ongoing budget plan will have their budget amount periodically trued up.
- The conditions under which the system will highlight an existing budget amount as being anomalous with the customer's current use patterns.

You will need multiple budget plans if any of the above rules / conditions differ for different types of customers. For example, if residential customers use a different recommended budget algorithm as compared to commercial customers, you'd need one budget plan for residential and another for commercial.

We'll design budget plans to satisfy the needs of a theoretical company to help you understand how to design your budget plans. The following points describe the budget requirements of our theoretical company:

- The recommended budget amount is the last year's real bill amounts plus any existing debit/credit balance divided by 12. This is true regardless of the type of customer.
- The frequency of budget true up is monthly for commercial customers and annually for residential customers.
- The system should highlight when a residential customer's budget is more than 30% out of whack with what their budget amount would be if it was recalculated.

- The system should highlight when a commercial customer's budget is more than 20% out of whack with what their budget amount would be if it was recalculated.

You'd need the following budget plans to satisfy the above requirement:

Budget plan	Recommended Amount Algorithm	True Up Algorithm	Monitor Algorithm
Residential	Average Bill	True up every 12 months	Highlight when more than 30% out
Commercial	Average Bill	True up every month	Highlight when more than 20% out

Refer to the Page Controls under [Setting Up Budget Plans](#) for a description of the various algorithms defined in respect of a budget plan.

Setting Up Budget Plans

In the previous section, *Designing Your Budget Plans*, we presented a case study that illustrated a mythical organization's budget plans. In this section, we explain how to maintain your Budget Plans.

Budget Plan - Main

To set up budget plans, select **Admin > Credit & Collection > Budget Plan > Add**.

Description of Page

Enter an easily recognizable **Budget Plan** and **Description**.

If your implementation requires restricting budget plans to accounts by CIS Division, specify a **CIS Division** on the budget plan.

The remaining information on this page is used by the various budget-oriented processes.

Refer to [Budget Plan - Calculation Algorithm](#) for information about the **Calculation Algorithm**.

Refer to [Budget Plan - Monitor Algorithm](#) for information about the **Monitor Algorithm**.

Refer to [Budget Plan - True Up Algorithm](#) for information about the **True Up Algorithm** and **Months for True Up**.

Budget Plan - Calculation Algorithm

On [Budget Plan - Main](#) you must define the **Calculation Algorithm** used by the system when it calculates a customer's recommended budget amount.

If you haven't done so already, you must set up this algorithm in the system. To do this:

- Create a new algorithm (refer to [Setting Up Algorithms](#)).
- On this algorithm, reference an Algorithm Type that calculates recommended budget amounts.

Budget Plan - Monitor Algorithm

On [Budget Plan - Main](#) you must define the **Monitor Algorithm** used by the [Budget Monitor](#) background process when it determines if a customer's budget plan is out-of-sync with their consumption patterns.

NOTE:

What happens? If the algorithm determines that a customer's budget plan is out-of-sync with its current recommended amount, an entry is added to the [Budget Review](#) page.

If you haven't done so already, you must set up this algorithm in the system. To do this:

- Create a new algorithm (refer to [Setting Up Algorithms](#)).
- On this algorithm, reference an Algorithm Type that highlights if a customer's current budget amount is out-of-sync with their consumption patterns.

Budget Plan - True Up Algorithm

On [Budget Plan - Main](#) you must define the **True Up Algorithm** used by the [Budget True Up](#) background process when it periodically trues up a customer's budget.

If you haven't done so already, you must set up this algorithm in the system. To do this:

- Create a new algorithm (refer to [Setting Up Algorithms](#)).
- On this algorithm, reference an Algorithm Type that trues up budget amounts.

The system will automatically true up a customer's budget amount every X months (X is defined in **Months for True Up**).

Tender Management

When a payment is received, a tender is created to record what was remitted (e.g., cash, check, credit card). The topics in this section describe control tables that must be set up in order to remit tenders.

FASTPATH:

We strongly recommend [Tender Management and Workstation Cashiering](#) before setting up the control tables described in this section.

Setting Up Tender Types

Tender types are used to indicate the method in which the tender was made. A unique **Tender Type** must exist for every type of tender that can be remitted. For example, if you allow cash, checks, direct debits from a checking account, and direct debits from a credit card to be tendered, you'd need the following tender types:

Tender Type	Description	Like Cash	Generate Auto Pay	Require External Source ID	Require Expiration Date	External Type
CASH	Cash	Yes	No	N/A	N/A	N/A
CHEC	Check	No	No	N/A	N/A	N/A
OVUN	Cash drawer - over/under	No	No	N/A	N/A	N/A
DDCH	Direct debit - checking	No	Yes	Yes	No	Checking withdrawal

CRED	Direct debit - credit card	No	Yes	No	Yes	Credit card withdrawal
------	-------------------------------	----	-----	----	-----	---------------------------

Go to **Admin > Financial > Tender Type** to define your tender types.

Description of Page

Enter a unique **Tender Type** and **Description** for the tender type.

Turn on the **Like Cash** switch if this tender type is cash or the equivalent of cash. This indicator controls if the system generates a warning if a cash-only account remits a tender other than cash. It is also used to generate a warning for online cashiers to turn in their tenders when the cash-like amount exceeds the maximum amount balance defined for the [tender source](#).

Turn on **Generate Auto Pay** if this type of tender causes an automatic payment request to be routed to a financial institution. For example, this switch will be on if this tender type is used for direct debits from a customer's checking account (because every tender of this type will have an automatic payment request created when the tender is created).

The following fields are only used for tender types associated with automatic payments:

External Type This field is used by the background process that creates the information that is interfaced to the automatic payment source. Specifically, it controls the record type associated with the different types of automatic payments that are routed to the automated clearinghouse (ACH).

NOTE:

The values for this field are customizable using the Lookup table. This field name is EXT_TYPE_FLG.

Require Ext. Src. ID This switch indicates if an Auto-Pay Source that references this type of tender must contain an External Source ID. The External Source ID is the unique identifier of the financial institution to which the automatic payment will be routed.

This switch is typically turned on for tender types associated with checking / saving direct debits. It is turned off for tender types associated with credit card debits (you don't need an external source for a credit card debit, you just need the credit card number).

Expiration Date Required Turn this switch on if an Auto-Pay Option that references an auto-pay source that references this type of tender must also contain an expiration date (e.g., automatic debit / credit cards).

Turn this switch off for tender types associated with checking / saving direct debits.

Tender Authorization Indicates that tenders of a particular type require authorization prior to being created.

Business Object If Tender Authorization has a value of Required, a Business Object must be specified for the tender type. The primary function of this Business Object is to manage the authorization of payment tenders.

FASTPATH:

For more information on authorizing credit card payments, refer to the Tender Type - Credit Card with Authorization business object.

Turn on **Allow Cash Back** if the system should automatically calculate a cash back amount when a tender is remitted for this tender type and the amount tender exceeds the amount being paid.

Setting Up Tender Sources

A unique **Tender Source** must exist for every potential source of funds. For example,

- Every cashiering station will have a unique tender source.

NOTE:

If your organization accepts alternate currency payments online, then a tender source must exist for each currency code accepted at the cashiering station.

- Every lock box will have a unique tender source.
- Your remittance processor will have a unique tender source.
- If you allow customers to pay bills automatically (e.g., via EFT), you'll need a tender source for each institution to which you route automatic payment requests. For example, if you route automatic payment requests to the automated clearinghouse (ACH), you'll need a tender source for the ACH.

For example, if you have 3 lock boxes, 2 cash drawers at an area office A, 2 cash drawers at area office B, and a single remittance processor, you'd need the following tender sources:

Tender Source	Type	External Source ID (Lockbox ID)	Default Starting Balance	Currency Code	Suspense Service Agreement
CASH-A01	Cashiering	N/A	150.00	USD	N/A
CASH-A02	Cashiering	N/A	150.00	USD	N/A
CASH-B01	Cashiering	N/A	150.00	USD	N/A
CASH-B02	Cashiering	N/A	150.00	USD	N/A
LB-INDUS	Lockbox	112910-A	N/A	USD	9291019281
LB-COMM	Lockbox	938219-C	N/A	USD	4739837372
LB-RESID	Lockbox	372829-B	N/A	USD	1912910192
REMIT	Lockbox	N/A	N/A	USD	1920038437
ACH	Auto Pay	N/A	N/A	USD	N/A

To set up a tender source, select **Admin > Financial > Tender Source > Add**.

Description of Page

Enter an easily recognizable **Tender Source** and **Description** for the tender source.

Define the **TenderSource Type**. Valid values are: Ad Hoc, Auto Pay, Online Cashiering and Lockbox. The system uses this information to prevent tender controls from different sources from being included under the same deposit control. In other words, you can't mix ad hoc, automatic payment, cashiering and lockbox tenders under the same deposit control.

FASTPATH:

For more information, refer to [Maintaining Deposit Controls](#).

If the source is an external system (e.g., a lockbox or an automatic payment destination), use **External Source ID** to define the unique identifier of the source. The background process that interfaces tenders from this source uses this information to create the appropriate tender control when it interfaces payments from external sources.

If this source is a cash drawer, define the **Default Starting Balance**. This balance is defaulted onto new tender controls and may be overridden.

NOTE:

The tender type of the **Start Balance** is defined on the installation record.

If this source is a cash drawer, define the **Max Amount Balance**. When the amount of **cash-like** tenders in a cash drawer exceeds this balance, a warning is issued to remind the cashier to turn in some of the funds to a tender control.

Define the **Currency Code** of tenders linked to this source. All tenders in a source must be of the same currency.

If this tender source is associated with payments that are [interfaced from an external source](#) (e.g., a lockbox or a remittance processor), use Suspense **Service Agreement** to define the service agreement whose account will hold uploaded payments with an invalid account. Refer to [Payment Upload Error Segmentation](#) for more information about suspense service agreements. Also note, because the payment upload process simply books payments that reference invalid accounts to the account associated with this service agreement, this account should belong to a customer class with the appropriate payment distribution algorithms. This may entail creating a new customer class that will only be used on these "suspense accounts". This customer class would need the following algorithms:

- We'd recommend using a simple payment distribution algorithm like PYDIST-PPRTY (distribute payment based on SA type's payment priority and the age of the debt).
- We'd recommend using an overpayment distribution algorithm like OVRPY-PPRTY (distribute overpayment to highest priority SA type).

Define the **Bank** and **Bank Account** into which the tender source's moneys will be deposited. The bank account defines the distribution code used to build the GL details for the payment. Refer to The [Source of GL Accounts on Financial Transactions](#) for more information. Note that the bank code and bank account can later be overwritten when entering Tender Deposits on [Deposit Control](#).

Printer IP Address and **Printer Port** are for implementation use, if needed. The base samples for receipt printing do not use these settings, as they are designed for local printers. Refer to the Receipt Printing section of the Optional Products Installation Guide for more details.

If this tender source is associated with payments that are [interfaced from an external source](#), for example tender sources associated with Auto Pay and Lockbox **Tender Source Types**, the information is also used as follows:

- The [payment upload process](#) uses this information to populate the bank and bank account when it creates deposit control records for the tender controls it creates during the interface. Refer to [Managing Payments Interfaced From External Sources](#) for more information.
- The [automatic payment interface](#) uses this information to populate the bank and bank account when it creates deposit control records for the tender controls it creates during the interface.

NOTE:

If your organization accepts alternate currency payments online, then a tender source must exist for each currency code accepted at the cashiering station. When a user adds a tender control the system attempts to default a tender source based on the currency of the deposit control and the tender source(s) define on the user's record.

FASTPATH:

Refer to [Alternate Currency Payments](#) for more information.

Automatic Payment Options

If your customers can pay their bills automatically (via direct debit or credit card debits), you'll need to set up the various control tables described in this section.

IMPORTANT:

Besides the tables described in this section, additional values must also be added to control tables defined under [Tender Management](#). Specifically, refer to [Setting Up Tender Types](#) and [Setting Up Tender Sources](#).

FASTPATH:

Refer to [Automatic Payments](#) for more information about how automatic payments are handled in the system.

Setting Up Auto Pay Route Types

This portal is used to display and maintain an Auto Pay Route Type.

Auto Pay Route Types are used to control when and how automatic payment requests are routed to a financial institution, and when the general ledger is impacted.

You can access the portal from **Admin > Financial > Auto Pay Route Type**.

The information captured on the auto pay route type depends on the business objects supported by your implementation. Refer to the embedded help for more information.

Setting Up Auto Pay Source Codes

A unique **Auto Pay Source** must exist for every bank / credit card company / bill payment service that your customer's use as the source of the funds when they sign up for automatic payment. For example,

- Every bank will have a unique auto pay source.
- Every credit card company will have a unique auto pay source.

To set up an auto pay source, select **Admin > Financial > Auto Pay Source Type > Add**.

Description of Page

Enter an easily recognizable **Auto Pay Source Code** and **Description** for the auto pay source.

The **Source Name** is the name of the financial institution.

When the system creates an automatic payment request, it also creates an associated payment tender. This tender (like all tenders) must have a tender type. This field defines the **Tender Type** associated with this auto pay source's tenders. The **Prenote Tender Type** is also specified on checking and savings tender types. It determines the transaction code to stamp on an auto pay extract records that are sent out for the purpose of debit prenotification. Refer to [Setting Up Tender Types](#) for more information.

The **External Source ID** is the unique identifier of the financial institution to which the automatic payment will be routed (e.g., the bank routing ID of the bank). This field is typically blank on automatic payments routed to credit card companies because the credit card company doesn't have an external source ID (whereas direct debits from banks must have a bank routing number). Whether this field is required is controlled by the **Tender Type**.

The **Auto Pay Route Type** controls when and how automatic payment requests get routed to a financial institution. It also controls when the general ledger is impacted by the automatic payments financial transaction. Refer to [Setting Up Auto Pay Route Types](#) for more information.

The **Work Calendar** defines the financial institution's workdays. This information is used to determine the date on which automatic payment requests will be sent to the financial institution. Refer to [Setting Up External Workday Calendars](#) for more information.

The **Validation Algorithm** defines how the system validates the customer's account ID at the financial institution. If you haven't done so already, you must set up this algorithm in the system. To do this:

- Create a new algorithm (refer to [Setting Up Algorithms](#)).
- On this algorithm, reference an Algorithm Type that validates the customer's account ID at the financial institution.

Refer to [Account - Auto Pay](#) for more information.

SEPA Payments

The topics in this section provide background information about the Single Euro Payments Area (SEPA) payment functionality.

NOTE: This section is only relevant for some organizations. The system configuration requirements described in this section are only relevant if your organization is participating in SEPA payment transactions such as direct debit collection.

What Is SEPA?

SEPA (Single Euro Payments Area) is a European Union (EU) integration initiative that is aimed at streamlining processes that are related to cross-border payments. SEPA consists of the EU member states plus a few additional countries. In SEPA, customers can make electronic Euro payments within and across these countries under the same rights and obligations. SEPA payment services are based on global ISO (International Organization for Standardization) standards.

SEPA Direct Debit

The SEPA Direct Debit (SDD) scheme allows a creditor to collect money from the debtor, with prior approval from the debtor. The direct participants are the following:

- Creditor
- Creditor's bank
- Debtor
- Debtor's bank

The debtor and creditor must each hold an account with a payment service provider located within SEPA. The accounts may be in Euro or in any other SEPA currency. However, the transfer of funds between the debtor's bank and the creditor's bank always takes place in the Euro currency. The indirect participants are the following:

- Clearing and Settlement Mechanisms (CSMs) such as an automated clearinghouse
- Intermediary Banks that offer intermediary services to debtor banks and/or creditor banks

SEPA Direct Debit Mandate

The mandate is the consent and authorization that the debtor gives to the creditor, to allow the creditor to initiate direct debit collections. The creditor is responsible for storing the original mandates, together with any amendments relating to the mandate or information regarding its cancellation or lapse. The contents of this section describe how mandates are issued and canceled.

Issuing a Mandate

The creditor initiates the issuance of a mandate by sending the mandate form (either paper or electronic) to the debtor with the creditor information filled in. The creditor information includes the creditor's unique identifier as a SEPA creditor. An ISO standard specifies the structure of the creditor identification, which includes country code, a check digit, the creditor's business code and a country-specific identifier for the creditor. The creditor ensures that the mandate form contains the mandatory legal wording and the mandatory set of information, as specified in the standards. The debtor must ensure that the required information is supplied and that the mandate is signed, either in writing or electronically. The mandatory debtor information includes the debtor's international bank account number (IBAN) and bank identifier code (BIC). The creditor

assigns a unique reference for the mandate and provides that reference to the debtor before the first initiation of a collection. The debtor can then use both the unique mandate reference and the creditor identification to verify the bank transactions.

Canceling a Mandate

A mandate can be canceled by either the debtor or the creditor, without the involvement of either bank.

The Lifecycle of a Direct Debit Mandate Task

The following diagram shows the possible lifecycle of the Direct Debit Mandate Task business object:

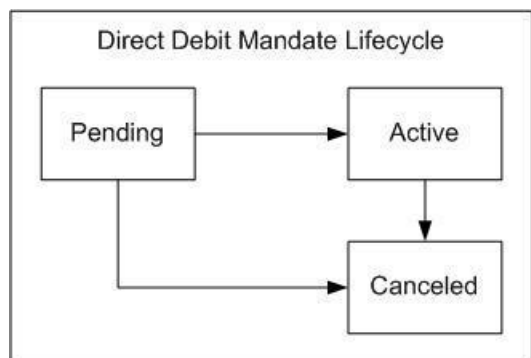

Pending State: The direct debit mandate starts out in a pending state.

Active State: The direct debit mandate is transitioned manually by a user to the active state. Once a mandate is created and activated in the system, the account's auto pay information must be updated to reflect information on the mandate. This process may be automated within the mandate's lifecycle and a sample algorithm exists in the demo database to achieve this. This algorithm is also included in the export bundle in the demo database.

Canceled State: The direct debit mandate is transitioned manually by a user to the canceled state.

Configuring the System for SEPA Direct Debits

The following sections describe the setup required if your organization intends to process SEPA direct debit transactions.

Define Auto-Pay Route Type

Configure an auto-pay route type for routing direct debit requests to a financial institution. This auto-pay route type must reference the SEPA Direct Debit Payment Extract (C1-SDDCE) batch process.

Refer to [Setting Up Auto-Pay Route Types](#) for more information.

Define Auto-Pay Source Type

Ensure that your auto-pay source codes reference the above auto-pay route type. You must also configure a validation algorithm on the auto-pay source type to ensure the International Bank Account Number (IBAN) defined on the Auto-pay Source of the Account has the correct format.

Refer to [Setting Up Auto Pay Source Codes](#) for more information.

Define a Direct Debit Task Type

Your implementation must configure a **Direct Debit Task Type**. This service task type captures general information that the SEPA extract process needs to create the output file. The base product provides a business object for direct debit task type, **C1-DirectDebitMandateTaskType**.

Note that the direct debit task type is maintained on the Service Task Type portal.

Define SEPA Country Codes

The list of countries and territories that are part of the Single Euro Payment Area (SEPA) must be defined on extendable lookup **C1-SEPACountryCodeLookup**. These country codes are used by the system to validate the creditor identification entered on a direct debit task type.

Note that an export bundle exists in the demo database that includes a sample list of SEPA country codes. This list must be verified by your implementation for accuracy.

Define Mandate Cancel Reasons

A cancel reason is required when canceling a direct debit mandate. Ensure that these status reasons have been configured for the direct debit task business object, **C1-DirectDebitMandateTask**.

Define Navigation Options

The base product includes navigation options for easy access to query and maintain an account's direct debit mandate. To access these portals, add a new menu item to the account context menu (**CI_CONTEXTACCOUNT**). This menu item should include two menu lines:

- A context menu line for navigation to the direct debit mandate that references a navigation option of **c1DirectDebitMandate**. The system uses the account in context and attempts to find the most recent active mandate for the account. If a mandate exists, navigation is to the service task maintenance portal. If an active mandate does not exist, navigation is to the service task query portal.
- A context menu line for adding a new direct debit mandate that references a navigation option of **c1AddDirectDebitMandate**.

Setting Up Account Auto Pay

The SEPA direct debit extract process retrieves banking details from the account's auto pay record. Once a mandate is created and activated in the system, the account's auto pay information must be updated to reflect information on the mandate. This process may be automated within the mandate's lifecycle and a sample algorithm exists in the demo database to achieve this. This algorithm is also included in the export bundle in demo.

Web Debit Account Validation

This section describes Web Debit Account Validation and the steps to enable this functionality.

NOTE: This section is only relevant for some organizations. The system configuration requirements described in this section are only relevant if your organization is required to validate bank accounts that are used for the first time in electronic payments initiated over an online channel such as web self-service. This functionality does not cover credit card payment types, which are verified through tender authorization.

Web Debit Account Validation allows your implementation to validate a first-use checking/savings account that is captured through any of the following self-service activity:

- Automatic Payment Setup
- Make One Time Payment
- Manage Payment Options (wallet)

The account validation method is your implementation's choice, based on what regulation prescribes as acceptable account validation options. For instance, the National Automated Clearinghouse Association (NACHA) - that governs the ACH network in the United States - prescribes any of the following options:

- **ACH prenotification.** With this option, a zero-amount checking/savings debit pre-note transaction is sent through the auto pay extract, to verify the bank account information. If a negative response is not received from the bank within a set number of days, the account is considered valid.
- **ACH micro-transaction verification.** With this option, two very small transactions – a debit to deposit the money and a credit to remove the money - are sent to the account. The account holder needs to confirm the amounts on the transactions. The account will only be considered verified if the account holder describes the amounts correctly.
- **Commercially available third party validation service vendors.** Some financial institutions and third parties have access to a large number of accounts and may offer a product that leverages this information. These services can be accessed for verifying that account information is correct and/or verifying the account holder's identity. The responses can be real-time, same-day or next-day.

Web Debit Account Validation is a Plug-in

An algorithm plugged in on Auto Pay Route Type or on CIS Division - Auto Pay Route Type Override Controls (if applicable) is responsible for web debit account validation. Payment methods captured for self-service automatic payment setup and self-service one time payment specify the Auto Pay Source, which in turn, identifies the Auto Pay Route Type.

The base product provides a Web Debit Account Validation Algorithm for ACH prenotification. The algorithm creates an Auto Pay Clearing Staging record with the account number to verify and a zero amount. Refer to the Web Debit Account ACH Prenotification (C1WDAPRENTF) algorithm for details.

Web Debit Account Validation Applies to Self-Service Tasks that Manage Payment Options

The following self-service task business objects include an Account Validation status, where web debit account validation is performed:

- Automatic Payment Task - WX-AutoPayTask
- One Time Payment Task - WX-OneTimePayTask
- Self-Service Payment Option Task - C1-PaymentOptionsTask

The Account Validation status has an enter algorithm that performs the Web Debit Account Validation Algorithm configured in the Auto Pay Source's Auto Pay Route Type (or in the CIS Division's Override Auto Pay Controls, if applicable) when the service task type has Web Debit Account Validation enabled and the account number does not exist in any of the account's saved auto pay options and in any of the saved self-service payment options of persons on the account. The account auto pay option or self-service payment option is not saved until the bank account is deemed valid. The Account Validation Error status includes algorithms for retry processing and wait timeout processing. If the account is deemed invalid, the service task goes to the Rejected status. Refer to the business object for more details.

NOTE: When checking for the existence of a bank account number in person self-service payment options, the system relies on the hash value (in HASH_EXT_ACCT_ID). Implementations must ensure that encryption configuration for this table field includes both the encrypted and hash fields and that legacy data has both fields populated. Refer to [Encrypting Sensitive Data](#) and [Encrypting Legacy Data](#) for more details.

Validating Payment Methods Captured On Add One-Time Payment UI

The Add One-Time Payment user interface allows the capture of first-use checking/savings bank accounts. If a bank account has not been used on any prior recurring bill auto pays and prior self-service one time payments, the system will trigger web debit account validation by creating the One-Time Payment Task (C1-OneTimePaymentTask). Since the Add One-Time Payment UI can handle multiple tenders, a single One-Time Payment Task manages all auto pay tenders that require validation.

Note that the Payment Event is kept in an Incomplete state while web debit account validation is still in progress. Lifecycle processing on the service task will either complete or delete the Payment Event, depending on the result of account validation.

Refer to the C1-OneTimePaymentTask business object in the application, for more information on the service task lifecycle processing.

Specific Transaction Codes for Checking/Savings Debit Prenotification

The APAYACH and C1-APACH batch processes stamp specific transaction codes for checking debit prenotification (28) and savings debit prenotification (38) on the Entry Detail record. The transaction code is retrieved from the prenotification Tender Type's External Type.

Configuring the System for Web Debit Account Validation

The following are the steps to enable Web Debit Account Validation functionality:

- Determine the account validation option(s) that your implementation will use.
 - If opting for ACH prenotification, you can use the base-supplied Web Debit Account ACH Prenotification (C1WDAPRENTF) algorithm.
 - If opting for ACH micro-transaction verification or third party validation, create a Web Debit Account Validation algorithm for your chosen method.
- Plug in the Web Debit Account Validation on your applicable Auto Pay Route Types and CIS Division - Auto Pay Route Type Override Controls (if applicable).
- On your Automatic Payment Setup and One Time Payment Service Task Types, set the Web Debit Account Validation flag to Yes. To use the wait timeout processing built into the Account Validation Error state, configure the Timeout Processing settings. Refer to the service task's embedded help for more details.
- On the Automatic Payment Setup and One Time Payment service task business objects:
 - If using the base-supplied Web Debit Account ACH Prenotification algorithm (or a CM algorithm that allows for a wait period after which the account is considered valid), monitor logic on the Account Validation status should check if the wait time has elapsed - and if so, transition the service task accordingly. Note that the Check Account Validation Status monitor algorithms provided in the base product simply transition the service tasks to the next state (i.e. Process Auto Pay, Process Payment or Process Request) when the wait time elapses. The base algorithms do not check for a negative response because the form of response is implementation-specific. If your implementation needs to check for a negative response, copy the base algorithms and add that processing. Refer to the Check Account Validation Status for One Time Payment (C1OTPACVAST) and Check Account Validation Status for Auto Pay Setup (C1APAYACVAST) algorithms for details.
 - To use the To Do creation algorithm plugged in on the Account Validation Error status, configure a new algorithm parameter instance to specify the Retry Frequency and Discard Cancel Terminate Reason (if applicable).
 - To use the retry processing on the Account Validation Error status, configure a new algorithm parameter instance to specify the Maximum Retry.
- Configure tender types for checking debit prenotification and savings debit prenotification. Use the applicable External Type value on each - i.e. Checking Debit Prenotification (28) or Savings Debit Prenotification (38), The auto pay extract

process uses the Prenote Tender Type's External Type as the transaction code on the Entry Detail record in the extract file.

- Configure the checking and savings Auto Pay Sources with the applicable Prenote Tender Types.
- If your implementation enabled the Add One-Time Payment UI, configure the One-Time Payment Task feature option. Refer to [One Time Payment Options](#) for more details.

One-Time Payment Options

The Add One-Time Payment popup provides the ability to 'quick add' a payment event using existing auto pay methods, new checking/savings auto pay methods, cash and non-cash/non-auto pay methods (like check).

This user interface provides the same capabilities as the [Payment Event - Add Dialog](#), including processing for open-item and non-CIS payor accounts. In addition, it provides the following:

- Ability to specify auto pay tender details within the same popup. No need to navigate to the Payment Event page.
- Ability to select an existing auto pay method from either a currently enrolled Account Auto Pay option or a stored Person Self-Service Payment Option.
- Ability to specify new auto pay methods, with an option to save the payment method for future one-time payments
- Web debit account validation can be enforced for first-use checking and savings accounts. Refer to [Web Debit Account Validation](#) for more details.

Enabling the Add One-Time Payment User Interface

To enable the Add One-Time Payment popup, configure the following options in Financial Transaction Options feature configuration:

- **Enable Add One-Time Payment UI.** Set this to Y, to replace the Payment Event-Add pop-up with the Add One-Time Payment pop-up on all existing launch points of the old pop-up.
- **One-Time Payment UI Navigation.** Specify where the user should be navigated after successful one-time payment creation. This is optional. If not specified, the pop-up simply closes.
- **One-Time Payment Service Task Type.** If your implementation enabled [Web Debit Account Validation](#), add a One-Time Payment service task type using the base-provided C1-OneTimePaymentTaskType and C1-OneTimePaymentTask. Specify your One-Time Payment service task type on this feature option.
- **Override Script for Add One-Time Pmt UI.** If your implementation has additional requirements for the [Add One-Time Payment](#) UI, you can clone the base-owned BPA script (C1OTPayAddNv) and specify your CM script on this feature option. If configured, the system will launch this override script instead of the base-owned script.

FASTPATH:

Refer to [Add One-Time Payment](#) for more information.

Third Party Payment Processing Options

If you allow customers to make one time payments and/or pay bills automatically through a third party payment processing system, you will need to set up a number of control tables to enable these functions in the system.

IMPORTANT: Aside from the tables mentioned in these sections, control tables defined under [Automatic Payment Options](#) must also be configured. Additional values must also be added to control tables defined under [Tender Management](#). Specifically, refer to [Setting Up Tender Types](#) and [Setting Up Tender Sources](#).

FASTPATH: Refer to [Third Party Payment Processing](#) for the big picture of third party payment processing.

Define Service Task Types

The web services used to process one time payment notifications, automatic payment setup and account verification create a corresponding service task record to perform the needed actions.

The following service task types need to be configured and defined on the Third Party Payment Processing Integration master configuration:

- A **Third Party One Time Payment** service task type is used to create an immediate or scheduled third party one time payment. The base product supplies the following service task type and service task business objects: **C1-ThirdPartyOneTimePyTaskType** and **C1-ThirdPartyOneTimePyTask**. Refer to these business objects for details on schemas and processing logic.
- A **Third Party Account Verification** service task type is used to verify an account, which is typically done prior to capturing and processing a one time payment within the third party payment processing system. The base product supplies the following service task type and service task business objects: **C1-ThirdPartyAcctVerifTaskType** and **C1-ThirdPartyAcctVerifTask**. Refer to these business objects for details on schemas and processing logic.
- A **Third Party Auto Pay Setup** service task type is used to add or update an account's ongoing automatic payment option. The base product supplies the following service task type and service task business objects: **C1-ThirdPartyAutoPayTaskType** and **C1-ThirdPartyAutoPayTask**. Refer to these business objects for details on schemas and processing logic.

Refer to [Defining Service Task Types](#) for details on setting up service task types

Define Auto Pay Sources and Auto Pay Route Types

Configure specific auto pay sources for the payment types that your third party payment processing system accepts for one time payment processing and ongoing automatic payment processing. Base-supplied Payment Type values are: Checking Withdrawal, Savings Withdrawal and Credit Card Withdrawal. Your implementation can add payment types. In the Third Party Payment Processing Integration master configuration, each accepted payment type is associated with a Tender Type that is used to create the payment tender associated with a third party one time payment. For checking and savings payment types, the tender type and routing number are used to identify the auto pay source.

Auto pay sources used for ongoing automatic payment processing (i.e. ACH) should be associated with an auto pay route type that specifies C1-TAPEX as the Extract Batch. This ensures that the correct extract batch code is stamped on bill-related auto pay staging records during auto pay activation.

Define Tender Cancel Reason

Configure a Tender Cancel Reason that will indicate that a payment tender was canceled from the third party payment processing system. This cancel reason is configured in the Third Party Payment Processing Integration master configuration and used when a scheduled or processed one time payment is canceled.

Third Party Processing DateTime

The services used in third party payment processing allow for the possibility that the third payment processing system is processing in a different time zone as the utility's. The Third Party Payment Processing Integration master configuration includes the third party's Processing Cutoff Time and Processing Cutoff Time Zone, as well as the local equivalent of the processing cutoff time, based on the Time Zone defined on the Installation record.

The payment datetime that is sent by the third party payment processing system with one time payment notifications and auto pay confirmations is stored as-is as a characteristic on the one time payment's tender. This is done for the purposes of tender controls processing and payments reconciliation (*i.e.*, with reports generated from the third party payment processing system).

As a standard, inbound and outbound communications external systems must use the standard xsd datetime format (yyyy-MM-dd'T'hh:mm:ss[+ or -]hh:mm). The payment datetimes sent with third party one time payment notifications and auto pay confirmations should follow this format.

The Third Party One Time Payment Task also stores the local equivalent of the payment datetime, based on the Time Zone defined on the Installation record. This local datetime is used anywhere third party one time payments (and their payment dates) are displayed in the system (*e.g.*, in the [Scheduled Payments Log](#) in Control Central - Account Information).

Third Party Payment Processing Master Configuration

The integration with a third party payment processing system requires the setup of master configuration data that controls the processing of one time payments and ongoing automatic payments.

To set up the third party payment processing master configuration, navigate using **Admin > General > Master Configuration**. You are brought to an all-in-one portal with options to add/edit the Third Party Payment Processing Integration master configuration record.

Refer to the master configuration's embedded help for more details on how each section in this record is configured.

Payment Advices

The topics in this section provide background information about payment advice functionality.

NOTE:

This section is only relevant for some organizations. The system configuration requirements described in this section are only relevant if your organization issues payment advices to the customer instead of initiating electronic funds transfer directly to the customer's bank.

What Is A Payment Advice?

Payment advice is a money order that is established at the initiative of the utility. When a bill is completed, the utility sends the customer a document that indicates a payment amount and the customer's bank details. If the customer agrees to the information on the payment advice, they sign it and return it to the clearinghouse address that is indicated on the payment advice. The clearinghouse, in turn, sends the dated and signed payment advice to the customer's bank, which completes the payment.

Payment Advice vs. Direct Debit

The existing functionality that creates automatic payments is referred to as direct debit processing. Payment advice processing differs from direct debit processing in the way that automatic payments get initiated. With payment advice processing, the usual automatic payment records - *i.e.* payment event, payment, tender and auto pay clearinghouse staging - are not created. Instead, a payment advice is printed and sent to the customer. The customer sends the approved payment advice directly to the clearinghouse.

NOTE:

The system does not provide sample processes for extracting and printing payment advice information. Your implementation team would have to create these.

Setting Up The System To Enable Payment Advices

You must set up a Financial Transaction Options [Feature Configuration](#) to define parameters that control payment advice functionality.

The following points describe the various **Option Types** that must be defined:

- **Payment Advice Functionality Supported.** This option controls whether the system allows for payment advice processing.
 - Enter Y if the system should allow for both direct debit and payment advice processing.
 - Enter N if the system should only allow for direct debit processing.
- **Default Auto Pay Method.** This option is used for defaulting the auto pay method on new account auto pay records.

Refer to [Account - Auto Pay](#) for more information on auto pay method.

NOTE:

The system assumes direct debit processing if the above feature options are not defined.

Credit Card Payments

If your organization accepts credit card payments, you can configure the system to authorize customers' credit card charges in real-time, and perform an authorization reversal (also in real-time) when the credit card payment is canceled. When the authorization web service is not available, you can permit users to enter authorization codes manually so that they can continue processing payments.

Configuring the System for Tender Authorization

The following sections describe the setup required if your organization intends to use the base CyberSource integration tender authorization functionality.

Define the Outbound Message Type

An outbound message type is required for the CyberSource authorization outbound message. This outbound message type must reference the base CyberSource - Credit Card Authorization business object.

An outbound message type is required for the CyberSource reversal outbound message. This outbound message type must reference the base CyberSource - Credit Card Reversal business object.

Define the Message Sender

A Message Sender is required to define how to send messages to CyberSource. Use the context of the Message Sender to define the web service interface.

Define the External System and Configure the Messages

Define an external system and configure the valid outbound message types and the method of communication for each (XAI, Batch or Real Time; Real Time is generally the appropriate choice for credit card authorization). You will also need to select the appropriate XSLs to format both the request and response to the outbound message types for CyberSource.

Define a User

Add a user to hold details required for CyberSource communication. Security information (e.g. Merchant Id, Merchant Reference Code, CyberSource User Name and Password) needed to interface with CyberSource is stored as user characteristics.

Set up the Tender Authorization Algorithm

A Tender Type (BO) - Tender Authorization algorithm must be configured. This algorithm performs a tender authorization or a tender authorization reversal through CyberSource.

Define a Business Object

A business object (BO) must be created for the TENDER TYPE maintenance object. This BO must reference the tender authorization algorithm created.

Define Tender Types

Update the appropriate tender type(s) to denote that authorization is required. The new business object must be specified on the tender type(s).

Tender Authorization - Feature Configuration

If your implementation has a need to prevent users from overriding the automatic tender authorization, then you must set up the Allow Manual Tender Authorization Override option type on the Financial Transaction Options [Feature Configuration](#). The Allow Manual Tender Authorization Override option must have a value of N in order to suppress the Authorization Override checkbox.

FASTPATH:

For more information on credit card payment authorization refer to the Tender Type - Credit Card with Authorization business object.

Non CIS Payments

Payment Templates can be configured for common types of non CIS payment allocations. These templates are used to default the payment distribution and allow non CIS payments to be directly allocated to specific distribution codes.

Setting Up Payment Templates

Payment templates contain the rules that control how non CIS payments are created. You can use a payment template to default the payment distribution for common types of non CIS payments. To set up a payment template, open **Admin > Financial > Payment Template > Add**. The topics in this section describe the base-package zones that appear on the Payment Template portal.

Payment Template List

The Payment Template [List zone](#) lists every payment template. The following functions are available:

- Click a [broadcast](#) button to open other zones that contain more information about the adjacent payment template.
- Click the Add link in the zone's title bar to add a new payment template.

Payment Template

The Payment Template zone contains display-only information about a payment template. This zone appears when a payment template has been broadcast from the Payment Template List zone or if this portal is opened via a drill down from another page. The following functions are available:

- Click the **Edit** button to start a business process that updates the payment template.
- Click the **Delete** button to start a business process that deletes the payment template.
- Click the **Duplicate** button to start a business process that duplicates the payment template.
- Click the **Activate** or **Deactivate** button to start a business process that updates the status of the payment template.

Please see the zone's help text for information about this zone's fields.

Alternate Currency Payments

The topics in this section provide background information about alternate currency payments.

NOTE:

This section is only relevant for some organizations. The system configuration requirements described in this section are only relevant if your organization accepts payments tendered in a currency other than the customer's currency. If your organization does not accept alternate currency payments, you need only indicate such on the [Installation Record](#); no other setup is required.

What Is An Alternate Currency Payment?

The currency code on the customer's account defines the currency in which the account's financial transactions are expressed. If the customer remits a payment in a different currency, this is referred to as an alternate currency payment. The system enables conversion of the tendered amount to the account's currency and captures the alternate currency and amount,

as well as the exchange rate used in the conversion on the payment tender. The payment tender is linked to a tender control that references the alternate currency.

Configuring the System for Alternate Currency Payments

Allowing Alternate Currency Payments

You must set the **Alternate Currency** flag on the [Installation Record](#) to Allowed if your organization accepts alternate currency payments. This option controls whether the **Currency Converter** button is displayed when a payment is processed on the payment portal.

Payment Event Business Object

A business object (BO) must be created for the PAY EVENT maintenance object. You must specify this BO as the option value for the CIS Payment Event Add BO option type on the Financial Transaction Options [Feature Configuration](#). This BO must have the Currency Conversion Script BO option defined. This BPA script is invoked when the user clicks on the **Currency Converter** button during CIS payment processing on the payment portal.

NOTE:

Currency conversion logic is customizable. The base product includes a script for currency conversion called C1-ConvCurr that's plugged in on the C1-CISPaymentEvent business object. This script converts an alternate currency amount to the account's currency using a bill factor value. The bill factor to use is derived by concatenating the alternate currency code and the account's currency code. For example, if converting US Dollars (USD) to Barbados Dollars (BBD) the bill factor code to use would be USDBBD. Your implementation can change this logic by developing a new script and plugging it into the payment event business object.

Define the User's Tender Sources

Define the tender source(s) for the location (e.g., the specific cash drawer) in which a user's payment tenders are stored during the day. A tender source should be specified for each currency that payments are accepted in. The tender source(s) on the user record are used by the system when a user adds a new tender control. The system attempts to default a tender source on a new tender control based on the deposit control's currency and the tender source(s) defined on the user's record.

Payment Event Distribution

The base-package, by default, creates a single payment for a payment event. If your business requires potentially many payments to be created when payment events are added, you'll need to set up the various control tables described in this section.

FASTPATH:

Refer to [Distributing A Payment Event](#) for more information about how payment event distribution is handled in the system.

Making Payments Using Distribution Rules

As part of this method, one or more distribution details are provided at payment time along with the usual payment and tender information. Each distribution detail record references a distribution rule and a corresponding value. The distribution rule encapsulates the business rules that govern the distribution of the payment amount into payments using the specified value.

The type of value being captured on the distribution detail and the logic that uses it to create payments are defined on the [distribution rule](#).

Rule Value

The primary use of the rule value is to identify the business entity whose balance is to be relieved by creating payment(s). In most cases where the payor account is the same as the payee account it may also be used to identify the tender account associated with the payment(s).

Determine Tender Account

The very first step in processing a distribution detail is to identify the tender account (i.e. the payor) associated with the payment. To do that the system calls the Determine Tender Account [algorithm](#) defined on the distribution rule providing it with the rule value and other tender information.

Creating Payment(s)

The business logic that distributes a payment amount into one or more payments(s) targeted towards the entity identified by a rule value is held in designated Create Payment [algorithms](#) defined on the distribution rule.

Rule Value Can Capture Additional Information

A rule value can also be used to capture additional information provided at payment time, like address information, comments, etc. Obviously payment distribution details with this type of rule value should have a zero payment amount, as they are not real payments. These distribution details end up being linked to a payment event, but unlike other distribution details they do not contribute any payments. You can think of these details as payment event characteristics.

You don't have to set up a Create Payment algorithm for distribution rules intended solely to capture additional payment information.

Setting Up The System To Use Distribution Rules

Setting Up Distribution Rules

Define a Distribution Rule for each payment event distribution method practiced by your business.

Distribution Rule - Main

To set up a distribution rule, navigate to **Admin > Financial > Distribution Rule > Add**.

Description of Page

Enter a unique **Distribution Rule** and **Description** for the distribution rule.

Provide a short and unique **Distribution Rule Label** to be used as rule's name throughout the system.

Characteristic Type defines the type of entity whose balance is relieved by the payment(s) this rule creates. For example, if this rule targets payments(s) towards a specific service agreement, you'd reference a characteristic that its value identifies a service agreement. We use the term "rule value" for the characteristic value.

Distribution Rule - Algorithms

Navigate to **Admin > Financial > Distribution Rule > Search** and navigate to the **Algorithms** page to set up the algorithms appropriate for your distribution rule.

Description of Page

The **Algorithms** grid contains algorithms that control important functions. You must define the following for each algorithm:

- Specify the algorithm's **System Event** (see the following table for a description of all possible events).
- Specify the **Algorithm** to be executed when the System Event executes. Set the **Sequence** to 10 unless you have a **System Event** that has multiple **Algorithms**. In this case, you need to tell the system the **Sequence** in which they should execute.

The following table describes each **System Event** (note, all system event's are optional and you can define an unlimited number of algorithms for each event).

System Event	Optional / Required	Description
Create Payment	Optional	This algorithm is executed to distribute a payment distribution detail payment amount into one or more payments.
Determine Tender Account	Optional	This algorithm is executed to determine the tender account associated with the payment distribution detail. Only one such algorithm may be specified.

Feature Configuration

You must set up a Financial Transaction Options [Feature Configuration](#) to define parameters that control various payment event distribution options.

The following points describe the various **Option Types** that must be defined:

- Always Enable Distribution Rule. This option controls whether the system should only use the distribution rule method to add payment events or rather allow both the default method and the distribution rule method to coexist.

- Enter Y if the system should always use distribution rules. With this setting, navigation to the Payment Event page in add mode opens up the [Payment Event Quick Add](#) page (defaulting it to the single payment event dialog). This dialog is designed to create a payment event using distribution rules
- Enter N if the system should allow both methods. With this setting, navigation to the Payment Event page in add mode opens up the standard [Payment Event - Add Dialog](#) that uses the default method to create a payment event. If you want to use the distribution rule method, navigate to the Payment Event Quick Add page from the menu.
- Default Distribution Rule. This option states your default distribution rule that appears throughout the system.

Cancel Reasons

As described in [The Financial Big Picture](#), the various types of financial transactions can be canceled if their financial impact needs to be reversed from the system. Whenever a financial transaction is canceled, a cancel reason must be specified. This section describes the control tables that contain the cancel reason codes.

Setting Up Bill (Segment) Cancellation Reasons

Open **Admin > Billing > Bill Cancel Reason** to define your bill segment cancellation reason codes.

Description of Page

Enter an easily recognizable **Bill Cancel Reason** and **Description** for the bill cancellation reason.

Only use **System Default** on those reason codes that are placed on bill segments that are automatically canceled by the system. Valid values are: Turn off auto-cancel, Bad estimated read auto-cancel, MDM Corrected Read, and Mass Cancel. The reason code identified as Turn off auto-cancel is placed on bill segments that are automatically canceled when the final bill segment ends before the prior bill (and therefore we have to cancel the prior bill). The reason code identified as Bad estimated read auto-cancel is placed on bill segments that are automatically canceled by the system when it detects that it used an estimated read whose consumption is greater than the next actual read (and therefore we have to cancel the estimated bill segment). The reason code identified as Mass Cancel is placed on bill segments that are canceled as a result of the execution of the Mass Cancellation background process. The reason code identified as MDM Corrected Read is placed on bill segments that are automatically canceled by the system when processing a corrected read notification. Corrected read notifications are received from MDM when reads that were used in bill determinant calculation requests (usage requests) are replaced or modified. This notification may result in the rebill of frozen bill segments. Refer to [Usage Requests](#) for more information.

NOTE:

Required values. You must have one reason code defined for each of the System Default values.

Setting Up Payment Cancellation Reasons

Open **Admin > Financial > Pay Cancel Reason** to define your payment cancellation reason codes.

Description of Page

Enter an easily recognizable **Cancel Reason** and **Description** for the payment cancellation reason.

Turn on the **NSF Charge** switch if the system should invoke the non-sufficient funds (NSF) algorithm when a tender is cancelled using this reason code. Refer to [NSF Cancellations](#) for more information.

The next several fields are used to change an account's credit rating or cash-only points if a tender is canceled using the respective reason code.

- Use **Affect Cash-Only Score By** to define how tenders canceled using this reason will affect the account's cash-only score. This should be a positive number. When a customer's cash-only points exceed the cash-only threshold amount defined on the installation record or the account's CIS Division, the account is flagged as cash only during payment processing and on Control Central.
- Use **Affect Credit Rating By** to define how tenders canceled using this reason will affect the account's credit rating. This should be a negative number. A customer's credit rating is equal to the start credit rating amount defined on the installation record or the account's CIS Division plus the sum of credit rating demerits that are currently in effect.
- Use **Months Affecting Credit Rating** to define the length of time the demerit remains in effect. This information is used to define the effective period of the credit rating demerit record.

FASTPATH:

For more information, refer to [Account - Credit Rating](#).

NOTE:

The payor gets the credit rating / cash only hit. When you cancel a tender you must specify a cancellation reason. If the cancellation reason indicates a credit rating / cash only demerit should be generated, the system levies the credit rating transaction on the PAYOR's account.

The **System Default** is specified on those cancellation reasons that are placed on payment segments that are automatically cancelled by the system. Valid values are: Re-opened Bill. The Re-opened Bill value is used as follows:

- Payments are automatically created for accounts who pay their bills automatically when their bills are completed.
- If such a bill is reopened before the automatic payment is interfaced to the paying authority, the system automatically cancels the payment. The Re-opened Bill cancellation reason is placed on such payments.

Setting Up Adjustment Cancellation Reasons

Open **Admin > Financial > Adjustment Cancel Reason** to define your adjustment cancellation reason codes.

Description of Page

Enter an easily recognizable **Cancel Reason** and **Description** for each adjustment cancellation reason.

Miscellaneous Financial Controls

This section describes miscellaneous control tables.

A/P Check Request

Adjustments whose adjustment type is marked with an A/P check request code are interfaced to your A/P system. Your A/P system then cuts the checks.

FASTPATH:

Refer to [Controls The Interface To A/P](#) for more information about the accounts payable interface.

You must set up at least one A/P check request code if you want A/P to cut checks.

To set up A/P check request types, open **Admin > Financial > A/P Request Type**.

Description of Page

Enter an easily recognizable **A/P Request Type** for the accounts payable request type.

Use **Due Days** to define when the check is cut. The cut date is equal to the adjustment date plus due days.

Select a **Payment Method**. Choose from these options:

System Check System check

Billable Charge Line Type

NOTE:

Background information. Before using this page, you should be comfortable with the topics described under [Setting Up Billable Charge Templates](#) and [Uploading Billable Charges](#).

Billable charge line types will simplify the effort required to interface billable charges from an external system. Each line type contains values that will be defaulted onto the line details associated with the uploaded billable charges. Obviously, this defaulting is possible only if you specify a billable charge line type on the billable charge upload staging lines.

To set up billable charge line types, select **Admin > Billing > Billable Charge Line Type > Add**.

Description of Page

Enter an easily recognizable **Billable Charge Line External Type** and **Description**.

Use **Currency Code** to define the currency to be defaulted onto billable charge upload lines that reference this line type.

Use **Show on Bill** to define the value to be defaulted into the Show on Bill indicator on billable charge upload lines that reference this line type.

Use **App in Summary** to define the value to be defaulted into the App in Summary indicator on billable charge upload lines that reference this line type.

Use **Memo Only, No GL** to define the value to be defaulted into the Memo Only, No GL indicator on billable charge upload lines that reference this line type.

Use **Distribution Code** to define the values to be defaulted into the Distribution Code field on billable charge upload lines that reference this line type.

Payables Cash Accounting

In some areas, taxes and other 3rd party liabilities are not truly payable until the customer remits payment. We refer to this as "payables cash accounting". This practice should be contrasted with "payables accrual accounting" in which the liability is realized when the bill is created (as opposed to when it is paid).

If your organization does not practice payable cash accounting, you may skip this section as accrual accounting is the system default. If you practice payables cash accounting, the contents of this section describe how to configure the system appropriately.

Accrual versus Cash Accounting Example

The following is an example of the financial events that transpire when a customer is billed and payment is received using accrual accounting.

Event	GL Accounting	Tax Payable Balance
Bill segment created	A/R 110	(10)
	Revenue <100>	
	Tax Payable <10>	
Payment received	Cash 110	(10)
	A/R <110>	

In the above example, you'll notice that the payable is booked when the bill is created. Let's contrast this with what takes place if the payable is subject to payables cash accounting.

Event	GL Accounting	Tax Payable Balance	Tax Holding Balance
Bill segment created	A/R 110	0	(10)
	Revenue <100>		
	Tax Holding <10>		
Payment received	Cash 110	(10)	0
	A/R <110>		
	Tax Holding 10		
	Tax Payable <10>		

Notice that when the bill segment is produced, the liability is not booked, rather, the amount of the liability is placed in a "holding" GL account. When the customer pays, the moneys are transferred from the "holding" GL account to the true tax payable account.

NOTE:

Cash accounting is only applicable for liabilities. In the above example, you'll notice that only the tax payable account had cash accounting implications. This is because organizations that practice cash accounting only do it for liability accounts; they never do it for assets, revenue or expenses.

If the above seems simple, consider the following complications that must be considered:

- What happens if a partial payment is received?
- What happens if there are multiple taxes subject to cash accounting rules?
- What happens if the A/R is relieved via a deposit seizure (or transference of a credit balance from another SA)?
- What if, after payment, the original bill segment is cancel/rebilled resulting in a different amount of tax (keep in mind that the payable got booked when the payment was received)?
- What happens if the payment is cancelled?
- What if the payment isn't received and we have to write-off debt?
- What happens if the customer overpays?
- What happens if the customer is allowed to prepay their tax (this is a common practice in the United Kingdom) and then the tax rate changes at billing time?

The above points, and more, are discussed below.

Distribution Code Controls Cash Accounting For A GL Account

NOTE:

If you do not understand the significance of distribution codes, please refer to [Setting Up Distribution Codes](#).

Whether or not cash accounting is used for a specific GL account is defined on HOLDING GL account's distribution code (i.e., the holding GL account references the true payable account).

It is very important that unique payable and holding distribution codes be used for each type of tax subject to cash accounting rules. For example, if you have cash accounting requirements for both value-added tax (VAT) and a climate levy, you would need four distribution codes:

- VAT Payable.
- VAT Holding.
- Climate Levy Payable.
- Climate Levy Holding.

Without unique distribution codes for each payable and holding account, the system cannot keep track of how much of a given tax is being held, awaiting payment.

Bill Segments and Cash Accounting

The contents of this section describe how cash accounting is implemented when bill segments are created.

Bill Segment Financial Transactions Are Not Affected By Cash Accounting

There are NO changes to rate calculation associated with cash accounting. This is because the rate components that calculate tax reference the HOLDING payable distribution codes.

NOTE:

Prepaid taxes - future functionality. If your organization allows customers to prepay taxes in anticipation of a future tax increase (the customers receive the lower rate if they pay in advance), please speak to your account manager for information about when corresponding functionality will be available.

Payment Segments and Cash Accounting

The contents of this section describe how cash accounting is implemented when payment segments are created.

Payment Segment Financial Transaction Algorithms Transfer Holding Amounts to Payable GL Accounts

Logic exists in the pay segment's FT algorithm that transfers amounts from payable holding distribution codes to their respective payable real distribution codes.

FASTPATH:

Refer to [Setting Up Payment Segment Types](#) for how to define the appropriate FT algorithm.

The following table shows what happens to the financial transaction associated with the payment segment for a cash accounting customer.

Event	GL Accounting
Bill segment is created	A/R 110
	Revenue <100>
	Tax Holding <10>
Payment segment relieves receivables	Cash 110
	A/R <110>
Additional GL details created when the payment segment FT algorithm transfers the holding amount to a payable account	Tax Holding 10
	Tax Payable <10>
Net effect of the above	Cash 110
	A/R <110>
	Tax Holding 10
	Tax Payable <10>

How Does The System Know What Amounts To Transfer From Holding To Payables?

When a payment segment is created for an account that is subject to cash accounting processing, the system determines if there is a CREDIT balance for any holding distribution code in respect of the service agreement. If so, it generates additional GL details to transfer moneys from the holding distribution code to the payable distribution code in proportion to the amount of receivables relieved by the payment. Therefore, if 100% of receivables are relieved by the payment segment, 100% of the holding amounts will be transferred to payable distribution codes. Refer to [Partial Payments Result In Partial Payables](#) for an example of what happens when a partial payment is created.

Partial Payments Result In Partial Payables

The previous example showed the entire tax holding amount being transferred to the tax payable account. The entire holding amount was transferred because the service agreement was paid in full. If a partial payment is received, only part of the holding amount will be transferred to the payable amount (proportional to the amount of receivables reduced by the payment). An example will help make the point.

Event	GL Accounting	Tax Payable Balance	Tax Holding Balance
Bill segment created	A/R 110	0	(10)
	Revenue <100>		
	Tax Holding <10>		
Partial payment received	Cash 27.50	(2.50)	(7.50)
	A/R <27.50>		
	Tax Holding 2.50		
	Tax Payable <2.50>		

The above example assumes the use of the base product payment segment FT creation algorithm PSEG-AC to transfer the holding amount to the tax payable account. If multiple holding accounts are used, you may want to specify which holding amounts are relieved first. The base product includes an additional payment segment FT creation algorithm C1-FTGL-PSAC that handles booking holding amounts based on a priority.

Partial Payments Using Accounting Priority

To book holding amounts based on a priority, each holding distribution code must be assigned an **Accounting Priority**. When a partial payment is posted, only part of the holding amount will be transferred to the payable amount (proportional to the amount of receivables reduced by the payment). When the holding amount consists of various holding distribution codes with different accounting priorities, the amount to transfer is allocated as follows:

- Holding distribution codes associated with the oldest debt are settled first
- Within the same debt age, holding distribution codes with a higher accounting priority are booked first. If more than one distribution code shares the same priority, the settlement is distributed among them in proportion to the holding account balance

The above logic is handled by the payment segment FT creation algorithm C1-FTGL-PSAC. As an example of how these rules apply, let's assume an implementation practices cash accounting; i.e. revenue, taxes and other third party liabilities are not recognized until payment is received. Also assume the following distribution codes have been configured:

Holding Distribution Code	Description	Cash Accounting Distribution Code	Accounting Priority
HLD-LPC	Late Payment Charge	R-MISC	10
HLD-RGEN	Revenue - Generation Charge	R-GEN	20
HLD-RDIS	Revenue - Distribution Charge	R-DIST	30
HLD-RTRN	Revenue - Transmission Charge	R-TRAN	30
HLD-THRD	3 rd Party Charges	R-THRD	40
HLD-VAT	VAT	A/P-VAT	90

Assume a customer has an outstanding third party charge with an arrears date of 2/Jan/2009:

Event	GL Accounting	SA's Payoff Balance	Holding Balances					
			HLD-LPC	HLD-RGEN	HLD-RDIS	HLD-RTRN	HLD-THRD	HLD-VAT
Unpaid Amount	A/R 50 HLD-HRD <45> HLD-VAT <5>	50	0	0	0	0	(45)	(5)

A bill is created for a customer and the result of the bill's financial transactions (an LPC adjustment in the amount of 10 and a bill segment in the amount of 127) include the following FT GL lines (both financial transactions have an arrears date of 15/Jan/2009):

Event	GL Accounting	SA's Payoff Balance	Holding Balances					
			HLD-LPC	HLD-RGEN	HLD-RDIS	HLD-RTRN	HLD-THRD	HLD-VAT
Bill segment created	A/R 127	177	0	(15)	(20)	(55)	(55)	(32)

HLD-RGEN
<15>
HLD-RDIS
<20>
HLD-RTRN
<55>
HLD-THRD
<10>
HLD-VAT
<27>

Adjustment created	A/R 10	187	(10)	(15)	(20)	(55)	(55)	(32)
	HLD-LPC							
	<10>							

No payment is received prior to the next bill. The result of the next bill's financial transaction (a bill segment in the amount of 100) includes the following FT GL lines (this financial transaction has an arrears date of 16/Feb/2009):

Event	GL Accounting	SA's Payoff Balance	Holding Balances					
			HLD-LPC	HLD-RGEN	HLD-RDIS	HLD-RTRN	HLD-THRD	HLD-VAT
Bill segment created	A/R 100	287	(10)	(30)	(40)	(100)	(65)	(42)
	HLD-RGEN							
	<15>							
	HLD- RDIS							
	<20>							
	HLD- RTRN							
	<45>							
	HLD- THRD							
	<10>							
	HLD-VAT							
	<10>							

The following shows the result if a customer makes a payment on 20/Feb/2009. At payment time we'll build a table of holding amounts by accounting priority and debt age as follows:

Distribution Code & Priority	HLD-LPC	HLD-RGEN	HLD-RDIS	HLD- RTRN	HLD-THRD	HLD- VAT
Debt Age						
4 days old		(15)	(20)	(45)	(10)	(10)
36 days old	(10)	(15)	(20)	(55)	(10)	(27)
49 days old					(45)	(5)

Examples of Partial Payments Using Accounting Priority

The examples below assume a customer has the financial history described above and attempts to illustrate the financial effect when a payment is made.

- [Example 1 - Customer Pays In Full](#)
- [Example 2 - Customer Makes a Partial Payment](#)
- [Example 3 - Customer Makes a Partial Payment](#)

Example 1 - Customer Pays In Full

Assume the customer makes a payment in the amount of 287. This amount is sufficient to satisfy all holding amounts, so the payment will have the following financial effect:

Event	GL Accounting	SA's Payoff Balance	Holding Balances					
			HLD-LPC	HLD-RGEN	HLD-RDIS	HLD-RTRN	HLD-THRD	HLD-VAT
Payment received	Cash 287	0	0	0	0	0	0	0
	A/R <287>							
	HLD-LPC 10							
	R-MISC <10>							
	HLD-RGEN 30							
	R-GEN <30>							
	HLD- RDIS 40							
	R-DIST <40>							
	HLD- RTRN 100							
	R-TRAN <100>							
	HLD- THRD 65							
	R-THRD <65>							
	HLD-VAT 42							
	A/P-VAT <42>							

[Top of the Page](#)

Example 2 - Customer Makes a Partial Payment

Assume the same financial history described above for a customer and a partial payment in the amount of 70 is made. This amount is not sufficient to satisfy the total holding amounts of 287, so the system will start settling held amounts starting with distribution codes with the oldest debt first from highest priority until the payment amount is exhausted.

A payment in the amount of 70 will be applied in the following sequence

Distribution Code & Priority	HLD-LPC (10)	HLD-RGEN (20)	HLD-RDIS (30)	HLD-RTRN (30)	HLD-THRD (40)	HLD-VAT (N/A)
Debt Age						
4 days old		(15.00)	(20.00)	(45.00)	(10.00)	(10.00)
36 days old	③ (10.00)	④ (15.00)	(20.00)	(55.00)	(10.00)	(27.00)
49 days old					① (45.00)	② (5.00)

The following describes how the holding amounts will be booked as a result of this partial payment:

- Settle oldest debt first (49 days old), i.e. 3rd Party Charges (HLD-THRD) and VAT (HLD-VAT). Note that even though these holding accounts have the lower accounting priorities, they are booked first because they have the oldest debt. An amount of 20 now remains on the partial payment.
- Next, we'll settle the 36 days old debt from the highest priority:
 - Late Payment Charge (HLD-LPC) in the amount of 10. An amount of 10 now remains on the partial payment
 - Revenue - Generation Charge (HLD-RGEN) gets the remaining payment amount of 10
- So, this partial payment in the amount of 70 will result in the following financial effect:

Event	GL Accounting	SA Balance	Holding Balances					
			HLD-LPC	HLD-RGEN	HLD-RDIS	HLD-RTRN	HLD-THRD	HLD-VAT
Payment received	Cash 70 A/R <70> HLD-LPC 10 R-MISC <10> HLD-RGEN 10 R-GEN <10> HLD-THRD 45 R-THRD <45> HLD-VAT 5 A/P-VAT <5>	217	0	(20)	(40)	(100)	(20)	(37)

[Top of the Page](#)

Example 3 - Customer Makes a Partial Payment

Assume the same financial history described above for a customer and a partial payment in the amount of 220 is made. This amount is not sufficient to satisfy the total holding amounts of 287, so the system will start settling held amounts starting with distribution codes with the oldest debt first from highest priority until the payment amount is exhausted.

A payment in the amount of 220 will be applied in the following sequence

Distribution Code & Priority	HLD-LPC (10)	HLD-RGEN (20)	HLD-RDIS (30)	HLD-RTRN (30)	HLD-THRD (40)	HLD-VAT (NA)
Debt Age						
4 days old		3 (15.00)	10 (20.00)	10 (45.00)	(10.00)	(10.00)
36 days old	6 (10.00)	4 (15.00)	5 (20.00)	6 (55.00)	7 (10.00)	8 (27.00)
49 days old					1 (45.00)	2 (5.00)

The following describes how the holding amounts will be booked as a result of this partial payment:

- Settle oldest debt first (49 days old), i.e. 3rd Party Charges (HLD-THRD) and VAT (HLD-VAT). Note that even though these holding accounts have the lower accounting priorities they are booked first because they have the oldest debt. An amount of 170 now remains on the partial payment.
- Next, we'll settle the 36 days old debt from the highest priority, i.e. Late Payment Charge (HLD-LPC), Revenue - Generation Charge (HLD-RGEN), Revenue - Distribution Charge (HLD-RDIS), Revenue - Transmission Charge (HLD-RTRN), 3rd Party Charges (HLD-THRD) and VAT (HLD-VAT). An amount of 33 now remains on the partial payment.
- Next we'll settle the 4 day old debt from the highest priority:
 - Revenue - Generation Charge (HLD-RGEN) in the amount of 15. An amount of 18 now remains on the partial payment
 - The two holding accounts at the next priority have an outstanding amount of 65. Since the remainder of the payment is not enough to satisfy this amount, the remainder of the payment is prorated amongst HLD-RDIS and HLD-RTRN as follows:
 - $(\text{Remaining Pay Amount} / \text{Total Outstanding Holding Amount}) * \text{Holding Account Amount}$
 - So for the Revenue - Distribution Charge (HLD-RDIS) holding account the amount booked will be $(18/65 * 20) = 5.54$
- So, this partial payment in the amount of 220 will result in the following financial effect:

Event	GL Accounting	SA Balance	Holding Balances					
			HLD-LPC	HLD-RGEN	HLD-RDIS	HLD-RTRN	HLD-THRD	HLD-VAT
Payment received	Cash	67	0	0	(14.46)	(32.54)	(10)	(10)
	220							
	A/R							
	<220>							
	HLD-LPC 10							
	R-MISC							
	<10>							
	HLD-RGEN 30							
	R-GEN							
	<30>							
	HLD-RDIS							
	25.54							

R-DIST
<25.54>

HLD-
RTRN
67.46

R-TRAN
<67.46>

HLD-
THRD
55

R-THRD
<55>

HLD-
VAT32

A/P-VAT
<32>

Adjustments That Behave Like Payments

There are several types of adjustments that behave just like payments (in respect of payables cash accounting). Consider the following events:

- Seizing a deposit (i.e., transferring a credit from a deposit service agreement to a regular service agreement)
- Overpayments transferred from one service agreement to another

The above events should cause the system to transfer holding amounts to true payable amounts (notice that the above examples are all transfer adjustments).

However, there are many other adjustments that should NOT behave like payments. You control how the adjustment works by selecting the appropriate FT algorithm when you [set up adjustment types](#) (refer to ADJT-AC and ADJT-TC for a description of the base package algorithms that cause the holding amounts to be manipulated in proportion to the amount of receivable being adjusted; and to C1-FTGL-ADAC and C1-FTGL-ADTC for the base package algorithms that take **Accounting Priority** into consideration). In other words, there are adjustment FT algorithms that cause the transference of holding payable amounts to real payable amounts when the A/R balance is decreased by the adjustment.

NOTE:

Cash refunds can behave like "anti-payments". In addition to the above examples of transfer adjustments behaving like payments, you should be aware that cash refunds may impact your holding and true payable balances. Refer to [Cash Refunds](#) for more information.

Overpayment Of Taxes Due To Cancel/Rebills

Let's assume a cancel / rebill occurs after a payment is received and the net effect of the cancel / rebill is that the customer has overpaid their taxes.

Event	GL Accounting	Tax Payable Balance	Tax Holding Balance
Bill segment created	A/R 110	0	(10)

	Revenue <100>		
	Tax Holding <10>		
Payment received	Cash 110	(10)	0
	A/R <110>		
	Tax Holding 10		
	Tax Payable <10>		
Cancel	A/R <110>	(10)	10
	Revenue 100		
	Tax Holding 10		
Rebill	A/R 27.50	(10)	7.50
	Revenue <25>		
	Tax Holding <2.50>		

You'll notice that the amount payable to the taxing authority still indicates \$10 (the amount of tax that was paid by the customer). However, you'll notice that the tax holding balance is 7.50 (debit). This looks a bit odd, but it's correct. Remember that at this point, the customer has a credit balance of \$75 and this will be whittled down as successive bills are produced as shown below. Note: refer to [Cash Refunds](#) for an example of what happens if you refund the credit with a check rather than letting it whittle down.

Event	GL Accounting	Tax Payable Balance	Tax Holding Balance
		(10)	7.50
Bill segment created	A/R 55	(10)	2.50
	Revenue <50>		
	Tax Holding <5>		
Bill segment created	A/R 110	(10)	(7.50)
	Revenue <100>		
	Tax Holding <10>		

In the unlikely event of a payment being received while the tax holding has a debit balance, nothing will be done in respect of transferring funds from holding to payable (there is nothing to transfer).

Cash Refunds

If you refund moneys to a cash accounting customer, it's important to do the opposite of what was done when the payment was received (i.e., you need to transfer the payable back to the holding account). The following example should help clarify this situation (this example shows a refund due to a credit balance that occurred as a result of a cancel/rebill).

Event	GL Accounting	Tax Payable Balance	Tax Holding Balance	SA's Payoff Balance
Bill segment created	A/R 110	0	(10)	110
	Revenue <100>			
	Tax Holding <10>			
Payment received	Cash 110	(10)	0	0
	A/R <110>			
	Tax Holding 10			

	Tax Payable <10>			
Cancel	A/R <110>	(10)	10	(110)
	Revenue 100			
	Tax Holding 10			
Rebill	A/R 27.50	(10)	7.50	(82.50)
	Revenue <25>			
	Tax Holding <2.50>			
Payment refunded (via an A/P adjustment)	Cash <82.50>	(2.50)	0	0
	A/R 82.50			
	Tax Holding <7.50>			
	Tax Payable 7.50			

We understand this is tricky, but consider this - when a cash accounting customer makes a payment, the system transfers tax holding CREDIT balances to tax payable distribution codes in proportion to the amount of the receivable DEBIT amount that was reduced by the payment. Therefore, when cash is returned to the customer, the system should transfer tax holding DEBIT balances to tax payable distribution codes in proportion to the amount of the receivable CREDIT that was reduced by the refund.

NOTE:

The above takes place when an A/P adjustment is created if the related adjustment type references the appropriate FT algorithm (refer to ADJT-AC and **C1-FTGL-ADAC** for a description of the adjustment FT algorithms used for adjustments that behave like payments).

Overpayments

An overpayment, by definition, does not "match" to open items. However, the match type algorithms supplied with the base package will result in a balanced match event if an overpayment is made. The following points explain how this is achieved:

- The base package's match type algorithms will distribute the payment until the customer's current debt is satisfied.
- The amount of the overpayment will be kept on a separate SA (this only happens if you plug-in the appropriate Overpayment Distribution algorithm on your customer classes). Refer to [Overpayment Segmentation](#) for more information.
- When the payment is frozen, the payment segments that satisfy current debt will be matched against their respective open-items. The payment segment used to book the overpayment (on the overpayment SA) will not be matched.
- When future bills are completed, the credit balance on this "overpayment SA" will be transferred to the "real SAs" when future bills are completed (if you have plugged in the appropriate bill completion algorithm on the overpayment SA's SA type). If the overpayment satisfies all newly calculated charges, a match event is created that matches the new charges against the funds transferred from the overpayment SA. Refer to [When Are Match Events Created](#) for information about how the system creates match events at bill completion time when the new charges on the bill are satisfied by other credits (overpayments, deposit refunds, etc.).
- At some point in the future, the overpayment will be exhausted (i.e., all funds will be transferred to "real SAs"). At that point in time, the overpayment SA will close (assuming you set up the overpayment SA's SA type as a "one time"). At close time, the system creates a match event that matches the original overpayment payment segment with the adjustments that were used to transfer funds to the "real SAs". Refer to [When Are Match Events Created](#) for information about how the system creates match events when a SA closes.

Write Down Adjustment

Writing down debt is very different from [writing off debt](#). When you write down debt, you are removing the receivable with no expectation of it being paid. For example, most organizations write down small debit and credit balances as part of their write-off process (e.g., they don't send a very small amount to a collection agency).

Let's run through an example to illustrate this:

Event	GL Accounting	Tax Payable Balance	Tax Holding Balance	SA's Payoff Balance
Bill segment created	A/R 110	0	(10)	110
	Revenue <100>			
	Tax Holding <10>			
Payment received	Cash 109.50	(9.95)	.05	0.50
	A/R <109.50>			
	Tax Holding 9.95			
	Tax Payable <9.95>			
Write down cash accounting debt	Tax Holding 0.05	(9.95)	0	0
	Write Down Expense 0.45			
	A/R <0.50>			

In order to achieve the above, you must set up an adjustment type that references a special financial transaction algorithm (refer to non-accrual accounting write down algorithms ADJT-AD and **C1-FTGL-AD** for more information). This algorithm will reduce or increase the receivable balance accordingly AND cause any holding amounts to be set to zero. This adjustment type should be referenced on your write-down algorithm that is referenced on your write-off controls.

Write-Offs

At write-off time we may refund credit balances. The refunding of credit balances is handled by A/P adjustments and these have cash accounting processing as described under [Cash Refunds](#).

If we have to write-off debt, holding balances are relieved in proportion to the amount of debt that is written off (as usual). It's important to understand that for this to work, you must set up the system as follows:

- The tax holding distribution codes must have their override distribution switch turned on.
- The distribution code on the SA type associated with the service agreement to which the written-off payables are transferred must be the REAL payable distribution codes. This is important so that if the customer pays after the payables are reversed, we will be able to debit cash and credit the REAL payable distribution code.

Let's run through an example to illustrate this.

Event	Normal SA GL Accounting	Write Off Revenue SA GL Accounting	Reverse Liabilities SA GL Accounting
Bill segment created	A/R 110		
	Revenue <100>		
	Tax Holding <10>		
Write Off Time			

Reverse the held payables	Xfer 10 A/R <10>		Tax Holding 10 Xfer <10> Note, the tax holding only gets debited if you have turned on the override at write-off switch on its distribution code
Write off revenue	Xfer 100 A/R <100>	Write Off Expense 100 Xfer <100>	
If the customer subsequently pays		Cash 100 Write Off Exp <100>	Cash 10 Tax Payable <10> Note, the tax payable only gets credited if the SA type's distribution code has been defined as such

Deferred Accrual Accounting

Some implementations use a hybrid accounting method that combines cash and accrual accounting. In this case revenue, taxes, etc. are recognized on the earlier of the bill due date or the date payment is received. In this scenario, the cash accounting method is used up until the bill's due date, at which time the accrual method is enforced (let's call this "deferred accrual accounting"). A simpler flavor of deferred accrual accounting is when the revenue and liability recognition is done solely at bill due date regardless of when the payment is made.

Deferred accrual accounting affects distribution codes identified as **Use For Non-Accrual Accounting** with an associated **Accounting Method** of either Payable on Earlier of Payment or Due Date or Payable on Due Date. The system accomplishes the holding amount settlement on the bill due date using a customer class post bill completion algorithm C1-CR-BLRVWS that creates a bill review record to be processed on the bill's due date. The bill review batch process then analyzes these bill review records on the bill due date. If a bill review record is due for processing, the algorithm checks the outstanding balance of the holding accounts on each SA linked to the bill and creates a settlement adjustment for each SA.

Deferred Accrual Accounting Examples

The examples below illustrate the financial transactions that transpire under these different scenarios.

Example 1 - Payable On Due Date, Customer Pays In Full

The following is an example of the financial events that transpire when a customer is billed and full payment is received prior to the bill due date. The accounting method in this case is Payable On Due Date.

Event	GL Accounting	Tax Payable Balance	Tax Holding Balance
Bill segment created	A/R 110	0	(10)
	Revenue <100>		
	Tax Holding <10>		
Payment received	Cash 110	0	(10)

A/R <110>

Adjustment created on bill due date	Tax Holding 10	(10)	0
	Tax Payable <10>		

Example 2 - Payable On Due Date, Customer Does Not Pay

In the following example a customer is billed and no payment is received prior to the bill due date. The bill review batch process is responsible for creating the settlement adjustment for any outstanding holding amounts on the bill's due date. The accounting method in this case is Payable On Due Date.

Event	GL Accounting	Tax Payable Balance	Tax Holding Balance
Bill segment created	A/R 110	0	(10)
	Revenue <100>		
	Tax Holding <10>		
Adjustment created on bill due date	Tax Holding 10	(10)	0
	Tax Payable <10>		

Example 3 - Payable On Due Date, Customer Makes A Partial Payment

In the following example a customer is billed and a partial payment is received prior to the bill due date. The bill review batch process is responsible for creating the settlement adjustment for any outstanding holding amounts on the bill's due date. The accounting method in this case is Payable On Due Date.

Event	GL Accounting	Tax Payable Balance	Tax Holding Balance
Bill segment created	A/R 110	0	(10)
	Revenue <100>		
	Tax Holding <10>		
Payment received	Cash 27.50	0	(10)
	A/R <27.50>		
Adjustment created on bill due date	Tax Holding 10	(10)	0
	Tax Payable <10>		

Example 4 - Payable On Earlier Of Payment Or Due Date, Customer Pays In Full

In the following example a customer is billed and full payment is received prior to the bill due date. The accounting method in this case is Payable On Earlier Of Payment Or Due Date.

Event	GL Accounting	Tax Payable Balance	Tax Holding Balance
Bill segment created	A/R 110	0	(10)
	Revenue <100>		

	GL Accounting	Tax Payable Balance	Tax Holding Balance
Payment received	Cash 110	(10)	0
	A/R <110>		
	Tax Holding 10		
	Tax Payable <10>		

Example 5 - Payable On Earlier Of Payment Or Due Date, Customer Does Not Pay

In the following example a customer is billed and no payment is received prior to the bill due date. The bill review batch process is responsible for creating the settlement adjustment for any outstanding holding amounts on the bill's due date. The accounting method in this case is Payable On Earlier Of Payment Or Due Date. Note that if a payment is subsequently received after the settlement adjustment has been created, it's financial transaction(s) will not have any impact on the holding or liability accounts as these have already been booked.

Event	GL Accounting	Tax Payable Balance	Tax Holding Balance
Bill segment created	A/R 110	0	(10)
	Revenue <100>		
	Tax Holding <10>		
Adjustment created on bill due date	Tax Holding 10	(10)	0
	Tax Payable <10>		

Example 6 - Payable On Earlier Of Payment Or Due Date, Customer Partially Pays

In the following example a customer is billed and a partial payment is received prior to the bill due date. The bill review batch process is responsible for creating the settlement adjustment for any outstanding holding amounts on the bill's due date. The accounting method in this case is Payable On Earlier Of Payment Or Due Date. Note that if a payment is subsequently received after the settlement adjustment has been created, it's financial transaction(s) will not have any impact on the holding or liability accounts as these have already been booked.

Event	GL Accounting	Tax Payable Balance	Tax Holding Balance
Bill segment created	A/R 110	0	(10)
	Revenue <100>		
	Tax Holding <10>		
Payment received	Cash 27.50	(2.50)	(7.50)
	A/R <27.50>		
	Tax Holding 2.50		
	Tax Payable <2.50>		
Adjustment created on bill due date	Tax Holding 7.50	(10)	0
	Tax Payable <7.50>		

Payment Cancellations and Deferred Accrual Accounting

If a payment was responsible for transferring moneys from the holding distribution code to the payable distribution code, it stands to reason that if the payment is cancelled, it results in the reversal of this transfer from the holding distribution code to payable distribution code. If deferred accrual accounting is used and the payment is cancelled after the bill due date, the holding amounts that were transferred should remain booked.

Assume, for example, that the payment below was cancelled after the bill due date:

Event	GL Accounting
Payment received	Cash 110
	A/R <110>
	Tax Holding 10
	Tax Payable <10>

At cancellation, the above entry will be reversed, reinstating the balance in the holding account:

Event	GL Accounting
Payment cancelled after bill due date	Cash <110>
	A/R 110
	Tax Holding <10>
	Tax Payable 10

However, since the bill's due date has passed, the holding account needs to be booked. For open item accounts, the system comes with a customer class FT freeze algorithm (C1-PR-CA-RVS) that creates a bill review schedule for the affected bill, if one does not already exist. When the bill review batch process next runs, it checks the outstanding balance of the holding accounts on each SA linked to the bill and creates a settlement adjustment for each SA.

Event	GL Accounting
Adjustment created	Tax Holding 10
	Tax Payable <10>

Note that this solution is only applicable to open item accounting where the bill matched to the payment can be determined. If balance forward accounting is practiced, the bill or bills that the payment applied to cannot be determined. In this case, the next bill review record created for the account as part of billing will cause the balances of the holding accounts to be analyzed and the settlement will catch up at that point.

Open Item Accounting

The topics in this section provide background information about open-item accounting.

NOTE:

This section is only relevant for some organizations. The system configuration requirements described in this section are only relevant if your organization practices open-item accounting. If your organization practices balance-forward

accounting, you need only indicate such on your [customer classes](#); no other setup is required. Refer to [Open Item Versus Balance Forward Accounting](#) for more information about these two accounting practices.

Open-Item Versus Balance-Forward Accounting

If you practice open-item accounting, you match payments against bills. The term "open-item accounting" is used to describe this accounting practice because:

- Payments are matched against "open items" (i.e., unpaid bills and adjustments)
- Only unmatched bills and adjustments (i.e., open items) affect aged debt.

Contrast open-item accounting with "balance-forward" accounting - in a balance-forward world, payments are not matched to bills. Rather, payments implicitly relieve a customer's oldest debt. For example, consider the following unpaid financial transactions that exist for an account and the resultant aged debt.

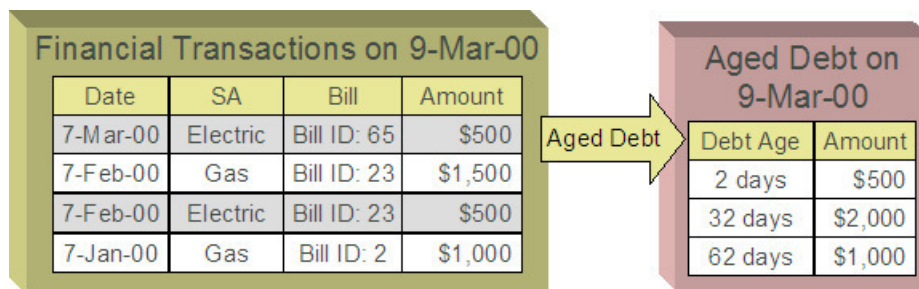

In a balance-forward world, if a \$1,000 payment was made on 9-Mar-00, the customer's aged debt would look as follows:

Debt Age	Amount
2 days	\$500
32 days	\$2,000

Notice how the \$1,000 payment relieves the 62 day old debt - it does this because, in a balance-forward world, payments payoff oldest debt first.

However, let's assume the customer wants the payment to settle their electric debt (e.g., because they disagree with the gas bills). If you could match the \$1,000 payment to the two electric bills (i.e., open-item accounting exists), the customer's aged debt would look as follows:

Debt Age	Amount
32 days	\$1,500
62 days	\$1,000

In sum,

- In an open-item world, payments are matched to bills and only unpaid bills and adjustments (i.e., open items) affect aged debt.

- In a balance-forward world, payments are not matched to bills and therefore a customer's aged debt is computed by aging debits (bills and adjustments) and then relieving the oldest debits using credits (payments and adjustments).

NOTE:

Financial Transactions and Bills. In an open-item world, only bill segments and adjustments are presented on a bill. When a bill is completed, only those bill segments and adjustments to be presented are swept onto a bill. Payment and payment cancellation FTs, bill segment FTs canceled before bill completion together with their corresponding bill segment cancellation FTs, and adjustment FTs marked as do not show on bill are not swept onto a bill. An adjustment's adjustment type and its algorithms determine if its FT will show on a bill by default.

Accounting Method Defined On Your Customer Classes

You define the type of accounting method that is practiced ([balance-forward versus open-item](#)) on your [customer classes](#). For example, residential customers can practice balance-forward accounting whereas industrial / commercial customers can practice open-item accounting.

Match Events

Match events are used to match open-items (i.e., debit and credit financial transactions) together. The topics in this section provide an overview of match events.

Match Events Match Debit FTs To Credit FTs

For open-item customers, the system matches credit financial transactions (FT's) to debit FT's under a [match event](#). The following is an example of a match event associated with two \$500 payments that satisfy the debt associated with one bill (on February 2000).

Match Event

Account: 10291011

Status: Balanced

Credit FT's: \$1,000

Date	SA	FT Info	Amount
7-Mar-00	Electric	None	\$500
1-Mar-00	Electric	None	\$500

Debit FT's: \$1,000

Date	SA	FT Info	Amount
15-Feb-00	Electric	Bill ID: 22	\$1,000

Notice the following:

- The match event matches 2 credit FT's against a single debit FT. A match event may contain an unlimited number of FT's.
- The match event contains FT's associated with a single account. While the FT's under a match event may belong to multiple service agreements, all FT's under a match event must belong to the same account.
- The match event only contains bill segments that belong to a single bill. If you mix multiple bills under a single match event, then an individual bill balance cannot be properly determined when partial payments exist.
- The status of the match event is balanced. This is because the sum of the debits equals the sum of the credits. If debits do not equal credits, the status of the match event would be open and the various FT's would still affect the customer's aged debt. Refer to [Match Event Lifecycle](#) for more information.

WARNING:

It is strongly encouraged that you refrain from mixing multiple bills on a single match event. If you stick by the rule of "just one bill per match event" you will then be able to determine the outstanding balance of a partially paid bill (see the [bill page](#), bill summary section). However, if you mix more than one bill under a match event, a particular bill's balance may become indeterminate. Algorithm types have been provided which help to enforce this rule of "one bill per match event", please refer to Match By Bill, Pay Oldest Bill First for an example of a matching algorithm that enforces this notion.

When Are Match Events Created?

The following points describe when match events are created for open-item accounts:

NOTE:

Match events are only created for open-item accounts (i.e., those accounts with a customer class that indicates open-item accounting is practiced). Match events may not be created for balance-forward accounts.

- The system can create one or many match events when a payment is added. This match event matches the payment's credit FT's with the debit and credit FT's from bill segments and adjustments. The FT's that are linked to the match event are controlled by the payment's **match type** and **match value** (payments made by open-item customers must reference a match type and match value). Refer to [Payments And Match Events](#) for more information.
- The system may create a match event when any type of financial transaction is cancelled. This match event groups together the original FT with its cancellation FT. Refer to [How Are Match Events Cancelled?](#) for more information.
- The system creates a match event when a bill is completed for customers that pay automatically (i.e., direct debit customers). The match event groups together the bill's new charges against the automatic payment's payment segments.
- The system creates a match event when a bill is completed where the new charges are offset by other financial transactions. For example,
 - Consider a bill that contains a deposit refund. If the sum of the deposit refund equals or exceeds the amount of the bill, the bill's FT's can be matched against the debit refunds FT's. Refer to [Refunding Deposits](#) for more information about deposit refunds.
 - Consider a bill whose new charges are offset by a previous overpayment. Refer to [Over Payments](#) for more information about overpayments.

FASTPATH:

Refer to [Bill Lifecycle](#) for more information about what happens during bill completion.

- The system creates a match event when a service agreement closes and the service agreement has unmatched FT's. For example,

- Consider a deposit service agreement that closes when the deposit is refunded to the customer. The system will create a match event with the deposit SA's FT's (the original credit and the debits used to refund the deposit) when the deposit SA closes (i.e., when its credit balance falls to zero). Refer to [Refunding Deposits](#) for more information about deposit refunds.
- Consider a service agreement for utility debt that is written off. This service agreement closes when the system creates transfer adjustments to transfer the utility debt to a write-off service agreement (or writes down the debt). The system creates a match event to match the original debt to the transfer adjustments used to write-off the debt. Refer to [How Is Debt Financially Written Off](#) for more information about write-off processing.
- A user can create a match event manually at any time. Manual match events would be created under a variety of situations. For example:
 - If a customer disputes a charge. Refer to [Disputing Items](#) for more information about disputes.
 - To handle unusual situations when the system is unable to automatically match FT's together.

Match Event Lifecycle

The following diagram shows the possible lifecycle of a match event:

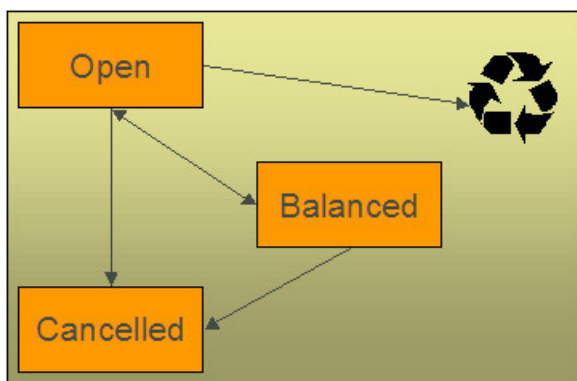

Match events are initially created in the open state. Financial transactions (FT's) linked to open match events affect arrears, but not in an open-item fashion. Rather, FT's linked to open match events affect arrears in a balance-forward fashion. Refer to [Open Item Versus Balance Forward Accounting](#) for more information about these two accounting methods.

A user may delete an open match event. When an open match event is deleted, its FT's may be linked to other match events.

The system automatically changes an open event's status to balanced when the sum of the debit financial transactions (FT's) equals the sum of the credit FT's for each SA on the match event. It's worth stressing that a match event may contain FT's from many SAs and each SA's FT's must sum to zero before the match event can become balanced.

A user may re open a balanced event (by adding / removing FT's so that the match event becomes unbalanced).

A user may cancel a balanced or open match event. Refer to [How Are Match Events Cancelled?](#) for more information about cancellation.

Payments And Match Events

As described under [When Are Match Events Created?](#), the system creates a match event when a payment is added for an open-item account. The system uses the payment's **match type** and **match value** to determine the FT's (e.g., bill segments and adjustments) that will be matched with the payment's FT's (i.e., the payment segments).

Another way to think of this is as follows:

- When most payments are distributed, the system calls the payment distribution algorithm that is plugged-in on the account's customer class.
- However, a payment that is made in respect of a specific bill requires a different distribution algorithm because the payment should only be distributed amongst the debt associated with the specific bill being paid. This is accomplished by referencing a match type / match value on the payment. The match type references the appropriate payment distribution algorithm. This algorithm is used rather than the customer class distribution algorithm.

For example, if a payment were made in respect of bill ID 192910192101, this payment would reference a match type of bill ID and a match value of 192910192101. At payment distribution time, the system calls the override payment distribution algorithm associated with this match type. The base package bill ID distribution algorithm does several things:

- It distributes the payment amongst service agreements associated with the bill.
- It creates a match event and links the bill's bill segment and adjustment FT's to it.
- Refer to the Bill ID Match Type Algorithm for more information about this algorithm.

NOTE:

The match type's distribution logic is not "hard coded". Because the match type's payment distribution logic is embedded in a plug-in algorithm, you can introduce new algorithms as per your company's requirements.

It's worth noting that payment *distribution* and *freezing* are two separate steps that typically happen in quick succession. The system's standard match event algorithms create the match event during payment distribution. This match event exists in the open state (because the payment segment's FT's have not yet been linked to the match event and therefore debit FT's do not equal credit FT's). The open match event references the debit FT's (the bill segments and adjustments) for which it pays. It is only at payment freeze time that the credit FT's (the payment segments) are linked to the match event thus allowing the match event to become balanced.

If, at freeze time, the payment's credit FT's do not equal the debit FT's on the match event, the match event is left in the open state. An alert will appear on Control Central to highlight the existence of open match events (if the appropriate alert algorithm is plugged in the installation record). In addition, you can also set up a To Do entry to highlight the existence of open match events.

Payments Are Matched To Debit Credit FTs

While the above discussion dealt with the typical situation where the payment's credit FT's are matched against a bill's debit FT's, we want to note that a payment's FT's may be matched against debit and credit FT's. Consider the following example:

Match Event

Account: 10291011

Status: Balanced

Bill 1929: \$2,900

Date	SA	FT Info	Cur Amount
7-Mar-00	Electric	Bill seg	\$1,500
6-Mar-00	Gas	Bill seg	\$1,500
1-Mar-00	Gas	Adj-Credit	\$-100

Pay: \$2,900

Match Type: Bill ID 1929

Date	SA	FT Info	Cur Amount
15-Mar-00	Electric	Pay seg	\$-1,500
15-Mar-00	Gas	Pay seg	\$-1,400

Notice that:

- The \$2,900 payment is distributed amongst two service agreements (electricity and gas).
- The FT's to which the payment segments are matched are both debit and credit FT's. Notice that the debit FT's (the bill segments) and the credit FT (the adjustment) sum to \$2,900.

Credits may result in a situation where the total amount on a bill for an SA is negative. This would be the case if in the above example the credit adjustment were for \$-1600 resulting in the total amount for the Gas SA on this bill to be \$-100 (credit). Assume a full payment of \$1400 is made towards this bill. The Bill ID Match Type Algorithm first allocates negative payment amounts to any SA credit amount on the bill being paid. It then carries over the credit amount to pay off other bill amounts. In this example, a "negative" payment segment is created to match the \$-100 credit of the Gas SA. Using the carried over credit a \$1500 payment segment is created to match the \$1500 debit of the Electric SA.

How Are Match Events Cancelled?

A user can cancel an open or balanced match event at any time. When a match event is cancelled, the event's FT's again effect arrears (and they can be associated with new match events). In other words, when a match event is cancelled, its FT's are released from the match event and become open-items.

In addition to manual cancellation, the system may automatically cancel a match event when the last of its payment FT's, if any, is cancelled (if you plug-in the appropriate FT freeze plug-in on your open-item customer classes).

For example, consider a match event that was created when a payment was made. If the payment is subsequently cancelled, the match event is also cancelled (thus releasing the match event's FT's) if no other payment FT's are linked to the match event. Please be aware that FT cancellation also causes a new match event to be created. This match event matches the original FT (the payment segment) and its cancellation FT. This means that the only "open items" that will exist after a payment is cancelled are the debit FT's that were originally paid.

NOTE:

Reopening bills associated with automatic payment customers. While many payments are cancelled due to non-sufficient funds, please be aware that if you reopen a bill for which an automatic payment was created, the system will cancel the associated payment. If this payment is associated with a match event (because the account is an open-item account), the match event will be cancelled and a new match event will be created to match the original

automatic payment with its cancellation details. This is necessary because a new payment will be created with the bill is subsequently completed and this payment's FT's will be matched to the bill's FT's.

Canceling a payment can result in many match events being created. If a cancelled payment has multiple payment segments, a separate match event will be created for each payment segment.

While payment cancellation is the most common type of FT cancellation, be aware that bill segment or adjustment cancellation may also cause a new match event to be created. We don't necessarily want to always link the cancellation FT and its original FT to the same match event. For example, when the cancellation FT is swept on to the next bill it affects the next bill and not the original FT's bill. For cancellations that will not be swept on to the next bill (payment cancellation, cancellation of an adjustment that is not shown on bill, credit notes, and bill segment cancellation before the bill is completed) the system creates a new match event that matches the original FT and its cancellation FT. This way, neither FT affects aged debt. If the original FT was linked to an existing match event and no other FTs are left on this match event it is automatically canceled.

Current Amount Is Matched, Not Payoff

The system matches the current amount of financial transactions, not the payoff amount.

FASTPATH:

Please refer to [Current Amount versus Payoff Amount](#) for more information about current and payoff amounts.

Disputing Items

Open-item customers may dispute FT's that they are not comfortable paying. For example, a customer who receives a bill with an anomalous charge may decide to dispute it.

When an open-item customer disputes a charge, a user creates a match event and links the disputed FT(s) to it. This match event will be in the open state (because it does not contain FT's that sum to zero). In addition, the match event's "disputed switch" is turned on.

NOTE:

Alerts. An alert is displayed on control central to highlight the existence of disputed match events (if the appropriate alert algorithm is plugged in). In addition, you can also set up a To Do entry to highlight the existence of disputed match events.

While the dispute is being researched, the disputed amount will not affect aged debt, but it still forms part of the customer's balance. For example, consider the following unpaid financial transactions that exist for an account:

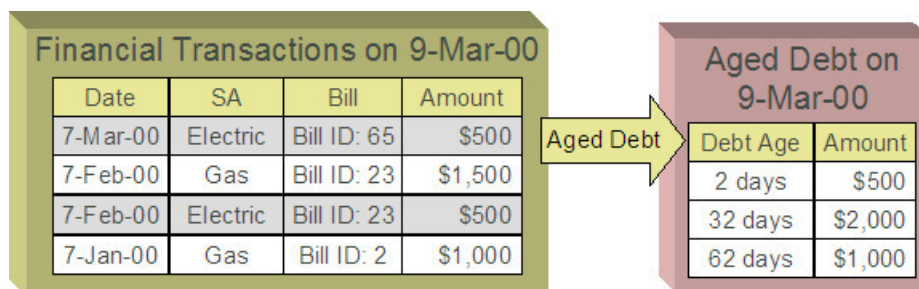

If the customer disputes the two electric bill segments, the customer's aged debt will look as follows:

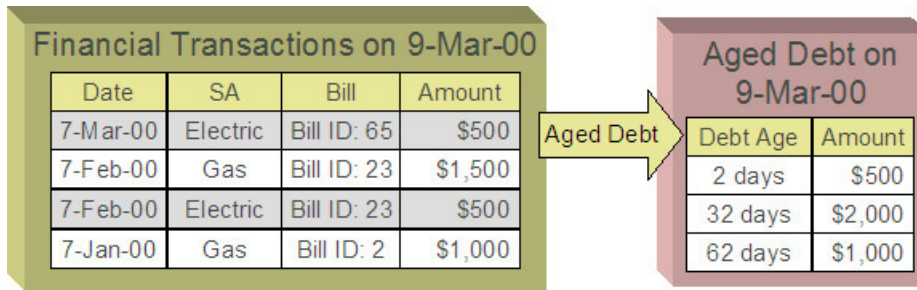

Notice how a new category of debt appears - Disputed. Also notice how the 2 day old debt disappears and the 32 day old debt is reduced by the disputed amount.

The system shows disputed debt on Control Central. In addition, in all places where aged debt appears in the system, disputed debt is shown as a separate debt category.

If the dispute goes in your company's favor, the disputed match event should be cancelled (thus allowing the FT's to again impact aged debt). For example, if we assume 3 days have passed and the dispute match event is cancelled, the customer's aged debt will look as follows:

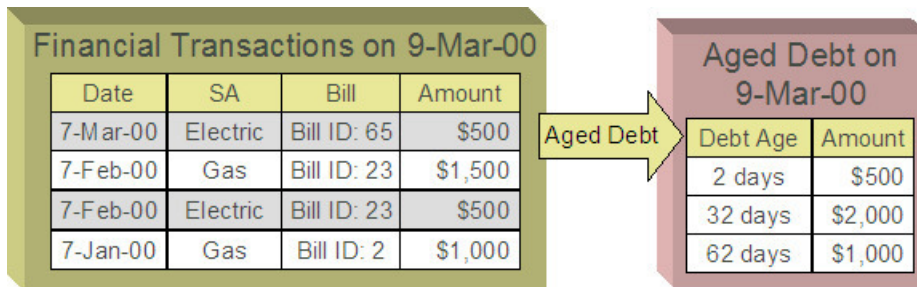

If the dispute goes in the customer's favor:

- You may decide to issue a credit note to cancel the offending bill or bill segment(s). As described above, the system in this case will automatically create new match events that match the original FTs with their cancellation FTs and cancel the disputed match event when the last item is unlinked from it.
- You may decide to cancel the offending bill segment(s) / adjustment(s). As described above, these cancellations are going to be swept on to the next bill. The system therefore will not automatically cancel the disputed match event. Notice that the cancellation effect of the disputed items is carried over on to the next bill. This means that the previously disputed items still need to be paid.

NOTE:

Cancel / rebill. If you cancel / rebill an offending bill segment, both the cancel and the rebill will become open-items that will be matched when the next bill is paid.

- You may decide to issue an adjustment to counter the effect of the disputed FT's. In this situation, you would simply link the adjustment FT to the disputed FT's (thus allowing the match event to become balanced). It is important to use in this case an adjustment that does not show on bill.

Pay Plans

You create a [pay plan](#) when a customer agrees to make one or more scheduled payments to satisfy past (or future) debt. These payments cannot be matched to open items because it is unlikely that debit FT's exist that equal the amount of each scheduled payment. However, you must specify a match type on all payments made by open-item customers. Therefore, a conundrum exists - the system requires a match type on payments made by open item accounts, but payments made for

pay plans cannot be matched to existing FT's. This conundrum is solved by the fact that match types do not have to specify an override payment distribution algorithm. The customer class's standard distribution algorithm is used for payments that reference such a match type.

You may wonder how these payments will eventually get matched to open items? If ALL payments associated with a pay plan occur before the next bill is paid (or if the pay plan exists to satisfy future debt), these payments will be swept onto the match event that is created when the customer pays their next bill. However, if the pay plan exists to payoff historical debt and this debt has not been entirely paid by the time of the next bill, an unmatched event will exist when the customer pays their subsequent bills (if the payment amount doesn't match the amount of new charges on the bill). Why? Because, the customer is not paying the entire amount of the bill and therefore the system will not be able to match the payment to open items. If this occurs, we recommend canceling the match events that are created when the customer pays their subsequent bills. When the customer finally pays off all outstanding debt, the system will create a single match event that will contain all payments and bill segments.

Over Payments

If a customer overpays a bill (i.e., we receive more cash than receivables), we strongly recommend you set up the system to NOT keep the excess credit on the customer's regular service agreements. Rather, we recommend you segregate the receivable onto an "excess credit" service agreement. If you do this, the system will transfer any excess credits to the regular service agreements at bill completion time. When this transfer occurs, the same accounting described under [Payments Segment Financial Transaction Algorithms Transfer Holding Amounts To Payable GL Accounts](#) occurs as shown in the following example. Note: this example assumes an excess credit of \$110 was transferred to a normal service agreement and the normal service agreement had \$10 of held payables.

FASTPATH:

Refer to [Overpayment Segmentation](#) for how to set up the system to segregate overpayments on a separate service agreement.

NOTE:

Why not keep excess credits on a customer's regular service agreement? Because the system can't differentiate between a credit that exists as a result of an overpayment and a credit that exists because of cancel/rebills, it would be impossible for the system to know if payables should be realized as a result of the reduced credit balance. However, if you keep overpayments on an excess credit service agreement, the system knows to treat any transference of these credits as "payments" and therefore it can transfer holding balances to true payables.

Event	Normal SA GL Accounting	Excess Credit SA GL Accounting
Bill segment created	A/R 110	
	Revenue <100>	
	Tax Holding <10>	
Payment of \$300 is received	Cash 110	Cash 190
	A/R <110>	Overpay <190>
	Tax Holding 10	
	Tax Payable <10>	
Bill segment created	A/R 110	
	Revenue <100>	
	Tax Holding <10>	

Transfer excess credit amount to normal service agreement (when bill is completed).	Xfer 110 A/R <110>	Overpay 110 Xfer <110>
Because the transfer adjustment is the equivalent of a cash relief outstanding tax holding is relieved in proportion to the amount of receivables that are reduced by the transfer	Tax Holding 10 Tax Payable <10>	
Net effect of the transfer	Xfer 110 A/R <110> Tax Holding 10 Tax Payable <10>	Overpay 110 Xfer <110>

NOTE:

Prepaid taxes - future functionality. If your organization allows customers to prepay taxes in anticipation of a future tax increase (the customers receive the lower rate if they pay in advance), we do not consider this prepayment to be an overpayment. Rather, it is a payment of future taxes that will be remitted to the taxing authorities at payment time (due to cash accounting). Please speak to your account manager for when corresponding functionality will be available.

Setting Up The System To Enable Open Item Accounting

The following section provides an overview of how to enable open-item accounting.

Match Type Setup

The number of match types that you will need is dependent on the number of ways you want payments to be matched to open items. At a minimum, you will probably need the following match types:

- **Bill ID.** This match type should reference an override payment distribution algorithm that distributes the payment based on the bill ID specified on the payment (in match value). Refer to [Payments And Match Events](#) for more information.
- **SA ID.** This match type should reference an override payment distribution algorithm that distributes the payment based on the SA ID specified on the payment (in match value). Refer to [Payments And Match Events](#) for more information.
- **Pay Plan.** This match type should NOT reference an override payment distribution algorithm (if this algorithm is blank, the customer class's payment distribution algorithm is used). Refer to [Pay Plans](#) for more information.

Match Event Cancellation Reason Setup

The number of match event cancellation reasons that you will need is dependent on the number of ways your organization can justify the cancellation of a match event. At a minimum, you will probably need the following match event cancellation reasons:

- **FT Cancellation.** This cancel reason should be referenced on the Customer Class FT Freeze algorithm that is responsible for canceling match events when one of its financial transactions is cancelled.
- **Incorrect Allocation.** This cancel reason should be specified by users when they cancel match events that were created by the system erroneously.

Customer Class Setup

The following points describe [customer class](#) oriented set up functions:

- Turn on the open-item accounting switch.
- Set up the following algorithms for each CIS division:
 - Specify a **payment freeze** algorithm that causes a payment's FT's to be linked to the match event that was created when the payment was distributed. Refer to [Payments And Match Events](#) for more information.
 - Specify a **FT freeze** algorithm that causes match events to be cancelled (and a new match event to be created) when a FT is cancelled. Refer to [How Are Match Events Cancelled](#) for more information about cancellation.
 - We strongly recommend specifying an **overpayment** algorithm that causes overpayments to be segregated onto an "excess credit / overpayment" SA. Refer to [Overpayments](#) for more information.

Overpayment SA Type Setup

Specify a **bill completion** algorithm that causes the credit amount on overpayment SAs to be transferred to newly create debt (created when the bill is created). This algorithm transfers an overpayment SA's balance to regular SAs and creates a match event if the overpayment covers the entire bill. Refer to [Overpayments](#) for more information.

Installation Record Setup

Specify an **automatic payment** algorithm that causes a match event to be created when automatic payments are created for open-item accounts. The base package algorithm will do this for you if you specify the appropriate parameter on the algorithm. Refer to APAY-CREATE for more information about this algorithm.

If you want a Control Central alert to highlight when the current account has any open match events, plug in the appropriate **control central alert** algorithm on your installation record. Refer to C1-OPN-MEVT for more information about this algorithm.

If you want to enable manual pay segment distribution for open item accounts, along with other functions, you will need to plug in an installation algorithm for bill balance calculation. Refer to C1-OI-BI-AMT for more information about this algorithm.

To Do Entry Setup

Two To Do types are supplied with the base package:

- **TD-MODTL**. This To Do type highlights the presence of open, disputed match events.
- **TD-MONTL**. This To Do type highlights the presence of open, non-disputed match events.

Each of the above To Do types should be configured with the roles that work on entries of each type.

In addition, the account management group and/or divisions from which the default roles are extracted should be updated to define the role that should be defaulted for each of the above To Do types.

FASTPATH:

Refer to [The Big Picture Of To Do Lists](#) for more information about To Do lists.

Setting Up Match Types

Most payments are distributed amongst service agreements using the payment distribution algorithm specified on the payment's account's customer class. This algorithm decides how to distribute a payment amongst an account's existing debt if the customer doesn't specify how the payment should be distributed.

A customer can specify how a payment is distributed by specifying a match type and match value on their payments. Consider the following examples:

- Customers that are subject to open-item accounting (this is defined on the account's customer class) tell the system exactly which debt is covered by their payments. For example, an open-item customer might make a payment in respect of bill ID 123919101919.
- Even non open-item customers can direct payments to specific SAs. For example, the system allows a balance-forward customer's payment to be directed to a specific service agreement (however, they cannot direct payments to specific bills as only open-item customers can do this).

Match types are used to define the specific type of debt that is covered by a payment. The match type contains the algorithm that effectively overrides the standard payment distribution algorithm defined on the account's customer class.

NOTE:

Background information. Please refer to [Payments And Match Events](#) and [Match Type Setup](#) for more information about how match types are used.

To set up match types, select **Admin > Financial > Match Type**.

Description of Page

Enter an easily recognizable **Match Type** and **Description**.

Define the **Pay Dist Override Algorithm** used to distribute payments that reference this match type. If you haven't done so already, you must set up this algorithm in the system. To do this:

- Create a new algorithm (refer to [Setting Up Algorithms](#)).
- On this algorithm, reference an Algorithm Type that overrides the normal payment distribution algorithm.

Setting Up Match Event Cancellation Reasons

When a match event is canceled, a cancel reason must be supplied.

NOTE:

Background information. Refer to [How Are Match Events Cancelled?](#) and [Setting Up Match Event Cancellation](#) for more information about cancellation.

To set up match event cancellation reasons, select **Admin > Financial > Match Event Cancel Reason**.

Description of Page

Enter an easily recognizable **Match Event Cancel Reason** and **Description**.

Fund Accounting

The topics in this section provide background information about fund accounting.

NOTE:

This section is only relevant for some organizations. The system configuration requirements described in this section are only relevant if your organization practices fund accounting (this type of accounting is typically performed by municipal utilities). If your organization does not practice fund accounting, you need only indicate such on the [Installation Record](#); no other setup is required.

Fund Accounting Overview

Municipal utilities, and not-for-profit organizations in general, often use a form of accounting different from that used by for-profit corporations. Municipal utilities typically practice fund accounting, whereas corporations practice corporate accounting.

Regulations or other restrictions may require a municipal utility to account for the finances of each of its departments as a separate entity. If a municipal utility provides both water and wastewater service, a municipal utility may need to track the receivables, revenue, and liabilities for water service separately from those of wastewater. In contrast, a corporation is free to co-mingle the moneys of the two services.

To track the services separately, the municipal utility sets up a fund for each department. A fund is an accounting entity with its own self-balancing set of accounts. Each fund has its own "sub general ledger" with its own chart of accounts, and within each fund, its debits equal its credits at all times. This allows the utility to report on the financial state of each fund independently.

In addition to having a fund for each department, there is also a general fund, which is used to handle inter-fund transfers as well as shared accounts.

Fund Accounting Example

Consider a municipal utility which provides water and wastewater service. The utility has two departments: water and wastewater. Each department must track their finances separately therefore a fund is setup for each department:

- Water (fund 01).
- Wastewater (fund 02).

In addition, with fund accounting, there is always a general fund (fund 99).

Assume the following bill is generated.

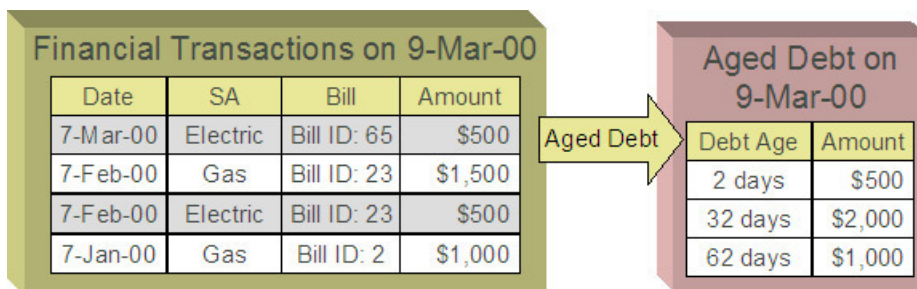

The bill would produce the following GL entries:

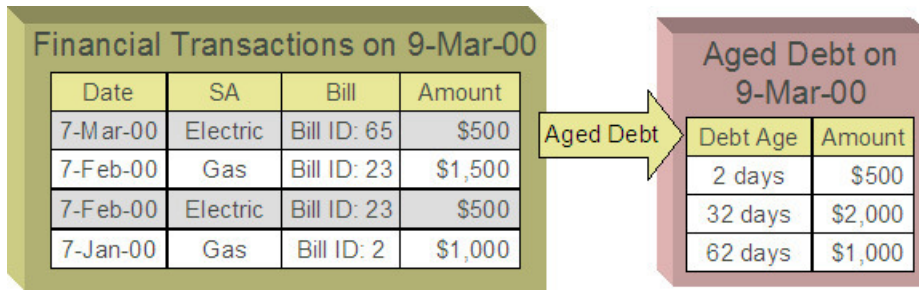

For each fund, the GL details of the bill will include a debit to the accounts receivable (A/R) account and credits to the revenue and taxes payable accounts. In organizational terms, each department is owed a portion of the overall bill by the customer, part of which is sales by the department and part of which is owed to the taxing authorities by the department. Each fund is balanced.

Note that the accounting could be identical under corporate accounting if each service is its own division with its own chart of accounts.

The following diagram illustrates the initial GL accounting that would occur when the payment arrives:

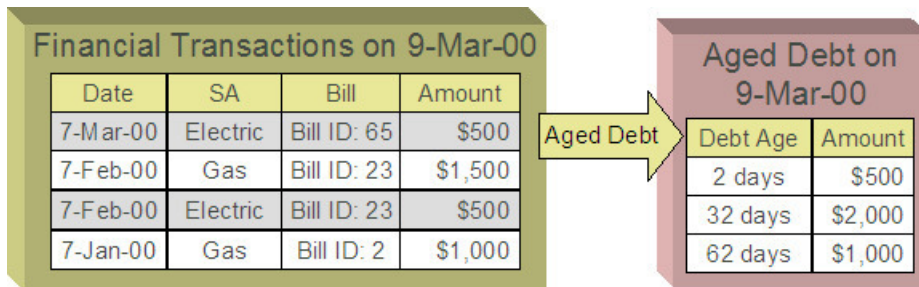

The utility's general cash account is debited, and the departmental funds' A/R accounts are credited. In other words, the cash is held by the utility as a whole but the receivables are reduced for the individual departments.

If the accounting were left in this state, the fund accounting principal - that each fund represents an independent entity with a self-balancing chart of accounts - would be violated. This violation is caused due to the fact that cash is recorded on the general fund, not the departmental funds, causing the general fund to have an excess debit and the departmental funds to have an excess credit.

From an organizational viewpoint, to make each department whole, the departments need to note what portion of the cash they own, and correspondingly, the utility needs to note what portion of the cash is owed to each department. The following diagram illustrates this point.

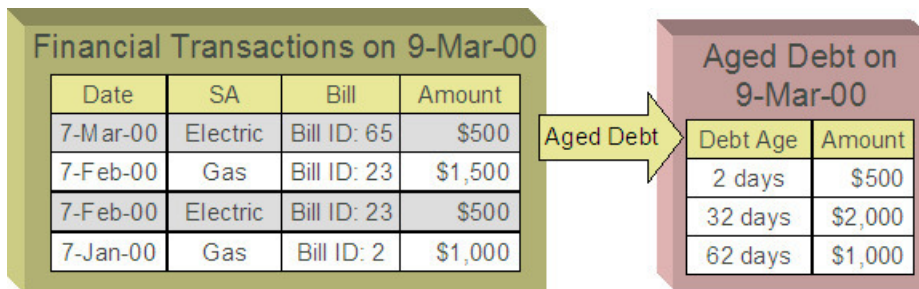

To maintain a balance of debits and credits within each fund, the departmental funds have an "equity in pooled cash" (EPC) account and the general fund has a liability account for each departmental fund. In addition to debiting the general fund's cash account and crediting the departmental funds' A/R accounts, the departmental funds' EPC accounts are debited and the general funds liability accounts are credited.

And so, with the additional GL entries, all funds have matching debits and credits.

An Example Of A Bill Segment That References Multiple Funds

Consider a municipal utility that primarily supplies water service but is also responsible for maintaining the city's fire hydrants. The costs for fire hydrant maintenance are borne by the water customers and make up just a small portion of the overall bill. These costs are simply added to the water bill as a line item. The utility has two departments:

- Water service (fund 01)
- Hydrant maintenance (fund 39).

In addition, there is a general fund (fund 99).

Assume the following bill is generated for water and hydrant services.

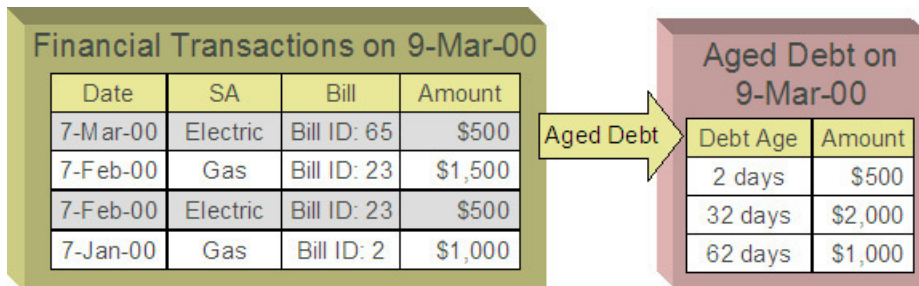

The following diagram illustrates the initial GL entries for the bill:

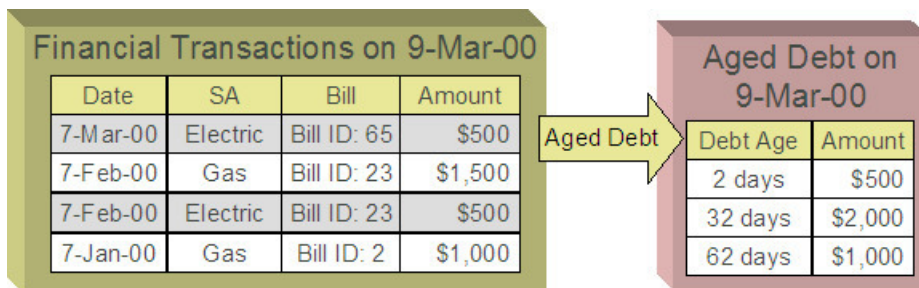

In accounting for the bill, the water fund's A/R is debited, the water and hydrant funds' revenue accounts are credited, and the water's taxes payable account is credited.

If left at this, the funds would be out of balance; the water fund would have an overall excess debit and the hydrant fund would have an equal excess credit. In organizational terms, the hydrant fund has recorded sales but that amount is recorded as being owed to the water department.

To balance each department, the water department accepts the responsibility for collecting the hydrant charges from the customer but immediately remunerates the charges to the hydrant fund.

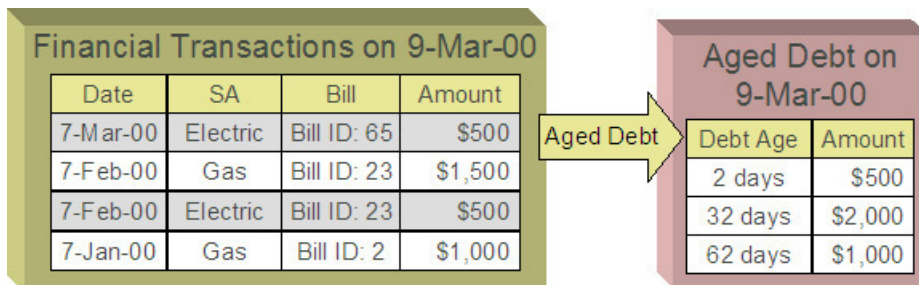

This transfer is done using the general fund. The water fund's EPC account is credited and the liability to water is debited with the amount of the hydrant revenue. Also, the hydrant fund's EPC account is debited and the general fund's liability to

hydrant account is credited by the hydrant revenue. In effect, the water department owes the hydrant charges to the general fund, and the general fund owes the hydrant charges to the hydrant fund.

The following diagram illustrates the initial GL accounting that would occur when the payment arrives:

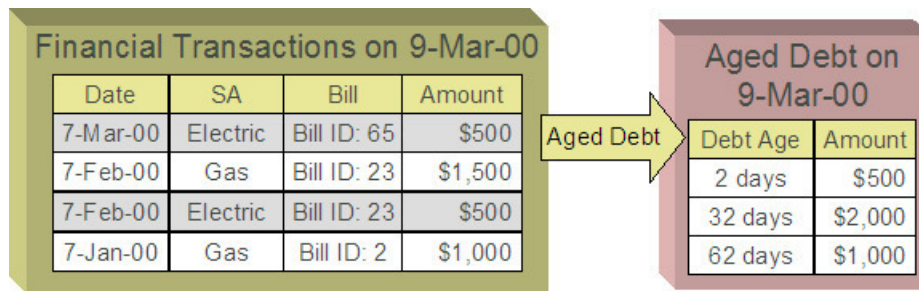

When the payment arrives, the cash is debited to the general fund's cash account, and the water fund's A/R is relieved. Again, the funds would be unbalanced if left in this condition; the water fund would have an excess of credits and the general fund would have an excess of debits.

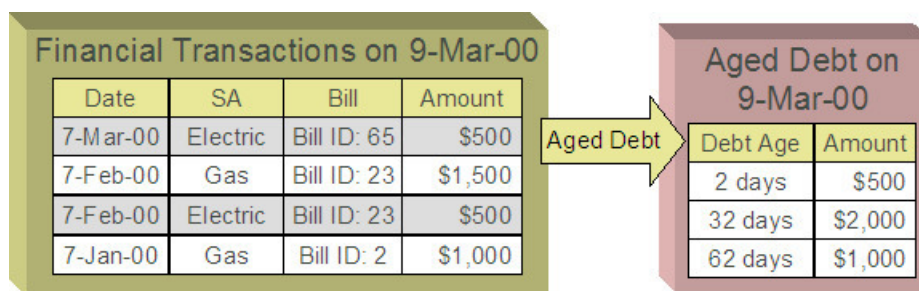

To maintain each fund's balance of debits and credits, the general fund's liability to the water fund is credited by the amount of the department's share of the cash, and the water fund's EPC is debited. Note that the payment has no effect on hydrant fund's EPC and the general fund's liability to the hydrant fund. The hydrant department "received" its money from the water department when the bill was created.

And so, all funds have matching debits and credits.

Accounting Method Is Defined On The Installation Options

You must turn on a switch on the [Installation Record](#) to enable fund accounting.

Fund Controls Fund-Balancing Entries

There are two levels of debit and credit balancing in fund accounting. There is the balancing required by double entry accounting: the total debits in the entire GL must equal the total credits. This is required regardless of whether fund or corporate accounting is used. The distribution codes for these entries come from varying sources, depending on the type of financial event.

FASTPATH:

Refer to [The Source Of GL Accounts On Financial Transactions](#) for information on the sources of the distribution codes.

The second level of balancing is specific to fund accounting. Within each fund-not just across the GL-the total debits must equal the total credits. The original distribution code from the financial event has a fund specified. For example, a bill would

cause a debit to a fund's A/R distribution code, and included in that A/R distribution code is the fund. It is the definition of the fund that specifies whether fund-balancing entries are required and provides the distribution codes for these entries.

For a departmental fund, the fund-balancing debit and credit would be specified. When a debit is applied to a departmental fund's GL account, an additional account (typically the general fund's liability to the departmental fund) is debited and an account (typically the departmental fund's EPC) is credited. When a credit is applied to a departmental fund's account, an additional account (typically the general fund's liability to the departmental fund) is credited and an account (typically the department's EPC) is debited.

For the general fund, no fund-balancing debits and credits are specified.

Building Fund-Balancing GL Details

Building the GL details for a financial event is a two-step process.

- First, the system generates the regular GL details for a financial transaction (FT). This is done regardless of whether corporate or fund accounting is used.
- Second, if fund accounting is activated (by turning on a switch on the [Installation Record](#)), the system analyzes the distribution code on each GL detail associated with the FT. If a **fund** is specified on a distribution code, the system checks the definition of the fund. If fund-balancing entries are specified on the fund, two additional GL entries are added to the FT:
- An offsetting entry to the Equity in Pooled Cash account is created for the departmental fund (e.g., if the FT is debiting a given fund, an offsetting credit is created in the funds EPC account).
- Another entry to the departments Liability account is created for the general fund.

The result is a consolidated set of GL entries for the FT, incorporating the regular entries as well as the fund-balancing entries.

The topics in this section illustrate the generation of the GL details for the earlier examples.

FTs Whose GL Details All Reference The Same Fund Do Not Impact the General Fund or EPC Accounts

In [Fund Accounting Example](#), where the bill's bill segments reference a single fund, the system creates a fund-balancing GL entry for each GL entry applied to a departmental fund:

- A debit to a departmental GL account triggers a debit to the general fund's liability-to-departmental-fund account and a credit to the departmental fund's equity-in-pending-cash account.
- A credit to a departmental GL account triggers a credit to the general fund's liability-to-departmental-fund account and a debit to the departmental fund's equity-in-cash account.

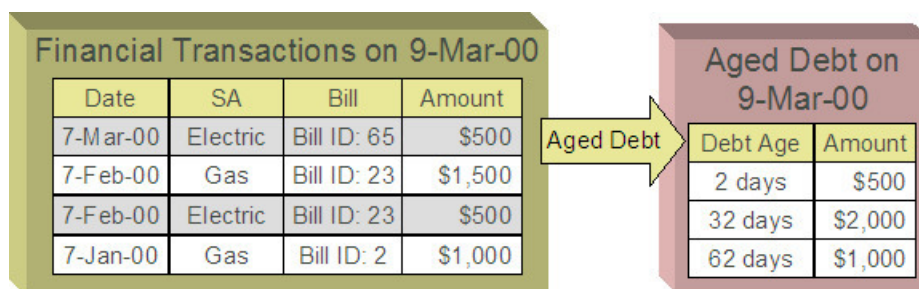

The net effect on the individual equity-in-cash and general fund's liability accounts is zero because the debits and credits net to zero for each GL account. In other words, the yellow boxes net to zero and therefore fund accounting does not impact the bill segment's financial transactions. Refer to [Fund Accounting Example](#) for the resulting consolidated GL entries.

An FT Whose GL Details Reference Multiple Funds

In [An Example Of A Bill Segment That References Multiple Funds](#), where the bill's bill segments reference multiple funds (water and hydrant), the system also creates fund-balancing GL entries for the financial transaction:

- A debit to a departmental GL account triggers a debit to the general fund's liability-to-departmental-fund account and a credit to the departmental fund's equity-in-pending-cash account.
- A credit to a departmental GL account triggers a credit to the general fund's liability-to-departmental-fund account and a debit to the departmental fund's equity-in-cash account.

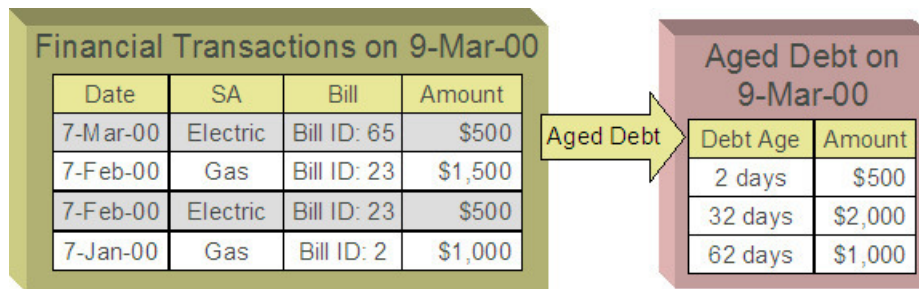

The net effect of the bill on the GL is that the water fund's EPC has a credit of \$0.80, the hydrant fund's EPC has a debit of \$0.80, the general fund's liability to the water fund has a debit of \$0.80, and the general fund's liability to the hydrant fund has a credit of \$0.80. Note that, overall, the general fund's overall liability to the departmental funds nets to zero. Refer to [An Example Of A Bill Segment That References Multiple Funds](#) for the resulting consolidated GL entries.

Setting Up The System To Enable Fund Accounting

The following section provides an overview of how to enable fund accounting.

Turn On Fund Accounting

On the [Installation Record](#), indicate that fund accounting is Practiced.

Defining Funds

A fund must be setup for each specific fund in your organization. Don't forget to also set up a fund for the general fund. Navigate using **Admin > Financial > Fund.**

Description of Page

Enter a **Fund** and a **Description** to identify the fund.

If this fund is used to balance other funds or to hold cash, indicate a **Fund Type** of General, otherwise indicate that it is Specific.

If the fund type is Specific, specify the **Equity Distribution Code** and **Liability Distribution Code**. These codes are used to balance financial transactions that span funds. The equity distribution code should belong to the same **Fund** as the one you are defining. The liability distribution code should belong to the general fund.

Distribution Codes Must Include Fund ID

All of your distribution codes must include their respective fund ID.

FASTPATH:

For more information, refer to [Setting Up Distribution Codes](#).

Update Your Funds With Their Respective Equity and Liability Distribution Codes

After distribution codes have been setup, you must update your funds to indicate the equity and liability accounts used to balance inter-fund financial transactions.

Bill Taxation Threshold

Some implementations only apply taxes if the accumulated tax amount at the bill level exceeds some specified threshold amount.

Taxation Threshold Examples

The following examples show how taxation thresholds affect a customer's bill. In the examples a tax rate of 5% and a threshold amount of \$21.30 is used.

Example 1 - Account With Taxes Under Threshold

This example shows the bill for an account where the accumulated tax amount is less than the threshold amount. Since the accumulated tax amount of \$10.50 is less than the threshold amount, taxes are not applicable and the account's bill should be adjusted to exclude the tax amount of \$10.50.

Bill Line	Amount
Standing Charge	10.00
2,000 units @ \$0.10	200.00
Tax @ 5% on \$210.00	10.50
Total	220.50
Adjusted Total	210.00

Example 2 - Account With Taxes Above Threshold

This example shows the bill for an account where the accumulated tax amount is greater than the threshold amount. Since the accumulated tax amount of \$27.92 is greater than the threshold amount, taxes are applicable and the account should be billed for the total amount.

Bill Line	Amount
Standing Charge	10.00
4,000 units @ \$0.10	400.00
Additional Charge	148.45
Tax @ 5% on \$558.45	27.92
Total	586.37

Example 3 - Account With Rounding Discrepancy

This example shows the resulting bill segment calc lines for an account with 3 service agreements. Here the accumulated tax amount at the bill level is \$21.29 with taxes calculated and rounded for each SA's bill segment. However, if the same taxes were calculated for each SA's bill segment and then accumulated and rounded at the bill level, the accumulated tax amount would be \$21.30 implying that taxes are applicable and the account should be billed for the tax amount of \$21.30 accounting for the discrepancy of \$0.01.

Bill Segment	Bill Line	Amount	Pre-rounding Amount
Bill segment for SA 1	964.70 units @ \$0.10	96.47	96.47000
	Tax @ 5% on \$96.70	4.82	4.82350
	Bill Segment Total	101.29	
Bill segment for SA 2	2222.90 units @ \$0.10	222.29	222.29000
	Tax @ 5% on \$222.29	11.11	11.11450
	Bill Segment Total	233.40	
Bill segment for SA 3	1072.40 units @ \$0.10	107.24	107.24000
	Tax @ 5% on \$107.24	5.36	5.36200
	Tax Discrepancy	0.01	
	Bill Segment Total	112.61	

NOTE:

Pre-rounding amount. Rate application captures two calculated amounts on the resulting bill segment calc lines. The first is the calculated amount rounded to two decimal places, and the second is a raw calculated amount with a five decimal precision. The base package algorithm that calculates taxation thresholds uses both amounts to account for any rounding discrepancy; however, only the raw calculated amount is used to compare against the taxation threshold.

Billing and Taxation Thresholds

The following sections describe how taxation threshold rules are implemented when a bill is produced.

Calculation of Taxation Thresholds

When taxation thresholds are applied at the account's bill level, it means that the system must calculate taxes for each of the account's service agreements, then sum these tax amounts and apply any applicable rounding rules. This accumulated tax amount is compared to a threshold amount and if the accumulated tax amount is less than the threshold amount, then taxes should not be applied to the customer's bill. To ensure the accumulated tax amount is accurate, all service agreements for an account whose tax amounts should be taken into consideration when comparing to the specified threshold should be billed together and the threshold comparison should take place after the bill segments have been generated. In addition, all bill segments whose tax amounts should be taken into consideration when comparing to the specified threshold must be for the same bill period.

NOTE:

Bill segments from different periods may not appear on the same bill. If a bill segment is canceled, all bill segments associated with that bill must be canceled and re-billed together. You cannot re-bill the bill segment on a bill for a different period.

An algorithm type is supplied with the base package that checks for taxation thresholds at bill completion time. The base bill completion algorithm type accumulates identified tax calc line amounts (accomplished using a bill segment calc line characteristic), and compares this to a specified threshold amount to determine if taxes apply for the account. If taxes do not apply, it sets a bill characteristic indicating this and regenerates the bill segment. Refer to the C1-CPBC-TAXT algorithm type for more information on how this type of algorithm operates.

NOTE:

Calculated adjustments are included in the evaluation against taxation thresholds. Adjustments that use a rate to calculate the adjustment amount may be included in the taxation threshold evaluation if their rate's components are set up to do so. The base algorithm C1-CPBC-TAXT looks at adjustments that are about to be swept onto the bill and, if applicable, includes them in the calculation.

The calculation rule(s) that calculate taxes make use of calculation rule eligibility criteria to ensure that taxes are only computed if the bill does not have the characteristic indicating that taxes are not applicable. Note that during the initial generation of each bill segment, the characteristic will not exist and taxes will be applied. This means that if you look at a bill before it is complete, taxes may not be accurately reflected.

Tax Amount Discrepancies

Since tax calculation rules are calculated and rounded at the bill segment level, it's possible that rounding discrepancies may occur if rounding of these tax amounts occurs at the bill level instead as illustrated in the example above. To account for this, the system uses both the two decimal precision and the five decimal precision calculated amounts that rate application captures on bill segment calc lines; however, only the raw calculated amount is used to compare against the taxation threshold. If there is a discrepancy in the tax amount (as shown in example 3 above), the system captures this amount as an entry in one of the bill segment's SQ collections prior to regenerating the bill segments. This is depicted in example 3 above where the tax discrepancy SQ resulted in an additional bill segment calc line on one of the bill segments for the rounding amount of 0.01. Note that a calculation rule is configured to bill for this discrepancy amount SQI.

NOTE:

Pre-rounding amount. Rate application captures two calculated amounts on the resulting bill segment calc lines. The first is the calculated amount rounded to two decimal places, and the second is a raw calculated amount with a five decimal precision. The base package algorithm that calculates taxation thresholds uses both amounts to account for any rounding discrepancy; however, only the raw calculated amount is used to compare against the taxation threshold.

Setting Up The System For Bill Taxation Thresholds

This section provides an overview of how to configure the system to calculate taxes at the account's bill level.

Installation Option

Select Freeze at Bill Completion as the bill segment freeze option. The system compares tax amounts calculated to a specified threshold amount and based on this determines if taxes should apply at bill completion time. If taxes should not be applied for the account, the system has to regenerate the bill segments as necessary.

Adjustment Types

Select Freeze at Bill Completion as the adjustment freeze option. The system compares tax amounts calculated to a specified threshold amount and based on this determines if taxes should apply at bill completion time. If taxes should not be applied for the account, the system has to regenerate the adjustments as necessary.

Bill Factors

Tax Threshold. Set up a separate bill factor for each distinct tax threshold amount.

Characteristic Type

Set up a characteristic type and value to identify the tax calculation rules and bill segment calculation lines that the system will use to compare to the specified threshold amount. Specify this characteristic type and value as parameters to the algorithms that apply the taxation threshold. This characteristic type and value must also be specified on each of your tax calculation rules that should be included in the threshold comparison.

Set up a characteristic type and value to use for the bill characteristic that indicates when bill level taxes apply. Specify this characteristic type and value as parameters to the algorithms that apply the taxation threshold.

Service Quantity Identifiers

Optional service quantity identifiers may be configured to capture the following:

- **Tax Amount.** The system compares the accumulated bill's tax amount to the specified threshold amount to determine if taxes are applicable. If taxes should not be applied for the account, the system regenerates the bill segments as necessary. If you wish to capture the tax amount computed for informational purposes, then a tax amount SQI should be set up and specified as a parameter on the algorithms that apply the taxation threshold.

- **Tax Discrepancy Amount.** Since tax calculation rules are calculated and rounded at the bill segment level, it's possible that rounding discrepancies may occur if rounding of these tax amounts should take place at the bill level. If you wish to account for these rounding discrepancies, then a tax discrepancy amount SQI should be set up and specified as a parameter on the algorithms that apply the taxation threshold. Your rates should also be configured to cater for this rounding discrepancy. The system adds an entry for the discrepancy amount to one of the bill segment's SQ collections prior to regenerating the bill segments.

Algorithms

Apply Taxation Threshold. Define an algorithm for each distinct tax threshold amount. Plug the algorithm(s) in on the appropriate customer class for the Pre Bill Completion system event. Refer to the C1-CPBC-TAXT algorithm type for more information about the base package algorithm.

Adjustment Generation - Apply Rate. Define an algorithm for each rate to be used by calculated adjustment types that are to be included in the tax threshold evaluation. Plug the algorithm(s) in on the appropriate adjustment type for the Generate Adjustment system event. Refer to the ADJG-RT algorithm type for more information about the base package algorithm.

Calculation Rules For Bill Taxation Thresholds

Your calculation rules that bill for taxes require the following:

- A characteristic that identifies them as calculation rules to include in taxation threshold comparisons
- Calculation rule eligibility criteria to ensure that taxes are not calculated if the taxation threshold algorithm dictates this

Only one eligibility group on the calculation rule is required. It would look as follows:

Group No.	Group Description	If Group is True	If Group is False
1	Tax applies if total accumulated tax amount at the account's bill level exceeds the threshold amount	Apply calculation rule	Skip calculation rule

The following criteria will be required for this group:

Seq	Field to Compare	Comparison Method	If True	If False	If Insufficient Data
10	Bill characteristic: Characteristic type = Tax Not Applicable indicator	= YES	Group is false	Check next condition	Group is true
20	Characteristic Collection: Characteristic type = Tax Not Applicable	= YES	Group is false	Group is true	Group is true

NOTE:

The second criterion included above is used to evaluate the applicability of the tax on calculated adjustments. Since these adjustments are not yet linked to the bill, the first criterion cannot be used to evaluate the applicability of the tax threshold. The pre-bill completion algorithm C1-CPBC-TAXT instead adds the characteristic to the characteristic

collection for use by the rate application when evaluating the adjustment's rate's eligibility rules. Refer to the ADJG-RT algorithm type for more information about the base package algorithm.

FASTPATH:

For more information, refer to [Designing Calculation Groups and Rules](#).

An additional calculation rule is required to bill for the tax rounding discrepancy as follows

- Calculation Rule type = Service Quantity
- UOM/TOU/SQI = the identifier of the service quantity containing the tax discrepancy amount
- Value Type = Unit Rate
- Value Source = Value
- Value = 1

Other Financial Transaction Topics

Various topics about financial transactions are discussed in this section.

The Source Of GL Accounts On Financial Transactions

The following table lists the major financial events, their standard accounting, and the source of distribution codes used to derive the GL accounts sent to your general ledger.

Financial event	GL Accounting	Source Of Distribution Code
Create a normal utility bill segment. Bill Segment FT Algorithm is Payoff Amt = Bill Amt / Current Amt = Amt Due	Debit: A/R	SA Type
	Credit: Revenue / Taxes Payable	Calculation Rule
Create a bill for company usage. Bill Segment FT Algorithm is Payoff Amt = 0 / Current Amt = 0	Debit: Company Usage Expense	SA Type
	Credit: Revenue / Taxes Payable	Calculation Rule
Create a bill for charity. Bill Segment FT Algorithm is Payoff Amt=0 / Current Amt = Bill Amt	N/A - charity bills have no effect in the GL	N/A
	N/A	N/A
Create a payment segment for a normal utility service agreement	Debit: Cash	Bank Account on the Tender Source of the Tender Control for the Payment Segment's Tender.
	Credit: A/R	SA Type
Create a payment segment for a charitable contribution service agreement	Debit: Cash	Bank Account on the Tender Source of the Tender Control for the Payment Segment's Tender.

	Credit: Charity Payable	SA Type
Create a payment segment for auto-pay at bill completion time	Debit: Cash	Bank Account on the Tender Source on the Auto-pay Route Type of the Auto-pay Source.
	Credit: A/R	SA Type
Canceling a payment	Debit: A/R	SA Type
	Credit: Cash	Bank Account specified by the user on the cancel tender page. Note that this defaults to the original tender's bank account.
Create an adjustment to levy a charge	Debit: A/R	SA Type
	Credit: Revenue	Adjustment Type

The bottom line is as follows:

- If a bill segment has a financial effect, the distribution code to debit comes from the distribution code on the SA Type, the distribution code to credit comes from the calculation rule(s) used to calculate the bill segment.
- Payment segments always have a financial effect; the distribution code to debit comes from the bank account on the tender source of the tender control of the tender, the distribution code to credit comes from the SA type.
- If an adjustment has a financial effect, the distribution code to debit and credit comes from the SA type and adjustment type. If the adjustment is positive (i.e., the customer owes your organization more money), the distribution code to debit comes from the SA type; the distribution code to credit comes from the adjustment type. Vice versa if the adjustment is negative.

Defining Customer Options

The definition of a customer is someone (or something) with financial obligations with your company. These obligations ensue because the customer has agreed to purchase goods or services at an agreed price.

You may be surprised to learn that there is no "customer" record in the system. Rather, the system subdivides customer information into the following records:

- **Person.** The person record holds demographic information about your customers and every other individual or business with which your company has contact. For example, in addition to customers, person records also exist for landlords, contractors, accountants at corporate customers, guarantors of customers, energy distributors, collection agencies, etc.
- **Account.** Accounts are the entities for which bills are produced and therefore you must create at least one account for every person who has financial obligations with your company. The account record contains information that controls when the bills are created and how the bills are formatted.
- **Service Agreement.** Think of a service agreement as a contract between your company and the customer. The service agreement contains the terms and conditions controlling how the bill details are created. Every account will have at least one service agreement (otherwise, nothing will appear on the account's bills).

Before you can define persons, accounts, and service agreements, you must set up the control tables defined in this section.

FASTPATH:

For more information about how persons, accounts and premises are used by your customer service reps, refer to [Understanding The "V"](#).

NOTE:

The tables in this section are only some of many tables that must be set up before you can bill your customers for the service(s) they consume. In this section, we limit the discussion to those tables that control basic demographic

and financial information. In later sections, we describe the tables that control other billing-related functions like bill creation algorithms, meter reading and rates. It is only after all of these tables are set up that you will be able to generate bills and record payments.

Customer Overview

This section describes how the person, account, and service agreement records are used to record your customers' demographic and billing options.

A Simple Example Of Two Customers

The following picture illustrates two customers: Joe Smith and Pam Jones. Joe is the "main customer" on the first account. Pam is the "main customer" on the second account. Pam is also the "third party guarantor" on Joe's account.

A Simple Example Of Two Customers

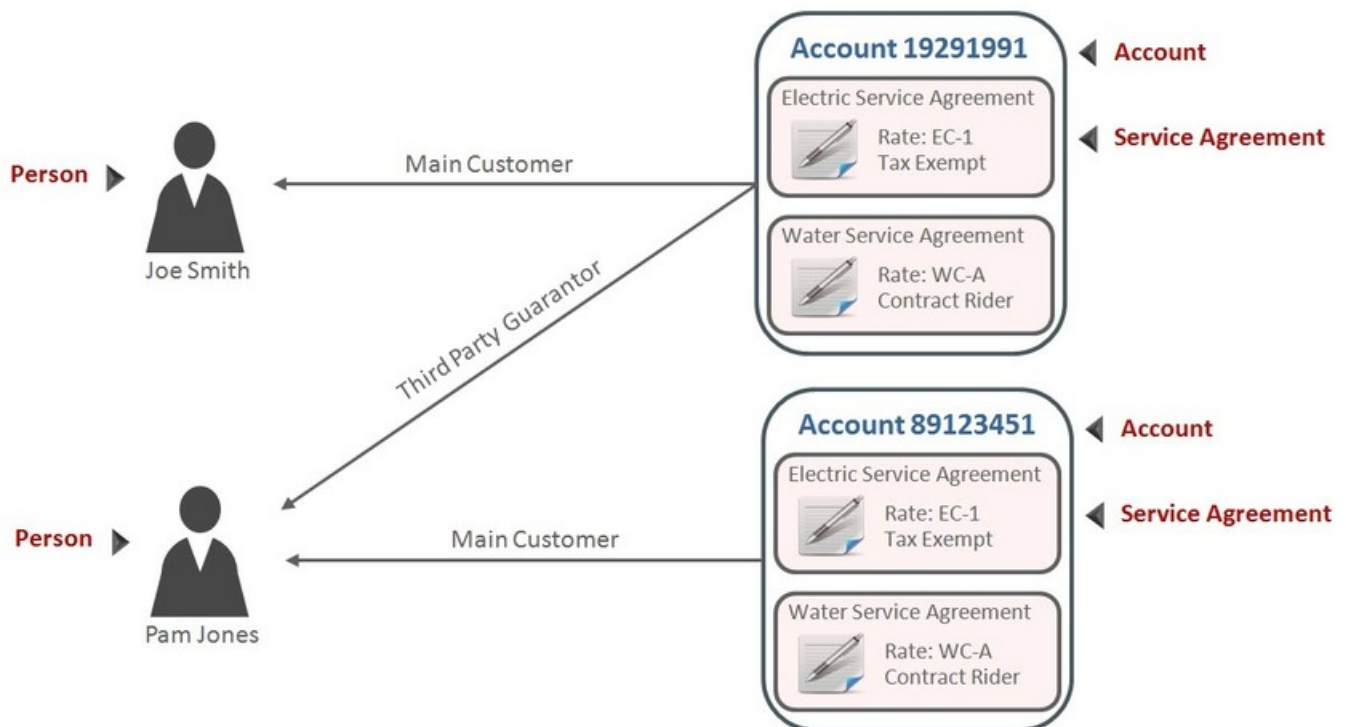

Persons

Person records hold demographic information about the individuals and businesses with whom your organization communicates. Demographic information includes phone number(s), names and aliases, identification numbers, life support equipment needs, employment information, etc.

In the above example, 2 person records would be needed; one for Pam Jones and another for Joe Smith.

A new person is added when you first have contact with a person; the person does not have to be a customer before it is added. So, for example, if your company is starting a new marketing campaign, you can add information about potential customers the moment they are identified.

NOTE:

Businesses are persons too. In addition to humans, you use person records to maintain basic information about the businesses with which your organization has contact.

FASTPATH:

For a description of the control tables that must be set up before you can define a person, refer to [Setting Up Person Options](#).

Accounts

An account is analogous to an account at a bank:

- A person or business with no financial dealings with a bank will have no account (but the bank may choose to keep demographic information about the person as part of their marketing efforts). The exact analogy exists in this system.
- Individuals with financial dealings with a bank will have one or more accounts. The number of accounts is up to the customer. The exact analogy exists in this system.

A simple way to determine the number of accounts a customer will have is to ask "how many bills do they want each period?" because a customer receives one bill for each account. For example:

- A residential customer who also owns a small business may choose to receive two bills each month; one for the residence, the other for the business. This way, the charges for their business would be segregated from their personal charges. This customer would have two accounts.
- A conglomerate that owns several factories may want their transportation gas charges to appear on a single bill rather than have a separate bill for each factory. This customer would have a single account.

Account ID Is Non-Intelligent

The unique number of an account is referred to as the "account ID". You are probably very comfortable with this concept. You may, however, have difficulty dealing with the fact that the account id in this system has no intelligence built into it (e.g., many systems include the bill cycle and geographic location in the account id). In this system, the account ID is a random, system-assigned value.

Because the account ID contains no meaning, it can remain with a customer for life, regardless of where they live, when they are billed, the type of service they receive, etc. This is important because it means that all of the financial history linked to the account remains with the customer for life.

NOTE:

The non-intelligence of the account ID is also important from the perspective of the parallel processing that takes place when the system creates bills. Because the collection of accounts to be billed in any given bill cycle will be randomly

distributed through the number spectrum, the system can distribute account number ranges to parallel threads and each thread will process roughly the same number of accounts.

Account / Person Cross-Reference

A person may be linked to zero or more accounts. A person won't be linked to an account when they have no financial relationship with your organization. A person will be linked to multiple accounts when they have financial relationships with more than one account.

An account must reference at least one person (i.e., the main customer), but may reference an unlimited number of individuals. Multiple persons are linked to an account when several parties have some type of financial relationship with the account (e.g., third party guarantors, account contact, bill copy recipients, etc.).

When Is An Account Created?

A person can exist without an account until such time as the person formally requests the commencement of service. The moment the customer requests service, an account must be created (and the person must be linked to the account).

When Is An Account Expired?

Accounts never expire. Once a customer has an account, the account remains in the system forever. Linked to the account are service agreements that define the price and conditions of a service supplied to the customer. When an account has active service agreements, the system produces bills for it. If the account doesn't have active service agreements, the system will not produce a bill for it. You can think of an account without active service agreements as being "dormant", waiting for the day when the customer again starts service. If the customer never restarts, the account (along with its financial history) remains dormant forever.

Service Agreements

A service agreement is a contract (either formal or implied) between your organization and a customer. Every service agreement contains the price and conditions of a service supplied to a customer.

A service agreement is linked to an account. There is no limit to the number of service agreements that may be linked to an account.

When Is A Service Agreement Created?

A service agreement is created when the customer requests service (not when service commences). Typically, service agreements are created in the pending state and field activities are generated to connect service. When the field activities are complete, the service agreement becomes active and the billing process starts generating bill segments for the service agreement.

FASTPATH:

For more information about starting service, refer to [The Big Picture Of Starting Service](#). For more information about bill segments, refer to [Bill Details](#).

Financial Transactions Are Linked To Service Agreements

FASTPATH:

For more information about how financial transactions are linked to service agreements, refer to [The Financial Big Picture](#).

When Is A Service Agreement Expired?

A service agreement is expired when the customer requests service be stopped. At that time, the service agreement is transitioned to the pending stop state and field activities are generated to stop service (these activities might involve simply reading the meter or they could involve disconnecting or removing the meter). When the field activities are complete, the system transitions the service agreement to the stopped state and the billing process generates a final bill for the service agreement. When the customer pays the final bill, the system transitions the service agreement to the closed state

FASTPATH:

For more information about stopping service, refer to [The Big Picture Of Stopping Service](#).

Setting Up Person Options

This section describes tables that must be set up before you can define persons.

Person Identifiers

This section describes the setup and use of person identifiers.

Setting Up Person Identifier Types

When you set up a person, you may define the various types of identification associated with the person, e.g., their driver's license number, their tax identity, etc. Every piece of identification associated with a person has an identification type.

NOTE:

How are person identifiers used? The reason why identifiers are defined on a person is so that users can look for a customer using one of their person identifiers (see [Control Central - Search Facilities](#) for more information). In addition, person identifiers help prevent duplicate persons from being added to the database. The base product provides an algorithm type C1-PERSONVAL that can issue a warning or error to a user before they add a new person or update an existing person when another person exists with the same identifier. This is a BO validation algorithm on the person MO's identifying BO.

Person identifier types are optional. An [installation option](#) controls whether at least one identifier type is required on every person.

You can access the portal from **Admin > Customer > Person Identifier Type**.

This is a standard [All-In-One Portal](#).

Refer to the embedded help text for more information.

Understanding Person Identifiers

Person Identifiers have many uses in the system. Their main use is to help uniquely identify persons and businesses. Another use is to store other non-uniquely identifying attributes about a person that are better suited to identifiers than they are to person contacts or characteristic. An example is a customer provided password or PIN that is verified before account details are provided.

The installation record defines if and when at least one person identifier is required on persons and businesses. Identifiers can be required when the record is created (always), when linked to an account, when linked to an account as financially responsible, or when linked to an account as the main customer. The system enforces these rules when a person is added or maintained or when persons linked to accounts are maintained. The installation record also defines the default identifier types for person and business records.

When a person identifier is required, the person identifier collection requires that one and only one record is marked as the primary identifier. Identifier types indicate if they can serve as the primary ID and also if they are validated for duplicates. Typically only ID types that should have unique values are configured to validate or duplicates.

Identifier types can be setup to indicate a format such as prefix, delimiter, and value. For example, an identifier for passport can indicate that the country code is the prefix followed by a dash then the passport number. A validation algorithm is provided to ensure all entered data conforms to this format.

Most organizations prefer that the primary identifier is uniquely identifying or a high-quality ID. However, it is not always possible to obtain such an identifier from all customers. The following are two common ways this is handled:

- An identifier type, such as a PIN, is configured and allowed to be the primary identifier, even if it considered a lesser quality or non-uniquely identifying identifier. These types should not be configured to validate for duplicates as their values are not uniquely identifying.
- The desired identifier is used, but a value such as all zeros or all nines is entered, indicating that the customer did not provide the value. In this scenario, the system cannot distinguish between an entry with a quality value and an entry with all zeros since the same ID type is used.

NOTE: Note: the customer service request-based start service process has configuration that allows your organization to differentiate between identifier types that can be primary and those that represent a high-quality ID. Refer to [Verifying Identity, Checking Credit and Requiring Deposits](#) for more information on how the start service process uses person identifiers.

Setting Up Contact Routings

Base values for Contact Routing are supplied. You can add your specific contact routings using the **Contact Routing** extendable lookup. You can add more contact routings, but the ones supplied with the system cannot be edited or deleted.

NOTE: Person contacts that reference the CSS routing type cannot be added by a user, and are not permitted to be edited or deleted. As well, records with this contact routing are only visible in the Person - Main page and are not displayed in the Account Portal or other places in the system.

Refer to [Defining Extendable Lookups](#) and for more information on lookups.

If your implementation is using notification preferences, you may need to set up delivery types before setting up contact routings. Refer to [Setting Up Delivery Types](#) for more information.

Setting Up Person Contact Status

Person contacts can have a status; for example, the status of an email contact could be pending, verified, or bounced. The product is delivered with statuses that are used in conjunction with opt-in functionality. When new person contacts are added, the initial status can be defaulted from the person contact type. See [The Person Contact Status Can Be Controlled By A Process](#), [System Person Contact Statuses](#) and [Opt-in Process](#) sections for more information.

Your implementation may choose to introduce other logic to update the status. See [The Person Contact Status Can Be Controlled By A Process](#) for more information. You can add your specific person contact statuses by updating the value for the CND_VERIF_STATUS_FLG lookup field.

When new person contacts are added, the initial status can be defaulted from the person contact type. Refer to the Person Contact zone's help text for more information.

Setting Up Person Contact Type Algorithms

Format Validation

Person contact information can be subject to format validation such as ensuring a phone number is entered in a particular format.

The base product provides the algorithms C1-VALEMFMT (Validate Email Format), C1-VALPHFMT (Validate Phone Format), and C1-VALANYFMT (Any Format Valid), which your implementation may use (and if so, no further configuration is needed). If your implementation's business rules require additional format validation algorithms, you may introduce your own.

NOTE: These algorithms confirm that a specific format exists and do not reformat or apply formatting to the corresponding field; for example, the *C1-VALEMFMT* (Validate Email Format) algorithm confirms that the email address contains required features (such as an @ symbol and domain). It will not, however, insert these features.

If your implementation's business rules require additional format validation algorithms, you may introduce your own.

Setting Up Person Contact Types

Person contact types define the format for entering person contacts and information about the person contact.

To set up contact types, select **Admin > Customer > Person Contact Type > Add**.

This is a standard [All-In-One Portal](#).

Refer to the embedded help text for more information.

Choosing to Use Person Contact or Person Phone

Person contact is an updated and more configurable alternative to person phone and email. In this release, a feature is introduced that some system processes use to determine if person contact or person phone and email is being used. Person phone and email are referred to as legacy behavior. Legacy behavior is enabled when the Legacy Person Phone and Email **Option Type** on the Customer Information Options is set to Y. When set to N or not set legacy behavior is not enabled.

If your implementation uses functionality that has not been updated to use the feature, such as campaigns and order, you may wish to enable legacy behavior and continue to use person phone and email. It is important to note that Person Contacts are required for notifications.

The following system processes have been updated to alter functionality based on whether legacy behavior is enabled or not.

System Process	Behavior When Feature is Not Set	Behavior When Feature is Set
Person	The Person Phone Grid and the Person Email field are not shown	The Person Phone Grid and the Person Email field are shown. Person Contact is always shown.
Person	The functionality to maintain person contacts from person phone is not triggered even when a person contact type is associated with a phone type.	The functionality to maintain person contacts from person phone is enabled.
Account/ Person	When an email or fax bill or quote route type is chosen, then information displayed is related to person contacts.	When an email or fax bill or quote route type is chosen, then information displayed is related to person phone or email.
Start/Stop	The Person Contact collection is shown and can be edited.	The Person Phone collection and Person Email are shown and can be edited.
Case	The Preferred Contact Methods associated with legacy person phone and email are not shown.	The Preferred Contact Methods associated with legacy person phone and email are available. Person Contact is always available.
Customer Contact	The Preferred Contact Methods associated with legacy person phone and email are not shown.	The Preferred Contact Methods associated with legacy person phone and email are available. Person Contact is always available.

Person Contact Status Can Be Controlled By A Process

Overview

Person contact types can be configured to allow a status. For some person contact types, your implementation may want to control the status through a process instead of allowing the status to be set manually. An example of this is using person contact status to capture opting in for receiving text messages, which is required in some jurisdictions. Opt-in is seeking permission from a customer to use a person contact for a purpose such as sending a customer text messages.

Opt-in works in conjunction with the functionality to enable opt-in for a delivery type. Each can function independently, but together they offer a complete solution. Since they can function apart from each other, each is described independently. See [Enabling Opt-in for a Delivery Type](#) for more detail on this logic.

To control a person contact status with a process, the person contact type must first be configured to allow status. The person contact type must then be set up in the opt-in section of the [Notification Preferencesmaster configuration](#). By defining a Status Script, the person contact status can only be changed by the logic contained in or initiated from the script. The product is delivered with a script that creates an opt-in service task. This is designed specifically to support opting in to receiving notifications via text messages (SMS).

Opt-In Process

To use the delivered functionality, configure a new service task type for opt-in. This task type should reference the Notification Preference Opt-In Task Type Business Object (C1-NotifPrefOptInTaskType). The product is delivered with a service task business object The service task is responsible for initiating an opt-in request, updating the person contact status, and logging the user response. An inbound web service receives responses and transitions the service task. These components are designed to integrate with Notification Center. When a customer is sent an opt-in request, they are asked to confirm. The content of the message explains the commands to the user. Examples are CONFIRM or STOP. Notification Center is configured to interpret the specific commands and map them to those expected by the inbound service, which transitions the service task appropriately.

Aside from the initial opt-in request, users can stop or unsubscribe from notifications at any time. The delivered solution supports two modes for this functionality: unsubscribing from all notifications for a particular person contact or unsubscribing from a specific notification type for a particular person contact. This is controlled through configuration, and relies on the external system such as Notification Center to determine the notification type.

The [Notification Preferencesmaster configuration](#) help text contains detailed information about the configuration required to control person contact status and setting up opt-in processes.

It is important to note that while the delivered process to control person contact status was designed to work in conjunction with the opt-in process, your implementation can design a custom process that can create a service task or do something

completely different. Also, it can be independent of opt-in and notifications. For example, the process can be used to verify that an email address is valid by sending the customer a verification request.

There is another concept, which is enabling opt-in for a delivery type. This is closely related to the functionality described here, but has different implications in the system. See [Enabling Opt-in for a Delivery Type](#) for more information.

There is a limitation worth noting. A person contact type may be set up to allow multiple delivery types, however the delivered solution only allows a single delivery type to be associated with the process used to automate person contact status. Without this limitation, different processes would be responsible for updating a single person contact status and those updates could be conflicting.

The System Person Contact Statuses

The opt-in solution delivered with the product utilizes the three delivered status values. They are: **Pending**, **Approved**, and **Rejected**. Your implementation can add your own person contact statuses, but they will not work with the solution delivered with the product. See [Setting Up Person Contact Status](#).

How the System Automates Person Contact Status

There are many ways that the process that controls person contact status can be invoked. For all of these, the person contact type must be set up in the **Notification Preferences** master configuration to have its status controlled by a process and, unless noted otherwise, the person contact is not already *Approved*.

- The primary way to initiate the process to control person contact status is when a person contact is used to add a contact preference and the contact preference's delivery type matches the delivery type associated with the person contact type as defined in the Notification Preferences master configuration. This method relies on enabling opt-in for a delivery type. This is how the two processes work with each other. See [Enabling Opt-in for a Delivery Type](#) for more information. An example of this scenario is that a person contact exists and is of a type that can receive text messages, such as "Mobile Phone". Until the person contact is used on a contact preference to receive a notification, there is no reason to initiate an opt-in process.
- This process can be automatically initiated by configuring a person contact to default to an initial status of *Pending*. When a person contact is added, the process is initiated. An example of this scenario is an email person contact initiating a process to verify the email address as soon as it is added to the system.
- When the value of an approved person contact is changed, the process is reinitiated. For example, even though the approval is attached to a specific person contact in the system, which has a unique ID, externally the approval was for a particular phone number or email address. When the person contact value (i.e. the phone number or email address) is changed, the prior approval is no longer valid. The person contact status is changed to *Pending*.

A user can manually initiate the process. A button is provided on the Person Contact row on Person - Main. The button can be used to reinitiate the process when the customer does not have the request and needs it resent. It can also be used to manually initiate the process upfront - before the person contact is used on a contact preference.

Maintaining Person Contact via Person Phone

Person phone is referenced extensively throughout the system. All system processes have been updated to determine if phone data and email data is being maintained on person contacts or being maintained on person phone and email. See [Choosing to Use Person Contact or Person Phone](#) for more information.

To keep person contacts records in sync with a person phone, you should consider which phone types should be stored as contacts, configure the person contact type corresponding to each phone type, and update the person contact type to reference the corresponding phone type. Many phone types may be associated with a single person contact type, but a single phone type may only be associated with one person contact type.

The base product provides a batch process C1-INPUS (Create Person Contact from Person Phone/Email) that creates a person contact for all person phone records whose phone type is associated with a person contact type. The batch process can also create person contact records for the email address on the person. You would run this process to create person

contact records if you already have phone or email data for persons, and you wanted to start leveraging person contact as the repository for phone and email information. See the batch process description for more information.

NOTE:

There is a primary switch on person contact records; one person contact for each unique contact routing must be set as the primary contact. When the batch process creates person contacts from person phone data, the first person contact added for each unique contact routing is set as primary. This can be controlled to some extent by your implementation by associating phone types with person contact types sequentially and running the batch process multiple times. For example, you may prefer that a home phone be the primary over a cell phone if both exist. To ensure this happens, associate the home phone with a person contact type and run the batch process. Then associate the cell phone with a person contact type and run the batch process again. This will force all home phone records to be processed first. It is recommended that regardless of how many times the batch processes run, they are run back to back. This should be thought of as a conversion of data and should be treated as such.

When a phone type is associated with a person contact type the following occurs:

- When a phone record is added, a corresponding person contact is added if one does not already exist.
- When a phone record is updated, corresponding updates are made to the person contact.
- When a phone record is deleted, the system tries to delete the corresponding person contact. All business rules for person contacts are enforced. If the person contact is associated with a contact preference, the person contact cannot be deleted, and in turn the phone record cannot be deleted.
- Person contacts associated with phone types cannot be deleted directly. The delete function is disabled.
- Contact information on person contacts associated with phone types cannot be updated directly. The contact information and extension are disabled.
- Person contacts whose person contact type is associated with a phone type cannot be added from the account contact information zone in the account portal. These need to be added through person phone.

There is no direct association between a person phone record and person contact (i.e. there are no foreign keys on either record pointing to the other). The system uses the association between phone type and person contact type and the specific phone number in order to find the associated person contact.

Your implementation may decide to use person contacts to store phone data and not associate them with phone types. Functionality related to the system use of person phone will not be available such as updating a phone number through an order.

If your implementation associates phone types with person contact types and wishes to remove this association, it is best to remove all phone types from all person contact types.

WARNING: Making changes to the association of phone type to person contact type can have serious implications for your data. Changing the person contact type associated to a phone type will likely result in difficulty maintaining both person phone and person contact data.

Setting Up Statement Construct Options

This section describes tables that must be set up before a statement construct can be set up for a person to begin receiving financial statements.

FASTPATH:

For more information, refer to [The Big Picture of Complex Statements](#).

Setting Up Statement Route Types

Statement route types define the method used to route statements to persons. To define a statement route type, open **Admin** > **Billing** > **Statement Route Type**.

Description of Page

Enter a unique **Statement Route Type**, **Description** and **Statement Routing Method** for every statement route type.

NOTE:

The values for Statement Routing Method are customizable using the Lookup table. This field name is STM_RTG_METH_FLG.

The next two fields control how statements that are routed using this route type are printed (both in batch and online). Refer to [Technical Implementation Of Batch Statement Production](#) for more information about producing statements in batch. Refer to [Technical Implementation Of Online Statement Production](#) for more information about online statement production.

- Use **Batch Control** to define the process that creates the flat file that is passed to your statement printing software. If you use an **Extract Algorithm** to construct the downloaded information, you can use the STMDWLD process.
- Use **Extract Algorithm** to define the plug-in component that constructs the "flat file records" that contain the information to be merged onto statements routed using this route type. This algorithm is called when a user requests an online image of a statement on [Statement - Main](#) and it may also be called by the batch statement extraction process defined above.

Setting Up Account Options

This section describes tables that must be set up before an account can receive a bill.

Setting Up Account Management Groups

Users are informed that something requires their attention by entries that appear in To Do lists. For example, consider what happens when billing can't find a reading (and it's not allowed to estimate):

- The billing process creates a bill segment that is in error - meter read cannot be found.
- This error bill segment, in turn, triggers the creation of a To Do entry.
- The To Do entry is addressed to a role. A role is one or more users who can "action" the To Do entry.
- When a user views their To Do entries, they see all entries addressed to all roles of which they are part.

You can optionally use account management groups (AMG) to define the respective role to be assigned to To Do entries that are associated with an account and a given To Do type. For example, you can create an AMG called Credit Risks and assign this to accounts with suspect credit. Then, whenever an account-oriented To Do entry is created for such an account, it will be assigned a role based on the Credit Risks AMG. Refer to [Assigning A To Do Role](#) for more information..

NOTE:

Account management groups are optional. You need only set up account management groups (and link them to accounts) if you wish to address specific To Do entries associated with specific accounts to specific roles.

Account management groups are defined using **Admin > Customer > Account Management Group > Add**.

Description of Page

Enter an easily recognizable **Account Management Group** code and **Description** for each account management group. Use the grid to define the **To Do Role** to be assigned to entries of a given **To Do Type** that are associated with accounts that reference the **Account Management Group**.

NOTE:

Only To Do entries that are account-oriented take advantage of the roles defined for an account management group (because only accounts reference an account management group).

Setting Up Account Relationship Codes

When you link a person to an account, you must define in what way the person is related to the account by using an account relationship code. These codes are defined using **Admin > General > Account Relationship Type**.

Description of Page

Enter an easily recognizable **Relationship Type** and **Description** for each relationship type.

Setting Up Alert Types

Account based alerts that appear in control central have an **AlertType**. To define valid alert types, navigate to **Admin > Customer > Alert Type**.

Description of Page

Enter an easily recognizable **Alert Type Code** and **Description** for each alert type. Specify the **Alert Days** to indicate the amount of time that alerts of this type will be effective by default. Specify a value of zero to indicate that alerts of this type will be effective indefinitely by default.

Setting Up Bill Messages

There are various informational and warning messages that may appear on an account's bills. Each message is identified with a bill message code. To define a bill message, open **Admin > Billing > Bill Message > Add**.

Description of Page

Enter a unique **Bill Message** and **Description** for every bill message.

The following attributes control how and where the bill message appears on the customer's bill:

Priority controls the order in which the message appears when multiple messages appear on a bill.

NOTE:

The values for this field are customizable using the Lookup table. This field name is MSG_PRIORITY_FLG.

Insert Code controls whether a document should be inserted into the bill envelope when the bill message appears on a bill.

Message on Bill is the actual verbiage that appears on the customer's bill. If the message text is not static (e.g., field values need to be substituted into the body of the message), you can use the % *n* notation within the **Message on Bill** to cause field values to be substituted into a message. Refer to [Substituting Field Values Into A Bill Message](#) for more information.

Setting Up Bill Route Types

Bill route types define the method used to route bills to accounts. To define a bill route type, open **Admin > Billing > Bill Route Type**.

Description of Page

Enter a unique **Bill Route Type** and **Description** for every bill route type.

Bill Routing Method controls the type of information that may be defined when the respective **Bill Route Type** is selected on [Account - Person Information](#). The following options are available:

- **Postal:** Use this method if the routing is via the postal service.
- **Fax:** Use this method if the routing is via fax.
- **Email:** Use this method if the routing is via email.

NOTE:

The values for **Bill Routing Method** are customizable using the [Lookup](#) table. This field name is BILL_RTG_METH_FLG.

The next two fields control how bills that are routed using this method are [printed](#) (both in batch and online).

- Use **Batch Control** to define the background process that performs the actual download of the billing information. Refer to [Technical Implementation of Printing Bills In Batch](#) for more information about these processes.
- Use **Extract Algorithm** to define the algorithm that constructs the records that contain the information that appears on a printed bill. Refer to [Printing Bills](#) for more information.

Setting Up Bill Cycles

FASTPATH:

Refer to [Defining Bill and Measurement Cycles](#) for a description of how to set up bill cycles.

Setting Up Customer Classes

When you set up an account, you must assign it a customer class. The topics in this section describe the customer class control table.

Customer Class - Main

To set up customer classes, navigate to **Admin > Customer > Customer Class > Add** and use the **Main** page to define your Customer Class.

Description of Page

Enter a unique **Customer Class** code and **Description** for every customer class.

Use **Collection Class** to define the collection class that defaults onto new accounts that belong to this customer class. An account's collection class may be subsequently modified if the account has special collection problems or needs.

FASTPATH:

For more information about the significance of collection class, refer to [Designing Your Collection Classes](#).

Turn on **Business Activity Required** if service agreements linked to accounts with this customer class require a Business Activity description to be entered.

Turn on **Open Item Accounting** if accounts belonging to this customer class are subject to open-item account. Refer to [Open Item Accounting](#) for a complete explanation of the significance of this switch.

Turn on **Non CIS Payment** if accounts belonging to this customer class are used for payments made to reduce non-CIS debt. For example, assume your company accepts payments for a county assessor and you don't want to set up a separate account for each person who pays their assessment bill. You should set up the following information to accept such payments:

- Create a new customer class called "Non CIS Customer".
 - Create a SA type for each type of non-CIS payment that customers can make. Make sure to enter a distribution code on each SA type that references the appropriate revenue (or payable) account. Don't forget to indicate that each SA type is not billed.
-

NOTE:

Payment Templates can be used for common types of non-CIS payment allocations. These templates are used to default the payment distribution and allow non-CIS payments to be directly allocated to specific distribution codes.

FASTPATH:

For more information about using Payment Templates to process non-CIS payments, refer to [Non-CIS Payments](#).

- Create an account to which you'll book such payments. Have this account reference the new customer class. We recommend creating a separate account for each SA type that you created in the previous step.
- Create and activate a service agreement for the new account(s).

When someone pays for non-CIS debt, the operator will add a payment for the above account. On the payment, the operator should record reference information in order to know exactly why the payment was made. Refer to [Payment Event - Main](#) for more information.

You must define a variety of business rules for every division in which a customer class has customers. For example, if you operate in both California and Nevada AND you have CIS divisions for each state AND you have residential customers in each state, you must define **Customer Class Controls** for each CIS division. You do this on the [Customer Class - Controls](#) page. The grid that follows simply shows the CIS divisions for which business rules have been set up.

Customer Class - Bill Messages

When a customer class has bill messages, the system will sweep these messages onto bills created for accounts belonging to the customer class. Use this page to define a customer class's bill messages. Navigate to **Admin > Customer > Customer Class > Search** and then navigate to the **Bill Messages** page to maintain this information.

Description of Page

Use the bill messages collection to define **Bill Message** codes that should appear on bills that created for accounts that belong to a given customer class. For each message, also specify the **Start Date** and **End Date** when such a message should appear on the bill (leave **End Date** blank if the message should appear indefinitely).

Where Used

The system snaps customer class bill messages on a bill during bill completion. For more information about bill messages, refer to [The Source Of Bill Messages](#).

Customer Class - Controls

You must define a variety of business rules for every division in which a customer class has customers. For example, if you operate in both California and Nevada AND you have CIS divisions for each state AND you have residential customers in each state, you must define **Customer Class Controls** for each CIS division in respect of the residential customer class. Open **Admin > Customer > Customer Class > Search** and then navigate to the **Controls** page to maintain this information.

Description of Page

The **Customer Class Controls** scroll contains business rules governing accounts that belong to a **CIS Division** and **Customer Class**. The following fields should be defined for each **CIS Division**:

- Use **Days Till Bill Due** to define the number of days after the bill date that the customer's bill is due. If the due date is a weekend or company holiday, the system will move the due date forward to the next workday (using the workday calendar defined on the account's CIS division).
- Specify the **Budget Plan** that defaults onto new accounts belonging to this customer class. Please note that an account's budget plan may be subsequently modified if the account has special budget processing needs. Refer to [Setting Up Budget Plans](#) for more information.
- Use **Min Credit Review Freq (Days)** to define the maximum number of days that can elapse between the reviews of an account's debt by the [account debt monitor](#). Note, a value of zero (0) means that accounts in this customer class will be reviewed every day.
- Use **Credit Review Grace Days** to define the number of days after the bill due date that an account should be reviewed by the [account debt monitor](#).
- Turn on the **Late Payment Charge** if customers in the class / division combination are eligible for late payment charges.
- Use **LPC Grace Days** to define the number of days after a bill's due date that a late payment charge will be generated (if the various LPC algorithms allow such - refer to [How Late Payment Charges Get Calculated](#) for the details). If the grace date falls on a weekend or holiday, the system moves the grace date to the next available workday (using the workday calendar defined on the account's CIS division).
- Specify an **Access Group** to default an access group onto an account based on the account's CIS Division and customer class. This will override the access group defaulted from the user's default access group. Note: the access group defined here will not apply if a Customer Class Control - Determine Access Group algorithm is defined and successfully returns an access group.

The grid that follows contains **Algorithms** that control important functions in the system. You must define the following for each algorithm:

- Specify the **System Event** with which the algorithm is associated (see the table that follows for a description of all possible events).
- Specify the **Sequence** and **Algorithm** for each system event. You can set the **Sequence** to 10 unless you have a **System Event** that has multiple **Algorithms**. In this case, you need to tell the system the **Sequence** in which they should execute.

WARNING:

These algorithms are typically significant system processes. The absence of an algorithm may prevent the system from operating correctly.

You can define algorithms for the following **System Events**:

System Event	Optional / Required	Description
--------------	---------------------	-------------

Auto Pay Amount Over Limit	Optional	<p>This algorithm is called to handle the situation when a system-initiated automatic payment is created that exceeds the customer's maximum withdrawal limit. Specifically, this algorithm is called when:</p> <ul style="list-style-type: none"> - The account has a maximum withdrawal limit on their automatic payment options - The system attempts to create an automatic payment that exceeds this amount - The automatic payment algorithm that's plugged into the installation record has logic that invokes this algorithm when the above conditions are true <p>If you do not plug-in this type of algorithm and the above situation is detected, the automatic payment will be created and no error will be issued.</p> <p>Refer to How To Implement Maximum Withdrawal Limits for more information.</p>
Bill Completion	Optional	<p>When a bill for an account is completed, bill completion algorithms are called to do additional work.</p> <p>Refer to the description of the Complete button under Bill Lifecycle for a description of when this algorithm is called during the completion process.</p>
Bill Eligibility	Optional	<p>Algorithms for this plug-in spot are called when generating a bill in batch billing. It provides the ability to determine if an account is ineligible for billing and should therefore be skipped from further processing.</p> <p>If an eligibility algorithm is not used, a bill is created for any account in the open bill cycle and is later deleted by the billing process if it detects that there is no information linked to the bill.</p>
Bill Segment Freeze/Cancel	Optional	<p>When a bill segment for an account in this customer class / division is frozen or canceled, an algorithm of this type may be called to do additional work.</p> <p>Refer to Bill Segment Lifecycle for more information about freezing and canceling bill segments.</p>
Cancel Bill	Optional	<p>This algorithm provides the ability to include additional cancel logic when canceling online.</p> <p>Algorithms of this type can be called in two modes: D (Determine Bill Page Buttons) and X (Cancel Bill). Mode 'D' governs whether an action button to cancel the bill will appear on</p>

		the Bill page and mode 'X' performs the actual cancellation logic.
Determine Access Group	Optional	<p>When an account is added or an account's CIS Division or customer class is changed, this plug-in spot can be used to determine the appropriate access group. This plug-in spot allows more complex logic to be defined, such as checking the access group on the main person's others account's.</p> <p>If a determine access group is not used, the access group can be defaulted from the customer class control or the user.</p>
FT Freeze	Optional	<p>When an FT is frozen, this algorithm is called to do additional work.</p> <p>For example, if you practice Open Item Accounting, you will need such an algorithm to handle the cancellation of match events when a financial transaction is canceled that appears on a match event. Refer to How Are Match Events Cancelled? for more information about cancellation.</p>
LPC Eligibility	Required if the customer class / division is eligible for late payment charges	<p>This algorithm is called by the late payment process to determine eligibility for late payments.</p> <p>Just because an account's customer class allows late payment charges to be calculated doesn't mean the account's delinquent service agreements will be levied late payment charges. In addition, a delinquent service agreement's SA type must reference a late payment charge algorithm. Refer to SA Type - Main for more information about SA type late payment charge issues. Refer to How Late Payment Charges Get Calculated for more information about late payment charges in general.</p> <p>NOTE: Only One Algorithm. Only one late payment charge eligibility algorithm may be defined for a customer class / CIS division combination.</p>
Levy NSF Charge	Optional	<p>This algorithm is called when a payment is canceled with a cancellation reason that indicates an NSF.</p> <p>Refer to NSF Cancellations for more information about what happens when a payment is canceled due to non-sufficient funds.</p> <p>NOTE:</p>

Only One Algorithm. Only one algorithm to levy an NSF charge may be defined for a customer class / CIS division combination.

Order Completion	Optional	When an order is completed for a customer linked to this customer class, this algorithm is called to do additional work (e.g., create a customer contact). You need only specify this type of algorithm if you require additional work to be performed when an order is completed for customers who belong to this customer class.
Overpayment Distribution	Required	When a customer pays more than they owe, this algorithm is called to determine what to do with the excess funds. Refer to Overpayment Segmentation for a description on how to configure the system to handle your overpayment requirements. NOTE: Only One Algorithm. Only one overpayment distribution algorithm may be defined for a customer class / CIS division combination.
Override Due Date	Optional	An account's bill due date will be equal to the bill date plus its customer class' Days Till Due. If you need to override this method for accounts in a specific customer class, specify the appropriate algorithm here. NOTE: Only One Algorithm. Only one due date override algorithm may be defined for a customer class / CIS division combination.
Payment Cancellation	Optional	Algorithms of this type are called when a payment is canceled.
Payment Distribution	Required	This algorithm is called to distribute a payment amongst an account's service agreements. Refer to Payment Distribution for more information about how payment distribution works. NOTE: Only One Algorithm. Only one payment distribution algorithm may be defined for a customer class / CIS division combination.
Payment Freeze	Optional	When a payment is frozen, this algorithm is called to do additional work. If you practice Open Item Accounting , you will need such

an algorithm to link the payment's financial transactions to the match event that was originally created when the payment was distributed. Refer to [Payments and Match Events](#) for more information.

Post Bill Completion	Optional	<p>When a customer class has algorithms of this type, they are called after the completion of a bill for an account linked to this customer class.</p> <p>Refer to the description of the Complete button under Bill Lifecycle for a description of when this algorithm is called during the completion process.</p>
Pre Bill Completion	Optional	<p>When a customer class has algorithms of this type, they are called immediately before completion starts for an account linked to this customer class. These algorithms have the potential of:</p> <ul style="list-style-type: none">• Deleting a bill. You might want a pre completion algorithm to delete a bill if a condition is detected that should inhibit the sending of a bill to a customer (e.g., the bill just contains information about recent payments).• Aborting the completion process and creating a bill exception. If the algorithm indicates this should be done, the bill is left in the pending state and a bill exception is created describing why completion was aborted. You might want a pre completion algorithm to do this if, for example, integrity checks detect there is something wrong with the account or its service agreements. If the integrity check fails, the bill can be left in the pending state and a bill exception created describing why. <p>Refer to the description of the Complete button under Bill Lifecycle for a description of when this algorithm is called during the completion process.</p>
Quote Completion	Optional	<p>When a quote is completed for a customer linked to this customer class, this algorithm is called to do additional work (e.g., create a customer contact). You need only specify this type of algorithm if you require additional work to be performed when a quote is completed for customers who belong to this customer class.</p>
Write Off Method	Required if you allow users to write-off debt real time using the write off transaction	<p>When a user presses the create button on the write off transaction, this algorithm is executed to write-off the selected debt. Refer to The</p>

Setting Up Collection Classes

FASTPATH:

Refer to [Setting Up Collection Classes](#) for a description of how to set up collection classes.

Setting Up Customer Information Options

When you add a new person, the system is set up by default to add an account for the person and go to the Start Service page when you save the new person information. You can change this functionality by configuring the following option types on the Customer Information Options feature configuration:

- **Add Account and Start Service Default:** Indicates whether the Add Account and Start Service option is selected on the person page, by default. If this option is not configured, the Add Account and Start Service option is selected by default.
- **Post Add Person BPA Script:** Indicates a BPA script to invoke when a user successfully adds or changes a person on the person page.

When you use control central to search for accounts, the system limits your search results based on your access rights. You can change this functionality by configuring the following option type.

- **Search All Accounts:** Indicates whether a Control Central search should allow a user to search all accounts without validating the user's access rights. If the user tries to select an account without having the required access, they will not be able to navigate to the Account Information tab on Control Central for the selected account.

For more information about Feature Configurations, see [Defining Feature Configurations](#).

Setting Up Customer Contact Options

This section describes tables that must be set up before you can define customer contacts.

FASTPATH:

Refer to [The Big Picture Of Customer Contacts](#) for more information about customer contacts.

Setting Up Customer Contact Classes

Every customer contact record has a contact type that classifies the record for reporting purposes. And every contact type, in turn, references a customer contact "class". The class categorizes customer contacts into larger groupings for reporting purposes.

Open **Admin > Customer > Customer Contact Class** to define your customer contact classes.

Description of Page

Enter a unique **Contact Class** and **Description** for each customer contact class.

After you have created your customer contact classes, you'll be ready to setup your [customer contact types](#).

Setting Up Customer Contact Types

Every customer contact record has a contact type that controls the behavior of the customer contact.

FASTPATH:

Refer to [The Big Picture Of Customer Contacts](#) for more information about customer contacts.

Open **Admin > Customer > Customer Contact Type > Add** to define your customer contact types.

Description of Page

Every customer contact type is identified by a unique combination of **Contact Class** and **Contact Type**.

Enter a brief **Description** of the customer contact type.

Only specify a **Contact Shorthand** if customer contacts of this type can be added in the [Customer Contact Zone](#). The value you specify in this field is what the user selects to add a customer contact in this zone.

If your implementation requires restricting customer contact types by CIS Division, specify a **CIS Division** on the customer contact type.

Person Usage controls the applicability of a person on customer contacts of this type. Select **Required** if a person must be defined on this type of customer contact. Select **Optional** if a person can optionally be defined on this type of customer contact. Select **Not Allowed** if a person is not allowed on this type of customer contact.

Account Usage controls the applicability of an account on customer contacts of this type. Select **Required** if an account must be defined on this type of customer contact. Select **Optional** if an account can optionally be defined on this type of customer contact. Select **Not Allowed** if an account is not allowed on this type of customer contact.

Premise Usage controls the applicability of a premise on customer contacts of this type. Select **Required** if a premise must be defined on this type of customer contact. Select **Optional** if a premise can optionally be defined on this type of customer contact. Select **Not Allowed** if a premise is not allowed on this type of customer contact.

NOTE:

Person usage and premise usage cannot both be set to not allowed, as the customer contact must at least one of them. Account usage is dependent on person usage.

Entity Relationship controls the validation of relationships on customer contacts of this type. *All* ensures that the account belongs to the person and that the account and premise are related. *Person and Account Only* disables the account and premise validation. *Premise and Account Only* disables the person and account validation. *None* disables all validation and allows any values. This setting only impacts the validation of values entered and works in conjunction with the three usage fields described above.

Use **Contact Action** if something should be triggered when customer contacts of this type are added or if the contact has a special use. When set to *Send Letter*, you must also specify a **Letter Template**. Refer to [Printing Letters](#) for more information about how letters are produced. Set to *Record Notification* if this contact type is used on template-based notification types as a record of the communication.

The **Business Object** defined here controls how customer contacts of this type are show on the customer contact portal. The system is delivered with three customer contact business objects. The value is defaulted based on the contact action.

NOTE: Unlike many objects, the customer contact business object is not stored directly on the customer contact. The system obtains it from the type and uses it to control how the customer contact is displayed, such as which fields are shown. It does not impact the behavior of the customer contact.

Set the **Custom Archive Eligibility Criteria** flag to *Applicable* if customer contacts of this type require additional custom eligibility criteria checks when being evaluated for archiving.

NOTE: The base product provides an ILM Eligibility algorithm for Customer Contact (C1-CCILMELIG) that marks a customer contact as eligible for archiving based on the customer contact's age and the state of the related person's information. This algorithm will not mark the customer contact as eligible for archive if the customer contact type's Custom Archive Eligibility Criteria flag is Applicable. Your implementation is responsible for providing the additional criteria checks for customer contact types that require custom eligibility criteria.

Use the **Customer Contact Type Characteristics** collection to define characteristics that can be defined for contacts of a given type. Use **Sequence** to control the order in which characteristics are defaulted. Turn on the **Required** switch if the **Characteristic Type** must be defined on customer contacts of a given type. Turn on the **Default** switch to default the **Characteristic Type** when customer contacts of the given type are created. Enter a **Characteristic Value** to use as the default for a given **Characteristic Type** when the **Default** switch is turned on.

Setting Up Notification Preference Options

The topics in this section provide background information about notification preferences.

Notification Preferences Overview

The Notification Preferences functionality is comprised of two main components: sending messages out of the system and maintaining customers' communication preferences for receiving these messages.

Notifications are created by an algorithm plugged into the Create Notification plug-in spot on the Notification Type (BO). The base product provides the C1-CRE-NTF algorithm, which creates the notification via an outbound message.

The following sections describe specific notification preference concepts and how to configure the system to use notification preferences.

Setting Up Notification Event Types

This portal is used to display and maintain a Notification Event Type.

Notification Event Types are system events used to send communications or notifications to customers.

You can access the portal from **Admin > Customer > Notification Event Type**.

This is a standard [All-In-One Portal](#).

Refer to the embedded help text for more information.

Template-Based vs. Message-Based Notification Types

The application supports two different notification formats: template-based and message-based. For message-based notifications, the outbound message contains the message that is delivered. It contains the fixed and variable information and comes from the message catalog. For template-based, the outbound message contains the data necessary for an external system to create the notification. In this model, the external system owns the message format and fixed content and uses the data from the system for the variable information. The notification type's business object has an option that indicates the format. This business object option is used by the programs that initiate notifications from the application. The programs that initiate a notification and need to know the notification type's format and must have the responsibility to populate the correct elements before calling the create notification plug-in spot. These programs know how to prepare notification information based on the format before calling the notification type's BO create notification plug-in spot. That plug-in spot's API has elements that support both notification formats.

Push vs. Subscription Notification Types

Notification types are defined as either push – which means that a customer need not sign up to receive notifications of this type, or subscription – which means that a customer must sign up to receive this type of notification. As you can tell, they have different uses and different behaviors.

Push notification types allow users to specify communication preferences for a general type of notification, which are referred to as parent push notification types. These preferences include contact preferences and opt-out preferences, which are applied to individual notifications belonging to the parent type. For example, “Products and Offers” may be the parent type, and the individual notification types may include several different types of product and offers notifications that contain different messages and are targeted at different customers. Refer to [Parent vs. Individual Push Notification Types](#) for more information.

In the absence of any contact preference or opt-out preference, push-based notifications can determine a default contact and send the notification using it. The logic to determine a default contact is defined via an algorithm plugged into the Determine Default Contact plug-in spot on the Notification Type (BO). The base product provides the C1-NTF-DFPRF (Determine Default Contact for Notification Type) algorithm, which looks to retrieve a default contact from the account’s main person.

Subscription notification types define a particular notification and its message. Customers must have an active contact preference to receive these notifications. Subscription-based notification types can use an underlying service task. Refer to [Some Notification Types Use Service Task](#) for more information. A subscription-based notification type can also be set up to allow routing of bills or quotes to multiple destinations.

NOTE: For template-based notifications, there are distinct business objects for subscription, parent push and individual push notification types. For message-based notifications, there is a single business objects and the behavior of the notification type must be defined when configuring the notification type.

Parent vs. Individual Push Notification Types

Push notification types are configured as either a parent or individual notification type. An individual notification type references a parent notification type; a parent cannot reference another parent. Customers define communication preferences for parent push notification types. Notifications are sent out for individual push notification types. The preferences defined for parent push notification types are applied to the associated individual push notification types.

This means that customers do not have to supply their preferences for every individual notification that your implementation may send. Storing customer preferences for a parent notification type permits those preferences to be inherited for individual notification types added later in time under the same parent. The parent push notification types can be thought of as categories of notifications for which your customers define contact preferences and opt-out preferences.

When system processes or your custom processes attempt to send out a push notification, it should be for an individual notification type. The system will retrieve the parent notification type from the individual notification type when checking for communication preferences.

One function available to push-based notifications as described in [Push vs. Subscription Notification Types](#) is the ability to determine a default contact in the absence of a contact preference or opt-out preference. If your implementation wants to take advantage of this function, but would like the customer to supply preferences for receiving an individual notification, a parent push notification type can be set up with only one individual push notification type.

Delivery Type

Delivery Type is the channel used to send a notification. Examples are email, text message (SMS), fax, and outbound IVR. Delivery type is used throughout notification preferences. If your implementation is not using notification preferences, you would not utilize delivery type.

- Notification types list the supported delivery types. For example, a bill ready notification type may support email and SMS while a notification type to encourage customers to enroll in a budget plan may only support email. The message subject and body are configured for each notification type's supported delivery type.
- Person contact types list the allowable delivery types. For example, a cell phone person contact type may allow SMS while a home phone person contact type may not allow any delivery types. An email person contact type would allow an email delivery type unless the person contact type exists to capture a customer's email address and not to be used in conjunction with notification preferences. Note: the delivery types that can be specified on a person contact type are restricted to those defined on the person contact types contact routing. Refer to [Setting Up Contact Routings](#) for more information.
- A contact preference for a customer consists of the combination of notification type, delivery type, and person contact.

Enabling Opt-In for a Delivery Type

Overview

Opt-in can be enabled for a delivery type and is configured using the **Notification Preferences** [master configuration](#); for example, opt-in can be enabled for SMS, but not email.

To help clarify some terminology, as explained in [Person Contact Status Can Be Controlled by a Process](#), the product is delivered with a process that initiates a service task to request opt-in or permission to use a person contact. This solution requires that opt-in is enabled for the delivery type associated with the person contact type. In this regard, the two concepts are intertwined, but enabling opt-in for a delivery type can function independently.

Enabling opt-in is centered on the person contact status, while the process that controls the status can vary; therefore, it is possible to use enable opt-in for a delivery type while manually controlling the person contact status. Enabling opt-in for a delivery type has two key impacts system behavior.

- When a contact preference is added and the delivery type is enabled for opt-in, there is logic that checks if the person contact associated with the contact preference is in the **Approved** status. If it is not, and the person contact type is associated with a process to control the status, that process is initiated. If the person contact type is not associated with a process to control its status, a To Do Entry is created. The To Do Type is configured on the **Notification Preferences** master configuration. The system is delivered with To Do Type Opt-In Errors (C1-OPTIN) for this purpose.
- Notifications will not be delivered to person contacts that are not **Approved**. When a system process initiates an outbound notification based on an active preference, if the person contact associated with the contact preference is not **Approved**, a flag is set in the notification indicating that it should not be delivered. It is up to the receiving system, such as Notification Center, not to deliver the notification based on this flag. This is designed so that a record of the notification being generated is still captured. Also, C1-NTF-DFPRF (Determine Default Contact for Notification Type) will not choose a person contact that is not approved.

The **Notification Preferences** [master configuration](#) help text contains detailed information about the configuration required to enable opt-in for a delivery type.

Some Notification Types Use Service Task

Prior to the introduction of notification preferences functionality, the system supported notifications set up through self-service. These notifications used service tasks to store customer preferences and in some cases trigger notifications. The destination information for the notification existed outside of the system. Notification preferences, and more particularly communication preferences, define the user's preferences on how to be notified for each notification type and where the notification is to be sent. This reduces, but does not eliminate, the need to use a service task to store a customer's preference. These service tasks will not contain the self-service information when created internally by the system

There are four existing notification types that rely on service tasks to trigger a notification. Additionally, one of the prepaid notifications uses a service task type business object with specific fields for that notification type. Refer to [Designing Notification Types](#) for information regarding the configuration requirements for certain notification types.

Notification Preferences supports configuring notification types with or without a service task and only subscription-based notification types can be configured with an underlying service task.

Designing Notification Types

Some notification types require a specific configuration in order for the system to create notifications for that type.

Service Task Based Notification Types

There are system processes that rely on a hard-coded notification type lookup, referred to as notification type (legacy) on the notification type configuration. The system identifies the user-defined notification type from the lookup value.

The following identifies the configuration requirements for the notification types that are supported by existing processes in the system that rely on service tasks.

Notification Type (User Defined)	Push/Subscription	Controlled By	Notification Type (Legacy)	Service Task Type
Prepaid billing new charge	Subscription	Service Task	C1PC	Self-Service Task Type with BO C1-NotifyTaskType
Prepaid billing payment request	Subscription	Service Task	C1PP	Self-Service Task Type with BO C1-PPBPaymentNotifyTaskType
Payment Received	Subscription	Service Task	WSPR	Self-Service Task Type with BO C1-NotifyTaskType
Bill Ready	Subscription	Service Task	WXBR	Self-Service Task Type with BO C1-NotifyTaskType
Bill Due	Subscription	Service Task	WXBD	Self-Service Task Type with BO C1-NotifyTaskType
Late Payment	Subscription	Service Task	WSLP	Self-Service Task with BO C1-NotifyTaskType

Non-Service Task Based Notification Types

The following identifies the configuration requirements for the notification types that are supported by existing processes in the system that rely on the user-defined notification type to be configured.

NOTE:

Marketing and forms notification types can be set up one of two ways: as subscription-based or as push-based. For it to be push-based, it would be an individual push, meaning that it references a parent push notification type specified by the implementer.

Notification Type (User Defined)	Push/Subscription	Controlled By	Notes
Marketing Preference (Lead Event)	Subscription or Individual Push	N/A	Notification type configured on lead event type of BO C1-LeadEvtTypeNotificationPref
Forms Update	Subscription or Individual Push	N/A	Notification type configured on form task type of C1-FormTaskTypeForNotification

Bill and Quote Routing

Notification types can also be used to define contact preferences for bill and quote routing for email and fax. This can enable a bill or quote to create a routing for each active contact preference. For example for a single person on an account that receives a copy of the bill, the bill can be sent to more than one email address.

Some specific configuration is needed to support this.

The notification types are to be set up as follows and must use the message-based notification type business object.

Notification Type (User Defined)	Push/Subscription	Controlled By	Bill/Quote Route Type	Algorithm
Bill Route	Subscription	Bill Route	Specify the Bill Route Type	Use the Suppression Algorithm for Bill/Quote Route
Quote Route	Subscription	Quote Route	Specify the Quote Route Type	Use the Suppression Algorithm for Bill/Quote Route

Configure only the delivery type that corresponds with the bill or quote route's routing method. For example, if the bill route type's routing method is email, configure the email delivery type on the notification type.

Configure only person contact types whose contact routing corresponds with the bill or quote route's routing method. For example, if the bill route type's routing method is email, configure only person contact types with a contact routing of email. Ensure that the person contact type allows only the delivery type specified on the notification type.

This very specific configuration is needed because the system will override the existing logic that creates bill and quote routings when a notification type exists as described above and there are active contact preferences for that notification type with the specified delivery type and the person contact's person contact type.

Collection Events

The system is delivered with a collection event algorithm type that supports template-based notifications. To send collection based notifications, define individual push notification types for each collection notification. These notification types should reference a parent notification type such as "Collection Notices". Configure algorithm(s) using the delivered algorithm type, specifying the individual push notification type(s) in the algorithm parameter. Create collection event types using these algorithms and incorporate them into your collection process templates.

Setting Up Notification Type Algorithms

Suppression Criteria

Notification types can be suppressed from appearing in a list for a particular customer. This is done by plugging in a suppression criteria algorithm on the notification type.

The base product provides the C1-ALWY-SUP (Always Suppressed) algorithm, which suppresses the notification type for all customers. This does not impact active contact preferences for the notification type, nor does it prevent processes from creating notifications of this type. This should be used with business process changes to stop sending notifications of this type. This can also be used temporarily after a notification type has been configured, but before it should be used.

The base product provides the C1-CKSP-PPB (Check Prepaid Biller Suppression) algorithm, which suppresses the notification type if the customer does not have an active prepaid biller task. This should be used on prepaid related notification types so that only customers on prepaid billing receive these notifications.

If your implementation's business rules require additional notification type suppression rules, you may introduce your own algorithm.

Override Do Not Disturb

Do not disturb information can be captured on person contacts. Person contacts are associated with a notification type to define a contact preference. When notifications are sent out, do not disturb information is included in the message to the receiving system. Some notification types might be important enough to not honor the customer's do not disturb information. For example, a notification might be sent to a subset of customers to warn of a gas leak and evacuation and needs to be sent regardless of the customer's do not disturb wishes. This is done by plugging in an override do not disturb algorithm on the notification type. Note: this does not actually override the customer's information, but sends an indicator in the message to the receiving system that the do not disturb information should be overridden or ignored.

The base product provides the C1-OVR-DND (Override Do Not Disturb) algorithm, which returns a value of true that is passed to the receiving system in the notification.

If your implementation has more specific business rules related to overriding a customer's do not disturb preference, you may introduce your own algorithm.

Setting Up Delivery Types

Base values for Delivery Type are supplied. You can add your specific delivery types by updating the value for the C1_SS_DELIVERY_TYPE lookup field.

Setting Up Notification Types

Each notification type defines the controls and behavior for defining communication preferences and sending out notifications of that type.

There are two main categories of notification types: subscription and push. These behave differently. Refer to [Push vs. Subscription Notification Types](#) for more information.

Push notification types are configured as either parent or individual push notification types. A parent push notification type is used to define communication preferences and an individual push notification type is used to send notifications. Refer to [Parent vs. Individual Push Notification Types](#) for more information.

The base product supplies one Notification Type business object for message-based notification types and distinct business objects for template-based notification types. Refer to [Template-Based vs. Message-Based Notification Types](#) for more information. For more details, refer to the specifications for these business objects.

Some notification types require specific configuration. Refer to [Designing Notification Types](#) for more information.

To set up notification types, select **Admin > Customer > Notification Type +**.

This is a standard [All-In-One Portal](#).

Refer to the embedded help text for more information.

Setting Up the Outbound Message Type

An outbound message type is required for the notification outbound message. This outbound message type must reference the base C1-NotifPrefOutboundMessage (Notification Preference Outbound Message) business object.

Setting Up the Message Sender

A Message Sender is required to define how to send notifications. Use the context of the Message Sender to define the web service interface.

Setting Up the External System and Configure the Messages

Define an external system and configure the valid outbound message types and the method of communication for each (XAI, Batch, or Real Time); Real Time is generally the appropriate choice notifications).

Setting Up Notification Preferences Master Configuration

General configuration details for the notification preferences functionality is captured in the **Notification Preferences**[master configuration](#).

For more information about specific fields in the master configuration, refer to the embedded help.

Other Edge Application Notification

Other applications such as *Oracle Utilities Network Management System* or *Oracle Utilities Meter Data Management* may initiate notifications; for example, the network management product can create notifications for outages or restoration information. The customer's preferences to receive these notifications will reside in Oracle Utilities Customer Care and Billing, since this is where their contact information exists. The other applications need to be notified when an active contact preference is created for one of their notifications. The **Notification Preferences**[master configuration](#) provides the section to indicate if a Notification Type is owned by another edge application. When a contact preference is created or inactivated for one of these notification types, an outbound message is sent to notify the other edge product. When the system event in another edge application occurs that initiates a notification, that application calls and inbound web service that creates the notification.

The **Notification Preferences**[master configuration](#) help text contains detailed information about other edge applications.

Setting Up Service Agreement Options

This section describes tables that must be set up before you can define service agreements.

Setting Up Standard Industry Codes (SIC)

A service agreement for non-residential service should reference a standard industry code (SIC). This code is used to categorize service agreements for reporting purposes. To define a SIC, open **Admin > Customer > SIC Code**.

Description of Page

Enter a unique **SIC** and **Description** for the SIC.

Setting Up Tax Exempt Types

Your rates will probably have provisions for the calculation of taxes of one type or another. Frequently you will have customers who are completely or partially exempt from these taxes. The service agreements for these customers will need to have tax exemption information in order for them to be billed properly. Tax Exempt Type is used to define the precise nature of the applicable exemption. To define the Tax Exempt Types you will use, open **Admin > Customer > Tax Exempt Type**.

Description of Page

Enter a unique **Tax Exempt Type** and **Description** for each type of tax exemption.

Setting Up Contract Quantity Types

You may have customers whose contracts (service agreements) have contractual consumption limits. The service agreements for these customers must have information regarding this quantity in order to be billed properly. Contract Quantity Type is used to precisely define the nature of the quantity. To define the Contract Quantity Types, open **Admin > Rates > Contract Quantity Type**.

Description of Page

Enter a unique **Contract Quantity Type** and **Description** for each type of contract quantity.

SA Type Controls Everything

Every service agreement references a SA type. The SA type controls all aspects of a service agreement's behavior including how service is started, how bills are created, how its financial transactions are booked in the general ledger, and much more. We don't explain how to set up SA types in this section because it's only after you have set up all of the control tables in this manual that you'll be able to finally define your SA types.

FASTPATH:

For more information about SA types, refer to [Defining Service Agreement Types](#).

Financial Controls

FASTPATH:

There are also a number of control tables that must be set up to control the bills, payments, and adjustments that are linked to a service agreement. For more information about these tables, please refer to [Defining Financial Transaction Options](#).

Setting Up Order Options

This section describes tables that must be set up before orders can be used to start service.

FASTPATH:

For more information, refer to [The Big Picture of Campaigns, Packages and Orders](#).

Setting Up Column References

A column reference must be created for each miscellaneous field that's captured on an order that doesn't reside in a characteristic. Refer to [Determine The Properties Of Every Miscellaneous Field](#) for more information.

Open **Admin > Sales & Marketing > Column Reference > Add** to define your column references.

Description of Page

Enter an easily recognizable **Column Reference** code and **Description** for each column reference.

Specify the **FK Reference** to use if this column reference uses field values from another table. Use **Long Description** to describe the data that fields using this column reference capture.

The grid contains **Algorithms** that control important functions in the system. You must define the following for each algorithm:

- Specify the **System Event** with which the algorithm is associated. You can define algorithms for the following system events: Post when order completed, Retrieve current value, Validate field value, Service task order processing, and Pre-process field value. Refer to [Extract Column References](#) for a description of these events.
- Specify the **Sequence** and **Algorithm** for each system event. You can set the **Sequence** to 10 unless you have a **System Event** that has multiple **Algorithms**. In this case, you need to tell the system the **Sequence** in which they should execute.

WARNING:

These algorithms are typically significant processes. The absence of an algorithm may prevent the system from operating correctly.

Setting Up Order Cancellation Reasons

An order cancellation reason must be supplied when an order is cancelled. Open **Admin > Sales & Marketing > Order Cancel Reason** to define your reason codes.

Description of Page

Enter an easily recognizable **Order Cancel Reason** and **Description** for each order cancellation reason.

Where Used

Cancellation reasons are used when an [order is canceled](#).

Setting Up Order Hold Reasons

An order hold reason must be supplied when an order is held. Open **Admin > Sales & Marketing > Order Hold Reason** to define your reason codes.

Description of Page

Enter an easily recognizable **Order Hold Reason** and **Description** for each order hold reason.

Where Used

Hold reasons are used when an [order is held](#).

Setting Up Order Feature Configurations

Defining a [feature configuration](#) with a feature type of Order Configuration can increase performance of the Order page when campaigns have a large number of packages or criteria. Open **Admin > Feature Configuration > Add** to define a configuration for the feature type Order Configuration.

NOTE:

Only one. The system expects only one order configuration feature configuration to be defined.

Description of Page

The following points describe the various **Option Types** that may be defined:

- Eligibility Tree - Suppress Error Packages node. Select this option type and define a value if you would like the [Order Eligibility Tree](#) to suppress the node that contains packages with errors in their eligibility criteria. This is an optional setting. If the option type is not defined, the error packages node is displayed, if applicable.
- Eligibility Tree - Suppress Ineligible Packages node. Select this option type and define a value if you would like the [Order Eligibility Tree](#) to suppress the node that contains packages that are not applicable to the customer based on the eligibility criteria. This is an optional setting. If the option type is not defined, the ineligible packages node is displayed, if applicable.
- Eligibility Tree - Suppress Other Campaigns node. Select this option type and define a value if you would like the [Order Eligibility Tree](#) to suppress the node that contains other eligible campaigns. This is an optional setting. If the option type is not defined, the other campaigns node is displayed, if applicable.

Setting Up Program Management Options

This section describes how to set up the system for program management.

For more information about program management, see [The Big Picture of Program Management](#)

Designing Initiative Eligibility Criteria

The following describes guidelines for designing initiative eligibility criteria. These guidelines apply when using the base-supplied business objects and any additional business objects that the implementation defines.

There are two general types of initiative eligibility criteria business objects provided in base: specific and freeform. Your implementation decides whether to use only one of these types or a mixture of both.

NOTE: Initiative criteria has three categories: eligibility criteria, related object criteria, and participation criteria. (The participation criteria type is currently not used.) During criteria maintenance and lead generation, the system identifies the category to use through a business object option called Initiative Criteria Type. Eligibility criteria business objects are defined with an Initiative Criteria Type of either C1EC (Eligibility Criteria) or C1BT (Both Eligibility Criteria and Participation Criteria).

Specific Criteria Business Objects

Most of the base-supplied business objects are designed to perform comparisons to a specific field. The algorithm type for retrieving/determining the value to compare with is already preset in the business object, such that the Algorithm values that the user sees on the user interface are restricted to the instances of that algorithm type.

Refer to the following base business objects for more details:

- Communication Channel Criteria
- Conservation Program Criteria
- Contract Option Criteria
- Rate Schedule Criteria
- SP Type Criteria
- Service Type Criteria
- Is Account Current Criteria
- Account is on Autopay Criteria
- Account is on Budget Criteria
- Number of Days Since Last Lead Criteria

- Account Customer Class Criteria
- Average Service Quantity Criteria
- Premise Cities Criteria

To add similar business objects:

- Identify the specific value for comparison. This could be a reference to an object or entity in the system, or a character string; such as, true/false.
- Develop the algorithm program to retrieve or determine the comparison value.
- Configure your algorithm type using the Initiative Criteria - Derive Field Value algorithm entity and reference the program you created.
- Configure your business object schema so that the Algorithm field retrieves all algorithm instances of the algorithm type you created.
- Define algorithm instances of your algorithm type.

Freeform Criteria Business Object

The Freeform Criteria business object, on the other hand, is designed to perform comparisons for different types of values. The comparison value is determined by a Derive Value Algorithm Type that is defined as an option on this business object. A number of these Derive Value Algorithm Types are supplied with this business object and your implementation can add to these, as necessary.

NOTE: The supplied Derive Value Algorithm Types perform similar comparisons as those in the base-supplied specific criteria business objects (listed above). The Freeform Criteria business object should only be used if the available specific criteria business objects are not sufficient to perform the needed field value comparisons.

To add Derive Value Algorithm Types:

- Identify the specific value for comparison. It could be a reference to an object or entity in the system, a character string (such as, true/false), or a scalar value (such as, number of days or number of kwh).
- Develop the algorithm program to retrieve or determine the comparison value.
- Configure your algorithm type using the Initiative Criteria - Derive Field Value algorithm entity and reference the program you created.
- Define an algorithm instance for your algorithm type.
- Update the Freeform Criteria business object to add a Derive Value Algorithm Type business object option referencing your algorithm.

Repeat the above steps for each specific field to compare.

Designing Related Object Criteria

The following describes guidelines for designing related object criteria. These guidelines apply when using the base-supplied business objects and additional business objects that the implementation defines.

An initiative defines the related object(s) to associate with leads via the Object Nomination algorithm on the initiative business object. The lead generation process executes this object nomination algorithm after executing initiative eligibility criteria. The base supplied parent Initiative business object (C1–Initiative) is configured with an object nomination algorithm that retrieves the premises that are associated with the account’s active and pending start service agreement’s service points. This algorithm applies the related object criteria, which is configured on the initiative, to each premise. If the premise is determined to be eligible, it is returned as a related object for the lead. To override the base object nomination algorithm, add another instance of the Object Nomination System Event and specify your own algorithm.

The base product supplies related object criteria business objects that look for one or more premise to associate with a lead.

There are two general types of related object criteria business objects provided in base - specific and freeform. Your implementation decides whether to use only one of these types or a mixture of both.

NOTE: Initiative criteria has three categories: eligibility criteria, related object criteria, and participation criteria. (The participation criteria type is currently not used.) During criteria maintenance and lead generation, the system identifies the category to use through a business object option called Initiative Criteria Type. Related object criteria business objects are defined with an Initiative Criteria Type of C1EO (Related Object Criteria).

Specific Criteria Business Objects

The base product supplies two business objects that perform comparisons to a specific premise-related field. The algorithm type for retrieving or determining the comparison value is preset in the business object, such that the Algorithm values that the user sees on the user interface are restricted to the instances of that algorithm type.

Refer to the following base business objects for more details:

- Premise SP Type Criteria
- Geographic Value Criteria

To add similar business objects:

- Identify the specific comparison value. It could be a reference to an object or entity in the system (such as, SP Type), or any other attribute that can be used to find the related object.
- Develop the algorithm program to retrieve or determine the comparison value.
- Configure your algorithm type using the Initiative Criteria - Derive Field Value algorithm entity and reference the program you created.
- Configure your business object schema so that the Algorithm field retrieves all algorithm instances of the algorithm type you created.
- Define algorithm instances of your algorithm type.

Freeform Premise Criteria Business Object

The Freeform Premise Criteria business object, on the other hand, is designed to perform comparisons to different types of values. The comparison value is determined by a Derive Value Algorithm Type that is defined as an option on this business object. Derive Value Algorithm Types are supplied with this business object and your implementation can add to these, as necessary.

NOTE: The supplied Derive Value Algorithm Types perform similar comparisons as those in the base-supplied specific criteria business objects (listed above). The Freeform Premise Criteria business object should only be used if the available specific criteria business objects are not sufficient to perform the needed field value comparisons.

To add Derive Value Algorithm Types:

- Identify the specific comparison value.
- Develop the algorithm program to retrieve or determine the comparison value.
- Configure your algorithm type using the Initiative Criteria - Derive Field Value algorithm entity and reference the program you created.
- Define an algorithm instance for your algorithm type.
- Update the Freeform Premise Criteria business object to add a Derive Value Algorithm Type business object option referencing your algorithm.

Repeat the above steps for each specific field to compare.

Setting Up Lead Event Types

Each initiative can define a structured marketing effort for the events that take place during the life of a lead. For example, one event could be that a letter or an email is sent to the customer.

Each event references a lead event type. An initiative defines a lead event type profile that specifies one or more lead event types and the sequence in which those event types should occur. Refer to [The Big Picture of Initiatives](#) for more information.

Some types of lead events may also involve sending outbound messages to an external system (*e.g.*, to notify a third party representative about a customer who has signed up). The lead event type business object can specify the outbound message type(s) to use.

Event types that involve additional workflow activities can define one or more steps; for instance, when work is outsourced to a third party representative (after customer sign-up), the third party lead event includes a list of steps to complete. Each event step has information (such as, completion date) that can be used to track progress.

The base product supplies a number of Lead Event Type business objects. For more details, refer to the specifications for these business objects.

To set up lead event types, select **Admin > Sales & Marketing > Lead Event Type**.

The Lead Event Type portal contains the following zones:

Lead Event Type List

The Lead Event Type List zone lists all lead event types. The following functions are available:

- Click a [broadcast](#) button to open other zones that contain more information about the adjacent lead event type.
- The standard actions of **Edit**, **Delete** and **Duplicate** are available for each lead event type.

Click the **Add** link in the zone's title bar to add a new lead event type.

Lead Event Type

The Lead Event Type zone contains display-only information about the Lead Event Type. This zone appears when a Lead Event Type has been broadcast from the Lead Event Type List zone or if this portal is opened via drill down from another page.

Please see the zone's help text for information about this zone's fields.

Overriding Initiative Sign Up Options

The behavior of the Sign Up action on Lead maintenance is controlled by two business object options on the initiative:

- Sign Up UI Map
- Sign Up Service Script

When invoking a lead's Sign Up action, the system retrieves these options and displays or executes them accordingly.

The base-owned parent initiative business object, C1-Initiative, is supplied with the Sign Up Service Script option referencing the C1-IntvSignU script. To override this, add another *Sign Up Service Script* option with a higher sequence number.

The Sign Up UI map, on the other hand, is not plugged in on the base BO, because this could vary across implementations. The Sign Up UI map C1-SignUpResponseCh provided in base simply prompts for a Response Channel. Implementations can use this map or their own specific map.

NOTE: The system does not issue an error if the Sign Up UI map is not specified. It proceeds with executing the Sign Up Service Script and, if there are no problems, displays a sign up confirmation. The base-supplied C1-IntvSignU script includes logic to recheck the account's eligibility for the initiative and update the *Has Signed Up* indicator on the lead.

Program Management Master Configuration

The master configuration business object for Program Management defines general configuration details for the program management functionality.

Navigate using **Admin > General > Master Configuration**. In the Master Configuration list, scroll to Program Management Configuration and click the add icon if there is no record yet or the edit icon to modify an existing record.

For more information about specific fields in the master configuration, refer to the embedded help.

Setting Up Letter Templates

You can set up a customer contact type to generate a form letter whenever a customer contact of this type is added. In fact, this is the only way to generate a letter in the system.

FASTPATH:

Refer to [Printing Letters](#) for more information about how letters are produced.

Every customer contact that causes a letter to be sent must reference a unique letter template. To define a letter template, open **Admin > Customer > Letter Template**.

NOTE:

Document composition application users. If you use the document composition software to produce letters, there will be a template in the software associated with each letter. The name of the template must be the same as the code associated with the letter template set up in the system.

Refer to the embedded help for details on the letter template fields.

Setting Up Customer Service Request Types

This portal is used to display and maintain a Customer Service Request Type.

A Customer Service Request Type controls how a specific customer service request is processed.

Refer to [Understanding Customer Service Requests](#) for more information.

To maintain customer service request types, open **Admin > Customer > Customer Service Request Type**.

You are brought to a query portal with options for searching for a specific customer service request type. Once a question is selected, you are brought to the maintenance portal's Main tab, to view and maintain the selected record.

Refer to the zone's embedded help for more information.

The Questions tab is used to configure one or more questions to ask during the flow of a start/stop/transfer service request. Refer to [Setting Up Customer Service Request Questions](#).

The Service Eligibility tab is used to configure one or more service eligibility criteria that are applied using question responses and existing information for the customer or premise request. Refer to [Setting Up Service Eligibility Criteria](#).

The Related Updates tab is used to configure how question responses should be stored when the service request is processed and/or completed. Refer to [Setting Up Response-Related Updates](#).

Setting Up Consumer Contract Request Types

A consumer contract request type is a Customer Service Request Type that controls how a contract change request is processed.

Refer to [Understanding Customer Service Requests](#) for more information on customer service requests.

For contract change requests, the Consumer Contract Request Type also defines the service location business object that is applicable to a market and action (i.e. Add to Contract, Remove from Contract, Meter Change, etc.)

Setting Up Start, Stop and Transfer Request Types

The following sections describe how the request types and process flow types provided in the base product can be extended for your specific business rules.

Verifying Identity, Checking Credit and Requiring Deposits When Starting Service

The Start Service Request Type (request type) provides controls to help verify customers' identity and/or check their credit. The start service process provided with the system can begin with or without a person being passed into the process. The process orchestrates the following:

- When there is no person passed into the process, the assumption is that this is a new customers, but the first step is to ensure they are not already in your system. This is done by performing a person search using, name, phone, e-mail or person identifiers. The search options are configured on the start service type. When a record is not found, the last search criteria are retained to minimize asking the customer for the same information again. If an existing person is found, the record can be selected and the process continues as if the process began with an existing customer. For this purpose, existing customers are simply those in your system before beginning the start service process. They may be long-standing customers with current service, or a person record added moments before beginning the start service process. For this reason, the start service process follows the same steps after choosing to add a new customer or selecting an existing one.
- Ensuring customers are who they say they are is often an important step in starting service, especially for new customers. This is often done by asking the customer for a unique identifier such as a government issued ID like a driver's license, or Social Security number. This information is often verified with a third-party and is sometimes combined with a credit check.

The start service process allows you to configure what identifier types your organization accepts when both new and existing customers are starting service. This may be a subset of all of the person identifier types defined in your system. Refer to [Understanding Person Identifiers](#) for more information. Note: This help topic pertains to the primary identifier; the start service process supports additional, non-primary identifier types separately.

When setting up the start service type and configuring the primary identifier types, you need to indicate their usage. The usage for most uniquely identifying identifiers is probably **New & Existing**. These are identifier types that you accept and can uniquely identify a person or business and are probably the primary ID type on the person record. If there is an identifier that was once accepted and is still considered valid for existing customers, but is not used for new customers, these can be set to **Existing Only**. Lastly, some identifier types such as a PIN or password are used when an identifier is required, but the customer is not willing or is unable to provide a high-quality unique ID. These identifier types should be set to **New & Non-Identifying**. This allow agents to input an ID when one is required, but the process knows that the record is not a unique identifier.

For existing customer, the start service process sets an indicator when an existing identifier is found from the list of identifiers valid for existing customers. Note: the identifier need not be the primary, although it is likely that it is. For new and existing customers, a different indicator is set when a new uniquely identifying identifier is provided during the start service process. ID types that are configured as non-identifying are not considered when setting the indicator. It is

not possible for both indicators to be set since the user is not prompted to enter a new ID when a valid existing one is found. These indicators are passed into plug-in spots called during the start service process.

- Your business rules, might include asking customers for their date of birth. This could be used when deciding whether or not to perform a credit check or ID verification or if it does not factor into the decision, it could be passed to the third party as part of the credit check or ID verification process. If date of birth is not part of the credit or ID process, it may be requested only if the customer is eligible for service and may be used when determining if a deposit is required. Since this could be considered sensitive data, it is possible that is used during the start service process, but not saved on the person record.

To support a wide range of business rules, the start service process provides options for capturing and saving date of birth. When the use of date of birth is enabled, there are options to determine when the date of birth field is shown. It can be show always. It can be show only if a credit check or ID verification is going to be performed. This means the presence of the date of birth cannot factor into the decision to perform a credit or ID check. Lastly it can be shown only if service can start. There is also an option to save the date of birth as a person characteristic. For existing persons, if the date of birth already exists, it is shown, but cannot be updated during the start service process. Note: the date of birth functionality is only available for persons and not businesses.

- After the data entry is complete, the start service process calls the algorithm(s) plugged into the ID/Credit Check Should be Performed plug-in spot, passing the two ID indicators and the date of birth if enabled, to determine if an identity or credit check should be performed. This can be used to ensure the customer has provided the necessary information to pass to an external service to check credit or verify ID. This can also check the indicator that person has an existing ID and no further checking is needed. This is a multi plug-in spot so you can configure as many business rules as necessary. Each algorithm can indicate if the next algorithm should be called. The system is delivered with a sample algorithm that chooses to run a credit check based on the availability of a unique ID and a sample algorithm that bases the decision on the account history. Refer to the algorithm types for this plug-in spot for more details.
- If a credit check should be performed, the user is prompted to perform the credit check or ID verification. The algorithm plugged into the ID/Credit Check plug-in spot is then called. The user is shown if the credit check passed or failed, but the process relies on subsequent plug-in spots to determine use the results of the credit check or ID verification.
- After checking the credit or verifying ID, the next step is ensuring the criteria has been met for starting service and, if so, identifying if the person or business has existing accounts that eligible for service. This is done by calling the algorithm(s) plugged into the Start Service Eligibility plug-in spot. These algorithms receive ID indicators, date of birth if enabled, and the output from the ID/credit check plug-in spot, which can be used to determine if service can start. Algorithms in this plug-in spot are also responsible for returning the eligible accounts if there are any. For example, accounts previously used for bankruptcy or those dormant too long might not be eligible for new service based on your business rules. This is a multi plug-in spot so you can configure as many business rules as necessary. Each algorithm can indicate if the next algorithm should be called. When there are existing accounts that are eligible for service, a control on the start service request type indicates if new accounts are also allowed. You would set the control if a new account can be created even when there are existing eligible accounts. Algorithms in this plug-in spot also support returning a list of ineligible accounts that are shown on the start service process to show information about all of the customer's accounts. If your business rules do not support using existing accounts for new service, your algorithms would not return any eligible accounts. The system is delivered with a sample algorithm that determines start eligibility and account eligibility. Refer to the algorithm type for this plug-in spot for more details.
- Your business rules may require a deposit before a customer starts service. If so, the deposit functionality should be enabled for the start service process and optionally for the transfer service process. There is a control on the customer service request type that allows you to define if a deposit is always required or if the determination is situational, in which case algorithms in the Determine Deposit Required plug-in spot are called. The following explains the plug-in spot.

Since deposits can be based on more than one factor, this is a a multi plug-in spot. When the plug-in spot is called, the deposit required indicator is not set and a generic message is set that a deposit is not required. The system then relies on the algorithms plugged into the plug-in spot to indicate that a deposit is required, or update the message with a specific reason that a deposit is not required.

When called from within the Start Service process flow, the ID indicators, date of birth if enabled, and the results of the ID verification or credit check are passed into this plug-in spot and can be used in determining if a deposit is required.

Note: the transfer service process uses the same plug-in spot, but is not passed any date of birth, ID or credit information since transfer only applies to accounts with current service and the transfer process does not contain the identifier and credit check logic.

There are four sample algorithms provided to determine if a deposit is required. The following illustrates how these algorithms can be used to support both new and existing customers. When a specific condition requiring a deposit or exempting a customer from a deposit is met, the reason is output from the algorithm and displayed to the user in order to communicate with the customer. As mentioned, the system's default assumption is not required and a default message would be shown to the user if none of the algorithms output a more specific message explaining why the deposit is or is not required. Refer to the algorithm type descriptions for more detail information about each.

- C1DEPEXBAGE illustrates how an algorithm is used to waive a deposit when a condition is met, which in this case is the customer's age. This sample indicates that other algorithms in the plug-in spot should not be performed when the condition is met. If your business rules waive deposits when a condition is met and no further checking is required, you'd plug-in the algorithm(s) that check for this first. These algorithms should tell the system not to perform the additional algorithms in this plug-in spot.
- C1REQDEPAID uses the results from the ID or credit check to determine if a deposit is required. This algorithm has logic for both new and existing customers. It uses inputs including an indicator if an ID or credit check was run and, if run, the results of the ID or credit check. Based on the results, this algorithm can require a deposit. This algorithm tells the system not to perform the subsequent algorithms in this plug-in spot when a deposit is required.
- C1REQDEPBACR is intended for existing customers and uses the account's internal credit rating to determine if a deposit is required. It's possible that you'd not verify ID nor run an external credit check for existing customers, so the preceding algorithm would not have required a deposit, leaving downstream algorithms such as this one to make the determination. If the customer's internal credit rate is too low, a deposit is required, and this algorithm tells the system not to perform the subsequent algorithms in this plug-in spot.
- C1DEPEXMPBAH is the last sample and is based on account history. If the customer has recent or current service, the algorithm indicates that a deposit is not required and updates the message explaining that a deposit is not required. If there is no recent account history, the algorithm indicates that a deposit is required. In this example, this is the last algorithm, but it could be performed before other algorithms. To accommodate calling it in any sequence, this algorithm tells the system not to perform the subsequent algorithms only when a deposit is required.

NOTE: If your business follows the model where a deposit is required unless there is a reason to waive it, then your algorithms will behave in the inverse from the delivered samples. Your first algorithm plugged into the plug-in spot must set the deposit required indicator and update the default message. Subsequent algorithms or subsequent steps in the first algorithm can then clear the deposit required indicator when conditions to waive the deposit are met.

The delivered algorithms for these four plug-in spots work with each. You can design the algorithms in these four plug-in spots to work together or independently to implement your business's rule for adding new customers or ensuring existing persons or businesses meet the requirements for verifying ID or credit, starting service, choosing an account, and checking if a deposit is required.

Introducing Your Business Rules For Starting Or Transferring Service

The Start Service and Transfer Service requests are designed to allow you to define pre-requisites before customers start service. Each request has an "Waiting for Additional Actions" status where you can plug-in your business rules that define the actions required to start service. The requests have monitor algorithms to transition into and out of the waiting status.

For example, if you require a deposit to be paid before starting service, you can plug-in your business rule that ensure that the deposit is paid before our process starts the customer's service.

Understanding UI Override Controls

Process flow type panels are made up of a data area or UI map fragment. The delivered start, stop, and transfer process flow type panels are built using data areas. Instead of a single data area, these panels are built using nested or included data areas. This is done to facilitate custom extension of the data area at the lowest. This is useful when your business rules include adding something at the end of one of the delivered sections. However, there are times when your business rules are more complex than just adding on to a delivered section. Some of the UI sections that are delivered can be overridden with a custom replacement UI section. This logic is enabled through UI Override Controls on the request types.

The start, stop, and transfer processes each contain a summary header that is shown at the top of each step in the process that can be overridden. By overwriting this, you can create a custom header that is displayed throughout the process flow.

When starting service, especially for a new customer, business rules can differ between different organizations or within different operating units of the same organization. For example, a utility with customers in different states may have different requirements around verifying identity or checking credit. The sections responsible for new customer and existing customer identification can be replaced with a custom experience using the UI override controls.

When the request type indicates that the UI section is overridden, the extension data area replaces the UI component of the delivered data area that it extends. It does not override or replace the data area's schema.

Displaying More Details for the Move-to Premise

When starting or transferring service, additional scrutiny may be given to the move-to premise. Some of the pertinent information might be related to knowing if the premise has had frequent move-ins and move-outs and what the outstanding balance is on the previous account(s). Perhaps the meter information or usage history is important.

The system is delivered with a feature that is not enabled by default. On the start and transfer customer service request type business objects, you can specify a BPA script in the **Move-To Premise Details BPA Script** BO Option type. This script should invoke a map that contains the additional premise information that is relevant to your business. The Move-To Premise steps on the start and transfer service processes display an icon next to the selected premise when this option is configured. The system is delivered with a sample BPA script (**C1SSDisPrDe**) that can be used as a guide for any custom script you wish to introduce.

Capturing Custom Elements in the Start, Stop, and Transfer Processes

Your business rule may require capturing information beyond what is delivered in the start, stop, and transfer processes. Additional elements can be added to specific places in the processes and the values then made available to the requests and therefore the request's lifecycle algorithms.

To create custom extensions in the processes, create a new data area to hold the custom elements that extends the Panel Extension Data Area where you want to make the extension. The data areas need to use UI Hints or map fragments.

To pass the custom elements values from the process to the request, make the identical extension to the corresponding Request Extension Data Area. The system handles copying the values using "move by name".

Process	Panel	Panel Extension Data Area	Request Extension Data Area
Start	Move-To Premise Address	C1-StartMoveToPremPanelExtend	C1-StartMoveToPremCSRExtend
	Customer Identification	C1-StartCustIDPanelExtend	C1-StartCustIDCSRExtend
	Services to Start	C1-StartSvcToStartPanelExtend	C1-StartSvcToStartCSRExtend
	Person and Account Details	C1-StartAcctDetailPanelExtend	C1-StartAcctDetailCSRExtend
Stop	Services to Stop	C1-StopSvcToStopPanelExtend	C1-StopSvcToStopCSRExtend
	Person and Account Details	C1-StopAcctDetailPanelExtend	C1-StopAcctDetailCSRExtend
Transfer	Move-To-Premise Address	C1-TransferMoveToPremPanelExt	C1-TransferMoveToPremCSRExt

Services to Start	C1-TransferSvcToStartPanelExt	C1-TransferSvcToStartCSRExt
Services to Stop	C1-TransferSvcToStopPanelExt	C1-TransferSvcToStopCSRExt
Person and Account Details	C1-TransferAcctDetPanelExtend	C1-TransferAcctDetCSRExtend

Adding Custom Text to the Start, Stop, and Transfer Processes

When using the start, stop, or transfer processes, agents or CSRs users may need specific instructions or may need to provide specific information to customers, such as how their information such identifiers or email are used. This functionality is referred to as “Agent Contact Scripting” and the system is delivered with specific places in the processes where custom text can be added. These places are called “Script Points” and are maintained as extendable lookup values.

When setting up start, stop, and transfer customer service request, you can configure the text that appears for the provided script points. Refer to the embedded help on the Agent Contact Scripting sections for more information on how to configure this feature.

If your implementation has added custom elements through data area extensions, those extensions can reference custom script points. To implement this, you need to ensure your map fragment’s class attribute is set to “contact-script-point” and the scriptPoint attribute is set to the CM script point extendable lookup value. Here is the sample syntax: <div class="contact-script-point" scriptPoint="CM-NewScriptPoint"/>.

Questions and Response Processing

A customer service request type defines the questions to ask the customer during the flow of self-service start / stop / transfer service requests. Questions are presented, based on the applicability to the customer and / or the premise(s) / SP(s) / SA(s) being started / stopped.

The responses to questions can be inputs to service eligibility criteria processing, to determine: start options (for new/ additional services), additional SAs to start (e.g. non-SP-based SAs) and changes to whether or not selected services (for start / stop) are eligible to be started/stopped.

Questions can also be configured to update person / account / premise attributes and characteristics with the captured responses when the start / stop / transfer service request is processed or completed.

The following sections describe question configuration and response processing.

Understanding Customer Service Request Questions

One or more questions can be asked during the flow of a self-service New Service / Add Service / Stop Service / Transfer Service request. The questions can vary across customer service request types. For instance, the questions asked during a self-service New Service / Add Service request differ from the questions asked during a Stop Service request. Transfer Service requests ask questions for both stopping service and starting service.

The base product provides a Customer Service Request Type Question business object (**C1-CSRTQuestion**) for configuring questions. Refer to the business object in the application for more information

The following describes the functionality that this business object supports:

Question Structure and Valid Answers

A Customer Service Request Type Question references a Customer Question that defines the structure of the question - i.e., question text, answer style (i.e., data type), and valid answers (if applicable).

Refer to [Defining Customer Questions](#) for more details.

Question Applicability

The questions to ask during the flow of a customer service request can be determined using any of the following applicability criteria:

- The customer starting/stopping service is a Person or Business
- Account's Customer Class
- Start / Stop Premise's Premise Type
- SP Type(s) on the Premise(s) being started / stopped

Applicability criteria is optional. General questions can be configured to be always applicable.

Questions are marked as either Required or Optional. When marked as Optional on the CS Request Type Questions, it can be overridden as Required for certain SP Type(s) or Premise Type(s) or any other custom applicability criteria.

Your implementation can extend applicability criteria by:

- Adding elements to the CS Request Type Question - Main (**C1-CSRTQuestionMain**) data area, and / or
- Adding lookup values for Question Related Object Type (QSTN_REL_OBJ_TYPE_FLG)

Note that if you choose to extend the Question Related Object Types, you will also need to customize the **Read Questions** algorithm plugged in on the Customer Service Request Type BOs, to handle your additional applicability criteria.

Answer-Based Question Relationships (Conditional Questions)

A question can have one or more valid answers. Each valid answer, in turn, can determine the next question to ask.

A Customer Service Request Type Question can reference a related question for each Valid Answer. The related question must be one that is already configured on the Customer Service Request Type. Therefore, questions configuration should be a two-step process:

- Add all questions to the Customer Service Request Type.
- For each question, set up the related question(s) based on its valid answer(s).

The system has validation in place to ensure that question relationships do not result in recursion.

Question Placement Groups

A customer service request type can logically group questions based on where they are shown on the user interface. For instance, with a Transfer Service Request, the questions for stopping service are shown separately from the questions for starting service.

A Customer Service Request Type Question can be designated with a Question Placement Group, which is an extendable lookup (**C1-QuestionPlacementGrpLookup**) field. Base-owned lookup values are provided for Self-Service Start Service and Self-Service Stop Service. Each lookup value defines the customer service request type business objects that can use the Question Placement Group. Your implementation can define additional lookup values, if the groupings need to be more specific / granular.

Retrieving Applicable Questions

The **Read Questions** plug-in on the Customer Service Request Type BO is responsible for retrieving the questions that are applicable to a customer service request type. Given the inputs (Customer Service Request Type, Person ID, Account ID and Premise ID), the questions are read based on applicability criteria: Person / Business, Customer Class, Premise Type, SP Type(s) and/or any implementation-specific question applicability criteria (configured in Question Related Objects).

The **Read CS Request Type Questions By Applicability (C1RDCSRTQSTN)** base algorithm will apply Person / Business, Customer Class, Premise Type and SP Type criteria. Additional applicability criteria will require a custom algorithm type.

The Read Questions plug-in spot is invoked using a common service script, **Read CS Request Type Questions By Applicability (C1RDCSRTQSTN)**. The Service Questions operation of the **Start Stop Transfer Tasks IWS** calls this script to read the applicable questions to show on the self-service user interface. Refer to this IWS' specifications for more details.

Understanding Service Eligibility

A service eligibility criterion has four components:

- The value to compare.
- The comparison method, which consists of an operator and a comparison value.
- Action to take, based on the comparison results. The result can be any of: True, False or Insufficient Data. For each result, the possible actions are: Eligible, Not Eligible, Check Next Condition.
- The SA Type(s) and any applicable Start Options that are eligible for start / stop when the comparison results in an Eligible action.

The base product provides a CS Request Type Svc Eligibility Criteria business object (**C1-CSRTSvcEligCriteria**) for configuring service criteria. Refer to the business object configuration in the application for more information

The following describe the functionality that this business object supports:

Criteria Basis and Comparison Method

The **Criteria Basis** on CS Request Type Service Eligibility Criteria determines the value to compare:

- **Question Response** uses the response to a question that is configured on the CS Request Type.
- **Derive Value Algorithm** retrieves a field or characteristic value from an existing object, such as Person, Account or Premise. The base product provides algorithms to retrieve: an attribute from Account, an attribute from Premise and a characteristic value from Person / Account / Premise / SP / SA. Refer to the algorithm types for the **CS Request Type Svc Criteria - Derive Value** algorithm entity, for details.

The **Criteria Comparison** defines the operator to use and the value to compare with either question response or algorithm-derived value. The base product supports the operators: =, <>, >, >=, <, <=, Between and In. The comparison value is a free-form string, which should contain comma-separate values when the operator is Between or In.

Configuring Eligible SA Types and Start Options

At least one Eligible SA Type must be configured on a service eligibility criterion. If configuring multiple SA Types, designate one of them as the default. Configure any applicable Start Option(s) and designate one as the default.

Applying Service Eligibility Criteria

The **Apply Svc Criteria** plug-in on the Customer Service Request Type BO is responsible for processing service eligibility criteria, given input: the selected SPs and SAs to start / stop, list of question responses and the service task ID.

The **Apply Service Eligibility Criteria (C1CSRTAPSEC)** base algorithm reads the service eligibility criteria and performs the criteria comparisons for each.

The **Apply Svc Criteria** plug-in spot is invoked from the common service script for response processing, **Process Question Responses (C1ProQstnRsp)**. The Process Services to Start and Process Services to Stop operations of the **Start Stop Transfer Tasks IWS** calls this script to apply the service eligibility criteria using the question responses capture from self-service. Refer to this IWS' specifications for more details.

Enabling Service Eligibility Criteria

To enable service eligibility criteria:

- Identify the CS Request Type Questions, for which the responses will be used as the values to compare on service eligibility criteria.
- Determine the 'Derive Value' processing that your implementation needs
 - To use the base-provided **CS Request Type Svc Criteria - Derive Value** algorithms:
 - Configure algorithm instances for the **Retrieve Account Attribute (C1SCRETACCT)** algorithm type.
 - Configure algorithm instances for the **Retrieve Premise Attribute (C1SCRETPREM)** algorithm type.
 - Configure algorithm instances for the **Retrieve Effective-Dated Characteristic Value (C1SCRETEFFCH)** algorithm type.
 - Identify and develop any additional **CS Request Type Svc Criteria - Derive Value** algorithms.
- Configure the Service Eligibility Criteria for your implementation's self-service New Service, Add Service, Stop Service and Transfer Service customer service request types. For each criterion, specify:
 - The criteria comparison details - criteria basis, question or algorithm (depending on the criteria basis), operator and comparison value.
 - The actions to take for comparison results True, False and Insufficient Data.
 - The eligible SA Types and any applicable start options.

Refer to [Setting Up Service Eligibility Criteria](#) for more details.

Understanding Response-Related Updates

The questions configured on the customer service request type can be set up to perform related updates when the start / stop / transfer service request is processed and / or completed.

A response-related update can store the response value in a specific attribute or characteristic on objects such as Person, Account, Premise, SP and SA. In other cases, the response value can be used to derive the actual value to store on a particular attribute (e.g. when the attribute is a foreign key to an admin table or a lookup).

The base product provides a CS Request Type Related Update business object (**C1-CSRTRelUpd**) for configuring response-related updates. Refer to the business object configuration in the application for more information

The following describes the functionality that this business object supports:

Related Update Entity Defines The Object To Update

A response-related update specifies a Related Update Entity, which identifies the maintenance object (i.e. Account, Person, Premise, etc.) and the specific part of the object to update - i.e., table field, characteristic or a custom element in the CLOB/XML.

Related Update Entity is an extendable lookup (**C1-CSRTRelUpdEntity**) that has several base-supplied values, to support updates to fields and characteristics on Person, Account, Premise, etc.. Your implementation can add other objects to update by adding values to this lookup.

Response-Related Updates Are Staged For CS Request Processing

Response-related updates are staged into the CS Request Person / Account / Premise or directly on the CS Request, so that all updates to each object are done at the same time - i.e. when the CS Request transitions to a specific status. For instance, with a Start Service Request, the Person(s) and Account are updated when the request transitions to the Service Processing state. An algorithm on that state transitions the CS Request Person and CS Request Account staging records, that will in turn, update the Person(s) and Account. The CS Request SA records are also created and transitioned at that point. The CS Request Premise(s) are transitioned when the CS Request is transitioned the Completed state. Updates to SP attributes and characteristics need to be staged directly on the CS Request, as there is no staging object for SP.

Each response-related update specifies a Processing Algorithm that is responsible for staging the update on the applicable CS Request staging object. The base product provides processing algorithms for the Related Update Entities that are supported in base. Refer to the algorithms types for the **CS Request Type Related Update - Process** algorithm entity, for more details.

Staging Related Updates

The **Stage Related Updates** plug-in on the CS Request Type (BO) is responsible for invoking a customer service request type's response-related updates. It reads the Response-Related Update configuration and invokes the associated **CS Request Type Related Update - Process** algorithms.

The **Stage Related Updates** plug-in spot is invoked using a common service script, **Process Related Updates (C1ProcRelUpd)**.

When a self-service start / stop / transfer request is finalized, an enter algorithm on the service task's Service Processing state calls the Process Related Updates service script before transitioning the CS Request (that in turn, transitions CS Request Person, Account, etc). Refer to the Self-Service Start/Stop/Transfer Task (C1-SSStartStopXferServiceTask) business object, for details on this lifecycle processing.

Enabling Response-Related Updates

To enable response-related updates for configured CS Request Type Questions:

- Determine the Related Update Entities that your implementation needs to support:
 - To use the base-provided Related Update Entities, configure the **CS Request Type Related Update - Process** algorithm instances for the specific fields and / or characteristics that should be updated from the responses.
 - Configure any additional **Related Update Entity** lookup values and develop the corresponding **CS Request Type Related Update - Process** algorithms for them.
- Identify the CS request type questions that will trigger response-related updates. Configure a Response-Related Update for each of these questions, specifying the applicable Related Update Entity and Processing Algorithm. Refer to [Setting Up Response-Related Updates](#) for more details.

Setting Up Customer Service Request Questions

A customer service request type can define one or more questions to ask during the flow of customer service requests, such as self-service New Service, Add Service, Stop Service and Transfer Service.

Refer to [Understanding Customer Service Request Questions](#) for more information.

To configure questions, open **Admin > Customer > Customer Service Request Type** and navigate to the **Questions** tab page.

The Questions List zone displays all questions that are configured for the customer service request type. Search filters are provided, to allow specific search using any of the following criteria: Person/Business, Customer Class, Premise Type (applicability), SP Type (applicability), Sort Sequence (range) and Status.

The Question zone displays when a record is broadcast from the Questions List. Refer to the zone's embedded help for more details.

Setting Up Service Eligibility Criteria

A customer service request type can define one or more service eligibility criteria to apply, using the responses to questions and/or information that is already stored in the system (e.g. person / account / premise attributes and characteristics).

Service eligibility criteria processing can determine one or more of the following:

- Applicable start option(s) for SP-based service agreements that are selected for starting service.

- Additional service agreements that are eligible to start. For example, non-SP-based service agreements, such as charitable contributions, equipment rentals, loans, etc.
- A change in whether or not a selected SP-based service agreement can be started/stopped.

Refer to [Understanding Service Eligibility](#) for more information.

To configure service eligibility criteria, open **Admin > Customer > Customer Service Request Type** and navigate to the **Service Eligibility** tab page.

The Service Eligibility Criteria List zone displays all service eligibility criteria that are configured for the customer service request type. Search filters are provided, to allow specific search using any of the following criteria: Sort Sequence range, Question text and Status.

The Service Eligibility Criteria zone displays when a record is broadcast from the Service Eligibility Criteria List. Refer to the zone's embedded help for more details.

Setting Up Response-Related Updates

Question responses can trigger updates to Person, Account and / or Premise attributes and characteristics, when the request is processed or completed. A Response-Related Update defines: the object to update, the object's attribute / field to update and the algorithm that will process the update. The base product provides algorithms that store question responses in: characteristics, a table fields (on the object's primary table), or a custom element in the object data area (CLOB) field (on Person).

Refer to [Understanding Response-Related Updates](#) for more information.

To configure Related Updates, open **Admin > Customer > Customer Service Request Type** and navigate to the **Response-Related Updates** tab page.

The Response-Related Updates List zone shows all questions that are currently configured for the customer service request type. Each can be configured with a related update that stores the response to the question in a field / attribute / characteristic on Person, Account or Premise. Click **Add Related Update** or **Edit Related Update** to configure the related update.

The Respons-Related Update zone displays when a record is broadcast from the Response-Related Updates List. Refer to the zone's embedded help for more details.

Defining Customer 360 Options

The following section provides an overview of how to enable Customer 360.

FASTPATH:

Refer to [Customer 360](#) for more information on this functionality.

Setting Up The System To Enable Customer 360

To set up the system for Customer 360, do the following:

- Define Display Icon Override Configuration settings.
- Define Billing and Usage Configuration settings.

Display Icon Override Configuration

This section describes the process for configuring display icons that are used within the various zones for Customer 360. For example, icons that appear alongside nodes within the Premise Context tree, as well as icons that appear within records of the Customer Activity and Financial History zones.

By default, display icon references are configured at the Maintenance Object or Business Object level using the **Default Icon Reference** Option Type. For certain Maintenance Objects, these icons can be overridden based on their type fields. For example, a Customer Contact can have an override icon based on its Contact Class or Contact Type, a Service Agreement can have an override icon based on the SA Types Service Type, etc.

Display icon overrides are configured by adding or changing a Master Configuration. You can access the portal through **Admin > General > Master Configuration**.

From the Master Configuration list, add or edit the **Display Icon Override Configuration** record. Use the Add button to configure for the first time. If a record has already been added, click the Edit button instead. Use the embedded help to guide you through the options.

Billing and Usage Display Configuration

There are several options available to tailor your Customer 360 Billing & Usage data display via Master Configuration - Billing and Usage Display Configuration. The units of measure, the specific service quantities to display per rate, the default time period, as well as the summarization of the data within the bar chart can all be adjusted per your organization's needs.

Billing and Usage display settings are configured by adding or changing a Master Configuration. You can access the portal through **Admin > General > Master Configuration**.

From the Master Configuration list, add or edit the **Billing and Usage Display Configuration** record. Use the Add button to configure for the first time. If a record has already been added, click the Edit button instead. Use the embedded help to guide you through the options.

Defining Service Order Options

Service orders manage the activities that are required to enable service, disable service, and perform other operations. These activities can range from simple events (such as, a meter read) to complex events (such as, installing a power line and a new meter). They can also include both fieldwork and smart commands.

Service Orders

This section provides an overview of service order activities.

SOM Options Overview

Understanding Service Order Management

At a high level, service order management handles requests for service as follows:

Receive / Create Service Order Request

A service order request is created and/or received. This can be as a result of a customer requesting a change to their service such as enabling or disabling service when moving into or out of a residence, but can also be the result of other business processes, such as a request to cut service due to non-payment.

Regardless of the origin of the request, a service order request is created in a customer information system (CIS) such as Oracle Utilities Customer Care and Billing), which in turn is sent to Service Order Management.

Create Service Order Activity

When Service Order Management receives the service order request, it creates a service order activity. This activity will manage and orchestrate any/all other activities needed to fulfill the original service request.

Evaluate Service Point and/or Meter

The service order activity then evaluates the current state of the service point, meter, or item, and determines the appropriate action(s) to take to fulfill the service request.

Create Activities as Needed / Appropriate

Based on the evaluation of the service point/meter/item, the service order activity creates one or more activities as needed.

- Service order field activities involve sending workers into the field to perform service. This can include meter installation, meter replacement, and other activities.
- Command activities are smart meter commands used to remotely change the state of the meter. This can include connect, disconnect, checking the device status (ping), or requesting an on-demand reading.

Following each of activities, the orchestration activity re-evaluates the state of the service point/ meter/item to determine the next appropriate action(s) required to fulfill the original service request.

For example, when enabling service at a service point with a smart scalar meter, a typical scenario might involve the following:

1. Service Order Field Activity - Install Meter
2. Command Activity: Commission Device
3. Command Activity: Remote Connect
4. Command Activity: On Demand Read - Scalar

Update Requesting System

When the service order activity determines that everything necessary to satisfy the service order request is ready, the service order activity will inform the requester and complete the original request.

Send Notification to Subscribing Systems

The service order activity can also be configured to send notifications to other subscribing systems regarding the status of the service point/meter/item.

Supported Service Order Processes

Service Order Field Activity supports the following service order processes as part of the base package.

- [Enable Service](#)
- [Disable Service](#)

- [Cut for Non-Payment](#)
- [Reconnect for Payment](#)
- [Meter Exchange](#)
- [Back-to-Back](#)
- [Cancellation Service Order Requests](#)
- [Update Service Order Requests](#)

Enable Service

Enable Service is a request to start service for a particular service point. It is typically initiated by a *Start Service* field activity request, but can also be initiated by another CIS application.

A Start Service field activity request results in the creation of an Enable Service orchestration activity. The Enable Service orchestration activity then initiates the necessary field activities and smart meter commands to change the state of service at a service point to Enabled and confirm that an initial measurement exists; for example, an enable service orchestrating activity could involve the following service order field activities and smart meter commands based on the state of the service point:

- If there is no meter at the service point and the service point is not connected at the source, a service order field activity will be created to connect the service point to its source and install a meter.
- If a smart meter exists at the service point and it is in a disconnected state, a smart meter command will be sent to the appropriate head-end system to connect the meter.
- If there is a non-smart (manual) meter at the service point and it's On, a service order field activity will be created to request a read on or near the start date (depending when the next read is scheduled).

Disable Service

Disable Service is a request to stop service for a particular service point. It is typically initiated by a *Stop Service* field activity request, but can also be initiated by another CIS application.

A Stop Service field activity request will result in the creation of a Disable Service orchestration activity in Service Orders. The Disable Service orchestration activity will initiate the necessary field activities and smart meter commands to change the state of service at a service point to Disabled and confirm that a final measurement exists; for example, a disable service orchestration activity could invoke the following service order field activities and smart meter commands based on the state of the service point:

- If there is a non-smart (manual) meter at the service point and it's on, a service order field activity will be created to turn off the meter.
- If a smart meter exists at the service point and its state is connected or commissioned, a smart meter command will be sent to the appropriate head-end system to perform a remote disconnect of the meter.

Cut for Non-Payment

Disconnect for non-payment is a type of field work that is most often initiated from a collections process that has been created from within the Credit & Collection module. A collections process is created when the customer's current balance has been determined to be past due. One of the methods for eliciting payment is to issue a disconnect. A *Disconnect for Non-Payment* field activity request will result in the creation of a Cut Service for Non-Payment orchestration activity in Service Orders. The Cut Service for Non-Payment orchestration activity will initiate the field activities and/or smart meter commands necessary to change the state of service at a service point to the disabled state.

For a Cut for Non-Payment service order, the orchestrations steps will include determining if a smart meter command can be executed, or if a request to a mobile field work application (such as Oracle Utilities Mobile Workforce Management) to dispatch a truck needs to be executed. Another example might be to determine if a disconnect can be executed for a service point. These rules might include determining if there is life support equipment at the premise, or if the service point can be

disconnected at the current time of year or business hours based on utility defined rules taking into account predominant weather conditions (for instance, the utility cannot disconnect someone in the dead of winter or the service point resides at a postal code that is affected by extreme cold weather).

Reconnect for Payment

Reconnect Service for Payment is a request to restart service for a particular service point after customer has paid off their past due balance. It is typically initiated from the Credit & Collection's Severance Process.

A Reconnect for Payment field activity request will result in the creation of a Reconnect Service for Payment orchestrator activity in Service Orders. The Reconnect for Payment orchestration activity will initiate the field activities and/or smart meter commands necessary to change the state of service at a service point to the enabled state; for example, a service order request to reconnect service could involve the following service order field activities and smart meter commands based on the status of the service point:

- If there is a non-smart (manual) meter at the service point and it's turned off, a service order field activity will be created to turn on the meter.
- If a smart meter exists at the service point and it is in a disconnected state, a smart meter command will be sent to the appropriate head-end system to connect the meter.

Meter Exchange

Meter Exchange service is basically an exchange of an old meter with a new meter. A meter exchange request may be initiated as the result of:

- A smart meter rollout.
- A customer opting-out of having a smart meter.
- A meter no longer working correctly.
- A meter reaching the end of its life expectancy.
- A customer with a manual meter enrolling in a program that requires a smart meter.
- A need to upgrade measurement capabilities.

Meter exchanges can be initiated in a variety of ways, including:

- Within service order field activities (internally)
- By an external CIS or asset management system such as Oracle Utilities Operational Device Management
- A pick-up order from a field work application such as Oracle Utilities Mobile Workforce Management

Meter Exchanges involving smart meters will include smart meter commands in addition to field activities. A request can optionally include information on the type of meter needed, depending on the requesting system; this information could be specific (the type of configuration) or general (smart or manual).

Back-to-Back

Back to Back service is service disablement and enablement in single step; for example, one customer moving out while another moves in. The main purpose of this service is to minimize dispatching field work to obtain readings for both a start and stop event.

Another example of a back-to-back scenario would involve an tenant moving out and another moving into the same premise. As long as the gap between tenants (vacancy) is within the utility company's threshold, the change would be considered as a back-to-back event. In this situation, a single field task is used for this event to take the meter reading.

A Back-to-Back Service field activity request will result in the creation of a Back-to-Back Service orchestration activity in Service Orders. The Back-to-Back Service orchestration activity will initiate the field activities and smart meter commands necessary to change the state of the service of both customers at a service point to the desired state and confirm that measurements exists for that period.

Canceling Service Order Requests

A cancellation request basically cancels any orchestration and/or specific activities that are in progress. If the cancellation request is for an orchestration activity then that orchestration activity along with corresponding activities will be discarded. If the cancellation request is for a specific activity then only that specific activity will be discarded.

Depending on the status of a specific activity, a Cancel orchestration activity will either discard the activity or an outbound communication will be sent to the field work system to request a cancel the specific activity. Once the cancellation sent to the field work system is confirmed as successful, the Cancel orchestration activity will also cancel the parent orchestration activity and/or specific activities. If the cancellation sent to the field work system is not successful then the Cancel orchestration activity will be discarded. When it is discarded, it will send a response message to the requester indicating the cancellation was unsuccessful. A cancellation request can be initiated in a variety of ways, including by cancelling a field activity request , within Service Orders itself (internally), and by an asset management system such as Oracle Utilities Operational Device Management. Cancellation requests can also be created as pick-up orders from a field work application such as Oracle Utilities Mobile Workforce Management.

Update Service Order Requests

An update request handles requests for updates to an existing enablement, disablement, cut for nonpayment, and reconnect for payment orchestration activity and their related specific field activities.

The types of data available for update include the following:

- Instructions
- Comments
- Start Date/Time
- Contact Name
- Main Phone

Additionally, an update request can check to see if appointment information is different between the specific activity and the update orchestration activity. Depending on the status of the specific activity, direct updates will be made to the activities and communications within Service Orders or an outbound communication will be sent to the field work system to request an update of the specific activity fields that have been changed. Once that update to the field work system is confirmed as successful the Update orchestration activity will update the effected orchestration activity. If the updates are not successful the Update orchestration activity will be discarded. When it is discarded, it will send a response message to the requester indicating the update was unsuccessful.

Update service requests can be initiated by a field activity request or within Service Orders itself (internally).

Defining Disconnect Locations

When a service point is disconnected from the supply source, a disconnect location must be specified. This location defines where service was severed.

To define disconnect location codes, open **Disconnect Location** page.

Description of Page

Enter a **Disconnect Location** and **Description** for every disconnect location.

Defining Field Activity Profiles and Types

A field activity request initiates a service order to perform a task at a service point. Every field activity request references a field activity type.

Most field activity requests are created:

- When a customer service representative starts or stops service at a premise. When this happens, the system automatically creates field activity requests for each service point.
- When service is cut due to lack of payment.

If you set the system up correctly, your CSRs won't have to create these field activity requests. Rather, the system creates field activity requests based on the information you set up in your field activity type profiles.

- Refer to [Starting Service & Field Activities](#) for a description of how field activity requests are created to start service.
- Refer to [Stopping Service & Field Activities](#) for a description of how field activity requests are created to stop service.
- Field activities used to cut service due to non-payment are created by two modules:
 - If you use severance process to stop a service agreement due to nonpayment, refer to [Field Events And Their Activities](#) for a description of how these field activity requests are created.
 - If you use cut processes to stop a service agreement due to nonpayment, refer to [Field Activities To Cut and Reconnect Service](#) for a description of how these field activity requests are created.

The topics in this section describe how to design your field activity profiles and field activity types.

How Does A Field Activity Type Profile Get Used?

A field activity type profile contains:

- A list of the types of field activity requests that can be made for service points.
- A matrix defining the specific activity type(s) to generate in order to start service, stop service, or disconnect due to nonpayment.

You may wonder how field activity type profiles get related to your service points. It's a little indirect, but the indirection provides a great deal of flexibility:

- Every service point references an SP type.
- Every SP type references the specific field activity type profile used by the start/stop and credit and collections process to generate field activity requests.

An example will help illustrate how this works:

- When you start service at a specific service point, the system extracts the service point's SP type.
- Then, the system determines the field activity type profile that is to be used on this SP type.
- And finally, it generates the appropriate field activity request.

Designing Field Activity Type Profiles

With Service Order Management typically only a single field activity type profile will be needed for the meter and item related service points. This profile should have a template for each of the following with a service point condition of *External Fieldwork Orchestration* to indicate that Service Order Management is orchestrating the field work:

- Start Service
- Stop Service
- Start/Stop

- Cut for Non-Payment
- Reconnect for Payment

Designing Field Activity Types

A field activity type is required for the following events:

- Start service
- Stop service
- Cut for non-payment
- Reconnect for payment
- Back-to-back

Setting Up Field Activity Types

The topics in this section describe how to set up field activity types.

FASTPATH:

For more information about field activity types, refer to [Defining Field Activity Profiles and Types](#).

Field Activity Type - Main

You begin to define a field activity type by opening **Admin > Field Work > Field Activity Type > Add**.

Description of Page

Enter an easily recognizable **Activity Type** and **Description** for each field activity type.

Use **Field Activity Priority** to define the priority associated with field activity requests of a given type.

NOTE:

The values for this field are customizable using the Lookup table. This field name is FA_PRIORITY_FLG.

Turn on **Display as Alert** if Control Central should display an alert if its premise has a completed field activity request of this type. If this switch is on,

- Use **Nbr Days Alert Active** to define the number of days the alert should appear on Control Central. The field activity request's scheduled date is used as the start date for the alert period.
- Enter the **Alert Information** to appear on Control Central.

NOTE:

Recommendation. We recommend only using this feature on unusual field activity types (e.g., cut for non-payment) so that a CSR is not presented with an alert for every field activity request.

Enter the **Business Object** for this FA Type if the FA type will need access to the BO plug-in spots. If the FA type has a business object specified, the system applies the business object's rules when the FA is added, changed, or deleted. This includes the business object's validation algorithms (only executed after the "core validation" specified on the maintenance object is done), post-processing algorithms, and audit algorithms. The maintenance object for the FA should specify an

algorithm that finds its business object using its FA Type. Refer to the base package Determine Standard Business Object algorithm for an example of this type of algorithm.

Field Activity Step is not applicable when Service Order Management is used.

Use the **Characteristic** collection to define **Characteristic Types** and their respective **Characteristic Values** to describe characteristics that are common to all field activity requests of this type.

NOTE:

You can only choose characteristic types defined as permissible on the field activity type record.

Field Activity Type - FA Characteristics

Description of Page

Use the **Characteristics** collection to define characteristics that can be defined for field activity requests of a given type. Use **Sequence** to control the order in which characteristics are defaulted. Turn on the **Required** switch if the **Characteristic Type** must be defined on field activity requests of a given type. Turn on the **Default** switch to default the **Characteristic Type** when field activity requests of the given type are created. Enter a **Characteristic Value** to use as the default for a given **Characteristic Type** when the **Default** switch is turned on.

NOTE:

Field activity requests created by the system. When setting the Required switch, remember that most field activities are created by the system. Only turn on the required switch for these types of activities if a default characteristic value can also be indicated

Field Activity Type - FA Completion Control

Description of Page

NOTE:

These algorithms are optional. The use of completion algorithms on a field activity type is optional. You would only use them if you have special functions that should be executed when a given field activity type is completed.

The **Field Activity Completion Controls** tab is used when an algorithm should be executed when a field activity request is completed. The type of algorithm may differ based on the CIS division in which the service point's premise is located. The following fields must be defined:

CIS Division Defines the division associated for which the algorithm will be executed. The system will only execute the algorithm when a field activity request is performed at a service point whose premise is governed by the division.

FA Completion Algorithm Defines the algorithm that will be executed when a field activity request is performed at a service point whose premise is governed by the associated division.

Field Activity Type - SP Type Review

Not applicable when Service Order Management is being used.

Setting Up Field Activity Type Profiles

The topics in this section describe the pages used to define a field activity type profile.

NOTE:

When a new profile is added. When you introduce a new field activity type profile, you must define the SP types that use it. Refer to [Understanding Service Point Types](#) for more information.

FASTPATH:

For more information about field activity type profiles, refer to [Designing Your Field Activity Profiles & Types](#).

Field Activity Type Profile - Main

Description of Page

Enter a unique **Field Activity Type Profile** and **Description** for the activity type profile.

The **FA Type Profile Templates** indicate the templates that exist for this field activity type profile. Use the drill down button to go directly to the desired template. Alternatively, you can go to the **Template** tab and scroll until you find the correct template.

Field Activity Type Profile - Template

Description of Page

The information in the **Field Activity Profile Template** collection defines the field activity request(s) created for each situation identified by the **Customer Event**. The possible customer events are Cut for Non-payment, Disconnect Warning, Reconnect for Payment, Reread, Stop Service, Start Service, and Start/Stop.

NOTE: Field activity requests do not need to be defined for Reread when Service Order Management is being used.

Other customer events can be defined on the [Look Up](#) page (search for the CUST_EVT_FLG field name). Refer to the following sections for more detail about customer events included with the base product.

The fields defined for each event are common. You define the field activity request(s) to be generated given the condition of the service point. The following fields display:

SP Field Condition Define the condition of the service point associated with the field activity. Define *External Fieldwork Orchestration* when Service Order Management is being used.

Sequence You will typically have a single field activity request for any specific combination of SP Field Condition and Disconnect Location. Therefore you'll just have a single sequence (say 10) for each combination. If you need to generate multiple field activities based on a given combination, use a unique sequence number for each activity.

No Activity Turn on this switch if no field activity should be generated for the condition.

Disconnect Location this is not applicable when Service Order Management is being used.

Activity Type Define the type of field activity request to be generated. You should take care to ensure that the activity type is defined as valid for the SP type (on the last page).

Where Used

Refer to the following sections for information about where each template is used.

Field Activity Requests Initiated To Start Service

Use the customer event Start to define the field activity request(s) used to start service at a service point whose SP type references this profile.

Description of Page

See [Field Activity Type Profile - Template](#) for a description of the fields.

Where Used

The start service process uses this information to determine the type of field activity requests to create to start service at a service point.

WARNING:

Warning. Field activity requests will only be created for starts if you have defined the appropriate field work creation algorithm on the service agreement's SA type. Refer to [SA Type - Algorithms](#) for more information.

Field Activity Requests Initiated To Stop Service

Use the customer event Stop to define the field activity request(s) used to stop service at a service point whose SP type uses this profile.

Description of Page

See [Field Activity Type Profile - Template](#) for a description of the fields.

Where Used

The stop service process uses this information to determine the type of field activity requests to create to stop service at a service point.

WARNING:

Warning. Field activity requests will only be created for stops if you have defined the appropriate field work creation algorithm on the service agreement's SA type. Refer to [SA Type - Algorithms](#) for more information.

Field Activity Requests Initiated For Back-to-Back Service

Use the customer event Start/Stop to define the field activity request(s) used to stop service for one customer and start service for another at a service point whose SP type uses this profile.

NOTE:

Terminology. We use the term **back-to-back** to describe the situation when a single field activity request supports both the stop and start service requests. The system sets up a back-to-back situation by default when it is aware of both the start and stop customers at a premise.

Description of Page

See [Field Activity Type Profile - Template](#) for a description of the fields.

Where Used

The start/stop service process uses this information to determine the type of field activity requests to create to start service at a service point.

Field Activity Requests Initiated To Cut Service Due To Non-Payment

Use the customer event Cut for Non-Payment to define the field activity request(s) used to cut service at a service point whose SP type uses this profile.

Description of Page

See [Field Activity Type Profile - Template](#) for a description of the fields.

Where Used

Severance and cut events use this information to determine the type of field activity requests to create to cut service at a service point.

Field Activity Requests Initiated To Place A Disconnect Warning At A Service Point

Use the customer event Disconnect Warning to define the field activity request(s) used to place a disconnect warning at a service point whose SP type uses this profile.

Description of Page

See [Field Activity Type Profile - Template](#) for a description of the fields.

Where Used

Severance and cut events use this information to determine the type of field activity requests to create to leave a disconnect warning at a service point.

Field Activity Requests Initiated To Reconnect Service At A Service Point

Use the customer event Reconnect for Payment to define the field activity request(s) used to reconnect service (after being cut) at a service point whose SP type uses this profile.

Description of Page

See [Field Activity Type Profile - Template](#) for a description of the fields.

Where Used

Severance and cut events use this information to determine the type of field activity requests to create to reconnect service at a service point.

Field Activity Requests Initiated To Reread A Meter At A Service Point

This template is not applicable when Service Order Management is being used.

Defining A Profile's Valid Field Activity Types

Description of Page

The **Field Activity Type** collection shows the field activity requests that may be created for at service points whose SP type references the field activity type profile.

Where Used

This information is used to control the types of field activity requests that may be created for at a service point.

Setting Up Fieldwork Cancellation Reasons

Description of Page

Enter a **Cancel Reason** and **Description** for every field activity request cancellation reason.

Only use **System Default** on those reason codes that are placed on field activity requests that are automatically canceled by the system. The following table lists the valid values and the condition where this cancel reason is used.

System Default	System Condition
Cut Process canceled	Placed on field activity requests that are canceled when a Cut Process is canceled.
SA Start/Stop canceled	Placed on field activity requests that are canceled when a pending start/stop is canceled.
Severance Process canceled	Placed on field activity requests that are canceled when a severance process is canceled .

NOTE:

Required values. You must have one reason code defined for each of the System Default values that corresponds to an event that may occur in your implementation.

Setting Up Field Activity Remarks

NOTE: Field work remarks are typically processed by Service Order Management; therefore, field activity request remarks are not required.

Description of Page

Enter a unique **Field Activity Remark** and a **Description** for every field activity request remark.

Turn on **Eligible for Processing** if field activity requests marked with a given remark code should cause one or more algorithm to execute.

The grid contains **Algorithms** associated with the field activity request remark. You must define the following for each algorithm:

- Specify the **System Event** with which the algorithm is associated (see the table that follows for a description of all possible events).
- Specify the **Sequence Number** and **Algorithm** for each system event. You can set the **Sequence Number** to 10 unless you have a **System Event** that has multiple **Algorithms**. In this case, you need to tell the system the **Sequence** in which they should execute.

The following table describes each **System Event**.

System Event	Optional / Required	Description
--------------	---------------------	-------------

Setting Up Outage Call Types

When you create an outage call, you must supply an outage call type. Outage call types contain a great deal of information that is defaulted onto the outage call, including the outage category group codes or trouble codes. To set up outage call types, open **Admin > Field Work > Outage Call Type > Add**.

FASTPATH:

Refer to [The Big Picture of Outage Care Integration](#) for more information about how trouble calls are created and sent to NMS

The topics in this section describe the base-package zones that appear on the Outage Call Type portal.

Outage Call Type List

The Outage Call Type [List zone](#) lists every outage call type, i.e. every service task type that has a service task type class of Outage Call. The following functions are available:

- Click a [broadcast](#) button to open other zones that contain more information about the adjacent outage call type.
- Click the Add link in the zone's title bar to add a new outage call type.

Outage Call Type

The Outage Call Type zone contains display-only information about an outage call type. This zone appears when an outage call type has been broadcast from the Outage Call Type [List zone](#) or if this portal is opened via a drill down from another page. The following functions are available:

- **Edit:** to start a business process that updates the outage call type.
- **Delete:** start a business process that deletes the outage call type.
- **Duplicate:** to start a business process that duplicates the outage call type.

Please see the zone's help text for information about this zone's fields.

Setting Up Service Call Communication Types

A Service Call Communication Type defines the rules and controls for creating service call communications.

Refer to [Asset Management System Integration](#) for more information.

To set up service call communication types, open **Admin > Field Work > Service Call Communication Type > Search**.

This is a standard [All-In-One Portal](#).

The information captured on the service call communication type depends on the business objects that your implementation supports. Refer to the embedded help text for more information.

Setting Up Service Categories

A service category represents a broad category of services.

Refer to [Asset Management System Integration](#) for more information.

To set up service categories, open **Admin > Field Work > Service Category — CCB > Search**.

This is a standard [All-In-One Portal](#).

The information captured on the service category depends on the business objects that your implementation supports. Refer to the embedded help text for more information.

Setting Up Service Codes

Service Codes are used to create the appropriate work record from the service call

Refer to [Asset Management System Integration](#) for more information.

To set up service codes, open **Admin > Field Work > Service Code — CCB > Search**.

This is a standard [All-In-One Portal](#).

The information captured on the service code depends on the business objects that your implementation supports. Refer to the embedded help text for more information.

Service Order Management External Applications

The external systems used with Service Order Management must be defined as External Applications using the "External Application" (D1-ExternalApplication) business object. Examples of external systems can include:

- A customer information system (such as Oracle Utilities Customer Care and Billing)
- A field work system
- An asset management system (such as Oracle Utilities Operational Device Management or Oracle Utilities Work and Asset Management)

Information defined for external system service providers used by Service Order Management include:

- **Our Name/ID in Their System:** This is the value that the field work system uses to identify our system.
- **Utility Device ID Type:** This is the Device ID Type that will be used when communicating with the external application and it will be the assumed Device ID Type for any device identifiers sent from the external application.
- **Utility Service Point ID Type:** This is the Service Point ID Type that will be used when communicating with the external application and it will be the assumed Service Point ID Type for any service point identifiers sent from the external application.

Refer to [Understanding External Applications](#) and [Configuring External Applications](#) for more information about external applications.

Processing Roles

The external application's processing roles define how data relevant to the field work system is sent and/or created.

Field work service providers can use the following processing roles:

- **Activity Notification:** Used to send notifications to subscribing and/or requesting systems about the status of orchestration and/or service order field activities.
- **Appointment Request:** Used to send a request for an appointment to the field work system.
- **Cancelation Activity:** Used to send notifications to requesting systems when canceling orchestration and/or service order field activities.
- **Collection Details:** Used to retrieve details about collections processing (used with "Cut Service for Non-Payment" and "Restore Service for Payment" orchestration activities).
- **Customer Contact:** Used to send a contact to a customer regarding a service request
- **Field Activity:** Used to send a service order field activity to the field work system.
- **Field Activity Completion:** Used to send a notification regarding completion of a service order field activity.
- **Interim Status Update:** Used to send updates regarding the status of orchestration and service order field activities to requesting systems.
- **Meter Exchange Mapping:** Used to define how to define different types of meter exchanges based specific roles and device configurations. This can provide context to field crews to help ensure they install the correct type of device and device configuration when exchanging a meter.
- **Response - Appointment:** Used to send a request for an appointment to the field work system.
- **Response - Fail:** Used to send a response to an external system when Service Order Management fails to respond.
- **Response - Missed Appointment:** Used to send a response to the field work system when notification of a missed appointment is received.
- **Response - Negative Acknowledgement:** Used to send a negative acknowledgement response to an external system in the event that a request is rejected.
- **Response - Received:** Used to send a response to an external system to acknowledge receipt of a request.
- **Response - Success:** Used to send a response to an external system when Service Order Management successfully processes a request.
- **Send Field Activity Remark:** Used to send a service order field activity remark to a subscribing system
- **Update Activity:** Used to send notifications to requesting systems when updating orchestration and/or service order field activities.

Service Order Activities

Understanding Service Order Activities

This section describes service order activities and how they manage the service order process.

Service order activities coordinate a large number of child transactions that represent the communication to and from an external application. The below diagram depicts a service order activity:

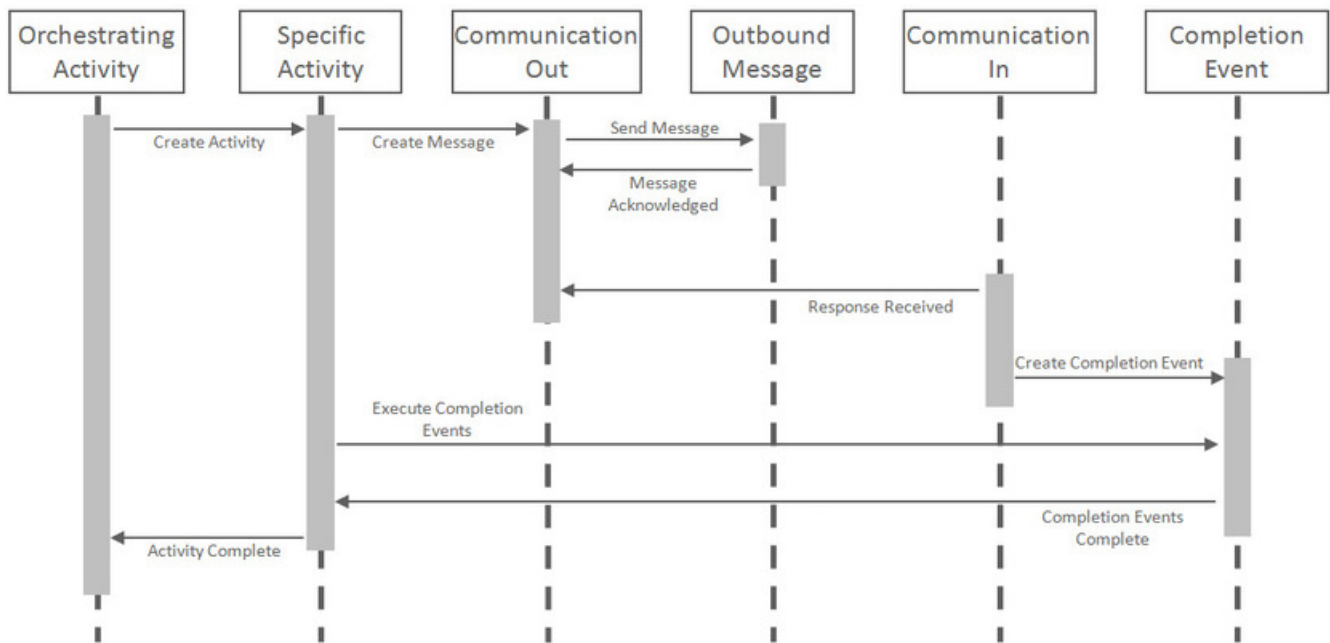

Each object in the sequence diagram has a distinct set of duties within the context of the communication:

- **Orchestrating Activity:** controls the overall intent of the communication. For example it may "Enable Service" which would include initiating one-to-many specific activities to install the meter and begin the flow of the metered commodity to the service point.
- **Specific Activity:** can be initiated from an orchestrating activity or directly. These activities represent a single task to be carried out such as installing a meter or a remote disconnect smart meter command.
- **Communication Out:** orchestrates the communication to the external application and provides robust handling for any errors that might occur during that communication.
- **Outbound Message:** represents the message payload sent to the external system and the synchronous response.
- **Communication In:** orchestrates the handling of an asynchronous or unsolicited response from an external system.
- **Completion Event:** carries out the results of the communication. For example, in the case of a remote connect it would create the appropriate on off history entry for the device's installation event.

The base package provides the following types of service order activities:

- **Enable Service:** Used to enable service at a service point.
- **Disable Service:** Used to disable service at a service point.
- **Cut for Non-Payment:** Used to cut off service at a service point due to non-payment of past due amounts.
- **Reconnect Service for Payment:** Used to restore service at a service point after receipt of past due payment.
- **Exchange Meter:** Used to orchestrate the exchange of meters at service point, such as in the event that a customer upgrades their meter.
- **Back to Back Service:** Used to orchestrate a change of service when the customer at a service point changes (such as when owners/tenants change).

Service Order Activity Processing

To understand how service order activities manage the service order process, it's important understand the lifecycle of orchestration activity business objects.

Service Order Orchestration Activity Lifecycle

All service order orchestration activity business objects share a common parent business object that defines their lifecycles. This is the Service Point Activity Orchestration business object (DI-SPActivityOrchestration). The table below outlines the lifecycle for this business object.

State	Description
Pending	<p>The initial state for orchestration activities.</p> <p>An Enter algorithm sends an acknowledgement to the requesting system.</p> <p>The activity is transitioned to the next state via a monitor process.</p>
Validate	<p>Enter algorithms perform the following:</p> <p>Validate Activity Type</p> <p>Validate Service Point</p> <p>Check for a non-final duplicate service order request activity for the same service point.</p>
Validation Error	<p>If the business object fails any of the validations in the Pending state, it enters this state.</p> <p>Activities in this state can be corrected and retried.</p>
Discarded	<p>Activities discarded in other states enter this state.</p> <p>Enter algorithms perform the following:</p> <p>Validate that non-final child activities can be discarded without the need for a cancel activity</p> <p>Cancel non-final child activities</p> <p>Send a failure notification to the requesting system</p>
Waiting for Effective Date	<p>If an orchestration activity has a future effective date, it remains in this state until the effective date is reached.</p> <p>A Monitor algorithm transitions the activity to the next state when the activity's effective date time is reached (process date time >= effective date time).</p>
Are SP and Device Ready?	<p>Each type of orchestration activity business object has a unique set of Enter algorithms that perform operations as appropriate for the type of service order request.</p> <p>See Service Order Activity Algorithm Types for more information about these algorithms.</p>
Activity in Progress	<p>Orchestration activities remain in this state while their child activities are processed.</p> <p>A Monitor algorithm transitions the activity to the "Are the SP and Device Ready?" state if there are no non-final child activities related to the current activity.</p> <p>A Monitor algorithm validates that the orchestration activity has not been in its current state for too long, based on the Expiration Days parameter on the orchestration activity's type and the Expiration Date/Time on the orchestration activity</p> <p>An Exit algorithm resets the Expiration Date/Time on the orchestration activity such that each time the activity exits this state its Expiration Date/Time is updated.</p>
Activity Error	<p>If one or more child activities enters an Error state, the orchestration activity enters this state.</p> <p>Activities in this state can be corrected and retried.</p>
Retry	<p>When an orchestration activity is retried after correction of an error condition, it enters this state.</p> <p>Enter algorithms perform the following:</p> <p>Check to determine if there are child field activities in progress that have outbound communications awaiting a response.</p> <p>Transition any non-final child activity to the "Reject" state (the state defined as "Reject" on the child activity business object lifecycle. This is most often the "Discarded" state).</p>

State	Description
Completed	Orchestration activities enter this state when all child activities have successfully completed. An Enter algorithm send a success notification to the requesting system.

Use the Business Object and Algorithm portals to view additional details about this business object and its lifecycle algorithms.

Cancel / Update Orchestration Lifecycle

The Cancel Orchestration (D1-CancelOrchestration) and Update Orchestration (D1-UpdateOrchestration) business objects have a similar lifecycle, with the following exceptions:

- There is no "Waiting for Effective Date" state.
- In place of the "Are SP and Device Ready?" state, they have "Cancel Specific Activity" / "Update Specific Activity" states. Enter algorithms on these states attempt to cancel or update a specific child activity.
- In the place of "Activity In Progress" and "Activity Error" states, they have "Communication in Progress" and "Communication in Error" states.

Use the Business Object and Algorithm portals to view additional details about this business object and its lifecycle algorithms.

Throttling Commands Issued from Service Order Activities

Service order management can be configured to limit, or "throttle", the number of smart meter command activities initiated by a service order activity that are executed within a specified time range. For example, in a situation in which a utility initiates dozens (or hundreds) of cut for on-payment service activities on a single day, this feature allows the execution of the related remote disconnect commands to be spread out over a number of hours rather than executing all of those commands in the first hour of the day.

NOTE: Throttling is only supported for Cut Service for Non-Payment service order activities and Remote Disconnect smart meter command activities.

Configuring throttling of command processing is done via parameters on the service order activity type and the related smart meter command activity type.

Service Order Activity Type

The following **Business Hours** parameters on the Cut Service for Non-Payment activity type are used to define the business days and hours during which remote disconnect commands can be executed:

- **Ensure Business Hours:** Indicates if commands should be processed during specified business hours as defined by the **Work Calendar**, **Start Hour**, and **End Hour** parameters.
- **Work Calendar:** The work calendar used to determine work days on which commands can be processed.
- **Start Hour:** The start hour of the day during which commands can be processed.
- **End Hour:** The end hour of the day during which commands can be processed.

Refer to the **Business Hours** embedded help on the Cut Service for Non-Payment activity type for more details.

Smart Meter Command Activity Type

The **Throttle Parameters** on the Remote Disconnect activity type are used to define if throttling is enabled, and if so, the number of commands that can be processed during specific time ranges during each business day. These parameters include:

- **Throttle Option:** Specifies if throttling is allowed. If set to "Allowed", one or more time ranges must be defined in the **Schedule** list.
- **Schedule:** Defines one or more time ranges (defined by the **From** and **To** columns) and the number of records that can be processed during each (defined by the **Number of Requests** column).

Batch Processing

Processing of commands configured for throttling is performed using the Command Request Wait Monitor with Throttle Option batch control (D1-CRWTO).

This batch control monitors command activities in the "Wait For Effective Date/Time" state, and if the Throttle Option parameter (enableThrottle) is set to "Y", it will only process up to the number of records specified in the current time range defined in the **Schedule** section on the command activity type. For example, if there are 50 Remote Disconnect commands in the "Wait For Effective Date/Time" state and this batch control (with **Throttle Option** set to "Y") is run during a time range for which the **Number of Requests** is set to 30, only 30 of the commands will be transitioned to the Connection Ready state.

This batch control can be used for all commands, with the **Throttle Option** parameter set as appropriate based on the type of command activities. As of this release, throttling is only available with Remote Disconnect smart meter command activities.

Notes:

- This batch control can be used only with command activity business objects whose "Wait For Effective Date/Time" state does NOT have a monitor process defined.
- If this batch control is run more than once during a specific time range, it will process up to the number of records specified for that time range during each run. In the previous example, if the batch control were to be run twice during the same time range, the first run would process 30 records, and the second would process the remaining 20 records.

See the **Detailed Description** of this batch control for more information.

Service Order Activity Algorithm Types

When an orchestration activity enters the "Are SP and Device Ready?" state, a set of Enter algorithms are used to evaluate the state of the service point / meter / item to determine which actions are required to complete the service request. These algorithms are based on the following algorithm types.

Customer-Device Compatibility Check (D1-DVCOMCHK)

Algorithms of this type execute the "Customer-Device Compatibility Algorithm" defined on the orchestration activity's activity type. Algorithms of this type uses the following parameters:

- **Activity BO To Create If Compatibility Detected:** Specifies the activity business object to instantiate if the algorithm detects an in compatibility between the customer/service point and device.

Note: The base package does not include algorithm types for the "Activity Type - Customer Device Compatibility" algorithm entity.

Connect Only If Previously Connected (D1-CONPRECON)

Algorithms of this type check if the "Connect New Device" flag has a value. If the flag is not populated, the algorithm sets the value of the flag based on the connection status of the device prior to the meter exchange (used only with Meter Exchange requests).

For additional information, refer to the D1-CONPRECON Algorithm Type.

Create Meter Exchange Field Activity (D1-CREMTREXC)

Algorithms of this type create a service order field activity based on details provided in the algorithm's parameters. Algorithms of this type uses the following parameters:

- **Activity and Specific Field Task to Create:** Specifies the type of activity business object and field task type to create for meter exchange service order field activities, as defined by the following mnemonics:

Mnemonic	Description
activityBOToCreate	Specifies the activity business object to create.
specificFieldTask	Specifies the Field Task Type when creating a service order field activity. This value comes from the Field Task Type extendable lookup.

For example, to create a service order field activity based on the D1-FieldActivity business object and the Exchange Meter field task type, these mnemonics would be configured as follows:

```
activityBOToCreate=D1-FieldActivity specificFieldTask=D1-ExchangeMeter
```

For additional information, refer to the D1-CREMTREXC Algorithm Type.

Decommission Removed Meter (D1-DCRMMTR)

Algorithms of this type create a decommissioning command for a removed meter (used only with Meter Exchange requests). Algorithms of this type uses the following parameters:

- **Decommission Activity BO to be created:** Specifies the type of activity business object to create when decommissioning a meter. The specific activity is created, as defined by the following mnemonics:

Mnemonic	Description
activityBOToCreate	Specifies the activity business object to create.

For example, to create a smart meter command activity based on the D1-DeviceDecommission business object, this parameter would be configured as follows:

```
activityBOToCreate=D1-DeviceDecommission
```

For additional information, refer to the D1-DCRMMTR Algorithm Type.

Create Specific Activity (D1-CRSPACT)

Algorithms of this type determine if a specific activity needs to be created based on the state of the service point. Algorithms of this type use the following parameters to specify the conditions and activity to be created:

- **Field Activity BO:** Specifies the field activity business object to instantiate if the algorithm creates a field task type (see next parameter).
- **SP State and Activity BO to Create:** Specifies the type of activity business object to create based on the state of the service point. This parameter can be repeated up to 20 times. Instances of the parameter are evaluated one at a time and the first condition matching the state of the service point is used. Parameters should be ordered from the most restrictive condition to the least restrictive. This parameters uses the following mnemonics to indicate the state (any combination of the following) of the service point:

Mnemonic	Description
servicePointConnected	Specifies if the service point is currently connected Valid values are "true" and "false".
disconnectLocation	Specifies the "Disconnect Location" for the service point.

Mnemonic	Description
	Valid values are "D1SR" (source) and "D1DV" (device).
deviceInstalledAtSP	Specifies if there is a device currently installed at the service point. Valid values are "true" and "false".
installationEventStatusOverride	Specifies the value of the "Installation Status" option type of the Install Event's Status ("Pending", "Conn-PreComm", "ManualOff", etc.)

Based on the unique combination of these mnemonics, a specific activity is created, as defined by the following mnemonics:

Mnemonic	Description
activityBOToCreate	Specifies the activity business object to create (used most often to specify a command business object)
specificFieldTask	Specifies the field task type when creating a service order field activity. This value comes from the Field Task Type extendable lookup. Note: If this mnemonic is specified, the "Field Activity BO" parameter should specify the field activity business object to create.
spTypeCategory	Specifies a service point type category. Valid values include "D1MT" (meter), "D1IT" (item), "D1MI" (multi-item), from the SP_CATEGORY_FLG lookup. Specifying this mnemonic indicates that a service order field activity should be created only if the service point's category match the one specified by this mnemonic.
executeOverrideAlgorithm	Specifies whether or not to execute the algorithm specified for the Override Device/Task Algorithm on the service order orchestration activity type. This allows the activity business object to create to be dynamically determined based on an algorithm instead of the "activityBOToCreate" or "specificFieldTask" mnemonics. Valid values are "true" and "false".

For example, the following parameter configuration would create a "Connect Service Point and Install Meter" service order field activity given the following conditions:

- Service Point Connected: False
- Disconnect Location: Source
- Device Installed at Service Point: False
- Service Point Category: Meter

```
servicePointConnected=false disconnectLocation=D1SR deviceInstalledAtSP=false specificFieldTask=D1-ConnSPAtSrceAndInstMtr spTypeCategory=D1MT
```

NOTE: Additional values for the **SP State and Activity BO to Create** parameter can be defined using the **Field Task By Service Point Condition** zone on the [Activity Type](#) portal.

For additional information, refer to the D1-CRSPACT Algorithm Type.

Update Device (D1-UPDDVC)

Algorithms of this type determine if an activity needs to be created to update the device based on the state of the service point and device installed at the service point. Algorithms of this type use the following parameters to specify the conditions and activity to be created.

- **Error if SP Not Connected or no Device Installed (Default is Yes):** Indicates if the algorithm should return an error if the service point is not connected or if a device is not currently installed. Valid values are "Yes" and "Con" (continue)
- **SP State and Activity BO to Create:** Specifies the type of activity business object to create based on the state of the service point. This parameter can be repeated up to 20 times. Instances of the parameter are evaluated one at a time and the first condition matching the state of the service point is used. Parameters should be ordered from the most restrictive condition to the least restrictive. This parameters uses the following mnemonic to indicate the state (any combination of the following) of the service point:

Mnemonic	Description
installationEventStatusOverride	Specifies the value of the "Installation Status" option type of the Install Event's Status ("Pending", "Conn-PreComm", "ManualOff", etc.)

Based on the value of this mnemonic, a specific activity is created, as defined by the following mnemonics:

Mnemonic	Description
activityBOToCreate	Specifies the activity business object to create (used most often to specify a command business object)
specificFieldTask	Specifies the Field Task Type when creating a service order field activity. This value comes from the Field Task Type extendable lookup. Note: If this mnemonic is specified, the "Field Activity BO" parameter should specify the field activity business object to create.
spTypeCategory	Specifies a service point type category. Valid values in include "D1MT" (meter), "D1IT" (item), "D1MI" (multi-item), from the SP_CATEGORY_FLG lookup. Specifying this mnemonic indicates that a service order field activity should be created only if the service point's category match the one specified by this mnemonic.
alternativeFieldTask	Specifies an alternative Field Task Type to use when creating a service order field activity in the event that the device does not support the command indicated by the "activityBOToCreate" mnemonic. Note: If this mnemonic is specified, the "Field Activity BO" parameter should specify the field activity business object to create. A value of 'skip' will continue the evaluation of the algorithm's next parameter

For example, the following parameter configuration would create a "Turn On Meter" service order field activity given the following conditions:

- Installation Status: Manual Off

- Service Point Category: Meter

```
installEventStatusOverride=ManualOff specificFieldTask=D1-TurnOnMeter spTypeCategory=D1MT
```

NOTE: Additional values for the **SP State and Activity BO to Create** parameter can be defined using the **Field Task By Device Condition** zone on the [Activity Type](#) portal.

Other parameters used by algorithms of this type include:

- **Field Activity BO:** Specifies the field activity business object to instantiate if the algorithm creates a field task type (see above parameter).
- **XPath of Activity Element controlling Activity creation:** Defines an element within the activity business object schema that can be used to control whether or not this algorithm should create an activity. For example, to specify that the value of the "Connect New Device" flag be used to determine whether or not the algorithm should create an activity, this parameter could be set to "connectNewDevice".
- **Element value indication that Activity creation should not proceed:** Specifies a value for the element defined in the "XPath of Activity Element controlling Activity creation" parameter that would indicate that the algorithm should not create an activity. Valid values are based on the element defined for the "XPath of Activity Element controlling Activity creation" parameter. For example, to specify that an activity should not be created if the "Connect New Device" flag is set to "Do Not Connect / Turn On", this parameter should be set to "D1NC" (from the D1_CONNECT_NEW_DEVICE_FLG lookup).

For additional information, refer to the D1-UPDDVC Algorithm Type.

Remote Turn Off Turn On (D1-REMONOFF)

Algorithms of this type remotely turn a device off and on for a Back to Back service request. Algorithms of this type use the following parameters:

- **Device Incompatibility Detected Activity BO:** Specifies the activity business object the algorithm will look for. If the algorithm finds an activity of this business object, the algorithm terminates.
- **Remote Connect BO:** Specifies the activity business object to instantiate when creating a remote connect command.
- **Remote Disconnect BO:** Specifies the activity business object to instantiate when creating a remote disconnect command.
- **Installation Event Status Override for Connect:** The override status to which the Installation Event Status is set after performing a remote connect command.
- **Installation Event Status Override for Disconnect:** The override status to which the Installation Event Status is set after performing a remote disconnect command.

For additional information, refer to the D1-REMONOFF Algorithm Type.

Check for Measurement (D1-CHKMSMT)

Algorithms of this type determine if measurements exist on activity's service point as of the service date/time. If no measurement is found, algorithms of this type create an activity to either obtain or wait for a measurement. The specific type of activity is based on the type and configuration of the device and service point. Algorithms of this type use the following parameters:

- **Activity BO To Wait For Measurement:** Specifies the activity business object to instantiate when the algorithm logic indicates it should wait for a measurement for the service point.
- **Activity BO For Field Read:** Specifies the field activity business object to instantiate when the algorithm logic indicates it should request a meter reading from the field.
- **Specific Field Task:** Specifies the field task type when creating a service order field activity for a meter reading from the field.

- **Activity BO To Wait For Scheduled Read:** Specifies the activity business object to instantiate when the algorithm logic indicates it should wait for a scheduled read for the service point.
- **Activity BO For On Demand Read - Scalar:** Specifies the activity business object to instantiate when the algorithm logic indicates it should issue an on-demand read (scalar) smart meter command.
- **Start Range for Normal Measurement Condition:** The start of the range of conditions that indicate "normal" measurements when the algorithm is searching for measurements for the service point.
- **End Range for Normal Measurement Condition:** The end of the range of conditions that indicate "normal" measurements when the algorithm is searching for measurements for the service point.
- **Minimum Range for bottom Measurement condition:** The minimum measurement condition used when searching for measurements for the service point. Used only when no measurements are found in the "normal" range defined by the "Start/End Range Normal Measurement Condition" parameters.

The following parameters on the orchestration activity type are also used by algorithms of this type when searching for measurements for the service point:

- **Look for Measurement within the Day:** Limits the search to the reference date (the service date).
- **Minimum and Maximum Offset Number of Days:** Numbers of days added to /subtracted from the reference date to expand the search period.

For additional information, refer to the D1-CHKMSMT Algorithm Type.

Algorithm Types and Orchestration Activity Business Objects

Each of the orchestration activity business objects uses a different set of these algorithm types. The table below lists which of these algorithm types are defined for each of the service order orchestration activity business objects.

	Enable Service	Disable Service	Cut for Non-Payment	Reconnect for Payment	Meter Exchange	Back-to-Back
Customer-Device Compatibility Check	X					X
Connect Only If Previously Connected					X	
Create Specific Activity	X					
Create Meter Exchange Field Activity					X	
Update Device	X	X	X	X	X	X
Remote Turn Off Turn On						X
Decommission Removed Meter					X	
Check For Measurement:	X	X	X			X

Cancel / Update Orchestration - Algorithm Types

Enter algorithms on the "Cancel Specific Activity" and "Update Specific Activity" states attempt to cancel or update a specific child activity. These algorithms are based on the following algorithm types.

- **Cancel Specific Activity:** Algorithms of this type cancel the specific activity (either a service order field activity or a smart meter command) that is associated to the Cancel or Update orchestration activity, based on the current status of the specific activity.

- **Update Specific Activity:** Algorithms of this type update the specific activity (either a service order field activity or a smart meter command) that is associated to the Cancel or Update orchestration activity, based on the current status of the specific activity.

Algorithm Type	Algorithm(s)
Cancel Specific Activity (D1-CANSPACT)	Cancel Specific Activity (D1-CANSPACT)
Update Specific Activity (D1-UPDSPAC)	Update Specific Activity (D1-UPDSPAC)

Use the Algorithm Type and Algorithm portals to view additional details about these algorithms.

Understanding Service Order Field Activity Types

Service order activity types must be configured for each type of service order activity.

Service order activity types are assigned to the following Activity Type Categories:

Service Order Activity	Activity Type Category
Back-to-Back	Service Request Orchestration
Cancel Orchestration	Orchestration Maintenance
Cut Service for Non-Payment	Request Orchestration
Disable Service	Request Orchestration
Enable Service	Request Orchestration
Exchange Meter	Request Orchestration
Reconnect Service for Payment	Request Orchestration
Update Orchestration	Orchestration Maintenance

Refer to [Understanding Activity Types](#) for more information about activity types.

Configuring Service Order Activity Types

You use the **SOM Activity Type** portal is to view and maintain service order activity types.

Refer to [Understanding Activity Types](#) for more information.

You can access the portal by selecting **Admin, Communication, SOM Activity Type**.

NOTE: If the **Restrict Division** setting in the **Control by Division** section in the MDM Master Configuration is set to "Yes", this zone displays only unsecured service order activity types as well as service order activity types with a Division (or Divisions) associated with the user on the **User Miscellaneous Information** zone on the **Miscellaneous** tab of the **User** portal.

The following zones may appear as part of the portal's **Main** tab page:

- **Activity Type List:** This zone works differently than the typical zone that list types in that it displays both those activity types that have been configured as well as those activity types that have yet to be configured. Broadcast a record to display the details of the selected record.
- **Activity Type:** This zone provides information about the selected Activity Type
- **Activity Type List:** This zone works differently than the typical zone that list types in that it displays both those activity types that have been configured as well as those activity types that have yet to be configured. Broadcast a record to display the details of the selected record.
- **Activity Type:** This zone provides information about the selected Activity Type

- **Field Task By Device Condition:** This zone is used to configure field tasks such as Turn On Device or Turn Off Device, based on the device condition. The configurations defined in this zone are used by the **SP State and Activity BO to Create** parameter for algorithms based on the [Update Device \(D1-UPDDVC\)](#) algorithm type. This allows the **SP State and Activity BO to Create** parameter to be defined more than the 20 times allowed on the algorithm. Note that configurations defined in this zone can also include **Service Point Type**.

NOTE: If the **Restrict Division** setting in the **Control by Division** section in the MDM Master Configuration is set to "Yes", only service point types available to the user (based on division), and only field task types considered valid for the service point type can be defined in this zone.

- **Field Task By Service Point Condition:** This zone is used to configure field tasks such as “Install Device” or “Connect SP”, based the service point condition. The configurations defined in this zone are used by the **SP State and Activity BO to Create** parameter for algorithms based on the [Create Specific Activity \(D1-CRSPACT\)](#) algorithm type. This allows the **SP State and Activity BO to Create** parameter to be defined more than the 20 times allowed on the algorithm. Note that configurations defined in this zone can also include **Service Point Type**.

NOTE: If the **Restrict Division** setting in the **Control by Division** section in the MDM Master Configuration is set to "Yes", only service point types available to the user (based on division), and only field task types considered valid for the service point type can be defined in this zone.

Service Order Management Configuration

The following table outlines the activity types that must be configured for the service order activity types supported by Service Order Management:

Service Order Activity	Activity Type (Business Object)
Enable Service	Enable Service (D1-EnableServiceType)
Disable Service	Disable Service (D1-DisableServiceType)
Cut Service for Non-Payment	Cut Service for Non-Payment (D1-CutServiceForNonPaymentType)
Reconnect Service for Payment	Reconnect for Payment (D1-ReconnectForPaymentType)
Meter Exchange	Exchange Meter (D1-ExchangeMeterType)
Back-to-Back Service	Back-to-Back Service (D1-BackToBackServiceType)
Cancel Orchestration	Cancel Orchestration (D1-CancelOrchestrationType)
Update Orchestration	Update Orchestration (D1-UpdateOrchestrationType)

The demonstration database contains examples of each of these service order activity types.

Service Order Field Activities

Understanding Service Order Field Activities

This section describes service order field activities and how they communicate with field work management systems.

Service order field activities are activities that involve sending workers into the field to perform service. This can include meter installation, meter replacement, and other activities.

Service order field activities send messages to a field work system, which in turn assigns them to crews to be completed in the field.

Field Activity Information

All service order field activities are based on the Field Activity (D1-FieldActivity) business object, and include the following user-accessible information:

- **Status:** The current status of the service order field activity.
- **Service Date/Time:** The date and time the service order field activity was created.
- **Service Point:** The service point associated with the service order field activity.
- **Field Task Type:** The field task type for the service order field activity. This defines the type of task and other processing details regarding how Service Order Management processes the service order field activity. See [Field Task Types](#) for more details about field task types.
- **Recipient:** The field work system service provider to which the service order field activity is sent for scheduling and assignment.
- **Device ID:** The device related to the service order field activity (if applicable).
- **Request Information:** Details of the service order request, including requester and external system information.
- **Contact Details (or Customer Information):** Contact details for the customer associated with the service order request.
- **Address Information:** The address of the service point associated with the service order field activity.

The field activity business object also contains other information that is populated by algorithms and scripts as the service order field activity is processed by the system.

How Do Service Order Field Activities Work?

At a high level, service order field activities work as follows:

Create Field Activity

A service order orchestration activity creates a service order field activity based on the current state of the service point/meter/item.

Retrieve Required Data

The service order field activity uses a set of pre-processing algorithms to derive and populate data needed by the activity, such as the device, service point, address, effective date, and others.

Request Appointment (Optional)

If the service order field activity task type specifies that field tasks of this type require an appointment, the service order field activity checks for available appointment slots in the field work system and sends a notification to the appointment handling system.

Create Outbound Communication

The service order field activity creates an outbound communication to send the service order field activity to the field work system. The outbound communication gathers the information required by the field work system before being sent. This information is retrieved by a set of processing scripts defined on the field task type.

Receive Inbound Communication

When the service order field activity has been completed, the field work system sends an inbound communication back to Service Order Management.

Inbound communications can contain Field Activity Remarks (entered by field resources when they perform and complete their field work. If the Field Activity Remarks reference completion events, they are executed.

The inbound communications create completion events as defined on the field task type. If the service order field activity was successfully completed, it creates the "Completion Events When Successful" completion events. If the service order field activity was canceled, it creates the "Completion Events When Canceled" completion events.

Execute Completion Events

After receiving the inbound communication, a service order field activity algorithm transitions any active completion events into their executed state.

Complete Processing

The service order field activity completes its processing by doing the following:

- Updating the parent orchestration activity
- Sending a success response to the requester
- Transitioning the parent orchestration activity to the next state in its lifecycle
- Sending a service order field activity completion outbound communication to subscribing systems.

Service Order Field Activity Processing

This section outlines how service order field activities are processed.

Pre-Processing, Validation, and Post-Processing Algorithms

When service order field activities are first instantiated, a set of pre-processing algorithms populate and derive information needed for the activity, such as the activity type, service point, device, address, effective date, and other information.

Validation algorithms validate this information when first retrieved and when updated.

When service order field activities are completed, a post-processing algorithm populates the activity end date/time.

Service Order Field Activity Lifecycle

As a service order field activity moves through its lifecycle, it triggers various business processes based on the type of service order field activity. The table below outlines the lifecycle for the Field Activity (D1-FieldActivity) business object.

State	Description
Pending	The initial state for service order field activities. An Enter algorithm sends an acknowledgement to the requesting system. The activity is transitioned to the next state via a monitor process.
Validate	Enter algorithms perform the following: Validate Activity Type (and transition to error if invalid) Derive and validate service order field activity recipient Validate duplicate and conflict service order field activities Derive and validate service order field activity service point Derive and validate service order field activity device Validate address constituents Check for any existing cut service restrictions

State	Description
Validation Error	<p>The activity is transitioned to the next state via a monitor process.</p> <p>If the business object fails any of the validations in the Pending state, it enters this state.</p> <p>Enter algorithms perform the following:</p> <p>Create a To Do based on specified To Do Type and To Do Role</p> <p>Set the "Allow Child to Transition Parent Activity" flag to "yes".</p> <p>This allows the service order field activity to transition the parent orchestration activity if needed.</p> <p>Activities in this state can be corrected and retried.</p>
Waiting to Request	<p>If a service order field activity has a future effective date, it remains in this state until the effective date is reached.</p> <p>A Monitor algorithm transitions the activity to the next state when the activity's effective date time is reached (process date time >= effective date time).</p> <p>An Enter algorithm sets the "Allow Child to Transition Parent Activity Based On Effective Date" flag to "yes". This allows the service order field activity to transition the parent orchestration activity if needed.</p>
Waiting for Appointment	<p>If the service order field activity passes its validations and the effective date has been reached, the activity enters this state.</p> <p>Enter algorithms perform the following:</p> <p>Evaluate if an appointment is required for field tasks of this type. If not, the activity transitions to the "Communication in Progress" state.</p> <p>Create a To Do if an appointment is necessary but the system is not able to send an appointment request.</p> <p>Set the "Allow Child to Transition Parent Activity" flag to "yes".</p> <p>This allows the service order field activity to transition the parent orchestration activity if needed.</p> <p>Send a notification to the appointment handling system.</p> <p>Monitor algorithms perform the following:</p> <p>Verify if an appointment has been supplied.</p> <p>Send a notification to the appointment handling system.</p> <p>The activity is transitioned to the next state via a monitor process.</p> <p>See Waiting for Appointment for more information about this state.</p>
Communication in Progress	<p>Service order field activities enter this state following the "Waiting for Appointment" or "Retry" states.</p> <p>Enter algorithms perform the following:</p> <p>Create an outbound communication for the service order field activity (see Communication in Progress for more information).</p> <p>Set the "Allow Child to Transition Parent Activity" flag to "yes".</p> <p>This allows the service order field activity to transition the parent orchestration activity if needed.</p> <p>Monitor algorithms perform the following:</p> <p>Check for existing child communications.</p> <p>Check that the activity hasn't timed out.</p>

State	Description
Discarded	<p>Activities discarded in other states enter this state.</p> <p>Enter algorithms perform the following:</p> <p>Cancel outstanding outbound communications.</p> <p>Cancel outstanding completion events.</p> <p>Populate the cancel reason.</p> <p>Send a failure notification to the requesting system.</p> <p>Transition the parent activity to the "Activity Error" state (see Service Order Orchestration Activity Lifecycle for more information).</p> <p>Check if a Cancel Orchestration activity is required.</p>
Communication Error	<p>If an outbound or inbound communication an Error state, the service order field activity enters this state.</p> <p>Monitor algorithms perform the following:</p> <p>Check that the activity hasn't timed out.</p> <p>Enter algorithms perform the following:</p> <p>Create a To Do based on specified To Do Type and To Do Role.</p> <p>Set the "Allow Child to Transition Parent Activity" flag to "yes". This allows the service order field activity to transition the parent orchestration activity if needed.</p> <p>Activities in this state can be corrected and retried.</p>
Retry	<p>When a service order field activity is retried after correction of an error condition, it enters this state.</p> <p>Enter algorithms perform the following:</p> <p>Check to determine if there are associated outbound communications in progress.</p> <p>Cancel any outstanding outbound communications.</p>
Execute Completion Events	<p>After an inbound communication is received, it enters this state.</p> <p>Enter algorithms perform the following:</p> <p>Executes completion events defined on the field task type (these completion events were initially created by the inbound communication).</p> <p>Evaluates the "Field Activity Completed" flag on the service order field activity. If this is set to "No", the service order field activity is transitioned to the "Canceled In Field" state.</p> <p>The activity is transitioned to the next state via a monitor process.</p> <p>See Execute Completion Events for more information about this state.</p>
Completion Event Error	<p>If an error occurs during completion event processing, the service order field activity enters this state.</p> <p>Monitor algorithms perform the following:</p> <p>Check that the activity hasn't timed out.</p> <p>Enter algorithms perform the following:</p> <p>Create a To Do based on specified To Do Type and To Do Role.</p> <p>Set the "Allow Child to Transition Parent Activity" flag to "yes". This allows the service order field activity to transition the parent orchestration activity if needed.</p>

State	Description
	Activities in this state can be corrected and retried.
Completed	<p>Service order field activities enter this state when all completion events have successfully completed.</p> <p>Enter algorithms perform the following:</p> <p>Update the parent orchestration activity.</p> <p>Send a success response to the requester.</p> <p>Transition the parent orchestration activity to the next state in its lifecycle.</p> <p>Send a service order field activity completion outbound communication to subscribing systems.</p>
Canceled in Field	<p>If the "Field Activity Completed" flag on the field activity is set to "No", the service order field activity enter this state.</p> <p>Enter algorithms perform the following:</p> <p>Send a failed response to the requester.</p> <p>Transition the parent orchestration activity to the "Activity Error" state.</p> <p>Create a To Do to notify users that the service order field activity has been canceled.</p>

Waiting for Appointment

When a service order field activity enters the "Wait for Appointment" state, it first determines if an appointment is necessary for the service order field activity. If not, the activity moves on to the "Communication in Progress" state (see below).

If an appointment request cannot be sent for some reason, the service order field activity creates a To Do item to alert a user to attempt to manually request an appointment. Otherwise, the service order field activity sends an outbound message to the field work system requesting an appointment. based on the appropriate processing role defined on the "Send Notification to Appointment Handling System - Enter" algorithm.

Processing Role	Outbound Communication Business Object
Appointment Response (default)	Send Appointment Response Outbound Message (D1-SendApptRespOutboundMsg)
Used if: An appointment is required and needs to be scheduled Appointment has been set	Note: An outbound message must be created based on this business object.

The response from the field work system can be received by creating an Inbound Web Service that references the "Book selected appointment to Field Activity" (D1-BookAppt) service script.

While in this state, monitor algorithms verify if an appointment has been supplied and send notifications to the field work system.

Communication in Progress

Service order field activity communications are records of messages sent between Service Order Management and an external field work system. Communications can flow both outbound and inbound.

See [Service Order Field Activity Communication](#) for more information about service order field activity communication.

Manually Completing Service Order Field Activities

Service order field activities in the "Communication in Progress" state can be manually completed or canceled by clicking **Complete** in the **Record Actions** section of the **Activity** zone. This opens the **Field Activity Manual Completion** page where the user can enter appropriate details to manually complete the field activity (such as completion information, service point information, device information, and so on). When submitted, this page creates an inbound communication and transitions the field activity to the next state as appropriate.

Note: Implementations can define custom service scripts for each field task type in the **Manual FA Completion Controls** section on the Field Task Type extendable lookup to customize the sections displayed on the **Field Activity Manual Completion** page.

Execute Completion Events

After receiving the inbound communication, the service order field activity enters the "Execute Completion Events" state.

The inbound communication will have previously created completion events for the service order field activity, based on those defined on the field task type or those referenced by field activity remarks. These creation events begin in the "Pending" state.

An Enter algorithm transitions completion events associated with the service order field activity into their "Executed" state.

Service Order Field Activity Communication

This section outlines how service order field activities communicate with field work systems.

When a service order field activity enters the "Communication in Progress" state, it sends an outbound communication to the field work system, and waits for an inbound communication response.

See **Understanding the Service Order Field Activity Communication Process** below for more information about the role of communications in the service order field activity communication process.

Outbound Communications

Outbound Communications represent messages sent from Service Order Management to an external field work system. Outbound communications use the following types of objects:

Outbound Communication Business Objects

An outbound communication business object exists for each type of message to be sent to an external system. For service order field activities, the following base package outbound communication objects can be used.

Type of Outbound Communication	Outbound Communication Business Object
--------------------------------	--

Initial service order field activity outbound communication	Field Activity Outbound Communication (D1-FieldActivityOBComm)
---	--

Modify outbound communication	Field Activity Outbound Communication (D1-ActivityModifyOBComm)
-------------------------------	---

Used to send an update to a service order field activity previously sent to the field work system.

Outbound Message Types

A outbound message type must also be created for each type of message to be sent to an external system. Again, this is based on the types of messages the system is designed to accept. For service order field activities, the following outbound message types are needed:

Type of Outbound Communication	Outbound Message Type
Initial Service Order Field Activity Message	Field Activity Outbound Message
Modify Existing Service Order Field Activity	Modify Field Activity Outbound Message

Refer to the Oracle Utilities Application Framework documentation for more information about outbound message types.

External Systems

You must also create an External System for each external system to which Service Order Management will send messages. Each external system defines a set of outbound message types that will be sent to that system. Each external system outbound message type also specifies the following:

- The processing method used to send the message (Batch, XAI, or Real-time)
- Message Sender (if Processing Method is set to Real-time or XAI)
- Batch Control (if Processing Method is set to Batch)
- Message XSL, W3C Schema, and Response XSL (as applicable)

To continue the example above, you might create the following external system:

Outbound Message Type	Processing Method	Batch Control
Field Activity Outbound Message	Batch	Sync Request Monitor (F1-SYNRQ)
Modify Field Activity Outbound Message	Batch	Sync Request Monitor (F1-SYNRQ)

Refer to the Oracle Utilities Application Framework documentation for more information about external systems.

Inbound Communications

Inbound Communications represent messages sent from an external field work system to Service Order Management. Inbound communications are typically sent in response to a service order field activity. Inbound communications use the following types of objects:

Inbound Communication Business Objects

An inbound communication business object must be created for each type of message to be received from an external system. For service order field activities, the following base package inbound communication object can be used.

Inbound Communication Business Object
Field Activity Inbound Communication (D1-FieldActivityIBComm)

Inbound Web Service

You must also create an Inbound Web Service for each type of message to be received from an external system. Inbound web services define the details of how messages are received from an external system, including the inbound communication business object (or business service or service script) to be invoked when the response message is received. As in the case of inbound communication business objects, the set of inbound web services you need to create is based on the types of messages the system is designed to send. To continue the example above, you might create the following inbound web services:

Inbound Web Service	Schema (Inbound Communication Business Object)
Field Activity Inbound Communication	Field Activity Inbound Communication D1-FieldActivityIBComm

Refer to the Oracle Utilities Application Framework documentation for more information about Inbound Web Services.

Field Activity Remarks

Inbound communications can contain activity remarks, which represent notes entered by the field worker as they perform and complete their field work. These can be solely informational, or can reference completion events via the "Remark Processing" section of the Field Activity Remark Type extendable lookup. This allows information sent with the inbound communication to initiate business processing if necessary.

Completion events specified on this extendable lookup are created by the inbound communication, and then executed when the service order field activity enters the "Execute Completion Events" state.

Understanding the Service Order Field Activity Communication Process

This section provides an overview of the communication process that takes place when a service order field activity is initiated. For each step in the process, the table below provides a brief description of the processing that takes place, and lists the specific base package objects used by Service Order Management

Note that the process outlined below has been simplified for illustrative purposes, and does not reference every step performed in this process.

Step	Process	Base Package Objects
1.	An orchestration activity creates a service order field activity as part of its processing. A service order field activity business object is instantiated for the command.	Field Activity Business Object: Field Activity (D1-FieldActivity)
2.	When the service order field activity enters the Communication in Progress state, it creates an outbound communication.	Outbound Communication Business Object: Field Activity Outbound Communication (D1-FieldActivityOBComm)
3.	A Enter algorithm on the "Awaiting Response" state of the outbound communication retrieves information needed by the outbound message to be sent to the field work system based on processing scripts specified on the field task type.	Enter Algorithm: Populate Send Detail for Field Activity (D1-POPSNDDTL)
4.	A Enter algorithm on the "Awaiting Response" state of the outbound communication creates an outbound message.	Enter Algorithm: Create Outbound Message (D1-COUTMSG) Note: An outbound message type for this message is not included in the base package.

Step	Process	Base Package Objects
5.	<p>The outbound message is sent to middleware components via an External System and Batch Control.</p> <p>Middleware components utilize Business Process Execution Language (BPEL).</p>	<p>External System: MWM</p> <p>Batch Control: Sync Request Monitor (F1-SYNRQ)</p>
6.	<p>The middleware converts the outbound message from SOM format into the format used by the field work system, and sends the message to the field work system.</p>	
7.	<p>When the field work system sends a response, the middleware receives the response message from the field work system, and converts it from the format used by the field work system to SOM format and invokes an Inbound Web Service.</p>	<p>Inbound Web Service: D1-FieldActivityIBComm</p>
8.	<p>The Inbound Web Service picks up the message, and creates a corresponding inbound communication.</p> <p>The specific type of inbound communication business object created is determined by the Inbound Web Service.</p>	<p>Inbound Web Service: D1-FieldActivityIBComm</p> <p>Inbound Communication Business Object: Field Activity Inbound Communication (D1-FieldActivityIBComm)</p>
9.	<p>The inbound communication identifies the parent outbound communication.</p>	<p>Outbound Communication Business Object: Field Activity Outbound Communication (D1-FieldActivityOBComm)</p>
10.	<p>The inbound communication creates the completion events defined on the field activity field task type (Successful or Canceled, as appropriate) in the "Pending" state.</p> <p>If the inbound communication contains field activity remarks, it also executes any field activity remark completion events.</p>	<p>Inbound Communication Business Object: Field Activity Inbound Communication</p> <p>D1-FieldActivityIBComm</p>
11.	<p>The inbound communication updates the outbound communication.</p> <p>This update is performed by an Enter algorithm on the "Completed" Status of the inbound communication business object's lifecycle.</p>	<p>Inbound Communication Business Object: Field Activity Inbound Communication</p> <p>D1-FieldActivityIBComm</p> <p>Outbound Communication Business Object: Field Activity Outbound Communication (D1-FieldActivityOBComm)</p>
12.	<p>The outbound communication updates the "Completion Flag" and the original service order field activity business object.</p> <p>This update is performed by an Enter algorithm on the "Completed" Status of the outbound communication business object's lifecycle.</p>	<p>Outbound Communication BO: Initiate Connect Disconnect (D3-InitiateConnectDisconnect)</p> <p>Field Activity Business Object: Field Activity (D1-FieldActivity)</p>

Unrelated Pickup Orders

When field work crews are out performing field work, it's possible that they will encounter other work unrelated to their current task that needs to be done. This type of work can be as simple as trimming a tree whose branches are too close to power lines, or the replacement of a meter for a different customer or service point. These types of task are referred to as "unrelated pickup activities." Crews can either work the field activity or leave it to be assigned to another crew at a later date.

When the crew creates an unrelated pickup activity in the field work system, it is sent to Service Order Management, and a corresponding service order field activity is created in the system.

Unrelated pickup activities can be created via one of the following Inbound Web Services:

- Field Activity Asynchronous Req Inbound (D1-FARequestAsynchronous)
- Field Activity Synchronous Req Inbound (D1-FARequestSynchronous)

Once created, they are processed like any other service order field activity. If the pickup activity was completed in the field before being sent to Service Order Management, it will quickly move through its lifecycle (as no further action is needed) until it reaches the "Completed" state.

Retrieving Service Point Information

If the unrelated pickup activity is customer-related it will require service point information to be created. This information can be queried by the field work crew via the "Field Work Service Point Query" (D1-FieldWorkSPQuery) Inbound web service.

This service uses a set of service point criteria to allow the field crew to search for a service based upon either service point or device information. The service returns a list of service points that is configurable in length. If the number of results is larger than the configured maximum length the service indicates that additional records exist and the crew can request another set of results allowing them to identify the proper service point to associate to the activity.

There are times when an unrelated pick-up activity is identified but the field crew is out-of-coverage (i.e. no network connection) and they will not be able to immediately verify service point information. In this type of situation, the crew can input the service point criteria fields and create the activity, which, when imported into Service Order Management, will attempt to identify the service point based upon the information provided. If the service point can be uniquely identified everything should operate as normal. If the service point cannot be uniquely identified then the service order field activity is set to the error state.

Setting Up Service Order Field Activity Types

Understanding Service Order Field Activity Types

A single service order field activity type must be configured to support communication with external field work systems such as Oracle Utilities Module Workforce Management. Service order activity types are assigned to the "Field Activity" Activity Type Category.

Refer to [Understanding Activity Types](#) for more information about activity types.

Service Order Field Activity Types and Divisions

Service order field activity types can specify a Division, to represent the specific operating company associated with activities of that type. If the **Restrict Division** setting in the **Control by Division** section in the MDM Master Configuration is set to "Yes", users can only access service order activities or service order field activities with a Division (or Divisions) associated with the user on the **User Miscellaneous Information** zone on the **Miscellaneous** tab of the **User** portal.

See [Understanding Divisions](#) for more information about divisions.

Configuring Service Order Field Activity Types

You use the **SOM Activity Type** portal to view and maintain service order field activity types.

Refer to [Understanding Activity Types](#) for more information.

You can access the portal by selecting **Admin, Communication, SOM Activity Type**.

NOTE: If the **Restrict Division** setting in the **Control by Division** section in the MDM Master Configuration is set to "Yes", this zone displays only unsecured service order field activity types as well as service order field activity types with a Division (or Divisions) associated with the user on the **User Miscellaneous Information** zone on the **Miscellaneous** tab of the **User** portal.

The following zones may appear as part of the portal's **Main** tab page:

- **Activity Type List:** This zone works differently than the typical zone that list types in that it displays both those activity types that have been configured as well as those activity types that have yet to be configured. Broadcast a record to display the details of the selected record.
- **Activity Type:** This zone provides information about the selected Activity Type
- **Activity Type List:** This zone works differently than the typical zone that list types in that it displays both those activity types that have been configured as well as those activity types that have yet to be configured. Broadcast a record to display the details of the selected record.
- **Activity Type:** This zone provides information about the selected Activity Type
- **Field Task By Device Condition:** This zone is used to configure field tasks such as Turn On Device or Turn Off Device, based on the device condition. The configurations defined in this zone are used by the **SP State and Activity BO to Create** parameter for algorithms based on the [Update Device \(D1-UPDDVC\)](#) algorithm type. This allows the **SP State and Activity BO to Create** parameter to be defined more than the 20 times allowed on the algorithm. Note that configurations defined in this zone can also include **Service Point Type**.

NOTE: If the **Restrict Division** setting in the **Control by Division** section in the MDM Master Configuration is set to "Yes", only service point types available to the user (based on division), and only field task types considered valid for the service point type can be defined in this zone.

- **Field Task By Service Point Condition:** This zone is used to configure field tasks such as "Install Device" or "Connect SP", based on the service point condition. The configurations defined in this zone are used by the **SP State and Activity BO to Create** parameter for algorithms based on the [Create Specific Activity \(D1-CRSPACT\)](#) algorithm type. This allows the **SP State and Activity BO to Create** parameter to be defined more than the 20 times allowed on the algorithm. Note that configurations defined in this zone can also include **Service Point Type**.

NOTE: If the **Restrict Division** setting in the **Control by Division** section in the MDM Master Configuration is set to "Yes", only service point types available to the user (based on division), and only field task types considered valid for the service point type can be defined in this zone.

Service Order Management Configuration

The following table outlines the activity types that must be configured for the service order field activity type supported by Service Order Management:

Field Activity	Activity Type (Business Object)
Field Activity	Field Activity (D1-FieldActivityType)

The demonstration database contains examples of each of these service order activity types.

Configuring Service Order Field Activity Reschedule Reasons

The Reschedule Reason (D1-RescheduleReasonLookup) extendable lookup can be used to define reasons for rescheduling field activities. Reschedule reasons are captured on field activities, as well as their parent service order activity and an update orchestration activity.

Use the following steps to define service order field activity reschedule reasons:

1. Select **Admin, General, Extendable Lookup** to access the **Extendable Lookup Query** portal.
2. Enter “D1-RescheduleReasonLookup” in the **Business Object** field (or enter “Reschedule Reason” in the **Description** field) and click **Search**.
3. Click the “Reschedule Reason” link in the **Description** column of the search results.
4. Click **Add**, and enter the following details for the reschedule reason (fields not listed below are optional):
 - **Reschedule Reason:** A code used to designate the reschedule reason.
 - **Status:** The status of the reschedule reason.
 - **Description:** A description of the reschedule reason. This is what will appear in **Reschedule Reason** drop-down list on the service order field activity.
5. Click **Save**.

Field Task Types

Understanding Field Task Types

A service order field activity’s field task type defines details about the type of task to be performed and how the system will process the activity.

Field Task Type Information

Field task types are values for the Field Task Type (D1-FieldTaskTypeLookup) extendable lookup. Each field task type value includes the following information:

- **Routing:** Indicates if field tasks of this type can only be performed at a service point. Valid values are "SP Required" and "Pass-Through".
- **Appointment Option:** Indicates if an appointment (via a mobile workforce application) is required or applicable to field tasks of this type. Valid values are "Not Applicable", "Optional", and "Required".
- **Completion Events When Successful:** One or more completion events that are executed upon successful completion of field tasks of this type.
- **Completion Events When Canceled:** One or more completion events that are executed upon cancellation of field tasks of this type.
- **Duplicate Task Type Information:** Defines processing rules for handling potential duplicate field tasks, including:
 - **Allow Duplicates:** Specifies whether or not duplicate field tasks are allowed.
 - **Duplicate Threshold:** A number of hours used to determine if a newly instantiated field task type should be considered a duplicate.
 - **Field Task Types:** A list of one or more field task types that are considered to be duplicates of the field task type.

- **Conflict Task Type Information:** Defines processing rules for handling potentially conflicting field tasks, including:
 - **Allow Conflicts:** Specifies whether or not conflicting field tasks are allowed.
 - **Conflict Threshold:** A number of hours used to determine if a newly instantiated field task type should be considered a conflict.
 - **Field Task Types:** A list of one or more field task types that are considered to conflict with the field task type.
- **Processing Scripts:** Defines one or more processing scripts to extract supplemental information needed by the mobile workforce application to schedule field tasks of this type.
- **Manual FA Completion Controls:** Defines an optional Service Script used to customize the sections displayed on the **Field Activity Manual Completion** page when manually completing service order field activities.

Configuring Field Task Types

Field task types are configured using the extendable lookup portal.

You can access the extendable lookup portal from the **Admin > General > Extendable Lookup**.

Use the **Extendable Lookup Search** zone to search for and select the Field Task Type (D1-FieldTaskTypeLookup) extendable lookup.

The following zones may appear as part of the portal's **Main** tab page:

- **Extendable Lookup List:** This zone displays a list of values for the Field Task Type extendable lookup.
- **Extendable Lookup List:** This zone provides information about the selected value.

Service Order Management Configuration

The following table outlines the field task types that must be configured to support each of the service order activity types supported by Service Order Management:

Service Order Activity	Field Task Types
Enable Service — Meters	Connect SP at Source: D1-ConnectSPAtSource Connect SP at Meter: D1-ConnectSPAtMeter Connect SP at Source and Turn On: D1-ConnectSPAtSourceAndTurnOn Connect SP at Meter and Turn On: D1-ConnectSPAtMeterAndTurnOn Connect SP at Source and Install Meter: D1-ConnSPAtSrceAndInstMtr Connect SP at Meter and Install Meter: D1-ConnSPAtMtrAndInstMtr Install Meter: D1-InstallMeter Turn On Meter: D1-TurnOnMeter
Enable Service — Items	Connect SP at Source: D1-ConnectSPAtSource Item - Connect SP at Device: D1-ConnectSPAtDevice Item - Connect SP at Source and Turn On: D1-ConnSPAtSrceAndTurnOnDvc Item - Connect SP at Device and Turn On: D1-ConnectSPAtDvcAndTurnOn Connect SP at Source and Install Device: D1-ConnSPAtSrceAndInstDvc Connect SP at Device and Install Device: D1-ConnSPAtDvcAndInstDvc Item - Install Device: D1-InstallDevice

Service Order Activity	Field Task Types
	Turn On Item: D1-TurnOnItem
Disable Service — Meters	Turn Off Meter: D1-TurnOffMeter
Disable Service — Items	Turn Off Item: D1-TurnOffItem
Cut Service for Non-Payment — Meters	Cut for Non-Payment: D1-CutForNonPayment
Cut Service for Non-Payment — Items	Item - Cut for Non-Payment: D1-CutItemForNonPayment
Reconnect Service for Payment — Meters	Reconnect for Payment: D1-ReconnectForPayment
Reconnect Service for Payment — Items	Item - Reconnect for Payment: D1-ReconnectItemForPayment
Meter Exchange	Exchange Meter: D1-ExchangeMeter
Item Exchange	Exchange Device: D1-ExchangeDevice
Back-to-Back — Meters	Read Meter: D1-ReadMeter

Defining Credit & Collections Options

NOTE:

The functionality described in this section is meant to handle the collection of unpaid balances. If your organization practices [open-item accounting](#) and collects on unpaid bills, you will not use this functionality. Rather, you will use the functionality described under [Defining Overdue Processing Options](#).

The system periodically monitors how much your customers owe to ensure they haven't violated your collection criteria. When a violation is detected, the system generates the appropriate responses (e.g., letters, disconnect notices, collection agency referrals, and eventually write off). This section describes how to set up the tables that control your credit & collections processing.

WARNING:

Setting up the credit & collections control tables is as challenging as your organization's collection rules. If you have simple rules then your setup process will be straightforward. If your collection rules are complicated (e.g., they differ based on the type of customer, the type of debt, the age of debt, the type of service, etc.), then your setup process will be more challenging.

The Big Picture Of Credit & Collections

This section provides an overview of important C&C concepts with which you should be familiar before you set up your C&C control tables.

Collection Criteria vs. Severance Criteria vs. Write Off Criteria

The following diagram introduces important concepts related to the C&C processes:

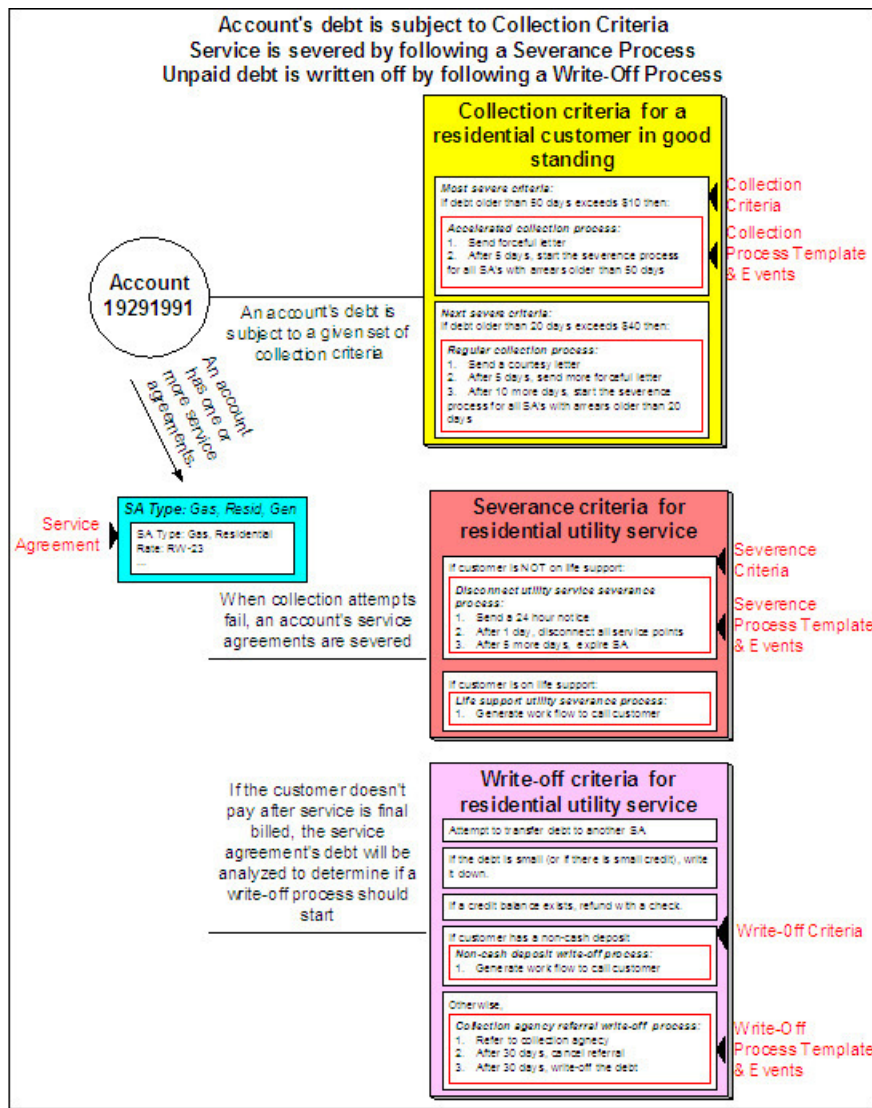

There are many important concepts illustrated above:

An account's debt comes from its service agreements

An account's debt is managed at the service agreement level, i.e., the system keeps track of how much a customer owes in respect of each service agreement. In order to determine an account's balance, the system must add up the debt on each of the account's service agreements.

Collection criteria define intolerable debt

Collection criteria are control data that define intolerable debt. Most criteria are defined using a combination of number of days in arrears and a dollar amount.

Collection criteria may be compared to an account's total debt or to subsets of debt

If your organization has simple collection procedures, you will probably target collection criteria at an account's total debt. However, you have the option of segregating an account's debt into debt classes and targeting the collection criteria at each class. For more information about debt classes, see [Different Collection Criteria For Different Customers And Different Debt](#).

Collection criteria also define what to do when the level of intolerable debt is exceeded

When you define collection criteria, you also define how the system should respond if an account violates your criteria. These collection events are defined in respect of a "collection process template".

There are usually several collection events that take place when criteria are violated

A collection process template usually has several collection events. Each event is meant to prod the customer to pay. The initial collection events are typically letters. If payment is not received after several such attempts, the last collection event typically starts a severance process for each service agreement in arrears.

A severance process template defines how to sever a service agreement

A "severance process template" defines how to sever a given type of service agreement. A severance process template usually contains several severance events. These events are a series of letters and / or disconnection field activities that eventually result in the expiration of a service agreement if payment is not received.

Severance criteria define how to sever service agreements

Severance criteria define the severance process to be executed for service agreements of a given SA type. The severance process may differ depending on some attribute of the customer (or premise). For example, you may have a different severance process if the customer has life support equipment.

After a service agreement is severed, it will be final billed

When the last active service agreement linked to an account is stopped, the system changes the account's bill cycle to bill that evening. If only one of many SAs is stopped, the SA will only be final billed as per the account's original bill cycle schedule.

If a customer doesn't pay their final bill, the account's debt will be analyzed to determine if the system can reduce the debt to zero using a variety of mechanisms

The system will look at an account's finaled debt on its next scheduled credit review date (typically a few days after the bill's due date). The system will attempt to reduce the service agreement's debt to zero using all of the following methods:

- If the account has active service agreements, it will transfer the finaled debt to an active service agreement.
- If the debt or credit amount on the service agreement is small, the system will generate an adjustment to 'write it down' (or up in the case of a small credit).
- If the service agreement has a large credit amount, the system will generate an A/P adjustment (resulting in a check being sent to the customer).

If a customer's finaled debt cannot be reduced via any of the previous methods, the system creates a write-off process

A write-off process contains one or more write-off events. These events can generate a letter, send a To Do entry to a CSR, send a referral to a collection agency, etc.

When you set up the system, you define the type of write-off process to use for every collection class / write-off debt class combination. In addition, you can also indicate when the type of write-off process should differ depending on some attribute of the customer (or premise). For example, you may have a different write-off process if the customer has a non-cash deposit.

The last write-off event typically causes the debt to be written off

Ultimately, if the write-off events fail, the debt will have to be written off. When debt is written-off, the system creates a write-off service agreement and transfers the outstanding debt to it. This means the debt stays with the account for life and will have to be paid off if the customer ever returns.

NOTE:

Checkpoint. At this point, you should be familiar with the concept that an account's debt is compared to user-defined collection criteria. If the account violates the criteria, a series of events will ensue that prod the customer to pay. If the customer doesn't respond, every service agreement in arrears will be severed (i.e., disconnected). If lack of service doesn't inspire payment, the service agreement will be expired and a write-off process will be created to manage the write-off activities.

The C&C Monitors

Your collection, severance and write-off criteria described in the previous section exist to support the processes that manage the collection of overdue debt: The following diagram illustrates, at a high level, the major processes that manage the collection of overdue debt:

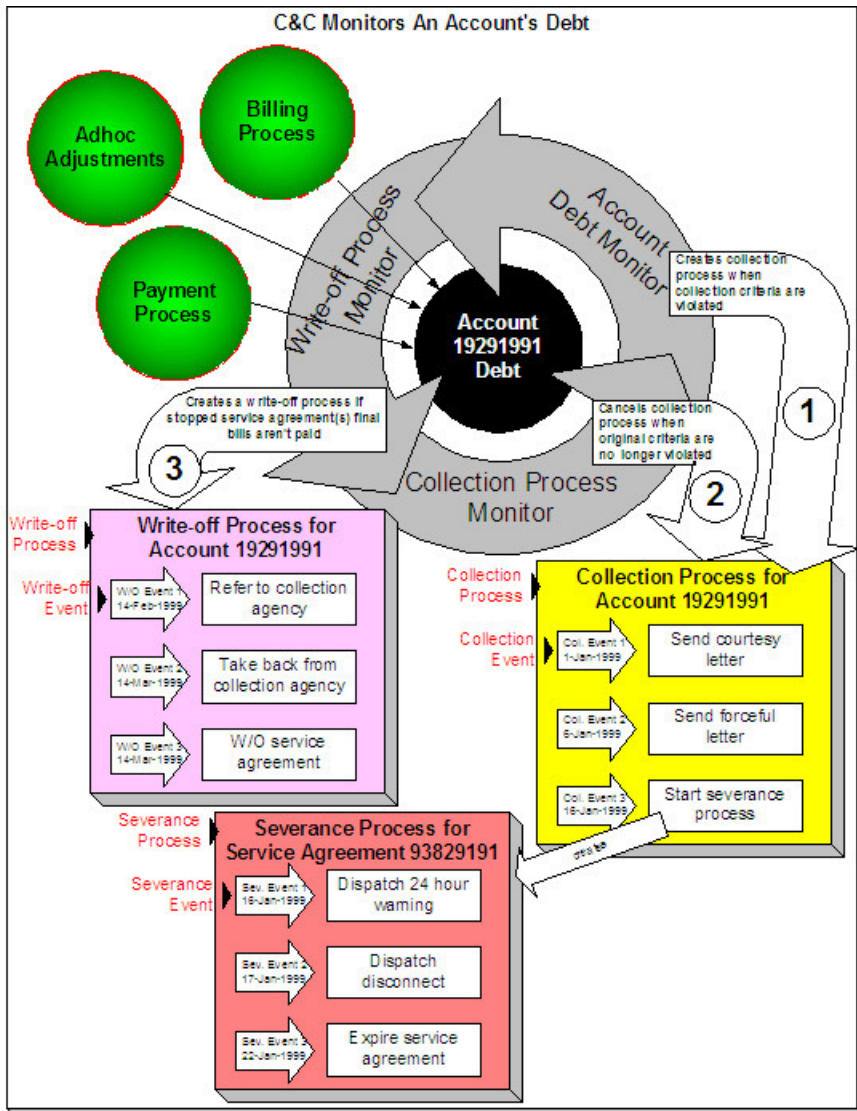

There are many important concepts illustrated above:

Bills, payments and adjustments affect an account's debt	An account's debt is the accumulation of all bills, payments and adjustments.
The Account Debt Monitor creates a collection process when an account violates collection criteria	Periodically, a background process referred to as the Account Debt Monitor determines if an account's debt violates your collection criteria. If so, a collection process is created using the violated criteria's collection process template. Refer to When Is An Account's Debt Monitored? for a description of when an account's debt is compared against collection criteria.
A collection process contains one or more collection events	The collection process contains a series of collection events. These events correspond with the collection event types associated with the collection process template. The initial collection events are typically letters. If payment is not received after several such communications, the last collection event typically starts a severance process for each service agreement in arrears.
The Collection Process Monitor cancels a collection process when warranted	The Collection Process Monitor cancels a collection process when its service agreements satisfy your cancellation criteria (e.g., when the service agreements have less than \$10 of debt older than 20 days). Refer to How Are Collection Processes Cancelled for more information about the cancellation process.
The last collection event starts one or more severance processes	The last collection event typically starts one or more severance processes. A severance process contains the activities necessary to sever a service agreement. The service agreement(s) that are severed may be all SAs that are associated with the collection process. Alternatively, you can nominate a service agreement to act as the primary service to cut (you'd do this if you cut electricity when the customer doesn't pay for their gas). The algorithm on the collection event that starts severance will control which service agreement(s) are severed. Refer to How To Nominate A Single Service Agreement To Sever for more information.
Each service agreement has its own severance process	Every service agreement that is severed has a severance process. The type of process is dependent on the severance criteria linked to the service agreement's SA type.
A severance process contains one or more severance events	The severance process contains a series of severance events. The events correspond with the severance process template's severance events.
The system cancels a severance process when warranted	The system cancels a severance process when its service agreement satisfies your cancellation criteria (note, it is possible to set up the system so that all service agreements in the debt class must satisfy your cancellation criteria before a severance process is cancelled). It's important to note that the cancellation is real time (as opposed to the cancellation of collection processes, which happens in a background process). Refer to How Are Severance Events Canceled? for more information.
The last severance event should expire the service agreement	The last severance event typically expires its service agreement. When the last service agreement linked to an account is expired, the system will schedule the account for billing (outside of its normal bill cycle schedule).
If you nominate a single SA to sever when multiple SAs are in arrears...	Earlier we indicated that you can nominate a service agreement to act as the primary service to cut (you'd do this if you cut electricity when the customer doesn't pay for their gas). If you do this, you also need

a severance event that will sever all other service agreements in the debt class if the severance of the nominated service agreement doesn't inspire payment. A severance event algorithm to do such is supplied with the base package. Refer to [How To Nominate A Single Service Agreement To Sever](#) for more information.

The Write-Off Monitor creates a write off process to collect stopped, unpaid debt

The Write-Off Monitor reviews stopped and reactivated service agreements after their closing bill's due date (plus grace period). The Write-Off Monitor attempts to reduce the service agreement's debt to zero using all of the following methods:

- If the account has active service agreements, it will transfer the finalized debt to an active service agreement.
- If the debt or credit amount on the service agreement is small, the system will generate an adjustment to 'write it down' (or up in the case of a small credit).
- If the service agreement has a large credit amount, the system will generate an A/P adjustment (resulting in a check being sent to the customer).
If the system is unsuccessful in reducing the account's debt to zero, a write-off process will be created using the appropriate write-off process template. Refer to [The Big Picture Of Write Off Processing](#) for more information about the write-off process.

A write-off process contains one or more write-off events

The write-off process contains a series of write-off events. These events correspond with the write-off event types associated with the write-off process template. The initial write-off events are typically collection agency referrals and/or letters. If payment is not received as a result of such efforts, the last write-off event typically writes off the customer's debt.

The system cancels a write-off process when warranted

The system cancels a write-off process when its service agreements no longer have debt (i.e., they become closed).

Another write-off process will be created if a closed service agreement ever reactivates

If a service agreement becomes reactivated (e.g., because the final payment bounces), the service agreement will be processed by the Write-Off Monitor and the whole write-off process starts again.

NOTE:

Checkpoint. At this point, you should be familiar with the concept that a collection process will be created for an account that violates collection criteria. The collection process consists of a series of events that typically generate letters and / or To Do entries. If the customer doesn't respond, a severance process will be started for one or more service agreements. A severance process consists of a series of events that typically generate letters and/or disconnection field activities. If lack of service doesn't inspire payment, the last severance event expires the service agreement (and a final bill will be scheduled when the last service agreement is expired). If the customer doesn't pay the final bill, a write-off process will be created for each type of unpaid debt. The write-off process consists of a series of events that ultimately result in the write-off of the customer's debt. When debt is written-off, the system creates a write-off service agreement and transfers the outstanding debt to it. This means the debt stays with the account for life (because the write-off service agreement is linked to the account) and will have to be paid off if the customer ever returns.

The Big Picture Of Collection Processes

The topics in this section describe how collection processes are created and cancelled.

FASTPATH:

For more information refer to [The Lifecycle Of A Collection Process And Its Events](#).

How Does The Account Debt Monitor Work?

This section describes how the Account Debt Monitor uses your collection criteria and collection process templates to collect overdue debt.

Different Collection Criteria For Different Customers And Different Debt

Consider the following:

- You probably have different collection criteria for different jurisdictions (i.e., CIS Divisions). For example, if you have customers in different states / provinces, you may have different regulator-imposed criteria applied to each state's debt. You differentiate your debt in respect of the collection process via the **CIS division code on each customer's account**.
- You probably have different collection criteria for different customer segments. For example, customers with large bills probably have strict criteria, whereas you're probably more lenient with small customers (or vice versa). You differentiate your customers in respect of the collection process via a **collection class code on the customers' accounts**. An account's initial collection class is defaulted from its customer class. You may override an account's collection class at will.
- You probably have different collection criteria for different classes of debt. For example, if a single customer has both regulated and unregulated debt, you probably have commission-imposed criteria to be applied to the regulated debt, but you have the freedom to apply stricter criteria to the unregulated debt. You differentiate your debt in respect of the collection process via a **debt class code on the customers' service agreements** (note: the debt class is actually defined on the service agreement's SA type).
- You will have different criteria for every currency in which you work because the monitoring process always compares a customer's debt against some value and this value must be denominated in the customer's currency. A customer's currency is defined using a **currency code on the account**.

Given the above, you should understand that different collection criteria will exist for every combination of CIS division, collection class, debt class, and currency code. If you're confused, consider the following matrix (where we assume you have a single currency and division and therefore avoid the third and fourth dimensions):

SA's Debt Class	Account's Collection Class:	
	Commercial Customer	Residential Customer
Regulated	N/A - there is no regulated, commercial customer debt.	Highest Priority: If > \$5 in arrears by more than 50 days, create the accelerated collection process for residential customers. Lower Priority: If > \$25 in arrears by more than 25 days, create the courtesy reminder collection process for residential customers.
Unregulated	Highest Priority: If > \$10 in arrears by more than 50 days, create the accelerated collection process for commercial customers. Lower Priority: If > \$1000 in arrears by more than 25 days, create the normal collection process for commercial customers.	Highest Priority: If > \$10 in arrears by more than 25 days, create the normal collection process for residential customers.

Charitable Contribution

Highest Priority: If > \$10 in arrears by more than 50 days, create the charitable collection process.

Highest Priority: If > \$10 in arrears by more than 50 days, create the charitable collection process.

Also, notice that there can be multiple criteria for each cell in the matrix. What differentiates one collection criteria from another is its priority. The higher priority criteria will be compared first. If the debt meets the criteria, the collection process is initiated and no further comparisons are performed.

FASTPATH:

For more information about maintaining this matrix, refer to [Setting Up Collection Class Controls](#). For more information about how the system handles an element in this matrix that has multiple criteria, see [How Is An Account's Debt Monitored?](#).

Override Conditions

WARNING:

Your credit & collection requirements may not require any overrides and therefore this section may not be relevant for your organization.

The matrix presented in the previous section showed:

- You can have different collection criteria for different categories of debt and customers.
- When a collection criteria is violated, the system generates a specific collection process.

This works great for many organizations, but if your organization has other factors that affect either the collection criteria OR the collection process that is initiated when the criteria is violated, you may need to use override collection criteria. For example,

- If you have a different collection process for regulated, residential debt during the winter months, you'll need to use override collection criteria (where the override criteria is "if it's winter").
 - If you have different collection criteria for customers with a poor credit score, you'll need to use override collection criteria (where the override criteria is "if the customer's credit rating is poor").
-

FASTPATH:

Refer to [Designing Your Collection Class Control Overrides](#) for more information.

This section describes how and when the Account Debt Monitor analyzes an account's debt.

When Is An Account's Debt Monitored?

The account debt monitor (ADM) analyzes an account's debt at least every X days, where X is defined on the [customer class control](#) associated with the account's customer class and division (in the field Min Credit Review Freq (Days)).

In addition, an account's debt will also be monitored as follows:

- The ADM looks at an account's debt X days after an account's bill due date (X is defined on the account's customer class in the field Collection Grace Days).
- The ADM looks at an account's debt after a payment is canceled when the cancellation reason indicates NSF (non-sufficient funds).

- The ADM looks at an account's debt after a payment arrangement is broken (assuming you use the base package's break payment arrangement plug-in). Refer to [Monitoring Payment Arrangements](#) for more information.
- The ADM looks at an account's debt after a pay plan is broken. Refer to [The Pay Plan Monitor](#) for more information.

How Is An Account's Debt Monitored?

Assume the following collection control matrix exists for your organization:

SA's Debt Class	Account's Collection Class:	
	Commercial Customer	Residential Customer
Regulated	N/A - there is no regulated, large customer debt	Highest Priority: If > \$5 in arrears by more than 50 days, create the accelerated collection process for residential customers. Lower Priority: If > \$25 in arrears by more than 25 days, create the courtesy reminder collection process for residential customers.
Unregulated	Highest Priority: If > \$10 in arrears by more than 50 days, create the accelerated collection process for commercial customers. Lower Priority: If > \$1000 in arrears by more than 25 days, create the normal collection process for commercial customers.	Highest Priority: If > \$10 in arrears by more than 25 days, create the normal collection process for residential customers.

This matrix contains the information used by the Account Debt Monitor.

FASTPATH:

For more information about the information in this matrix, refer to [Different Collection Criteria For Different Customers And Different Debt](#).

This matrix can be overwhelming when viewed as a whole. So let's consider how to use it for a specific account's debt and things will become clearer.

First, because an account belongs to a unique collection class, we only have to worry about a single column in the matrix when monitoring an account's debt.

Next, we accumulate the total amount of aged debt for each unique debt class associated with the account's service agreements.

Next, we subject the accumulated aged debt to the override aged debt algorithm (plugged in on the debt class). This algorithm can cause aged debt to be reduced. This is an optional algorithm and is only used if you set up pay plans for customers. Refer to [How Pay Plans Affect The Account Debt Monitor](#) for more information.

Next, we determine if the debt for the debt class violates the collection criteria in the respective matrix element. If so, we kick off a collection process and link the offending service agreements to it. The logic associated with the determination of whether to kick off a collection process is rather sophisticated. The following flowchart explains the exact details.

NOTE:

Important. If a service agreement is part of an ongoing severance process, it will NOT be considered by the Account Debt Monitor (it's already being severed). If a service agreement is stopped, closed, or reactivated, it also will NOT be considered by the Account Debt Monitor (it's already severed).

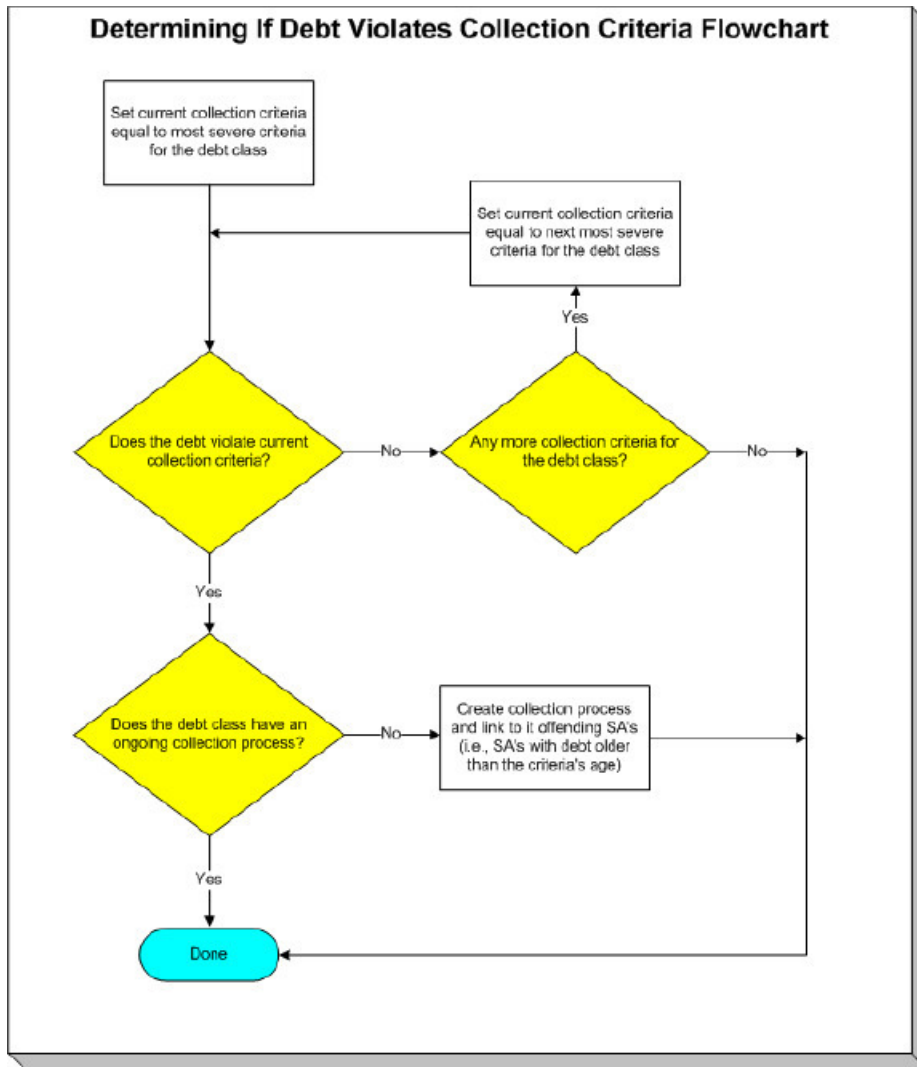

NOTE:

Multiple collection processes may be kicked off. It's important to be aware that if an account's service agreements reference multiple debt classes, a collection process will be started for each offending debt class.

One collection process per debt class. A given debt class for an account may only have one ongoing collection process at any point in time.

What Happens When A Collection Process Is Started?

When you define collection criteria, you must define the collection process template to use if the criteria are violated. The system uses this template to create the account-specific collection process.

Every service agreement that is part of the offending debt class that has debt older than X days will be linked to the collection process (where X is the debt age on the collection criteria).

Also linked to the collection process will be one or more collection events. These events are typically a series of letters meant to prod the customer (you can also create an event that sends a To Do entry to a user to highlight the offensive debt). You define exactly which letters are generated and when they are generated when you set up the events on your collection process templates.

It's important to note that all of the collection events will be created when the collection process is created. Each of these collection events contains a trigger date. The trigger date of the first event(s) will typically be the current date. The trigger date of the other events will be in the future. Refer to [Calendar vs Work Days](#) for information that describes how the trigger date is set.

A separate process, Activate Collection Events, is responsible for activating collection events whose date is on or before the current date. Activation of an event causes the system to do whatever the event indicates (e.g., send a letter, send a To Do entry to a user, start a severance processes, etc.)

If adequate payments / credits are recorded in the system, the collection process will be cancelled.

FASTPATH:

For more information about collection process templates, see [Setting Up Collection Process Templates](#). For more information about collection events, see [The Big Picture Of Collection Events](#). For more information about how a collection process is cancelled, see [How Are Collection Processes Cancelled](#).

Experimenting With Alternative Collection Process Templates

The system allows you to determine the efficacy of proposed collection process templates using a small subset of customers before implementing the templates on the entire customer base. We use the term "champion / challenger" to reference this functionality.

We'll use an example to explain. Let's assume your prevailing collection process template for residential customers starts with a "gentle reminder" letter followed 10 days later by a letter threatening collection agency referral if payment is not received. You may want to experiment with the impact of a change to this template. For example, you may want to change the "gentle reminder" to something more assertive and follow this up 5 days later with an even sterner warning. You can use the "champion / challenger" functionality to perform this experiment.

The following points describe how to implement "champion / challenger" functionality:

- Set up a "challenger" collection process template for each template that you want to experiment with.
- Insert a new **Champion/Challenger** option on the Collection Processing [Feature Configuration](#) for every champion template. Each option's value defines:
 - the "champion" collection process template code
 - the "challenger" collection process template code
 - the percentage of the time the system should use the "challenger" template
- Keep in mind that you can only experiment with one challenger template per champion template. For example, let's assume you have two prevailing collection process templates - one for residential customers and another for commercial customers. You can experiment with different challenger templates for the residential and commercial templates. However, you cannot experiment with two different challenger templates for the residential champion template (i.e., a champion template can have 0 or 1 challenger template).

After setting up the above, the [Account Debt Monitor](#) will use the challenger template X% of the time rather than the champion template.

If you are using the Oracle Utilities Analytics product, you can configure analytic zones in innumerable ways to compare the efficacy of the champion versus the challenger. For example,

- You can set up a graph to show the average duration of each type of process.
- You can set up a graph to show the average dollars that were successfully collected.
- You can set up a dimensional scorecard to show how each template performed in different regions (or customer classes or ...).
- Etc (the list is limited by your imagination).

How Are Collection Processes Cancelled?

A collection process may be cancelled via the mechanisms described in this section.

The Collection Process Monitor Can Cancel A Collection Process

The Collection Process Monitor (CPM or C1-CPM) is a background process that reviews a collection process when the debt associated with one of its service agreements is reduced. Financial events that can cause service agreement debt to be reduced are:

- The cancellation of a bill segment.
- The creation of a payment segment.
- The creation of an adjustment that credits a service agreement.

The review performed by the CPM occurs as follows:

- **Debt class cancel criteria.** In general, the sum of all debt associated with the collection process's debt class must be less than a given threshold amount for a collection process to be cancelled. If so, the collection process is cancelled.
- Please be aware that, if a [Pay Plan](#) exists for the account and debt class, the customer's debt will be temporarily reduced by the amount of the pay plan's scheduled payments before it is compared to the threshold amount. Please be aware that this temporary reduction will only occur if you have plugged in the appropriate pay plan debt reduction algorithm on the debt class.

NOTE:

The above logic is not "hard coded". The CPM calls the Collection Process Cancel Criteria Algorithm defined on the debt class that is associated with the collection process. This algorithm will cancel a collection process if the sum of ALL service agreements in the debt class have debt less than a given threshold amount. However, because it's an algorithm, you can introduce whatever cancellation criteria you please.

- **Service agreement cancel criteria.** You can optionally introduce a special quirk to the cancellation logic. This quirk is a bit difficult to understand. To understand it, you should recall:
 - All service agreements that are in arrears in a given debt class are linked to the collection process.
 - The collection event called Start Severance creates a severance process for every service agreement that is in arrears on the collection process (the alternative is to [Nominate A Single Service Agreement To Sever](#)).
 - If you use the Start Severance collection event, you would want to remove a service agreement from a collection process when it no longer has intolerable debt (regardless of the state of the debt class's entire debt). You'd want to do this because, if you don't, the system would start a severance process for the paid up service agreement and if it's paid up, you wouldn't want a severance process created for it.
- To "remove" service agreements from a collection process when they no longer have intolerable debt, you should plug-in a Service Agreement-Oriented Cancel Criteria Algorithm on your collection process templates. The CPM will call this algorithm if you've plugged it in.

NOTE:

When all service agreements are "removed" from a collection process, the CPM cancels all pending collection events and cancels the collection process.

WARNING:

Checking if individual service agreements should be removed from a collection process is optional (meaning that you don't have to plug one in on the collection process template).

A New Payment Plan Can Cancel A Collection Process

Refer to [Collection Process / Severance Process Cancellation When A Pay Plan Is Created](#) for the details.

NOTE:

Real time cancellation. Please be aware that the system will cancel a collection process real time when a pay plan is created (if the pay plan's scheduled payments are enough to pay-off the customer's outstanding debt).

A User May Cancel A Collection Process At Their Discretion

A user may cancel a collection process at their discretion.

Stopping A Service Agreement May Cancel A Collection Process

The system will "remove" a service agreement from a collection process when it is stopped (i.e., when the service agreement's status becomes Stopped). When the last service agreement is "removed" from the collection process, the collection process will be cancelled.

The Big Picture Of Collection Events

This section describes the various types of collection events and their lifecycle.

How Are Collection Events Created?

Collection events may be created as follows:

- The Account Debt Monitor creates a collection process when an account violates collection criteria. The collection process has one or more collection event(s). The number and type of events is controlled by the collection process template associated with the collection process.
 - Collection events are created when a user creates an ad hoc collection process. The number and type of events is controlled by the collection process template defined when the collection process is created.
 - An ad hoc collection event may be created and linked to an existing collection process by a user at their discretion.
-

NOTE:

Bottom line. Most collection events are created by the system when it creates a collection process for delinquent accounts. If you need to create an ad hoc collection event, you can either create a collection process whose template contains the desired event OR link the desired event to an existing collection process.

FASTPATH:

For more information about the creation of events by the Account Debt Monitor refer to [What Happens When A Collection Process Is Started?](#). For more information about creating ad hoc collection processes, refer to [Collection Process Maintenance](#). For more information about creating ad hoc events, refer to [Collection Process - Events](#).

Types Of Collection Events

The following table describes the various types of collection events and what happens when they are completed:

Type Of Collection Event	What Happens In The System
Send Letter	<p>A customer contact is created for every financially responsible person linked to the account. The customer contact causes a letter to be produced.</p> <p>The type of letter is defined on the customer contact's contact type.</p> <p>The recipient of each letter is defined on Account / Person (those persons marked as Receiving Notifications).</p>
Create To Do Entry	A To Do entry is created. Refer to The Big Picture of To Do Entries for more information about To Do entries.
Affect Credit Rating/Cash-Only	An account credit rating demerit record is created. The number of demerits is defined on the collection event type.
Cancel Budget	Every service agreement linked to the account that is on a budget is "removed" from the budget (i.e., the recurring charge amount for the service agreement is set to zero). In addition, a syncing adjustment is issued to cause each SA's current balance to be set equal to their payoff balance (the adjustment type is defined on the SA's SA type). Also, the Budget Plan field on the Account - Budget page is cleared.
Generic Algorithm	The algorithm defined on the event's event type is executed.
Start Severance Process	A severance process is created for every service agreement linked to the collection process. The type of severance process is defined on the SA type table (every service agreement references an SA type).

FASTPATH:

Refer to [Setting Up Collection Event Types](#) for more information.

Collection Event Lifecycle

The following diagram shows the possible lifecycle of a collection event:

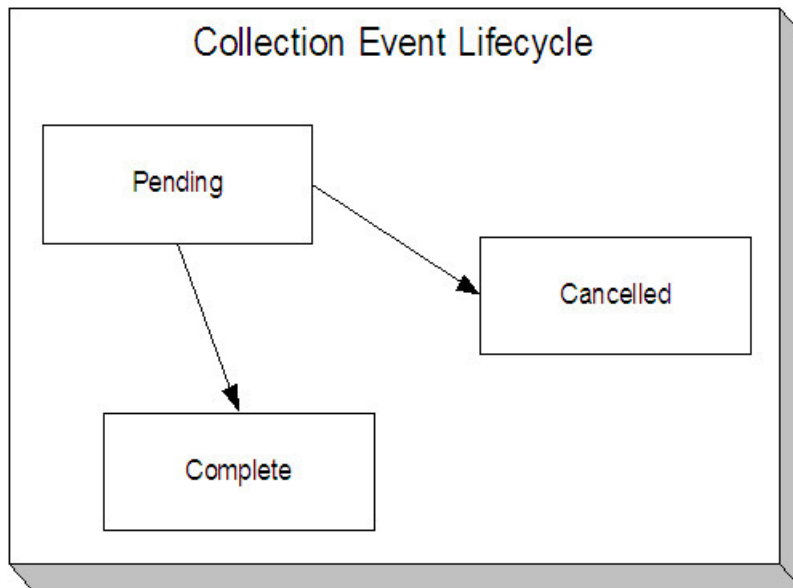

Collection events are initially created in the pending state.

When the system sees a pending event with a trigger date on or before the current date, the system executes the event's activity and completes the event.

FASTPATH:

For more information about a collection event's trigger date, see [Collection Event Trigger Date](#).

A pending event will be cancelled automatically by the system when the account's debt no longer violates the collection criteria that sparked the event's collection process. A pending event may also be cancelled by a user at their discretion. Refer to [How Are Collection Processes Cancelled](#) for more information about how the system will cancel a collection process (and its events).

Collection Event Trigger Date

When a collection event is created by the system, its trigger date is set in accordance with your date arithmetic preferences. Refer to [Calendar vs. Work Days](#) for more information.

How Are Collection Events Completed

A background process runs periodically (at least daily) that looks for collection events with a trigger date on or before the current date. For each triggered event, the system executes its activity and then completes it. Refer to [Collection Event Activator](#) for more information.

The Last Collection Event Should Kick Off Severance Process(es)

The last collection event will typically kick off the severance process for every service agreement linked to the collection process. This will only happen if you set up the collection process template accordingly (i.e., the last event type in the process template is the kind that starts a severance process for every service agreement linked to the collection process).

NOTE:

Nominating a service agreement to sever. Many organizations that have multiple services in arrears will NOT sever every service agreement that's in arrears. Rather, they will nominate one service agreement and use it to encourage the customer to pay for the other services. If your organization works this way, then your last collection event should call the Nominate A Service Agreement To Sever Algorithm.

How Are Collection Events Canceled?

Users can cancel a collection event at their discretion. In addition, the system can cancel a collection event when it automatically cancels a collection process. Refer to [How Are Collection Processes Cancelled](#) for the details.

The Big Picture Of Severance Process Cancellation

The topics in this section provide high level information about the cancellation of severance processes.

FASTPATH:

For more information refer to [The Lifecycle Of A Severance Process And Its Events](#).

How Are Severance Processes Cancelled?

A severance process may be cancelled via the mechanisms described in this section.

FASTPATH:

Refer to [What Happens When A Severance Process Is Cancelled?](#) for what happens when a severance process is cancelled.

The Freezing Of Certain Financial Transactions Can Cancel A Severance Process

NOTE:

The system will only cancel a severance process if its severance process template indicates that **Auto Cancel** is allowed. Typically, this switch is set on all severance process templates except for the odd ones that are used to [reconnect service](#).

The system reviews a severance process real-time whenever its service agreement's debt is reduced. Financial events that can cause service agreement debt to be reduced are:

- The cancellation of a bill segment.
 - The creation of a payment segment.
 - The creation of an adjustment that credits a service agreement.
-

NOTE:

Real time cancellation. Unlike collection processes, the system cancels severance processes real time (i.e., there is no background process that monitors severance processes). Why are severance processes canceled real time? Because a severance process may have events that create field activities to sever service. These events need to be canceled the moment the FT is frozen, we can't wait until a background process runs. This means that if a customer pays in person

for a service agreement that is pending severance, the system will cancel the process and its field activities (if any) the moment the payment is entered.

The review takes place as follows:

- **Debt class cancel criteria.** In general, the sum of all debt associated with the severance process's debt class must be less than or equal to a given threshold amount for a severance process to be cancelled. If so, the severance process is cancelled.
- Please be aware that, if a [Pay Plan](#) exists for the account and debt class, the actual debt will be temporarily reduced by the amount of the pay plan's scheduled payments before it is compared to the threshold amount. Note: this temporary reduction will only occur if you have plugged in the appropriate pay plan debt reduction algorithm on the debt class.

NOTE:

The above logic is not "hard coded". The system calls the Severance Process Cancel Criteria Algorithm defined on the [debt class](#) that is associated with the severance process. This algorithm cancels a severance process if the sum of ALL service agreements in the debt class have debt less than or equal to a given threshold amount. However, because it's an algorithm, you can introduce whatever cancellation criteria you please.

- **Service agreement cancel criteria.** You can optionally introduce a special quirk to the cancellation logic. This quirk is a bit difficult to understand. To understand it, you should recall:
 - The collection event called Start Severance creates a severance process for every service agreement that is in arrears. Note: you would only use this type of collection event if you do not Nominate A Single Service Agreement To Sever.
 - If you use the Start Severance collection event, then you would want to cancel a severance process when its service agreement no longer has intolerable debt (regardless of the state of the debt class's entire debt).
- To cancel a severance process when its related service agreement no longer has intolerable debt, you should plug-in a Cancel Criteria Algorithm on your [severance process templates](#). The system will call this algorithm if you've plugged it in.

NOTE:

Manual Creation. A user can create a severance process for an account that does not qualify to be on severance according to the cancel criteria algorithm. For example, perhaps your cancel criteria algorithm cancels a severance process when the account's debt falls below a threshold amount. A user can create a severance process for an account whose debt is already below this threshold. Because cancellation is real time, there is no action that will cause this severance process to be canceled. When a manual severance process is created, the system executes the appropriate cancellation criteria algorithm. If the algorithm indicates that the system would have canceled this severance process, a warning is issued.

A New Payment Plan Can Cancel A Severance Process

Refer to [Collection Process / Severance Process Cancellation When A Pay Plan Is Created](#) for the details.

NOTE:

Real time cancellation. Please be aware that the system will cancel a severance process real time when a pay plan is created that pays off enough debt.

A User May Cancel A Severance Process At Their Discretion

A user may cancel a severance process at their discretion.

Stopping A Service Agreement Will Cancel A Severance Process

The system will cancel a severance process if its service agreement is stopped (i.e., when the service agreement's status becomes Stopped).

What Happens When A Severance Process Is Cancelled?

The following takes place when a severance process is canceled by the system:

- The system cancels all pending severance events and deactivates the severance process.
- If there are any field activities linked to the severance process, an optional plug-in spot defined on the installation record allows you to plug in an algorithm to cancel these field activities.
 - The base package Severance Process Cancellation Algorithm will cancel all pending field activities that were created as a result of the severance process that are not linked to a dispatched field order.
- If there are any pending field activities left associated with the severance process, it is marked to trigger the creation of a To Do entry to highlight that field activities exist for a canceled severance process. (This happens if you have not plugged in an algorithm to perform the cancellation or if the algorithm detected a condition that prevented cancellation.) To create the To Do entry, you must run the background process [TD-SPRO](#).
- There is an optional plug-in spot defined on the severance process' template. If an algorithm is plugged-in, it is called. The base package algorithm will create a reconnect process if there are completed field activities for a cut for nonpayment severance event associated with the severance process. Refer to Severance Post Cancellation Algorithm for more information about this algorithm.

The Big Picture Of Severance Events

This section describes the various types of severance events and their lifecycle:

How Are Severance Events Created?

Severance events may be created as follows:

- The process that completes (i.e., executes) collection events creates a severance process when it completes a "start severance process" collection event. The severance process has one or more severance event(s). The number and type of events is controlled by the severance process template associated with the severance process. Refer to [The Collection Event Activator](#) for more information about this process.
- Severance events will be created when a user creates an ad hoc severance process. The number and type of severance events is controlled by the severance process template associated with the severance process.
- An ad hoc severance event may be created and linked to an existing severance process by a user at their discretion.

NOTE:

Bottom line. Most severance events are created by the system when it creates a severance process for delinquent service agreements. If you need to create an ad hoc severance event, you can either create a severance process whose template contains the desired event OR link the desired event to an existing severance process.

FASTPATH:

For more information about creating ad hoc severance processes and events, refer to [How To Perform Common Severance Process Functions](#).

Types Of Severance Events

The following table describes the various types of severance events and what happens when they are completed:

Type Of Severance Event	What Happens In The System
Send Letter	<p>A customer contact is created for every financially responsible person linked to the service agreement's account. It is the customer contact that causes a letter to be produced.</p> <p>The type of letter is defined on the customer contact's contact type.</p> <p>The recipient of each letter is defined on Account / Person (those persons marked as Receiving Notifications).</p>
Create To Do Entry	<p>A To Do entry is created. Refer to The Big Picture of To Do Entries for more information about To Do entries.</p>
Create Field Activities	<p>A field activity is created for each service point associated with the service agreement being severed. The type of activity is defined on the service point's SP type's field activity type profile.</p>
Generic Algorithm	<p>The algorithm defined on the event's event type is executed.</p>
Expire Service Agreement	<p>The service agreement is expired and, if earlier severance events created "cut for non-payment" field activities, these field activities will be used as the basis for stopping service. Refer to Finalizing Pending Stops for how the system use the meter reads on these field activities as the "stop reads" on the service agreement. Note, you can see the field activities that are used to "cut" and "stop" service by viewing the Field Activities grid on Service Agreement - Service Point.</p>
Affect Credit Rating/Cash-Only	<p>An account credit rating demerit record is created. The number of demerits is defined on the collection event type.</p>

FASTPATH:

Refer to [Setting Up Severance Event Types](#) for more information.

Field Events Versus Office Events

Severance events are considered either field or office events. Office events are just like collection events in that they don't involve any type of field activity in their completion. Field events, however, are not like collection events because they create one or more field activities. These activities cause these events to have a different lifecycle. Refer to [Severance Event Lifecycle](#) for more information.

Severance Event Lifecycle

The following diagram shows the possible lifecycle of a severance event:

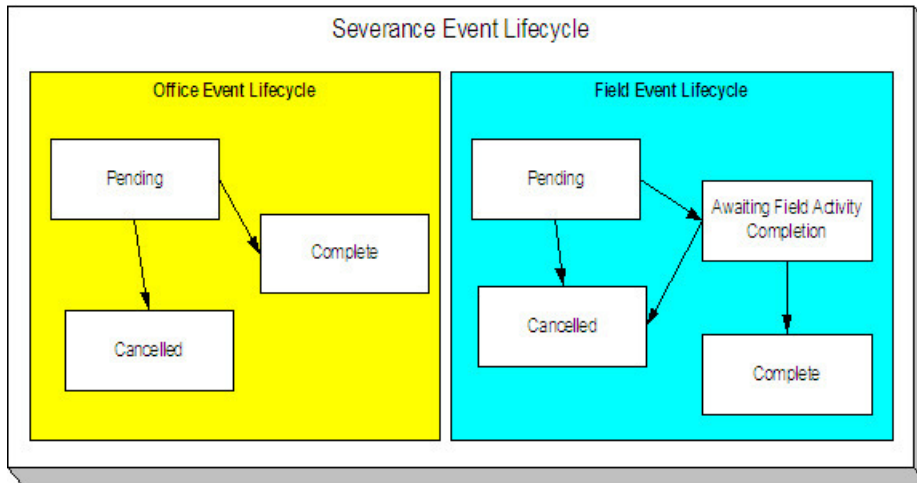

The following points explain the lifecycle of severance events of the office variety:

- Office events are initially created in the pending state.
- A pending office event becomes complete when the system sees that its trigger date is on or before the current date. At this time, the system executes the event's activity (e.g., create a letter, create To Do entry).

FASTPATH:

For more information about a severance event's trigger date, see [Severance Event Dependencies & Trigger Date](#).

- A pending office event will be cancelled automatically by the system when the debt associated with the severance process's service agreement is sufficiently reduced. A pending office event may also be cancelled by a user at their discretion. Refer to [How Are Severance Processes Cancelled](#) for more information about how the system will cancel a severance process (and its events).

The following points explain the lifecycle of severance events of the field variety:

- Field events are initially created in the pending state.
- A pending field event becomes awaiting field activity completion when the system sees that its trigger date is on or before the current date. At this time, the system creates the field activities associated with the given event (e.g., disconnection warning, disconnect for nonpayment, etc.).

FASTPATH:

For more information about a severance event's trigger date, refer to [Severance Event Dependencies & Trigger Date](#). For more information about the field activities that are created for a field severance event, refer to [Field Events And Their Activities](#).

- An awaiting field activity completion field event becomes complete when the system sees that its field activities are all complete or cancelled.
- A pending field event will be cancelled automatically by the system when the service agreement associated with the severance event's severance process has sufficient credits. A pending field event may also be cancelled by a user at their discretion.
- An awaiting field activity completion field event will be cancelled automatically by the system when the service agreement associated with the severance event's severance process has sufficient credits if the field activity has not been dispatched (refer to [Designing Your Reconnection Procedures](#) for information on how the system handles the situation if the field activity is completed or dispatched). An awaiting field activity completion event may also be cancelled by a user at their discretion.

Severance Event Dependencies and Trigger Date

When a severance event is created by the system, its trigger date cannot be set. This is because, unlike collection events, the trigger date on severance events can only be set when ALL of the preceding severance events on which it depends are complete. An example will help explain why this design is necessary. Consider the following example that shows a standard severance process and its events:

Event Number	Severance Event	Dependent On Event(s)	Trigger Date Set To X Days After Completion Of Preceding Events
10	Field activity - Disconnect for non-payment warning	N/A - first event	0
20	Field activity - Disconnect for non-payment	10	2
30	Create To Do entry	20	0
40	Send letter to customer	20	0
50	Expire service agreement	20	10

This severance process is meant to execute as follows:

- On the first day, generate a 48-hour warning of impending disconnection. This is a field event as most organizations deliver this warning in person.
- After 2 days (i.e., 48 hours) have passed, create a field activity to disconnect for non-payment.
- When this is completed, generate a To Do entry to let a CSR know about the cutoff. Also, send a letter to the customer.
- If after 10 days from the cutoff, we still don't have payment, expire the service agreement.

As can be seen from the above example, the later events are dependent on the completion of the field activities in the earlier events. This means that when you set up a severance event, you must indicate the events on which it depends (and the number of days after their completion that the event should be triggered).

NOTE:

Bottom line. The system sets the trigger date on severance events when it detects that all of its dependent events are complete (this is the responsibility of the SED background process). Refer to [Calendar vs Work Days](#) for a description of your choices in respect of how the trigger date is calculated.

Field Events And Their Activities

When the system is told to start a severance event that creates field activities (e.g., disconnect for non-payment), it will generate a field activity for every service point linked to the service agreement.

The question is, where does it get the field activity type associated with the field activities? The answer is explained below:

- Every service point has an SP type.
- Every SP type references a field activity type profile.
- A field activity type profile contains a matrix defining activity types to generate under various situations. Some of these situations are those associated with severance.

FASTPATH:

For more information, refer to [Setting Up Field Activity Type Profiles](#).

Severance Event Activation & Completion

A background process runs periodically (at least daily) that looks for severance events with a trigger date on or before the current date. This process executes the activity associated with each event. If the event is an office event, the event then becomes complete. If the event is a field event, the event becomes "awaiting field activity completion" until the field activities are complete. At this time, the severance event is completed. Refer to [Severance Event Activator](#) for more information.

How Are Severance Events Canceled?

Users can cancel a severance event at their discretion. In addition, the system can cancel a severance event when it automatically cancels a severance process. Refer to [How Are Severance Processes Cancelled](#) for the details.

The Big Picture Of Write Off Processing

Before you financially write-off debt, most companies go to some effort to collect the past due funds. You control exactly what happens by setting up the various write-off control tables. The topics in this section provide background information that will help you understand how the information in these control tables is used.

How Is Debt Financially Written-Off?

Before debt can be written-off, a write-off service agreement must exist for the account. Why? Because when you write-off a normal service agreement's debt, you are actually transferring its debt to a write-off service agreement.

A write-off service agreement is just like other service agreements in that:

- It holds debt.
- When a payment is received, the service agreement's debt is reduced.

Debt is transferred to a write-off service agreement (WO SA) from the customer's uncollectable service agreements (SAs). The following points highlight important characteristics about the uncollectable SAs and the WO SA:

- The WO SA and the uncollectable SAs should be linked to the same account (note: this isn't a strict rule, it just makes sense because an account's written off funds should be linked to the account).
- Debt may be transferred to a WO SA from any type of service agreement regardless of debt class, i.e., a WO SA can contain debt that originated in any debt class.
- When you transfer debt from the uncollectable SAs to the WO SA, the debt is removed from the uncollectable SAs (and their status becomes closed - assuming their balance becomes zero).
- If you use the system's automated write-off processing, the system will create WO SAs for you. The system's automated write-off processing can write-off revenue in a different manner than is used to write-off liabilities. Refer to [The Ramifications of Write Offs in the General Ledger](#) for more information.
- WO SAs are immune from the account debt monitor (assuming their debt class is marked as not being subject to collection activities).
- WO SAs are not billed (assuming their SA type is marked as being not billable).

- WO SAs start their life with a non-zero payoff and current balances (i.e., they have debt when first started). This debt is transferred from the normal service agreement(s) whose uncollectable debt necessitated the creation of the WO SA.
- If the customer pays off the write-off debt, the WO SA remains active in case you ever need to write-off debt in the future. If you don't like the WO SA remaining active after it's paid off, you can indicate on the WO SA's SA Type that it is a "one time charge", this will cause the WO SA to be automatically closed when it's paid off.
- You can transfer additional uncollectable debt to the WO SA.

NOTE:

Bankruptcy write-offs. If you have to write-off debt because a customer declares bankruptcy, everything stated above is true. The only thing you have to do is use a different SA type for bankruptcy write-offs as compared to "normal" write-offs. On the bankruptcy write-off SA type, simply leave the payment segment type blank - this way the system will never distribute a payment to the bankrupt debt (because bankrupt debt is legally uncollectable).

The Ramifications of Write Offs in the General Ledger

WARNING:

If you practice cash accounting, refer to [Cash Accounting and Write-Offs](#).

When you write-off unpaid debt, you shouldn't book it all to a write-off expense account. Why? Because the debt that you're writing off typically contains both revenue and liabilities. At write-off time, you typically want to:

- Book the written off revenue to a write-off expense account, and
- Reduce the liabilities (you don't owe the liability if you don't get paid).

Consider the following example of a simple electric service agreement with two financial transactions:

Event	GL Accounting
Customer is billed	A/R 1000
	Revenue <900>
	State Tax Payable - Taxing State - California <80>
	City Tax Payable - Taxing City - San Francisco <20>
Customer is levied a late payment charge	A/R 50
	Late Payment Revenue <50>

After these two financial transactions are booked, the customer has debt of \$1050. Of this \$1,050; \$950 is revenue and \$100 is liability (money you owe the taxing authorities).

If the customer doesn't pay, you will eventually have to write-off this debt. Most organizations would issue the following types of financial transactions to do this:

Event	GL Accounting
Write-off the bill	Write-off Expense 900
	State Tax Payable - Taxing State - California 80
	City Tax Payable - Taxing City - San Francisco 20
	A/R <1000>
Write-off the late payment charge	Write-off Expense 50

Notice in the above transactions, the two separate revenue accounts are written off by booking to an expense account. However, the liability accounts are reversed. Why is revenue treated differently from liabilities at write-off time? There's a good reason for it (if you're an accountant), for the time being, just accept that this is how it works.

And finally, we need to worry about what happens if the customer eventually pays off their written off debt. If this happens, most organizations would pay off the write-off first, and, if there was still money left, they'd reimburse the taxing authorities. If we assume the customer pays off the entire written off debt, the following financial transactions would be issued:

Event	GL Accounting
Pay off the written off debt	Cash 900
	Write-off Expense <900>
Reinstate the liabilities	Cash 100
	State Tax Payable - Taxing State - California <80>
	City Tax Payable - Taxing City - San Francisco <20>

While the reinstatement of liabilities at payment time is possible in the system, the ramifications of doing such make this approach impracticable (the ramifications are a) if the check bounces, we would not be able to reduce the liabilities, and b) if there was a partial payment of the liabilities, the remaining unpaid amount could get written down). Therefore, when a write-off is paid the following financial transactions should be issued:

Event	GL Accounting
Pay off the written off debt	Cash 900
	Write-off Expense <900>
Reinstate the liabilities	Cash 100
	Reinstated liabilities <100>

Notice that rather than reinstating the individual liabilities, we simply reinstate all liabilities into a single account. This means your accountants will have to distribute this money to the appropriate liabilities manually.

So, how do we achieve the above in the system? This explanation is a little complicated, but it'll make sense if you keep the above financial transactions in mind:

- First of all, you'll need two different SA types - one to hold the written off revenue and another to hold the reduced liabilities.
 - On the SA type that holds written off revenue, indicate that it is not billable, indicate that it cannot have excess credits, and give it a high payment distribution priority. The distribution code on this SA type should reference your Write-off Expense account.
 - On the SA type that holds the reduced liabilities, indicate that it is not billable, indicate that it cannot have excess credits, and give it a high payment distribution priority. The distribution code on this SA type should reference a the "reinstated liabilities" GL account.

Next, you need to understand how the system's standard write-off logic works:

- The system accumulates the distribution codes from GL details associated with recent financial transactions linked to the service agreement being written-off.
- When the system has accumulated enough distribution codes (i.e., where the amount associated with the distribution code equals or exceeds the amount to write off), the debt will be transferred to a new or existing write-off service agreement(s). The number and type of service agreements to which the bad debt is transferred is defined on the distribution codes. Refer to [Setting Up Distribution Codes](#) for how to define the type of write-off service agreement

associated with a distribution code. In our example, we'd need the two SA types described above - one for the revenue accounts, the other for the liability accounts.

- At write-off time, for those distribution codes associated with revenue, the system will create a transfer adjustment from the normal service agreement to the write-off revenue service agreement. This will reduce (credit) the receivable on the normal service agreement and increase (debit) the expense account defined on the write-off revenue service agreement.
- However, if we do the above for the distribution codes associated with liabilities, we have a problem. The problem is a bit hard to explain unless you understand tax accounting, but it basically comes down to this - if we simply transfer the portion of the receivable balance associated with the liabilities to the write-off liability SA, we will always be debiting the distribution code defined on the SA type. This isn't correct because we really want to debit the liability account (and reference the characteristic type and value from the original credit) when we reduce the liability. So how do we do this? For those distribution codes associated with liabilities, you need to indicate that you want to override the distribution code on the "transfer to" side of the transfer adjustment with the distribution code / characteristic type / characteristic value that was originally booked. Refer to [Setting Up Distribution Codes](#) for how to indicate you want to override the distribution code at write-off time. If you do the above, then at write-off time the transfer adjustment will reduce (credit) the receivable on the normal service agreement and increase (debit) the original liability accounts from the original financial transactions.

If you followed the above, you'll see that we now have everything debited and credited appropriately. And, if a payment materializes for the written off debt, we will simply debit cash and credit the distribution code on the respective SA (either Write Off Expense or Reinstated Liabilities).

NOTE:

Batch and real-time write-offs may use the above processing. The above logic is executed real time when a user writes off debt using the [write-off transaction](#) (assuming the base package write off algorithm is plugged into the account's [customer class](#)). The above logic is executed in batch when a write-off event that references a Write Off Using Distribution Codes [event type](#) is executed. Write-off events are described in detail below.

Automated versus Manual Write Offs

The system will automatically create write-off SAs and transfer uncollectable debt to them during the automated write-off processing described below.

If necessary, you can write-off debt outside of the automated write-off process using either of the following methods:

- You can transfer bad debt from any service agreement to a write-off service agreement using a transfer adjustment.
- You can use the [write-off transaction](#) to write-off debt real-time. When this transaction is used, the system executes the logic embedded in the Write Off Method algorithm that's plugged in on the account's [customer class](#).

How Does The Write-Off Monitor Work?

This section describes how the [Write Off Monitor](#) uses your write-off criteria and write-off process templates to collect overdue debt.

Different Write-Off Criteria For Different Customers And Different Debt

Consider the following:

- You probably have different write-off criteria for different customer segments. For example, customers with large bills probably have strict criteria, whereas you're probably more lenient with small customers (or vice versa). You differentiate your customers in respect of the collection process via a **collection class code on the customers' accounts**.

An account's initial collection class is defaulted from its customer class. You may override an account's collection class at will.

- You probably have different write-off criteria for different classes of debt. For example, if a customer has both regulated and unregulated debt, you probably have commission-imposed criteria to be applied to the regulated debt, but you have control over how to write-off unregulated debt. You differentiate your debt in respect of the collection process via a write-off **debt class on the customers' service agreements** (note the write-off debt class is actually defined on the SA type and every service agreement has a SA type).

NOTE:

Write Off Debt Class vs. Regular Debt Class. It's important to be aware that a SA type references both a regular debt class and a write-off debt class. The regular debt class controls the collection criteria applied against an account's service agreements. The regular debt class is also used to segregate an account's outstanding balance on several queries in the system. The write-off debt class controls the write-off criteria applied against an account's stopped service agreements. The reason the system supports two different debt classes is because you may categorize your service agreements differently when you try to collect overdue debt versus when you write-off debt.

Given the above, you should understand that different write-off criteria will exist for every combination of collection class and write-off debt class. If you're confused, then consider the following matrix:

SA's Write-Off Debt Class	Account's Collection Class:	
	Commercial Customer	Residential Customer
Regulated	N/A - there is no regulated, commercial customer debt.	Attempt to reduce the SA's balance to zero using the following methods: Synchronize current balance with payoff balance. Attempt to transfer debt to another active service agreement linked to the account. If the debt is < \$10 and > \$-1, write down the debt using a write-down adjustment. If the debt is <= \$-1, create an A/P adjustment to refund the credit to the customer. If debt remains, create the default write-off process for regulated debt.
Unregulated	Attempt to reduce the SA's balance to zero using the following methods: Synchronize current balance with payoff balance. Attempt to transfer debt to another active service agreement linked to the account. If the debt / credit is < \$10 and > \$-10, write down the debt using a write-down adjustment. If the debt / credit is <= \$-10, create an A/P adjustment to refund the credit to the customer. If debt still remains: Highest priority: If customer has a non-cash deposit, create the non-cash deposit write-off process.	Attempt to reduce the SA's balance to zero using the following methods: Synchronize current balance with payoff balance. Attempt to transfer debt to another active service agreement linked to the account. If the debt is < \$10 and > \$-1, write down the debt using a write-down adjustment. If the debt is <= \$-1, create an A/P adjustment to refund the credit to the customer. If debt remains, create the default write-off process for unregulated residential debt.

Otherwise, create the default write-off process
for unregulated commercial debt.

Notice that each cell in the matrix has the same pattern:

- The system first attempts to reduce the SA's current and payoff balances to zero using the following methods (assuming you have set up the write-off control appropriately):
 - Sync the current balance with the payoff balance. If the SA's payoff balance is zero, this will cause the current balance to become zero and therefore close the SA.
 - If there's a debit balance, transfer the debt to any pending start or active SA in the same write-off debt class.
 - If there's a credit balance, transfer the debt to any non-closed / non-cancelled SA in the same write-off debt class
 - If the remaining debit / credit balance is within a user-defined tolerance (this is defined on the respective algorithm on the write-off control), create an adjustment to write-down the small balance.
 - If a credit balance remains, create an A/P adjustment to refund the balance with a check (the adjustment type is defined on the respective algorithm on the write-off control).
- All of the above points will cause the SA to close. If debt remains, the system starts some type of write-off process. The type of process is dependent on the respective criteria. What differentiates one write-off criteria from another is its priority. The higher priority criteria will be compared first. If the customer / debt meets the criteria, the write-off process is initiated; no further comparisons are performed.

FASTPATH:

For more information about maintaining this matrix, refer to [Setting Up Write-off Control](#).

When Is Debt Monitored For Write Off Purposes?

The write-off monitor only reviews a service agreement when the following conditions are true:

- The service agreement is stopped and reactivated.
- If the service agreement is a "billable charge" SA (as identified on its SA type), all of its billable charges must appear on a bill segment AND the bill segment's bill's due date plus grace period must be on or before the business date.
- If the service agreement is not a "billable charge" SA AND it is billable (as identified on its SA type), the SA must have a closing bill segment (i.e., it must be final billed) and the bill segment's bill's due date plus grace period must be on or before the business date.
- If the service agreement is a sub SA, its master SA must abide by the above conditions.
- If the service agreement is not billable, it is possible that adjustments, which affect the SA's debt, exist. The write-off monitor will only review a non-billable SA if all FTs for this SA that have been marked to include on a bill have been swept onto a bill and the bill for any of these FTs has a bill due date plus grace period on or before the business date.

NOTE:

Postponing write-off processing. You can prevent the write-off process from processing an eligible service agreement by populating the account's C&C Postpone Date with a future date.

Attempt To Close The SA Before Creating A Write Off Process

Before the write-off monitor creates a write-off process for a stopped and reactivated service agreement, it attempts to reduce the service agreement's debt to zero using all of the following methods:

- If the account has active service agreements, it will transfer the finalized debt to a pending start or active service agreement.
- If the debt or credit amount on the service agreement is small, the system will generate an adjustment to 'write it down' (or up in the case of a small credit).
- If the service agreement has a large credit amount, the system will generate an A/P adjustment (resulting in a check being sent to the customer).

NOTE:

Plug-in algorithms do the work. Algorithms that are plugged-in on the [write-off control](#) responsible for managing the service agreement's debt actually perform the above effort. You can customize these algorithms to behave exactly how your collections staff desires.

If the algorithms responsible for the above effort are successful in reducing the service agreement's debt to zero, then the service agreement closes and will not be subject to write-off processing. If the above algorithms don't result in the service agreement's debt being reduced to zero, a write-off process will be started (as describe below).

What Happens When A Write-Off Process Is Started?

When you define write-off criteria, you must define the write-off process template to use if the criteria are violated. The system uses this template to create the account-specific write-off process.

Every stopped or reactivated service agreement that is part of the offending write-off debt class will be linked to the write-off process.

Also linked to the write-off process will be one or more write-off events. These events are meant to prod the customer. You define the types of events and when they are generated when you set up your write-off process templates.

It's important to note that all of the write-off events will be created when the write-off process is created. Each of these write-off events contains a trigger date. The trigger date of the first event(s) will typically be the current date. The trigger date of the other events will be in the future. Refer to [Calendar vs Work Days](#) for a description of how the trigger date is calculated.

A separate process, Activate Write-off events, is responsible for activating write-off events whose date is on or before the current date. Activation of an event causes the system to do whatever the event indicates (e.g., send a letter, send a To Do to an operator, refer debt to a collection agency, etc.)

NOTE:

Multiple write-off processes may be kicked off. It's important to be aware that if an account's service agreements reference multiple write off debt classes, a write-off process will be started for each offending write off debt class that has stopped or reactivated service agreements.

FASTPATH:

For more information about write-off process templates, see [Setting Up Write Off Process Templates](#). For more information about write-off events, see [The Big Picture Of Write-off Events](#). For more information about how a write-off process is cancelled, see [How Does A Write-Off Process Get Cancelled?](#).

How Does A Write-Off Process Get Cancelled?

The system "removes" a service agreement from a write-off process when its status becomes closed (i.e., when its balance is zero). When all service agreements are removed, the system cancels all pending write-off events and deactivates the write-

off process. When the write-off process is deactivated, all collection agency referrals associated with the write-off process are cancelled.

NOTE:

Removing closed service agreements from a write-off process. Service agreements aren't actually removed from the process. Rather, they are inactivated so a proper audit exists.

How Do Collection Agency Referrals Work?

The following points describe how collection agency referrals work.

- A write-off process has one or more events. One type of event causes overdue debt to be referred to a collection agency.
- When a referral write-off event is activated, the system marks the event for processing by the event's Collection Agency Referral Algorithm (refer to [Setting Up Write Off Event Types](#) for more information).
- The next time the Collection Agency Referral process executes (the frequency is dependent on your background process schedule), it will refer the process' debt to a collection agency. The specific agency to which the debt is referred is controlled by the event type's Collection Agency Referral Algorithm. The sample algorithm supplied with the system simply refers debt to the collection agency with the least amount of referred debt. If you prefer different logic, you must write your own algorithm.
- Regardless of the manner in which a collection agency is selected for an account's debt, the referral involves the creation of a collection agency referral history record. Refer to [Collection Referral](#) for more information.
- A collection agency referral history record is linked to an account. It contains the amount of debt referred to the collection agency. It is the creation of this record that, in turn, triggers the interface of information to the collection agency. The method used to interface the information to the agency is defined on the collection agency's record. Refer to [Setting Up Collection Agencies](#) for more information.
- If the collection agency is successful in obtaining the funds, simply add a payment. If the payment causes the SA's balance to become zero, the system will automatically close the service agreement. When the system closes a service agreement, it is "removed" from the write-off process. When a write-off process no longer contains active service agreements, the system cancels the write-off process. When a write off process is cancelled, all collection agency referrals are automatically cancelled.
- Collection agency referrals get cancelled by the creation of a new collection agency referral history record (with a type of cancel). This record will be interfaced to the agency in the same manner used to interface a new referral (see above).
- If the collection agency is not successful in obtaining your funds after a given amount of time, you probably want to cancel the referral and write-off the debt. The cancellation of the referral will happen automatically if you design your write-off process to generate a collection agency cancellation X days after the referral. Refer to [Setting Up Write Off Process Templates](#) for how to do this. You can cancel a referral manually by simply creating a new collection agency referral history record (with a type of cancel).

FASTPATH:

When you enable the Control Central alert algorithm, C1-COLL-REF, an alert displays when an account has an active collection agency referral. This algorithm is plugged-in on the [installation record](#).

The Big Picture Of Write-off Events

This section describes the various types of write-off events and their lifecycle.

How Are Write-off Events Created?

Write-off events may be created as follows:

- The Write-Off Monitor creates a write-off process when an account has unpaid, final billed service agreements. The write-off process has one or more write-off event(s). Refer to [How Does The Write-Off Monitor Work?](#) for more information about how the system creates write-off processes and their events.
- Write-off events are created when an operator creates an ad hoc write-off process. The number and type of events is controlled by the write-off process template defined when the write-off process is created.
- An ad hoc write-off event may be created and linked to an existing write-off process by an operator at their discretion.

NOTE:

Bottom line. Most write-off events are created by the system when it creates a write-off process for unpaid, finalized service agreements. If you need to create an ad hoc write-off event, you can either create a write-off process using a template that contains the desired event OR link the desired event to an existing write-off process.

FASTPATH:

For more information about creating ad hoc write-off processes and events, refer to [How To Perform Common Write-off Maintenance Functions](#).

Types Of Write-off Events

The following table describes the various types of write-off events and what happens when they are completed:

Type Of Write-off Event	What Happens In The System
Affect Credit Rating/Cash-Only	An account credit rating demerit record is created. The number of demerits is defined on the write-off event type.
Cancel Agency Referral	All collection agency referrals associated with the write-off process will be cancelled.
Refer to Agency	The debt associated with the SAs linked to the write-off process will be referred to a collection agency.
Send Letter	A customer contact is created for every financially responsible person linked to the account. The customer contact causes a letter to be produced. The type of letter is defined on the customer contact type control table. The recipient of each letter is defined on Account / Person (those persons marked as Receiving Notifications).
Send To Do	A To Do entry is created. Refer to The Big Picture of To Do Entries for more information about To Do entries.
Write Off using Distrib Code	This type of event is used to write-off bad debt in accordance with the distribution codes associated with the financial transactions that caused the debt in the first place. You'd use this method for example if you want to write-off revenue differently than you write-off liabilities. The system accumulates the distribution codes from GL details associated with recent financial transactions linked to each write-

off service agreement. When the system has accumulated enough distribution codes (i.e., where the amount associated with the distribution code equals or exceeds the amount to write off), the debt will be transferred to a new or existing write-off service agreement. The type of service agreements to which the debt is transferred is defined on the distribution codes.

Write Off using SA Type

The service agreements linked to the process will be written-off by transferring their debt to a new or existing write-off service agreement. Note: the SA type of the write-off service agreement is defined on the algorithm defined on events of this type.

Generic Algorithm

The system calls the algorithm defined on the write-off event type. This type of event is used when what you need to do isn't handled by one of the above event types.

FASTPATH:

Refer to [Setting Up Write Off Event Types](#) for more information.

Write-off Event Lifecycle

The following diagram shows the possible lifecycle of a write-off event:

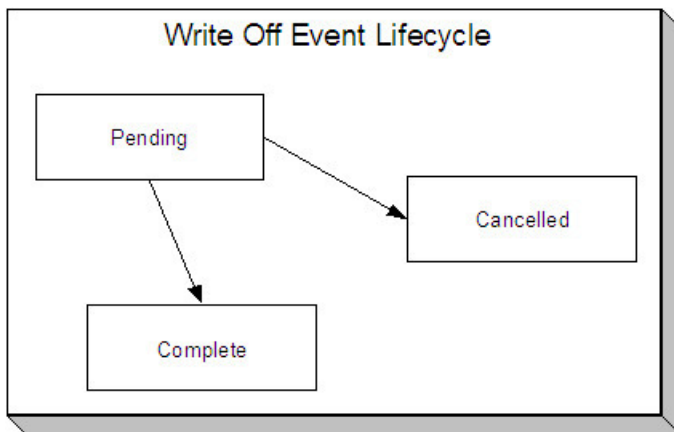

Write-off events are initially created in the pending state.

When the system sees a pending event with a trigger date on or before the current date, the system executes the event's activity and completes the event.

FASTPATH:

For more information about a write-off event's trigger date, see [Write-off Event Trigger Date](#).

A pending event will be cancelled automatically by the system when the service agreements linked to the process are all closed (i.e., they no longer have debt - either because it was paid or transferred to a write-off service agreement). A pending event may be cancelled by an operator at their discretion.

Write-off Event Trigger Date

When a write-off event is created by the system, its trigger date is set in accordance with your date arithmetic preferences. Refer to [Calendar vs. Work Days](#) for more information.

How Are Write-off Events Completed

A background process runs periodically (at least daily) that looks for write-off events with a trigger date on or before the current date. For each triggered event, the system executes its activity and then completes it. Refer to [Write Off Event Activator](#) for more information.

The Last Write-off Event Should Write Off All Debt Associated With All SAs

The last write-off event will typically transfer all debt from the service agreement's linked to the process to a write off service agreement (linked to the account). This will only happen if you set up the write-off process template accordingly (i.e., the last event in the write-off process template is the kind that writes off debt for every service agreement linked to the write-off process).

How Are Write-off Events Canceled?

The system removes a service agreement from a write-off process when its status becomes closed (i.e., when its balance is zero). Be aware that any type of financial event could cause an SA's balance to fall to zero (e.g., the creation of an adjustment, the application or cancellation of a payment, the cancellation of a bill, ...). When all service agreements are removed, the system cancels all pending write-off events and deactivates the write-off process.

NOTE:

Real time cancellation. Unlike collection processes, the system cancels write-off processes real time when the service agreement becomes closed (i.e., there is no background process that monitors write-off processes).

Besides the automated cancellation process, an operator may cancel a write-off event at will.

NOTE:

Removing closed service agreements from a write-off process. Service agreements aren't actually removed from the process. Rather, they are inactivated so a proper audit exists.

Calendar vs. Work Days

When you set up your collection, severance and write-off process templates, you supply information that controls how the system determines the trigger date of each event in the related process. There are two different mechanisms for doing this:

- When you set up your severance process templates, you must define the number of days between each event. For example, the second event (send cutoff warning) may need to be triggered 7 days after the first event (send reminder letter).
- When you set up your collection and write-off process templates, you must define the number of days after the start of the process when each event should be triggered. For example, the second event (send cutoff warning) may need to be triggered 7 days after the start of the collection process.

The system uses this information in conjunction with the account's division's work calendar when it allocates a trigger date to the various collection, severance, and write-off events in your processes. The system offers you the following choices in respect of how it calculates an event's trigger date:

- You can indicate that the trigger date should be set to the next possible workday. For example, if you indicate that the second event is triggered 7 days after the first event, the system will add 7 days to the first event's completion date. It then checks if this is a workday (and not a holiday), if so, this is the trigger date of the event; if not, it assigns the trigger date to the next workday.
- You can indicate that the trigger date should be calculated by counting workdays. For example, if you indicate that the second event is triggered 7 days after the first event, the system will count 7 workdays (using the account's division's work calendar), and set the trigger date accordingly.

You must define which of the above methods is used in the following processes:

- Account Debt Monitor (ADM). Refer to [The Account Debt Monitor](#) for more information.
- Collection Event Trigger (CET). Refer to [The Collection Event Activator](#) for more information.
- Severance Event Set Trigger Date (SED). Refer to [Set Trigger Date](#) for more information.
- Write-off Monitor (WPM). Refer to [The Write Off Monitor](#) for more information.

The Big Picture Of Payment Arrangements and Pay Plans

The topics in this section describe two different mechanisms that allow a customer to payoff overdue debt in installments.

The Big Picture Of Payment Arrangement Requests

A Payment Arrangement Request is used to manage the process of starting a payment arrangement. It is a step-by-step process that can include:

- Checking the account's eligibility for payment arrangement
- Capturing the terms of the payment arrangement such as the included service agreements, down payment amount, number of installments and installment amount
- Evaluating whether or not the payment arrangement request requires approval
- User approval / rejection of the payment arrangement request
- Monitoring for the down payment, if applicable
- Creating the payment arrangement service agreement

The topics in this section describe how payment arrangement requests work.

Lifecycle Of A Payment Arrangement Request

The base product provides a Payment Arrangement Request (**CI-PARrequest**) business object that supports the functions needed to create a payment arrangement. Its lifecycle allows for managing and monitoring of the prerequisites of a payment arrangement:

- The first step in the payment arrangement request process is typically to check that the account is eligible for a payment arrangement. One or more eligibility criteria are executed and an overall assessment is made on the results, to determine the account's eligibility/ineligibility. The request goes into the **Eligibility Checked** state. The results are shown on the user interface, for the user to determine the next step.
- If the account is ineligible for a payment arrangement, the request process ends. The payment arrangement request goes into the **Denied** state.

- If the account is eligible, the process can proceed with setting up the terms of the payment arrangement. The agreed upon terms are submitted and the request proceeds to the next step. If there are no prerequisites (approvals, down payment etc.), the request can automatically go to the **Granted** state, where the payment arrangement service agreement is created
- A payment arrangement request may be subject to prior approval if it meets certain criteria — e.g. the payment arrangement amount exceeds a threshold amount. The payment arrangement request goes into the **Approval In Progress** state, where an authorized user will need to review the request and **Approve** or **Reject** it accordingly.
 - If the user approves the request, the request will proceed to the next step — i.e. either another prerequisite (such as a down payment) or granting the request.
 - If the user rejects the request, the request will automatically go to the **Denied** state.
- If a down payment must be paid prior to starting the payment arrangement, the request will stay in the **Waiting for Down Payment** state until the payment is received or until the down payment due date.
 - If the down payment is paid (i.e. according to implementation-specific criteria for considering it paid), the payment arrangement request goes into the **Granted** state, where the payment arrangement service agreement is created. The account's SA balances to include in the payment arrangement are recalculated, based on the actual down payment that was received.
 - On the other hand, if the down payment is not received or is received but insufficient, the payment arrangement request goes into the **Unpaid Down Payment** state.
- A payment arrangement in a **Waiting for Down Payment** or **Approval In Progress** state can be **Withdrawn**. This is for cases where a customer decides to not proceed with the payment arrangement.
- Any issues encountered during the recalculation of the SA balances or during the creation of the payment arrangement service agreement can put the request into the **Error** state.

Refer to the Payment Arrangement Request business object, for more details on these lifecycle rules.

Payment Arrangement Eligibility

An account's eligibility for payment arrangement is typically checked at the start of the request process. Based on the results of these eligibility checks, a user can determine whether or not the payment arrangement request can proceed.

Since the eligibility rules can vary across implementations, the base product provides plug-in spots on the Payment Arrangement Request Type (**C1-PARequestType**) business object for eligibility checking:

- The **PA Request Type – Eligibility Criteria** algorithm spot is responsible for checking specific conditions or activity on the account, to determine payment arrangement eligibility. Algorithms of this type commonly return a simple Pass/Fail result. The base product supplies a sample algorithm that checks the account's past broken payment arrangements.
- The **PA Request Type — Criteria Assessment** algorithm spot is responsible for taking the results of the execution of **PA Request Type – Eligibility Criteria** algorithms and determining the overall result, which is whether or not the account is eligible for payment arrangement. The base product supplies two sample algorithms for this spot:
 - One algorithm type checks for at least one Fail result from the **PA Request Type – Eligibility Criteria** algorithms and if it finds one, returns an *Ineligible* result
 - Another algorithm type simply returns an *Eligible* result. This is for implementations that do not need **PA Request Type – Eligibility Criteria** algorithms. This default algorithm would be the only algorithm to plug in.

Payment Arrangement Request Approval

A payment arrangement request may require prior approval, based on the terms specified on the request. For instance, if the total payment arrangement amount exceeds a set threshold amount, the request may have to be routed to another user for approval. That user will need to review the request and Approve or Reject accordingly.

Since the approval requirements are implementation-specific, the base product provides a **PA Request Type — Determine Approval Requirement** plug-in spot on the Payment Arrangement Request Type (**C1-PARequestType**) business object. Algorithms of this type return an indicator of whether or not approval is needed. If the algorithm indicates that approval is needed, the payment arrangement request will go into the **Approval In Progress** state until a user reviews and approves/rejects the request.

Your implementation must configure an algorithm with your specific approval criteria. The base product does not currently supply an algorithm type for this spot.

Payment Arrangement Down Payments

A down payment may be required/applicable as a prerequisite for starting the payment arrangement.

A setting on the Payment Arrangement Request Type controls whether down payments are required/optional/not applicable. If down payments are required or optional, the payment arrangement request type defines the down payment options, which are percentages of the total payment arrangement amount or a flat amount.

The down payment due date is calculated based on settings in the Payment Arrangement Request Type – e.g. number of days till due.

The down payment is monitored for the actual payment:

- If the down payment is paid, the request is granted. The SA balances are recalculated based on the down payment amount that was paid and the payment arrangement service agreement is created.
- If the down payment is unpaid or is insufficient (based on the implementation's rules), the request is denied and the payment arrangement service agreement will not be created.

Refer to the Payment Arrangement Request Type (**C1-PARequestType**) business object for more details on down payment option configuration and to the Payment Arrangement Request (**C1-PARequest**) business object, to see the monitor algorithm that checks if the down payment was made.

Setting Up Payment Arrangement Request Control Tables

This section describes the control tables needed to set up payment arrangement requests.

Setting Up Payment Arrangement Request Types

A payment arrangement request type defines properties that control how a request for payment arrangement is processed.

Refer to [The Big Picture Of Payment Arrangement Requests](#) for an overview of payment arrangement request functionality.

To maintain payment arrangement request types, open **Admin > Credit & Collection > Payment Arrangement Request Type > Search**.

This is a standard [All-In-One Portal](#).

Refer to the embedded help text for more information on the fields.

Setting Up Payment Arrangement Request Reasons

A payment arrangement request can capture the specific reason why a customer is asking to go on a payment arrangement. This reason is optional if using the base-owned Payment Arrangement Request (**C1-PARequest**) business object and the Payment Arrangement Request Process Flow Type (**C1-PAREQUEST**) on your Payment Arrangement Request Types.

To use Payment Arrangement Request Reasons, configure your specific values on the **C1-PARequestReasonLookup** extendable lookup. No base values are supplied for this lookup.

Setting Up Payment Arrangement Request Status Reasons

The Payment Arrangement Request (**C1-PARequest**) base business object provides the option to specify the reason for the request going into the **Denied** or **Canceled** state.

A few base-owned status reasons are supplied. To add other reasons for payment arrangement request cancellation/denial, go to the Status Reason portal and update the **C1-PARequest** business object's status reasons for the Denied and Canceled states.

Automatically Cancelling Inactive Payment Arrangement Requests

The system is delivered with a batch process, Cancel Inactive PA Requests (C1-ACPAR), that can be used to cancel payment arrangement requests that have been open for more than a specified number of days. Refer to the batch control description for more detail.

The delivered process is built using the [Plug-in Driven Background Processes](#) framework. Your implementation can introduce alternate logic, by duplicating this batch control and replacing the select and/or process records algorithms. For example, you can introduce a process record algorithm to create a To Do Entry instead of cancelling the payment arrangement request. Adjust the batch parameters according to your custom logic, if needed.

The Big Picture Of Pay Arrangements

A payment arrangement is an agreement with a customer to payoff severely overdue debt in **billed** installments. Bills sent to customers with payment arrangements contain charges for both their current services and their payment arrangement installment amount.

NOTE:

Nomenclature. Some people refer to payment arrangements as "current bill plus" agreements because the customer's bills contain charges for both their current debt plus their installment amount. After the customer has paid off their overdue debt, the customer's bill only contains charges for their current debt.

The topics in this section describe how to set up a payment arrangement and how the system monitors the ongoing arrangements.

Creating Payment Arrangements

When you create a payment arrangement, you are actually creating a service agreement. This service agreement is just like other service agreements in that:

- It holds debt.
- It is periodically billed.

- When a payment is received, the service agreement's debt is reduced.
- If the service agreement becomes delinquent, a collection process is initiated to collect the overdue debt.

Debt is transferred to a payment arrangement service agreement (PA SA) from the customer's delinquent service agreements (SAs) at the inception of the payment arrangement.

When you transfer delinquent debt from the delinquent SAs to the PA SA, the debt is removed from the delinquent SAs. If you transfer all debt from the delinquent SAs, the customer will no longer be in arrears in a given debt class (and if the customer is no longer in arrears, active collection and severance processes will be cancelled).

NOTE:

Use the Payment Arrangement Request Transaction. You could do the above functions by adding a new service agreement and creating transfer adjustments. However, this is tedious. Rather, use the [Payment Arrangement Request process](#). This process is recommend when requests for payment arrangements require eligibility checking and other prerequisites such as down payments and approvals. When a payment arrangement request is granted, it creates the PA SA, transfers debt to it, and sets up the installment amount.

You can also create the payment arrangement service agreement directly using the [Payment Arrangement](#) transaction if you don't require any prior eligibility checks, down payments or approvals. This transaction is also used if you need to break or cancel the payment arrangement.

Installment, Payoff and Current Amounts

WARNING:

If you do not understand the difference between payoff balance and current balance, refer to [Current Amount versus Payoff Amount](#).

When you set up a payment arrangement service agreement (PA SA), you transfer delinquent debt to the PA SA using transfer adjustments. After moneys are transferred, the system sets the PA SA's current balance to zero. At this point, neither the original service agreements nor the PA SA have delinquent debt. If the customer neglects to pay their payment arrangement, the PA SA will fall into arrears and a collection process will ensue. If the customer neglects to pay their previously delinquent SAs, they will again fall into arrears and a collection process will ensue.

PA SAs start their life with a non-zero payoff balance (i.e., they have debt when first started). This debt is transferred from the normal service agreement(s) whose outstanding debt necessitated the creation of the PA SA.

The installment amount that the customer is billed is determined by the number of installments used to payoff the debt. For example, if the customer owes \$500 on their electric and water service agreements and they want to pay this off in 10 installments, you'd set up the installment amount to be \$50. The installment amount is saved on the PA SA's recurring charge amount. If the customer again falls into arrears on their normal service agreements, you can transfer additional delinquent debt to the PA SA. You can also change the installment amount as needed.

A PA SA's payoff balance typically differs from its current balance. The payoff balance is the amount of debt remaining to be paid off under the terms of the payment arrangement. The current balance is the installment amount that has been billed but not paid. For example, a customer who is paying off \$500 with 10 installments of \$50 would have an initial payoff balance of \$500 and a current balance of \$0. After the first bill, the PA SA would still have a payoff balance of \$500, but its current balance would be \$50. When the customer pays, the PA SA's payoff balance would fall to \$450 and its current balance would return to \$0.

The following table contains a financial example of a customer who sets up a payment arrangement to payoff \$1,000 of debt in \$10 installments.

Event	Normal SA's GL Accounting	PA SA's GL Accounting	Normal SA's Current Balance	Normal SA's Payoff Balance	PA SA's Current Balance	PA SA's Payoff Balance
-------	---------------------------	-----------------------	-----------------------------	----------------------------	-------------------------	------------------------

Prior to creation of payment arrangement	N/A	N/A	1000	1000	N/A	N/A
Transfer debt from normal SA(s) to PA SA	Xfer 1000 A/R <1000>	PA A/R 1000 Xfer <1000>	0	0	1000	1000
Set current balance to zero on PA SA	N/A	N/A	0	0	0	1000
Customer is billed (\$50 for new debt and \$10 of payment arrangement debt)	A/R 50 Revenue <50>	N/A	50	50	10	1000
Customer pays \$60	Cash 50 A/R <50>	Cash 10 PA A/R <10>	0	0	0	990

When the customer pays off the payment arrangement debt, the system automatically closes the PA SA after it final bills (assuming the PA SA's SA type references a bill segment type that has a bill segment creation algorithm of Recurring Charge With Auto Stop).

Monitoring Payment Arrangements

The PA SA should belong to its own debt class (let's call it Payment Arrangement Debt) so that you can have stricter collection criteria for payment arrangement debt (as compared to normal SAs). Because there will be a new debt class, there will be a unique collection class control (CCC) for payment arrangements. This CCC will have debt criteria associated with payment arrangement debt. If these criteria are violated, we will kick off a collection process that should have 1 collection event - Start Severance.

The severance process template for PA SAs will have 1 severance event that calls the Break Payment Arrangement Event algorithm. This algorithm does the following:

- Cancels ALL adjustments that were used to transfer the debt to the payment arrangement (identified by the XFER adjustment type on the PA SA's SA type). When these are cancelled, the original arrearage will be reinstated under the original SAs - this debt should be rather old by this point.
- Syncs up current balance with payoff balance on the PA SA.
- Makes the PA SA pending stop (SA activation will stop the SA when it next runs).
- If there is a credit left on the PA SA (because payments were made against the arrangement), the credit will be distributed amongst the account's debt using the standard distribution algorithm. Because the payment arrangement debt that was reinstated should be rather old, it should get relieved first. This relief will occur via transfer adjustments from the PA SA to the original SAs.
- If there is a debit left (e.g., because LPC were issued or some other type of adjustment was created by an operator), the debt will be transferred back to one of the SAs from which the arrangement was originally created.
- Inserts a characteristic under the PA SA to indicate that it has been broken (we need this for the account debt monitor (ADM) a few steps down).
- Inserts a row on the account debt monitor trigger. This trigger will cause the account to be reviewed by the ADM the next time it runs.

NOTE:

The PA SA must final bill before it closes. The PA SA will only close after the PA SA is final billed. This is OK as it won't have any money left on it.

When the ADM next runs, it will analyze the account's reinstated debt. We recommend creating a new override collection criteria for the normal debt class that will return a value of true if the account has a closed payment arrangement that has been broken in the last X days (where X is a parameter of the override collection criteria's algorithm). If this algorithm returns a true, kick off a unique collection process template (that has nasty events). A sample algorithm of this type is supplied in the base package - COLL COND PA.

To complete this discussion, we have to worry about the situation when the final bill of a payment arrangement goes unpaid. In this situation, the payment arrangement is stopped and will therefore not be processed by the ADM. In this case, the write off monitor will process the PA SA after its final bill's due date and a write-off process will start. This write off process will have a single event that calls the Break Payment Arrangement algorithm (described above). After the FT's are issued in this event, the SA will close (because it's been final billed and its balance will go to zero).

The Big Picture Of Pay Plans

A pay plan (PP) is an agreement with a customer to make payments on specific dates. Pay plans differ from payment arrangements in that pay plans have user-defined scheduled payment dates, which are independent from the customer's billing dates. In other words, payment arrangements appear on the customer's bills, pay plan scheduled payments do not.

If a customer is in arrears and you want to receive payments on specific dates (as opposed to with the customer's regular bills), you would set up a pay plan and define the dates on which you expect the payments.

The topics in this section describe how pay plans work.

A Pay Plan Has One Or More Scheduled Payments

When you create a pay plan for an account, you must define the number of scheduled payments and their respective amounts. There is no limit to the number of scheduled payments that may be set up under a pay plan.

Automatic Payments Can Be Created On The Scheduled Payment Dates

The system will create automatic payments on a pay plan's scheduled payment dates if:

- The account is set up for automatic payment (as described under [How To Set Up A Customer To Pay Automatically](#)), and
- The payment method defined on the pay plan indicates automatic payment is being used

The background process called PPAPAY is responsible for creating these automatic payments. It does this by calling the automatic payment creation algorithm plugged in on the installation record.

NOTE:

If the **Autopay Creation Option** on the [installation record](#) is set to Create On Extract Date, the automatic payment is NOT distributed and frozen when the automatic payment is initially created. Rather, a separate background process ([APAYDSFR](#)) distributes and freezes the automatic payment on the automatic payment GL distribution date (refer to [Automatic Payment Dates](#) for more information on how this date is calculated). Refer to [Automatic Payments](#) for more information.

A Pay Plan Insulates Overdue Debt From The Account Debt Monitor

A pay plan's scheduled payments are used by the account debt monitor as "pseudo payments" that relieve the account's debt before it is subjected to the collection criteria (refer to [How Does The Account Debt Monitor Work](#) for more information about collection criteria).

It's important to understand that a pay plan only insulates the account's debt that belongs to the pay plan's debt class. Therefore, if a customer has debt that belongs to two debt classes (e.g., normal debt and 3 rd party pass through debt), you would need to set up a separate pay plan for each debt class (assuming both types of debt are covered by a pay plan). Refer to [Different Collection Criteria For Different Customers and Different Debt](#) for more information about debt classes.

A Pay Plan Must Reference A Pay Plan Type

When you create a pay plan, you must define its pay plan type. The pay plan type controls the following functions:

- The debt class whose debt is insulated by the pay plan.
- The type of algorithm (if any) that is executed when the pay plan is broken. You might use such an algorithm to affect the customer's credit rating when the pay plan is broken.

A Pay Plan May Reference A Third-Party Payor

In addition to referencing the account whose debt is insulated by the pay plan, the pay plan must also reference the account that is responsible for making the payments. We refer to this second account as the pay plan's "payor".

While the payor's account is typically the same as the account whose debt is insulated by the pay plan, you can indicate a third-party payor (e.g., a social service agency) is responsible for making the pay plan's scheduled payments.

If your organization allows third-party payors, you can define each on the third-party payor control table. This control table exists to simplify the data-entry effort when you create a pay plan (as it defines the account associated with the third-party payor).

NOTE:

If a pay plan does not reference a third-party payor, any non-third-party payor (i.e., any account that is not defined in the third-party payor control table) can make payments on behalf of the customer. If a pay plan references a third-party payor, only payments made by the third party on behalf of the customer are counted towards the fulfillment of the pay plan.

The Lifecycle Of A Pay Plan

The following diagram shows the possible lifecycle of a pay plan:

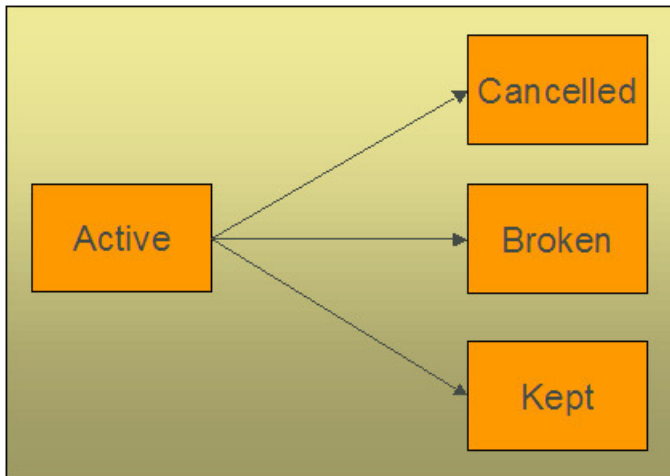

The following points explain this lifecycle:

- Pay plans are initially created in the active state. Active pay plans are monitored for compliance by [The Pay Plan Monitor](#).
- A pay plan may be cancelled as follows:
 - A user can cancel a pay plan at will.
 - When a SA is stopped AND there are no other active SAs in the same debt class, all **Active** pay plans associated with the account and debt class will be will be **Canceled** .
 - The activation of a collection event that calls the "cancel pay plan" algorithm will cancel all active pay plans associated with the collection process's debt class. You may want to use such a collection event if your organization cancels active pay plans when new debt causes a collection process to kick-off. Note, the base package algorithm that performs this function will not cancel the pay plan if it's associated with a 3rd party payor.
- [The Pay Plan Monitor](#) causes active pay plans to become broken if sufficient payments have not been made to satisfy the pay plan's scheduled payments.
- [The Pay Plan Monitor](#) causes active pay plans to become kept when it detects that sufficient payments have been made to satisfy the pay plan's scheduled payments.

Highlighting The Existence Of Broken / Kept / Active and Denied Pay Plans

You can define on the installation record plug-in algorithms that format alert messages. (Refer to [Installation Options - Algorithms](#) for additional information.) We recommend that you take advantage of the following algorithms to highlight pay plans:

- Highlight pay plans in a given status. This algorithm is used to highlight pay plans in a given state (broken, kept, cancelled) that were started within the last X days.
- Highlight customer contacts of a given type. This algorithm would be used to highlight customer contacts of a given type that were created within the last X days. This would be useful if you create a specific type of customer contact when you deny a pay plan. Some utilities do this to prevent customers from shopping around.

In addition, you can define account-specific alerts to highlight customers that should never be allowed to have a pay plan (for whatever reason).

A Pay Plan Must Reference A Payment Method

When you create a pay plan, you must define how the customer will make the payments by referencing a payment method. Examples of payment methods include: In Person , Wire Transfer, By Post, Express Mail, etc.

The payment method is more than just documentation as it defines the number of grace days the customer has to make the pay plan's scheduled payments. For example, if you set up the payment method control table to indicate that payments made By Post have 3 grace days, then the customer has up to 3 days after each scheduled payment date to make the payment. If payment is not received by the scheduled payment date plus the grace days, the pay plan will be marked as broken (and the ADM will be triggered).

The Pay Plan Monitor

FASTPATH:

Please understand the concepts described in [The Lifecycle Of A Pay Plan](#) and [The Tendering Account May Differ From The Account Whose Debt Is Relieved](#) before reading this section.

The Pay Plan Monitor background process (referred to as PPM) is responsible for monitoring active payment plans. This process can cause a pay plan (PP) to become kept or broken (or being left as active).

NOTE:

When is a pay plan marked as broken / kept? It's important to understand that only the PPM can cause a pay plan to become kept or broken. This means that if a customer makes a payment that satisfies a pay plan, the pay plan will only be marked as kept when the pay plan monitor next runs. Analogously, if a payment is cancelled, nothing will happen to an active pay plan until the PPM next runs. When the PPM next runs, it will see that the scheduled payment was not kept and it will break the pay plan and schedule the ADM to be executed. When the ADM next executes, it will create a collection process (because the customer's debt will no longer be insulated by the pay plan's scheduled payments).

NSF Cancellations After A Pay Plan Is Kept. If a payment is cancelled due to non-sufficient funds (NSF) after a pay plan is marked as kept, the pay plan will remain kept. But keep in mind that the pay plan's account is scheduled for review by the ADM when a payment is cancelled due to NSF. When the ADM reviews the account's debt, it will no longer have an active pay plan to insulate it and the account's debt will likely trigger a new collection process. Refer to [How Pay Plans Affect The Account Debt Monitor](#) for more information.

The following points describe, at a high level, how the PPM monitors a pay plan (PP) for compliance.

- The system selects all frozen, non-cancelled payment segments associated with the PP's account and debt class where:
 - The payment date is after the start date of the pay plan, and
 - The payment's pay event has at least one tender that references the pay plan's payor.
- The system logically reduces / removes past and current scheduled payments (starting with the earliest scheduled payment) until the total amount of payment segments is exhausted (or there are no more historical / current scheduled payments).

NOTE:

Paying pay plans in advance. Scheduled payments with a future date are not logically removed / reduced. This means that if a customer makes advance payments on a pay plan, it will not be marked as kept until all scheduled payment dates are in the past.

- If all scheduled payments have been logically removed, the pay plan is marked as kept.
- If there exist scheduled payments where the pay date + grace days (grace days are defined on the pay plan's payment method) is before the current date (i.e., a payment doesn't exist for a scheduled payment):
 - The pay plan is marked as broken.

- The PP's break algorithm (if any) is called (note, for European / Australian pay plans, there are scenarios where the break algorithm can cause the pay plan to become unbroken - when there aren't at least two missed, historical scheduled payments).
- An ADM trigger is stored for the PP's account. This will cause the account to be reviewed by the ADM the next time it runs. And because the pay plan is broken, its scheduled payments will no longer insulate the account's arrearage.

IMPORTANT:

It's important that you schedule the PPM to run before the ADM so that it can break unpaid payment plans prior to the ADM subjecting the account's debt to collection criteria. Refer to [How Pay Plans Affect The ADM](#) for more information.

How Pay Plans Affect The Account Debt Monitor

As described under [A Pay Plan Insulates Overdue Debt From The Account Debt Monitor](#), a pay plan's scheduled payments insulate an account's debt from the ADM. This section describes how this is accomplished.

WARNING:

You should understand the concepts in [How Does The Account Debt Monitor Work](#) and [The Tendering Account May Differ From The Account Whose Debt Is Relieved](#) before reading the following.

NOTE:

The ADM will be triggered when a pay plan is broken. Refer to [The Pay Plan Monitor](#) for an explanation of how the ADM is triggered when a pay plan is broken.

Before the ADM subjects an account's debt to the collection criteria, it calls the debt's debt class's Override Arrears Algorithm (this is an optional plug-in spot on [Debt Class](#)). This algorithm is passed the debt class's aged debt and manipulates it as follows:

- First, a list of all past, present and future scheduled payments associated with the account and debt class's active pay plans is constructed.
 - If multiple payors are encountered (because the customer has multiple pay plans and these have different payors), a separate list of scheduled payments is maintained for each payor.
- Next, for each payor, retrieve the total amount of frozen, non-cancelled payment segments made on behalf of the pay plan's account and debt class.
 - Select all frozen, non-cancelled payment segments associated with the pay plan's account and debt class whose pay date is \geq pay plan's start date and the pay segment's event has at least one tendering account associated with the pay plan's payor.
- Next, logically reduce / remove past and current scheduled payments (starting with the earliest scheduled payment) until the payor's payment amount is exhausted (or there are no more historical / current scheduled payments). Future scheduled payments cannot be remove / reduced.
- Finally, reduce the passed in aged debt with any unpaid scheduled payments.

NOTE:

This logic is not "hard coded". Rather, the mechanism used to use a pay plan's scheduled payments to reduce debt is defined in an algorithm defined on the pay plan's debt class. The contents in this section describe how a base package algorithm works. Because it's an algorithm, you can introduce whatever logic you please.

The following is an example of how pay plans affect aged debt.

Date	Event	SA's Arrears	SA's Balances	Scheduled Payments
Prior to creation of the PP 1/18/2000		\$1,000 - 90 days old \$1,600 - 60 days old \$1,900 - 30 days old	Current: \$4,500 Payoff: \$4,500	
1/18/2000	Pay Plan created. The \$4,500 in future scheduled payments offsets the existing \$4,500 of aged debt.	\$1,000 - 90 days old \$1,600 - 60 days old \$1,900 - 30 days old De facto ADM debt: \$0	Current: \$4,500 Payoff: \$4,500	1/20/2001 \$1,500 2/01/2001 \$1,500 2/07/2001 \$1,500
1/20/2001	The customer pays \$1,500. There exists \$3,000 of future scheduled payments that offset the arrears	\$1,100 - 62 days old \$1,900 - 32 days old De facto ADM debt: \$0	Current: \$3,000 Payoff: \$3,000	1/20/2001 \$1,500 "Paid" 2/01/2001 \$1,500 Future 2/07/2001 \$1,500 Future
1/20/2001	ADM runs. The \$3000 in future scheduled payments offsets the Current Balance of \$3000, so CC events not created.	\$1,100 - 62 days old \$1,900 - 32 days old De facto ADM debt: \$0	Current: \$3,000 Payoff: \$3,000	1/20/2001 \$1,500 "Paid" 2/01/2001 \$1,500 Future 2/07/2001 \$1,500 Future
1/24/2001	A new bill is created for \$400	\$1,100 - 62 days old \$1,900 - 32 days old \$400 - 1 day old De facto ADM debt: \$400 - 1 day old	Current: \$3,400 Payoff: \$3,400	1/20/2001 \$1,500 "Paid" 2/01/2001 \$1,500 Future 2/07/2001 \$1,500 Future
2/2/2001	Pay Plan Monitor runs. PP marked as Broken because the 2/1/2001 scheduled payment has not been paid (assuming no grace period on the pay plan's payment method)	\$1,100 - 74 days old \$1,900 - 44 days old \$400 - 8 days old	Current: \$3,400 Payoff: \$3,400	1/20/2001 \$1,500 "Paid" 2/01/2001 \$1,500 "Late" 2/07/2001 \$1,500 Future
2/2/2001	ADM runs. There are no active pay plans and therefore there is nothing to insulate the customer's debt. Therefore the aged debt will be subjected to the collection criteria and an appropriate collection process will be created.	\$1,100 - 74 days old \$1,900 - 44 days old \$400 - 8 days old De facto ADM debt is the same as above (i.e., rather old)	Current: \$3,400 Payoff: \$3,400	Pay plan is broken and therefore its scheduled payments cannot be used.

Collection Process / Severance Process Cancellation

When a pay plan (PP) is created, the system determines if it can cancel active collection and severance processes associated with the pay plan's account and debt class. It does this because a pay plan's scheduled payments act as "pseudo payments" that relieve the account's debt (temporarily). The following points describe how this works:

- The system attempts to cancel collection processes by calling the Collection Process Cancel Criteria Algorithm defined on the debt class that is associated with the collection process. This algorithm is meant to cancel a collection process if the sum of ALL service agreements in the debt class have debt less than a given threshold amount. Because of the existence of the pay plan, the actual debt will be temporarily reduced by the amount of the pay plan's scheduled payments before it is compared to the threshold amount (see [How Pay Plans Affect The Account Debt Monitor](#) for more information about how debt is reduced). Note: this temporary reduction will only occur if you have plugged in the appropriate pay plan debt reduction algorithm on the debt class.
- It attempts to cancel severance processes by calling the Severance Process Cancel Criteria Algorithm defined on the debt class that is associated with the severance process. This algorithm is meant to cancel a severance process if the sum of ALL service agreements in the debt class have debt less than a given threshold amount. Because of the existence of the pay plan, the actual debt will be temporarily reduced by the amount of the pay plan's scheduled payments before it is compared to the threshold amount (see [How Pay Plans Affect The Account Debt Monitor](#) for more information about how debt is reduced). Note: this temporary reduction will only occur if you have plugged in the appropriate pay plan debt reduction algorithm on the debt class.

If collection / severance processes still exist for the account / debt class associated with the pay plan, a warning is issued.

Interesting Pay Plan Facts

The following points describe a variety of interesting facts about pay plans (PP):

- An account may have many active pay plans. However, only 1 pay plan may be active for a given account / debt class / payor at any point in time.
- The existence of a pay plan has no impact on payment distribution.
- When a SA is stopped, if the SA's debt class has an active PP AND there are no other active SAs in the same debt class, the PP will be cancelled
 - The cancel reason will be "cancelled by system" (as opposed to "cancelled by user")
- If necessary, different collection / severance processes can be triggered if a broken PP is detected (via the override algorithms on CCC and write-off control - we do NOT provide such algorithms).

Setting Up Pay Plan Control Tables

This section describes the control tables needed to set up pay plans.

Setting Up Pay Plan Types

Pay plan types control what is done by a given pay plan. Open **Admin > Credit & Collection > Pay Plan Type** to define your pay plan types.

FASTPATH:

For more information refer to [The Big Picture Of Pay Plans](#) for more information.

Description of Page

To modify a pay plan type, simply move to a field and change its value. To add a new pay plan type, press + to insert a row, then fill in the information for each field. The following fields display:

Pay Plan Type The name of the pay plan type.

Description A meaningful description of the pay plan type.

Broken Algorithm This algorithm is called when a pay plan is broken. Refer to [The Pay Plan Monitor](#) for more information about how pay plans are broken.

If you haven't done so already, you must set up this algorithm in the system. To do this, create a new algorithm (refer to [Setting Up Algorithms](#)). On this algorithm, reference an Algorithm Type that breaks a pay plan.

Debt Class The debt class covered by pay plans of this type. Refer to [Setting Up Debt Classes](#) for more information.

Setting Up Payment Methods

Payment methods are used to describe how a customer intends to make their pay plan's scheduled payments. Open **Admin > Credit & Collection > Pay Method** to define your payment methods.

FASTPATH:

For more information refer to [A Pay Plan Must Reference A Payment Method](#) for more information.

Description of Page

To modify a pay method, simply move to a field and change its value. To add a new pay method, press + to insert a row, then fill in the information for each field. The following fields display:

Pay Method The name of the payment method.

Description A meaningful description of the payment method.

Grace Days The number of days added to the scheduled payment date. The ADM will consider the pay plan to be broken if payment is not made by the scheduled date plus the grace days.

Auto Pay If the pay method is marked as being for **Auto Pay**, the PPAPAY background process will automatically create an automatic payment on the pay plan's scheduled payment dates IF the account has been set up for automatic payment.

Setting Up Third Party Payors

Pay plans support optional third-party payors. Open **Admin > Credit & Collection > Third Party Payor** to define your third-party payors.

NOTE:

A third-party payor refers to an account. You must set up the account before you can create a third-party payor.

FASTPATH:

Refer to [A Pay Plan May Reference A 3rd Party Payor](#) for more information.

Description of Page

The following fields display for each third party payor:

Third Party Payor Provide a meaning id for the third-party payor that can be easily recognized when setting up a pay plan.

Description A meaningful description of the payor.

Account ID The account that is used for this payor. It is this account that is tracked as the "payee" of any payments made towards a third party payor's pay plan.

Active Check this box if the payor is currently available to participate in pay plans.

Creating Collection, Severance & Write-Off Procedures

Your collection procedures define how your organization collects overdue debt. Your severance procedures define how your organization severs service agreements when collection attempts fail. Your write-off procedures define how your organization writes off finalized debt. In this section, we describe how to set up the data that controls these procedures.

FASTPATH:

For more information about collection, severance and write-off procedures, see [The Big Picture Of Credit & Collections \(C&C\)](#).

WARNING:

There are innumerable ways to design your collection, severance and write-off procedures. Some designs will result in easy long-term maintenance, others will result in maintenance headaches. In this section, we provide information to help you understand the ramifications of the various options. Before you set up your production collection, severance and write-off procedures, we encourage you to gain an intuitive understanding of these options by using the system to prototype the alternatives.

Designing Your Collection Procedures

The design of your collection procedures is an iterative process. Over time, you will develop intuitive skills that will allow you to skip some iterations. However, when you're starting out, we recommend you use the following matrix as your guide. When the matrix is complete, you're ready to set up the collection process control tables.

SA's Debt Class	Account's Collection Class:	Account's Collection Class:

The topics discussed below will gradually complete this matrix using a simple case study.

FASTPATH:

For more information about how the information in this matrix is used to monitor your customers' debt, refer to [Different Collection Criteria For Different Customers And Different Debt](#).

Designing Your Debt Classes

Multiple debt classes are needed when you have different collection procedures for different types of service agreements. If all service agreement debt is collected the same way, then you'll have just one debt class (call it Generic). However, if you're like many organizations, you will have multiple debt classes. The following points will help you understand why:

- If you have both regulated and unregulated service, you probably have different debt classes for each type of service. Why? Because your local regulators control how you collect and cutoff overdue, regulated debt. For unregulated debt, your organization controls how overdue debt is collected.
- If your customers make charitable donations, you will have a charitable contribution debt class. Why? Because you probably send a different type of letter when the customer falls into arrears on their charitable contributions. You also can't cut off their water service if they don't make their charitable contributions.

- If you levy deposits, you will probably have a deposit debt class. Why? Because you probably respond differently if the customer doesn't pay their deposit (e.g., you may decide to cut off their electric service until the deposit is paid).
- If you allow customers to make payments on Non-Billed Budgets, you will probably have a Non-Billed Budget debt class. Why? Because you probably respond differently if the customer doesn't pay their Non-Billed Budget (e.g., you may decide to expire the Non-Billed Budget but not affect their other service since the Non-Billed Budget is a way for customers to prepay for upcoming bills).
- If you write-off uncollectable debt, you will need another debt class for write-off service agreements. Why? Because when you write-off debt in the system, you transfer the uncollectable debt from the original service agreement(s) to a write-off service agreement. The write-off service agreement holds this debt forever (or until it is paid). You need to use a different debt class for the write-off service agreements because they aren't subject to collection criteria.
- If you use the system to charge your organization's company usage, you'll need another debt class (we refer to it as the "N/A" debt class below). Why? Because all service agreements must have a debt class, even those that will never have debt.

SA's Debt Class	Account's Collection Class	Account's Collection Class
Regulated		
Unregulated		
Charitable Contribution		
Deposit		
Non-Billed Budget		
Write Off		
N/A		

Designing Your Collection Classes

Multiple collection classes are needed when any debt class has different collection rules depending on the type of customer. If all customers within all debt classes are collected the same way, then you'll just have a single collection class (call it Generic). However, if you're like many organizations, you will have multiple collection classes.

Consider unregulated debt. For commercial/industrial customers, you probably don't worry until they owe you more than, say, \$100 after 20 days. For residential customers, you probably don't worry until they owe you more than, say, \$5 after 20 days. In this situation, you will have at least two collection classes: one for large customers, the other for residential customers.

In our example, we are assuming you have two collection classes: Residential and Commercial/Industrial.

SA's Debt Class	Account's Collection Class: Residential	Account's Collection Class: Commercial/Industrial
Charitable Contribution		
Regulated		
Unregulated		
Write Off		
Company Usage		

Designing Collection Class Controls

At this point we have the rows and columns defined in our matrix. Now it's time to work on the individual cells.

Each cell should have a "collection class control" that defines its collection criteria and what to do if the criteria are violated. If a cell doesn't have a collection class control, this means you don't have any debt associated with that combination of collection class and debt class. So, we'll mark each cell without debt with "N/A".

SA's Debt Class	Account's Collection Class:	
	Residential	Commercial/Industrial
Regulated		N/A
Unregulated		
Charitable Contribution		N/A
Deposit		
Write Off		
N/A		

Next, we'll mark each cell for debt classes whose debt isn't collectable (i.e., the write-off and N/A debt classes).

SA's Debt Class	Account's Collection Class:	
	Residential	Commercial/Industrial
Regulated		N/A
Unregulated		
Charitable Contribution		N/A
Deposit		
Write Off	N/A	N/A
N/A	N/A	N/A

NOTE:

If the Account Debt Monitor encounters debt associated with a non-existent collection class control, it will issue an error.

Determining the collection criteria in each remaining cell can be straightforward or complicated; it depends on how your organization works. Our case study assumes the following:

- For charitable debt, if the customer is more than \$0 in arrears by more than 20 days, kick off the "charity reminder" collection process. We'll talk more about this collection process later.
- For regulated / residential debt, if the customer is more than \$15 in arrears by more than 20 days, kick off the Normal Regulated collection process. We'll talk more about this collection process later.
- For unregulated / residential debt, if the customer is more than \$5 in arrears by more than 20 days, kick off the Normal Unregulated collection process. We'll talk more about this collection process later.
- For unregulated / commercial-industrial debt we have multiple criteria:
 - Highest priority. If the customer is more than \$10,000 in arrears by more than 20 days, kick off the Large Overdue Debt collection process. We'll talk more about this collection process later.

- Lower priority. If the customer is more than \$100 in arrears by more than 20 days, kick off the Normal Unregulated collection process. We'll talk more about this collection process later.
- For deposit debt (regardless of collection class) we have multiple criteria:
 - Highest priority. If the customer is more than \$5 in arrears by more than 50 days, kick off the Deposit Severely Overdue collection process. We'll talk more about this collection process later.
 - Lower priority. If the customer is more than \$15 in arrears by more than 20 days, kick off the Deposit collection process. We'll talk more about this collection process later.

Given the above, our matrix will look as follows:

SA's Debt Class	Account's Collection Class:	
	Residential	Commercial/Industrial
Charitable Contribution	If > \$0 is older than 20 days, start Charity Reminder collection process.	N/A
Regulated	If > \$15 is older than 20 days, start Normal Regulated collection process.	N/A
Unregulated	If > \$5 is older than 20 days, start Normal Unregulated collection process.	Highest priority: If > \$10,000 is older than 20 days, start Large Overdue Debt collection process. Lower priority: If > \$100 is older than 20 days, start Normal Unregulated collection process.
Deposit	Highest priority: If > \$5 is older than 50 days, start Deposit Severely Overdue collection process. Lower priority: If > \$15 is older than 20 days, start Deposit collection process.	Highest priority: If > \$5 is older than 50 days, start Deposit Severely Overdue collection process. Lower priority: If > \$15 is older than 20 days, start Deposit collection process.
Write Off	N/A	N/A
N/A	N/A	N/A

Designing Your Collection Class Control Overrides

WARNING:

Your collection needs may not require any overrides for your collection class control matrix and therefore this section may not be relevant.

The following matrix will help you design your collection class overrides. When the matrix is complete, you're ready to set up the collection class control tables.

Notice that the matrix has two dimensions: one is dependent on collection condition algorithms; the other is dependent on the collection class controls designed in the previous section. Collection condition algorithms are confusing. Think of them as optional conditions that, if met, will subject the collection class control's debt to different collection criteria.

Each cell in the matrix contains the collection criteria that will be applied to the account's debt when the collection condition is met (i.e., the same type of criteria - dollars and days and collection process - are defined in each cell).

We label the first collection condition as the Default. The collection criteria associated with this column will be used to analyze an account's debt when none of the other conditions applies. We'll start by indicating the Default collection criteria (this was defined in the previous section).

SA's Debt Class	Account's Collection Class: Default	Account's Collection Class: Credit Rating < Threshold
Residential Charitable Contribution	See default collection criteria defined in previous section.	
Residential Regulated	See default collection criteria defined in previous section.	
Residential Unregulated	See default collection criteria defined in previous section.	
Commercial-Industrial Unregulated	See default collection criteria defined in previous section.	
Residential Deposit	See default collection criteria defined in previous section.	
Commercial-Industrial Deposit	See default collection criteria defined in previous section.	

If a different collection process OR criteria should be used when other conditions are met, you should indicate such by defining the collection criteria in the cell. For example, if we assume that all unregulated residential debt has a different collection process when the account's credit score is less than the threshold credit rating on the installation record or the account's CIS Division, our matrix will look as follows:

SA's Debt Class	Account's Collection Class: Default	Account's Collection Class: Credit Rating < Threshold
Residential Charitable Contribution	See default collection criteria defined in previous section.	
Residential Regulated	See default collection criteria defined in previous section.	
Residential Unregulated	See default collection criteria defined in previous section.	Override: If Credit Rating is lower than the credit rating threshold: If > \$5 is older than 15 days, start Risky Unregulated collection process.
Commercial-Industrial Unregulated	See default collection criteria defined in previous section.	
Residential Deposit	See default collection criteria defined in previous section.	
Commercial-Industrial Deposit	See default collection criteria defined in previous section.	

Once the matrix is complete, you're ready to design your collection process and collection event types.

NOTE:

The collection conditions are limited by your imagination (and business requirements). We have provided the collection conditions you see above as an example; we don't expect you'll be able to use the exact conditions we supply. Your conditions will be based on any number of factors. For example, if you have different collection criteria that apply during winter months, you should add a new collection condition (called Winter Season). Or if you have different criteria based on years of service, you could have another condition.

New collection conditions may require programming. See [How To Add A New Algorithm](#) for more information.

Designing Collection Process Templates & Collection Event Types

The following table shows the collection process templates referenced in the previous section's matrix. Adjacent to each process are its events and an indication of when they are triggered.

Collection Process Template	Collection Event Template	Triggered X Days From Start Of Collection Process
Charitable Contribution Reminder	Charity courtesy reminder letter	0
	Start severance	15
Normal Regulated	Regulated courtesy reminder letter	0
	Regulated second notice letter	10
	Start severance	15
Large Overdue Debt	Large debt courtesy reminder letter	0
	To Do for large overdue debt	3
	Large debt second notice letter	10
	Start severance	15
Normal Unregulated	Unregulated courtesy reminder letter	0
	Unregulated second notice letter	5
	Start severance	10
Risky Customer Unregulated	Unregulated risky letter	0
	Start severance	5
Deposit	Deposit reminder	0
Deposit Severely Overdue	Create To Do entry	0

If we extract each unique event type from the above table, we end up with the following:

Collection Event Type	Event Type
Charity courtesy reminder letter	Send Letter - CHARIT REMIN
Start severance	Start Severance Process
Regulated courtesy reminder letter	Send Letter - REGUL REMIN
Regulated second notice letter	Send Letter - REGUL second
Large debt courtesy reminder	Send Letter - LARGE REMIN
Risky debt courtesy reminder	Send Letter - RISKY REMIN
To Do for large overdue debt	Issue To Do
Large debt second notice letter	Send Letter - LARGE second
Unregulated courtesy reminder letter	Send Letter - UNREG REMIN
Unregulated second notice letter	Send Letter - UNREG second
Deposit reminder	Send Letter - DEPOS REMIN

Now you're (almost) ready to set up your collection procedures.

Defining Cancellation Process Auto Cancellation Criteria

The topics in the section [How Are Collection Processes Cancelled](#) describe the two algorithms that play a part in the cancellation of a collection process. It also describes when to use what type of algorithm. Please read this section and then set up the appropriate cancellation criteria on your [Debt Classes](#), and optionally, on your [Collection Process Templates](#).

Setting Up Collection Procedures

In the previous section, [Designing Your Collection Procedures](#), we presented a case study that illustrated a mythical organization's collection procedures. In this section, we'll explain how to set up the control tables to implement these procedures:

Setting Up Collection Event Types

Collection event types control what is done by a given collection event. Open **Admin > Credit & Collection > Collection Event Type > Add** to define your collection event types.

Description of Page

Enter a unique **Collection Event Type** and **Description** for the collection event type.

Enter the **Collection Event Type**. Permissible values are: Affect Credit, Rating/Cash-Only, Cancel Budget, Generic Algorithm, Send Letter, Create To Do Entry, Start Severance Process. The following discussion describes the parameters that must be defined for each type of collection event.

The Affect Credit Rating/Cash-Only collection event type causes a credit rating demerit record to be linked to the account. This record is constructed using the following **Parameters**:

- Use **Credit Rating Points** to define this event's affect on the account's credit rating. This should be a negative number. An account's credit rating is equal to the beginning credit rating amount defined on the installation record or the account's CIS Division plus the sum of credit rating demerits that are currently in effect. When an account's credit rating is less than the credit rating threshold defined on the installation record or the account's CIS Division, the account's credit rating is displayed as an alert on Control Central.
- Use **Cash-Only Points** to define this event's affect on the account's cash-only score. This should be a positive number. When an account's cash-only score exceeds the cash-only threshold score defined on the installation record or the account's CIS Division, the account is flagged as cash-only during payment processing and on Control Central.
- Use **Credit Rating Months** to define the length of time the demerit remains in effect. This information is used to define the effective period of the credit rating demerit record.

FASTPATH:

For more information, refer to [Account - Credit Rating](#).

The Send Letter collection event type causes a customer contact to be generated that, in turn, generates a letter. Enter the following **Parameters** for this type of event:

- Select the **Contact Class** used to categorize the customer contact.

- Use **Contact Type** to define the type of customer contact to create. The type of customer contact controls the type of letter that is generated.

NOTE:

Letter creation is triggered via a customer contact. You must set up a customer contact type for each type of letter you generate. You specify the necessary customer contact type on the collection event. Refer to [Setting Up Letter Templates](#) for more information.

The Cancel Budget collection event type cancel an account's budget plan (if the account is on such a plan). When a budget plan is cancelled, adjustments are issued to synchronize every service agreement's current balance with its payoff balance and each applicable SA's recurring charge amount (i.e., budget amount) is set to zero.

The Generic Algorithm collection event type causes the algorithm defined in the **Collection Event Alg** to be executed. You use this type of algorithm when the standard types of collection events won't do what you need done. If you haven't done so already, you must set up this algorithm in the system. To do this:

- Create a new algorithm (refer to [Setting Up Algorithms](#)).
- On this algorithm, reference an Algorithm Type that determines the algorithm that will be called when events of this type of activated.

The Create To Do Entry collection event type causes a To Do entry to be issued. A good example of where this is used is when the collection event requires that the customer be called on the phone. Refer to [The Big Picture of To Do Entries](#) for more information about To Do entries (refer to the To Do type TD-CEVT for the type of To Do entry that's created).

The Start Severance Process type will start a severance process for every service agreement linked to the collection process. No parameters are needed for this type of event.

Enter a **Long Description** to fully describe the collection event type.

Setting Up Collection Process Templates

Collection process templates define the collection events that will be executed when a collection criteria rule is violated. Open **Admin > Credit & Collection > Collection Process Template > Add** to define your collection process templates.

Description of Page

Enter a unique **Collection Process Template** and **Description** for the collection process template.

Select a **Cancel Criteria Algorithm** if your organization allows individual service agreements to be "removed" from a collection process regardless of the debt associated with all service agreements in the debt class. In other words, if your cancel criteria are based on the debt associated with ALL service agreements in a debt class DO NOT SPECIFY THIS ALGORITHM. If this algorithm is specified, it is executed by the collection process monitor when it detects that a credit has been applied to a service agreement linked to an active collection process. This algorithm will indicate if the specific service agreement that has been credited no longer has debt that warrants a collection process. Refer to [How Are Collection Processes Cancelled](#) for more information. If you haven't done so already, you must set up this algorithm in the system. To do this, create a new algorithm (refer to [Setting Up Algorithms](#)). On this algorithm, reference an Algorithm Type that "removes" a service agreement from a collection processes if the service agreement's debt so warrants.

The **Response** grid contains an entry for every collection event that will be created when a collection process that references this template is created. The following information must be defined for each event:

Event Sequence controls the order in which the collection event types appear under the collection process template. The sequence number is system-assigned and cannot be changed. If you have to insert a collection event type between two existing templates, you'll have to remove the latter events, insert the new event, and then re-specify the removed events.

Collection Event Type Specify the type of collection event to be generated.

Days After Process Creation Specify the number of days after the creation of the collection process that the related collection event will be triggered. Refer to [Calendar vs Work Days](#) for a description of how this system uses this information to set the trigger date on the respective collection events.

FASTPATH:

For more information about collection event types, see [Setting Up Collection Event Types](#). For more information about trigger dates, see [Collection Event Trigger Date](#).

Setting Up Collection Classes

Every account has a collection class. This class is one of several fields that control the collection method applied to the account's debt. Open **Admin > Credit & Collection > Collection Class** to define your collection classes.

FASTPATH:

For more information about collection classes, see [Designing Your Collection Classes](#).

Description of Page

Enter a unique **Collection Class** code and **Description** for each collection class.

Indicate which method is used to monitor the member accounts' unpaid debt:

- If you practice [balance-forward accounting](#) for accounts belonging to this collection class, select Collection, Severance & Write-Off. This method of collection is described throughout this chapter.
- If you practice [open-item accounting](#) for accounts belonging to this collection class, select Overdue. This method of collection is described under [Defining Overdue Processing Options](#).
- If accounts belonging to this collection class are not subject to either of the above collection methods, select Not Eligible For Collection. Please be aware that these accounts will NOT be reviewed for overdue debt.

Setting Up Debt Classes

Every SA type has a debt class. This class is one of several fields that control the collection criteria applied to the service agreement's debt. Open **Admin > Credit & Collection > Debt Class > Add** to define your debt classes.

FASTPATH:

For more information about debt classes, see [Designing Your Debt Classes](#).

Description of Page

Enter a unique **Debt Class** and **Description** for the debt class.

Turn on **Eligible for Collection** if service agreements belonging to this debt class have their debt monitored by the collection process. This should only be turned off if this debt cannot be collected, e.g., write-off debt.

The grid that follows contains **Algorithms** that control important functions in the system. You must define the following for each algorithm:

- Specify the **System Event** with which the algorithm is associated (see the table that follows for a description of all possible events).
- Specify the **Sequence** and **Algorithm** for each system event. You can set the **Sequence** to an arbitrary number as only one algorithm for each system event is allowed in this case.

WARNING:

These algorithms are typically significant system processes. The absence of an algorithm may prevent the system from operating correctly.

You can define algorithms for the following **System Events**:

System Event	Optional / Required	Description
Collection Process Cancellation	Required if debt class is eligible for collection	This algorithm determines if a collection process can be canceled, and if so, it cancels it. Refer to How Are Collection Processes Cancelled for more information.
Severance Process Cancellation	Required if debt class is eligible for collection	This algorithm determines if a severance process can be canceled, and if so, it cancels it. Refer to How Are Severance Processes Cancelled for more information.
Override Arrears Due to Pay Plan	Required if you use Pay Plans	<p>This algorithm is called to temporarily override a customer's arrears using a pay plan's scheduled payments when the system looks at an account's debt from a credit & collections perspective (i.e., the ADM calls this algorithm before it subjects a customer's debt to the collection criteria and when a pay plan is created). It does not actually change any data, but overlays the current arrears with the pay plan scheduled payments.</p> <p>This algorithm is also called by the above algorithms when a pay plan is created in order to evaluate if the scheduled payments actually cover the arrears (if so, the collection / severance processes are cancelled). It is also called periodically by the ADM in order to establish if the current state of the pay plan still covers the arrears. Refer to How Pay Plans Affect The Account Debt Monitor.</p>

Setting Up Collection Class Controls

The topics in this section describe the windows on which you set up your collection class control information.

WARNING:

The information in this page is what controls how the system analyzes your customer's debt. The flexibility of this control information provides you with almost unlimited options. This is very powerful, but it requires careful analysis. Refer to [Designing Your Collection Procedures](#) for more information.

Collection Class Control - Main Information

The information on this transaction defines the conditions that will be checked by the [Account Debt Monitor](#) when it checks if an account has violated your debt criteria.

Open **Admin > Credit & Collection > Collection Class Control > Add** to define this information.

FASTPATH:

For more information about collection class control, refer to [Designing Collection Class Controls](#).

Description of Page

Enter a unique **Collection Class Control** code and **Description** for the collection class control (CCC).

Enter the **CIS Division** to which the CCC's criteria applies.

Enter the **Collection Class** to which the CCC's criteria applies.

Enter the **Debt Class** to which the CCC's criteria applies.

Enter the **Currency Code** in which the CCC's criteria are denominated.

Use **Long Description** to further describe the CCC.

FASTPATH:

The information in the following grid is not intuitively obvious. Refer to [Designing Collection Class Controls](#) and [Designing Your Collection Class Control Overrides](#) for more information.

The grid which follows contains the conditions that are checked by the [Account Debt Monitor](#) (ADM) to determine the type of criteria (defined on the next tab) that will be applied against an account's debt. In other words - the ADM will check each condition (from highest to lowest **Priority**). The first condition that returns a value of true will cause the system to compare the account's debt against the debt criteria defined on the next tab.

Multiple conditions may be defined if different conditions result in a different type of debt thresholds (or a different type of collection process). The following fields are required for each condition:

Collection Condition Priority The priority controls the order in which the ADM checks if a collection condition applies (the lower the number, the higher the priority). Higher priorities are checked before lower priorities.

NOTE:

The values for this field are customizable using the Lookup table. This field name is COLL_CAT_PRIO_FLG.

Condition Algorithm Define the algorithm used to check if an account should be subject to the collection criteria defined on the next tab. If the algorithm returns a value of true (i.e., the condition is met), the ADM will compare the account's debt against the **Debt Criteria** (defined on the next tab) and start a collection process if the account has debt that violates these criteria.

You must have at least one collection condition; otherwise the system will not have criteria against which to compare the account's debt. This entry should have the lowest priority code and reference the "default" algorithm. If you haven't done so already, you must set up this algorithm in the system. To do this, create a new algorithm (refer to [Setting Up Algorithms](#)). On this algorithm, reference an Algorithm Type that references the "default" collection condition algorithm type (COLL COND DF).

If you have other conditions that should be checked before the default condition, you must create an entry for each in this grid. Each entry should have a priority consistent with your business requirements (and this priority should be higher than the default condition's priority). In addition, you should reference an algorithm that contains the conditions that will be checked to determine if the account should be subject to the debt criteria (defined on the next tab). The system is supplied with many additional algorithm types. In order to take advantage of them, you will need to create an algorithm (refer to [Setting Up Algorithms](#)). On this algorithm, reference an Algorithm Type that references one of the collection condition algorithm types.

Where Used

Collection class controls contain the data that controls the Account Debt Monitor. Refer to [How Does The Account Debt Monitor Work?](#) for more information.

Collection Class Control - Debt Criteria

The information on this page defines the debt and age thresholds used by the [Account Debt Monitor](#) when it checks if an account has violated your acceptable levels of debt. Open **Admin > Credit & Collection > Collection Class Control > Search** and navigate to the **Debt Criteria** page to define this information.

NOTE:

The information on this page is not intuitively obvious. Refer to [Designing Collection Class Controls](#) and [Designing Your Collection Class Control Overrides](#) for more information.

Description of Page

The **Debt Criteria** scroll contains an entry for each collection criteria algorithm defined on the **Main** tab. The following information appears

The **Collection Condition Priority** controls the order in which the Account Debt Monitor (ADM) checks if a collection condition applies. Higher priorities are checked before lower priorities.

The **Condition Algorithm** is called by the ADM to determine which collection criteria should be applied to the account's debt. If this algorithm returns a value of true (i.e., the condition is met), the ADM will compare the account's debt against the **Debt Criteria** defined below. If the account violates any criteria, a collection process will be started (using the respective **Collection Process Template**).

The grid that follows contains the debt age and amount of debt that must be violated by the account in order for the ADM to create a collection process template. The following fields should be defined:

Arrears Priority controls the order in which the arrears criteria will be checked by the Account Debt Monitor (the lower the number, the higher the priority). The first criteria, if any, that is met will cause a collection process to be created (using the **Collection Process Template**).

Collection Process Template If the Account Debt Monitor determines that the account's debt violates the corresponding criteria, it creates a collection process using the specified collection process template.

Arrears Amount When the Account Debt Monitor checks an account's debt, it determines if the account has debt older than "> Number of Days" (the next field) AND the debt exceeds "> Arrears Amount". If so, a collection process is started.

Days When the Account Debt Monitor checks an account's debt, it determines if the account has debt older than **Days** AND the debt exceeds **Arrears Amount**. If so, a collection process is started.

Where Used

Collection class controls contains the data that controls the [Account Debt Monitor](#).

Designing Your Severance Procedures

The following matrix will help you design your severance procedures. When the matrix is complete, you're ready to set up the severance process control tables.

Notice that the matrix has two dimensions: one is dependent on severance criteria algorithms; the other is dependent on the SA type of the service agreement being severed. The number and type of SA types is dependent on how your organization sets up the SA type table (the SA types shown below are characteristic of those used by a simple utility).

SA Type	Severance Criteria Algorithm:	Severance Criteria Algorithm:
	Default	Customer On Life Support

Electric Residential

Electric Commercial

Gas Residential

Gas Commercial

Charitable Contribution

Once you know the values of each dimension, you fill in each cell with its respective severance events. We've completed the sample matrix with some characteristic events.

SA Type	Severance Criteria Algorithm:	Severance Criteria Algorithm:
	Default	Customer On Life Support
Electric Residential	<p>Create a 48-hour warning field activity.</p> <p>2 days after completion, create a disconnect service field activity.</p> <p>Immediately after completion of the disconnect field activity, send a letter to the customer.</p> <p>10 days after completion of disconnection, expire the service agreement.</p>	<p>Create a To Do entry asking a collection rep to call the customer.</p> <p>5 days later, create a 72-hour warning field activity.</p> <p>2 days after completion, create a To Do entry telling collection rep of impending life support cutoff.</p> <p>3 days after completion of warning, create a disconnect service field activity AND generate a To Do entry informing a collection agent of such.</p> <p>Immediately after completion of the disconnect field activity, send a letter to the customer.</p> <p>10 days after completion of disconnection expire the service agreement.</p>
Electric Commercial	<p>Create a 48-hour warning field activity.</p> <p>2 days after completion, create a disconnect service field activity.</p> <p>Immediately after completion of the disconnect field activity, send a letter to the customer.</p> <p>10 days after completion of disconnection, expire the service agreement.</p>	N/A
Gas Residential	<p>Create a 48-hour warning field activity.</p> <p>2 days after completion, create a disconnect service field activity.</p> <p>Immediately after completion of the disconnect field activity, send a letter to the customer.</p> <p>10 days after completion of disconnection, expire the service agreement.</p>	<p>Create a 48-hour warning field activity.</p> <p>2 days after completion, create a disconnect service field activity.</p> <p>Immediately after completion of the disconnect field activity, send a letter to the customer.</p> <p>10 days after completion of disconnection, expire the service agreement.</p>
Gas Commercial	<p>Create a 48-hour warning field activity.</p> <p>2 days after completion, create a disconnect service field activity.</p>	N/A

Immediately after completion of the disconnect field activity, send a letter to the customer.

10 days after completion of disconnection, expire the service agreement.

Charitable Contribution	Expire service agreement	Expire service agreement
-------------------------	--------------------------	--------------------------

Once the matrix is complete, you determine the severance process templates needed to implement your severance procedures. The following table shows the severance process templates referenced in the previous section's matrix. Adjacent to each process are its events and an indication of when they are triggered.

Severance Process Template	Event Number	Severance Event Template	Dependent On Event(s)	Trigger Date Set To X Days After Completion Of Dependent Events
Utility severance - default	10	Field activity - 48 hour disconnect for non-payment warning	N/A - first event	0
	20	Field activity - disconnect for non-payment	10	2
	30	'Service has been disconnected' letter	20	0
	40	Expire service agreement	20	10
Electric life support residential severance	10	Generate delinquent life support customer To Do entry	N/A - first event	0
	20	Field activity - 72 hour disconnect for non-payment warning	10	5
	30	Generate impending life support cutoff To Do entry to C&C rep	20	2
	40	Field activity - cut for non-payment	20	3
	50	Service has been disconnected letter	40	0
	60	Expire service agreement	40	10
Just expire severance	10	Expire service agreement	N/A - first event	

If we extract each unique severance event type from the above table, we end up with the following:

Severance Event Template	Event Type
48-hour warning	Generate Field Activity - Disconnect Warning
72-hour warning	Generate Field Activity - Disconnect Warning
Disconnect for non payment	Generate Field Activity - Cut For Non-Payment
Delinquent life support customer	Create To Do Entry - C&C Rep Role
Impending life support cutoff	Create To Do Entry - C&C Rep Role

WARNING:

The field activity types are NOT specified directly on the severance event type. Why? Because each service point linked to the service agreement being severed could necessitate a different type of field activity. Therefore, the system uses the type of service point, its state (e.g., connected, meter is off.) and the desired customer event (e.g., Disconnect Warning, Cut For Non-Payment) to determine which field activity type(s) to generate. Refer to [Setting Up Field Activity Type Profiles](#) for how to set up the specific disconnect field activity types for your various types of service points.

Now you're (almost) ready to set up your severance procedures.

Defining Severance Process Auto Cancellation Criteria

The topics in the section [How Are Severance Processes Cancelled](#) describe the two algorithms that play a part in the cancellation of a collection process. It also describes when to use what type of algorithm. Please read this section and then set up the appropriate cancellation criteria on your [Debt Classes](#), and optionally, on your [Severance Process Templates](#).

Designing Your Reconnection Procedures

If a customer pays for a service agreement after the service has been cut for non-payment AND BEFORE THE SA HAS BEEN EXPIRED, they need to be reconnected. Counter-intuitively, you must set up a severance process to initiate the field activities to reconnect service.

NOTE:

Why do you use a severance process to reconnect service? Because a severance process is nothing more than a series of events that take place one after another. Some of the events create field activities, others send letters, others create To Do entries. So, why not use a severance process? You just have to send different letters and perform different field activities.

WARNING:

The system will automatically create a reconnection process if a severance process is cancelled as a result of a payment (or other credits). Please note that this will only happen if you plug-in the appropriate post cancellation algorithm on your severance process templates. Refer to [What Happens When A Severance Process Is Cancelled?](#) **for more information.**

While you don't define the reconnect procedures for an SA type, we recommend you think about the reconnection steps for each of your SA types that can be disconnected for nonpayment. We've completed the sample matrix with some characteristic events.

SA Type	Steps
Electric Residential	Create a reconnect service field activity. Immediately after completion of the reconnect, send a letter to the customer.
Electric Commercial	Create a reconnect service field activity.

	Immediately after completion of the reconnect, send a letter to the customer.
Gas Residential	Create a reconnect service field activity. Immediately after completion of the reconnect, send a letter to the customer.
Gas Commercial	Create a reconnect service field activity. Immediately after completion of the reconnect, send a letter to the customer.

Once the matrix is complete, you determine the severance process templates needed to implement your reconnection procedures. Notice each SA type has the same reconnection steps. This means you just need one severance process. The following table shows this severance process template and its events.

Severance Process Template	Event Number	Severance Event Template	Dependent On Event(s)	Trigger Date Set To X Days After Completion Of Dependent Events
Reconnect	10	Field activity - reconnect service	N/A - first event	0
	20	Service has been reconnected letter	10	0

If we extract each unique severance event type from the above table, we end up with the following:

Severance Event Template	Event Type
Reconnect	Generate Field Activity - Reconnect
Service has been reconnected letter	Send Letter

WARNING:

The field activity types are NOT specified directly on the severance event type. Why? Because each service point linked to the service agreement being severed could necessitate a different type of field activity. Therefore, the system uses the type of service point, its state (e.g., connected, meter is off.) and the desired customer event (e.g., Disconnect Warning, Cut For Non-Payment) to determine which field activity type(s) to generate. Refer to [Setting Up Field Activity Type Profiles](#) for how to set up the specific disconnect field activity types for your various types of service points.

IMPORTANT:

If you want the system to automatically create a reconnection process if a customer pays after they have been cut, you must specify the appropriate post cancellation algorithm on your severance process templates.

And now you're ready to set up your severance (and reconnection) procedures.

Setting Up Severance Procedures

In the previous section, [Designing Your Severance Procedures](#), we presented a case study that illustrated a mythical organization's severance procedures. In this section, we'll explain how to set up the control tables to implement these procedures:

Setting Up Severance Event Types

Severance event types control what is done by a given severance event. Open **Admin > Credit & Collection > Severance Event Type > Add** to define your severance event types.

FASTPATH:

For more information refer to [Designing Your Severance Procedures](#).

Description of Page

Enter a unique **Severance Event Type** code and **Description** for the severance event type.

Enter the Severance **Event Type**. Permissible values are: Affect Credit Rating/Cash-Only, Send Letter, Generic Algorithm, Create To Do Entry, Create Field Activities, Expire Service Agreement. The following discussion describes the parameters that must be defined for each type of severance event.

The Affect Credit Rating/Cash-Only collection event type causes a credit rating demerit record to be linked to the account. This record is constructed using the following **Parameters**:

- account debt monitor.
- Use **Cash-Only Points** to define this event's affect on the account's cash-only score. This should be a positive number. When an account's cash-only score exceeds the cash-only threshold score defined on the installation record, the account is flagged as cash-only during payment processing and on Control Central.
- Use **Cash-Only Points** to define this event's affect on the account's cash-only score. This should be a positive number. When an account's cash-only score exceeds the cash-only threshold score defined on the installation record or the account's CIS Division, the account is flagged as cash-only during payment processing and on Control Central.

The Send Letter severance event type causes a customer contact to be generated that, in turn, generates a letter. Enter the following **Parameters** for this type of event:

- Select the **Contact Class** used to categorize the customer contact.
- Use **Contact Type** to define the type of customer contact to create. The type of customer contact controls the type of letter that is generated.

The Generic Algorithm severance event type causes the algorithm defined in the **Sev. Event Algorithm** to be executed. You use this type of algorithm when the standard types of severance events won't do what you need done.

The Create To Do Entry severance event type causes a To Do entry to be created. Refer to [The Big Picture of To Do Entries](#) for more information about To Do entries (refer to the To Do type TD-SEVT for the type of To Do entry that's created).

The Generate Field Activities severance event type causes one or more field activities to be generated. Enter the following **Parameters** for this type of event:

- Select the **Customer Event** associated with the field activity. Valid values are: Cut For Non-Payment (CNP), Disconnect Warning (Disc Warn), Reconnect for Payment (Reconn), Start Service (Start) , Start/Stop Service (Start/Stop), Stop Service (Stop), Reread (Reread).
- The system uses the **Customer Event** to select the appropriate field activity type(s) from the field activity type profile associated with the service points linked to the service agreement.

WARNING:

The field activity types are NOT specified directly on the severance event type. Why? Because each service point linked to the service agreement being severed could necessitate a different type of field activity. Therefore, the system uses the type of service point, its state (e.g., connected, meter off) and the desired customer event (e.g., Disconnect Warning, Cut

For Non-Payment) to determine which field activity type(s) to generate. Refer to [Setting Up Field Activity Type Profiles](#) for how to set up the specific disconnect field activity types for your various types of service points.

The Expire Service Agreement severance event type causes the service agreement to be moved to the pending stop state (it also populates the service agreement's stop date). Refer to [Finalizing Pending Stops](#) for how the system will eventually stop the service agreement (and then final bill it). There are no parameters for this type of event.

NOTE:

Cut for non-payment field activities are special. The Expire Service Agreement severance event type also makes any "cut for non-payment" field activities created by earlier severance events available to stop service. Specifically, it changes the linkage type of the field activities from Severance Activity to Stop Activity. You can see a service agreement's service points' field activities and their respective linkage type on [Service Agreement - Service Point](#).

Enter a **Long Description** to fully describe the severance event type.

Setting Up Severance Process Templates

Severance process templates define the severance events that will be executed when a service agreement is severed. Open **Admin > Credit & Collection > Severance Process Template > Add** to define your severance process templates.

Description of Page

Enter a unique **Severance Process Template** and **Description** for the severance process template.

If severance processes of this type should be automatically canceled when the customer pays the collection amount on the severance, turn on **Auto Cancel**. This switch would typically only be turned off for severance processes used to reconnect a cut service because you don't want such a reconnection process to be canceled when a payment is made. Refer to [Designing Your Reconnection Procedures](#) for more information.

In addition to turning on the **Auto Cancel** switch, specify a **Cancel Criteria Algorithm** if your organization allows a severance process to be cancelled regardless of the debt associated with all service agreements in the debt class. In other words, if your cancel criteria are based on the debt associated with ALL service agreements in a debt class DO NOT SPECIFY THIS ALGORITHM.

If the **Cancel Criteria Algorithm** is specified, it is executed when a credit is posted to the service agreement associated with a severance process. This algorithm will indicate if the service agreement no longer has debt that warrants a severance process. Refer to [How Are Severance Processes Cancelled](#) for more information. If you haven't done so already, you must set up this algorithm in the system. To do this, create a new algorithm (refer to [Setting Up Algorithms](#)). On this algorithm, reference an Algorithm Type that cancels a severance process if the service agreement's debt so warrants.

If you wish to perform any special processes after a severance process is canceled, specify a **Post Cancel Algorithm**. This can be used to start a reconnection in case the severance process was canceled too late to stop the disconnection. If you haven't done so already, you must set up this algorithm in the system. To do this, create a new algorithm (refer to [Setting Up Algorithms](#)). On this algorithm, reference an Algorithm Type that cancels a severance process if the service agreement's debt so warrants.

When a service agreement is to be severed due to non-payment, the system creates a severance process and links to it one or more severance events based on the **Event Types** entered here. The information in the scroll defines these events and the date on which they will be triggered. The following fields are required for each event:

Event Sequence controls the order in which the severance event types appear under the severance process template. The sequence number is system-assigned and cannot be changed. If you have to insert a severance event type between two existing templates, you'll have to remove the latter events, insert the new event, and then re-specify the removed events.

Severance Event Type Specify the type of severance event to be generated.

Dependent On Other Events Turn this indicator on if the trigger date of the event can only be determined after earlier events are complete. For example, you would turn this switch on for the event that initiates the field activity to disconnect service. Why? Because you only want to disconnect service after the preceding event that warned the client of impending disconnection is complete.

Days After Prev Response Specify the number of days after the completion / cancellation of the dependent events on which the severance event will be triggered. If this event is not dependent on the completion of other events, this field contains the number of days after the creation of the severance process that the related severance event will be triggered. Refer to [Severance Event Dependencies and Trigger Date](#) and [Calendar vs Work Days](#) for a description of how the system uses this information to set the trigger date on the respective severance events.

When the **Dependent On Other Events** switch is on, use the grid to define the events on which this event is dependent. If multiple events are specified in the grid, all such events must be completed or cancelled before the event will be triggered.

Sequence is system-assigned and cannot be specified or changed.

Dependent On Sequence Specify the sequence number of the severance event on which the above severance event depends.

FASTPATH:

For more information about severance event types, see [Setting Up Severance Event Types](#). For more information about trigger dates, see [Severance Event Dependencies & Trigger Date](#).

Designing Your Write-Off Procedures

The design of your write-off procedures is relatively straightforward. Simply follow the instructions in the following topics.

Designing Your Write-Off Debt Classes

Multiple write-off debt classes are needed when you have different write-off procedures for different types of service agreements. If all service agreement debt is written-off the same way, then you'll have just one write-off debt class (call it Generic). However, if you're like many organizations, you will have multiple write-off debt classes. The following points will help you understand why:

- If you bill for 3 rd parties, you probably have different write-off debt classes for the 3 rd party service agreements. Why? Because you probably treat 3 rd party uncollectable debt differently from your own debt.
- You will need a separate write-off debt class for service agreements whose debt cannot be written off. Why? Because there is a switch on the write-off debt class control table that controls if service agreements in the write-off debt class are eligible for write-off processing. Given that you will have some service agreements that hold debt that aren't eligible for write-off processing (e.g., service agreements that hold written-off debt and service agreements that overpayments), you will need at least one other write-off debt class.
- If you use the system to calculate charges for your organization's company usage, you'll need another write-off debt class (we refer to it as the "N/A" write-off debt class below). Why? Because all service agreements must have a write-off debt class, even those that will never have debt.

SA's Write-Off Debt Class	Account's Collection Class	Account's Collection Class
Normal W/O		
N/A		

Designing Write-Off Controls

Set up a matrix using the collection classes you designed when you were designing your collection procedures ([Designing Your Collection Procedures](#)).

SA's Write-Off Debt Class	Account's Collection Class Residential	Account's Collection Class Commercial/Industrial
Normal Write Off		
N/A		

Each cell should have a "write-off control" that defines what to do when the system detects finalized debt that hasn't been paid. This is true even of the "N/A" write-off debt class. Why? Because you may want the system to write-down these stopped SAs when they have a small balance. For example, if you have a write-off service agreement that subsequently receives a partial payment that leaves a small amount owing, you probably want the system to generate a write-down adjustment (so that the write-off service agreement will close). We'll initially fill in the matrix for the "N/A" write-off debt class.

SA's Write-Off Debt Class	Account's Collection Class Residential	Account's Collection Class Commercial/Industrial
Normal Write Off		
N/A	Attempt to reduce the SA's balance to zero using the following methods: Synchronize current balance with payoff balance. If the debt is < \$10 and > \$-1, write down the debt using a write-down adjustment.	Attempt to reduce the SA's balance to zero using the following methods: Synchronize current balance with payoff balance. If the debt is < \$10 and > \$-1, write down the debt using a write-down adjustment.

NOTE:

If the Write Off Monitor encounters debt associated with a non-defined collection class and write-off debt class, it will issue an error.

For each cell that isn't designated as N/A, you need to answer the following questions:

- Are you allowed to transfer debt to other non-closed service agreements linked to the account? If so, you need to define the algorithm used to do such. Refer to [Setting Up Write-off Control](#) for more information about this algorithm.
- Are you allowed to write-down small amounts of debt (or small credits)? If so, you need to define the algorithm used to do such. Refer to [Setting Up Write-off Control](#) for more information about this algorithm.
- Should you refund credit balances with a check? If so, you need to define the algorithm to do such. Refer to [Setting Up Write-off Control](#) for more information about this algorithm.
- If debt remains after doing the above, how do you write it off (e.g., do you first refer the debt to a collection agency and only write it off after waiting 30 days)?

We'll fill in the above matrix with our assumptions:

SA's Write-Off Debt Class	Account's Collection Class Residential	Account's Collection Class Commercial/Industrial

Normal Write-Off	<p>Attempt to reduce the SA's balance to zero using the following methods:</p> <p>Attempt to transfer debt to another active service agreement linked to the account.</p> <p>If the debt is < \$10 and > \$-1, write down the debt using a write-down adjustment.</p> <p>If the debt is <= \$-1, create an A/P adjustment to refund the credit to the customer.</p> <p>If debt remains:</p> <p>Highest priority: If customer has a non-cash deposit, create the non-cash deposit write-off process.</p> <p>Otherwise, create the default write-off process for residential debt.</p>	<p>Attempt to reduce the SA's balance to zero using the following methods:</p> <p>Attempt to transfer debt to another active service agreement linked to the account.</p> <p>If the debt / credit is < \$10 and > \$-10, write down the debt using a write-down adjustment.</p> <p>If the debt / credit is <= \$-10, create an A/P adjustment to refund the credit to the customer.</p> <p>If debt remains:</p> <p>Highest priority: If customer has a non-cash deposit, create the non-cash deposit write-off process.</p> <p>Otherwise, create the default write-off process for commercial debt.</p>
N/A	<p>Attempt to reduce the SA's balance to zero using the following methods:</p> <p>Synchronize current balance with payoff balance.</p> <p>If the debt is < \$10 and > \$-1, write down the debt using a write-down adjustment.</p> <p>Because this debt class isn't eligible for further write-off processing, criteria used to process debt are not necessary.</p>	<p>Attempt to reduce the SA's balance to zero using the following methods:</p> <p>Synchronize current balance with payoff balance.</p> <p>If the debt is < \$10 and > \$-1, write down the debt using a write-down adjustment.</p> <p>Because this debt class isn't eligible for further write-off processing, criteria used to process debt are not necessary.</p>

We can now use the information in the above matrix to design the necessary Write Off Process Templates and Write Off Event Types.

Designing Write Off Process Templates & Write Off Event Types

The following table shows the write-off process templates referenced in the previous section's matrix. Adjacent to each process are its events and an indication of when they are triggered.

Write Off Process Template	Write Off Event Type	Triggered X Days From Start Of Write Off Process
Residential	Refer to collection agency	0
	Letter notifying customer of referral	0
	Cancel collection agency referral	60
	Write off	60
Non-Cash Deposit Exists	To Do for non-cash deposit redemption	0
	To Do to highlight unpaid SA(s) still exist (and they will be reconsidered for write-off processing)	10
Commercial	Refer to collection agency	0
	Letter notifying customer of referral	0

To Do to check up on collection agency's efforts	30
Cancel collection agency referral	60
Write off	60

If we extract each unique event type from the above table, we end up with the following:

Write Off Event Type	Event Type
Notification of write-off referral	Send letter - Debt referred to a collection agency
Refer to collection agency	Refer to collection agency
Cancel collection agency referral	Cancel collection agency referral
Write off	Write off
To Do for non-cash deposit redemption	Generate To Do - Redeem non-cash deposit
To Do to highlight unpaid SA(s) still exist	Generate To Do - SA(s) linked to a non-cash deposit remain unpaid (and will be reconsidered for write-off processing)
To Do to check up on collection agency's efforts	Generate To Do - Check up on collection agency's efforts

And now you're ready to set up your write-off procedures.

Setting Up Write-Off Procedures

In the previous section, [Designing Your Write-Off Procedures](#), we presented a case study that illustrated a mythical organization's write off procedures. In this section, we'll explain how to set up the control tables to implement these procedures:

Setting Up Write Off Debt Classes

Every SA type has a write-off debt class. This class is one of several fields that control the write off criteria applied to the service agreement's debt. Select **Admin > Credit & Collection > Write Off Debt Class** to define your debt classes.

FASTPATH:

For more information about debt classes, see [Designing Your Write-Off Debt Classes](#).

Panel controls

To modify a write-off debt class, simply move to a field and change its value. To add a new write-off debt class, click + to insert a row, then fill in the information for each field. The following fields display:

Write Off Debt Class Code The unique identifier of the write off debt class.

Eligible for Write Off Indicates if service agreements belonging to this write off debt class are eligible for write-off processing. This should only be turned off if this debt cannot be written off, e.g., write off debt.

Description The description of the write off debt class.

Setting Up Write Off Event Types

Write-off event types control what is done by a given write-off event. Select **Admin > Credit & Collection > Write Off Event Type > Add** to define your write-off event types.

Description of Page

Enter a unique **Write Off Event Type** code and **Description** for the write-off event type.

Select the **Write Off Event Type**. Permissible values are: Affect Credit Rating/Cash-Only, Cancel Agency Referral, Generic Algorithm, Refer to Agency, Send Letter, Create To Do Entry, Write Off using Distrib Code, and Write Off using SA Type. The following discussion describes the parameters that must be defined for each type of write-off event.

The Affect Credit Rating/Cash-Only write-off event type causes a credit rating demerit record to be linked to the account. This record is constructed using the following **Parameters**:

- Use **Affect Credit Rating By** to define this event's affect on the account's credit rating. This should be a negative number. An account's credit rating is equal to the beginning credit rating amount defined on the installation record or the account's CIS Division plus the sum of credit rating demerits that are currently in effect. When an account's credit rating is less than the credit rating threshold defined on the installation record or the account's CIS Division, the account's credit rating is displayed as an alert on Control Central.
- Use **Affect Cash-Only Score By** to define this event's affect on the account's cash-only score. This should be a positive number. When an account's cash-only score exceeds the cash-only threshold score defined on the installation record or the account's CIS Division, the account is flagged as cash-only during payment processing and on Control Central.
- Use **Months Affecting Credit Rating** to define the length of time the demerit remains in effect. This information is used to define the effective period of the credit rating demerit record.

FASTPATH:

For more information, refer to [Account - Credit Rating](#).

The Cancel Agency Referral event type will cancel previous collection agency referrals. No parameters are needed for this type of event.

The Generic Algorithm write-off event type causes the algorithm defined in the **Generic Algorithm** to be executed. You use this type of algorithm when the standard types of write off events won't do what you need done. If you haven't done so already, you must set up this algorithm in the system. To do this:

- Create a new algorithm (refer to [Setting Up Algorithms](#)).
- On this algorithm, reference an Algorithm Type that determines the algorithm that will be called when events of this type are activated.

The Refer to Agency event type will refer the debt associated with the process' SAs to a collection agency. You must supply the **Agency Selection Algorithm** that is used to determine the collection agency associated with the referral. If you haven't done so already, you must set up this algorithm in the system. To do this:

- Create a new algorithm (refer to [Setting Up Algorithms](#)).
- On this algorithm, reference an Algorithm Type that determines the collection agency to which bad debt should be referred.

NOTE:

Letters. You must set up a customer contact type for each type of letter you generate. You specify the necessary customer contact type on the write off event type. Refer to [Setting Up Letter Templates](#) for more information.

The Send Letter write-off event type causes a customer contact to be generated that, in turn, generates a letter. Enter the following parameters for this type of event:

- Select the **Contact Class** used to categorize the customer contact.
- Use **Contact Type** to define the type of customer contact to create. The type of customer contact controls the type of letter that is generated.

The Create To Do Entry write-off event type causes a To Do entry to be issued. Refer to [The Big Picture of To Do Entries](#) for more information about To Do entries (refer to the To Do type TD-WOEV for the type of To Do entry that's created).

The Write Off using Distrib Code event type causes bad debt to be written off in accordance with the distribution codes associated with the financial transactions that caused the debt in the first place. Use this method if, for example, you want to write-off revenue differently than you write-off liabilities. When this type of event is activated, the system accumulates the distribution codes from GL details associated with recent financial transactions linked to each write-off service agreement. When the system has accumulated enough distribution codes (i.e., where the amount associated with the distribution code equals or exceeds the amount to write off), the debt will be transferred to a new or existing write-off service agreements. The type of service agreements to which the debt is transferred is defined on the distribution codes. Refer to [Setting Up Distribution Codes](#) for more information.

The Write Off using SA Type event type causes all debt associated with the process' SAs to be transferred to a write-off service agreement linked to the account. Enter the following **Parameters** for this type of event:

- **CIS Division / SA Type** is the type of write-off service agreement to which the debt will be transferred. Note well,
 - The system will reuse an existing service agreement if an active SA of this type is already linked to the account; otherwise the system will create a new service agreement of this type.
 - The adjustment type used to set the offending service agreement's current balance equal to its payoff balance is defined on the write-offable SA Type. Refer to [SA Type - Main Information](#) for more information.
 - The adjustment type used to transfer the delinquent debt to the write-off service agreement is defined on the write off SA type. Refer to [SA Type - Detail](#) for more information.

Enter a **Comment** to fully describe the write-off event type.

Setting Up Write Off Process Templates

Write-off process templates define the write-off events that will be executed when a write-off criteria rule is violated. Select **Admin > Credit & Collection > Write Off Process Template > Add** to define your write-off process templates.

Description of Page

Enter a unique **Write Off Process Template** code and **Description** for the write-off process template.

The rows in the following grid define the events that will be created when a write off process is created using this template. The following fields display:

Event Sequence Controls the order in which the write-off event is executed. The sequence number is system assigned and cannot be changed. If you need to insert a write-off event between two existing events, you must remove the latter events, insert the new event, and then re-enter the removed events.

Write-off Event Type Code Specify the type of write-off event to be generated. The event type's description is displayed adjacent.

Days After Process Creation Specify the number of days after the creation of the write-off process that the related write-off event will be triggered. Refer to [Calendar vs Work Days](#) for a description of how this system uses this information to set the trigger date on the respective write-off events.

FASTPATH:

For more information about write-off event types, see [Setting Up Write Off Event Types](#). For more information about trigger dates, see [Write-off Event Trigger Date](#).

Setting Up Write Off Control

Write-off controls define how the system handles finalized, unpaid debt belonging to a given collection class and write off debt class.

Write Off Control - Main

Select **Admin > Credit & Collection > Write Off Control > Add** to define basic information about a write-off control. After entering basic information, navigate to the **Criteria** tab to define the type of write-off process to start when given criteria are met.

FASTPATH:

For more information about write-off control, refer to [Designing Write-Off Controls](#).

Panel controls

Enter a **Write Off Control** code and **Description** for the write-off control (WOC).

Enter the **Collection Class** to which the WOC applies.

Enter the **Write Off Debt Class Code** to which the WOC applies.

Enter general **Comments** to further describe the WOC.

Define the **Synch All Algorithm** used by the system to generate adjustments that cause current balance to equal payoff balance on the service agreements to be written off. This type of algorithm is issued before you actually start a write-off process as current balance is meaningless at write-off time (the customer owes you the payoff balance). If you haven't done so already, you must set up this algorithm in the system. To do this:

- Create a new algorithm (refer to [Setting Up Algorithms](#)).
- On this algorithm, reference an Algorithm Type that synchronizes current and payoff balances.

Define the **Debt Transfer Algorithm** used by the system when it attempts to transfer the unpaid debt to another active service agreement linked to the stopped SA's account. If you haven't done so already, you must set up this algorithm in the system. To do this:

- Create a new algorithm (refer to [Setting Up Algorithms](#)).
- On this algorithm, reference an Algorithm Type that transfers unpaid balances.

Define the **Write Down Algorithm** used by the system when it attempts to write-down small debt and/or credit balances. If you haven't done so already, you must set up this algorithm in the system. To do this:

- Create a new algorithm (refer to [Setting Up Algorithms](#)).
- On this algorithm, reference an Algorithm Type that writes down small amounts.

Define the **Credit Refund Algorithm** used by the system when it refunds a credit balance to a customer. If you haven't done so already, you must set up this algorithm in the system. To do this:

- Create a new algorithm (refer to [Setting Up Algorithms](#)).
- On this algorithm, reference an Algorithm Type that refunds credit balances.

Write Off Control - Criteria

Select **Admin > Credit & Collection > Write Off Control > Search** and navigate to the **Criteria** page to define the type of write-off process to start when given criteria are met.

FASTPATH:

The following information is not intuitively obvious. Refer to [Designing Write-Off Controls](#) for more information.

Panel controls

The information in the grid defines the write-off process to be executed for debt belonging to the previously defined collection class and write off debt class. The type of write-off process may differ depending on some condition. For example, you may have a different write-off process if the customer has a non-cash deposit. You must have at least one entry in this collection otherwise the system will not start a write-off process. This entry should have the lowest priority code and should reference a **Write Off Criteria Algorithm** that references the WO CRIT DFLT the algorithm type.

The following fields display:

Priority controls the order in which the criteria will be checked by the Write Off Monitor (higher priorities are checked before lower priorities). The first criteria algorithm that is met (i.e., returns a value of *True*) will cause the associated write-off process to be initiated.

NOTE:

The values for this field are customizable using the Lookup table. This field name is CRIT_PRIO_FLG. Be aware that this field is used for multiple tables: [Collection Class Control](#), [Severance Criteria](#), and [Write Off Control](#).

Write Off Criteria Algorithm The Write Off Monitor checks if the condition defined by the W/O Condition Algorithm applies to the account whose debt is being analyzed. If a condition is met, a write-off process is created using the associated write-off process template.

If you haven't done so already, you must set up this algorithm in the system. To do this:

- Create a new algorithm (refer to [Setting Up Algorithms](#)).
 - On this algorithm, reference an Algorithm Type that determines if a customer's bad debt should be processed using the associated **Write Off Process Template**.
-

IMPORTANT:

You must have at least one entry in this grid otherwise the system will not start a write-off process. This entry should have the lowest priority code and should reference a **W/O Criteria Algorithm** that references the WO CRIT DFLT algorithm type.

Write Off Process Template If the Write Off Monitor determines the condition defined by the w/o condition algorithm applies, a write-off process is created using the associated write-off process template.

Where Used

Write-off controls contain the data that controls the Write Off Monitor. Refer to [How Does The Write-Off Monitor Work?](#) for more information.

Setting Up Collection Agencies

You must set up a collection agency for each such organization to which you refer delinquent debt. To define a collection agency, select **Admin > Credit & Collection > Collection Agency**.

Description of Page

Enter an easily recognizable **Collection Agency** code and **Description** for each collection agency.

A collection agency must be associated with a Person. Choose the **Person ID** of the organization from the prompt.

FASTPATH:

Information about how to set up persons is discussed in [Maintaining Persons](#).

Turn on the **Active** switch if the collection agency is actively receiving referrals.

Specify the **Batch Control** that's used to route new and cancelled referrals to the collection agency. The batch control's description is displayed adjacent.

Where Used

Collection agencies get assigned to collection agency referrals when the collection agency referral background process executes. Refer to [How Do Collection Agency Referrals Work?](#) for more information.

Setting Up Feature Configuration

You must set up a [Feature Configuration](#) if you use the [champion / challenger](#) functionality.

The following describes the various **Option Types** that must be defined:

Champion Template\$Challenger Template\$Percentage(1-100). You need only set up options of this type if your implementation implements [Champion / Challenger](#) functionality. Options of this type are entered in the format A\$B\$nnn where A is the collection process template of the champion template, B is the collection process template of the challenger template, and C is the percent of the time that the system should create the challenger template. The collection monitor uses this option to override the champion collection process template X% of the time with the challenger template. You may enter any number of these options (but only one per Champion Template).

How To

The contents of this section describe how to set up various credit and collections scenarios.

How To Nominate A Single Service To Sever (Rather Than Sever Everything That's In Arrears)

Some organizations that offer multiple services do not sever all services when the customer falls into arrears. Rather, they nominate a single service agreement to sever in the hopes that the lack of service will cause the customer to remit payment. The following diagram illustrates the control tables values required to implement this type of requirement.

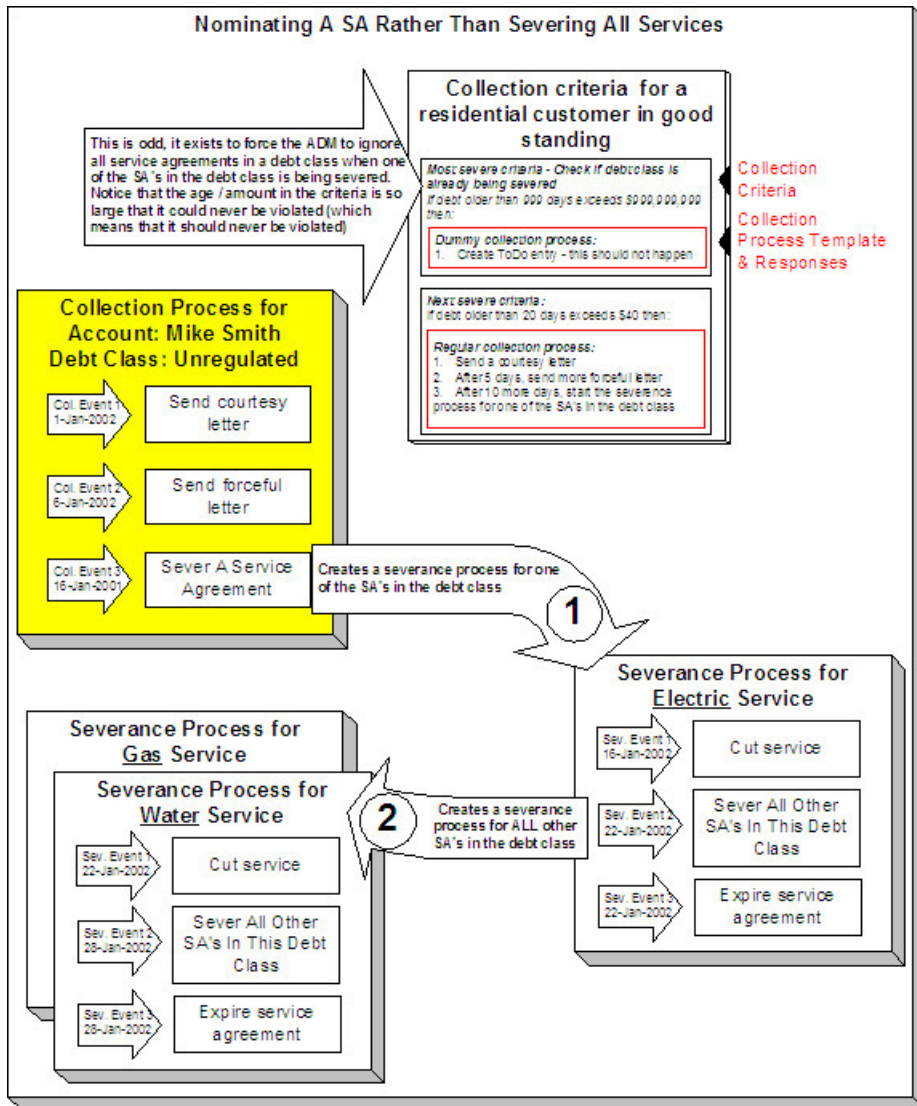

The following important concepts are illustrated above:

- The collection process's last event does NOT sever all services. Rather, it calls an algorithm that selects a single service to sever. A base package algorithm allows you to define the primary service to sever and a secondary service to sever (if the customer does not have the primary service). If you sold electricity and gas, you would probably define the primary service as electricity and the secondary as gas (because electricity is easier to cutoff than gas).
- The severance process that is started for the primary service cuts service. If the customer doesn't remit what is owed, the second severance event calls an algorithm that severs all other service agreements in the debt class.
- Because you are nominating a single service to sever, you must set up a special value in collection class control to force the ADM to ignore all service agreements in a debt class when one of the SAs in the debt class is being severed. Notice that the age / amount in the criteria is so large that it could never be violated.
- In addition, because the entire debt class must no longer be in arrears to stop the collection and severance processes, you must plug-in the appropriate collection process and severance process cancellation criteria on the debt class. Refer to [How Are Collection Processes Cancelled](#) and [How Are Severance Processes Cancelled](#) for more information about how these algorithms are used. Also note, you do not need service agreement cancellation criteria defined on your collection process templates and severance process templates (because cancellation is controlled at the debt class level).

Defining Asset Options

NOTE: The asset management functionality described in this section is available only to cloud implementations using Oracle Utilities Customer Cloud Service or Oracle Utilities Meter Solution Cloud Service.

Asset Activity Types

Understanding Asset Activity Types

Activity types define the main attributes broad range of activities, such as maintenance, repairs, inspections, field work etc. The base package includes an asset activity type business object (W1-SOMActivityType) that should be used when created asset activity types.

Activity types are defined by:

- **Activity Business Object:** The business object used for asset activities of this type
- **Activity Schedule Information:** Default scheduling information for asset activities of this type, including Activation Lead Days, Work Lead Days, and Activity Disposition.
- **Attachments:** One or more attachments associated with asset activities of this type, such as procedures or checklists.
- **Exception Handling:** Details regarding exception handling for asset activities of this type, including default To Do Type, To Do Role, and retry options.
- **Completion Event Types:** One or more completion event types associated with asset activities of this type. See [Understanding Completion Event Types](#) for more information.
- **Object To Create:** The service history type to be created by asset activities of this type. Service history records are created by Create Activity Type's Service History completion events.

Refer to [Defining Asset Activity Types](#) for more information about setting up asset types.

NOTE: Asset activity types are created by the system when [field task types](#) are created in Service Order Management.

Defining Asset Activity Types

You use the **Activity Type** portal to display and maintain asset activity types.

Refer to [Understanding Asset Activity Types](#) for more information.

You can access the portal by selecting **Admin**, then **Asset Management**, then **Asset Activity Type**. You are brought to a query portal with options for searching. Once your record has been selected you are brought to the maintenance portal to view and maintain the selected record.

The following zones may appear as part of the portal's **Main** tab page:

- **Activity Type:** This zone displays basic information about the activity type.
- **Attachments:** This zone attachments associated with the activity type.

Asset Completion Event Types

Understanding Asset Completion Event Types

Asset completion event types are used to define various processes or events to be executed when completing an asset activity such as asset replication, service history creation, attachment creation, and activity creation.

Asset completion event types are referenced on activity types to indicate which completion events should be included as part of the lifecycle of activities of that type. For example, this affects when service history is created for an activity, and the disposition of the assets on an activity as the activity is processed. Asset completion events can be configured as optional or required for activities of different types.

Asset completion event types are defined by:

- **Completion Event Business Object:** The business object used for asset completion events of this type
- **Identifiers:** One or more identifiers that can be used to characterize asset completion events of this type
- **Inbound Communication:** Information used to create asset completion events of this type using information defined within an inbound communication business object, or within its raw message
- **UI Payload Create Data Mover:** XPath statements executed when creating asset completion events of this type online. These statements are used to populate elements within the payload from the completion event business object.

Refer to [Defining Completion Event Types](#) for more information about setting up completion event types.

Defining Asset Completion Event Types

You use the **Completion Event Type** portal to display and maintain asset completion event types.

Refer to [Understanding Asset Completion Event Types](#) for more information.

You can access the portal by selecting **Admin**, then **Asset Management**, then **Asset Completion Event Type**. You are brought to a query portal with options for searching. Once your record has been selected you are brought to the maintenance portal to view and maintain the selected record.

The following zones may appear as part of the portal's **Main** tab page:

- **Completion Event Type** : This zone provides information about the selected completion event type, including as inbound communications and attachments.
- **Unlink Activity Types:** This zone enables the removal of an activity type from the completion event type. To remove an activity type select the activity type(s) to remove and click **Remove**. The selected activity types will no longer appear in the **Unlink Activity Types** zone.
- **Link Activity Types:** This zone enables adding an activity type to the completion event type. To link an activity type:
 1. Enter search criteria in the **Activity Type Description** field and click **Search**. The zone will display a list of activity types matching your search criteria.
 2. Select the activity type(s) to add and click **Link**. The selected activity types will now appear in the **Unlink Activity Types** zone.

Asset Inbound Communication Types

Understanding Asset Inbound Communication Types

Asset inbound communication types define the information required for the system to receive messages from external systems. These typically hold value mappings of the inbound communication elements to an xpath element in the completion message.

Asset inbound communication types are defined by:

- **Inbound Communication Business Object:** The business object used for asset inbound communications of this type
- **Exception Handling:** Details regarding exception handling for asset inbound communications of this type, including default To Do Type, To Do Role, and retry options.
- **Message Validation:** Source elements within the inbound communication business object or raw message used for validation of asset inbound communications of this type
- **Communication Data Mapping:** Information used to populate communication business object elements from information within the communication's raw message
- **Attachment Suppression:** Substitution text used in place of large data attachments in the completion event list on the inbound communication. Used when messages received from an external system contain attachment data that are very large.

Refer to [Defining Asset Inbound Communication Types](#) for more information about setting up asset inbound communication types.

Defining Asset Inbound Communication Types

You use the **Communication Type** portal to display and maintain asset inbound communication types.

Refer to [Understanding Asset Inbound Communication Types](#) for more information.

You can access the portal by selecting **Admin**, then **Asset Management**, then **Asset Inbound Communication Type**.

The following zones may appear as part of the portal's **Main** tab page:

- **Communication Type List:** This zone lists all asset inbound communication type records. Broadcast a record to display the details of the selected record.
- **Communication Type:** This zone provides information about the selected communication type, such as attachment suppression, communication data mapping, message validation and exception handling.

Asset Types

Understanding Asset Types

Asset types define the attributes for assets and components of a certain type including information such as the valid location types and service history types for the assets and whether or not such assets can have attached components.

Asset types are defined by:

- **Component Relationship:** A flag that indicates if components can be installed on assets or components of this type
- **Asset Business Object:** The business object used for assets or components based on this asset type
- **Valid Location Types:** A list of location types where assets or components of this type can be located

- **Valid Attached To Asset Types:** A list of valid asset types where components of this type can be attached (applicable to components only)
 - **Valid Service History Types:** A list of valid service history types that can apply for assets or components of this type
- Refer to [Defining Asset Types](#) for more information about setting up asset types.

Asset Classes

Assets are defined by classes, each of which is based on a specific business object, and determines the type of asset: an asset or a component.

The table below lists the asset classes and the business object for each.

Asset Class	Business Object
Asset	W1-AssetType (Operational Device Asset Type)
Component	W1-ComponentType (Operational Device Component Type)

Defining Asset Types

You use the **Asset Type** portal to display and maintain asset types.

Refer to [Understanding Asset Types](#) for more information.

You can access the portal by selecting **Admin**, then **Asset Management**, then **Asset Type**. You are brought to a query portal with options for searching. Once your record has been selected you are brought to the maintenance portal to view and maintain the selected record.

The following zones may appear as part of the portal's **Main** tab page:

- **Asset Type** : This zone provides information about the asset type.
- **Asset Type Statistics:** This zone displays statistics for the asset type.

Service History Questions

Understanding Service History Questions

Service History Questions are used to guide workers through corrective and preventive inspection processes as part of an asset's service history.

Service history questions are associated to a service history type which is then associated to an asset type.

During a corrective or inspection process, workers can be guided through a series of questions assessing the condition of the asset. The answers can be "weighted", which when calculated, gives an overall score as to the condition of the asset. The calculation is generally a sum (answer points * question weight), but can vary depending on the service history type. The total inspection points are then normalized to an overall grade or score. The condition rating and confidence rating are also calculated and the asset is updated with the appropriate values.

A service history question's answers can be defined as check boxes, multiple choice, or free-form text.

Refer to [Defining Service History Questions](#) for more information about defining service history questions.

Defining Service History Questions

You use the **Service History Question** portal to display and maintain Service History questions.

Refer to [Understanding Service History Questions](#) for more information.

You can access the portal by selecting **Admin**, then **Asset Management**, then **Service History Question**. You are brought to a query portal with options for searching. Once your record has been selected you are brought to the maintenance portal to view and maintain the selected record.

The following zones may appear as part of the portal's **Main** tab page:

- **Question:** This zone provides information about the question.
- **Service History List:** This zone displays a list of service history types that reference the question.

Service History Types

Understanding Service History Types

Service history types define the main attributes for service history of a certain type. Types might include maintenance, inspection, service, test, measurement, and so on.

Service history types are defined by the following:

- **Service History Business Object:** The business object used to create service history records of this type.
- **Category:** The category to which service history records of this type belong. The base package includes the following categories:
 - Downtime
 - Failure
 - Inspection
 - Maintenance
 - Repair
- **Subclass:** The specific subclass of the service history type, based on the **Service History Business Object**. Oracle Utilities Customer To Meter supports two subclasses of service history types:
 - Operational Device Service History
 - Questionnaire Service History

Each service history type subclass includes other specific configuration information, outlined below.

Operational Device Service History Types

Operational Device Service history types are also defined by the following:

- **Service Schedules:** One or more template work orders and time intervals that should be used to schedule work order generation for service history records of this type

Questionnaire Service History Types

Questionnaire Service history types are also defined by the following:

- **Follow-up Actions:** One or more actions intended as “follow-up” actions for service histories of the service history type, such as work orders or work order activities, users can configure those follow-up actions on the service history type. Note that if a regulatory compliance requirement is associated with a follow-up action, a compliance type must be specified. For example, a Service History Type of “Grade 2 Gas Leak”, might include a follow-up action of “Recheck” which could be configured with a “30 day” Compliance Type and a follow-up action of “Repair” which could be configured with a “1 year” Compliance Type.
- **Stop Processing Service History Type:** One or more service history types that should stop the processing of **Follow-up Actions**. For example, certain problem that needs follow up actions was reported. Then another service history, which indicates the problem has been fixed or its severity has changed, is recorded. Businesses might want to stop/cancel the follow up actions based on the original problem/severity.
- **Questions:** A list of one or more questions used to guide inspection of an asset. Questions are defined in the **Questions** portal.

Defining Service History Types

You use the **Service History Type** portal to display and maintain service history types.

Refer to [Understanding Service History Types](#) for more information.

You can access the portal by selecting **Admin**, then **Asset Management**, then **Service History Type**. You are brought to a query portal with options for searching. Once your record has been selected you are brought to the maintenance portal to view and maintain the selected record.

The following zones may appear as part of the portal's **Main** tab page:

- **Service History Type:** This zone provides information about the service history type.
- **Questionnaire Tree:** This zone displays the service history types' questionnaire, based on the questions defined for the service history type. Applicable for Questionnaire service history types only.
- **Unlink Asset Types:** This zone lists the asset types currently linked to the service history type. To unlink one or more asset types, check the corresponding checkboxes and click **Remove**.
- **Link Asset Types:** This zone is used to search for and link asset types to the service history type. To link new asset types,
 1. Enter search criteria in the **Asset Type Description** field.
 2. Click **Search**.
 3. Select the asset types to link by checking the corresponding checkboxes.
 4. Click **Link**.

Configuration Types

Understanding Configuration Types

Configuration types define the information required for various asset configurations with other assets, components, firmware, and other data.

Configurations are referenced on specifications which are then referenced on assets and components to indicate the best way that these entities can work with the other entities that they are connected to in the field.

Configuration types are defined by the following:

- **Configuration Class:** The class for configurations of this type

- **Configuration Category:** The category of configurations of this type
- **Configuration Business Object:** The business object used for configurations of this type

Configuration Classes

In general configuration classes define the types of connections that are being configured. Each configuration class is based on a specific business object, which is the business object used for configurations of each class and type.

The table below lists the configuration classes and the business object for each.

Configuration Class	Business Object
Single Asset	W1-SingleAssetConfig (Single Asset Configuration)
Asset/Component	W1-AssetCompConfig (Asset/Component Configuration)
Asset to Asset	W1-AssetToAssetCompConfig (Asset to Asset/Component Configuration)
Asset/Component to Asset	W1-AssetCompToAssetConfig (Asset/Component to Asset Configuration)
Asset to Asset/Component	W1-AssetToAssetConfig (Asset to Asset Configuration)
Asset/Component to Asset/Component	W1-AssetCompToAssetCompConfig (Asset/Component to Asset/Component Config)

Defining Configuration Types

You use the **Configuration Type** portal to display and maintain configuration types.

Refer to [Understanding Configuration Types](#) for more information.

You can access the portal by selecting **Admin.**, then **Asset Management**, then **Configuration Type**.

The following zones may appear as part of the portal's **Main** tab page:

- **Configuration Type List:** This zone lists all configuration type records. Broadcast a record to display the details of the selected record.
- **Configuration Type :** This zone provides information about the selected configuration type.

Configurations

Understanding Configurations

Configurations document and manage valid setups for assets and components. This includes a specification for each asset or component in the configuration as well as the valid value for each parameter, such as the firmware version of each asset.

Configurations are defined by the following:

- **Configuration Type:** The [configuration type](#) upon which the configuration is based
- **Status:** The current status of the configuration
- **Configuration Detail:** Specific information related to the configuration such as the assets and components involved, the firmware, characteristics, identifiers and other important information

Defining Configurations

You use the **Configuration** portal to display and maintain configurations.

Refer to [Understanding Configurations](#) for more information.

You can access the portal by selecting **Admin**, then **Configuration Report**, then **Configuration**. You are brought to a query portal with options for searching. Once your record has been selected you are brought to the maintenance portal to view and maintain the selected record.

The following zones may appear as part of the portal's **Main** tab page:

- **Configuration:** This zone provides information about the selected configuration.
- **Configuration Attachments:** This zone lists any attachments defined for the configuration.

Configuration Reports

Understanding Configuration Reports

Configuration reports provide a summary of any currently installed configurations.

These reports show whether the configuration in an installation is valid or invalid, the identifiers and values being used, and display all of the assets/components and other elements that make up the installed configuration.

Configuration reports are defined by the following:

- **Reporting Mode:** The mode in which the report is run (One Time or Recurring)
- **Status:** The current status of the report (Pending or Submitted)
- **Report Criteria:** Specific information used to establish the filter criteria when generating the report, such as the assets and components involved, the firmware, characteristics, identifiers and other important information.
- **Report Result:** Specific information for each configuration, including the number of configurations, the assets and components involved, and the specifications and firmware versions of each. If the configuration is invalid, the **Configuration** column is blank in the report results. Users can navigate to specific valid configurations to review and edit the setup as needed. In addition, users can generate a work order to correct, reconfigure, or otherwise maintain any of the configurations by clicking **Generate Activity**.

Base Package Configuration Reports

The base package includes a number of configuration reports, each based on one of the support configuration classes (see [Understanding Configuration Types](#)).

The table below lists the configuration reports and the business object for each.

Configuration Report	Business Object
Single Asset Configuration Report	W1-SingleAssetCfgRpt
Asset/Component Configuration Report	W1-AssetCompCfgRpt
Asset to Asset Configuration Report	W1-AssetToAssetCfgRpt
Asset/Component to Asset Configuration Report	W1-AssetCompToAssetCfgRpt
Asset to Asset/Component Configuration Report	W1-AssetToAssetCompCfgRpt

Defining Configuration Reports

You use the **Configuration Report** portal to display and maintain configuration reports.

Refer to [Understanding Configuration Reports](#) for more information.

You can access the portal by selecting **Admin**, then **Configuration Report**, then **Configuration Report**. You are brought to a query portal with options for searching. Once your record has been selected you are brought to the maintenance portal to view and maintain the selected record.

The following zones may appear as part of the portal's **Main** tab page:

- **Configuration Report:** This zone provides information about the selected configuration report.

Defining Location Options

Asset Location Types

Understanding Asset Location Types

Asset location types define the details of locations of a certain type where assets or components can be installed. Valid types of asset locations can include service points, other locations for installed assets, or any other location as defined by your organization.

Asset location types are defined by the following:

- **Class:** The general class for asset locations of this type, such as commercial or residential, a shop or warehouse, etc.
- **Location Business Object:** The business object used for asset locations of this type
- **Number of Assets Allowed:** A flag that indicates whether or not asset locations of this type can accommodate a single or multiple assets
- **Service Type:** The type of service (electric, water, etc.) that asset locations of this type support
- **Allow Related Work Locations:** A flag that indicates whether asset locations of this type should be allowed to be connected to a work location
- **Valid Parent Location/Organization Types:** One or more valid parent locations and parent organizations that can be referenced on asset locations of this type. Used primarily for reporting.
- **Valid Communicate-To Location Types:** One or more asset location types to which asset locations of this type can communicate. The **Tree View** tab of any asset or location will display other related assets with a visual indication of their relationship.

NOTE: Asset location types are used to define locations where assets and components are installed. Locations where assets that are out of service are stored and maintained are defined via [Out of Service locations](#) and [Out of Service location types](#).

NOTE: In Oracle Utilities Customer To Meter, asset location types are maintained via [Merged Maintenance](#).

Defining Asset Location Types

You use the **Asset Location Type** portal is used to display and maintain asset location types.

Refer to [Understanding Asset Location Types](#) for more information.

You can access the portal by selecting **Admin, Location**, then **Asset Location Type**.

The following zones may appear as part of the portal's **Main** tab page:

- **Asset Location Type List:** This zone lists all asset location type records. Broadcast a record to display the details of the selected record.
- **Asset Location Type:** This zone provides information about the selected asset location type.

NOTE: In Oracle Utilities Customer To Meter, asset location types are maintained via [Merged Maintenance](#).

Organization Types

Understanding Organization Types

Organization types define the main attributes for organizations of a certain type.

Organization types are defined by the following:

- **Class:** The general class organization. Parent organizations have a class of “Parent”.
- **Organization Business Object:** The business object used for organizations of this type
- **Valid Parent Organization Types:** One or more valid parent organizations that can be referenced on organizations of this type. Used primarily for reporting.

Defining Organization Types

You use the **Organization Type** portal is used to display and maintain organization types.

Refer to [Understanding Organization Types](#) for more information.

You can access the portal by selecting **Admin**, then **Location**, then **Organization Type**.

The following zones may appear as part of the portal's **Main** tab page:

- **Organization Type List:** This zone lists all organization type records. Broadcast a record to display the details of the selected record.
- **Organization Type:** This zone provides information about the selected organization type.

Organizations

Understanding Organizations

Organizations are used for categorization and reporting for locations.

For example, your reporting may include a hierarchy that groups locations by a structure of parent and child organizations. Organizations are defined by the following:

- **Organization Type:** The organization's type. [Understanding Organization Types](#) for more information.
- **Organization Disposition:** The current status of the organization (Active or Inactive)
- **Parent Organization:** The parent organization, if applicable.
- **Main Contact:** A contact for the organization

Defining Organizations

You use the **Organization** portal to display and maintain organizations.

Refer to [Understanding Organizations](#) for more information.

You can access the portal by selecting **Admin**, then **Location**, then **Organization**. You are brought to a query portal with options for searching. Once your record has been selected you are brought to the maintenance portal to view and maintain the selected record.

The following zones may appear as part of the portal's **Main** tab page:

- **Organization:** This zone provides information about the organization.
- **Child Locations / Organizations:** This zone lists any child locations and/or organizations for the current organization.

Out of Service Location Types

Understanding Out of Service Location Types

Out of service location types define attributes of types of locations where assets that are out of service are stored and maintained. Examples of out of service locations include warehouses, storerooms, and repair shops.

Out of service location types are defined by the following:

- **Class:** The general class (storeroom, meter shop, etc.) of out of service locations of this type
- **Location Business Object:** The business object used for out of service locations of this type
- **Valid Parent Location/Organization Types:** One or more valid parent locations and parent organizations that can be referenced on out of service locations of this type. Used primarily for reporting.

Defining Out of Service Location Types

You use the **Out of Service Type** portal is used to display and maintain out of service location types.

Refer to [Understanding Out of Service Location Types](#) for more information.

You can access the portal by selecting **Admin**, then **Location**, then **Out of Service Location Type**.

The following zones may appear as part of the portal's **Main** tab page:

- **Out of Service Location Type List:** This zone lists all out of service location type records. Broadcast a record to display the details of the selected record.
- **Out of Service Location Type:** This zone provides information about the selected out of service location type.

Out of Service Locations

Understanding Out of Service Locations

Out of service locations are physical locations where assets are stored or repaired such as a storeroom, warehouse, or service facility. When assets are changed to statuses such as “In Repair” or “Pending Disposition” the asset location is typically moved to an out of service location.

Out of service locations are defined by the following

- **Location Type:** The out of service location’s type. See [Understanding Out of Service Location Types](#) for more information.
- **Location Disposition:** The current status of the out of service location (Active or Inactive)
- **Parent Location/Organization:** The out of service locations’ parent location or organization (if applicable)
- **External ID:** An ID used to identify the out of service location in external systems
- **Address Information:** The physical address of the out of service location
- **Contacts:** The primary contact for the out of service location. See [About Contacts](#) and [Maintaining Contacts](#) for more information about creating and maintaining contacts used with out of service locations.
- **Field Information:** Additional information about the physical location, such as GPS coordinates

Defining Out of Service Locations

You use the **Out of Service Location** portal to display and maintain out of service locations.

Refer to [Understanding Out of Service Locations](#) for more information.

You can access the portal by selecting **Admin**, then **Location**, then **Out of Service Location**. You are brought to a query portal with options for searching. Once your record has been selected you are brought to the maintenance portal to view and maintain the selected record.

The following zones may appear as part of the portal’s **Main** tab page:

- **Out of Service Location:** This zone provides information about the out of service location.
- **Current Activities:** This zone provides a summary of the activities that are currently associated to the location.
- **Asset Summary:** This zone provided statistics about the number of assets, by asset type, that are currently associated with the location.
- **Owned Attachments:** This zone lists attachments owned by the location.
- **Referenced Attachments:** This zone lists attachments related to the location.

NOTE: See [About Contacts](#) and [Maintaining Contacts](#) for more information about creating and maintaining contacts used with out of service locations.

Defining Device Options

Command Sets

Understanding Command Sets

Command sets are used to define a group of commands that are not eligible for a particular device. For instance, if Commission or Decommission commands should be considered ineligible for a particular device model, a command set that references the Device Commission and Device Commission business objects could be created and associated with that device model.

Command sets are specified for individual device models via the Manufacturer portal.

Individual devices of a particular model can be configured to override ineligibility if needed.

Configuring Command Sets

This portal is used to display and maintain a Command Set.

Refer to [Understanding Command Sets](#) for more information.

You can access the portal by selecting **Admin**, then **Device**, then **Command Set**.

The following zones may appear as part of the portal's **Main** tab page:

- **Command Set List:** This zone lists all Command Set records. Broadcast a record to display the details of the selected record.
- **Command Set:** This zone provides information about the selected Command Set.

Head End Systems

Understanding Head End Systems

Head end systems are systems that collect measurement data and meter events for eventual submission to the application. Many devices can communicate to the application through a single head-end system, but a utility may have numerous head-end systems through which they communicate with devices.

Head end systems utilize processing methods that specify the type of initial measurement data and device events to create for devices (and their related measuring components) based on measuring component type. Head end systems also utilize processing methods that specify how smart meter commands are processed.

Refer to [Understanding Process Methods](#) for more information about processing methods.

Head End Systems Impact Data Import and Export

Head end systems are configured to identify how a particular external system communicates data with Oracle Utilities Meter Data Management. This includes:

- The identifier type used to locate devices and measuring components. These are used both on import and export of data.
- The date/time format used in various data imports (i.e. whether or not the date/time format includes time zone information).

Please refer to the embedded help for more information about these fields.

Each head end system can be associated to an [external system](#) which is used to define the messages that can be sent to that service provider and how each message is sent.

Understanding Processing Methods

Head end systems, external applications, and market participants can have one or more associated processing methods that define the format or means by which it receives or sends data from or to the application, such as bill determinants, interval data, or meter events. Processing methods are also used to define how to create information internal to the application such as initial measurement data and usage transactions. Processing methods can also be used to define the information an external system wishes to subscribe to receive from our application.

At the lowest level processing methods are used to identify an outbound message type, business object, batch control, or message category and number.

Each processing method is comprised of a business object that defines what is being mapped as well as how it should be mapped.

Important Processing Method System Events

The actual logic to determine the appropriate output for a given head end system, external application, or market participant and processing role for a processing method is executed by the following system event:

- **Determine Processing Method(s):** is a business object algorithm system event that takes in a head end system, external application, or market participant, a processing role, and a list of relevant input data aka related object (e.g. a measuring component, device, etc). For the head end system or external application and the input data it will analyze the selection criteria to determine the appropriate output.

How Processing Methods Work

Processing methods perform two basic tasks:

- They define the criteria for selecting the appropriate output. This can be as simple as providing a single object in return without qualification or in more involved situations it could support determining the appropriate return object based on characteristics of the data being processed. This is accomplished through the data structure defined on the processing method business object.
- They evaluate the criteria for selecting the appropriate output given a specific head end system, external application, or market participant. This is accomplished through the Determine Processing Method system event on the processing method business object.

Each processing method business object can be associated to one or more processing roles. This is done by adding the Applicable Processing Role business object option. It is these processing roles that actually create the association between a head end system, external application, or market participant, the processing method, and the functional event that is being executed. For example, when initial measurement data is processed through the IMD Seeder the processing role Initial Measurement Creation is used to identify the processing method "How to Create MC Related Information" which maps a particular measuring component type to the appropriate initial measurement business object to be used for processing.

When system logic requires the results of a processing method the service Determine Service Providers and Methods is used. This service is available to call via Java or from within scripting through the business service of the same name. It can be called in one of two ways:

With a head end system, external application, or market participant: identifies the appropriate output for a single head end system, external application, or market participant being processed for the input processing role and related objects

Without a head end system, external application, or market participant: used to identify subscribing systems. This will provide a list of any head end system, external application, or market participant that has the input processing role and an appropriate output given the related objects.

Processing Methods Available

There are the following processing methods provided by the base package:

Name	Details	Business Object
How to Create OB COMM/Send OB Message	Identifies Message Number/Category, Business Object, Outbound Message Type and allows for an override by a device type.	D1-HowToCreateActivityOBComm
How to Create MC Related Information	Identifies a business object and allows for an override by measuring component type.	D1-HowToCreateMCInformation
How to Process Device Event Related Info	Identifies a business object, outbound message type, and batch control by device event category allowing for an override by device event type.	D1-HowToProcDvcEvtsInformation
How to Process Device Related Information	Identifies a business object and allows for an override by device type.	D1-HowToProcessDeviceInfo
How to Send Activity Related Information	Identifies a batch control and business object by activity type and allows for an override by device type.	D1-HowToSendActInformation
How to Send Activity Related O/B Messages	Identifies an outbound message type, message category, and message number and allows for override by activity type.	D1-HowToSendActivityResponse
How To Create US Related Information	Identifies a business object and allows for override by usage subscription type.	D2-HowToCreateUSInformation
How To Send US Related Information	Identifies a batch control, business object, and outbound message type and allows for override by usage subscription type.	D2-HowToSendUSInformation
How to Process Service Point Related Info	Identifies a business object and allows for override by service point type.	D1-HowToProcSPRelatedInfo
How to Send Field Activity Related Info	Identifies a outbound message type and allows for an override by field task type.	D1-HowToSendFARelatedInfo
How to Send Field Activity Remark Info	Identifies an outbound message type for an activity remark type.	D1-HowToSendActivityRemarkInfo
How to Translate External Value	Identifies a business object and allows for override by identifier.	D1-HowToTranslateExternalValue
How to Request Customer Notification	Identifies a list of outbound message types.	D1-HowToRequestCustomerNotific
How to Process Business Flag Related Info	Identifies an outbound message type and allows for an override by business flag type.	D1-HowToProcessBusinessFlagInf

Understanding SGG Adapter Configuration

This section describes how to use a head end system's SGG Adapter Configuration portal.

You can use the SGG Adapter Configuration portal to view configuration information and access configuration components for an SGG adapter head end system.

Note: This portal displays configuration information for head-end systems that reference an SGG Adapter Configuration Sheet extendable lookup..

To use the configuration information portal for an SGG adapter head end system:

Select **Admin > Device > Head End System**.

In the Head End system List zone, click the Broadcast icon for the head-end system you wish to view.

Click the SGG Adapter Configuration tab to view the configuration information.

The SGG Adapter Configuration portal contains the following zones:

- **SGG Adapter Configuration Tracker:** This zone displays the configuration details of the adapter, as defined by the SGG Adapter Configuration Sheet extendable lookup referenced on the head end system. The configuration details include:

The components required for usage and event processing and command processing. To view more details about the components, you can click the component name to go to the business object for the component. For example, you can click the business object "SSN - Connect or Disconnect" to go to the business object portal for the SSN - Connect or Disconnect business object.

Status messages describing the configuration status of components. The following table lists the status messages that may be displayed and the possible actions you can take:

If the status message is...	You can...
Set up this processing method	Click the processing role to set up the processing method.
This processing method has been configured	Click the processing role to view the configured processing method.
Update your processing method with a communication BO	Click the status message to set up the processing method.
Update your external system / outbound message type with an Message sender	Click the status message to go to the external system.
Update your processing method with an outbound message type	Click the status message to set up the processing method.
Add a value to get started	Click the status message to go to the extendable lookup.
Values Existing: (number)	Click the status message to go to the extendable lookup.
Add a communication type	Click the status message to go to the communication type portal.
Add a device event type	Click the status message to go to the device event type business object for the communication type. This message appears only for Echelon type adapters.
Master Configuration has been added	Click the status message to view the Master Configuration portal.
Add Master Configuration for this adapter	Click the status message to view the Master Configuration portal.

Upload Statistics Aggregators: This zone lists the IMD Upload Statistics Aggregator measuring components associated with the head-end system.

Configuring Head End Systems

This portal is used to display and maintain Head End Systems.

Refer to [Understanding Head-End Systems](#) for more information.

You can access the portal by selecting **Admin**, then **Device**, then **Head End System**.

The following zones may appear as part of the portal's **Main** tab page:

- **Head End System List:** This zone lists all Head End System records. Broadcast a record to display the details of the selected record.
- **Head End System:** This zone provides information about the selected Head End System.
- **Processing Method List:** This zone provides the list of processing methods defined for the Head End System.
- **Translation Methods List:** This zone provides the list of translation methods defined for the Head End System.
- **Inbound BOs Send By Service Provider:** This zone lists inbound Business Objects that are sent by this Head End System. The identification is driven by the Business Object having a Business Object Option of type "Sent By Service Provider" that references the current Head End System.

Measuring Component Types

Understanding Measuring Component Types

Measuring component types define the most important properties of a measuring component.

Measuring component types define what a measuring component measures (KWH, temperature, etc.), how regularly it measures it, and whether it should be connected to a physical device, or if it's used as a scratchpad measuring component or an aggregator measuring component. Measuring component types also specify how the measuring component's final measurements should be stored, how the measuring component's user-defined values should be calculated, and specific rules governing validation, editing, and estimation (VEE) for measuring components of the type. In addition, measuring component types define display properties and valid attribute values for measuring components belonging to the type.

The following configurable items are available for most measuring component types:

- **Value Identifiers:** These store the values of UOM, TOU, and SQI that identify the measured amounts for measuring components of this type. Value identifiers specify the quantities stored on the measurement records for measuring components of this type. Please refer to the [Measuring Component Type Value Identifiers](#) topic later in this section for more information.
- **Valid VEE Groups:** These define the VEE groups considered valid for measuring components of this type. Each group supplied here will be available to be selected on measuring components of this type and act as an override to the Fallback VEE Groups.
- **Fallback VEE Groups:** These define default VEE groups for a specific VEE Group Role that can be used with all measuring components of this type. This alleviates the need to specify the same VEE groups on multiple measuring components of the same type. Changes made to these groups will automatically apply to all measuring components of this type unless they have specified their own VEE groups for that particular VEE Group Role. Each VEE group is designated a VEE group role that indicates when and how the VEE group is used (for initial load, manual override, estimation, etc.).
- **Eligible Profile Factors (interval only):** These define the profile factors that are considered to be eligible for interval measuring components of this type. One profile factor can be identified as the default. The default profile factor will be automatically selected in system processing when a profile factor is required.
- **Valid Profile Factors for Conversion from Scalar to Interval (scalar only):** These define the profile factors that are considered to be eligible for scalar measuring components of this type when converting scalar measurements to interval measurements. These profile factors are used to produce a curve of interval data from a scalar value. Without one of these factors defined scalar to interval conversion will use a flat line method (i.e. evenly divide the scalar value across the intervals). One profile factor can be identified as the default. The default profile factor will be automatically selected in system processing when a conversion profile factor is required.
- **Valid Scratchpad Measuring Component Types:** These define the scratchpad measuring component types considered valid for measuring components of this type.
- **Related Statistics Measuring Component Types:** These define the measuring component types that will be used to store statistical information about the historical usage of measuring components of this type. Please refer to [Configuring Measuring Component Statistics](#) for more information on how this list is used.
- **Display Properties:** Defines how measurement data for measuring components of this type is displayed, including:
 - *Display Configuration:* Details related to how measurements are displayed, including the 360 chart rendering method, number of hours of data to display, the maximum days to search for measurements, the default TOU map used, the TOU by Day Profile factor used, and default measurement condition.
 - *Event Bar Profiles:* The event bar profiles used when displaying measurement data for measuring components of this type. Event bar profiles are defined as values for the 360 View Event Bar Profile extendable lookup.

- *Final Values Overlay Profiles*: The final values overlay profiles used when displaying measurement data for measuring components of this type. Final values overlay profiles are defined as values for the Final Values Overlay Profile extendable lookup.
- *Measurement Conditions Not Shown on Chart*: The measurement conditions that should be omitted from rendering onto 360 Degree charts. Measurements whose conditions match these values will be rendered as gaps. For example, many 360 Degree charts use the condition "No Read - System" to represent the lack of a measurement, by adding this condition to this list it a gap will be rendered instead of a line with a 0 quantity measurement and a condition of "No Read - System".

When creating a measuring component type the following options are available:

Name	Details	Business Object
Interval Channel Type - Physical	Provides the configuration for a physical interval channel (including interval size). This is recommended for measuring components that measure consumptive usage in interval sizes up to 1 hour.	D1-IntervalChannelTypePhysical
Interval Channel Type - Scratchpad	Provides the configuration for a scratchpad interval measuring component.	D1-IntervalChannelTypeScratchp
Interval Channel Type - Physical Subtractive	Provides the configuration for a physical subtractive interval channel. In addition to standard interval configuration (including interval size) it also provides additional subtractive specific configuration (e.g. rollover validation, estimate reevaluation, etc). This is recommended for measuring components that measure subtractive usage in interval sizes up to 1 hour.	D1-IntrvlChanTypPhysSubtractiv
Register Type	Provides the configuration for a physical register that is manually read (e.g. rollover validation). These can be either consumptive or subtractive but are expected to be read infrequently (e.g. once a month).	D1-RegisterTypePhysical
Auto-Read Register Type	Provides the configuration for a physical register that is automatically read. In addition to the standard register configuration (e.g. rollover validation) it also provides details around the schedule of expected readings (e.g. first daily measurement time and expected hours between measurements). These can either be consumptive or subtractive but are expected to be read frequently (e.g. at least once per day). Note: these measuring component types can also be used to model interval data that is received with a large interval size (24 hours and larger).	D1-AutoReadRegisterType
Aggregator Type	Provides the configuration for an aggregation measurement.	D2-AggregatorType

NOTE: For “interval” data with an interval size greater than one hour, use the D1-AutoRegisterReadType measuring component type business object and the D1-RegisterAutoRead measuring component business object. This business object is well suited to daily and sub-daily readings. Using an interval data business object can result in measurement date problems during daylight saving time.

Refer to [Configuring an Out-of-the-box Aggregation](#) for more information about aggregation configuration

Measuring Component Type Value Identifiers

Measuring components are configured to measure specific types of quantities this is defined by the list of value identifiers on the measuring component type. Up to eleven value identifiers can be specified. The primary measured quantity should

be identified using the Value Identifier Type of Measurement. An additional ten derived values can be computed based on the primary measurement, these are identified with the Value Identifier Type of Value 01 through Value 10. Each value identifier is constructed of:

- **Unit of Measure:** The unit of measure for the quantity being recorded. Examples include kilo-watt hours (kWh), kilowatts (kW), therms, cubic feet (CCF), temperature (Fahrenheit or Celsius), etc. Refer to [Understanding Units of Measure](#) for more information.
- **Time of Use:** Modifiers for a given unit of measure that indicate a period of time during which a quantity has been used, such as On-Peak (meaning during a time when the greatest quantity of some consumable is being used), Off-Peak (meaning during a time when the least amount of some consumable is being used), etc. Refer to [Understanding Time of Use](#) for more information.
- **Service Quantity Identifiers:** Used to further distinguish between measured quantities that have identical UOM/TOU combinations, including situations in which the distinguishing identifier of a UOM is not accurately described as a TOU. Generally, SQI is only used when multiple measuring components measure the same thing, but in different ways. A meter that measures both generation KWH and consumption KWH could use SQIs to differentiate between the two. Refer to [Understanding Service Quantity Identifiers](#) for more information.
- **Value Derivation Algorithm:** Unlike UOM, TOU, and SQI this is not used in the identification of what is measured but rather is used to calculate a derived value based on the primary measurement. An algorithm from the list should be selected that contains the appropriate logic for calculating the derived value. This is applicable for those value identifiers with a Value Identifier Type of Value 01 through Value 10. More information on how derived values are calculated can be found in the Important Measuring Component Type System Events topic in this chapter. For more functional information about derived values please refer to [About Final Measurements](#).

The combination of UOM, TOU and SQI define what a measuring component measures. TOU and SQI are optional, but UOM must be defined for all value identifiers. For example, consider a meter (as illustrated in the image below) with two measuring components, both measuring the same unit of measure (kWh), but each measuring component measures consumption in different time of use (TOU) periods (peak and off-peak).

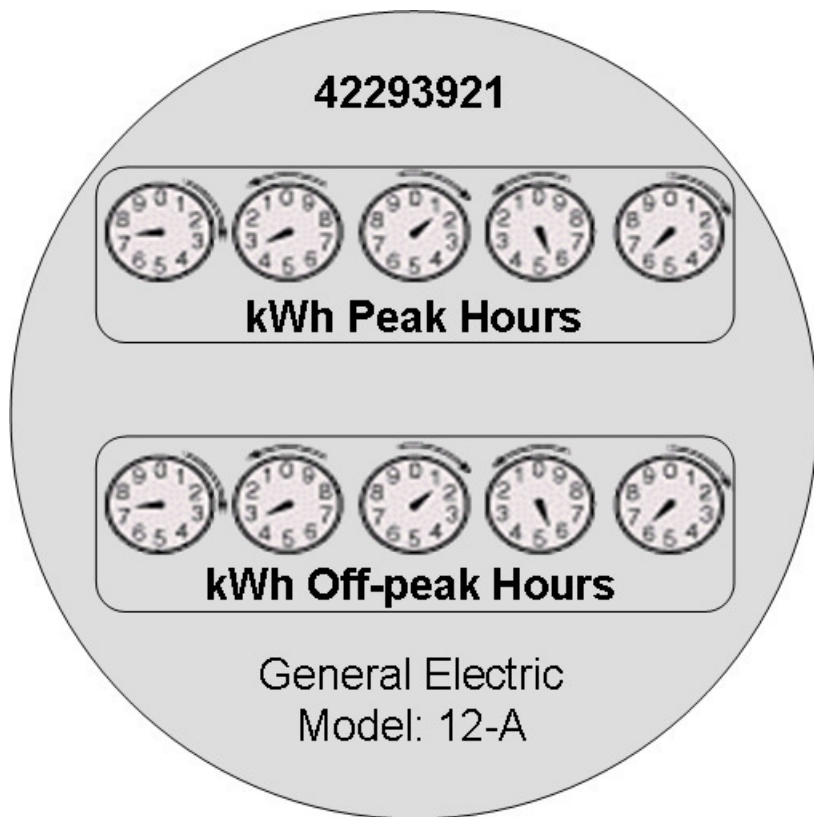

Another example might be a meter that records both generated KWH and consumed KWH. This meter would be configured to measure both UOM and SQL.

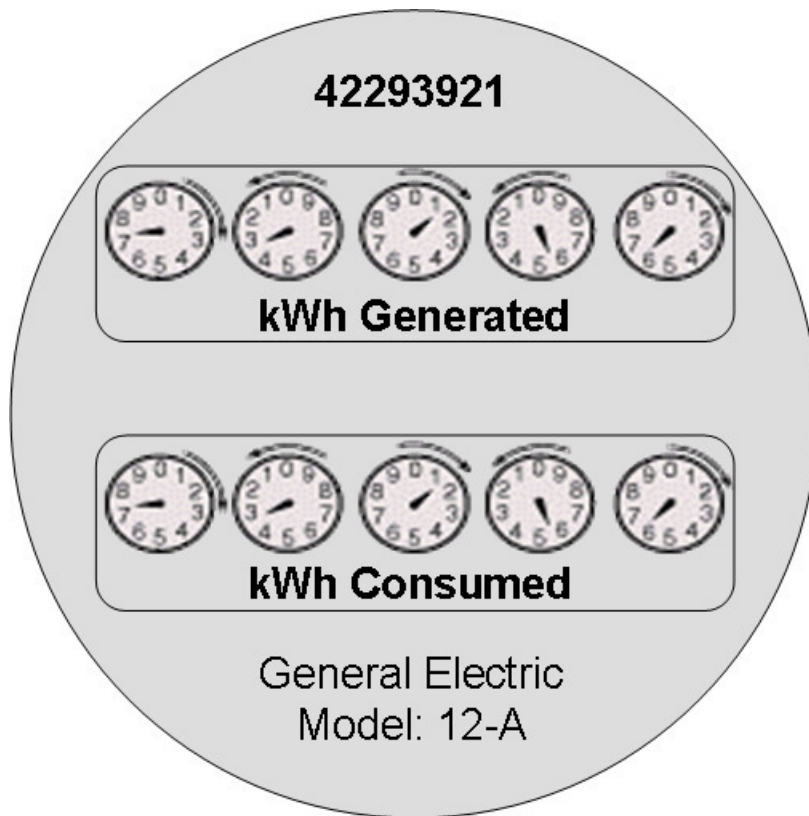

A measurement is recorded each time a measuring component is read. This means that for a meter with two measuring components that is read once a month, two measurements, one for each measuring component, would be recorded each month.

Important Measuring Component Type System Events

The measuring component type supports several business object algorithm system events that relate to calculating the consumption for measuring components of that type:

- **Calculate Interval Consumption:** receives the interval list and performs any necessary calculations on that interval data to compute consumption. Since interval data is already received as consumption data algorithms for this system event are typically limited to application of the appropriate multipliers. Refer to the algorithm type Calculate Interval Consumption (D1-IN-CNSUMP) as an example.
- **Calculate Scalar Consumption:** receives information about the scalar reading and calculates the consumption as appropriate. Algorithms for this event typically support calculating the consumption using a stop and start reading or backing into a reading using consumption and a start reading. Much like the interval counterpart it will apply the appropriate multipliers. Refer to algorithm type Calculate Scalar Consumption (D1-SC-CNSUMP) as an example.
- **Calculate Subtractive Interval Consumption:** receives the interval list and supporting information (e.g. the start reading for the first interval) and either calculates the consumption by subtracting the interval's reading from the prior interval's reading or calculates the reading by adding the current interval's consumption to the prior interval's reading. Refer to algorithm type Calculate Subtractive Interval Consumption (D1-SIN-CNSUM) as an example.
- **Condition Mapping:** receives the details of a single subtractive interval along with the details for its start reading and computes the applicable final condition and reading condition. This is leveraged solely for subtractive interval measuring component types. Refer to algorithm type Subtractive Interval - Condition Mapping (D1-SIN-CNMAP) as an example.

These system events are typically called from within initial measurement processing during the initial stages of the initial measurement lifecycle (e.g. the Pre VEE status of most initial measurement business objects).

In addition to the measuring component type business object algorithms there is an additional system event provided on measuring component type itself:

- **Value Derivation:** receives details of an initial measurement and an associated final measurement. Using these inputs it can compute a value derived either from the primary measurement or one of the other derived values. Refer to algorithm type Derive a quantity using a formula (D1-DERIVAQTY) as an example.

Important Measuring Component System Events

The measuring component business object that is associated to a given measuring component type supports a special system event that is used in the periodic estimation process:

- **Periodic Estimation:** this system event will scan the measuring component's final measurement history to identify missing measurements and create either a To Do, or an estimation initial measurement, or both. More detail about this system event can be found by visiting the following algorithm types: Refer to algorithm type Create Interval IMD and To Do Based Upon Install History (D1-CIITBIH) and Auto-Read Scalar Periodic Estimation (D1-ARSPE) as an example.

Measuring Component Business Object Options

The device business object that is associated to a given device type plays an important role in how a device is processed in a system beyond defining the data associated to that device. Below are a list of business object options that are defined on the device business object and their impact on system processing:

- **Estimation Initial Measurement Data BO:** Is used to identify the appropriate estimation IMD to create.
- **Manual Override IMD BO:** Is used to identify the appropriate manual override IMD to create.
- **System IMD BO:** Is used to identify the appropriate system IMD to create.
- **Measuring Component Consumption Function:** identifies a function that can be executed from any compatible measuring component 360 Degree zone. Each measuring component can support 0 to many of these functions.
- **Interval Initial Measurement Function:** identifies a function that can be executed from any compatible initial measurement zone. Each measuring component can support 0 to many of these functions.

More detail about these options can be found by visiting a measuring component business object and inspecting the business object options.

Configuring Measuring Component Types

This portal is used to display and maintain a Measuring Component.

Refer to [Understanding Measuring Component Types](#) for more information.

You can access the portal by selecting **Admin**, then **Device**, then **Measuring Component**.

The following zones may appear as part of the portal's **Main** tab page:

- **Measuring Component Type:** This zone provides information about the selected Measuring Component Type.

Measuring Component Comparison Types

Understanding Measuring Component Comparison Types

Measuring component comparison types define the details by which measuring component data can be compared to determine the days that most closely resemble a specific day being evaluated. For example, measuring component

comparison types can be used on measuring components that store weather data so that comparisons can be made based on temperature. These are used when performing “proxy day” estimations, allowing the application to search for days that are similar to historical data (for instance, the same date from the previous month or previous year) to use as the basis for estimation.

Measuring component comparison types use the following parameters:

- A specific metric to be calculated to enable data comparisons. The “Calculate Comparison Coefficient - Pearson Correlation Coefficient” algorithm, included with the base package can be used to calculate a coefficient based on the linear correlation between two data sets (specifically between weather data stored on a measuring component and on the comparison object).
- The specific object to be compared. This can be either the same measuring component (to compare against historical data for the same measuring component), or a factor profile (to compare against profile data).
- The date range for the comparison period, including the start of the comparison period (current date, same date last year, or both), the time each day through which the comparison will be calculated, and the number of days prior to and after the start date that will be compared with the comparison object.
- Average Difference Eligibility: An average value either above or below the average for the current date that will be eligible for comparison. For example, assume the current date’s average is 75, and the prior day’s average is 72. If the Average Difference Eligibility is set to 3 then the prior day value of 72 will be eligible for comparison to the current day average of 75.
- The maximum number of resulting calculations that should be stored as measuring component comparable periods.
- A template that defines which days are considered like each day of the week (for example, weekdays are like other weekdays, weekend days are like other weekend days). This template is defined as a record for the “Like Day Eligibility Template” extendable lookup.
- Work calendars used to determine if specific data should be compared to other weekend days or to the same date in prior years, and which dates, if any, should be excluded from historical data used for comparison.

Configuring Measuring Component Comparison Types

Refer to [Understanding Measuring Component Comparison Types](#) for more information.

You can access the portal by selecting **Admin**, then **Device**, then **Measuring Component Comparison Type**.

The following zones may appear as part of the portal's **Main** tab page:

- **Measuring Component Comparison Type List:** This zone lists all measuring component comparison type records. Broadcast a record to display the details of the selected record.
- **Measuring Component Comparison Type:** This zone displays details for the selected measuring component comparison type.

Device Configuration Types

Understanding Device Configuration Types

Device Configuration types define the measurements a given device can record. It should be noted that the device configuration type itself does not specify this information but rather the device configuration type will identify the valid list of measuring component types that can be referenced associated to a device.

When creating a new device configuration type there are the following options:

Name	Details	Business Object
------	---------	-----------------

Device Configuration Type	This represents configurations for physical meters and communication components. It identifies a list of valid measuring components types.	D1-DeviceConfigurationType
Item Configuration Type	This represents badged items that are installed at a particular service point. Given the nature of items there are no measuring component types associated to this type.	D1-ItemConfigurationType

Refer to [Configuring Consumption Synchronization](#) for more information on how a device configuration type can be set up to synchronize consumption between two related channels of measurement data.

Configuring Device Configuration Types

This portal is used to display and maintain a Device Configuration Type.

Refer to [Understanding Device Configuration Types](#) for more information.

You can access the portal by selecting **Admin**, then **Device**, then **Device Configuration Type**.

The following zones may appear as part of the portal's **Main** tab page:

- **Device Configuration Type List:** This zone lists all Device Configuration Type records. Broadcast a record to display the details of the selected record.
- **Device Configuration Type:** This zone provides information about the selected Device Configuration Type.

Device Types

Understanding Device Types

Device types define information about a class of devices, including properties that apply to all devices of a type. Properties defined for a device type can be overridden for an individual device

Specifically, device types provide information about:

- How a device can be configured by defining the valid list of device configuration types
- How a device communicates by defining a fallback head end system and a list of valid head end systems.
- How a device records measurement data through the fallback incoming data shift which plays an important role in daylight savings processing. Refer to [Daylight Savings Time Support](#) for more information.
- The consumption profile of an item: the unit of measure consumed and method of calculation (profile or straight line)
- Whether the device is attached to a service point or meter (used with items and device communication equipment)
- Characteristics common to all devices of this type (defined in the **Device Type Characteristics** zone).

When creating a new device type there are the following options:

Name	Details	Business Object
Smart Meter Device Type	These devices measure consumption for a given service point, support remote commands, and remote collection of measurement and event data. These devices are associated to a head end system.	D1-SmartMeterType
Manual Meter Device Type	These devices measure consumption for a given service point but require a visit to the service point to collect the measurement data. They are not associated to head end systems.	D1-ManualMeterType

Item Device Type	<p>These devices represent various items that consume consumption at a constant rate which are not directly metered. As consumption is calculated rather than measured so there is no need for an association to a head end system. Devices of this type can either be created individually for "badged" items or can be listed directly on a service point for "unbadged items."</p> <p>These devices may also be configured as equipment that can be attached to a service point.</p>	D1-ItemType
Communications Component Device Type	<p>These devices provide remote collection of consumption data measured by a manual meter on which they are installed. These devices are associated to a head end system.</p>	D1-CommunicationCompMeterType
Device Communication Equipment Type	<p>These devices provide remote collection of consumption data measured by a manual meter to which they are attached. Devices of this sort are sometimes referred to as Encoding Receiver/Transmitter (ERT) modules, or communication modules.</p> <p>These devices are associated to a head end system.</p>	D1-DvcCommEquipmentType

Device Business Object Options Drive Functionality

The device business object that is associated to a given device type plays an important role in how a device is processed in a system beyond defining the data associated to that device. Below is a list of business object options that are defined on the device business object and their impact on system processing:

- **Device Category:** This defines the type of device and correlates to the core device types that are supported (i.e. smart meter, AMR meter, manual meter, item, or communication component). This value is used by smart meter commands, service order management, and other system processes to make processing decisions.
- **Install Event BO:** This identifies the appropriate install event business object to use when this device is being installed at a service point. Refer to [About Install Events](#) for more information about install events.
- **Valid Command Request BO:** This identifies the commands that are valid for any device of this type. This option can be repeated for as many commands as the device supports. Note: the combination of the device and service provider (aka head end) define the true list of available commands by device.
- More detail about these options can be found by visiting a device business object and inspecting the business object options.

Device Type - Service Quantity

For "badged" and "unbadged" items consumption is not directly measured. Instead, for each item type, the average daily consumption amount is provided. The commodity represented by the daily consumption amount is defined by the item type's unit of measure.

The average daily consumption amount can be effective dated over time to support changes in the consumption profile. This is used in conjunction with the item's calculation method to derive the consumed amount per interval.

Refer to [Multiple Time Zone Support](#) for additional information on how device type service quantities are impacted by multiple time zones.

Valid Device Characteristic Types

The **Valid Device Characteristic Types** zone lists the valid characteristic types that may be instantiated on devices of this type. Characteristics of these types are maintained using the **Device Characteristics** zone in the **Device** portal.

Configuring Device Types

This portal is used to display and maintain a Device Type.

Refer to [Understanding Device Types](#) for more information.

You can access the portal by selecting **Admin**, then **Device**, then **Device Type**.

The following zones may appear as part of the portal's **Main** tab page:

- **Device Type List:** This zone lists all Device Type records. Broadcast a record to display the details of the selected record.
- **Device Type:** This zone provides information about the selected Device Type.
- **Device Type Service Quantity:** This zone displays the list of effective dated service quantities supported by the selected Device Type. This applies only to Items.
- **Device Type Characteristics:** This zone lists characteristics common to all devices of this type.
- **Valid Device Characteristic Types:** This zone lists the valid characteristic types that may be instantiated on devices of the device type. To add or edit valid characteristic types, click **Edit**.

Defining Device Installation Options

Service Point Types

Understanding Service Point Types

Service point types define a specific type of point at which service is delivered.

Specifically, service point types define how the application manages many aspects of the service point's behavior. A service point type may have one or more valid device types defined that limit the types of devices that can be installed at service points of this type.

Service point types are defined by the following:

- **Service Point Business Object:** the business object used by service points of this type
- **Service Point Category:** the types of devices that can be installed at service points of this type. Valid values include:
 - **Meter:** Indicates that a single meter can be installed at service points of this type.
 - **Item:** Indicates that a single "badged" item can be installed at service points of this type.
 - **Multi-Item:** Indicates that one or more "unbadged" items can be installed at service points of this type.
- **Divisions:** one or more divisions associated with service points of this type.
- **Valid Device Types:** the device types considered valid for service points of this type.
- **Valid Field Task Types:** the field task types considered valid for service points of this type. The field task types available when creating field activities can be based on the field task types listed here via the **Restrict Field Task Type by Service Point Type** option on the Service Order Management Master Configuration.
- **Usage Snapshot Configuration:** the configuration(s) to be used to take weekly or monthly usage snapshot(s)
- **Unreported Usage Snapshot Configuration:** the configuration(s) to be used to take weekly or monthly unreported usage snapshot(s)

Configuring Service Point Types

You use the Service Point Type portal to view and maintain service point types.

Refer to [Understanding Service Point Types](#) for more information.

You can access the portal by selecting **Admin, Device Installation, Service Point Type**.

NOTE: If the **Restrict Division** setting in the **Control by Division** section in the MDM Master Configuration is set to "Yes", this zone displays only unsecured service point types as well service point types with a Division (or Divisions) associated with the user on the **User Miscellaneous Information** zone on the **Miscellaneous** tab of the **User** portal.

The following zones may appear as part of the portal's **Main** tab page:

- **Service Point Type List:** This zone lists all service point type records. Broadcast a record to display the details of the selected record.
- **Service Point Type:** This zone provides information about the selected service point type.
- **Valid Field Task Types:** This zone lists the field task types considered valid for the selected service point type.
- **Valid Disconnect Location:** This zone lists disconnection locations considered valid for the selected service point type.

Service Point Quantity Types

Understanding Service Point Quantity Types

Service point quantity types define types of quantities that can be stored for a service point. These quantity types are often infrequently calculated descriptors of a given customer and how they relate, at an aggregate level, to either the customer base as a whole or their particular rate class. For example, a customer quantity may be used to store a scaling factor that describes how a given customer's usage compares to the profiled usage for their rate class.

In a settlement implementation, service point quantity types can be used to define values calculated monthly, annually, etc., such as annual peak load contribution (PLC).

Service quantity types use the following parameters:

- The service type (electric, gas, water, etc.) for service point quantities of this type
- Quantity identifiers related to the current service point quantity type (used to provide shorthand descriptions of the various types of values measured by service point quantities of this type)

Configuring Service Point Quantity Types

Refer to [Understanding Service Point Quantity Types](#) for more information.

You can access the portal by selecting **Admin**, then **Device Installation**, then **Service Point Quantity Type**.

The following zones may appear as part of the portal's **Main** tab page:

- **Service Point Quantity Type List:** This zone lists all service point quantity type records. Broadcast a record to display the details of the selected record.
- **Service Point Quantity Type:** This zone displays details for the selected service point quantity type.

Divisions

Understanding Divisions

Divisions are used to delineate between different operating companies within a large conglomerate of utilities.

Divisions can have one or more characteristics defined.

Divisions can be defined on several other objects and entities in the system, including:

- Service Point
- Service Order Activities (Request Orchestration activities)
- Service Order Field Activities
- Usage Subscription/Usage Subscription Type
- Usage Calculation Group
- Settlement Calculation Group
- Aggregation Group
- Data Source
- Market Product Type
- Market Product Set
- Measurement Data Snapshot Type
- Attribute Data Snapshot Type

Divisions can be associated with individual users on the **User Miscellaneous Information** zone on the [Miscellaneous](#) tab of the **User** portal.

Measurement Cycles

Understanding Measurement Cycles

Measurement cycles define the schedule for manual meter reading of devices at Service Points in that cycle. Measurement cycles can have one or more associated routes used to collect measurements.

Measurement cycles can also be configured to define when to [create usage transactions](#) for Usage Subscriptions associated to Service Points in the cycle.

For a deeper functional understanding, refer to the [About Route Management](#) section of the *Oracle Utilities Meter Solution Business User Guide*.

Configuring Measurement Cycles

This portal is used to display and maintain a Measurement Cycle.

Refer to [Understanding Measurement Cycles](#) for more information.

You can access the portal by selecting **Admin**, then **Device Installation**, then **Measurement Cycle**. You are brought to a query portal with options for searching. Once your record has been selected you are brought to the maintenance portal to view and maintain the selected record.

The following zones may appear as part of the portal's **Main** tab page:

- **Measurement Cycle List:** This zone lists all Measurement Cycle records. Broadcast a record to display the details of the selected record.
- **Measurement Cycle Type:** This zone provides information about the selected Measurement Cycle.
- **Measurement Cycle Route List:** This zone lists the measurement cycle routes related to the measurement cycle.
- **Measurement Cycle Schedule List:** This zone lists the measurement cycle schedules related to the current measurement cycle.

Measurement Cycle and Bill Determinants

The system can be configured to periodically push bill determinants to subscribing systems. In this case, measurement cycles can be configured to define when to create usage transactions for Usage Subscriptions associated to Service Points in the cycle. Even Service Points whose meters are read automatically may reference measurement cycles.

Creating bill determinants (by creating a usage transaction) is performed by an algorithm on the "Complete" state of the SP/Measurement Cycle Schedule Route business object (similar to creating activities as described above).

When the Pending SP/Measurement Cycle Schedule Route records are processed by the D1-PSPSR batch, rather than create a handheld download activity, the algorithm can create a usage transaction (usage transactions are transactions that cause bill determinants to be calculated for the Service Point's Usage Subscription).

If the implementation needs to both manually read the meter and push bill determinants, both algorithms would be plugged in on the SP/Measurement Cycle Schedule Route business object.

Measurement cycle processing is managed by the following three batch processes:

- **Create Pending Measurement Cycle Schedule Routes (D1-CMCS):** This batch process creates Schedule Routes for Measurement Cycle Schedules whose schedule selection date is on or before the batch business date. This process is used if routes have the same schedule each month, quarter, etc. This process simply copies the routes from the Measurement Cycle to the Measurement Cycle Schedule on/after the scheduled selection date.
- **Create Pending SP / Measurement Cycle Schedule Route Records (D1-CSPSR):** This batch process creates a "SP/Measurement Cycle Schedule Route" transaction for every Service Point in the Measurement Cycle Schedule Route that is ready for processing.
- **Process Pending SP / Measurement Cycle Schedule Route Records (D1-PSPSR):** This batch process transitions the Pending "SP/Measurement Cycle Schedule Route" transactions to their Complete state. Custom algorithms can be configured to do any additional necessary work, such as creating a "Meter Read Download" activity. This custom algorithm would be configured as an Enter algorithm on the "Complete" state of the SP/Measurement Cycle Schedule Route business object.

For a deeper functional understanding, refer to the [About Route Management](#) section of the *Oracle Utilities Meter Solution Business User Guide*.

Measurement Cycle Schedules

Understanding Measurement Cycle Schedules

Measurement cycle schedules define the dates on which devices are scheduled to be read for a given measurement cycle and the routes used to collect measurements for the measurement cycle.

For a deeper functional understanding, refer to the [About Route Management](#) section of the *Oracle Utilities Meter Solution Business User Guide*.

Configuring Measurement Cycle Schedules

This portal is used to display and maintain a Measurement Cycle Schedule.

Refer to [Understanding Measurement Cycle Schedules](#) and [Understanding Measurement Cycles](#) for more information.

You can access the portal by selecting **Admin**, then **Device Installation**, then **Measurement Cycle Schedule**. You are brought to a query portal with options for searching. Once your record has been selected you are brought to the maintenance portal to view and maintain the selected record.

The following zones may appear as part of the portal's **Main** tab page:

- **Measurement Cycle Schedule Query:** This zone allows you to query for Measurement Cycle Schedules based on Measurement Cycle and select the desired record.
- **Measurement Cycle Schedule:** This zone provides information about the selected Measurement Cycle Schedule.

Setting Up Metered Premise Options

This section describes tables that must be set up before you can define premises.

Setting Up Meter Read Instructions

When you set up a premise you may define instructions to be supplied to the individuals who read the meters located at the premise. To define meter read instruction codes, open **Admin > Geographic > Meter Read Instruction**.

Description of Page

Enter a unique **Meter Read InstructionCode** and **Description** for every meter read instruction.

Setting Up Meter Read Warnings

When you set up a premise you may define warnings to be supplied to the individuals who read the meters located at the premise. To define meter read warning codes, open **Admin > Geographic > Meter Read Warning**.

Description of Page

Enter a unique **Meter Read Warning** and a **Description** for every meter read warning.

Configuring Cross Installed Meter Processing

Cross installed meters is the term for situations in which meters are deployed at an incorrect customer service point. Consider the following example: Meter A is supposed to be installed at Service Point A and Meter B is supposed to be installed at Service Point B, but Meter B was mistakenly installed at Service Point A, and Meter A was mistakenly installed at Service Point B. This means that both customers will be billed incorrectly (customer at Service Point A will be billed for usage at Service Point B and vice versa) until the system can be updated to reflect the correct meter installations.

This process can also be used to issue financial adjustments and/or cancel/rebill any bill segments that are impacted by the change in meters, and create customer contacts related to the changes. See [Adjustments](#) and [Cancel / Rebill Incorrect Bill Segments](#) for more information about adjustments and rebilling.

The Cross Installed Meters process provides a tool to re-configure the meters through a correction process. When a user initiates the Cross Installed Meters process, the system will update device installation event details (like status, date and time of installation), device configurations, and measuring components with the correct information.

Cross installed meter processing requires the following administrative data:

- Customer Contact Class and Type (optional)
- Request Type
- Action Method

Each of these is described in detail below.

See [Correcting Cross Installed Meters](#) in the *Business User Guide* for more information about running cross installed meter processing.

Create a Customer Contact Class and Customer Contact Type - Optional

If you want customer contacts created as a result of cross-installed meter processing, you will need to reference a Contact Class and Contact Type. If you want to use a specific contact class and/or contact type, you will need to create these.

See [Setting Up Customer Contact Options](#) for more information about creating contact classes and contact types.

Create a Request Type

Each process flow instance has an associated request record, which is based on a specific request type. You must create a request type based on the "Cross Installed Meter Request Type" business object that will be used for cross installed meter processing.

Use the following procedure to create a request type used with cross installed meter processing

1. Select **Admin, General, Request Type, Add**.
2. Select "Cross Installed Meter Request Type" from the **Request Type Business Object** drop-down list on the **Select Business Object** screen and click **OK**.
3. Enter the following on the **Cross Installed Meter Request Type** screen:
 - **Main:**
 - **Request Type:** A code for your request type
 - **Description:** A description of your request type
 - **Crossed Installed Meter Parameters:**
 - **Swap Meters Service Script:** Cross Installed Meter - Swap Meters (this is the script that performs the change to Install Events)
 - **Insight Type:** Cross Installed Meters - Inline (default)
 - **Field Task Type:** D1-ServiceInvestigation (this defines the Field Task Type for field activities created by clicking the **Investigate** button on the **Swap Meters** panel)
 - **Create Customer Contact:** Indicates if customer contacts should be created as part of the cross installed meter process
 - **Contact Class:** The contact class used for customer contacts created from cross installed meter process flows. Applicable only if **Create Customer Contact** is set to "Yes".
 - **Contact Type:** The contact type used for customer contacts created from cross installed meter process flows. Applicable only if **Create Customer Contact** is set to "Yes".
 - **Bill Correction Parameters:**
 - **Allow Adjustment:** Indicates whether or not to allow adjustments when correcting bill segments

- **Adjustment Type:** Indicates the type of adjustment used when correcting bill segments
- **Allow Rebill:** Indicates whether or not to cancel/rebill when correcting bill segments
- **Allow Estimates:** Indicates whether or not to allow the use of estimated usage when using cancel/rebill to correct bill segments
- **Billing Option:** Indicates the billing option (Use Cut off Date or Use Schedule) used when using cancel/rebill to correct bill segments
- **Cancel Reason:** Cross Installed Meter (this is the Cancel reason used when using cancel/rebill to correct bill segments)

4. Click **Save**.

See [Setting Up Request Types](#) for more information about creating request types.

Create an Action Method

You must also configure an Action Method to associate the base package Cross-Installed Meter Process Flow Type (X1-CROSSEDMETER) with your custom Request Type.

Use the following procedure to create an action method used with cross installed meter processing

1. Select **Admin, System, Action Method, Add**.
2. Select "Cross Installed Meter Action Method" from the **Request Type Business Object** drop-down list on the **Select Business Object** screen and click **OK**.
3. Enter the following on the **Cross Installed Meter Action Method** screen:
 - **Main:**
 - **Action Method:** A code for your action method
 - **Action Method Role:** Cross Installed Meter
 - **Description:** A description of your request type
 - **Default Details:**
 - **Process Flow Type:** Cross Installed Meter (this is provided with the base package)
 - **Request Type:** Cross Installed Meter (the Request Type created above)
 - **To Do Type:** Cross Installed Meter (this is provided with the base package) This defines To Do Type for To Do Entries created by the Create Meter Process Completion Event.
 - **To Do Role:** A To Do Role for To Do Entries created by the Create Meter Process Completion Event.
4. Click **Save**,

See [Defining Action Methods](#) for more information about creating Action Method records.

Setting Up Consumption Estimation Parameters

The system estimates consumption under the following situations:

- At billing time, when "real" consumption cannot be computed due to the lack of a meter read, the system estimates how much the customer used assuming the following conditions are true:
 - The service agreement allows estimation.
 - The rate schedule allows estimation.

- The bill cycle schedule (if one is being used) allows estimation.
- The register is not a peak register (this is an artificial constraint, but most organizations do not estimate peak consumption). Note that the base product estimation algorithms may attempt to estimate peak registers.
- The register is subtractive. This is because only subtractive registers are self-correcting. For example, assume we estimate a reading of 100 and the next real read is 102, the customer will only be charged for 2 units. But consider what would happen if we estimated a consumptive register, the consumption associated with the next real read will be billed in its entirety.
- When a meter read is added, the system verifies that the resultant consumption is congruous with historical consumption trends (i.e., high / low checks are performed).

This section describes the tables that must be set up to estimate consumption.

Defining General Options

Units of Measure

Understanding Units of Measure

Units of Measure (UOM) identify quantities measured and recorded, such as KWH, KW, cubic feet, degrees Celsius, etc. UOMs are based on a specific service type.

Important Unit of Measure System Events

Unit of Measure supports the following business object algorithm system events:

- **Axis Conversion:** this event receives a list of measurements along with a source UOM and interval size and a target UOM and interval size. It should then perform the necessary actions to convert the source UOM and interval size into the target UOM and interval size. Refer to the algorithm Axis Conversion algorithm (D1-AXIS-CONV) as an example.

Configuring Units of Measure

This portal is used to display and maintain a Unit of Measure.

Refer to [Understanding Units of Measure](#) for more information.

You can access the portal by selecting **Admin**, then **General**, then **Unit Of Measure**.

The following zones may appear as part of the portal's **Main** tab page...

- **Unit of Measure List:** This zone lists all units of measure. Broadcast a record to display the details of the selected record.
- **Unit of Measure:** This zone provides information about the selected unit of measure.

Service Quantity Identifiers

Understanding Service Quantity Identifiers

Service Quantity Identifiers (SQI) are used to further distinguish between measured quantities that have identical UOM/TOU combinations, including situations in which the distinguishing identifier of a UOM is not accurately described as a TOU. Some examples include: Generated, Consumed, etc.

SQIs can also be used as a stand-alone representation of a service quantity that is not measured (one that is not properly described as a UOM) within a usage service quantity collection (such as a billing determinant).

Configuring Service Quantity Identifiers

This portal is used to display and maintain a Service Quantity Identifier.

Refer to [Understanding Service Quantity Identifiers](#) for more information.

You can access the portal by selecting **Admin**, then **General**, then **Service Quantity Identifier**.

The following zones may appear as part of the portal's **Main** tab page:

- **Service Quantity Identifier List:** This zone lists all Service Quantity Identifiers. Broadcast a record to display the details of the selected record.
- **Service Quantity Identifier:** This zone provides information about the selected Service Quantity Identifier.

Time of Use

Understanding Time of Use

Time of Use (TOU) periods are modifiers for a given unit of measure that indicate a period of time during which a quantity has been used, such as On-Peak (meaning during a time when the greatest quantity of some consumable is being used), Off-Peak (meaning during a time when the least amount of some consumable is being used), etc.

Configuring Time of Use

This portal is used to display and maintain a Time of Use.

Refer to [Understanding Time of Use](#) for more information.

You can access the portal by selecting **Admin**, then **General**, then **Time Of Use**.

The following zones may appear as part of the portal's **Main** tab page:

- **Time Of Use List:** This zone lists all Time Of Use records. Broadcast a record to display the details of the selected record.
- **Time Of Use:** This zone provides information about the selected Time Of Use.

Service Types

Understanding Service Types

Service Types define specific types of service for which usage can be recorded and captured, such as electric, gas, steam, etc.

Configuring Service Types

This portal is used to display and maintain a Service Type.

Refer to [Understanding Service Types](#) for more information.

You can access the portal by selecting **Admin**, then **General**, then **Service Type**.

The following zones may appear as part of the portal's **Main** tab page:

- **Service Type List:** This zone lists all Service Type records. Broadcast a record to display the details of the selected record.
- **Service Type:** This zone provides information about the selected Service Type.

Factors

Understanding Factors

Factor are a centrally stored set of values for use in validation rules, bill determinants calculations, and other processes.

A factor can have different values depending upon some definable attribute of a system object, such as customer size associated with a service point. Examples of factors can include minimum and maximum thresholds, loss factors, etc. Classes of factors are defined that can have numeric values (as in the above examples), or values pointing to profile measuring components, or VEE groups.

A factor's values are effective-dated values - either a number, a profile measuring component, a temperature profile measuring component, a VEE group, or some custom-defined value - assigned to a factor and associated to the value of some attribute of a system object. For example, consider a service point that can be classified as residential, commercial, or industrial. The tolerance percentage by which a customer's consumption can exceed last month's consumption can be based on the service point category.

For this example, factor values for a single factor called "tolerance percentage" could be:

- Residential - 20%
- Commercial - 10%
- Industrial - 5%.

Configuring Factors

This portal is used to display and maintain Factors and Factor Values.

Refer to [Understanding Factors](#) for more information.

Prerequisites: You must define factor characteristic source algorithms, factor characteristic types, and factor characteristic values before you can create a factor. Refer to the Oracle Utilities Application Framework online help for more information about algorithms, characteristic types, and characteristic values.

You can access the portal by selecting **Admin**, then **General**, then **Factor**.

The following zones may appear as part of the portal's **Main** tab page:

- **Factor List:** This zone lists all factor records. Broadcast a record to display the details of the selected record.
- **Factor:** This zone provides information about the selected factor.
- **Factor Char Value and Factor Value List:** This zone lists the characteristic values associated to the factor characteristic. For each characteristic value it will display the related factor values. From this zone you can click the **Factor Value** link to see the factor value in more detail on the **Factor Value** portal.

Processing Timetable Types

Understanding Processing Timetable Types

Processing timetable types define types of schedules that can be referenced by different processes and objects in Oracle Utilities applications such as Oracle Utilities Meter Data Management and Oracle Utilities Market Settlements Management. For example, if a process requires requesting data from an external system on a daily basis, a daily processing timetable type could be used to define the details of this schedule.

Processing timetable types are used by standalone data request measuring components to control the schedule by which requests for data are processed (for example, in a settlement process in which zonal load is requested on a daily basis). They are also used in the attribute data snapshot creation process.

The base package includes two processing timetable type business objects used with specific scheduling patterns:

- **Daily Processing Timetable:** Used for daily schedules
- **Defined Dates Processing Schedule:** Used for schedules that should execute on specific dates.

Parameters used to define processing timetable types include:

- **Execution Frequency Class:** Designates the type of processing timetable, Daily or Defined Dates (based on the business object)
- **Scheduling Information:** Details about how the schedule is executed, including:
 - **Period Cut-Off Time:** The time of day that represents the end of a period. In many instances this will be 12:00 AM. However, for something like a "Gas Day" this might be set to 09:00 AM.
 - **Earliest Execution Time:** Used to prevent records from being processed until after this time each day. This time relates to the processing time.
 - **Lag / Lead:** A flag that indicates whether periods in the past (Lag) or future (Lead) should be processed (applies to Daily schedules only)
 - **Lag Days / Lead Days:** The number of days in the past (Lag) or future (Lead) that should be processed (applies to Daily schedules only)
 - **Restrict Processing by Work Calendar:** Used to restrict processing to only the work days configured in the Work Calendar and will exclude any holidays added to the calendar (applies to Daily schedules only)
- **Workflow Information:** Details about how the processing timetable aligns with process workflows, including warning time and target due time
- **Processing Dates:** A list of specific dates on which the process should be executed (used with Defined Dates Processing Schedule only)

Configuring Processing Timetable Types

Refer to [Understanding Processing Timetable Types](#) for more information.

You can access the portal by selecting **Admin**, then **General**, then **Processing Timetable Type**.

The following zones may appear as part of the portal's **Main** tab page:

- **Processing Timetable Type List**: This zone lists all processing timetable type records. Broadcast a record to display the details of the selected record.
- **Processing Timetable Type**: This zone displays details for the selected processing timetable type.

Initial Measurement Data

Configuring the Initial Measurement Algorithms

The behavior of initial measurement data processing can be adjusted by updating parameters in several key algorithms in the lifecycle.

NOTE: This is not a list of all algorithms and algorithm parameters that can be customized in the initial measurement processing lifecycle. Rather, it is a selection of some of the more impactful parameters.

Initial Measurement Data Seeder Algorithms

- Derive Service Provider and Measuring Component (D1-DER-SPRMC):
 - Enabling a standalone measuring component search allows initial measurement data to be processed without a device identifier. This is useful when profile or temperature data is loaded through the IMD Seeder and a match must be made on measuring component identifiers alone.
 - If measuring component identifiers can be repeated across measuring components for the same device then the error for duplicate measuring components being found can be turned off. This is useful for certain head end systems that will have multiple channels with the same channel identifier. When a duplicate is found the search will fall back on other means for identifier the correct measuring component.
- Perform Date/Time Adjustments and Undercount/Overcount Check (D1-DODTTMADJ):
 - Undercount validation can be turned off completely or left enabled. When left enabled the automatic filling of gaps can be turned off separately.
 - The overcount check can be turned off.
 - The automatic adjustment of the individual interval date/times to an interval boundary can be turned on.

NOTE:

If your implementation receives initial measurement data with date/times that do not include an explicit time zone and the devices report date/times in standard time, you may need to add the following configuration:

- Navigate to **Admin > Integration > Message Option**
- In the **XAI compliance** option, ensure that the following text is provided:
`xsd:strict:dstGapInStandardTime`

This will prevent a date/time reported in standard time that falls on the missing hour of the day Daylight Savings Time is entered from being misinterpreted.

Specific Initial Measurement Data Algorithms

- Normalize measurements (overwrite identical existing Measurements) (D1-NORM-IMD):

- When the initial measurement data includes measurements that match exactly with the existing final measurements they can either be overwritten or skipped.
- If logging of changes to final measurements is desired then it must be indicated as such in this algorithm. It is suggested to keep this turned off for high volume initial measurement data such as initial load. See [Configuring Measurement Logging](#) for more details.

NOTE: Refer to [Configuring Consumption Synchronization](#) for additional parameters that can be adjusted on specific initial measurement data algorithms.

Configuring Measurement Logging

There are two components to logging changes to final measurements:

- **Initial Measurement Finalization:** the "normalization" algorithm on a particular initial measurement data business object will determine how final measurements are updated. For performance reasons certain types of initial measurement data (e.g. initial load) are delivered with a final measurement update method that will skip any logging. This can be controlled by parameters on the algorithm that implements the algorithm type Normalize Measurements for Initial Measurement Data (D1-NORM-IMD). Specifically the "Create Measurement Log on Update (Y/N)" parameter should be set to "Y". As mentioned creating these logs has a performance impact and it is not recommended for use on initial load.
- **Measurement Business Object:** there must be an algorithm for the audit system event configured. The base package delivers the algorithm type Add Measurement Log Record (D1-AMSRMTLOG). It is this algorithm that actually records the log entries.

Logging User Updates to Manual Initial Measurements

By default, manual edits made by users of these zones are not logged on the Log tab. Logging of manual edits to manual initial measurements can be enabled by adding a logging algorithm on an appropriate lifecycle state of the manual initial measurement business objects. The Log User Transaction (D1-LOGUSRTRN) base package algorithm can be used for this. This Enter algorithm is designed to be defined on the Initial state of the manual initial measurement business objects, but it can also be defined on any (non-transitory) Interim or Final state as well.

To ensure logging of any or all manual edits made to manual initial measurements, this algorithm should be specified on any state in which users will make manual edits. This will most often be the Pending or VEE Ready states, but could also include the Error, Exception, or Finalized states.

CAUTION: When defining this algorithm, the user should exercise caution and determine if previous algorithms in the sequence within the state contain any form of transitioning logic that may inadvertently cause this algorithm to be bypassed.

Removing Unwanted Initial Measurements

Over time, implementations can accumulate unnecessary non-final initial measurements which effectively become "stuck" in the system. Examples of these types of initial measurements include:

- Erroneously imported duplicate initial measurements
- Initial measurements that failed validation and were not corrected or replaced
- Initial measurements that triggered service issue monitors that remain unresolved

These initial measurements can also have related VEE Exceptions, To Do Entries, and Service Issue Monitors that remain "stuck" as well. This unnecessary data can impact overall system performance and should be reviewed and removed from time to time.

The Remove Unwanted Initial Measurements feature can be used to identify and close or delete these unwanted non-final initial measurements and any related VEE exceptions, To Do Entries and service issue monitors. This process is initiated by creating Request records which specify the parameters used to locate the non-final initial measurements to be removed. The request in turn initiates a batch process which identifies non-final measurements and related VEE Exceptions, To Do Entries, and/or Service Issue Monitors.

This functionality uses the following system objects:

Table listing objects used by this feature.

Object Type	Object Name	Description
Request Type Business Object	Remove IMDs Request Type (D1-RemoveIMDsType)	Used to define types of initial measurements removal requests. The Remove IMDs Request (D1-RemoveIMDsRequest) request business object (see below) is defined as the "Related Transaction BO" for this business object, meaning that requests created for request types based on this business object use the Remove IMDs Request (D1-RemoveIMDsRequest) request business object.
Batch Control	Remove Non-Final IMDs (D1-RENF)	Used to identify non-final measurements and related VEE exceptions, To Do Entries and/or Service Issue Monitors (Service Tasks).
Request Business Object	Remove IMDs Request (D1-RemoveIMDsRequest)	Used to create and process initial measurement removal requests.
Fact Business Object	Remove IMD Object Count (D1-RemoveIMDOjbecCount)	Used to capture details of the initial measurements and related objects to be removed.

Remove Unwanted Initial Measurements Request Types

Requests used to remove initial measurements are based on request types which specify the batch control used to identify and remove the initial measurements.

To create request types used with this feature:

1. Select Menu, **Admin, General, Request Type, Add**.
2. Select "Remove IMDs Request Type" from the **Request Type Business Object** drop-down list, and click **OK**.
3. Enter the following:
 - **Request Type:** A code for the request type
 - **Description:** A description of the request type
 - **Batch Control:** Search for and select the batch control to be used for requests of this type. The default is Remove Non-Final IMDs (D1-RENF), but implementations can create custom versions of this batch control.
4. Click **Save**.

Remove Unwanted Initial Measurements Requests

To create an initial measurement removal request:

1. Select **Menu, Tools, Request, Add**.
2. Select the appropriate request from the **Request Type** drop-down list and click **OK**.
3. Enter the **Submission Parameters** for the request. These include:
 - **Mode:** The mode in which the process will be run. Options include:

- **Preview:** Returns a count of non-final initial measurements and related objects (VEE Exceptions, To Do Entries, and Service Issue Monitors)
- **Close:** Transitions non-final initial measurements to the "Discarded" state and completes and/or closes related objects. Details regarding the data impacted by "Close" requests are captured and displayed in the **Object Log** zone.
- **Delete:** Deletes non-final initial measurements any related objects. Details regarding the data impacted by "Delete" requests are captured and displayed in the **Object Log** zone.
- **Thread Count:** The number of processing threads allocated to the process
- **IMD Business Object:** Used to restrict the initial measurements processed to those of a specific business object
- **IMD Status:** Used to restrict the initial measurements processed to those in a specific non-final state, including Pending, Held, Additional Mapping, Mapping Error, VEE Ready, Defer, Error, VEE Complete, Exception, or Force Complete
- **IMD Create Date/Time From:** Required. The start date and time of the time period in which initial measurements to be removed were created. For example, to remove initial measurements created between January 1, 2023 and January 31, 2023, the **IMD Create Date/Time From** would be "01-01-2023 12:00 AM".
- **IMD Create Date/Time To:** Required. The end date and time of the time period in which initial measurements to be removed were created. For example, to remove initial measurements created between January 1, 2023 and January 31, 2023, the **IMD Create Date/Time To** would be "01-31-2023 12:00 AM".
- **Device Configuration:** Used to restrict the initial measurements processed to those related to a specific device configuration.

4. Click **Save**. The request will then open in the **Request** portal.

5. Click **Submit Batch** to process the request.

Initially requests are created in the "Pending" status. When the request is run (by clicking **Submit Batch**), a batch process based on the batch control defined on the request type is executed.

- If the batch process errors, the request **Status** is set to the "Batch Error".
- If the batch process completes, the request **Status** is set to the "Completed".

Details of the process are captured in the **Submission Information** section, and the **Object Log** zone.

The **Submission Information** section includes:

- **Batch Submission:** Link to the batch job submission for the batch process. Click the link to navigate to the **Batch Job Submission** portal to view details of the batch process.
- **IMD SDE Extract Through Date/Time:** The date and time through which specialized data extracts have been performed for initial measurements impacted by the process.
- **End of Batch Date/Time:** The date and time when the batch process was completed.

The **Object Log** zone contains table with details regarding the initial measurements and related objects processed, including:

- **Object:** The type of object processed (Initial Measurement Data, Service Task, To Do Entry, or VEE Exception)
- **Specialized Data Extract Occurred:** An indicator as to whether or not ("Yes" or "No") occurred for initial measurement data
- **Count:** The number of objects processed.

Example:

Table listing sample results.

Object	Specialized Data Extract Occurred	Count
Initial Measurement Data	No	434
Initial Measurement Data	Yes	134
Service Task		1
To Do Entry		425
VEE Exception		413

Batch Control

The Remove Non-Final IMDs (D1-RENF) batch control identifies and closes or deletes unwanted initial measurements and their related objects. When run, this batch process creates a fact (using the Remove IMD Object Count (D1-RemoveIMDObjectCount) business object) that captures details regarding the batch process and the objects being removed during the process. These details are viewed in the **Object Log** zone in the **Request** portal.

Note that the Request ID is a required parameter for this batch control, meaning that this batch control cannot be run on its own. It can be only run from an initial measurement removal request.

Implementations can create specific versions of this batch control for use when removing specific types of data. For instance, an implementation could create a "Preview" version of this batch control, or a version used only with interval initial measurements.

Implementations can alter the processing of this batch control by creating alternate algorithms for each of the System Events used by this batch process. Refer to [Ad-hoc Processes](#) in the [Plug-in Driven Background Processes](#) section for more information.

Recommendations and Warnings

- We recommend using the **Preview** mode to identify potential initial measurements for removal before processing a request in either the **Close** or **Delete** mode. This allows you to review and verify the data to be removed before closing or deleting it.
- We recommend that access to this feature be limited to system administrators and other power users. Access to this feature can be restricted via the Remove IMDs Request BOAS (D1-RMIMDREQBOAS) application service.

WARNING: If used improperly, this feature can inadvertently remove valid operational data (such as initial measurements in "Pending" status awaiting VEE processing). There is no process for "undoing" the removal of initial measurements and related objects using this feature.

Defining Validation, Editing, and Estimation (VEE) Options

Exception Types

Understanding Exception Types

Exception Types define the groupings of exceptions for an IMD based on their functional similarity. This provides a way to define VEE Exceptions in a distinct enough way to understand the root issue that was generated from the VEE Rule.

For a deeper functional understanding of VEE, refer to the [About VEE](#) section of the *Oracle Utilities Meter Solution Business User Guide*.

Configuring Exception Types

This portal is used to display and maintain an Exception Type.

Refer to [Understanding Exception Types](#) for more information.

You can access the portal by selecting **Admin**, then **VEE**, then **Exception Type**.

The following zones may appear as part of the portal's **Main** tab page:

- **Exception Type List:** displays all of the Exception Types so you can choose the one you want to display in more detail
- **Exception Type:** shows the specific configuration for the selected Exception Type

There are two different options to use when creating an Exception Type:

Name	Details	Business Object
VEE Exception	This will create a "normal" VEE Exception that is attached to an IMD for tracking of conditions triggered in the VEE process.	D1-VEEException
VEE Exception - Monitor Service Point	In addition to tracking the failure in the VEE process, this VEE Exception generates a Service Issue Monitor . This allows for cumulative tracking of VEE Exceptions that can be configured to result in a Service Investigative Order (field work) for the Service Point.	D2-VEEExceptionServiceMonitor

VEE Groups

Understanding VEE Groups

VEE groups are collections of VEE Rules that are applied to initial measurement data. During the VEE process, the system executes the VEE Rules defined in each VEE group. The rules within a VEE group are defined in a specific sequence, allowing control over the order in which the rules are executed.

VEE groups can be associated to a specific measuring component, or to a measuring component type (or both). VEE groups associated with a measuring component type are applied to all measuring components of that type, while those associated to a specific measuring component are applied only to that measuring component. VEE groups associated to a measuring component override those assigned to a measuring component type.

VEE groups can also be referenced by the [Execute VEE Group](#) VEE Rule.

For a deeper functional understanding of VEE, refer to the [About VEE](#) section of the *Oracle Utilities Meter Solution Business User Guide*.

Configuring VEE Groups

This portal is used to display and maintain a VEE Group.

Refer to [Understanding VEE Groups](#) for more information.

You can access the portal by selecting **Admin**, then **VEE**, then **VEE Group**. You are brought to a query portal with options for searching. Once your record has been selected you are brought to the maintenance portal to view and maintain the selected record.

The following zones may appear as part of the portal's **Main** tab page:

- **VEE Group:** Defines basic information about VEE group
- **VEE Rules List:** lists the VEE Rules belonging to the group
- **Referencing VEE Rules List:** lists the VEE Rules that reference the group
- **Referencing VEE Group Factors List:** lists the VEE group factors that reference the group
- **Referencing Measuring Component Type List:** lists the measuring component types that reference the group
- **Referencing Measuring Component List:** lists the measuring components that reference the group

VEE Rules

Understanding VEE Rules

VEE Rules are standard and custom Validation and Estimation rules that perform checking and/or manipulation of initial measurement data. VEE Rules are created for a specific VEE group. For example, if you were configuring two VEE groups and both included a specific VEE Rule, you would need to create two instances of the VEE Rule, one for each group.

The specific validation and estimation processing performed on initial measurement data is defined in individual VEE Rules, each performing a specific set of targeted logic. The base product contains many VEE Rules you can use in your implementation, but you can also create your own custom VEE Rules.

Some VEE Rules generate VEE Exceptions if the initial measurement data fails the conditions specified for the rule. Other rules override measurements, changing measurement values as dictated by the rule's parameters. Some rules can both create exceptions and override the measurement as part of a single process. By convention, VEE Rules change the Post-VEE quantities of initial measurement data, but VEE Rules can change anything on an initial measurement.

Every VEE Rule has an effective period. Rules will only be applied if the initial measurement's start date is within the rule's effective period. For example, an Interval Spike Check rule with a Start Date of 11/15/2010 will only be applied if the start date of the initial measurement is on or after 11/15/2010.

This allows you to update the specifics of a rule without removing the previous version of the rule. For example, you might change the tolerance of an Interval Spike Check rule from 1.2 to 1.5 as of a certain date. However, for initial measurement data for the period prior to the change, you would want to use the tolerance for the original version of the rule (1.2) instead of the new tolerance (1.5).

On almost every VEE Rule, the failure of the rule results in a VEE Exception and the [Exception Type](#) for the failure can be configured on the rule. These Exception Types can also be set to a specific Exception Severity:

- **Information:** Used to highlight minor issues, but not sufficient to cause the initial measurement data to be put into the exception state. Exceptions of this category can be used to report on the frequency of interesting, but not fatal issues
- **Issues:** Used to report a problem that will prevent the initial measurement data from being finalized. Multiple "issue exceptions" can be created during VEE processing. If at least one issue exists after all rules have been applied, the initial measurement data is transitioned to the exception state
- **Terminate:** Used to report a severe issue that will cause the VEE process to stop and the initial measurement data to be transitioned immediately to the exception state. Only one terminate exception can be issued (as the first one causes VEE processing to stop on an initial measurement data).

For a deeper functional understanding of VEE, refer to the [About VEE](#) section of the *Oracle Utilities Meter Solution Business User Guide*.

Configuring VEE Rules

This portal is used to display and maintain a VEE Rule. Also, a list of the specific out-of-the-box rules is included below the instructions for using the portal.

Refer to [Understanding VEE Rules](#), [Understanding VEE Groups](#), and [Understanding Exception Types](#) for more information. For a deeper functional understanding of VEE, refer to the [About VEE](#) section of the *Oracle Utilities Meter Solution Business User Guide*.

You can access the portal by selecting **Admin**, then **VEE**, then **VEE Rule**. You are brought to a query portal with options for searching. Once your record has been selected you are brought to the maintenance portal to view and maintain the selected record.

The following zones may appear as part of the portal's **Main** tab page:

- **VEE Rule:** this zone displays all of the configuration items specific to this instance of a VEE Rule.
- **Eligibility Criteria List:** this zone displays any VEE Rule Eligibility Criteria that have been setup. These eligibility criteria determine conditionally whether the VEE Rule should be executed or not. Use the Add button to create a new eligibility criteria for the rule you're viewing.

Validation VEE Rules

Below is a list of the validation rules provided as part of base product. For more information on how each rule executes and can be configured, follow the link provided on the rule.

VEE Rule Name	Applicable Data Type(s)	Purpose
Consecutive Interval Check	Interval	This validation rule flags any combination of consecutive intervals within Initial Measurement Data based on the values of the data or the condition codes of the data.
Duplicate IMD Check	Interval or Scalar	This rule allows for a duplicate IMD to be flagged.
Dynamic Comparison Validation	Interval or Scalar	This powerful, flexible validation rule compares measurements to historical statistics for the related Service Point. The system will maintain statistics such as the following: sum, min, max, average, median, zero value count, outage count, and standard deviation. Then you define formulas (no programming required) for the comparison of current measurements to these statistics.
Ensure IMD Exists for Sibling MCs	Interval or Scalar	This rule validates that an IMD exists for all of the other measuring components associated to the same Device Configuration as the current measuring component, for the same period of time.
Final Measurement Replacement	Interval or Scalar	This validation rule allows you to define a variety of configuration options to decide if new data should replace existing measurements. The options include value change thresholds, percentage change thresholds, as well as condition code ranking.
High/Low Check	Interval or Scalar	This validation rule compares the total consumption of the current IMD to historical values. The comparison is normalized based on average daily usage (ADU). If the current IMD is too high or too low compared to historical data then an exception is thrown.

Inactive Measurement Check	Interval or Scalar	This validation rule flags any Initial Measurement Data received on a device that is either disconnected, uninstalled, and/or not connected to a Usage Subscription.
Interval Size Validation	Interval	This rule validates that the interval size (in seconds) supplied with the Initial Measurement is equal to the interval size defined on measuring component's type.
Interval Spike Check	Interval	This rule checks for spikes within an IMD and generates an exception if one is found.
Multiplier Check	Interval or Scalar	This rule validates that the register multiplier supplied with the IMD is equal to the multiplier stored on the measuring component. If not, an exception is created using the register multiplier exception type and severity configured on the rule.
Negative Consumption Check	Interval or Scalar	This rule flags any IMD where the total consumption is negative.
Prolonged Estimation Check	Interval or Scalar	This validation rule creates an alert when a device has been estimated for an extended period of time.
Raise Missing Quantity Exception	Interval	This rule flags any missing interval data.
Sum Check	Interval or Scalar	This rule is used to compare the difference between interval data to scalar data for a period of time, or between a set of TOU scalar reads to a "Sum" scalar reading.
Unit of Measure Check	Interval or Scalar	This rule checks the unit of measure (UOM) passed in with the Initial Measurement against the primary unit of measure configured on the measuring component's type.
Zero Consumption Check	Interval or Scalar	This rule checks if the total consumption for the IMD is zero. There is also a check for whether an outage occurred during the same time as the zero consumption to provide ways to avoid exceptions in that case.

Estimation VEE Rules

Below is a list of the estimation rules provided as part of base product. For more information on how each rule executes and can be configured, follow the link provided on the rule.

VEE Rule Name	Applicable Data Type(s)	Purpose
Interval Adjustment From Scalar	Interval	This rule performs adjustments to interval values based on the values from the associated scalar data on the same device.
Interval Averaging Estimation	Interval	This rule finds historical interval data from the same measuring component based on a variety of configuration options to use for estimating any missing data within an IMD.

Interval Create Estimation IMD for Gap	Interval	This estimation rule creates a new Estimation IMD to fill gaps between the interval data received from the Head End. <i>Note: this estimation rule acts differently from the other rules as it creates a new IMD rather than filling in missing values in an estimation IMD created from periodic estimations.</i>
Interval Interpolation Estimation	Interval	This rule attempts to interpolate gaps within an IMD using prior and subsequent intervals as starting points for linear interpolation.
Interval Profile Estimation	Interval	This rule estimates any missing interval data for the IMD based on a referenced Profile Factor.
Interval Proxy Day Estimation	Interval	This rule checks for days with similar temperature and uses the measurement data from those days as the basis of interval estimation for the in-flight initial measurement.
Scalar Calculation From Interval	Scalar	This rule performs adjustments to scalar values based on the values from the associated interval data on the same device.
Scalar Estimation	Scalar	This rule finds historical scalar data from the same measuring component based on a variety of configuration options to use for estimating any missing data within an IMD.
Scalar Profile Estimation	Scalar	This rule estimates any missing scalar data for the IMD based on a referenced Profile Factor.
Scalar Proration	Scalar	This rule prorates the value of a scalar reading that has two valid scalar readings on either side as boundaries. It will also take into account any related interval data within the same period to exclude from the calculation.
Subtractive Interval Adjustment Rule	Subtractive Interval Adjustment Rule	This rule performs adjustments to qualifying interval consumption values for subtractive interval measuring components based on an adjustment target calculated using a start and stop reading for the period that encapsulates the intervals to adjust.

Decision-Making VEE Rules

There are VEE Rules delivered as part of the base product that help with decision-making when executing VEE (listed below). For more information on how each rule executes and can be configured, follow the link provided on the rule.

VEE Rule Name	Purpose
Exception Handler	This rule allows for termination of the VEE process based on a configurable set of exceptions being present for the IMD. This rule also allows a unique To Do Type to be generated based on a group of exceptions.

Execute VEE Group

This rule performs a call to execute a separate VEE Group which includes execution of all VEE Rules within that group.

Successful Termination

This rule allows VEE to be successfully terminated based on a list of exceptions.

VEE Group Matrix (Factor)

This rule provides a way to choose different instances of a VEE Rule using a Factor. This factor leverages characteristics that are defined on Service Point, Device, or Measuring Component.

Validation VEE Rules

Consecutive Interval Check

Overview

This rule flags any combination of consecutive intervals within Initial Measurement Data based on the values of the data or the condition codes of the data. It can be used to find faulty meters that are reporting consecutive outage codes, zero measurements, or negative values. It can also be used by water utilities to identify leaks based on the interval never reaching zero.

NOTE:

Additional detail on the logic of this rule can be found in the Detailed Description of the D2-CONSINTRV Algorithm Type.

For help with the meaning of specific configuration fields, refer to the embedded help on the screen when adding or editing the rule.

Business Object

D2-ConsecutiveIntervalCheck

Example Scenarios

Below are some example scenarios that can be achieved based on configuration of this rule.

Scenario 1: Rule configured to fail for zero values

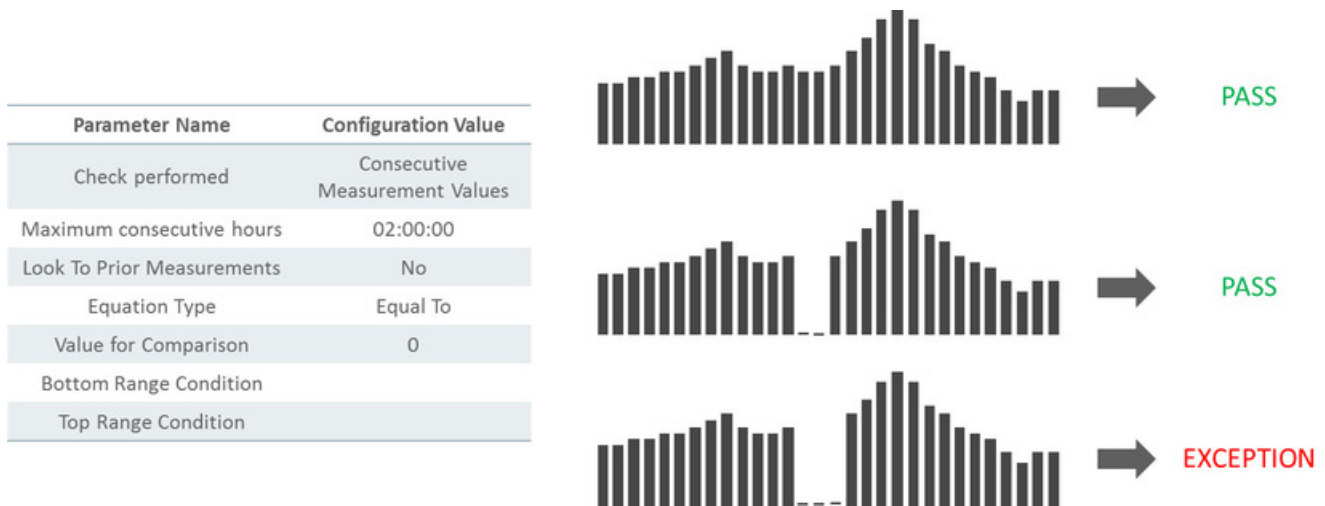

Scenario 2: Rule configured to fail for negative values

Parameter Name	Configuration Value
Check performed	Consecutive Measurement Values
Maximum consecutive hours	02:00:00
Look To Prior Measurements	No
Equation Type	Less Than
Value for Comparison	0
Bottom Range Condition	
Top Range Condition	

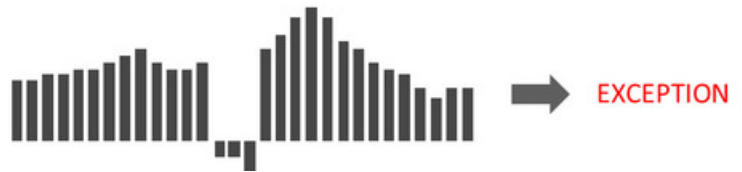
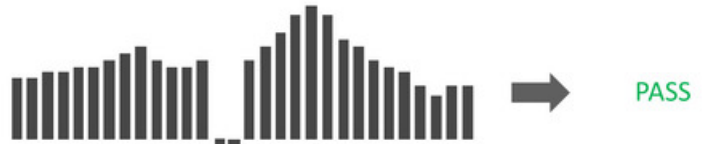
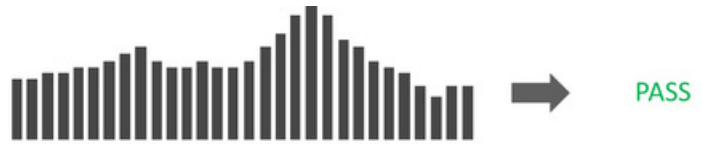

Scenario 3: Rule configured to fail for missing condition codes

Parameter Name	Configuration Value
Check performed	Consecutive Condition Values
Maximum consecutive hours	02:00:00
Look To Prior Measurements	No
Equation Type	
Value for Comparison	
Bottom Range Condition	Missing
Top Range Condition	Missing

KEY
 = Regular data
 = Missing data

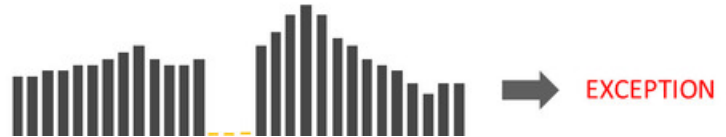
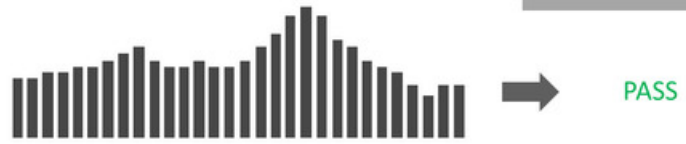

Scenario 4: Rule configured to fail for outage condition codes only if its zero

KEY
 ■ = Regular data
 ■ = Outage data

Parameter Name	Configuration Value
Check performed	Both
Maximum consecutive hours	02:00:00
Look To Prior Measurements	No
Equation Type	Equal To
Value for Comparison	0
Bottom Range Condition	Outage
Top Range Condition	Outage

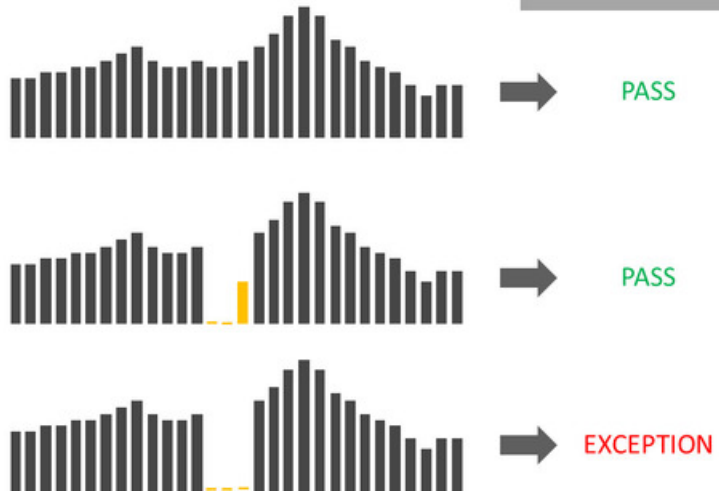

Scenario 5: Rule configured to fail if a long period of consecutive water values are greater than 0.1

Parameter Name	Configuration Value
Check performed	Consecutive Measurement Values
Maximum consecutive hours	20:00:00
Look To Prior Measurements When First Interval Matches Criteria	No
Equation Type	Greater Than
Value for Comparison	0.1
Bottom Range Condition	
Top Range Condition	

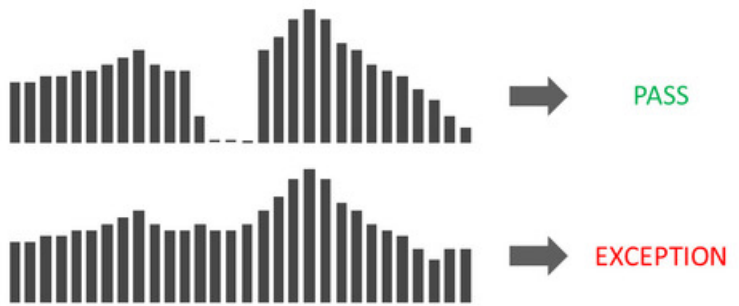

Scenario 6: Look back at prior measurements when the first interval matches criteria

Parameter Name	Configuration Value
Check performed	Consecutive Measurement Values
Maximum consecutive hours	02:00:00
Look To Prior Measurements	Yes
Equation Type	Equal To
Value for Comparison	0
Bottom Range Condition	
Top Range Condition	

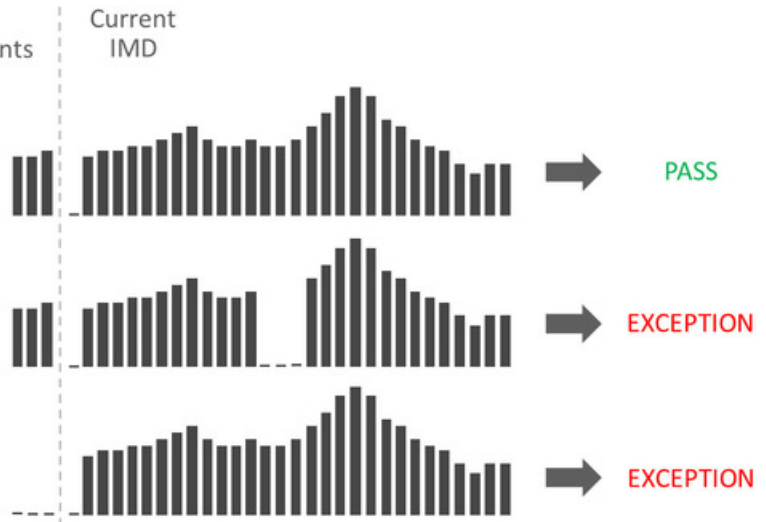

Duplicate IMD Check

If the current Initial Measurement Data (IMD) being validated is determined to be a duplicate of an existing IMD for the same measuring component, this rule will produce a VEE exception of the type and severity configured on the VEE Rule. The algorithm logic looks for duplicate IMDs using the following criteria:

- associated to the same measuring component as the current IMD
- utilizes the same IMD business object as the current IMD (for example, Initial Load Scalar)
- references the same To Date/Time (ends on the same date) as the current IMD
- exists in a "Finalized" state
- the contents of pre-VEE are identical to the pre-VEE of the current IMD

If any IMDs are found that meet all of the above criteria, the current IMD is deemed to be a duplicate.

NOTE:

Additional detail on the logic of this rule can be found in the Detailed Description of the D1-DUPIMDCHK Algorithm Type.

For help with the meaning of specific configuration fields, refer to the embedded help on the screen when adding or editing the rule.

Business Object

D1-DuplicateIMDCheck

Dynamic Comparison Validation

This validation rule compares measurements to historical statistics for the related Service Point. The system will maintain statistics such as the following: sum, min, max, average, median, zero value count, outage count, and standard deviation. Setting up these [Measuring Component Statistics](#) is a prerequisite to using the rule.

Users can define formulas (no programming required) for the comparison of current measurements to these statistics. This is powerful rule will allow utilities to look for unusual usage patterns. For example:

- Lowest/highest usage ever
- Current usage is more than three standard deviations from the mean
- Detect unexpected zero usage
- Detect negative usage while ruling out known cases
- Abnormal usage
- Voltage threshold monitoring
-

NOTE:

Additional detail on the logic of this rule can be found in the Detailed Description of the D2-DYNCOMCHK Algorithm Type.

For help with the meaning of specific configuration fields, refer to the embedded help on the screen when adding or editing the rule.

Business Object

D2-DynCompValidation

Example Scenarios

Below are some example scenarios that can be achieved based on configuration of this rule.

Example 1: Detect new "high water mark"

Historical Statistics		
Statistics MC Type: MC_STATS_13MONTHS		
Max	15 min	4.320

Dynamic Values	
Variable Name: IMD1	Variable Name: CS1
• Source Type: IMD	• Source Type: Channel Statistics
• Set Function: Max	• MC Type: MC_STATS_13MONTH
	• Value: Max

Equation

$$IMD1 > CS1 * 1.1$$

This equation is comparing the max interval in the new IMD to the max interval from the last 13 months of history from the MC. If greater than 110% of max then fail.

Example 2: High Usage

Historical Statistics		
Statistics MC Type: MC_STATS_LASTMONTH		
Average	15 min	1.630
Standard Deviation	15 min	0.519
Statistics MC Type: MC_STATS_LASTYEAR		
Average	15 min	1.893
Standard Deviation	15 min	0.851

Dynamic Values	
Variable Name: IMD1	Variable Name: CS3
• Source Type: IMD	• Source Type: Channel Statistics
• Set Function: Max	• MC Type: MC_STATS_LASTYEAR
	• Value: Average
Variable Name: CS1	Variable Name: CS4
• Source Type: Channel Statistics	• Source Type: Channel Statistics
• MC Type: MC_STATS_LASTMONTH	• MC Type: MC_STATS_LASTYEAR
• Value: Average	• Value: Standard Deviation
Variable Name: CS2	
• Source Type: Channel Statistics	
• MC Type: MC_STATS_LASTMONTH	
• Value: Standard Deviation	

Equation

$$(IMD1 - CS1) / CS2 > 3$$

$$AND (IMD1 - CS3) / CS4 > 3$$

This equation checks that the standard score of the current max interval is within 3 standard deviations of historical data from last month and last year. If greater than 3 standard deviations, an exception is thrown.

Example 3: Detect unexpected zero usage (method 1)

Historical Statistics		
Statistics MC Type: MC_STATS_LASTMONTH		
Total Count	15 min	2880
Zero Count	15 min	3
Statistics MC Type: MC_STATS_LASTYEAR		
Total Count	15 min	2880
Zero Count	15 min	0

Dynamic Values	
Variable Name: IMD1	Variable Name: CS_T2
• Source Type: IMD	• Source Type: Channel Statistics
• Calc Function: Sum	• MC Type: MC_STATS_LASTYEAR
	• Value: Total Count
Variable Name: CS_T1	Variable Name: CS_Z2
• Source Type: Channel Statistics	• Source Type: Channel Statistics
• MC Type: MC_STATS_LASTMONTH	• MC Type: MC_STATS_LASTYEAR
• Value: Total Count	• Value: Zero Count
Variable Name: CS_Z1	
• Source Type: Channel Statistics	
• MC Type: MC_STATS_LASTMONTH	
• Value: Zero Count	

Equation

$$IMD1 = 0$$

$$AND CS_Z1 / CS_T1 < 0.01$$

$$AND CS_Z2 / CS_T2 < 0.01$$

This equation finds zero intervals in the current IMD that seem to not fit with historical trends for the customer based on prior counts of zero intervals.

Example 4: Detect unexpected zero usage (method 2)

Historical Statistics		
Statistics MC Type: MC_STATS_LASTMONTH		
Min	15 min	0.43
Statistics MC Type: MC_STATS_LASTYEAR		
Min	15 min	0.52

Dynamic Values	
Variable Name: IMD1	Variable Name: CS1
• Source Type: IMD	• Source Type: Channel Statistics
• Calc Function: Min	• MC Type: MC_STATS_LASTMONTH
	• Value: Min
Variable Name: CS2	
• Source Type: Channel Statistics	
• MC Type: MC_STATS_LASTYEAR	
• Value: Min	

Equation

$$IMD1 = 0$$

$$AND CS1 > 0$$

$$AND CS2 > 0$$

This equation finds zero intervals in the current IMD that seem to not fit because the minimum values for the meter historically have never reached zero during comparable periods.

Example 5: Detect negative usage while ruling out known cases

Historical Statistics

Statistics MC Type: MC_STATS_13MONTHS		
Negative Count	15 min	0

Dynamic Values

Variable Name: V1	• Source Type: IMD	• Calc Function: Min
Variable Name: V2	• Source Type: Channel Statistics	• MC Type: MC_STATS_13MONTHS
	• Value: Negative Count	

Equation

$V1 < 0 \text{ AND } V2 = 0$

This equation detects negative usage on the current IMD while the prior 13 months shows no cases of negative usage.

Example 6: Abnormal usage

Historical Statistics

Statistics MC Type: MC_STATS_LASTMONTH		
Average	15 min	1.630
Standard Deviation	15 min	0.519

Statistics MC Type: MC_STATS_LASTYEAR		
Average	15 min	1.893
Standard Deviation	15 min	0.851

Dynamic Values

Variable Name: IMD_STD	• Source Type: IMD	• Calc Function: Standard Deviation
Variable Name: IMD_AVG	• Source Type: IMD	• Calc Function: Average
Variable Name: LM_AVG	• Source Type: Channel Statistics	• MC Type: MC_STATS_LASTMONTH
	• Value: Average	
Variable Name: LM_STD	• Source Type: Channel Statistics	• MC Type: MC_STATS_LASTMONTH
	• Value: Standard Deviation	
Variable Name: LY_AVG	• Source Type: Channel Statistics	• MC Type: MC_STATS_LASTYEAR
	• Value: Average	
Variable Name: LY_STD	• Source Type: Channel Statistics	• MC Type: MC_STATS_LASTYEAR
	• Value: Standard Deviation	

Equation

$IMD_AVG \Leftrightarrow 0$
 $AND\ ABS(IMD_AVG - LM_AVG) < 0.5$
 $AND\ ABS(IMD_AVG - LY_AVG) < 0.5$
 $AND\ ABS(IMD_STD - LM_STD) > 1.5$
 $AND\ ABS(IMD_STD - LY_STD) > 1.5$

This equation determines that the average of the current IMD is close to the historical average but that the standard deviation is far off. This points to abnormal usage.

Example 7: Voltage threshold monitoring

Historical Statistics

None

Dynamic Values

Variable Name: VOLT_MAX	• Source Type: IMD	• Calc Function: Max
Variable Name: VOLT_MIN	• Source Type: IMD	• Calc Function: Min

Equation

$VOLT_MIN < 117$
 OR
 $VOLT_MAX > 127$

This equation determines if the voltage data in the current IMD has fallen below or exceeded the bounds that a utility needs to keep customer voltage within. This is usually set to values that catch incorrect voltage before the value drops below the regulatory requirement.

Ensure IMD Exists for Sibling MCs

This rule validates that an IMD exist for all of the other measuring components associated to the same Device Configuration as the current measuring component, for the same period of time.

A check is also performed that all of the Initial Measurements have the same External Source ID (indicating that they all came from the same usage file).

NOTE:

Additional detail on the logic of this rule can be found in the Detailed Description of the D2-ENSIMDMC Algorithm Type.

For help with the meaning of specific configuration fields, refer to the embedded help on the screen when adding or editing the rule.

Business Object

D2-EnsureIMDExistsForSibling

Final Measurement Replacement

This validation rule allows you to define a variety of configuration options to decide if new scalar or interval data should replace existing measurements. The options include value change thresholds, percentage change thresholds, as well as condition code ranking. One common use for this rule is rejecting trivial measurement changes to prevent very small changes for a bill from being sent to a customer.

NOTE:

Additional detail on the logic of this rule can be found in the Detailed Description of the D2-VLMSRCOND Algorithm Type.

For help with the meaning of specific configuration fields, refer to the embedded help on the screen when adding or editing the rule.

Business Object

D2-FinalMeasurementValidation

Example Scenarios

Below are some example scenarios that can be achieved based on configuration of this rule.

Example 1: Replacement of measurements based solely on value difference

KEY	
■	= Regular
■	= System Estimated
■	= No Read – System
■	= No Read – Outage
■	= Super

Parameter Name	Configuration Value
Replacement Method	Reject Based on Configuration
Replacement Condition Value	No Read – System
Replace Manually Edited Data?	
Use Early and Late MC Type Settings?	
Replacement Evaluation Type	Compare Value Change
Value Change Tolerance	0.1
Percentage Change Tolerance	
Condition Code Prioritization by Groups	

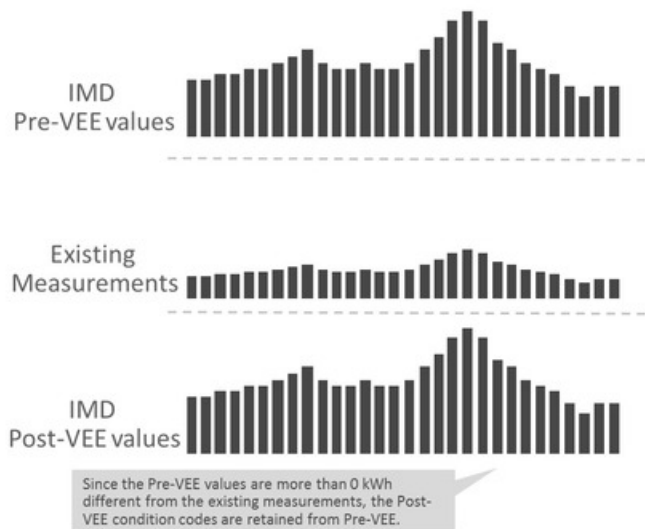

Example 2: Percentage change to replace measurement

KEY	
■	= Regular
■	= System Estimated
■	= No Read – System
■	= No Read – Outage
■	= Super

Parameter Name	Configuration Value
Replacement Method	Reject Based on Configuration
Replacement Condition Value	No Read – System
Replace Manually Edited Data?	
Use Early and Late MC Type Settings?	
Replacement Evaluation Type	Compare Percentage Change
Value Change Tolerance	
Percentage Change Tolerance	50
Condition Code Prioritization by Groups	

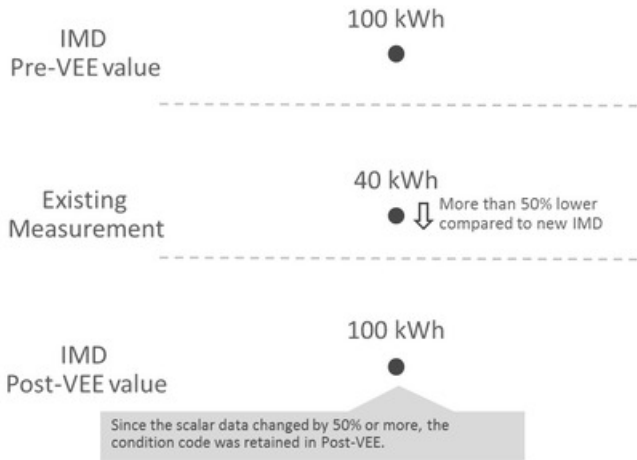

Example 3: Partial replacement of estimated data with regular data based on condition range prioritization

KEY	
■	= Regular
■	= System Estimated
■	= No Read – System
■	= No Read – Outage
■	= Super

Parameter Name	Configuration Value
Replacement Method	Reject Based on Configuration
Replacement Condition Value	No Read – System
Replace Manually Edited Data?	
Use Early and Late MC Type Settings?	
Replacement Evaluation Type	Compare Value Change
Value Change Tolerance	0.1
Percentage Change Tolerance	
Condition Code Prioritization by Groups	10: Super 20: Regular, No Read – Outage 30: System Estimate 40: No Read – System



Example 4: Partial replacement of regular data with outage data based on condition range prioritization

KEY	
■	= Regular
■	= System Estimated
■	= No Read – System
■	= No Read – Outage
■	= Super

Parameter Name	Configuration Value
Replacement Method	Reject Based on Configuration
Replacement Condition Value	No Read – System
Replace Manually Edited Data?	
Use Early and Late MC Type Settings?	
Replacement Evaluation Type	Compare Value Change
Value Change Tolerance	0.1
Percentage Change Tolerance	
Condition Code Prioritization by Groups	10: Super 20: Regular, No Read – Outage 30: System Estimate 40: No Read – System

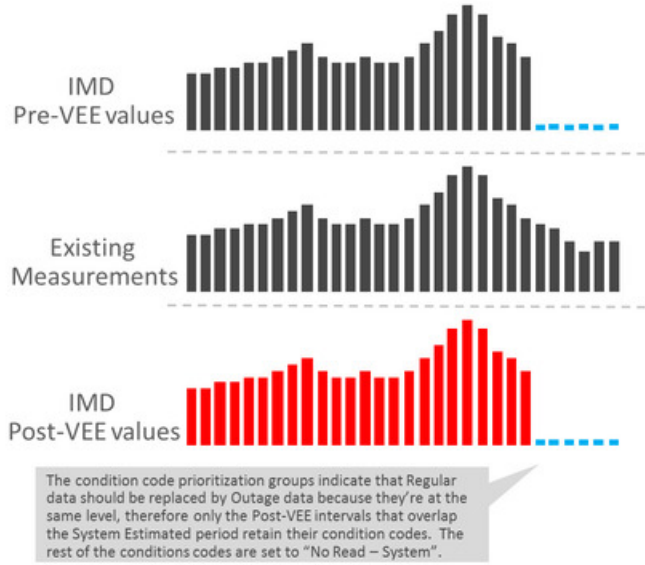

Example 5: Super not replaced by regular (retain a smoothed spike)

KEY	
■	= Regular
■	= System Estimated
■	= No Read – System
■	= No Read – Outage
■	= Super

Parameter Name	Configuration Value
Replacement Method	Reject Based on Configuration
Replacement Condition Value	No Read – System
Replace Manually Edited Data?	
Use Early and Late MC Type Settings?	
Replacement Evaluation Type	
Value Change Tolerance	
Percentage Change Tolerance	
Condition Code Prioritization by Groups	10: Super 20: Regular, No Read – Outage 30: System Estimate 40: No Read – System

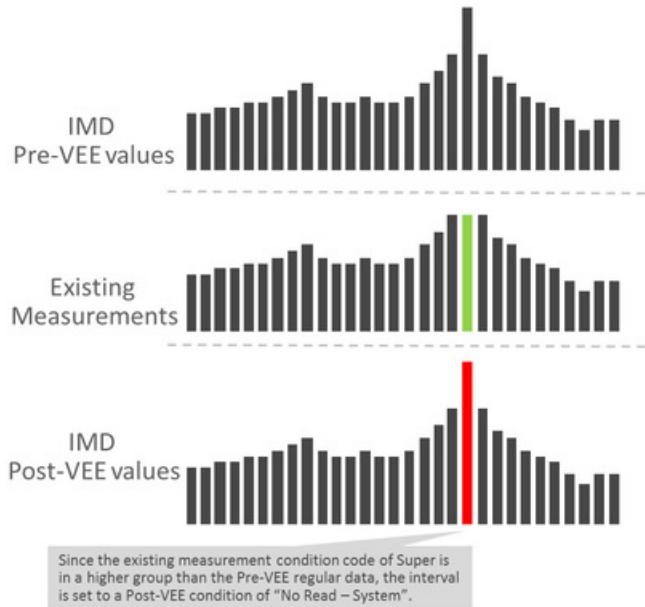

Example 6: Prevent replacement of manually edited data

KEY

- = Regular
- = System Estimated
- = No Read – System
- = No Read – Outage
- = Super
- = User Edited data

Parameter Name	Configuration Value
Replacement Method	Reject Based on Configuration
Replacement Condition Value	No Read – System
Replace Manually Edited Data?	No
Use Early and Late MC Type Settings?	
Replacement Evaluation Type	
Value Change Tolerance	
Percentage Change Tolerance	
Condition Code Prioritization by Groups	

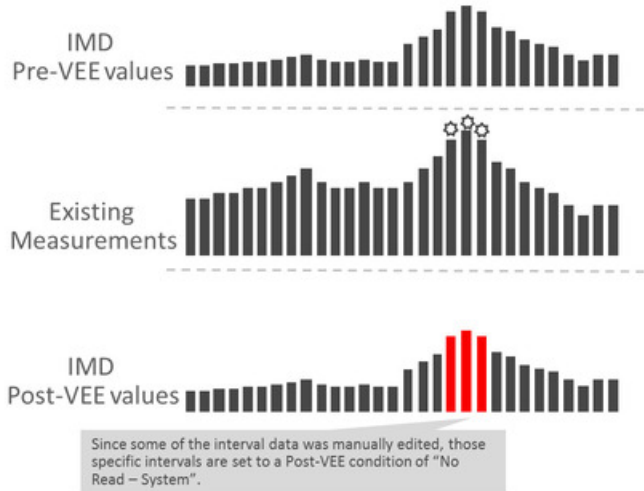

Example 7: Allow replacement of manually edited data if the condition group is lower than new data

KEY

- = Regular
- = System Estimated
- = No Read – System
- = No Read – Outage
- = Super
- = User Edited data

Parameter Name	Configuration Value
Replacement Method	Reject Based on Configuration
Replacement Condition Value	No Read – System
Replace Manually Edited Data?	No
Use Early and Late MC Type Settings?	
Replacement Evaluation Type	
Value Change Tolerance	
Percentage Change Tolerance	
Condition Code Prioritization by Groups	10: Super 20: Regular, No Read – Outage 30: System Estimate 40: No Read – System

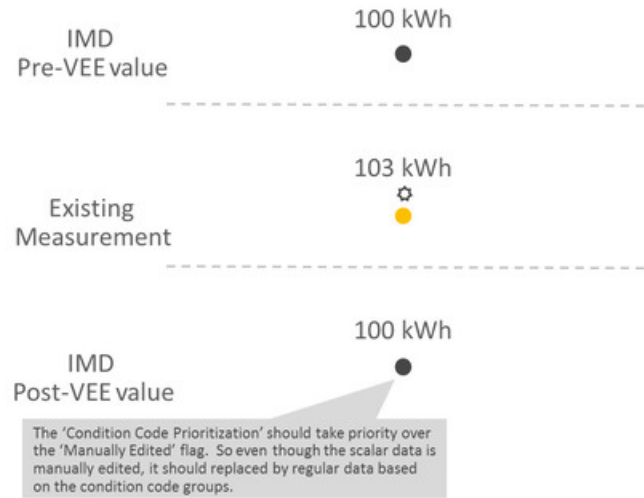

High/Low Check

This validation rule compares the total consumption of the current IMD to historical values. The comparison is normalized based on average daily usage (ADU). If the current IMD is too high or too low compared to historical data then an exception is thrown.

Numerous configuration options are provided including:

- A Historical Pre-Window and Post-Window that determines the number of days to check before and after the period being examined.

- Percentages to control how much of the historical data can be user edited, estimated, or non-normal data.
 - What type of historical data to look at first
 - What to do when an outage has occurred
-

NOTE:

Additional detail on the logic of this rule can be found in the Detailed Description of the D2-HILO-CHK Algorithm Type.

For help with the meaning of specific configuration fields, refer to the embedded help on the screen when adding or editing the rule.

Business Object

D2-VEERuleHighLowCheck

Inactive Measurement Check

This validation rule flags any Initial Measurement Data received on a device that is either disconnected, uninstalled, and/or not connected to a usage subscription.

- When the 'Check Measurements on Disconnected Device' flag is set to "Yes", the logic will compare the IMD measurements total to the threshold configured. If the total measurements are above the threshold, then logic compares the IMD dates to two things: 1) On/Off Dates related to the Install Event and 2) the Installation and Removal Dates of the Install Event. If the On or Off falls within the dates for an interval IMD, then the logic will only sum intervals that fall during the disconnected periods.
 - When the 'Check for Uninstalled Device' flag is set to "Yes", the logic will check for a valid Install Event based on the IMD dates.
 - When the 'Check for Missing Usage Subscription' flag is set to "Yes", the logic will check for an active Usage Subscription based on the IMD dates.
-

NOTE:

Additional detail on the logic of this rule can be found in the Detailed Description of the D2-INACTVCHK Algorithm Type.

For help with the meaning of specific configuration fields, refer to the embedded help on the screen when adding or editing the rule.

Business Object

D2-InactiveMeasurementCheck

Example Scenarios

Below are some example scenarios that can be achieved based on configuration of this rule.

Example 1: Non-zero data during disconnected period

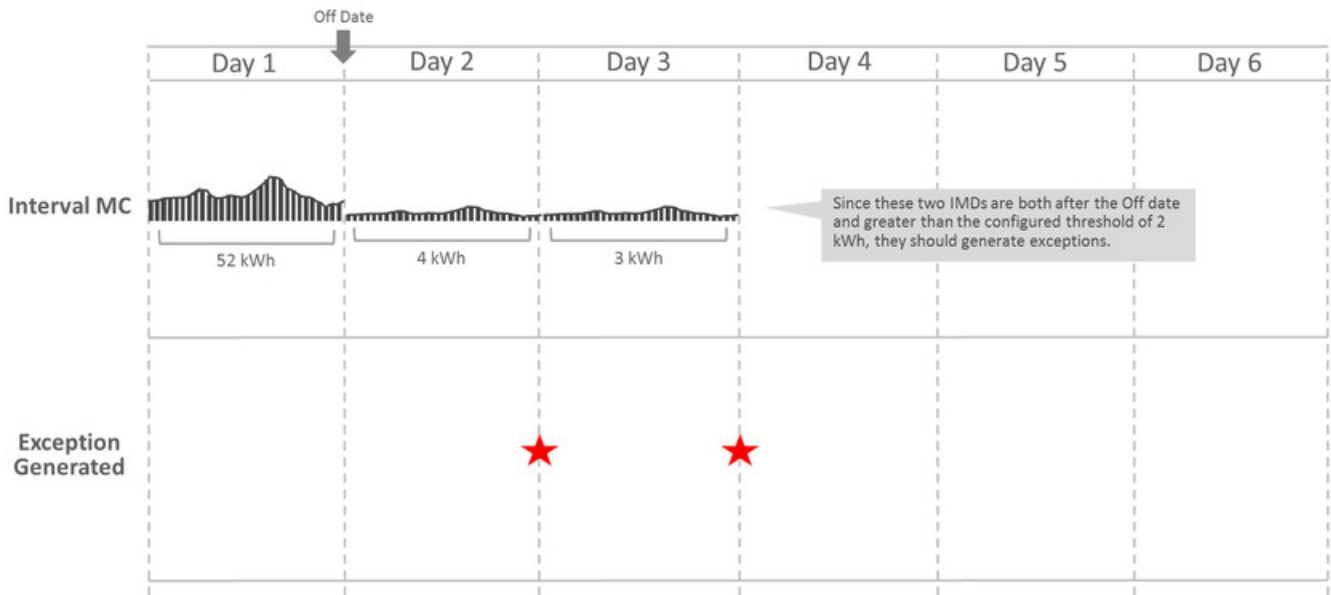

Example 2: Non-zero data after removal date with no new install

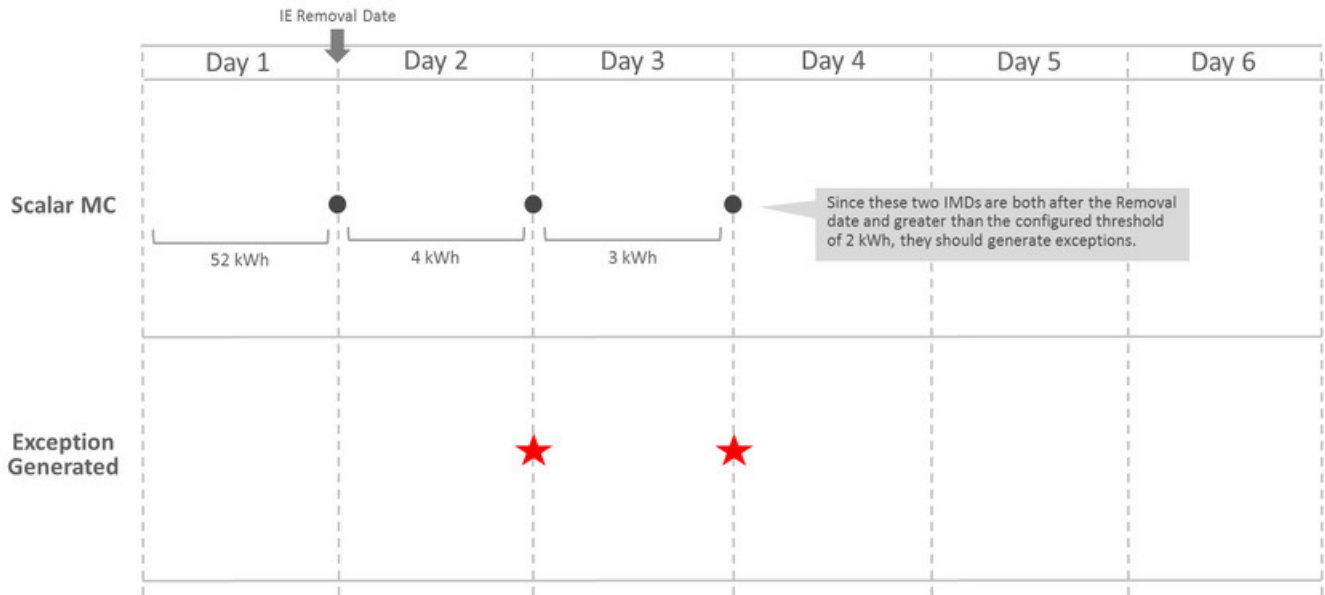

Example 3: Data received when device has no Install Event records



Example 4: Data received when not connected to a Usage Subscription record

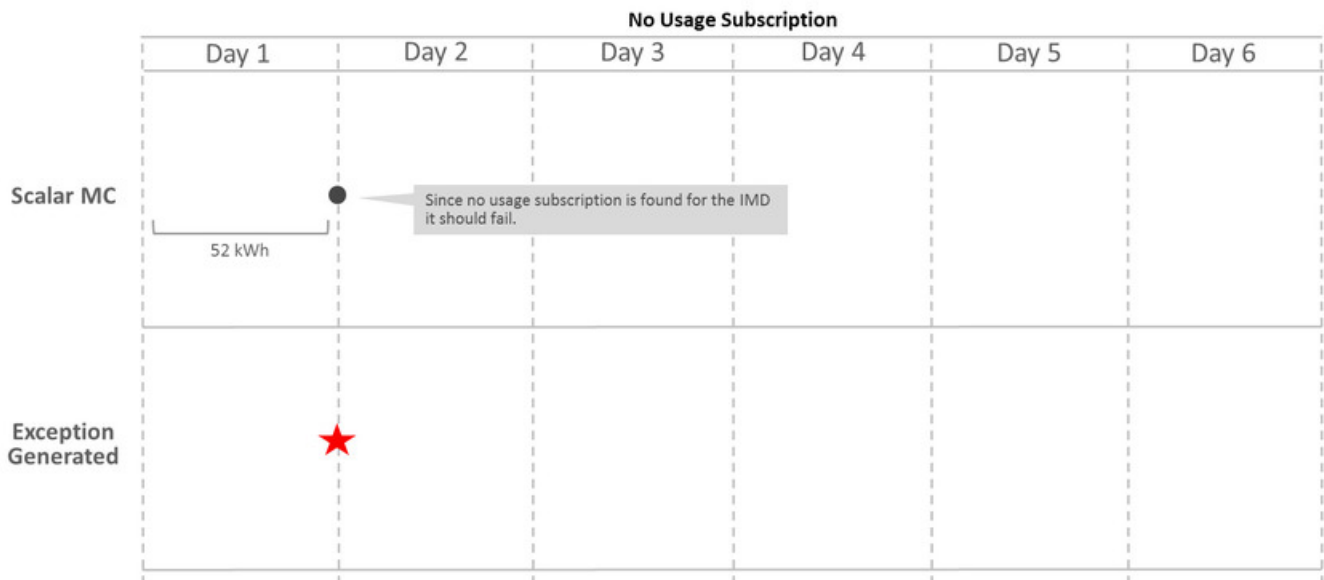

Interval Size Validation

This rule validates that the interval size (in seconds) supplied with the Initial Measurement is equal to the interval size defined on measuring component's type.

NOTE:

Additional detail on the logic of this rule can be found in the Detailed Description of the D2-INTSIZVAL Algorithm Type.

For help with the meaning of specific configuration fields, refer to the embedded help on the screen when adding or editing the rule.

Business Object

D2-IntervalSizeValidation

Interval Spike Check

This rule looks for spikes by taking the highest interval and the third-highest interval, and determining the percent difference between the two. If the percent difference is larger than the tolerance configured on the rule, the algorithm logs an exception of the type and severity configured on the rule.

The rule can be executed in one of two modes (as configured on the rule):

- The spike check is performed for every 24-hour chunk of data in the initial measurement data set
- The spike check is performed for the entire initial measurement data set

NOTE:

Additional detail on the logic of this rule can be found in the Detailed Description of the D2-INTSPKCHK Algorithm Type.

For help with the meaning of specific configuration fields, refer to the embedded help on the screen when adding or editing the rule.

Business Object

D2-IntervalSpikeCheck

Multiplier Check

This rule validates that the register multiplier supplied with the Initial Measurement is equal to the multiplier stored on the measuring component.

NOTE:

Additional detail on the logic of this rule can be found in the Detailed Description of the D2-REGMULCHK Algorithm Type.

For help with the meaning of specific configuration fields, refer to the embedded help on the screen when adding or editing the rule.

Business Object

D2-RegisterMultiplierCheck

Negative Consumption Check

This rule checks if the total consumption of the initial measurement is less than zero. If the rule encounters negative consumption, an exception will be logged if the related Measuring Component Type is not configured to "allow negative consumption", or if the Override MC Type Allow Negative Consumption flag on the rule is set to "Yes".

NOTE:

Additional detail on the logic of this rule can be found in the Detailed Description of the D2-NCON-CHK Algorithm Type.

For help with the meaning of specific configuration fields, refer to the embedded help on the screen when adding or editing the rule.

Business Object

D2-NegativeConsumptionCheck

Prolonged Estimation Check

This validation rule can be used on either interval or scalar and will alert you when a device has been estimated for an extended period of time. The IMD must first fall within the condition code range configured on the rule for this to execute. Next the validation finds the 'Most Recent Non-Estimated Read Date Time' from the Measurement Component. If this date plus the 'Days of Estimation Allowable' from the VEE Rule is less than the IMD End Date then a Prolonged Estimation Exception is created.

NOTE:

Additional detail on the logic of this rule can be found in the Detailed Description of the D2-PROESTCHK Algorithm Type.

For help with the meaning of specific configuration fields, refer to the embedded help on the screen when adding or editing the rule.

Business Object

D2-ProlongedEstimationCheck

Example Scenario

Below is an example scenario that can be achieved based on configuration of this rule.

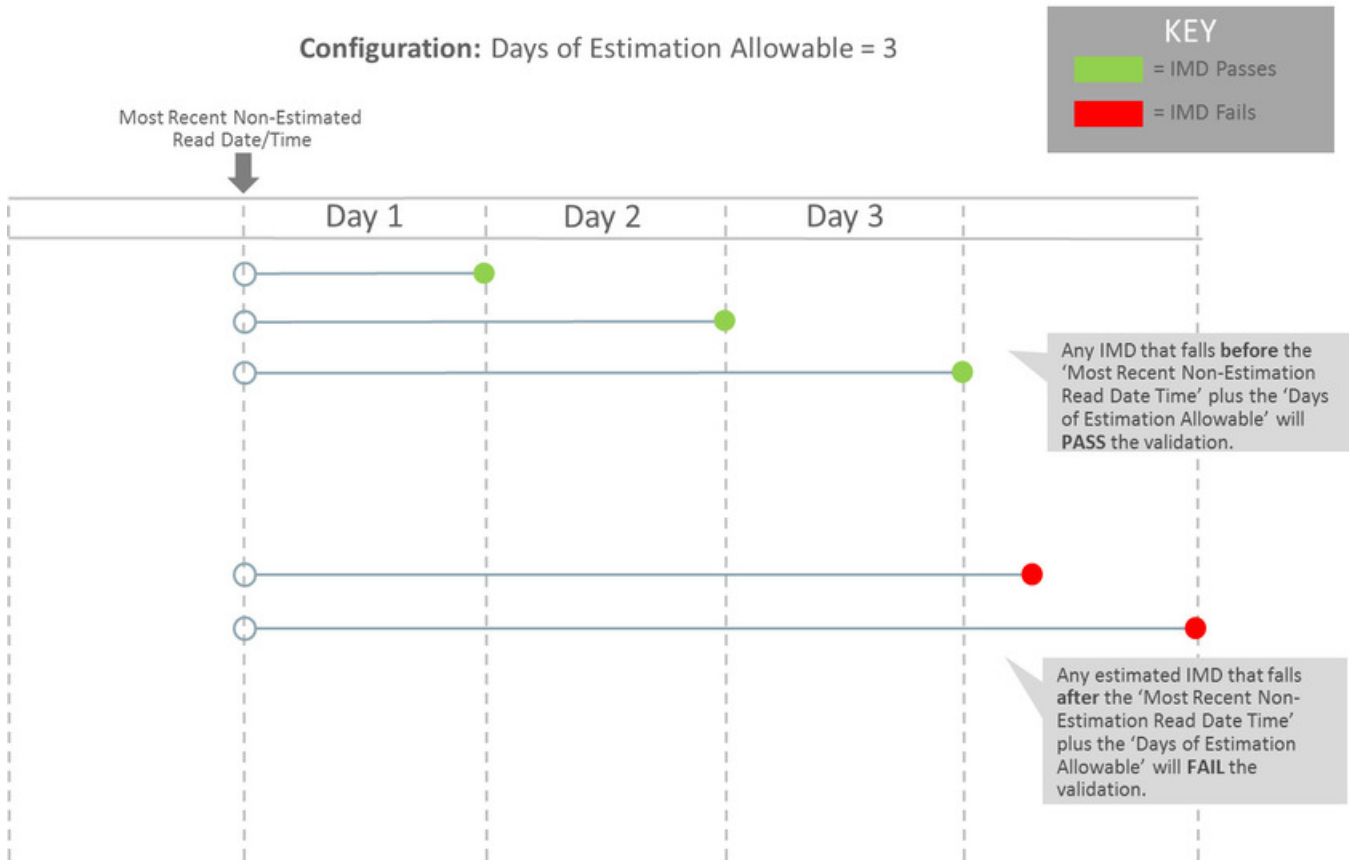

Raise Missing Quantity Exception

This rule flags any missing interval data while providing a soft parameter on the algorithm to exclude a condition range if desired.

NOTE:

Additional detail on the logic of this rule can be found in the Detailed Description of the D2-RAIMISQTY Algorithm Type.

For help with the meaning of specific configuration fields, refer to the embedded help on the screen when adding or editing the rule.

Business Object

D2-RaiseMissingQuantityExcp

Sum Check

This rule evaluates whether consumption for the current Initial Measurement Data is within a tolerance of the sum of the consumption during the same period for any measuring components related to the current one. If the values are not within the defined tolerance of each other, and exception is logged.

The rule can be used to evaluate consumption totals for an interval measuring component that has a related scalar measuring component with the same UOM to ensure that the total consumption of the interval measuring component is within a tolerance of that of the scalar value. It can also be used to evaluate consumption totals for scalar TOU meters that have a "check" register (for example, three registers that measure ON-PEAK, OFF-PEAK, and SHOULDER, with a fourth check register that measures the total consumption).

NOTE:

Additional detail on the logic of this rule can be found in the Detailed Description of the D2-SUM-CHK Algorithm Type.

For help with the meaning of specific configuration fields, refer to the embedded help on the screen when adding or editing the rule.

Business Object

D2-SumCheck

Unit of Measure Check

This rule checks the unit of measure (UOM) passed in with the Initial Measurement against the primary unit of measure configured on the measuring component's type.

NOTE:

Additional detail on the logic of this rule can be found in the Detailed Description of the D2-UOMCHK Algorithm Type.

For help with the meaning of specific configuration fields, refer to the embedded help on the screen when adding or editing the rule.

Business Object

D2-UOMCheck

Zero Consumption Check

This rule checks if the total consumption for the IMD is zero. There is also a check for whether an outage occurred during the same time as the zero consumption to provide ways to avoid To Dos by having a different exception type.

NOTE:

Additional detail on the logic of this rule can be found in the Detailed Description of the D2-ZEROCNCHK Algorithm Type.

For help with the meaning of specific configuration fields, refer to the embedded help on the screen when adding or editing the rule.

Business Object

D2-ZeroConsumptionCheck

Estimation VEE Rules

Interval Adjustment From Scalar

This rule adjusts interval Initial Measurement Data based on scalar values using one of two options configured on the VEE Rule. Both options require that a scalar measuring component be related to the current interval measuring component using the Consumption Reference Measuring Component, and that one or more final measurements be present for the related measuring component between the start and end date/times of the current Initial Measurement Data set.

1. Adjust all intervals. In this case, the scalar consumption provides a value that is then used to proportionally adjust all of the intervals in the set. The formula used is $(\text{Scalar Consumption} / \text{Total Initial Measurement Consumption}) * \text{Interval Amount}$. If the total of all of the intervals had been equal to zero originally, the rule adjusts all of the intervals to the same value.
 2. Adjust intervals based on condition. For this option, a range of conditions is configured on the VEE Rule, and the rule adjusts only those intervals with conditions that lie within the configured range. The adjustment is done by applying an adjustment factor to each of the intervals within range.
-

NOTE:

Additional detail on the logic of this rule can be found in the Detailed Description of the D2-INTADJSCA Algorithm Type.

For help with the meaning of specific configuration fields, refer to the embedded help on the screen when adding or editing the rule.

Business Object

D2-IntervalAdjustmentFrmScalar

Interval Averaging Estimation

The algorithm estimates when the current Measuring Component is eligible. Estimation is performed only if all these conditions are satisfied:

- The Measuring Component is interval.

- The Measuring Component is linked to a Service Point or the VEE Rule's Estimate If Not Attached to SP field is set to "Estimate".
- The Percentage of Missing Intervals is less than the VEE Rule's Maximum Percentage Missing Intervals Threshold.

The algorithm will compute the Total Accumulated Consumption and the Total Number of Intervals using a variety of methods including scanning holidays, similar days of the week, or neighboring days. Once a set of valid comparison days are found then these are used as the basis of creating estimated intervals for the current IMD.

NOTE:

Additional detail on the logic of this rule can be found in the Detailed Description of the D2-INTAVGEST Algorithm Type.

For help with the meaning of specific configuration fields, refer to the embedded help on the screen when adding or editing the rule.

Business Object

D2-IntervalAveragingEstimation

Interval Create Estimation IMD for Gap

This rule is very different from other VEE rules in that it does not examine the current initial measurement but rather looks to see if there are any missing measurements prior to the initial measurement being processed (i.e. a gap exists). If so and the scenario meets the configured options it will generate an estimation initial measurement to fill in that gap.

This rule is intended to provide more real-time filling of missing measurements as opposed to running periodic estimation. However, it is still expected that periodic estimation will be used in conjunction with this rule such that any gaps that are not filled in by this rule would eventually be filled in by periodic estimation.

This rule can be configured to perform minimal validation of that gap that is identified and defer to the estimation initial measurement to validate against other initial measurements and final measurements that may overlap the gap. Conversely, it can also be configured to validate the gap and exclude any periods where a final measurement or in progress initial measurement overlaps the gap's duration.

NOTE:

This estimation rule acts differently from the other rules - it creates a new IMD rather than filling in missing values in an estimation IMD created from periodic estimations.

Additional detail on the logic of this rule can be found in the Detailed Description of the D2-CREESTIMD Algorithm Type.

For help with the meaning of specific configuration fields, refer to the embedded help on the screen when adding or editing the rule.

Business Object

D2-CreateEstimationIMDRule

Example Scenarios

The following are sample scenarios that can be achieved based on configuration of this rule.

Example 1: A 4-hour gap exists and the rule is configured to always fill gaps. Maximum hours are set to 4 and the gap fill is set to "always".

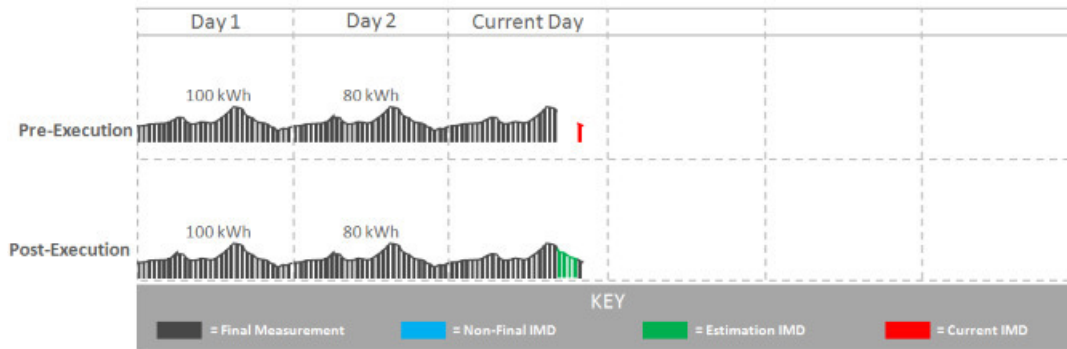

Since the maximum hours has not been exceeded and the rule is configured to always fill the gap, a 4-hour estimation IMD is created to fill the gap.

Example 2: A 4-hour gap exists and the rule is configured to always fill gaps. However, the maximum number of hours to fill is 3.

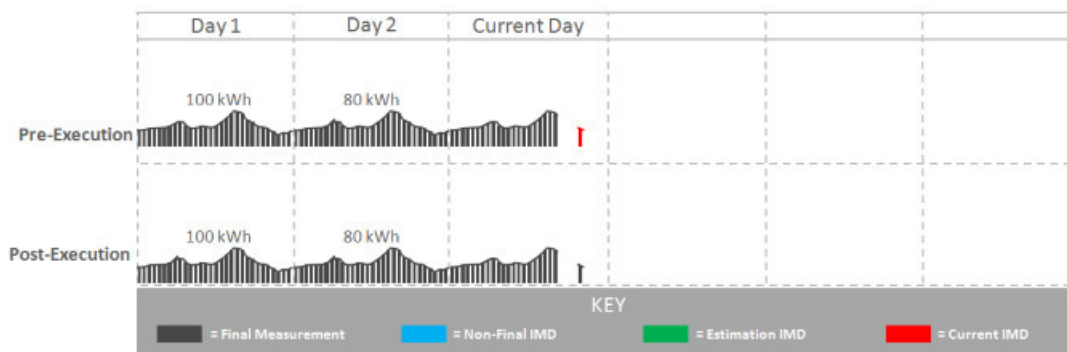

Since the gap is 4 hours long and the maximum hours to gap fill is 3 hours, no estimation has been created. An exception would be created if the rule were configured this way.

Example 3: A non-contiguous gap exists and the rule is configured to "Skip In-Progress IMDs and Final Measurements" with a maximum number of IMDs set to 2.

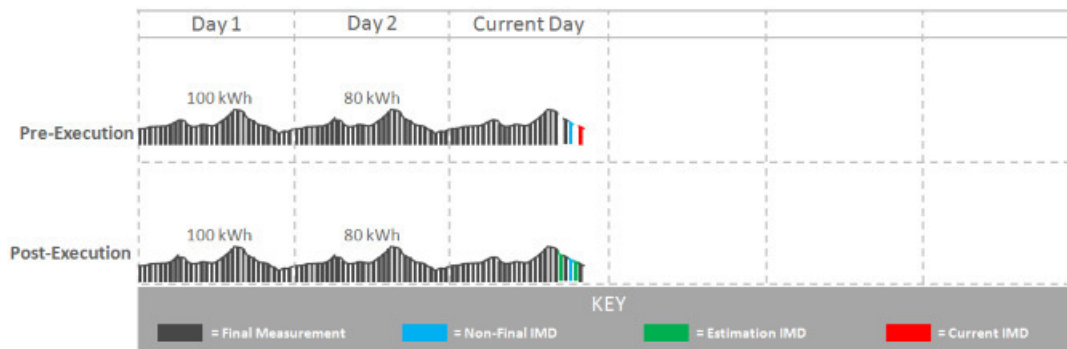

In this scenario:

- One interval in the 4-hour gap is covered by a final measurement.
- One interval in the 4-hour gap is covered by an in-progress IMD.
- Two estimation IMDs are generated one to fill each hour not covered by a final measurement or in-progress IMD.

Interval Interpolation Estimation

This rule attempts to interpolate gaps in Initial Measurement Data sets using prior and subsequent intervals as starting points for linear interpolation. A configuration parameter determines the maximum number of consecutive intervals within a gap before that gap can no longer be interpolated.

If a given gap lies at the beginning or end of the Initial Measurement Data set, this algorithm seeks out final measurements immediately before or after the set in an attempt to find two reference measurement values for interpolation. In this situation, assuming that the condition of the measurement retrieved lies in NEITHER of the algorithm parameter ranges you have configured (the measurement is neither "missing" nor an "outage"), this measurement value is then used as the basis for interpolation.

In the event that the gap is the entire length of the Initial Measurement Data set (and the VEE Rule is configured such that this is not too large of a gap), the routine attempts to find final measurements as described above.

If a valid measurement can be found for only one side of a given gap, the interpolation logic assigns each interval in the gap the same value - the value of the measurement retrieved. This is referred to as applying a "flat load".

NOTE:

Additional detail on the logic of this rule can be found in the Detailed Description of the D2-INTINTEST Algorithm Type.

For help with the meaning of specific configuration fields, refer to the embedded help on the screen when adding or editing the rule.

Business Object

D2-IntervalInterpolationEst

Interval Profile Estimation

This rule uses a profile measuring component's interval consumption as a source of values to assign to intervals in the current Initial Measurement Data set that are marked "missing" via the interval's condition. If the interval is marked with a condition indicating "outage", the algorithm skips it.

If a measurement is not available for the profile measuring component on the date/time, the interval is left unchanged.

NOTE:

Additional detail on the logic of this rule can be found in the Detailed Description of the D2-INTPROEST Algorithm Type.

For help with the meaning of specific configuration fields, refer to the embedded help on the screen when adding or editing the rule.

Business Object

D2-IntervalProfileEstimation

Interval Proxy Day Estimation

This rule checks for days with similar temperature and uses the measurement data from those days as the basis of interval estimation for the in-flight initial measurement. [Measuring component comparison periods](#) are used as the main driver for determining similar temperature days.

NOTE:

Additional detail on the logic of this rule can be found in the Detailed Description of the D2-INTPROXY Algorithm Type.

For help with the meaning of specific configuration fields, refer to the embedded help on the screen when adding or editing the rule.

Business Object

D2-IntervalProxyDayEstimation

Scalar Calculation From Interval

This rule calculates a single consumption amount for a scalar measuring component's Initial Measurement using the total consumption for the same date/time range for a related interval measuring component.

The scalar value replaces any existing value within the Initial Measurement (in the post-VEE list) and updates the condition to the value configured on the VEE Rule. This VEE Rule updates the condition to the value defined in "Condition Value for High Quality Condition" when the measurement condition value for all underlying interval data and the previous scalar measurement (when Evaluate Condition Of Previous Scalar Measurement is configured as "Yes") is greater than or equal to the "Minimum Condition Quality to Override" (If "Minimum Condition Quality to Override" is defined) otherwise it updates the measurement condition of the Initial Measurement Data to the condition defined in "IMD Created Condition Value".

NOTE:

Additional detail on the logic of this rule can be found in the Detailed Description of the D2-SCACALINT Algorithm Type.

For help with the meaning of specific configuration fields, refer to the embedded help on the screen when adding or editing the rule.

Business Object

D2-ScalarCalcFromInterval

Scalar Estimation

This rule uses historical data for the same measuring component to derive an estimated value for a scalar Initial Measurement. Depending upon a VEE Rule configuration parameter, the routine uses historical data from a month ago followed by a year ago, or vice-versa. If the data for the first historical period turns out to be usable, the second historical period will not be evaluated. Whether historical data qualifies for use in estimation is configured via the rule parameters in conjunction with the below algorithm parameters.

The rule rejects consumption from a historical period as unusable for estimation if too great a portion of the period is covered by final measurements that are not high-quality. The first pair of parameter values are used when evaluating the acceptable System-Estimated Percentage for historical periods as configured on the VEE Rule. Once an estimated value is calculated, the routine backs into a reading (which involves backing out multipliers and, if the measuring component is subtractive, adding the result to the prior reading).

An interim High/Low can also be configured on this rule.

NOTE:

Additional detail on the logic of this rule can be found in the Detailed Description of the D2-SCALAREST Algorithm Type.

For help with the meaning of specific configuration fields, refer to the embedded help on the screen when adding or editing the rule.

Business Object

D2-ScalarEstimation

Scalar Profile Estimation

This VEE rule arrives at a scalar estimate by looking at final measurements for a profile measuring component covering the same date range as the current Initial Measurement. The profile measuring component to be used as a source of measurement data is defined via a profile factor on the rule. This rule is meant primarily for a configuration in which the profile measuring components are interval, although the profile could be scalar as well.

If a measurement already exists in the current Initial Measurement with a condition that lies within the ranges specified in the pairs of algorithm parameters for "system estimate" and "regular", the routine does not attempt to estimate.

NOTE:

Additional detail on the logic of this rule can be found in the Detailed Description of the D2-SCAPROEST Algorithm Type.

For help with the meaning of specific configuration fields, refer to the embedded help on the screen when adding or editing the rule.

Business Object

D2-ScalarProfileEstimation

Scalar Proration

This rule prorates the value of a scalar reading that has two valid scalar readings on either side as boundaries.

If the scalar MC does have a related interval MC and 'Minimum Related Measurement Condition' is defined the algorithm will take into consideration any intervals during the proration period that meet a minimum condition quality defined by the 'Minimum Related Measurement Condition' when performing the proration. This is to keep the prorated scalar estimates in sync with any existing interval measurements. To do this the algorithm will augment the total duration and total quantity being prorated by the related interval MC's qualifying measurements. For example, take the following scenario:

- Scalar proration is executing for a scalar IMD for 01/01 12:00 AM - 01/02 12:00 AM (24 hours)
- The subsequent measurement is for 150 kWh and has a measurement date/time of 01/04 12:00 AM (72 hours)
- The related interval MC has measurements on 01/03 12:00 AM to 01/04 12:00 AM totally 100 kWh (24 hours)

Therefore the result of the calculation for the scalar IMD from 01/01 12:00 AM to 01/02 12:00 AM would be 25 kWh. Since the interval measurements covered 24 of the 72 total hours of the 150 kWh that would leave 50 kWh to be split among the remaining 48 hours. Which leaves 25 kWh for 01/01 12:00 AM to 01/02 12:00 AM and 25 kWh for 01/02 12:00 AM to 01/03 12:00 AM.

NOTE:

Additional detail on the logic of this rule can be found in the Detailed Description of the D2-SCLRPRORT Algorithm Type.

For help with the meaning of specific configuration fields, refer to the embedded help on the screen when adding or editing the rule.

Business Object

D2-ScalarProration

Subtractive Interval Adjustment Rule

This rule adjusts qualifying consecutive intervals for a subtractive interval initial measurement (IMD) based on the known consumption between a set of actual readings. The readings can either be leveraged from other intervals within the IMD or from the final measurements when there are no suitable readings within the IMD. The adjustment is done by applying an adjustment factor to each of the qualifying intervals.

The rule supports adjusting multiple sets of qualifying consecutive intervals by calculating a consumption adjustment target and adjustment factor specific to each set of consecutive qualifying intervals.

Intervals are considered to be qualified for adjustment based on condition. A range of conditions is configured on the VEE Rule, and the rule adjusts only those intervals with conditions that lie within the configured range.

NOTE:

Additional detail on the logic of this rule can be found in the Detailed Description of the D2-SUBINADJV Algorithm Type.

For help with the meaning of specific configuration fields, refer to the embedded help on the screen when adding or editing the rule.

Business Object

D2-SubIntAdjustmentVEE

Decision-Making VEE Rules

Exception Handler

This rule allows you to terminate the VEE process based on a configurable set of exceptions being present for the IMD. This rule also allows a unique To Do Type to be generated based on a group of exceptions.

NOTE:

Additional detail on the logic of this rule can be found in the Detailed Description of the D1-AVEER-EEH Algorithm Type.

For help with the meaning of specific configuration fields, refer to the embedded help on the screen when adding or editing the rule.

Business Object

D1-VEERuleExceptionHandler

Execute VEE Group

Many implementations need to execute a group of validations for any data being received. For example, you might want to perform device identifier validations, multiplier checks, and UOM checks on all measuring components. One inefficient way to meet this requirement would be to repeat these three rules in multiple VEE groups. However, this solution becomes hard to maintain if changes to the rules are required (or if new "global rules" are introduced) as each group would have to be updated. Instead of this, you can use the "Execute VEE Group" rule to execute a referenced VEE Group. Using the example

above, you could create a group called "Rules for All MCs" that contains a device identifier validations rule, a multiplier check rule, and a UOM check rule, and then reference the "Rules for All MCs" group in a Execute VEE Group rule.

NOTE:

Additional detail on the logic of this rule can be found in the Detailed Description of the D1-AVEER-RFG Algorithm Type.

For help with the meaning of specific configuration fields, refer to the embedded help on the screen when adding or editing the rule.

Business Object

D1-VEERuleReferredVEEGroup

Successful Termination

This rule allows VEE to be successfully terminated based on a list of exceptions.

NOTE:

Additional detail on the logic of this rule can be found in the Detailed Description of the D1-AVEER-EST Algorithm Type.

For help with the meaning of specific configuration fields, refer to the embedded help on the screen when adding or editing the rule.

Business Object

D1-VEERuleSuccessTermination

VEE Group Matrix (Factor)

Another situation likely to occur in many implementations is where specific rules may need to be applied to measurement data based on specific criteria, such as geography. For example, some geographic territories may have unique VEE Rules in addition to rules that are applied to all geographic territories. The "VEE Group Matrix (Factor)" rule allows for a Factor to determine which VEE Rule gets executed based on defined characteristics.

NOTE:

Additional detail on the logic of this rule can be found in the Detailed Description of the D1-AVEER-FCT Algorithm Type.

For help with the meaning of specific configuration fields, refer to the embedded help on the screen when adding or editing the rule.

Business Object

D1-VEERuleGroupFactor

Prerequisite Setup

Since the prerequisite setup items for this rule are more involved, the following procedure describes these in detail:

1. Create the Characteristic Type and Values to be used by the factor that will be referenced by the rule.
 2. Create the Characteristic Source Algorithm to be used by the factor that will be referenced by the rule.
 3. Create the VEE Groups to be associated to the characteristic values.
 4. Create the Factor that will be referenced by the rule.
-

5. Create the Factor Values for the factor, each referencing an effective-dated characteristic value/VEE group pairings.
6. Create the rule, referencing the factor

Measuring Component Statistics

Understanding Measuring Component Statistics

Oracle Utilities Meter Data Management provides a way to stage statistics for Measuring Components in order to speed up VEE processing. These statistics are primarily meant for use in conjunction with the [Dynamic Comparison Validation](#) VEE Rule, but could also be generated for other analytics or reporting.

Some of the potential benefits of using Measuring Component Statistics are:

- Reduce the data volume for VEE queries by up to 1000 times (this is most beneficial when replacing VEE Rules that query historical data such as High/Low)
- Offload heavier processing of historical data to "system downtimes" - potentially nights or weekends

Below is an overview example of how Measuring Component Statistics can be implemented along with the Dynamic Comparison Validation:

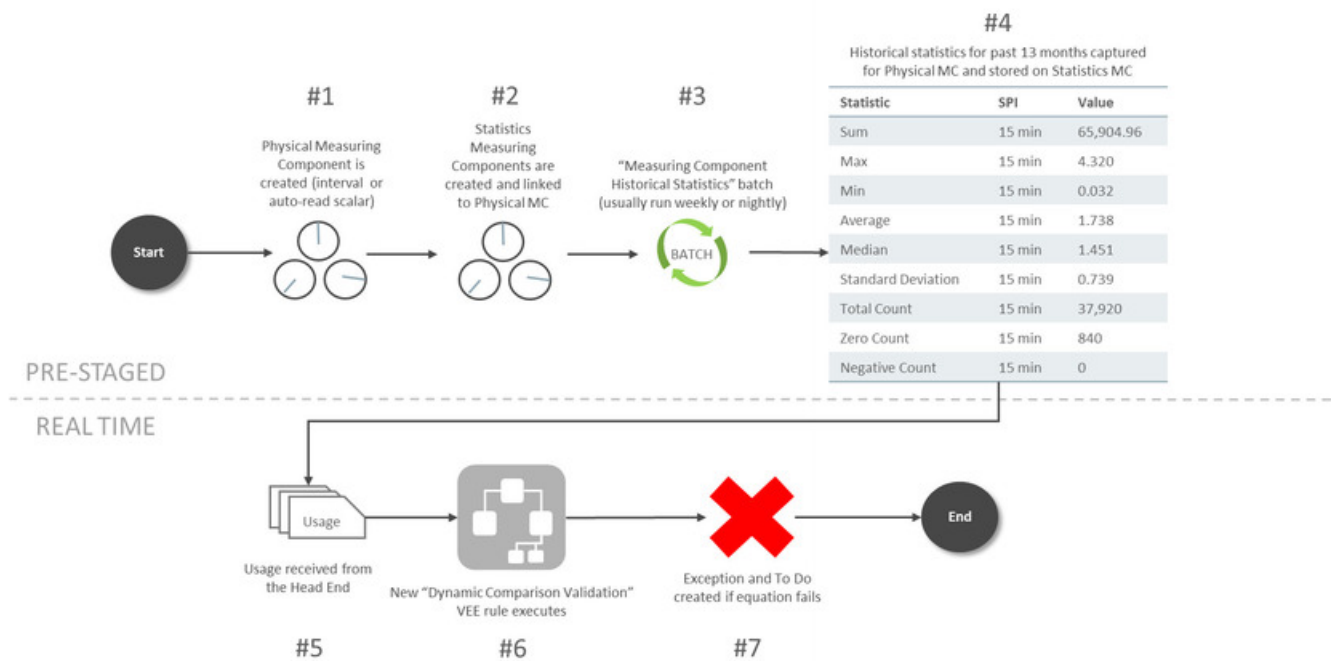

The steps for pre-staging Measuring Component Statistics are detailed below:

1. A Physical Measuring Component is created. The algorithm to trigger the creation of Statistics Measuring Components is only set on Interval or Auto-Read Scalar BOs as part of base product.
2. New Statistics Measuring Component are created and linked to the Physical Measuring Component.
3. The Measuring Component Historical Statistics Batch (D1-MCHS) is run based on the schedule you've defined. The suggestion is to run this either nightly or on the weekends during quieter times for overall system processing.
4. A measurement is created for the Statistics Measuring Component that holds historical statistics related to the Physical Meter for a specific period of time (in this example it's set for 13 months).

The steps for how VEE can take advantage of Measuring Component Statistics are detailed below:

1. IMDs are received from the Head End.
2. The [Dynamic Comparison Validation](#) VEE Rule is configured to execute for the meter. This validation uses the historical statistics from the Statistics Measuring Component in order to perform its validation logic.
3. An exception and potentially a To Do is generated based on the failure of the VEE rule.

Storage Impact from Statistics

Much consideration was given to the storage implications when designing Measuring Component Statistics. Below is an outline of the storage impact to customers who choose to calculate and store Channel Statistics. An example impact to a utility with 1 million Physical Meters (each with 4 channels of information) is shown in the far right column:

Area	Additional Data in MDM	Example Impact (assuming utility has 1 million Physical Meters)
Additional MCs <i>Assumption: Statistics are only configured on the primary billing channel MC Type for the majority of your Physical Meters.</i>	1-3 extra MCs per Physical Meter <i>Assumption: customers will only configure Statistics on their primary billing channel MC Type for the majority of their Physical Meters.</i>	1 - 3 million extra MCs <i>This increases the Measuring Component table by an extra 25% to 75% from its size without statistics.</i>
Additional Measurements <i>If 'Statistics Retention Mode' configured as "Only Retain Most Recent Record".</i>	1 extra Measurement per Physical Meter	1 - 3 million extra Measurements for the life of MDM <i>This data is a minuscule fraction compared to the overall AMI data footprint.</i>
Additional Measurements <i>If 'Statistics Retention Mode' configured as "Retain Historical Records".</i>	1 extra Measurement per Physical Meter per week	1 - 3 million extra Measurements per week (52-156 million per year) <i>This data is 0.2-0.5% of the size of the AMI data collected in that same week.</i>

Configuring Measuring Component Statistics

Measuring Component Types

In order to start generating Measuring Component Statistics, two different configurations must occur for [Measuring Component Types](#):

- New Measuring Component Types must be configured that leverage the **Channel Statistics Type** business object. These should be setup as the periods for which Measuring Component Statistics should be calculated. For example, if you would like to be able to reference both last month, last year, as well as the past 13 months as statistics periods, then 3 different Channel Statistics Types must be setup for this. These could be setup as follows:
 - "Last Month" Channel Statistics Type:
 - Calculation Lag Days = 0
 - Calculation Horizon Days = 30
 - "Same Month Last Year" Channel Statistics Type:
 - Calculation Lag Days = 365
 - Calculation Horizon Days = 395
 - "Prior 13 Months" Channel Statistics Type:

- Calculation Lag Days = 0
- Calculation Horizon Days = 395

NOTE: *it's recommended to set the Statistics Retention Mode to "Only Retain Most Recent Record" on the Channel Statistics Type to reduce the amount of data being stored in Oracle Utilities Meter Data Management.*

- For a Physical Measuring Component Type leveraging either "Interval Channel Type" or "Register - Auto-Read Type", the **Related Statistics Measuring Component Types** section must be filled in with the appropriate types that should be created for the Physical Measuring Component.

VEE Rule

If you have a desire to leverage Measuring Component Statistics for VEE, the [Dynamic Comparison Validation](#) VEE Rule section should be referenced. A number of detailed examples of how to implement this rule are provided in this section as well.

Related Batch Controls

There are a few batches directly involved with Measuring Component Statistics:

- **Measuring Component Historical Statistics (D1-MCHS):** this batch monitors any active Statistics Measuring Components to execute the logic for calculating a new set of historical statistics.
- **Statistics Measuring Component Creation (D1-STMCC):** this batch is used to create Statistics Measuring Components on any Physical Measuring Components that were created prior to configuring this module. This is especially useful for existing customers that want to implement Statistics Measuring Components for all of their devices.

NOTE: Refer to [Understanding Measuring Component Statistics](#) for more information.

Defining Usage Options

This section describes concepts and common tasks related to usage administration.

The Big Picture of Usage Requests

Oracle Utilities Meter Data Management is used by some organizations who use a meter data management (mdm) system to record meter reading information. Since meter reads are not available in Oracle Utilities Customer Care and Billing to calculate consumption during the billing process, usage (or bill determinants) must be requested by Oracle Utilities Customer Care and Billing from the mdm system, Oracle Utilities Meter Data Management.

The following sections describe how the base-package usage request process works.

Requesting Bill Determinants

The term bill determinant request is another way to refer to a usage request. These usage requests are created during the batch billing process, and also when a user generates an online bill segment or performs cancel / rebill. The get consumption algorithm specified on the SA Type's Bill Segment Type is responsible for creating the usage request.

Online Billing Usage Requests

- Usage requests created from an online billing request are not held in the initial state. These usage requests are transitioned through their lifecycle resulting in the request being sent to Oracle Utilities Meter Data Management (MDM) and, once a response is received, the bill segment is regenerated.
- The bill segment remains in the Freezable state until the user freezes the bill segment and completes the bill. If the freezable bill segment is regenerated, however, the system cancels the usage request and creates another usage request for the bill segment.
- In addition to the standard MDM usage request elements, the system captures the responsible user id.

Usage Request Lifecycle

The usage request business object (BO) contains the rules that govern the processing of a usage request. The base product provides the BO C1-UsageRequest which serves as a parent BO and contains the following lifecycle:

- All usage requests are created in the initial Pending state. If the usage request was created from the batch billing process, the batch Usage Scheduled Monitor Process must be executed to transition the usage request.
- If there are pending sync requests for the usage request's service agreement, the usage request is held in the Awaiting Data Sync state until the sync is processed.
- Once all pending sync requests related to the usage request have been processed, the usage request transitions to the Send Request state. An enter algorithm on this transitory state is responsible for sending the usage request to Oracle Utilities Meter Data Management (MDM).
- The usage request sits in the Awaiting Bill Determinants state until a response is received from MDM, or a time out is encountered.
- When a response is received from MDM, the usage request is transitioned to either the Bill Determinants Received state, or the Error state. In the case of an error, the following occurs:
 - If the usage request was created from the batch billing process and the billing window is still open, a new usage request will be created the next time billing runs and the process is repeated. If however, the billing window is no longer open, a to do entry is created for manual follow up.
 - If the usage request was created from an online billing process, the user will be notified. The bill segment remains in the error state and the user can either delete the bill segment, or attempt to generate it again. If the bill segment is regenerated, a new usage request is created and the process is repeated.
 - The system transitions usage requests in the Bill Determinants Received state to the Bill Determinants Processed state. An enter algorithm on this final state is responsible for generating the bill segment. If the usage request was created from the batch billing process, the bill segment is frozen and the bill is completed. For online billing usage requests, the user is responsible for freezing the bill segment and completing the bill.

Summary Billed Accounts and Usage Requests

A "summary" account refers to an account with service agreements that cover more than one premise. If these premises are linked to service points that span different measurement cycle routes scheduled for reading on different dates, there's no guarantee that all the account's SAs will be billed at the same time. This is because batch billing for manually read meters is based on the meter's scheduled reading date.

For example, assume a summary account has two SAs each linked to a different premise. One is on route X, scheduled for reading every first of the month and the other is on route Y, scheduled for reading every 20th of the month. Assume that the account's bill cycle is cycle X (which matches the schedule of premise/SP on route X). When billing runs on the first of the month, the service agreements tied to route Y won't have any reads. And because route Y is not scheduled for reading, the system will not estimate the consumption. Instead, it will skip billing the route Y SAs until the next month. This means some SAs are always one billing cycle behind.

Requesting Bill Determinants for Summary Billed Accounts

Usage requests for summary billed accounts are handled as follows:

- On the first night of the billing window usage requests are created for each SA and sent to Oracle Utilities Meter Data Management (MDM). MDM then checks what the next schedule read date is for each service point.
- Assuming Oracle Utilities Meter Data Management owns meter read schedules; when batch billing executes Oracle Utilities Customer Care and Billing (CCB) cannot determine whether a summary account's service agreement should be included on the bill or not.
- If MDM determines that an SA/usage subscription should be skipped from billing, it notifies CCB by including a skip indicator and reason on the usage response, as well as the SA's next scheduled read date. This date is captured as a **MDM Next Scheduled Read Date** characteristic on the SA, and the usage request is cancelled. The system still attempts to complete the bill since this might be the last outstanding usage request for the bill
- When billing next runs, the base *Get bill segment consumption using a usage request* algorithm first checks if the SA should be skipped as follows (Note that this check is also performed in first billing run):
- Get the **MDM Next Scheduled Read Date** characteristic on the SA. If this date is after the bill segment end date, we'll skip the SA from billing

If your implementation would like to wait until the bill cycle window end date before attempting to complete summary account's bills, ensure that the **Complete Bill at End of Bill Cycle** pre-bill completion algorithm is defined on customer class. This is useful if scheduled reads are expected in the bill cycle window, but not necessarily on the window start date.

Corrected Read Notifications

If a read that was used for bill determinant calculations is modified in the mdm system, notification is sent to Oracle Utilities Meter Data Management.. Resulting in the creation of an off cycle bill generator. The system uses the business object defined as the OCBG Corrected Read BO MO option on the Off Cycle Bill Generator maintenance object to create the OCBG.

What happens next depends on the lifecycle that your implementation has configured for the OCBG Corrected Read BO. Here are examples of what might occur:

- Create a To Do entry for manual follow up.
- Find any frozen bill segments that might be affected by the corrected read and perform cancel/rebill.

Configuring The System For Usage Request Integration

Oracle Utilities Customer Care and Billing sends usage requests to Oracle Utilities Meter Data Management (MDM) in the form of an xml message. MDM sends responses back to Oracle Utilities Customer Care and Billing.

The following sections describe at a high level the data setup required to send usage requests to MDM.

Start and End Times for Billing

As you know, there is logic in billing to determine the start date and end date for a bill segment. Refer to [Ways To Control The Start Date Of A Bill Segment](#) and [Ways To Control The End Date Of A Bill Segment](#) for more information. When billing for a customer with interval data, the system also needs to know the time.

The time used by billing, referred to as the cutoff time, is stored on the service agreement. There is also a control on the service agreement called Start Day Option that determines which day to use for the start time. Billing uses the billing date, the cutoff time, and the start day option to determine the correct interval data to process.

Oracle Utilities Customer Care and Billing lacks knowledge of the type of meter installed at a service point. Thus, both interval processing period as well as scalar processing information is captured on a usage request. Oracle Utilities Meter Data Management (MDM) then uses the appropriate period to calculate bill determinants based on the type of meter installed.

MDM returns the true usage period used to calculate bill determinants on the usage response. This usage period is captured on the bill segment.

The Big Picture of Time of Use Mapping and Pricing

This section provides an overview of the concepts related to setting up your control tables to support time of use mapping and pricing with the rates.

NOTE: Time of use mapping is supported to enable low volume interval data manipulation (for example, for mapping electric vehicle charging events into time of use quantities). A meter data management application, such as Oracle Utilities Meter Data Management, must be used to manipulate high volumes of interval data and calculating bill determinants for billing purposes.

Mapping to Time of Use (TOU) Periods

Many customers choose not to price their interval data using interval prices. Customers may choose for their interval data to be mapped into time of use (TOU) periods. This option for interval data might be preferred because:

- Typically it involves fixed prices for the use periods
- It is more manageable than direct billing
- It is easier for a customer to forecast and budget

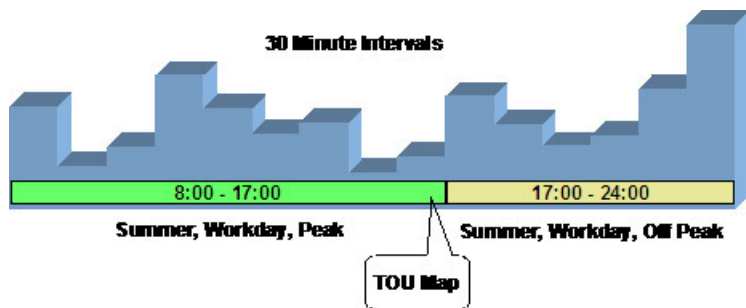

A TOU map's purpose is to define the TOU codes for a collection of time period definitions (i.e. given dates and times). The TOU Map has a TOU Map Type, which defines the interval size between TOU map data rows.

Time of use periods can (and often do) change during the year.

Map #123 (TOU Group 2)	
Effective 1 Jan 2000	
Interval Date/Time	
30/Apr/00 16:30	On Peak/Winter
30/Apr/00 16:45	On Peak/Winter
30/Apr/00 17:00	Off Peak/Winter
30/Apr/00 17:15	Off Peak/Winter

01/May/00 7:45	Off Peak/Summer
02/May/00 8:00	On Peak/Summer
02/May/00 8:15	On Peak/Summer

All the possible TOU codes for a given map are grouped together in a TOU group. Refer to [Grouping of TOU Codes for TOU Mapping](#) for more information.

Grouping of TOU Codes for TOU Mapping

This section describes the relationship between TOU Codes and TOU Mapping.

Overview of TOU Codes and TOU Mapping

A TOU map's purpose is to define the TOU codes for a collection of time period definitions (i.e. given dates and times).

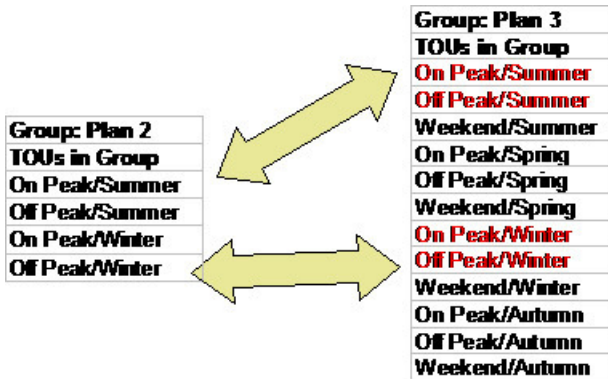
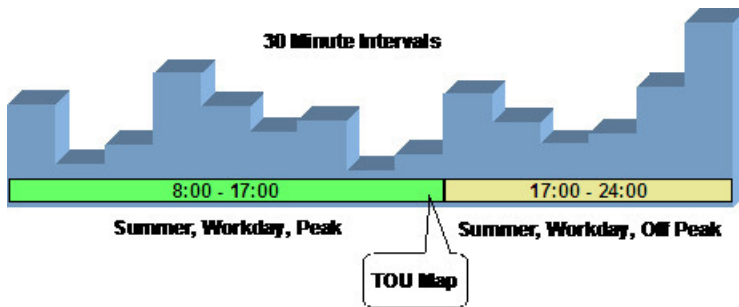

TOU Sequence for TOU Mapping and Pricing

If desired, you may use sequence number to indicate the relative position or relative priority of each TOU code within a TOU group. This sequence number is not used by any system functionality, but is available for you to use in a plug-in algorithm.

Time of Use (TOU) Mapping and Pricing

The following section describes the logic used by the system to map an interval data curve to TOU periods using a TOU map, and subsequently apply prices to these mapped quantities.

At some point during billing, the system will take an interval data curve and will map the interval values to TOU periods based on a TOU Map. The interval data curve is retrieved from either a specific usage request or from the new rate engine buffer populated prior to calling the rate engine.

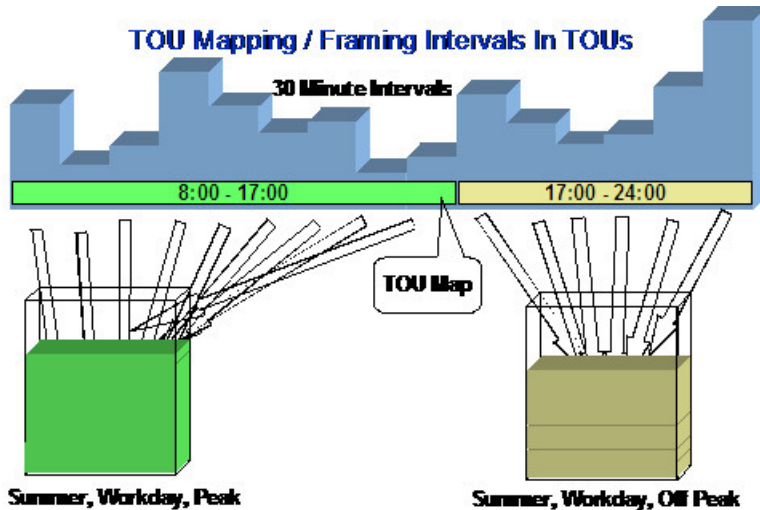

This type of data manipulation is typically handled using a calculation rule based on the 'math' calculation rule type.

Once the interval data curve values have been mapped to TOU periods, prices can be applied to the time of use period quantities using calculation rules based on the 'service quantity' calculation rule type.

Calculation Rules for TOU Mapping & Pricing

Calculation Rules are used to perform time of use mapping and time of use pricing.

Time of Use Mapping

Time of use mapping will be typically handled using a calculation rule based on the 'math' calculation rule type. Calculation rules of this type can perform many functions. Two examples include:

- Applying a TOU map to an interval data curve to produce service quantities that will be added to the bill segment's SQ collection.
- Applying a TOU map to a derived interval data curve. For example, after deriving the power factor curve, perform TOU mapping on the resultant curve.

For further details on the 'math' calculation rule type, refer to [Base Package Math Calculation Rule](#) for more information.

Time of Use Pricing

Time of use pricing will be typically handled using calculation rules based on the 'service quantity' calculation rule type. Calculation rules of this type can perform many functions. For example:

- Add or update a service quantity in the bill segments SQ collection
- Create bill calculations lines that levy charges based on some type of consumption. For example, applying a price to a specific service quantity in the bill segment's SQ collection

For further details on the 'service quantity' calculation rule type, refer to [Base Package Service Quantity Calculation Rule](#) for further information.

NOTE: Calculation rules are implemented using algorithms that contain the logic to be performed. If your implementation requires a new type of calculation rule, you can configure a new calculation rule type and reference the appropriate algorithm on it.

TOU Map Used For Mapping

An interval data curve is mapped into time-of-use periods using a TOU map. The TOU map used by the calculation rule for mapping interval data curve values to time of use periods is defined directly on the calculation rule.

Attributes of TOU Maps

TOU map types define attributes shared by TOU maps of a given type. The essential attributes of any TOU Map Type are the interval sizes between TOU map data rows, associated TOU map template(s) to use, and whether the TOU data will follow any seasonal time shifting.

Designing Your Time of Use (TOU) Mapping and Pricing Options

This section provides an overview for designing your control tables to support time of use (TOU) mapping and pricing with the new rating engine.

Designing Your Time Of Use (TOU) Mapping and Pricing Calculation Rules

As you know from the rates chapter, the system can handle mapping of interval data curve values into different time of use periods and pricing these quantities using the 'math' and 'service quantity' calculation rule types respectively. Refer to [Base Package Calculation Rule Descriptions](#) for more information.

The following guidelines provides a high level outline on how you should go about designing a rate schedule that involves time of use mapping and pricing.

- Obtain copies of existing bills that use the rate in question. If the rate is new, then write up exactly how the information should appear on the customers' printed bills.
- Identify all the lines that represent charges for individual time of use periods.
- Determine how the quantities for the time of use periods are calculated. Which time of use map is used to define the time periods?
- In order to perform time of use mapping and pricing, calculation rules need to be designed
 - A calculation rule based on the 'math' calculation rule type may be used to map an interval data curve into time of use periods. This calculation rule must know the TOU map to apply to the interval data curve to map into the relevant time of use periods. The time of use period quantities are populated in the bill segments SQ collection.
 - Calculation rules based on the 'service quantity' calculation rule type may be used to apply prices to each mapped time of use period quantity. These calculation rules each require either a price or regular bill factor for pricing each time of use period quantity. The bill factor may contain the price directly, or may indicate that the price is customer specific and can be found as contract quantities for the service agreement.

Once you have your calculation rules designed, you will be able to design the other control tables needed to set up your time of use billing customer.

Designing Your TOU Codes for TOU Mapping

The next most logical step in designing your time of use mapping controls is to define your time of use codes. To do this, look at the time of use periods to which your usage needs to be mapped. These values will likely correspond to the time of use quantities that your rate bills for. It should be noted that it's possible that will not bill for every time of use period.

Designing Your TOU Groups for TOU Mapping

To further aid in designing time of use mapping, the TOU Group enables you to group together all the time of use codes that are available to be used in a single map. You must also decide if you want to use a sequence number to define the relative order of a TOU code within a TOU group.

When TOU data is created for a TOU map, only TOU periods defined on a specified TOU group can be specified.

Designing Your TOU Map Types for TOU Mapping

Now that you have your TOU groups defined, you can begin defining TOU map types. Recall that the TOU map type defines the attributes that may be shared by TOU maps of the same type.

The essential attributes of any TOU Map Type are the interval sizes between TOU map data rows, associated TOU map template(s) to use, and whether the TOU data will follow any seasonal time shifting. Refer to [Designing Your Time Options](#) for more information.

TOU Map Type Interval Size

The interval size of a TOU map must divide evenly into the interval size of the interval data curve that uses the map (because the system joins the date/time of the interval data curve values to the date/time of the TOU data). This means that it is possible to use a 15 minute TOU map with a 60 minute interval data curve. However, it is not OK to have a 60 minute TOU map used with a 15 minute interval data curve because the join will miss 3 out of 4 interval data curve values.

TOU Map Type Override Template

While most TOU maps will use the TOU map template defined on the TOU map type, TOU maps also support override templates. Refer to [Designing Your TOU Map Templates](#) for TOU Mapping for more information.

- A TOU map's TOU map type defines the default TOU map template that's used to generate its TOU data.
- A TOU map's type defines the TOU map templates that can be referenced on individual TOU maps to override the default template.
- An individual TOU map can have override templates. If the TOU map doesn't have an override template, the default template defined on the TOU map type is used to generate the map's TOU data.

Refer to [Creating TOU Map Types](#) for further information.

Designing Your TOU Map Templates for TOU Mapping

In order to help your users to create and maintain data for TOU maps, you may define TOU map templates, which can be used to generate data for a TOU map. The templates may be used to define standard data for a TOU map as well as data for special periods, such as holidays. TOU map types reference TOU map templates.

Every TOU map references a TOU map template that defines the rules for generating TOU data from that TOU map. Specifically, TOU map templates define:

- The TOU group (defines the valid TOU periods for the template) used for the TOU map

- The default TOU period used for periods not explicitly defined. (This means you don't have to specify dates and times for all periods. For example, if your default TOU period is "Off Peak" you only need to define dates and days and times for On Peak or other TOU periods.)
- The specific date ranges, days of the week, and time periods designated for each TOU period. The system periodically generates TOU map data for TOU maps by interpreting the rules defined in the template.

Holidays

Many utilities categorize consumption on holidays differently than on the day of week on which the holiday falls. For example, holiday consumption might be categorized as Off-Peak regardless of the day it falls on. TOU map templates can define rules for different TOU periods for holidays by specifying the following:

- A Work Calendar that defines when holidays start and end
- Either:
 - A Holiday TOU period for consumption on holiday
 - A Holiday TOU Map Template that defines the TOU codes to use for different times in the year

TOU Map Template Interval Size

TOU map templates can also specify an interval size. This value specifies the duration of the individual TOU map data records, and also controls the values allowed in the Start and End Times. For example, if a TOU map template sets the interval size at 15 minutes, Start and End times must be in units of the interval size (10:00, 10:15, 10:30, etc.).

A TOU map template can be used to generate TOU map data for TOU maps whose interval size is divisible by the template's interval size. For example, a 60 minute template can be used to generate TOU data for TOU maps with an interval size of 60 minutes, 15 minutes, 5 minutes, etc. This means separate map templates are not needed for every interval size.

Refer to [Creating TOU Map Templates](#) for further information.

Setting Up Time of Use (TOU) Mapping and Pricing Control Tables

This section provides an overview of setting up your control tables to support time of use mapping and pricing with rates.

Creating TOU Map Templates

TOU map templates may be used to define standard data for a TOU map as well as data for special periods, such as holidays. TOU map types reference TOU map templates and used for TOU map data generation.

Prerequisites: You must define TOU groups and work calendars before you can create TOU map templates. Refer to the Oracle Utilities Application Framework online help for more information about creating work calendars.

To maintain existing TOU map templates, select **Admin > Usage > TOU Map Template > Search** then use standard actions to edit, duplicate, or delete a TOU map template.

To define a new TOU map template, follow these steps:

1. Select **Admin > Consumption > TOU Map Template > Add**. If your system supports more than one TOU map template business object, you will be prompted to select a business object for this TOU map template.
2. Enter a name and a meaningful description for the TOU map template.
3. Select the TOU group to be used by the TOU map template.
4. Select the default TOU for the TOU map template (from the TOU Group). This is the TOU used when creating TOU map data for dates not accounted for in the TOU Schedules section.

5. Select the work calendar for the TOU map template. Work calendars define the days of the week on which work is performed, and specify holidays.
6. Select the holiday TOU for the TOU map template (from the TOU Group).
7. Select the TOU map template used for holidays (if applicable).
8. Specify the interval size for TOU map data created from the map template. Interval size is designated as hours:minutes:seconds (HH:MM:SS)
9. To specify TOU schedule's date ranges and which TOUs should be used for this TOU map template, click the + or - sign in the TOU Schedule Section and enter or select the following:
 - Start and End Dates for a specific date range
 - Start and End Days of the Week: To add or remove Start and End Days of the Week pairs, click the + or - sign and select the appropriate weekdays
 - Start and End Times: To add or remove Start and End Times within a Start and End Days of the Week pair, click the + or - sign and enter the appropriate times
 - TOU
10. Click **Save**.

Now you can use the TOU map template when creating TOU types.

Creating TOU Map Types

An interval data curve is mapped into time-of-use periods using a TOU map. The TOU map used by the calculation rule for mapping interval data curve values to time of use periods is defined directly on the calculation rule. TOU map types define attributes shared by TOU maps of a given type.

Prerequisites: You must define TOU map templates and time zones before you can create TOU map types. Refer to the Oracle Utilities Application Framework online help for more information about creating time zones.

To maintain existing TOU map types, select **Admin > Consumption > TOU Map Type > Search** then use standard actions to edit, duplicate, or delete a TOU map type.

To define a new TOU map type, follow these steps:

1. Select **Admin > Consumption > TOU Map Type > Add**

NOTE: If your system supports more than one TOU map type business object, you will be prompted to elect a business object for this TOU map type.

2. Enter a name and a meaningful description for the TOU map type.
3. Select the business object to use when creating TOU maps of this type
4. Select the time zone for the TOU map type.
5. Specify the interval size for TOU map data created from the map type. Interval size is designated as hours:minutes:seconds (HH:MM:SS)
6. Select the default TOU map template for the TOU map type
7. To add or remove override TOU map templates for this TOU type, click the + or - sign in the Override TOU Map Templates section and select the TOU map template.
8. Click **Save**.

Now you can use the TOU map type when creating TOU maps.

Usage Subscription Types

Understanding Usage Subscription Types

Usage Subscription Types define a collection of properties defining a class of Usage Subscriptions. Usage Subscription types also control valid values for various attributes of Usage Subscriptions.

For a deeper functional understanding, refer to the [About Usage Subscriptions](#) or [About Usage Calculation](#) sections .

Configuring Usage Subscription Types

This portal is used to display and maintain a Usage Subscription Type.

Refer to [Understanding Usage Subscription Types](#) for more information.

You can access the portal by selecting **Admin**, then **Usage**, then **Usage Subscription Type**.

The following zones may appear as part of the portal's **Main** tab page:

- **Usage Subscription Type List:** displays all of the Usage Subscription Types so you can choose the one you want to display in more detail
- **Usage Subscription Type:** shows the specific configuration for the selected Usage Subscription Type

The Usage Subscription Type defines a number of lists for "valid" objects that can be used in conjunction with the overall usage calculation process:

- Valid Usage Recipients
- Valid Service Point Types
- Valid Usage Calculation Groups
- Valid Dynamic Option Types

Integrating Usage Transactions

Requesting Usage Transactions from External Systems

When Oracle Utilities Meter Data Management is deployed with Oracle Utilities Customer Care and Billing usage transactions can be created via a request from Oracle Utilities Customer Care and Billing.

To invoke a usage transaction request, Oracle Utilities Customer Care and Billing invokes a Usage Transaction Request Inbound service script which invokes the Usage Transaction Seeder (D2-UsgTranSeeder) business object. This business object does the following:

- Determines the usage subscription ID based on an external usage subscription ID
- Determines the appropriate usage transaction business object to create. This uses the "How To Create Usage Subscription Related Information" processing method defined for the "Usage Transaction Creation" processing role on the service provider that represents the external system.

For a deeper functional understanding of Usage Transactions, refer to the [About Usage Transactions](#) section of the *Oracle Utilities Meter Solution Business User Guide*.

Processing and Sending Usage Transactions to External Systems

When Oracle Utilities Meter Data Management is integrated with a customer information system (such as Oracle Utilities Customer Care and Billing), usage transaction information, including bill determinants and other data can be sent to the customer information system (again, such as Oracle Utilities Customer Care and Billing).

Usage transactions are sent to subscribing systems when they enter the "Sent" state. The "Send Usage" (D2-SEND-USG) Enter algorithm on the Sent state of the base package usage transaction business object (D2-UsageTransaction) determines the method used to send the information, based on the Usage Recipient (service provider) defined on the usage transaction's Usage Subscription. Usage transactions can be sent to service providers via either online real-time processing or periodically via batch processing.

Online Real-Time Processing

To set up the service provider to support online real-time notification of usage transactions, do the following:

- Create one or more Outbound Message Types that reference the outbound message business object to be used to send usage transaction information to the external system. The base package include the following business object for Usage Transaction Outbound Message (D2-UsageTranOutboundMesg).
- Define a Message Sender that will be used to send the message to the external system.
- Add the outbound message type to the service provider's External System and reference the Message sender created above.
- Add a processing method to the service provider as follows:
 - **Processing Role:** Usage Transaction Notification - Online
 - **Processing Method:** How To Send US Related Information
 - **Status:** Active
 - **Default Processing Method:**
 - **Outbound Message Type:** the outbound message type created above
 - **Override Processing Method:** outbound message types for specific usage subscription types if applicable

For a deeper understanding of integrating usage transactions with a customer information or Oracle Utilities Customer Care and Billing, refer to the [Configuring the Bill Determinant Interface](#) in the Interface section.

Batch Processing

If Oracle Utilities Meter Data Management is integrated with a customer information system (such as Oracle Utilities Customer Care and Billing) that requests bill determinants, usage transaction processing should be coordinated with the requesting system's billing process.

Requests from a billing system that have been indicated as "batch requests" (such as those produced by Oracle Utilities Customer Care and Billing batch billing process) accumulate in a "calculation deferred" state to be processed specially by the **Usage Transaction Calculate Defer Monitor** batch control (D2-UTCD).

To set up the service provider to support periodic batch processing of usage transactions, use a periodic monitor batch control. These batch programs should invoke the business objects that will contain the usage transaction information. The base package includes the following business object for this: Usage Transaction Outbound Message (D2-UsageTranOutboundMesg).

Next, setup the following configuration:

- Add a processing method to the service provider as follows:
 - **Processing Role:** Usage Transaction Notification - Batch

- **Processing Method:** How To Send US Related Information
- **Status:** Active
- **Default Processing Method:**
- **Batch Control:** the batch control created above
- **Override Processing Method:** batch controls for specific usage subscription types if applicable

Errors encountered when processing Usage Transactions can be reprocessed with the following batches:

- Reprocessing usage transaction "seeders" in error (D2-UTSED)
- Reprocessing usage transactions in error (D2-UTID)

If unexpected errors occur that leave usage transactions in an unmonitored state, the **Usage Transaction Monitor** batch control (D2-UT), or one based on this batch control with parameter values tailored to any specific requirements, can be used to process those usage transactions.

For a deeper functional understanding of Usage Transactions, refer to the [About Usage Transactions](#) section.

Generating Usage Transactions in Oracle Utilities Meter Data Management

There may be some cases where Usage Transactions should be generated in Oracle Utilities Meter Data Management rather than requested from an external system. Generation of these usage transactions are scheduled around the time when the meter installed on the service point is read.

Base product delivered a batch program that reads all pending measurement cycle schedule routes with selection date on or before the business date and creates as SP measurement cycle schedule route business object instance that stages the creation of these usage transactions.

For additional details refer to the D1-CSPSR batch control and D1-SPMrmtCycScheduleRoute business object.

Usage Transaction Exception Types

Understanding Usage Transaction Exception Types

Usage Transaction Exception Types define the groupings of exceptions for a Usage Transaction based on their functional similarity. This provides a way to define Usage Transaction Exceptions in a distinct enough way to understand the root issue that was generated from the usage calculation rule.

For a deeper functional understanding of Usage Calculation, refer to the [About Usage Calculation](#) section.

Configuring Usage Transaction Exception Types

This portal is used to display and maintain a Usage Transaction Exception Type.

Refer to [Understanding Usage Transaction Exception Types](#) for more information.

You can access the portal by selecting **Admin**, then **Usage**, then **Usage Transaction Exception Type**.

The following zones may appear as part of the portal's **Main** tab page:

- **Usage Transaction Exception Type List:** displays all of the Usage Transaction Exception Types so you can choose the one you want to display in more detail
- **Usage Transaction Exception Type:** shows the specific configuration for the selected Usage Transaction Exception Type

Usage Calculation Groups

Understanding Usage Calculation Groups

Usage calculation groups are collections of usage calculation rules that are used to either calculate bill determinants or validate bill determinants. During the usage transaction process, the system executes the usage calculation rules defined in the usage calculation group referenced on the usage subscription. The rules within a usage calculation group are defined in a specific sequence, allowing control over the order in which the rules are executed.

Usage calculation groups are associated with specific usage subscriptions and usage subscription types (or both). When assigned to usage subscriptions, usage calculation groups contain the usage calculation rules to be used to calculate usage / bill determinants. Usage calculation groups associated with usage subscription types are those groups considered valid for usage subscriptions of that type.

Usage calculation groups can also specify a list of device donfiguration types that are considered valid. Usage calculation groups should only be associated with usage subscriptions for service points related to device configurations of a valid device configuration type.

Usage calculation groups can also be referenced by the [Execute Usage Calculation Group](#) usage calculation rule.

For a deeper functional understanding of usage calculation, refer to the [About Usage Calculation](#) section.

Configuring Usage Calculation Groups

This portal is used to display and maintain a usage calculation group.

Refer to [Understanding Usage Calculation Groups](#) for more information.

You can access the portal by selecting **Admin**, then **Usage**, then **Usage Calculation Group**. You are brought to a query portal with options for searching. Once your record has been selected you are brought to the maintenance portal to view and maintain the selected record.

The following zones may appear as part of the portal's **Main** tab page:

- **Usage Calculation Group**: Defines basic information about usage calculation group
- **Usage Calculation Rules List**: lists the usage calculation rules belonging to the group
- **Referencing Usage Calculation Rules List**: lists the usage calculation rules that reference the group
- **Referencing Usage Subscription Type List**: lists the usage subscription types that reference the group
- **Referencing Usage Subscriptions List**: lists the usage subscriptions that reference the group

Usage Calculation Rules

Understanding Usage Calculation Rules

Usage calculation rules are standard and custom rules that perform calculations on measurement data to generate bill determinants and other values used by external systems, such as billing systems, customer information systems, etc. Usage calculation rules are created for a specific usage calculation group. For example, if you were configuring two usage calculation groups and both included a specific usage calculation rule, you would need to create two instances of the usage calculation rule, one for each group.

The base package includes rules that calculate common bill determinants including:

- Scalar reads
- Time-of-use consumption (by applying a time-of-use map to an interval channel)
- Interval curves (either real or derived)
- Virtually anything else that can be calculated from the information in the system

For a deeper functional understanding of usage calculation, refer to the [About Usage Calculation](#) section.

Usage Transaction Exceptions

On almost every usage calculation rule, the failure of the rule results in a usage transaction exception and the [Usage Transaction Exception Type](#) for the failure can be configured on the rule. These usage transaction exception types can also be set to a specific Exception Severity:

- **Information:** Used to highlight minor issues, but not sufficient to cause the usage transaction to be put into a failure state. Exceptions of this category can be used to report on the frequency of interesting, but not fatal issues
- **Issues:** Used to report a problem that will prevent the usage transaction from being sent. Multiple "issue exceptions" can be created during usage transaction processing. If at least one issue exists after all rules have been applied, the usage transaction is transitioned to a failure state requiring review and approval.
- **Terminate:** Used to report a severe issue that will cause the usage calculation process to stop and the usage transaction to be transitioned immediately to a failure state requiring review and approval. Only one terminate exception can be issued (as the first one causes calculation processing to stop on for a Usage Transaction). This should be used for cases where manual override / approval isn't accurate. For example, a "Curve Not Continuous" error that says the interval data doesn't cover the full usage period should always be set to Terminate as an Exception Severity.

Rounding Usage Transaction Service Quantities

Several usage calculation rules provide a means for defining the manner in which service quantities are rounded during usage calculations. Service quantity rounding can be defined using the **SQ Rounding Details** which allow configuration of the method by which quantities are rounded (Up, Down, or Nearest) and the number of decimal positions retained after rounding.

Creating Measurement Data Snapshots

Daily Scalar Calculation Rule, Get Interval, Get Item Counts and Consumption, and Get Scalar Details usage calculation rules can be configured to create measurement data snapshots during usage transaction processing. Measurement data snapshots are used by data aggregation in Market Settlements Management.

Measurement data snapshot configuration is done in the **Extract To Measurement Data Snapshots** section, and includes the following options:

- **Measurement Data Snapshot Type:** The measurement data snapshot type for measurement data snapshots created by the usage rule.
- **Usage Transaction ID To Use:** A flag that designates the type of ID to use to identify the usage transaction on the measurement data extract. Options include:
 - **Usage Transaction ID:** The usage transaction's ID
 - **Usage Transaction External ID:** The external ID for the usage transaction. Used when the usage transaction is triggered by external system such as a CIS (or by the billing functionality in Customer To Meter)
- **Extract To Different Usage Subscription:** A flag that designates whether or not the measurement data snapshot should be extracted to a different usage subscription, such as one used by Market Settlements Management. Options include:
 - **No:** The extract will reference the usage subscription for which usage calculations are being processed. This option is used when Meter Data Management and Market Settlements Management are installed in different application environments. In this case, the extract can be exported from Meter Data Management for subsequent import into Market Settlements Management.

- **Yes:** The extract will reference a different usage subscription such as one used by Market Settlements Management. This option is used when Meter Data Management and Market Settlements Management are installed in the same application environment. In this case, the measurement data snapshot is “exported” within the system to the Settlement Item, where it can be used in data aggregation processing. When this option is selected, the **Source Identifier Type** and **Target Identifier Type** fields must be configured to define how the system will determine the correct settlement usage subscription to use.
- **Irregular Data Flag Mapping:** Ranges of condition codes used to flag data as “irregular”. The value of the **Irregular Data Flag** (based on the IRREGULAR_DATA_FLG lookup) is used to flag data that falls with each range configured. A blank **Irregular Flag** value denotes that the condition range is considered to be "Regular".

See [About Measurement Data Snapshots](#) for more information about measurement data snapshot creation and processing.

Configuring Usage Calculation Rules

This portal is used to display and maintain a usage calculation rule.

Refer to [Understanding Usage Calculation Rules](#), [Understanding Usage Calculation Groups](#), and [Understanding Usage Transaction Exception Types](#) for more information.

You can access the portal by selecting **Admin**, then **Usage**, then **Usage Calculation Rule**. You are brought to a query portal with options for searching. Once your record has been selected you are brought to the maintenance portal to view and maintain the selected record.

The following zones may appear as part of the portal's **Main** tab page:

- **Usage Calculation Rule:** Defines the usage calculation rule, including parameters used when executing the rule
- **Eligibility Criteria List:** Lists the eligibility criteria defined for the rule

Pre-Calculation Usage Calculation Rules

The following is a list of the pre-calculation usage calculation rules provided as part of base product. For more information on how each rule executes and can be configured, follow the link provided on the rule.

Usage Calculation Rule Name	Applicable Data Type(s)	Purpose
Alignment and Delay Usage Calculation Rule	Interval or Scalar	This rule can be used to handle two main needs: 1) aligns all measuring components for a Usage Subscription to the same date (whether on the same device or separate devices) 2) delays the usage transaction until the end of the retry window based on the quality of available data and other configured parameters.
Check Existence of Installed Device	Interval or Scalar	This rule checks for the existence of a device installed on the Usage Subscription's Service Point for the usage period. In the case of multi-items this rule also checks that they are effective for the usage period.

Calculation Usage Calculation Rules

The following is a list of the calculation usage calculation rules provided as part of base product. For more information on how each rule executes and can be configured, follow the link provided on the rule.

Usage Calculation Rule Name	Applicable Data Type(s)	Purpose
Apply Math (Interval Data)	Interval	<p>This rule is used to perform calculations on interval data and stores the results in the usage transaction's service quantities. A variety of options are available on this rule that include defining the calculation type, variables to use, as well as the equation to use (math functions and expressions).</p> <p>This rule provides aggregated usage for all selected interval measuring components (filter by TOU, SQI & UOM) associated to a usage subscription.</p> <p>This rule can also multiply total usage by a factor using a custom formula.</p>
Coincident Peak and Individual SP Demand	Interval	<p>This rule is used to calculate the coincident peak demand for all of the service points on the usage subscription and the demand values for each service point at the coincident peak. The "coincident peak" is the time at which the combined values of multiple service points is the highest (which is not necessarily the peak for each individual service point).</p>
Daily Scalar Usage Calculation Rule	Scalar	<p>This rule is used to calculate usage of daily scalar measuring components installed in the Service Points associated with a Usage Subscription for the specified usage period. It creates bill determinants by taking the difference between the beginning and ending reading for the bill period.</p> <p>This rule can also be used to provide register readings by measuring component.</p> <p>For consumption values, only the beginning and ending readings are exported</p> <p>This rule supports date breaks (the normal Get Scalar Data rule does not).</p>
Get Interval Data	Interval	<p>This rule is used to get interval quantities from interval measuring components installed in the Service Points linked to the Usage Subscription for the specified 'Interval' usage period.</p> <p>This rule retrieves the interval data for measuring components associated to a usage subscription by TOU, SQI and UOM.</p> <p>This rule converts the interval data to another interval length or unit of measure.</p>

Get Item Counts and Consumption	Interval or Scalar	This rule finds item-based and multi-item-based Service Points linked to the Usage Subscription for the current usage transaction, summarizes the item counts by item type and Service Point, and calculates item-based consumption.
Get Scalar Details	Scalar	<p>This rule is used to get usage from scalar measuring components installed in the Service Points linked to the Usage Subscription for the specified 'Scalar' usage period.</p> <p>This rule creates bill determinants by summing all scalar readings for the bill period. This rule can also be used to provide register readings by measuring component. All readings are exported by this rule.</p> <p>Note: This rule is used for traditional monthly read meters.</p>
Get Subtractive Interval Details	Interval	<p>This rule is used to get interval quantities from subtractive interval measuring components installed on the service points linked to the usage subscription for the specified 'interval' usage period.</p> <p>It also identifies the start and stop readings for each usage period using subtractive interval readings.</p>
Get TOU Mapped Usage	Interval	This rule is used to get time of use quantities from interval measuring components for devices installed at the Service Points linked to the Usage Subscription for the specified 'Interval' usage period.
Interval Tier Calculation	Interval	<p>This rule calculates the difference between a source and reference vector.</p> <p>This rule loops through each tier that is configured and calculates the imbalance amount associated to that tier level.</p> <p>This rule breaks down that difference into one to many positive or negative tiers, and create a service quantity for each tier calculated.</p>
Profile Accumulation	Interval	This rule is used to manipulate a customer's interval data by adding other vectors to it. Those other vectors are derived from a list of profile factors and corresponding characteristic values stored in a list on the usage transaction.
Rolling Demand	Interval	This rule is used to calculate rolling demand for all of the service points on the usage subscription. Rolling demand can be based on a rolling consumption total, rolling consumption average, or coincident peak

demand. The "coincident peak" is the time at which the combined values of multiple service points is the highest (which is not necessarily the peak for each individual service point).

Round and Adjust Usage	Interval or Scalar	This rule copies identified source and target Service Quantities and inserts these as Service Quantities that are rounded and adjusted.
Vector and Service Quantity Math	Interval	<p>This rule is designed to facilitate configuration of complex vector calculations. It is based on a series of underlying services with vectors configured as input to the calculations.</p> <p>Typical uses:</p> <p>Perform math using interval data, e.g., take the difference between two curves, find max values, find coincident peaks, multiply a curve by a value, apply TOU maps, etc.</p> <p>Define complex formulas using various interval curves, profile factor values or calculated service quantities (bill determinant values).</p> <p>Support math functions: sin, cos, square root, etc.</p> <p>Store derived curves in memory that can be used in subsequent calculations</p> <p>Please note, this rule is not as efficient as other rules.</p>

Post-Calculation Usage Calculation Rules

Below is a list of the post-calculation usage calculation rules provided as part of base product. For more information on how each rule executes and can be configured, follow the link provided on the rule.

Usage Calculation Rule Name	Applicable Data Type(s)	Purpose
Usage High/Low Rule	Interval or Scalar	This rule compares the Service Quantities of the Usage Transaction to historical values. If the current value is too high or too low compared to historical data then an exception is thrown.
Validate Against Tolerance	Interval or Scalar	This rule is used to validate the calculated usage against a tolerance value. The tolerance value may either come from the specified value or tolerance factor defined in the usage calculation rule.
Business Flag Hold	Interval or Scalar	This rule can stop a usage transaction from proceeding when there have been business flags for the applicable service points. The hold can either be indefinite or set to expire

Decision-Making Usage Calculation Rules

There are usage calculation rules delivered as part of the base product that help with decision-making when executing running the usage calculation process. For more information on how each rule executes and can be configured, follow the link provided on the rule.

Usage Calculation Rule Name	Purpose
Execute Usage Calculation Group	This rule performs a call to execute a separate usage calculation group which includes execution of all usage calculation rules within that group.
Exception Handler	This rule is used to terminate execution of the usage processor if exception count criteria specified in the rule is met.

Advanced Aside: Using Factors For Variables

A situation common in some implementations involves converting one unit of measure (UOM) to another. However, the conversion factor used in conversions of this can differ based on many different types of criteria, such as the location of the service point or other characteristics. This sort of calculation can be implemented as a usage calculation rule that accumulates consumption for one UOM and converts the consumption to a different UOM by applying a factor to it.

Factors used for this purpose have a Factor Class of "Number," and use some unique rules:

- Number factors reference a characteristic type (with pre-defined values).
- Number factors reference an algorithm that retrieves or derives the value of the characteristic type at runtime.

Factor values for a Number factor are effective-dated pairings of a characteristic value and a corresponding value. Because these pairings are effective-dated, the value returned from the factor can change over time for each characteristic value. At run time, the rule retrieves / derives the characteristic value for the factor's characteristic type and then finds the value associated with the respective characteristic value. Factors can be related to any real or dynamic attribute, so rules of this type are very flexible. For example:

- **Real Attribute:** you could create a rule that retrieves a specific value based on the location of a service point.
- **Dynamic Attribute:** you could create a rule that retrieves a percentage value based on the amount the customer conserved as compared to the same period in the prior year, returning one value if the amount conserved is between 5% and 10%, another value if the amount conserved is between 10% and 20%, and yet a third value if the amount conserved is greater than 20%. The amount conserved is dynamically calculated at execution time and is compared to the characteristic values defined for the factor, and returns the appropriate value. In this example, if the amount conserved was anything less than 5%, no percentage value would be returned.

Pre-Calculation Usage Calculation Rules

Alignment and Delay Usage Calculation Rule

This rule attempts to delay usage calculation until high quality data for calculating bill determinants have become available. It is especially useful for usage subscriptions having multiple sources of usages such as multiple service points or multiple measuring components on the installed meter. The rule ensures that the usage calculated is based on a common date or alignment date, identified for these sources.

NOTE:

Additional detail on the logic of this rule can be found in the Detailed Description of the D2-ALGNDELAY Algorithm Type.

For help with the meaning of specific configuration fields, refer to the embedded help on the screen when adding or editing the rule.

Business Object

D2-AlignmentandDelay

Check Existence of Installed Device

This rule checks for the existence of a device installed on the Usage Subscription's Service Point for the usage period. In the case of multi-items this rule also checks that they are effective for the usage period.

NOTE:

Additional detail on the logic of this rule can be found in the Detailed Description of the D2-CHKEXTDVC Algorithm Type.

For help with the meaning of specific configuration fields, refer to the embedded help on the screen when adding or editing the rule.

Business Object

D2-ChkExistenceofInstalledDvc

Calculation Usage Calculation Rules**Apply Math (Interval Data)**

This rule is used to perform calculations on interval data and it stores the results in the usage transaction's service quantities. A variety of options are available on this rule that include defining the calculation type, variables to use, as well as the equation to use (math functions and expressions).

NOTE:

Additional detail on the logic of this rule can be found in the Detailed Description of the D2-APPMATHIN Algorithm Type.

For help with the meaning of specific configuration fields, refer to the embedded help on the screen when adding or editing the rule.

Business Object

D2-ApplyMathInt

Example Scenarios

Below are some example scenarios that can be achieved based on configuration of this rule.

Scenario 1: Get the total KWH for the period

Calculation Type = Single Variable

Variable Name = V1, where the following is configured:

- Variable Type = Channel Accumulation
- UOM = KWH
- Set Function = Sum

Scenario 2: Get the higher value between the total KWH or total KVARH

Calculation Type = Math Function

Math Function = Max

Variable Name = V1, where the following is configured:

- Variable Type = Channel Accumulation
- UOM = KWH
- Set Function = Sum

Variable Name = V2, where the following is configured:

- Variable Type = Channel Accumulation
- UOM = KVARH
- Set Function = Sum

Scenario 3: Total KWH multiplied with a factor value

Calculation Type = Mathematical Expression

Mathematical Expression = V1 * V2

Variable Name = V1, where the following is configured:

- Variable Type = Channel Accumulation
- UOM = KWH
- Set Function = Sum

Variable Name = V2, where the following is configured:

- Variable Type = Factor
- Factor = factor code that holds the multiplier

Daily Scalar Usage Calculation Rule

This rule is used to calculate usage of daily scalar measuring components installed in the Service Points associated with a Usage Subscription for the specified 'Interval' usage period. Only automatically read scalar measuring components with value identifier that matches usage calculation rule's UOM/TOU/SQI will be processed.

If configuring this rule with interval and scalar usage calculation rules under a usage calculation group, it should be executed after interval usage calculation rule and before the scalar usage calculation rule.

This rule calculates usage based on the beginning and ending reading values -- ignoring intermediate readings. This rule will not estimate data based on the usage transaction estimate flag. Frequently read scalar devices must use periodic estimation processes.

NOTE:

Additional detail on the logic of this rule can be found in the Detailed Description of the D2-GETFRESCR Algorithm Type.

For help with the meaning of specific configuration fields, refer to the embedded help on the screen when adding or editing the rule.

Business Object

D2-CalFrequentlyReadScalar

Get Interval Data

This rule is used to get interval quantities from interval measuring components installed in the service points linked to the usage subscription for the specified 'Interval' usage period. Only measuring components that match the UOM/SQI defined in the usage calculation rule are processed. Measurements within the period are stored in the usage transaction's service quantities' interval data list. The SQ entry's quantity is calculated based on the **Calculate Function** defined in the usage calculation rule. This is done for every entry in the usage period list. Each service quantity recorded by this rule is linked to a service point and measuring component.

By supplying the Axis Conversion parameters on the usage calculation rule, this algorithm will convert the identified measuring component's consumption into the supplied UOM and interval size prior to storing the consumption into the service quantity's interval data list.

NOTE:

Additional detail on the logic of this rule can be found in the Detailed Description of the D2-GETINTDAT Algorithm Type.

For help with the meaning of specific configuration fields, refer to the embedded help on the screen when adding or editing the rule.

Business Object

D2-GetIntervalData

Get Item Counts and Consumption

This rule finds item-based and multi-item-based Service Points linked to the Usage Subscription for the current usage transaction, summarizes the item counts by item type and Service Point, and calculates item-based consumption. Once the item detail entries are created, the rule processes goes through them to create usage period SQs.

NOTE:

Additional detail on the logic of this rule can be found in the Detailed Description of the D2-GETITEMCC Algorithm Type.

For help with the meaning of specific configuration fields, refer to the embedded help on the screen when adding or editing the rule.

Business Object

D2-GetItemCountsConsumption

Get Scalar Details

This rule is used to get usage from scalar measuring components installed in the Service Points linked to the Usage Subscription for the specified 'Scalar' usage period. By default all scalar measuring components are processed but if specific UOMs/TOUs/SQIs are defined in the usage calculation rule then only applicable measuring components are processed. Measurements within the period are retrieved. The usage transaction request may indicate whether or not 'Estimate' measurements are allowed.

The measurement details are stored in the usage transaction's scalar details. The usage is also stored in the usage transaction's service quantities unless otherwise specified in the usage calculation rule (using Build Service Quantity indicator).

This rule can be configured to perform measurement quality assessment, which will result in the population of the measurement quality list with the quantities and corresponding conditions of those measurements (regular, estimated, etc.).

Please note: this rule should not be used with readings occurring daily or more frequently as it will retrieve all of the readings to store in the Usage Transaction. The [Daily Scalar usage calculation rule](#) may be a better option for this use case.

NOTE:

Additional detail on the logic of this rule can be found in the Detailed Description of the D2-GETSCALAR Algorithm Type.

For help with the meaning of specific configuration fields, refer to the embedded help on the screen when adding or editing the rule.

Business Object

D2-GetScalar

Get Subtractive Interval Details

This rule is used to calculate the usage for a subtractive interval measuring components. This differs from the Get Interval Data usage calculation rule in that it also retrieves a start and stop reading for each usage period it calculates. The start and stop readings are then used to provide entries into the usage scalar details table which are then made available in the usage transaction sent to the billing system for bill presentment.

NOTE:

Additional detail on the logic of this rule can be found in the Detailed Description of the D2-SUBINTADJ Algorithm Type.

For help with the meaning of specific configuration fields, refer to the embedded help on the screen when adding or editing the rule.

Business Object

D2-GetSubtractiveInterval

Get TOU Mapped Usage

This rule is used to get time of use quantities from interval measuring components for devices installed at the Service Points linked to the Usage Subscription for the specified 'Interval' usage period. Only measuring components that match the UOM/SQI defined in the usage calculation rule instance are processed.

Measurements within the period are mapped to time of use quantities based on the TOU map defined on the usage calculation rule. If dynamic options are specified in the referenced TOU map and if there are dynamic option events in effect within the usage period then the TOU map associated with the dynamic option is used for the entire dynamic option event period. This calculation is performed for every usage period requested.

The calculated time of use quantities are stored in the usage transaction's service quantities per Service Point and measuring component.

NOTE:

Additional detail on the logic of this rule can be found in the Detailed Description of the D2-GETTOUUSG Algorithm Type.

For help with the meaning of specific configuration fields, refer to the embedded help on the screen when adding or editing the rule.

Business Object

D2-GetTOUUsage

Interval Tier Calculation

This rule calculates the difference between a source and reference vector. It then breaks that difference into one to many positive or negative tiers. For each tier calculated it will create a service quantity with the optional ability to create additional service quantities for the total of all positive tiers and the total of all negative tiers. This rule will loop through each tier that is configured and calculate the imbalance amount associated to that tier level.

NOTE:

Additional detail on the logic of this rule can be found in the Detailed Description of the D2-GETINTIER Algorithm Type.

For help with the meaning of specific configuration fields, refer to the embedded help on the screen when adding or editing the rule.

Business Object

D2-IntervalTierCalculation

Profile Accumulation

This rule is used to manipulate a customer's interval data by adding other vectors to it. Those other vectors are derived from a list of profile factors and corresponding characteristic values stored in a list on the usage transaction.

The typical application of this rule is for customer self-service rate compare, in which a self-service user has selected a set of usage adjustments to apply to their historical consumption to assess the effect on the amount consumed.

This rule algorithm retrieves the customer's usage (the source UOM) for the usage period using one of two options:

- A channel linked to a Usage Subscription
- A usage transaction service quantity

Then it takes each entry in the usage transaction's profile factor list, finds the profile measuring component for each, retrieves the measurement data for the profile, applies axis conversion to align it to the source UOM and target interval size, and adds it to the source vector. Each profile's data is added progressively to arrive at a final vector. The final vector may then be TOU-mapped, and the vector itself may be preserved or discarded.

NOTE:

Additional detail on the logic of this rule can be found in the Detailed Description of the D2-DYNPRFLAC Algorithm Type.

For help with the meaning of specific configuration fields, refer to the embedded help on the screen when adding or editing the rule.

Business Object

D2-ProfileAccumulation

Profile Service Quantity

This rule intervalizes scalar service quantity values based on a profile measuring component.

This rule first retrieves scalar service quantities, identified by the rule's UOM/TOU/SQI. If multiple service quantities exist for the service point they will be summarized at the service point level. In the case of a split or broken usage period for a service point, the usage period is merged and the quantities are summarized. Each service quantity is subject to intervalization. The profile measuring component is then derived using the profile factor supplied with either the usage

subscription or service point as characteristic sources. If the profile is not available, an exception will be created using the exception details on the rule.

If a dynamic option type is provided, the events associated with it are retrieved for the usage transaction period. Any intervalized quantities that coincide with the dynamic option events start/end date time are then recorded in a new usage period service quantity of usage type "Correlated SQ".

If no dynamic option type is provided, the intervalized quantities are recorded in a new usage period service quantity of usage type "Profile SQ".

NOTE:

Additional detail on the logic of this rule can be found in the Detailed Description of the D2-PRFSVCQTY Algorithm Type.

For help with the meaning of specific configuration fields, refer to the embedded help on the screen when adding or editing the rule.

Business Object

D2-ProfileServiceQuantity

Rolling Demand

This rule is used to calculate rolling demand for all of the service points on the usage subscription. Demand is calculated from consumption. In electric service markets, these are typically represented by kilowatts (kW) and kilowatt hours (kWh) respectively, where demand values are calculated by multiplying consumption interval values by the number of intervals per hour. For example, the demand associated with a fifteen (15) minute interval value of 25kWh would be 100kW (25 x 4 intervals per hour).

This rule has two main modes: calculating rolling demand for a usage subscription based on either a rolling consumption total (Total) or rolling consumption average (Average), or calculating the coincident peak among all of the service points on a usage subscription based on either a rolling consumption total (Total - Coincident Peak) or rolling consumption average (Average - Coincident Peak). The coincident peak calculation can be performed on either all readings, or those designated as "on-peak" or "off-peak" via time of use mapping using the Coincident On-Peak or Coincident Off-Peak function, See [Defining Time of Use Mapping Options](#) for more information about time of use mapping.

The number of intervals in the rolling total or rolling average is determined via rule configuration. The **Roll Interval Size** parameter (in the **Calculation Details** section) divided by the **Common Interval Size** parameter (in the **Interval Data Retrieval Parameters** section). For example, if **Roll Interval Size** was 01:00:00 (1 hour) and the **Common Interval Size** was 00:15:00 (15 minutes), the rolling total or average would be based on sets of 4 intervals (1 hour divided by 15 minutes).

Rolled Demand Total

The "Rolled Demand Total" **Roll Calculate Function** identifies the peak demand for the usage subscription based on a rolling consumption total.

For example, the table below lists sample hourly interval data for two service points belonging to single usage subscription for a 12 hour calculation period. This table includes the following:

- **Date/Time:** The date and time of each interval
- **Service Point n:** The kWh value for each interval at a specific service point
- **Total:** The combined total of consumption at the usage subscription's service points
- **Rolling Total:** The rolling total of 4 total values (based on a **Roll Interval Size** of 01:00:00 (1 hour) and **Common Interval Size** of 00:15:00 (15 minutes))
- **Demand:** The demand calculated from the rolling total (calculated by multiplying the running total by the number of intervals per hour - in this example the total is the same as the demand because this is hourly data).

This rule would identify the highest demand for the usage subscription during the calculation period (indicated in **bold**).

Date/Time	Service Point 1	Service Point 2	Total	Rolling Total	Demand
10/27/2022 12:00 PM	12	11	23		
10/27/2022 1:00 PM	10	12	22		
10/27/2022 2:00 PM	11	13	24		
10/27/2022 3:00 PM	13	13	26	95	95
10/27/2022 4:00 PM	14	14	28	100	100
10/27/2022 5:00 PM	13	13	26	104	104
10/27/2022 6:00 PM	12	13	25	105	105
10/27/2022 7:00 PM	11	12	23	102	102
10/27/2022 8:00 PM	12	13	25	99	99
10/27/2022 9:00 PM	13	14	27	100	100
10/27/2022 10:00 PM	12	14	26	101	101
10/27/2022 11:00 PM	12	12	24	102	102

This rule would return the following values in the usage transaction service quantities list, which represents the peak demand value during the calculation period:

Date/Time	Demand
10/27/2022 6:00 PM	105

Note: This option should be used for information and reporting purposes only. These values cannot be used for billing purposes.

Rolled Demand Total - Coincident Peak / Rolled Demand Total - Coincident On Peak / Rolled Demand Total - Coincident Off Peak

The "Rolled Demand Total - Coincident Peak / Rolled Demand Total - Coincident On Peak / Rolled Demand Total - Coincident Off Peak" **Roll Calculate Function** identify the coincident peak demand for all of the service points on the usage subscription. The "coincident peak" is the time at which the combined values of multiple service points is the highest (which is not necessarily the peak for each individual service point). The coincident peak demand is the demand based on the rolling total at the coincident peak.

The data used in the calculation is based on the specific **Roll Calculate Function** selected:

- **Total - Coincident Peak:** Evaluates all measurements matching the configured unit of measure
- **Total - Coincident On Peak:** Evaluates measurements matching the configured unit of measure that falls with the "on peak" TOU period defined in the **Results** section based on a specified TOU Map Template.
- **Total - Coincident Off Peak:** Evaluates measurements matching the configured unit of measure that falls with the "off peak" TOU period defined in the **Results** section based on a specified TOU Map Template.

For example, the table below lists sample hourly interval data for two service points belonging to single usage subscription for a 12 hour calculation period. This table includes the following:

- **Date/Time:** The date and time of each interval
- **Service Point n:** The kWh value for each interval at a specific service point
- **Total:** The combined total of consumption at the usage subscription's service points
- **Rolling Total:** The rolling total of 4 total values (based on a **Roll Interval Size** of 01:00:00 (1 hour) and **Common Interval Size** of 00:15:00 (15 minutes))
- **Demand:** The demand calculated from the rolling total (calculated by multiplying the running total by the number of intervals per hour - in this example the total is the same as the demand because this is hourly data).

This rule would identify the highest total for all of the service points within the calculation period (indicated in **bold**).

Date/Time	Service Point 1	Service Point 2	Total	Rolling Total	Demand
10/27/2022 12:00 PM	12	11	23		
10/27/2022 1:00 PM	10	12	22		
10/27/2022 2:00 PM	11	13	24		
10/27/2022 3:00 PM	13	13	26	95	95
10/27/2022 4:00 PM	14	14	28	100	100
10/27/2022 5:00 PM	13	13	26	104	104
10/27/2022 6:00 PM	12	13	25	105	105
10/27/2022 7:00 PM	11	12	23	102	102
10/27/2022 8:00 PM	12	13	25	99	99
10/27/2022 9:00 PM	13	14	27	100	100
10/27/2022 10:00 PM	12	14	26	101	101
10/27/2022 11:00 PM	12	12	24	102	102

This rule would return the following values in the usage transaction service quantities list, which represent the demand at the coincident peak:

Date/Time	Coincident Peak Demand
10/27/2022 4:00 PM	100

Note: This option should be used for information and reporting purposes only. These values cannot be used for billing purposes.

Rolled Demand Average

The "Rolled Demand Average" **Roll Calculate Function** identifies the peak demand for the usage subscription based on a rolling average (calculated from the rolling total).

For example, the table below lists sample hourly interval data for two service points belonging to single usage subscription for a 12 hour calculation period. This table includes the following:

- **Date/Time:** The date and time of each interval
- **Service Point n:** The kWh value for each interval at a specific service point
- **Total:** The combined total of consumption at the usage subscription's service points
- **Rolling Total:** The rolling total of 4 total values (based on a **Roll Interval Size** of 01:00:00 (1 hour) and **Common Interval Size** of 00:15:00 (15 minutes))
- **Rolling Average:** The rolling average of 4 total values (based on a **Roll Interval Size** of 01:00:00 (1 hour) and **Common Interval Size** of 00:15:00 (15 minutes))
- **Demand:** The demand calculated from the rolling average (calculated by multiplying the rolling average by the number of intervals per hour - in this example the total is the same as the demand because this is hourly data).

This rule would identify the highest demand for the usage subscription during the calculation period (indicated in **bold**).

Date/Time	Service Point 1	Service Point 2	Total	Rolling Total	Rolling Average	Demand
10/27/2022 12:00 PM	12	11	23			
10/27/2022 1:00 PM	10	12	22			
10/27/2022 2:00 PM	11	13	24			

Date/Time	Service Point 1	Service Point 2	Total	Rolling Total	Rolling Average	Demand
10/27/2022 3:00 PM	13	13	26	95	23.75	23.75
10/27/2022 4:00 PM	14	14	28	100	25	25
10/27/2022 5:00 PM	13	13	26	104	26	26
10/27/2022 6:00 PM	12	13	25	105	26.25	26.25
10/27/2022 7:00 PM	11	12	23	102	25.5	25.5
10/27/2022 8:00 PM	12	13	25	99	24.75	24.75
10/27/2022 9:00 PM	13	14	27	100	25	25
10/27/2022 10:00 PM	12	14	26	101	25.25	25.25
10/27/2022 11:00 PM	12	12	24	102	25.5	25.5

This rule would return the following values in the usage transaction service quantities list, which represents the peak demand value during the calculation period:

Date/Time	Demand
10/27/2022 6:00 PM	26.25

Note: This option should be used for information and reporting purposes only. These values cannot be used for billing purposes.

Rolled Demand Average - Coincident Peak / Rolled Demand Average - Coincident On Peak / Rolled Demand Average - Coincident Off Peak

The "Average - Coincident Peak / Average - Coincident On-Peak / Average - Coincident Off-Peak" **Calculate Function** identify the coincident peak demand for all of the service points on the usage subscription. The "coincident peak" is the time at which the combined values of multiple service points is the highest (which is not necessarily the peak for each individual service point). The coincident peak demand is the demand based on the rolling average at the coincident peak.

The data used in the calculation is based on the specific **Roll Calculate Function** selected:

- **Rolled Demand Total - Coincident Peak:** Evaluates all measurements matching the configured unit of measure
- **Rolled Demand Total - Coincident On Peak:** Evaluates measurements matching the configured unit of measure that falls with the "on peak" TOU period defined in the **Results** section based on a specified TOU Map Template.
- **Rolled Demand Total - Coincident Off Peak:** Evaluates measurements matching the configured unit of measure that falls with the "off peak" TOU period defined in the **Results** section based on a specified TOU Map Template.

For example, the table below lists sample hourly interval data for two service points belonging to single usage subscription for a 12 hour calculation period. This table includes the following:

- **Date/Time:** The date and time of each interval
- **Service Point n:** The kWh value for each interval at a specific service point
- **Total:** The combined total of consumption at the usage subscription's service points
- **Rolling Total:** The rolling total of 4 total values (based on a **Roll Interval Size** of 01:00:00 (1 hour) and **Common Interval Size** of 00:15:00 (15 minutes))
- **Rolling Average:** The rolling average of 4 total values (based on a **Roll Interval Size** of 01:00:00 (1 hour) and **Common Interval Size** of 00:15:00 (15 minutes))

- **Demand:** The demand calculated from the rolling average (calculated by multiplying the rolling average by the number of intervals per hour - in this example the total is the same as the demand because this is hourly data).

This rule would identify the highest demand for the usage subscription during the calculation period (indicated in **bold**).

Date/Time	Service Point 1	Service Point 2	Total	Rolling Total	Rolling Average	Demand
10/27/2022 12:00 PM	12	11	23			
10/27/2022 1:00 PM	10	12	22			
10/27/2022 2:00 PM	11	13	24			
10/27/2022 3:00 PM	13	13	26	95	23.75	23.75
10/27/2022 4:00 PM	14	14	28	100	25	25
10/27/2022 5:00 PM	13	13	26	104	26	26
10/27/2022 6:00 PM	12	13	25	105	26.25	26.25
10/27/2022 7:00 PM	11	12	23	102	25.5	25.5
10/27/2022 8:00 PM	12	13	25	99	24.75	24.75
10/27/2022 9:00 PM	13	14	27	100	25	25
10/27/2022 10:00 PM	12	14	26	101	25.25	25.25
10/27/2022 11:00 PM	12	12	24	102	25.5	25.5

This rule would return the following values in the usage transaction service quantities list, which represents the peak demand value during the calculation period:

Date/Time	Demand
10/27/2022 4:00 PM	25

Note: This option should be used for information and reporting purposes only. These values cannot be used for billing purposes.

Notes and Recommendations

- When using the "Coincident On Peak" or "Coincident Off Peak" **Roll Calculate Function**, you must specify either a TOU map (in the **TOU Map** field) or a TOU map template (in the **On Peak Off Peak Schedule** drop-down list) in the **Calculation Details** section, and specify the appropriate time of use period (On-Peak or Off-Peak, respectively) in the **TOU** field in the **Results** section.
- A recommended practice is to configure a Service Quantity Identifier (SQI) to uniquely identify coincident peak data and specify it in the **SQI** field in the **Results** section.

Note: Additional detail on the logic of this rule can be found in the **Detailed Description** of the D1-CALROLDDEM Algorithm Type.

For help with the meaning of specific configuration fields, refer to the embedded help on the screen when adding or editing the rule.

Business Object

D1-CalcRollingDemandRule

Example Scenarios

Below are some example scenarios that can be achieved based on configuration of this rule.

Scenario 1: Calculate demand for services points based on rolling total

- **Interval Data Retrieval Parameters:**
 - **UOM:** Kilowatt-Hour
 - **Common Interval Size:** 00:15:00
- **Calculation Details:**
 - **Roll Calculate Function:** Rolled Demand Total
 - **Roll Interval Size:** 01:00:00
- **Results:**
 - **UOM:** Kilowatt
 - **TOU:**
 - **SQI:**

Scenario 2: Calculate demand for services points based on rolling average

- **Interval Data Retrieval Parameters:**
 - **UOM:** Kilowatt-Hour
 - **Common Interval Size:** 00:15:00
- **Calculation Details:**
 - **Roll Calculate Function:** Rolled Demand Average
 - **Roll Interval Size:** 01:00:00
- **Results:**
 - **UOM:** Kilowatt
 - **TOU:**
 - **SQI:**

Scenario 3: Total - Coincident Peak

- **Interval Data Retrieval Parameters:**
 - **UOM:** Kilowatt-Hour
 - **Common Interval Size:** 00:15:00
- **Calculation Details:**
 - **Roll Calculate Function:** Rolled Demand Total, Coincident Peak
 - **Roll Interval Size:** 01:00:00
- **Results:**
 - **UOM:** Kilowatt
 - **TOU:**
 - **SQI:** Coincident Peak

Scenario 4: Average - Coincident On Peak

- **Interval Data Retrieval Parameters:**

- **UOM:** Kilowatt-Hour
- **Calculation Details:**
 - **Roll Calculate Function:** Rolled Demand Average, Coincident, On Peak
 - **Roll Interval Size:** 01:00:00
 - **Reference TOU Map by Template:** Yes
 - **On Peak Off Peak Schedule:** <TOU map template>
- **Results:**
 - **UOM:** Kilowatt
 - **TOU:** On Peak
 - **SQI:** Coincident On Peak

Round and Adjust Usage

This rule copies identified source and target Service Quantities and inserts these as period Service Quantities that are rounded and adjusted. This rule captures the source and target Service Quantity identifiers, rounding method, and Service Quantity bucket to hold the adjustment. The usage calculation rule also has an option to validate the difference between the source and target service quantities.

NOTE:

Additional detail on the logic of this rule can be found in the Detailed Description of the D2-RNDADJUSG Algorithm Type.

For help with the meaning of specific configuration fields, refer to the embedded help on the screen when adding or editing the rule.

Business Object

D2-RoundAndAdjustUsage

Vector and Service Quantity Math

This rule is designed to facilitate configuration of complex vector and scalar quantity calculations. It is based on a series of underlying services, including Axis Conversion, Apply Formula (most importantly), and Apply TOU Map. It can be configured to accept as input up to five vectors - where a single vector can represent the combination of all measuring components with linkages to the Usage Subscription with the configured UOM/SQI. It can also accept a list of scalar variables that can be taken in as factor values, usage transaction service quantities, set functions on a vector, or numeric values.

Vectors can be combined using a simple formula expression, or using condition formula expressions. Both interval values and interval conditions can be referenced. The result is interval-by-interval processing of the vector formula. The resulting final vector can be stored, TOU mapped, and/or subjected to a final set function (such as sum or max).

This rule stores service quantities of type "other" - meaning that the service quantities created by this rule do not have linkages to a specific Service Point or measuring component, given the potentially diverse sources of the data taken as input by this rule that lead to the final quantity.

NOTE:

Additional detail on the logic of this rule can be found in the Detailed Description of the D2-MATH Algorithm Type.

For help with the meaning of specific configuration fields, refer to the embedded help on the screen when adding or editing the rule.

Business Object

D2-Math

Post-Calculation Usage Calculation Rules

Usage High/Low Rule

This rule is used to validate the current usage against historical usage - previous year usage or previous usage. It ensures that any increase or decrease of the current usage relative to historical usage is within a tolerance.

NOTE:

Additional detail on the logic of this rule can be found in the Detailed Description of the D2-USGHIGLOW Algorithm Type.

For help with the meaning of specific configuration fields, refer to the embedded help on the screen when adding or editing the rule.

Business Object

D2-UsageHighLowRule

Validate Against Tolerance

This rule is used to validate the calculated usage against a tolerance value. The tolerance value may either come from the specified value or tolerance factor defined in the usage calculation rule.

NOTE:

Additional detail on the logic of this rule can be found in the Detailed Description of the D2-VALUSGTOL Algorithm Type.

For help with the meaning of specific configuration fields, refer to the embedded help on the screen when adding or editing the rule.

Business Object

D2-ValAgainstTol

Business Flag Hold

This rule can be used to place a hold on a usage transaction until the business flags related to the usage transactions service points can be investigated. The hold can be placed in one of two ways:

- **Calculation Window Based:** holds will remain until either a user manually bypasses the usage exception error or the current date is within a configurable tolerance of the calculation window end (aka the retry until date time).
- **Indefinite:** holds require a user to manually bypass the usage exception that is generated.

Defining which business flags should result in a usage transaction is a matter of identifying which business flag types, priorities, and confidences should be included.

NOTE:

Additional detail on the logic of this rule can be found in the Detailed Description of the D2-AUR-IBFH algorithm type.

For help with the meaning of specific configuration fields, refer to the embedded help on the screen when adding or editing the rule.

Business Object

D2-BusinessFlagHold

Decision-Making Usage Calculation Rules

Execute Usage Calculation Group

This rule performs a call to execute a separate usage calculation group which includes execution of all usage calculation rules within that group. It is especially useful in cases where repeating the same rule over and over would be hard to maintain.

For example, you may want to calculate a straightforward kWh sum for every usage calculation group. Creating a separate CALC_KWH_SUM usage calculation group for this one calculation allows you to isolate the configuration points. Then the CALC_KWH_SUM usage calculation group can be referenced in every other usage calculation group that needs this sort of service quantity.

NOTE:

Additional detail on the logic of this rule can be found in the Detailed Description of the D1-AUSGR-RFG Algorithm Type.

For help with the meaning of specific configuration fields, refer to the embedded help on the screen when adding or editing the rule.

Business Object

D1-UsageRuleReferredUsageGroup

Exception Handler

This rule evaluates the exception list that was accumulated during the execution of the calculation rules against exception criteria configured on this rule. This used to terminate the execution of usage calculation group processor if there are far too many exceptions hit during the execution.

NOTE:

Additional detail on the logic of this rule can be found in the Detailed Description of the D2-UREXPCHAN Algorithm Type.

For help with the meaning of specific configuration fields, refer to the embedded help on the screen when adding or editing the rule.

Business Object

D2-UsageRuleExceptionHandler

Detailed Configuration Examples

Demand Calculation Options Using Interval Data

There are a number of ways to calculate a demand value from interval data when retrieving bill determinants for CIS. A few examples of demand calculations are listed below:

Scenario 1: Use interval data for demand at a common block size: the [Vector and Service Quantity Math](#) usage calculation rule can be used to calculate demand from the interval data. Below is one example of configuration to handle demand calculation based on 30 minute blocks:

Usage Calculation Rule field	Value	Notes
Vector 1 // Type	Physical Channels Links to Usage Subscription	
Vector 1 // Unit of Measure	Kilowatt-Hours	Use your own UOM here - this is just as example.
Vector 1 // Service Quantity Identifier	Consumed	Use your own SQI here - this is just as example.
Vector Processing // Common Interval Size	00:30:00	This configuration rolls up all channels (whether 5 minute, 15 minute, or 30 minute interval data) into a common interval size.
Vector Processing // Vector Formula Source	Simple Vector Formula	
Vector Processing // Simple Vector Formula	IV1*2	This is multiplying the common 30 minute interval size by 2 to achieve an hourly value.
Result // Unit of Measure	Kilowatts	Use your own UOM here - this is just as example.
Result // Service Quantity Identifier	Consumed	Use your own SQI here - this is just as example.
Result // Insert Primary SQ Entry	Yes	
Result // SQ Entry Quantity Source	Set Function Against Derived Vector	
Result // Set Function Against Derived Vector	Max	This function pulls the max value based on the configuration in the "Vector Processing" section.

Scenario 2: Use interval data for demand by TOU period: This example is very similar to the last and again leverages the [Vector and Service Quantity Math](#) usage calculation rule. However, instead of calculating a single demand value for the entire period it will calculate a demand value for each TOU period:

Usage Calculation Rule field	Value	Notes
Vector 1 // Type	Physical Channels Links to Usage Subscription	
Vector 1 // Unit of Measure	Kilowatt-Hours	Use your own UOM here - this is just as example.
Vector 1 // Service Quantity Identifier	Consumed	Use your own SQI here - this is just as example.

Vector Processing // Common Interval Size	00:30:00	This configuration rolls up all channels (whether 5 minute, 15 minute, or 30 minute interval data) into a common interval size.
Vector Processing // Vector Formula Source	Simple Vector Formula	
Vector Processing // Simple Vector Formula	IV1*2	This is multiplying the common 30 minute interval size by 2 to achieve an hourly value.
Result // Unit of Measure	Kilowatts	Use your own UOM here - this is just as example.
Result // Service Quantity Identifier	Consumed	Use your own SQI here - this is just as example.
Result // Insert Primary SQ Entry	No	
Result // Apply TOU Map To Derived Vector	Yes	
Result // TOU Map	(your TOU Map)	Select the TOU Map you'd like to apply.
Result // Time Of Use Calculate Function	Max	This function pulls the max value based on the configuration in the "Vector Processing" section and then buckets it based on the selected TOU Map.

Usage Calculation Types

Understanding Usage Calculation Types

Usage calculation types define calculations executed at a customer level where there may be more than one calculation per usage subscription. For example, a customer may have a usage subscription for producing billing determinants but there may be additional calculations that will be executed on a much less frequent basis (annually, quarterly, etc). Usage calculation types provide a way to leverage a single usage subscription to drive multiple different calculations.

Usage calculation types use the following parameters:

- **Request Type:** Used to drive the creation and processing of the usage transactions for all usage subscriptions that are valid for the usage calculation type.

NOTE: Request types for usage calculation types should be based on the Usage Calculation Request Type business object (D2-UsageCalculationReqType)

- **Service Point Quantity Creation:** Details of the quantities created by usage calculations of this type, including service point quantity type, and UOM, TOU, and SQI.
- **Applicable Usage Subscription Types:** A list of usage subscription types for which this usage calculation type is applicable. Each usage subscription type is defined by an effective date range, the usage transaction business object used for the usage calculation, the result UOM/TOU/SQI, and the usage calculation group used to perform the calculations.

Configuring Usage Calculation Types

You use the **Usage Calculation Type** portal to maintain and view usage calculation types.

Refer to [Understanding Usage Calculation Types](#) for more information.

You can access the portal by selecting **Admin**, then **Usage**, then **Usage Calculation Type**.

The following zones may appear as part of the portal's **Main** tab page:

- **Usage Calculation Type List:** This zone lists all usage calculation type records. Broadcast a record to display the details of the selected record.
- **Usage Calculation Type:** This zone displays details for the selected usage calculation type.

Usage Subscription Quantity Types

Understanding Usage Subscription Quantity Types

Usage subscription quantity types define types of quantities that can be stored for a usage subscription. These quantity types are often infrequently calculated descriptors of a given customer and how they relate, at an aggregate level, to either the customer base as a whole or their particular rate class. For example, a customer quantity may be used to store a scaling factor that describes how a given customer's usage compares to the profiled usage for their rate class.

In a settlement implementation, usage subscription quantity types can be used to define values calculated monthly, annually, etc., such as annual peak load contribution (PLC).

Usage subscription quantity types use the following parameters:

- **Service Type:** The service type (electric, gas, water, etc.) for service point quantities of this type.
- **Usage Subscription Quantity Business Object:** The business object used for usage subscription quantities of this type.
- **Usage Subscription Quantity Identifiers:** Value identifiers related to the current usage subscription quantity type (used to provide shorthand descriptions of the various types of values measured by usage subscription quantities of this type).

Configuring Usage Subscription Quantity Types

You use the **Usage Subscription Quantity Type** portal to display and maintain usage subscription quantity types.

Refer to [Understanding Usage Subscription Quantity Types](#) for more information.

You can access the portal by selecting **Admin**, then **Usage**, then **Usage Subscription Quantity Type**.

The following zones may appear as part of the portal's **Main** tab page:

- **Usage Subscription Quantity Type List:** This zone lists all usage subscription quantity type records. Broadcast a record to display the details of the selected record.
- **Usage Subscription Quantity Type:** This zone displays details for the selected usage subscription quantity type.

Dynamic Option Types

Understanding Dynamic Option Types

Dynamic options specify terms that override how usage is normally calculated, such as a critical peak period that affects the TOU mapping of interval consumption. Dynamic option types store information common to dynamic options of a specific type.

There are two classes of dynamic options:

- **Interval Set:** Used to represent dynamic option types that provide a set of intervals that will be included in a calculation.

- **Usage Event:** Used to represent dynamic option types that provide a specific period of time during which a dynamic option is applicable.

Interval Set dynamic option types also define key information about the interval data they represent, including:

- **Unit of Measure:** Identifies the quantity that Interval Set dynamic options and Interval Set dynamic option events based on this type are measuring.
- **Interval Size:** Defines the size of the intervals for Interval Set dynamic option events of this type, represented as hours:minutes:seconds (HH:MI:SS).

Configuring Dynamic Option Types

This portal is used to display and maintain a Dynamic Option Type.

Refer to [Understanding Dynamic Option Types](#) for more information.

You can access the portal by selecting **Admin**, then **Usage**, then **Dynamic Option Type**.

The following zones may appear as part of the portal's **Main** tab page:

- **Dynamic Option Type List:** displays all of the Dynamic Option Types so you can choose the one you want to display in more detail
- **Dynamic Option Type:** shows the specific configuration for the selected Dynamic Option Type

Bill Cycle

Understanding Bill Cycle

Bill cycle identifies window period when a customer is going to be billed and when the bill determinants are going to be calculated.

Configuring Bill Cycle

This portal is used to display and maintain a Bill Cycle.

Refer to [Understanding Bill Cycle](#) for more information.

You can access the portal by selecting **Admin**, then **Usage**, then **Bill Cycle**.

The following zones may appear as part of the portal's **Main** tab page:

- **Bill Cycle List:** displays all of the Bill Cycles so you can choose the one you want to display in more detail.
- **Bill Cycle:** shows the specific configuration for the selected Bill Cycle.
- **Bill Cycle List:** lists the bill cycle schedules of the current bill cycle.

Defining Time of Use Mapping Options

Time of Use Groups

Understanding Time of Use Groups

Time of Use (TOU) Groups are groups of TOUs that are associated to TOU templates that limit the TOUs available for use in a TOU schedule. These TOUs will be available as the default, holiday, and schedule TOUs within the template.

Each TOU in the group is given a priority. The priority is important in a few ways:

- The [TOU Overlay](#) 360 Degree zone uses these priorities to decide which TOUs will be rendered as a unique shade and which will fall into a category of "other" when the maximum number of distinct TOUs to graph has been reached.
- These priorities are available for use in customized logic.

Configuring Time of Use Groups

This portal is used to display and maintain a TOU Group.

Refer to [Understanding Time of Use Groups](#) for more information.

You can access the portal by selecting **Admin**, then **Usage**, then **TOU Group**.

The following zones may appear as part of the portal's **Main** tab page:

- **TOU Group List:** This zone lists all TOU Group records. Broadcast a record to display the details of the selected record.
- **TOU Group:** This zone provides information about the selected TOU Group.

Time of Use Map Templates

Understanding Time of Use Map Templates

Every TOU map references a TOU map template that defines the rules for generating TOU data from that TOU map. Specifically, TOU map templates define:

- The TOU group (defines the valid TOU periods for the template) used for the TOU map
- The default TOU period used for periods not explicitly defined. (This means you don't have to specify dates and times for all periods. For example, if your default TOU period is "Off Peak" you only need to define dates and days and times for On Peak or other TOU periods.)
- The specific date ranges, days of the week, and time periods designated for each TOU period.

The system periodically generates TOU map data for TOU maps by interpreting the rules defined template.

Attributes used to define TOU map templates include the following:

- **TOU Group:** the TOU group used by the map template Default TOU: the default TOU for the map template (from the TOU Group). This is the TOU used when creating TOU map data for dates not accounted for in the TOU Schedules section.
- **Work Calendar:** the work calendar used to identify holidays. On each holiday the Holiday TOU will be used. For additional information see [Defining Work Calendar](#) in the Oracle Utilities Application Framework *Administrative User Guide*.
- **Holiday TOU:** the TOU used for holidays (from the TOU Group)
- **Holiday Template:** the TOU map template used for holidays (if applicable)
- **Interval Size:** the size of the intervals for TOU map data created from the map template, represented as hours:minutes:seconds (HH:MI:SS).

- **TOU Schedules:** date ranges (including month, day, and time ranges) and which TOU periods apply to each

Refer to [Understanding Referencing Master Data by Identifiers](#) for information on how admin configuration can reference a TOU map by a TOU template to ease migration of data between environments.

TOU Map Template Interval Size

TOU map templates can also specify an interval size (in seconds-per-interval, or SPI). This value specifies the duration of the individual TOU map data records, and also controls the values allowed in the Start and End Times. For example, if a TOU map template sets the interval size at 15 minutes, Start and End times must be in units of the interval size (10:00, 10:15, 10:30, etc.).

A TOU map template can be used to generate TOU map data for TOU maps whose SPI is divisible by the template's SPI. For example, a 60 minute template can be used to generate TOU data for TOU maps with SPIs of 60 minutes, 15 minutes, 5 minutes, etc. This means separate map templates are not needed for every SPI.

Holidays

Many utilities categorize consumption on holidays differently than on the day of week on which the holiday falls. For example, holiday consumption might be categorized as Off-Peak regardless of the day it falls on. TOU map templates can define rules for different TOU periods for holidays in two ways. Both options require that the template references a Work Calendar that identifies each of the holidays throughout the year. In addition they require either:

- A Holiday TOU that will be used for each holiday for the duration of that holiday (e.g. Off Peak)
- A Holiday TOU Map Template that defines the TOUs that should be used for holidays that fall during different seasons within the year (e.g. Off Peak Summer, Off Peak Winter)

Important Time of Use Template System Events

The time of use template supports the following business object algorithm system events:

- **Derive TOU:** receives a date time and determines the TOU code for that date time based on the configuration of the time of use template schedule. See the Derive Time Of Use For Date Time (D2-DERTOU-DT) algorithm type as an example.

Configuring Time of Use Map Templates

This portal is used to display and maintain a TOU Map Templates.

Refer to [Understanding Time of Use Map Templates](#) for more information.

You can access the portal by selecting **Admin**, then **Usage**, then **TOU Map Template**.

The following zones may appear as part of the portal's **Main** tab page:

- **TOU Map Template List:** This zone lists all TOU Map Template records. Broadcast a record to display the details of the selected record.
- **TOU Map Template:** This zone provides information about the selected TOU Map Template.

Time of Use Map Types

Understanding Time of Use Map Types

TOU Map Types define important properties of TOU maps of the type, including the interval size and the valid TOU map templates.

Attributes used to define TOU map types include the following:

- **Time Zone:** the time zone to be used when generating the TOU map data. Refer to [Multiple Time Zone Support](#) for more information about how time zones impact TOU map data in multiple time zone environments.
- **Interval Size:** the size of the intervals for TOU map data created from maps of this type, represented as hours:minutes:seconds (HH:MI:SS). The interval size cannot be larger than the interval size defined on the Default TOU Map Template or any of the Override TOU Map Templates.
- **Default TOU Map Template:** the default TOU map template used by maps of this type
- **Override TOU Map Templates:** one or more TOU map templates that can be used as an override on TOU maps of this type.

TOU Map Type Interval Size

The SPI of a TOU map must divide evenly into the SPI of any measuring component that uses the map (because the system joins the date/time of the measurement to the date/time of the TOU data). This means that it is possible to use a 15 minute TOU map with a 60 minute measuring component. However, it is not OK to have a 60 minute TOU map used with a 15 minute measuring component because the join will miss 3 out of 4 measurements.

However, it is important to note that the TOU mapping process is at its most efficient when the measurement data that is being mapped is of the same interval size as the TOU schedule it is being mapped against. When there are differences in the interval size the process must first convert the measurement data into the appropriate interval size for the TOU Map prior to applying the TOU Map.

This means that for each TOU Map Template you should have sufficient TOU Map Types to cover the various interval sizes that will be supported by your measurement data. For example, if you have measuring components with interval sizes of 15 minutes, 30 minutes, and 60 minutes then for each TOU Map Template there should be TOU Map Types with interval sizes of 15 minutes, 30 minutes, and 60 minutes.

Default and Override TOU Map Templates

While most TOU maps will use the TOU map template defined on the TOU map type, TOU maps also support a fallback/override pattern used in other areas of the system.

- A TOU map's TOU map type defines the default (or "fallback") TOU map template that's used to generate its TOU data.
- A TOU map's type defines the TOU map templates that can be referenced on individual TOU maps to override the "fallback" template.
- An individual TOU map can have an override template. If the TOU map doesn't have an override template, the fallback template defined on the TOU map type is used to generate the map's TOU data.

Important Time of Use Map System Events

The TOU Map business object that is associated to a given TOU map type supports a special system event that is used in the generation of TOU map data:

- **Create TOU Map Data:** receives a date range and for that date range it will create the appropriate TOU map data for the TOU map. See the Create TOU Map Data (D2-CRETMD-CT) algorithm type as an example.

Configuring Time of Use Map Types

This portal is used to display and maintain a TOU Map Types.

Refer to [Understanding Time of Use Map Types](#) for more information.

You can access the portal by selecting **Admin**, then **Usage**, then **TOU Map Type**.

The following zones may appear as part of the portal's **Main** tab page:

- **TOU Map Type List:** This zone lists all TOU Type records. Broadcast a record to display the details of the selected record.

- **TOU Map Type:** This zone provides information about the selected TOU Map Type.

Defining Premise and Service Point Options

A premise is where a customer consumes the services supplied by your company. Located at a premise are the various devices that consume energy and measure consumption. Before you can define premises and devices, you must set up the control tables defined in this section.

WARNING:

The topics in this section do not describe every table that must exist in order to set up premises and service points. Many premise and service point control tables are described in [Defining Device Options](#), and [Defining Service Order Options](#). The tables described in this section are those that must be set up regardless of the type of service.

An Illustration Of A Premise

The following picture illustrates a premise with 2 service points, 2 meters, and 2 badged items:

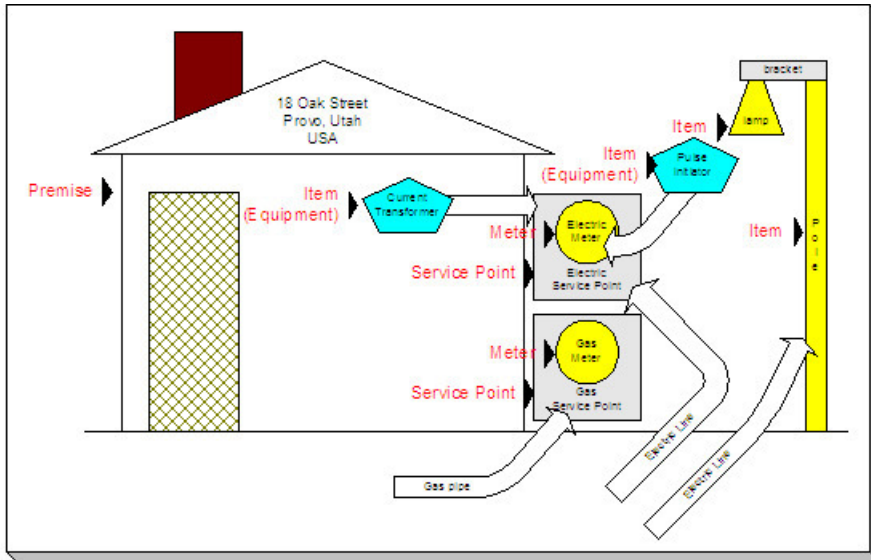

The following concepts are illustrated above:

Premise A premise describes a location at which your company supplies some type of service. In addition to the obvious address information, a premise also contains geographic coordinates, meter read instructions, and taxation jurisdiction information.

FASTPATH:

For more information about the control tables that must be set up before you can define a premise see [Setting Up Premise Options](#).

Service Point A service point (SP) is a geographic location at which service(s) are delivered to a premise. The SP record maintains information about the type of service, the measurement cycle (if the service is metered), the field office responsible for maintaining the service, the distribution company that supplies the service, etc.

There are three major categories of service points:

- Those where the rate of consumption and the total amount of consumption is measured (e.g., electricity, gas, water) by a meter. You can think of this type of service point as a "socket" into which a meter can be plugged. Over time, many meters may be plugged into the socket. We refer to these types of service points as metered.
- Those that hold badged items. A badged item is a physical device with a unique identity (e.g., a specific street light, a specific hydrant). You can think of this type of service point as a "socket" into which a badged item can be plugged. Over time, many items may be plugged into the socket. We refer to these types of service points as item-based.
- Those used to hold one or more non-badged items. For example, if your organization doesn't badge street lamps, you can use a single service point to hold an infinite number of lamps. We refer to these types of service points as non-badged.

FASTPATH:

Refer to [Service Points \(SPs\)](#) for more information about non-badged items.

An unlimited number of SPs may exist at a premise. However in reality, the number of SP's is related to the number of services supplied by your company. For example, an electric and gas company will typically have two SPs per premise.

FASTPATH:

For more information about the control tables that must be set up before you can define service points refer to [Setting Up Generic Service Point Options, Defining Device Options](#).

Field activities may be dispatched to all types of service points.

Meter A meter is a physical device used to measure the amount of gas, water, or electricity used by a customer. While most meters measure consumption in a single unit of measure (e.g., gallons, cubic feet, kilowatt-hours), some electric meters are extremely sophisticated and measure several different factors. For example, some electric meters measure how much was used, when it was used, the efficiency of consumption, the maximum amount used, and a few other unusual things.

FASTPATH:

For more information about the control tables that must be set up before you can define a meter, refer to [Defining Device Options](#), and [Setting Up Consumption Estimation Parameters](#).

Item An item that is not consider to be "equipment" is a physical device that does NOT measure consumption, but impacts billing in some way (i.e., there are charges in your rates based on the number and type of items installed at a service point). Examples include street lights, light poles, and security cameras. Items are related to service points and a service point can have one or more items linked to it.

FASTPATH:

For more information about the control tables that must be set up before you can define an item, refer to [Configuring Device Types](#).

For more information about premises and service points, refer to [Understanding The "V"](#).

Setting Up Premise Options

This section describes tables that must be set up before you can define premises.

Defining Premise Types

Open **Admin > Geographic > Premise Type** to define the premise types used to categorize your premises.

Description of Page

Enter a unique **Premise Type** and a **Description** for every premise type.

Allow CIS Division controls whether premises of this type can use the CIS Division on the premise page. Valid values are Not Allowed, Optional, and Required.

If your implementation requires restricting data by CIS Division, it is recommended that Allow CIS Division be set to Required.

Implementing Address Validation

In order to set up address validation, you must ensure that the following Option Types are defined with their corresponding values on the General System Configuration – Feature Configuration page:

Option Type	Description
Address Validation Script	Indicates the name of the BPA script to invoke when a user clicks on the validate address button. This option is required if the Allow Address Validation option is set to Y. The base product includes sample script C1-ValAddr that uses Oracle Spatial procedures and functions to geocode an address and return its matching quality code.
Allow Address Validation	Indicates whether an integration with address validation software is implemented. If set to Y, the system will render a validate button along with the address fields displayed throughout the application to trigger address validation. Valid values are 'Y' and 'N'. If set to Y, the Address Validation Script to invoke must be specified.

As described in the above table, the base product includes sample script C1-ValAddr uses Oracle Spatial procedures and functions to geocode an address and return a matching quality code. To use this script, ensure that the Oracle Spatial Geocoding (F1-ORAGEOCD) algorithm is plugged in on installation options for the geocoding service system event. A data source containing the geocoding data must also exist on the database.

If your implementation uses something other than Oracle Spatial for address validation, you'll need to create a new address validation BPA script to specify on the General System Configuration feature configuration. For additional information about creating this script, see the steps descriptions for the C1-ValAddr script in the application. The new script should contain the following move step to update the page:

- If the calling page is an old style page, the move from the BPA to the page can be achieved by specifying a move step from a source field to a User Interface Field.
- If the calling page is a display map, the move from the BPA to the page can be achieved by specifying a step to read the Business Object, modify the values as returned by the validation software, and then update the BO.

Setting Up Generic Service Point Options

This section describes tables that must be set up before you can define service points.

Setting Up Service Point Types

Every service point must reference a service point (SP) type. The SP type controls almost all aspects of the service point's behavior (e.g., the type of field activity that may be dispatched to it, the type of service agreement that may be linked to it, the type of device that may be installed at it).

The topics in this section describe the windows used to set up your SP types.

WARNING:

Setting up SP types requires careful analysis of your company's SA types, field activities, and its consumption estimation philosophy. Refer to [Designing SP Types](#) for more information about this design process.

Setting Up Premise & Service Point Postal Defaults

You set up postal defaults if your company is able to default field values onto new premises and service points based on the premise's postal code. The topics in this section describe how to maintain postal defaults.

FASTPATH:

For more information about where these default values are used, refer to [Maintaining Premises](#) and [Maintaining Service Points](#).

Postal Defaults - Main

To define premise postal defaults, open **Admin > Geographic > Postal Code Default > Add**.

Description of Page

Enter the **Country Code** and range of postal codes to which the default values apply using the **From Postal** and **To Postal**.

NOTE:

You may not have postal defaults whose from / to postal codes overlap.

Trend Area is not applicable for Customer to Meter.

Enter the **County** to be defaulted onto new premises located in this postal code range.

Enter the **City** to be defaulted onto new premises located in this postal code range.

Enter the **CIS Division** to be defaulted onto new premises located in this postal code range.

Enter the **State** to be defaulted onto new premises located in this postal code range.

Enter the **Time Zone** to be defaulted onto new premises located in this postal code range.

Use the **Characteristic Types and Values** collection to define the **Characteristic Types** and their respective **Characteristic Values** to be defaulted on premises located in this postal code range. In addition to providing interesting information, these characteristics may also determine the prices and tax rates on the bills generated for the services consumed at a premise.

FASTPATH:

For more information about characteristics, see [Setting Up Characteristic Types & Their Values](#) and [An Illustration Of A Bill Factor And Its Characteristics](#).

Use the **Geographic Types and Values** collection to define the **Geographic Types** and their respective **Values** to be defaulted on premises located in this postal code range. In addition to providing interesting information, these values may be used to sort field activities in geographic value order.

Where Used

This information is defaulted when a new Premise is added. Characteristics and geographic values are also defaulted when the postal code for a Premise is changed. Refer to [Maintaining Premises](#) for more information.

Postal Defaults - Service Default

To define values to be defaulted for a service point located in a postal range, open **Admin > Geographic > Postal Code Default > Search** and navigate to the **Service Defaults** page.

FASTPATH:

For more information about where these default values are used, refer to [Maintaining Service Points](#).

Description of Page

Use the **Service Defaults** collection to define values to be defaulted on service points located in a given postal code range belonging to a given **Service Type** (note, a service point's Service Type comes from its SP Type).

Stock Location is not applicable for Customer to Meter.

- Use the **Characteristic Types and Values** collection to define the **Characteristic Types** and their respective **Characteristic Values** to be defaulted on new service points located in this postal code range. In addition to providing interesting information, these characteristics may also determine the prices and tax rates on the bills generated for the services consumed at a service point.
- Use the **Geographic Types and Values** collection to define the **Geographic Types** and their respective **Values** to be defaulted on new service points located in this postal code range. In addition to providing interesting information, these values may be used to sort field activities in geographic value order.

Designing SP Types

Every service point must reference an SP type. When you set up an SP type, you define how the system manages many aspects of its service points' behavior.

NOTE:

Perfect foresight. In a perfect world, the other control tables would have been set up with perfect foresight of setting up your SP types. In reality, setting up your SP types may invalidate some of your earlier decisions. Don't feel bad if this happens, some amount of iteration is natural.

Designing your SP types is an iterative process. To minimize the number of iterations, we recommend using the steps outlined in this section to complete the following table. When the table is complete, you're ready to set up your SP types.

SP Type	Service Type
---------	--------------

Service Segmentation

At a minimum, you will have one SP type for every different type of service that exists at your premises. If we assume that your organization sells gas, water, waste water and electricity services, you will need four SP types.

SP Type	Service Type
GAS	Gas service
WATER	Water service

WASTE WATER

Waste water service

ELECTRIC

Electric service

Device Segmentation

For each service, determine if there exist meters, badged items, or non-badged items at the service points. For example, if we assume:

- Electric service has service points with meters, badged lamps, and parking lots.
- Gas and water services just use meters.
- Waste water service doesn't actually have a meter installed at it (it uses the water consumption measured by the water service point's meter)

Then your SP types will be:

SP Type	Service Type	SP Sub Type
GAS - METERED	Gas service	Meter
WATER - METERED	Water service	Meter
WASTE WATER	Waste water service	Unbadged
ELECTRIC - METERED	Electric service	Meter
ELECTRIC - BADGED LAMP	Electric service	Item
ELECTRIC - PARKING LOT	Electric service	Unbadged

SA Type Segmentation

Every SP Type whose service points can be linked to a service agreement has one or more SA types. These define which type of service agreements can pay for the service point's service. If different service points have different valid SA types, you will need to split the SP types accordingly.

The SA Type segmentation of SP Types is the most complicated design decision you'll have to make. Unfortunately, the decision making process is subjective and iterative. The iterations are caused by the fact that the number of SA types is dependent on the number of SP types (and vice versa). We recommend the following to help work your way through this conundrum:

- Design your SA types using the information in [Defining Service Agreement Types](#).
- Return to your SP types and determine if, given the proposed SA types, you can define a list of valid SA types for each SP type. If you find the population of SA types (and their valid rates) could result in invalid rates paying for service at a service point, divide your SA types further.

Defining Bill and Measurement Cycles

This chapter is dedicated to issues related to defining cycles, routes and schedules in the system.

Defining Bill and Measurement Cycles

Every account references a bill cycle. An account's bill cycle controls when it is billed.

Every manually read metered service point references a measurement cycle. A service point's measurement cycle controls when a service point's meter is measured.

The design of your measurement and bill cycles is inextricably linked because you probably want to bill your customers shortly after their meter devices are measured.

In this section, we describe how to design and set up these cycles. In addition, we discuss how to set up bill period schedules. These are used to define the bill segment end date for special types of non-metered service agreements.

NOTE:

Recommendation. We recommend reviewing [Bill Frequency - Bill Cycle vs Bill Segment Duration](#) before setting up this information.

The Big Picture of Bill Cycles, Measurement Cycles, and Bill Periods

The topics in this section provide background information about a variety of bill cycle, measurement cycle, and bill period issues.

Designing Cycles for Metered Services

The topics in this section provide background information about a variety of measurement cycle issues.

A Description of the Cyclical Meter Read Process

Manual meter readers using handheld devices record most meter reading measurements in the field. These meter reads are uploaded into the system for use by Oracle Utilities Meter Data Management.

A service point's installed meter device is measured due to the following data relationships:

- Every metered service point references a schedule route.
- A route references a measurement cycle.
- A measurement cycle has measurement cycle schedules that define when the service points in the cycle are measured.
- Every measurement cycle schedule contains two dates:
 - **Scheduled selection date.** This is the date Meter Data Management could use to select the service points in the cycle for download to your handheld software via custom algorithms to create handheld activities when pending measurement cycle schedules are proposed (refer to [Measurement Cycle and Bill Determinants](#) for more information).
 - **Expected work date.** This is the date the meter is expected to be read.

NOTE:

Overriding a route within a specific schedule. Rather than downloading all routes within a cycle, you can set up the system so that only specific routes are downloaded on any given date. This is a very powerful feature. You can use it, for

example, to estimate specific cycles every other month or indicate the customer reads the meter every third month. Refer to [Designing Measurement Cycles, Routes, And Schedules](#) for more information.

- On the scheduled selection date, Meter Data Management could create a download file, via custom algorithms, containing information to be sent to your handheld software. This download file should contain information about every register or measuring component on every meter in the routes being downloaded.
 - Your handheld software distributes this information to the handheld devices and then your meter readers do their job. When they finish, the resultant measurements are uploaded into the system for subsequent use by other processes such as usage transactions for billing.
-

WARNING:

It is very important to create a measurement cycle schedule for every expected read date regardless of whether the cycle's routes are downloaded. Why do you have to do this? Because Meter Data Management uses the expected work date on the measurement cycle to know when to look for a measurement during usage calculations. If it can't find a reading on or near this date, Oracle Utilities Meter Data Management may estimate consumption. Without a measurement cycle schedule, MDM wouldn't know when to look for readings. So, for example, if you estimate a given cycle's consumption EVERY OTHER MONTH, you must create a measurement cycle schedule for EVERY month. On each month's schedule, you must define if the routes should be downloaded.

FASTPATH:

For more information about the how to control when a cycle is read, refer to [Setting Up Measurement Cycle Schedules](#).

Designing Measurement Cycles, Routes, And Schedules

The topics in this section provide information describing how to design your measurement cycles, routes, and schedules.

- [Designing Measurement Cycles For Meter Reading](#)
- [Designing Schedule Routes For Meter Reading](#)
- [Designing Metered Measurement Cycle Schedules](#)

Designing Measurement Cycles for Meter Reading

The criterion that affects the number of measurement cycles has nothing to do with when meter readers physically read your meter devices. Rather, the frequency that you bill the meter's consumption (real or estimated) is what controls the number of measurement cycles.

So, for example, if you bill every month, but read every OTHER month, you'll have 20 measurement cycles - one for each bill day during the month. If you bill bimonthly, you'll have 40 measurement cycles. If you bill quarterly, you'll have 60 measurement cycles. Etc.

NOTE:

Different billing frequencies are possible for different service points. If you have different billing frequencies for your different types of metered service, you'll need a different set of cycles for each billing frequency. For example, if you bill water quarterly and electricity monthly, you'll have 20 bill cycles (one for each bill day during a month), but you'd need 60 quarterly measurement cycles for your water service points, and 20 monthly measurement cycles for your electric service points. This would result in a customer getting billed every month. However, four times a year, their bill would contain a charge for both electricity and water.

[Top of the Page](#)

Designing Service Routes For Meter Reading

The following points describe the relationship between a meter read, a route and a measurement cycle:

- A measurement cycle contains one or more routes.
- A route has one or more service points.
- A service point holds an installed meter device.
- And a device is what is measured.
- Therefore, the number of devices a person can read in a day limits the number of service points in a route.

WARNING:

If your company supplies electric service and uses MV90's, you will need to take advantage of "notional" routes. A "notional" route's service points are never actually read by a human. Rather, the service points' consumption is fed to the system by a sophisticated device (e.g., an MV90). These service points still need to be linked to a route because usage calculation is dependent on the route's cycle to determine the expected meter read date.

[Top of the Page](#)

Designing Metered Measurement Cycle Schedules

The process of designing your measurement cycle schedules is either easy or complicated. It will be easy if all routes within a cycle are downloaded when the measurement cycle is scheduled for download. It will be complicated if you download a subset of routes within a cycle on any given download date. We'll provide a few examples to help explain why.

If you download all cycles in a route whenever the cycle is downloaded, your measurement cycle schedule will look as follows.

NOTE:

Bill cycles. We've included each measurement cycle's related bill cycle to help you understand when the measurement cycle's consumption will be billed. Bill cycles are discussed in [Bill Cycles](#).

Measurement Cycle	Download Date	Expected Work Date	Which Routes To Download	Bill Cycle	Bill Window	Estimation Date
1	28-May-99	31-May-99	All	1	31-May-99 to 2-Jun-99	2-Jun-99
2	31-May-99	1-Jun-99	All	2	1-Jun-99 to 3-Jun-99	3-Jun-99
3	1-Jun-99	2-Jun-99	All	3	2-Jun-99 to 4-Jun-99	4-Jun-99
4	2-Jun-99	3-Jun-99	All	4	3-Jun-99 to 7-Jun-99	7-Jun-99

Etc. to 20

Now let's complicate life. If we assume you physically read your routes every other month (but bill monthly using estimated consumption), then you'll need the following measurement cycle schedule.

Measurement Cycle	Download Date	Expected Work Date	Which Routes	Bill Cycle	Bill Window	Estimation Date
1	30-May-99	31-May-99	1, 2, 3 - Download 4, 5, 6 - Estimate	1	31-May-99 to 2-Jun-99	2-Jun-99

2	31-May-99	1-Jun-99	1, 2, 3 - Download 4, 5, 6 - Estimate	2	1-Jun-99 to 3- Jun-99	3-Jun-99
3	1-Jun-99	2-Jun-99	1, 2, 3 - Download 4, 5, 6 - Estimate	3	2-Jun-99 to 4- Jun-99	4-Jun-99
4	2-Jun-99	3-Jun-99	1, 2, 3 - Download 4, 5, 6 - Estimate	4	3-Jun-99 to 7- Jun-99	7-Jun-99
Etc. to 20						
1	29-Jun-99	30-Jun-99	1, 2, 3 - Estimate 4, 5, 6 - Download	1	30-Jun-99 to 2-Jul-99	2-July-99
2	30-Jun-99	1-July-99	1, 2, 3 - Estimate 4, 5, 6 - Download	2	1-July-99 to 3- Jul-99	3-July-99
3	1-July-99	2-July-99	1, 2, 3 - Estimate 4, 5, 6 - Download	3	2-July-99 to 4- July-99	4-July-99
4	2-July-99	3-July-99	1, 2, 3 - Estimate 4, 5, 6 - Download	4	3-July-99 to 7- July-99	7-July-99
Etc. to 20						

Notice the following:

- You still have 20 measurement cycles even though you only read the meters every other month. Why? Because Oracle Utilities Meter Data Management uses the expected work date on the measurement cycle to know when to look for a measurement. If it can't find a reading on this date, Meter Data Management estimates consumption. Without a measurement cycle schedule, Meter Data Management wouldn't know when to look for readings.
- Every other month you download half the routes in each cycle and estimate consumption for the other half.
- If you don't download all routes when a measurement cycle is scheduled, you have to indicate how to handle every route in the cycle.

The above design is infinitely flexible. You can use it to handle any number of requirements:

- Estimate consumption every seventh month.
- Bill every month, but only read once a quarter.
- Etc.

Bill Cycles

The topics in this section provide background information about a variety of bill cycle features.

The Cyclical Billing Process & Window Billing

The cyclical bill creation process creates most bills. This process works as follows:

- Every account references a bill cycle. The bill cycle's schedule controls WHEN the system attempts to create bills for the account.
- Every bill cycle has a bill cycle schedule that defines the dates when a cycle's accounts are to be billed. Rather than attempt to create bills on one evening, most bill cycles use a concept of "window billing" where the system attempts to produce bills for accounts over a few nights. The first night (i.e., the day the window opens) should be the earliest day on which meter reads for the account can enter the system. The last night (i.e., the day the window closes) should be the last possible day in which a meter read can enter the system. This concept of window billing allows you to start billing accounts on the earliest possible day and then bill the stragglers over successive evenings. This results in much better cash flow.
- When the bill cycle creation process runs, it looks for bill cycles with open bill windows. It then attempts to create bills for the accounts in each such cycle. If a bill is created, it will send it out that evening. If a bill cannot be created, the system will create a bill in the "error" state with a message that can be analyzed by your billing staff. The next day, your staff can either correct the problem or not. When the bill cycle creation process next runs, it deletes all "error" bills and attempts to recreate them. It continues this throughout the bill window. If bills are in error at the end of the window, they will remain in this state until a user fixes them. If the bills are still in error when the cycle's next window opens, a billing error will be generated.

The following diagram should help clarify the above.

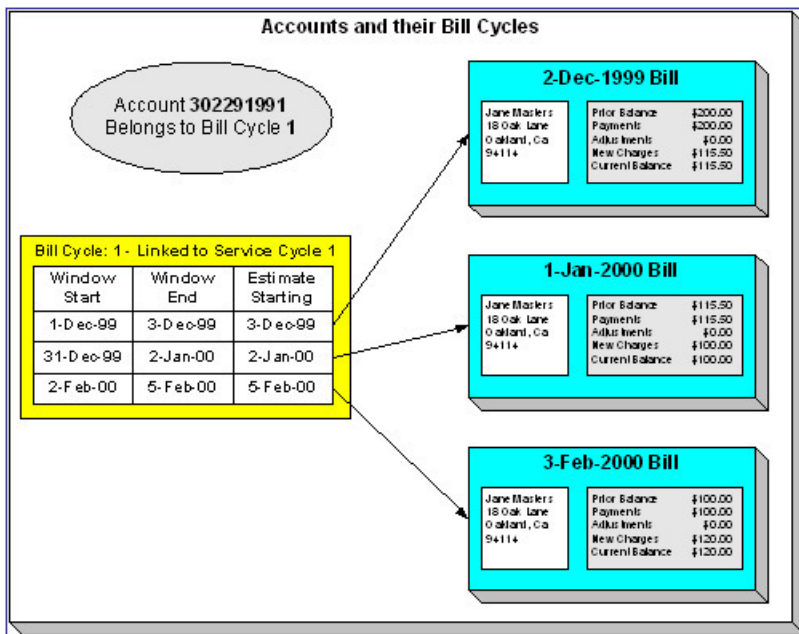

FASTPATH:

For more information about the how to control when bills are produced for a cycle, refer to [Bill Cycle - Bill Cycle Schedule](#).

Designing Your Bill Cycle

The number of bill cycles is determined by the frequency that you bill your customers. So, for example, if you bill every month, you'll have 20 bill cycles - one for each bill day during the month. If you bill bimonthly, you'll have 40 bill cycles. If you bill quarterly, you'll have 60 bill cycles. Etc.

Keep in mind the following:

- You may need additional bill cycles if you allow customers to be billed off-cycle. For example, you could create a bill cycle called "Seniors" and link this to every senior citizen. You would set up this bill cycle's schedule to create bills shortly after social security checks are issued.
- You may need other bill cycles for customers with non-metered services (e.g., land leases, one time invoices).

IMPORTANT:

An account's bill cycle should attempt to create bill segments at least as often as the shortest service agreement duration. For example, if an account has both monthly and quarterly service agreements, the account should be placed on a monthly bill cycle. Refer to [Bill Frequency - Bill Cycle vs Bill Segment Duration](#) for more information.

The Relationship Between Metered Measurement Cycles and Bill Cycles

As you can deduce, a service point's measurement cycle is related to an account's bill cycle.

The following table is an example of how you would set up the various dates on the various schedules that control meter reading and billing.

Measurement Cycle	Download Date	Expected Work Date	Bill Cycle	Bill Window	Estimation Date
1	28-May-99	31-May-99	1	31-May-99 to 2-Jun-99	2-Jun-99
2	31-May-99	1-Jun-99	2	1-Jun-99 to 3-Jun-99	3-Jun-99
3	1-Jun-99	2-Jun-99	3	2-Jun-99 to 4-Jun-99	4-Jun-99
4	2-Jun-99	3-Jun-99	4	3-Jun-99 to 7-Jun-99	7-Jun-99
Etc.					

Notice the following about this example:

- The bill cycle code is the same as the measurement cycle. This is not necessary, it's just good practice.
- The bill window starts on the first date on which a meter read could be uploaded.
- The bill window ends on the day after the last possible day a read could be uploaded for the bill cycle.
- Oracle Utilities Meter Data Management only estimates consumption on the last day of the bill window.

FASTPATH:

For more information about the bill cycle schedule, refer to [Setting Up Bill Cycles](#).

How Does An Account Get Its Bill Cycle?

Most accounts are created behind-the-scenes when a user uses the "add account" option on [Person - Main Information](#). An account created like this doesn't have a bill cycle. Rather, it sits in limbo awaiting the activation of its first service agreement. When a service agreement is activated, the system populates the account's bill cycle using the following algorithm:

- If an account's bill cycle is protected, the activation of a service agreement will not affect an account's bill cycle. Refer to [Protecting An Account's Bill Cycle](#) for more information.
- If the service agreement being activated is for metered service, the account is given a bill cycle that will generate bills shortly after the service point is read. The route the system follows to get this bill cycle is a bit indirect:
 - A metered service agreement references one or more metered service points.
 - Every metered service point references a measurement cycle (the measurement cycle controls when the meter at the service point is read).
 - Every measurement cycle references a default bill cycle. It is this bill cycle that is populated on the account paying for service at the service point.
- If the service agreement being activated is for metered service and the associated service point is externally managed along with its measurement cycle and bill cycle, an external call is made to obtain the bill cycle from Meter Data Management. This bill cycle is assigned to the service agreement's account.
- If the service agreement being activated is not metered, the system cannot populate the account's bill cycle because there is no measurement cycle from which to default the bill cycle. This means the account's bill cycle will be blank until a user specifies a bill cycle for the account (using the Account page).

NOTE:

A To Do entry highlights accounts without a bill cycle. A To Do entry highlights those accounts that require a user to specify a bill cycle. This entry is generated for accounts without a bill cycle that have active service agreements.

When the last service agreement linked to an account is stopped, the account's bill cycle will be changed so that the account will be final billed when billing next executes. Refer to [What Happens At Finalization Time?](#) for more information.

When a service point's measurement cycle is updated, and the account's bill cycle is not protected, the system automatically updates the account's bill cycle to be in sync with the measurement cycle. Note that this will only take place if the Allow Bill Cycle Synchronization **Option Type** on the General System Options [Feature Configuration](#) is set to Y.

When an externally managed service point's measurement cycle is updated that results to a change in the bill cycle, a change notification is sent by Meter Data Management to trigger an corresponding update of the associated account's bill cycle in Customer Care and Billing. Note that this will only take place if the Allow Bill Cycle Synchronization **Option Type** on the General System Options [Feature Configuration](#) is set to Y.

Protecting An Account's Bill Cycle

Over time, as a customer moves from premise to premise, their bill cycle is changed behind-the-scenes to be in sync with the latest service point's measurement cycle (as described in the previous section). If you do not want the system to change an account's bill cycle when a metered service agreement is activated, you need to turn on the account's **protect bill cycle** flag. You would do this if a customer liked to be billed at the start of the month regardless of when their device was read.

When the last service agreement for an account is stopped, the protect bill cycle flag is reset. This is to ensure that if the customer returns to start new service again, the bill cycle can be set based on [How Does An Account Get Its Bill Cycle](#).

What Happens If An Account Has Service Agreements Spanning Metered Measurement Cycles?

A single account can have service agreements that are in several measurement cycles. The bill cycle on such an account will default based on the last activated metered service agreement.

It's important to be aware that an account will only have bills created when its bill cycle schedule so indicates. This means that the consumption for some service points could remain unbilled for a few weeks.

Designing Bill Periods

Bill periods are used by non-metered service agreements whose bill end dates need to fall on strict dates. You need only set up this information if you have this type of service agreement.

FASTPATH:

Refer to [Ways To Control The End Date Of A Bill Segment](#) for more information.

Every bill period has a calendar that defines when bill segments are created for service agreements that use the bill period. Examples of bill periods include:

- Quarterly Bill - Last Day Of Quarter
- Quarterly Future Bill - Last Day Of Quarter
- Monthly - 15th Day Of Month.
- Monthly Future Bill - Last Day Of Month.

The Quarterly Bill - Last Day Of Quarter bill period would have a schedule that looked as follows:

Earliest Date On Which To Create A Bill Segment	Bill End Date
1-Oct-1998	30-Sep-1998
1-Jan-1999	31-Dec-1998
1-Apr-1999	31-Mar-1999
1-Jul-1999	30-Jun-1999
...	

The Quarterly Future Bill - Last Day Of Quarter bill period would have a schedule that looked as follows:

Earliest Date On Which To Create A Bill Segment	Bill End Date
15-Dec-1998	31-Mar-1999
15-Mar-1999	30-Jun-1999
...	

The remainder of this section provides examples using the above calendars.

The following example assumes the following:

- The service agreement starts on 18-Dec-1998.

- The service agreement's SA type references the Quarterly Future Bill - Last Day Of Quarter bill period.

The following table shows when bill segments will be produced (assuming the account's bill cycle attempt to create segments as soon as possible) for several bill periods:

Earliest Date Segment Will Be Produced	Bill Period
18-Dec-1998	18-Dec-1998 thru 31-Mar-1999
15-Mar-1999	1-Apr-1999 thru 30-Jun-1999
...	

The following example assumes the following:

- The service agreement starts on 18-Dec-1998.
- The service agreement's SA type references the Quarterly Bill - Last Day Of Quarter bill period.

The following table shows when bill segments will be produced (assuming the account's bill cycle attempts to create segments as soon as possible) for several bill periods:

Earliest Date Segment Will Be Produced	Bill Period
1-Jan-1999	18-Dec-1998 thru 31-Dec-1998
1-Apr-1999	1-Jan-1999 thru 31-Mar-1999
...	

FASTPATH:

Refer to [Setting Up Bill Periods](#) for information about how to define this information.

Setting Up Bill Cycles

An account references a bill cycle. The bill cycle defines when the account is billed and when the account's debt is checked to determine if it's overdue. To define a bill cycle and its bill cycle schedule, open **Admin > Billing > Bill Cycle > Add**.

Description of Page

Enter a unique **Bill Cycle** and **Description** for every bill cycle.

If your implementation requires restricting bill cycles to accounts by CIS Division, specify a **CIS Division** on the bill cycle.

Use the **Bill Cycle Schedule** collection to define when bills are produced for the accounts in a given bill cycle. The following fields are required for each instance:

Window Start Date Specify the date on which the system should start trying to create bills for accounts in the cycle.

Window End Date Specify the last day on which the system will create bills for accounts in the cycle. This should be the last possible date on which a meter read could be loaded into Oracle Utilities Meter Data Management for the account.

Accounting Date Specify the financial date associated with the bills' financial transaction. The accounting date defines the financial period(s) to which the bills will be booked in your general ledger.

Estimate Date The date on which Oracle Utilities Meter Data Management may start estimating consumption if a real measurement cannot be found. When specified, this date is typically on or shortly before the window end date.

Freeze and Complete Turn on this switch if the system should freeze and complete any bill that is created without errors. If this switch is turned off, all bills created by the billing process will be left in the unfinished state. You would only turn this switch off if you want to verify an entire bill run prior to freezing it (e.g., if you are introducing a new version of a rate). If you turn this off, you will need to return to this page after verifying a bill run and turn it back on for the customers to

receive bills. When the system next runs, it deletes all unfrozen bills and recreates them as per the instructions on the bill cycle schedule.

The batch bill creation process uses this schedule to define the bill cycles for which it should create bills.

NOTE:

Don't forget. After you set up the bill cycles that correspond with measurement cycles, go to [Setting Up Measurement Cycle Schedules](#) and update the measurement cycles accordingly.

Setting Up Service Cycles And Measurement Cycle Schedules

Refer to [Measurement Cycles](#), [Measurement Cycle and Bill Determinants](#), and [Setting Up Measurement Cycle Schedules](#) sections for more information

Setting Up Measurement Cycle Schedules

FASTPATH:

Refer to [Designing Cycles for Metered Services](#) for more information about measurement cycle. Refer to [The Relationship Between Metered Service Cycles and Bill Cycles](#) for more information about how measurement cycles are linked to bill cycles.

Description of Page

When you want to add a new measurement cycle schedule, you must specify the following information:

Service Cycle Enter the measurement cycle ID of the cycle whose routes will be downloaded.

Scheduled Selection Date Specify the date on which the system is meant to download information about the cycle's meters. This date should be a day or two before the scheduled work date.

Define the date the meters in the route are scheduled to be read using **Scheduled Work Date**. This date is extremely important as billing uses it when it looks for meter reads for service points in this cycle. If billing can't find a reading, consumption will be estimated as of this date (assuming the service agreement allows estimation).

Click **Pre-Generate Routes** if you need to finesse the cycle's routes on this Scheduled Selection Date (e.g., because some of the routes shouldn't be downloaded on a given date because the system is meant to estimate consumption). If you don't click this button, the system will create the routes on the scheduled selection date. It does this by creating a route extract for each downloadable route within the cycle (as defined by the route type). If you click this button, the system shows all routes within the cycle in the grid below. You must then define how the system is supposed to download each route on the scheduled selection date.

Click **Delete Routes** if you have pre-generated the routes and you want to remove them and allow the system to create the routes on the scheduled selection date.

Use the **Service Schedule Routes** to define how individual routes within the cycle should be handled during the download. The following fields are required for each schedule read date:

Service Route The unique ID of the service route. The route's route type is displayed adjacent.

Schedule Type This defines if and how the system is supposed to download the route's meter reads. Valid values are: Cust Read, Download, Estimate. Only those routes defined as Download will have meter reads downloaded. The other values are used to document why the route won't be downloaded.

Schedule Status This defines the download status of the route. Valid values are Pending and Complete. This value is only displayed for routes with a schedule type of Download.

Where Used

This information is used by the meter read download process to determine which meter reads to download.

This information is used by the billing process to determine the date on which it expects to find a read. If it cannot find a read on or around this date, and it's OK to estimate consumption, consumption will be estimated as of the scheduled work date. The system uses the service agreement's rate schedule's frequency to determine the period of time around the scheduled work date in which it looks for a read. Refer to [Defining Frequency Codes](#) for more information.

Setting Up Bill Periods

Some SA types reference a bill period. The bill period defines when the service agreement's bill segments are produced and the respective end date of each bill segment.

FASTPATH:

Refer to [Designing Bill Periods](#) for more information.

To define a bill period and the bill period schedule, open **Admin > Billing > Bill Period > Add**.

Description of Page

Enter a unique **Bill Period** and a **Description** for every bill period.

Use the **Bill Period Schedules** collection when the system should create bill segments for service agreements that use a given bill period. It also defines the end date of each respective bill segment. The following fields are required:

Bill Date Specify the earliest date on which the system is allowed to create a bill segment for service agreements using this bill period.

Bill Seg End Date Specify the end date of the bill segment. For future bills, this will be after the bill date. For retro bills, this will be before the bill date.

This information is used by the bill segment creation process to determine the end date of service agreements that use a bill period.

Defining Statement Cycles

If you have persons set up in the system to receive statements with financial information, you will need to assign them to a statement cycle and define a schedule for the statement cycle.

FASTPATH:

Refer to [The Big Picture of Complex Statements](#) for more information about statements.

The Big Picture Of Statement Cycles

A statement cycle has a similar purpose to that of a bill cycle. It controls when statements will be produced.

The Cyclical Statement Process

Persons who wish to receive statements will work with you to determine how often these statements should be produced. Some persons may want a monthly statement, some a quarterly and some annually. For each unique schedule that is designed for your various statement persons, you will set up a Statement Cycle and its schedule.

Designing Your Statement Cycles

The number of statement cycles is determined by a combination of the frequency that you will send statements to the statement persons and how many statement cycles you wish to manage within the same frequency.

So, for example, for all the statement persons who wish to receive a monthly statement, will you create only one monthly Statement Cycle so that all monthly statements are produced the same day? Or will you have several monthly statement cycles scheduled throughout the month? The answer will depend on the volume of statements being produced and on how you want to manage the statement production.

Lifecycle of a Statement Cycle Schedule

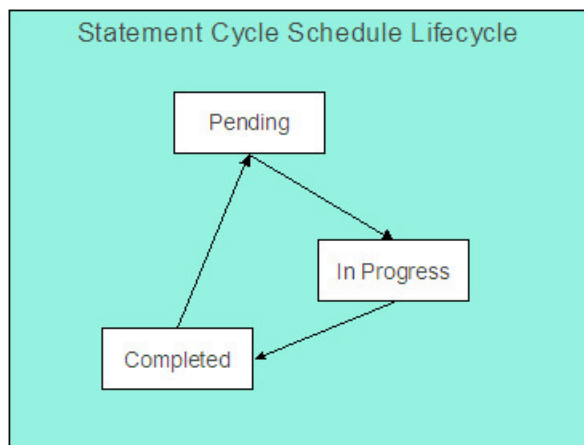

Pending The statement cycle schedule is added in this state. The Create Statements background process find records in this state to process on the appropriate date.

FASTPATH:

Refer to [Create Statements Background Process](#) for more information.

In Progress Records in this state are currently being processed by the Create Statements background process.

Completed Records in this state have already been processed by the Create Statements background process. If a problem occurs with the Create Statements background process and it needs to be rerun, simply change the status back to pending and rerun the process.

Setting Up Statement Cycles

A Statement Construct references a statement cycle. The statement cycle defines when the statement person will receive statements with financial information related to the accounts and service agreements linked to the statement construct. To define a statement cycle and its statement cycle schedule, open **Admin > Billing > Statement Cycle > Add**.

Description of Page

Enter a unique **Statement Cycle** and **Description** for every statement cycle.

Use the **Statement Cycle Schedule** collection to define when statements are produced for the persons with statement construct records in the given statement cycle. The following fields are required for each instance:

Processing Date Specify the date on which the system should create statements for persons with statement construct records in the cycle.

Status Indicates the status of the cycle schedule. Refer to [Lifecycle of a Statement Cycle Schedule](#) for more information.

The batch statement creation process uses this schedule to determine which statement cycles for it should create statements for the statement construct records. Refer to [Create Statements Background Process](#) for more information.

Defining Service Agreement Type (SA Types)

Every service agreement must reference a SA type. The SA type defines what you sell, how much you sell it for, to whom you sell it, how overdue debt is collected, and how sales will be booked in your general ledger.

NOTE:

Perfect foresight. In a perfect world, the other control tables would have been set up with perfect foresight of setting up your SA types. In reality, setting up your SA types may invalidate some of your earlier decisions. Don't feel bad if this happens, some amount of iteration is natural.

Designing SA Types For Service Agreements With Service Points

Designing your SA types is an iterative process. To minimize some iterations, we recommend using the steps outlined in this section to complete the following table. When the table is complete, you're ready to set up your SA types.

Division/SA Type	Service Type
------------------	--------------

The topics in this section provide guidelines describing how to fill in this table for SA types associated with service agreements that charge for service point-oriented services.

CIS Division Segmentation

A CIS division is typically associated with a jurisdiction. The definition of a jurisdiction is a geographic-oriented entity with unique business rules. For example, if you conduct business in California and Nevada, and each state has different collection rules, you will need a separate jurisdiction for each state. You must set up a CIS division for each jurisdiction in which you conduct business.

If we assume that you are located in a single jurisdiction - say California - we will need a single CIS division for all of our SA types.

CIS Division/SA Type
CA

Service Segmentation

At a minimum, you will have one SA type for every different type of utility service offered by your organization. If we assume you sell electricity, gas, water, wastewater and cable; your SA Types will be as follows:

CIS Division/SA Type	Service Type
CA/G	Gas service
CA/W	Water service
CA/E	Electric service
CA/WW	Waste water service
CA/CABLE	Cable

Receivable Segmentation

Many organizations segregate their receivable balances in the general ledger. For example, the receivable amount associated with gas and water service may be maintained in separate GL accounts.

If your organization does this, you will probably have at least one SA type for each such receivable account because each SA type references a distribution code that typically contains the receivable account.

- The word *probably* is underlined because this is a rule of thumb. There are situations where the number of receivable accounts isn't directly related to the number of SA types. This happens when an organization maintains very detailed receivable accounts in the general ledger and maintaining a one-to-one relationship between SA types and distribution codes would lead to a massive proliferation of SA types (and you don't want this!). If your organization maintains very detailed receivable accounts, please speak to your implementers, they should be able to introduce a small customization to generate the appropriate receivable account rather than extract it from the distribution code.
- The word *typically* is underlined because there are several SA types that don't book to a receivable account when bill segments are generated. For example, company usage and charitable contributions. Refer to [Company Usage Segmentation](#) and [Charitable Contribution Segmentation](#) for examples of SA types that don't book to receivable accounts.

We'll simplify our example and assume your organization has one receivable account for all types of utility service. Given this, we won't need additional SA types to support receivable segmentation:

CIS Division/ SA Type	Service Type	Distribution Code
CA/G	Gas service	A/R-UTIL
CA/W	Water service	A/R-UTIL
CA/E	Electric service	A/R-UTIL
CA/WW	Waste water service	A/R-UTIL
CA/CABLE	Cable service	A/R-UTIL

Revenue Segmentation

Look at your rates and determine which rates can be used by each SA type. The following table shows the sample rates that can be used for each service:

CIS Division/ SA Type	Service Type	Distribution Code	Rates
--------------------------	--------------	-------------------	-------

CA/G	Gas service	A/R-UTIL	GALL-1
CA/W	Water service	A/R-UTIL	WALL-1
CA/E	Electric service	A/R-UTIL	ERES-1, ERES-2, ECOM-1, EIND-1, ELAMP-1
CA/WW	Waste water service	A/R-UTIL	WWALL-1
CA/CABLE	Cable service	A/R-UTIL	CABLE

Now, look at the rates' calculation rule GL Distribution window. You're looking for calculation rules whose GL distribution is affected by revenue class. If there are no revenue classes referenced on the calculation rules, this means that the revenue associated with the rate will be booked to a single GL account regardless of the type of customer. If you see revenue classes, this means that the revenue account associated with the calculation rule(s) differs depending on the SA type's revenue class. If revenue classes are used in the rates, you must create a different SA Type for every revenue class.

Let's assume the following:

- The gas rate (GALL-1) references the RESIDENTIAL, COMMERCIAL and INDUSTRIAL revenue classes in order to differentiate revenue based on the type of customer.
- None of the other rates differentiate revenue based on customer class.

Our SA types will now look as follows:

CIS Division/ SA Type	Service Type	Distribution Code	Revenue Class	Rates
CA/G-RES	Gas service	A/R-UTIL	R - residential	GALL-1
CA/G-COM	Gas service	A/R-UTIL	C - commercial	GALL-1
CA/G-IND	Gas service	A/R-UTIL	I - industrial	GALL-1
CA/W	Water service	A/R-UTIL	N/A	WALL-1
CA/E	Electric service	A/R-UTIL	N/A	ERES-1, ERES-2, ECOM-1, EIND-1, ELAMP-1
CA/WW	Waste water service	A/R-UTIL	N/A	WWALL-1
CA/CABLE	Cable service	A/R-UTIL	N/A	CABLE

Notice that we created new SA types for gas in order to specify the respective revenue class. We didn't do this for the other services because it isn't necessary. However, you should feel free to do this if it feels right or if you need it for reporting purposes. For example, if you want to report on all *residential* service agreements, but you differentiate only gas by residential versus commercial, you'll be in trouble.

Rate Segmentation

Every SA Type whose service agreements have their charges calculated with a rate must have one or more rates linked to it. These define which rates can be linked to the SA type's service agreements. If different service agreements have different valid rate combinations, you will need to split the SA types accordingly.

For example, look at the electric rates. If we assume:

- the RES rates can only be used for residential customer,
- the IND rates can only be used for industrial customers,
- the COM rates can only be used for commercial customers,

- the LAMP rates can only be used for lamp customers

Then you might want to set up a new SA type to indicate such. The advantage of doing this is that you get more control over which rates can be used on a given SA type. The disadvantage is that you proliferate SA types. Unfortunately, it's really a question of taste.

CIS Division/ SA Type	Service Type	Distribution Code	Revenue Class	Rates
CA/G-RES	Gas service	A/R-UTIL	R - residential	GALL-1
CA/G-COM	Gas service	A/R-UTIL	C - commercial	GALL-1
CA/G-IND	Gas service	A/R-UTIL	I - industrial	GALL-1
CA/W	Water service	A/R-UTIL	N/A	WALL-1
CA/E-RES	Electric service	A/R-UTIL	N/A	ERES-1, ERES-2
CA/E-COM	Electric service	A/R-UTIL	N/A	ECOM-1
CA/E-IND	Electric service	A/R-UTIL	N/A	EIND-1
CA/LAMP	Electric service	A/R-UTIL	N/A	ELAMP-1
CA/WW	Waste water service	A/R-UTIL	N/A	WWALL-1
CA/CABLE	Cable service	A/R-UTIL	N/A	CABLE

WARNING:

Don't be too specific in your analysis in respect of rate segmentation because you could end up with a separate SA type for every rate (and you don't want this). We understand this is a very subjective warning, but we recommend that you start out with broad bands of rates that can be used on a SA type and narrow it down if you end up unhappy with the results. For example, you don't have to set up a separate SA type for low-income residential gas customers just because they have a special rate. Rather, you can leave your SA types as they are and treat low-income gas customers as a subset of your residential gas customers. **For more information**, refer to [Setting Up Start Options](#).

NOTE:

Rate override. If a service agreement of this type may be linked to a terms of service record, you must also consider whether or not the [rate schedule could be overridden](#) by a template SA linked to the terms of service record. Refer to [SA Type - Rate](#) for information about the possible values for this field.

Service Point (SP) Type Segmentation

Every SA Type whose service agreements exist to bill for service point-oriented service has one or more SP types. These define which type of service points can be linked to the SA type's service agreements. If different service agreements have different valid SP types, you will need to split the SA types accordingly.

For each service point-oriented SA type, determine if there are any restrictions in respect of the types of service points that can use the SA type's rates. For example, if we assume that only commercial SP types can be used by commercial customers, industrial SP types by industrial customers, residential SP types by residential customers, your SA types will be:

CIS Division/ SA Type	Service Type	Distribution Code	Revenue Class	Rates	SP Type
CA/G-RES	Gas service	A/R-UTIL	R - residential	GALL-1	G-RES
CA/G-COM	Gas service	A/R-UTIL	C - commercial	GALL-1	G-COM

CA/G-IND	Gas service	A/R-UTIL	I - industrial	GALL-1	G-IND
CA/W-RES	Water service	A/R-UTIL	N/A	WALL-1	W-RES
CA/W-COM	Water service	A/R-UTIL	N/A	WALL-1	W-COM
CA/W-IND	Water service	A/R-UTIL	N/A	WALL-1	W-IND
CA/E-RES	Electric service	A/R-UTIL	N/A	ERES-1, ERES-2	E-RES
CA/E-COM	Electric service	A/R-UTIL	N/A	ECOM-1	E-COM
CA/E-IND	Electric service	A/R-UTIL	N/A	EIND-1	E-IND
CA/WW-RES	Wastewater service	A/R-UTIL	N/A	WWALL-1	W-RES, WW-RES
CA/WW-COM	Wastewater service	A/R-UTIL	N/A	WWALL-1	W-COM, WW-COM
CA/WW-IND	Wastewater service	A/R-UTIL	N/A	WWALL-1	W-IND, WW-IND
CA/CABLE	Cable service	A/R-UTIL	N/A	CABLE	CABLE

Notice the wastewater SA types reference both water and waste water service points. This is intentional as wastewater service uses the consumption from the water service to calculate some part of the wastewater charge.

Company Usage Segmentation

Up to now, we've discussed SA types associated with service agreements linked to your customers. The system has also been designed to keep track of the expenses associated with your company's use of power. If you want the system to do this, you must create at least one SA type for each service consumed by your organization.

For example, if we assume your organization consumes electric, gas, and water service; your SA types will now be as follows:

CIS Division/ SA Type	Service Type	Distribution Code	Revenue Class	Rates	SP Type	Bill Seg Type
CA/G-RES	Gas service	A/R-UTIL	R - residential	GALL-1	G-RES	BD-RATED
CA/G-COM	Gas service	A/R-UTIL	C - commercial	GALL-1	G-COM	BD-RATED
CA/G-IND	Gas service	A/R-UTIL	I - industrial	GALL-1	G-IND	BD-RATED
CA/W-RES	Water service	A/R-UTIL	N/A	WALL-1	W-RES	BD-RATED
CA/W-COM	Water service	A/R-UTIL	N/A	WALL-1	W-COM	BD-RATED
CA/W-IND	Water service	A/R-UTIL	N/A	WALL-1	W-IND	BD-RATED
CA/E-RES	Electric service	A/R-UTIL	N/A	ERES-1, ERES-2	E-RES	BD-RATED
CA/E-COM	Electric service	A/R-UTIL	N/A	ECOM-1	E-COM	BD-RATED
CA/E-IND	Electric service	A/R-UTIL	N/A	EIND-1	E-IND	BD-RATED
CA/WW-RES	Wastewater service	A/R-UTIL	N/A	WWALL-1	W-RES, WW-RES	BD-RATED
CA/WW-COM	Wastewater service	A/R-UTIL	N/A	WWALL-1	W-COM, WW-COM	BD-RATED
CA/WW-IND	Wastewater service	A/R-UTIL	N/A	WWALL-1	W-IND, WW-IND	BD-RATED
CA/CABLE	Cable service	A/R-UTIL	N/A	CABLE	CABLE	BD-RATED
CA/E-COY	Electric service	EXP-COMP	N/A	E CO USE	E-CO USE	COMPUSAG

CA/G-COY	Gas service	EXP-COMP	N/A	G CO USE	G-CO USE	COMPUSAG
CA/W-COY	Water service	EXP-COMP	N/A	W CO USE	W-CO USE	COMPUSAG

Notice the three company usage SA types do not reference an A/R account as their distribution code. This is because when bill segments are created for these types of service agreements, the system must debit an expense account (or contra-revenue account) rather than a receivable account.

Also notice we introduced a new column - Bill Segment Type. Notice that the customer-oriented SA types use the BD-RATED bill segment type and the company usage SA types use the COMPUSAG bill segment type. Different bill segment types are necessary because company usage SA types use a different algorithm to calculate their bill segment's financial transaction algorithm because they don't affect either payoff or current balance.

FASTPATH:

For more information, refer to [Designing and Defining Bill Segment Types](#).

Debt Class Segmentation

Every SA Type has a debt class. The debt class is used to categorize a service agreement's debt for the purpose of credit and collections (C&C) analysis. If a given SA Type has different categories of debt from C&C's perspective, you will have to split the SA Type.

FASTPATH:

For more information about debt class, refer to [Designing Your Collection Procedures](#).

If we assume that your residential services are regulated and your commercial and industrial services are deregulated, we won't have to introduce additional SA types.

CIS Division/ SA Type	Distribution Code	Revenue Class	Rates	SP Type	Bill Seg Type	Debt Class
CA/G-RES	A/R-UTIL	R - residential	GALL-1	G-RES	BD-RATED	REGU
CA/G-COM	A/R-UTIL	C - commercial	GALL-1	G-COM	BD-RATED	UNRE
CA/G-IND	A/R-UTIL	I - industrial	GALL-1	G-IND	BD-RATED	UNRE
CA/W-RES	A/R-UTIL	N/A	WALL-1	W-RES	BD-RATED	REGU
CA/W-COM	A/R-UTIL	N/A	WALL-1	W-COM	BD-RATED	UNRE
CA/W-IND	A/R-UTIL	N/A	WALL-1	W-IND	BD-RATED	UNRE
CA/E-RES	A/R-UTIL	N/A	ERES-1, ERES-2	E-RES	BD-RATED	REGU
CA/E-COM	A/R-UTIL	N/A	ECOM-1	E-COM	BD-RATED	UNRE
CA/E-IND	A/R-UTIL	N/A	EIND-1	E-IND	BD-RATED	UNRE
CA/WW-RES	A/R-UTIL	N/A	WWALL-1	W-RES, WW-RES	BD-RATED	REGU
CA/WW-COM	A/R-UTIL	N/A	WWALL-1	W-COM, WW-COM	BD-RATED	UNRE
CA/WW-IND	A/R-UTIL	N/A	WWALL-1	W-IND, WW-IND	BD-RATED	UNRE
CA/CABLE	A/R-UTIL	N/A	CABLE	CABLE	BD-RATED	UNRE
CA/E-COY	EXP-COMP	N/A	E CO USE	E-CO USE	COMPUSAG	No debt

CA/G-COY	EXP-COMP	N/A	G CO USE	G-CO USE	COMPUSAG	No debt
CA/W-COY	EXP-COMP	N/A	W CO USE	W-CO USE	COMPUSAG	No debt

Notice the three company usage SA types do not have a debt class. This is because their bill segment type's FT algorithm doesn't cause debt to be created and therefore there is no reason to have a debt class. However, you'll need to create a "dummy" debt class - call it N/A - for these SA types because every SA type must reference a debt class.

Budget Billing Segmentation

Many utilities offer their customers levelized payment plans to smooth out the seasonal bill variations. We call this levelized amount the *budget amount*.

FASTPATH:

Refer to [Budget Billing](#) for more information about budgets in general. Refer to [Billing - Current Balance versus Payoff Balance](#) for an example of budget billing accounting.

If we assume that you only allow budget billing on the electric and gas residential services, then you'll need to update your CA/G-RES and CA/E-RES SA types:

CIS Division/ SA Type	Dist Code	Rev Class	Rates	SP Type	Bill Seg Type	Debt Class	Recurring Charge Control Info
CA/G-RES	A/R-UTIL	R	GALL-1	G-RES	BD-RATED	REGU	Amount to bill is Not Allowed Amount is Optional Frequency is Monthly Recurring Amount Label is Budget Amount:
CA/G-COM	A/R-UTIL	C	GALL-1	G-COM	BD-RATED	UNRE	
CA/G-IND	A/R-UTIL	I	GALL-1	G-IND	BD-RATED	UNRE	
CA/W-RES	A/R-UTIL	N/A	WALL-1	W-RES	BD-RATED	REGU	
CA/W-COM	A/R-UTIL	N/A	WALL-1	W-COM	BD-RATED	UNRE	
CA/W-IND	A/R-UTIL	N/A	WALL-1	W-IND	BD-RATED	UNRE	
CA/E-RES	A/R-UTIL	N/A	ERES-1, ERES-2	E-RES	BD-RATED	REGU	Amount to bill is Not Allowed Amount is Optional Frequency is Monthly Recurring Amount Label is Budget Amount:

CA/E-COM	A/R-UTIL	N/A	ECOM-1	E-COM	BD-RATED	UNRE
CA/E-IND	A/R-UTIL	N/A	EIND-1	E-IND	BD-RATED	UNRE
CA/WW-RES	A/R-UTIL	N/A	WWALL-1	W-RES, WW-RES	BD-RATED	REGU
CA/WW-COM	A/R-UTIL	N/A	WWALL-1	W-COM, WW-COM	BD-RATED	UNRE
CA/WW-IND	A/R-UTIL	N/A	WWALL-1	W-IND, WW-IND	BD-RATED	UNRE
CA/CABLE	A/R-UTIL	N/A	CABLE	CABLE	BD-RATED	UNRE
CA/E-COY	EXP-COMP	N/A	E CO USE	E-CO USE	COMPUSAG	No debt
CA/G-COY	EXP-COMP	N/A	G CO USE	G-CO USE	COMPUSAG	No debt
CA/W-COY	EXP-COMP	N/A	W CO USE	W-CO USE	COMPUSAG	No debt

Notice the following:

- We updated the two SA types to allow recurring charge information.
- The Recurring Charge Amount is Optional. Why? Because those customers who aren't on a budget plan won't have a recurring charge amount. Those customers on a budget will have a recurring charge amount.

NOTE:

Turn on Eligible for Budget. Besides indicating that these SA types use recurring charges, you also need to turn on the Eligible for Budget switch on the SA type to indicate that this type of SA participates in budget processing.

Override Budget Eligibility. You may plug in an override budget eligibility algorithm on an SA type that is configured to be Eligible for Budget if certain service agreements of this type are not eligible.

FASTPATH:

Refer to the Description of Page under [SA Type - Billing](#) for the definition of the recurring charge attributes.

Designing SA Types For SAs Without Service Points

The topics in this section provide guidelines describing how to design the SA types associated with your service agreements that don't have service points.

Overpayment Segmentation

When a customer pays more than they owe, you must decide what to do with the excess money. The following points describe two possibilities:

- You could create a new service agreement to hold the excess (let's call it an overpayment SA). The credit would be transferred from this service agreement to the billable service agreements when the next bill is completed. This means that all billable service agreements have the same opportunity to receive the overpayment when they are billed in the future.
- You could amalgamate the excess payment on one of the existing, billable service agreements. For example, if a customer has both electric and gas service, the excess funds could be kept on either the gas or the electric SA. This would result in the following:

- The service agreements that do NOT receive the overpayment will have debt when they are next billed.
- The service agreement that receives the overpayment could have its future debt offset by the overpayment (meaning that it could have a credit balance until the service agreement's future bill segments offset the overpayment amount).
- The above situation is not desirable unless the customer intentionally overpaid one service agreement. The first method (keeping the overpayment on a separate service agreement) obviates this potential problem. Obviously, if your organization sells a single service (and therefore your customers have a single service agreement) you would choose the second method.

You control which method is used by plugging in the appropriate Overpayment Distribution algorithm on each [Customer Class](#) (i.e., you can choose a different method for different customer classes). If you choose to hold overpayments on a separate SA, then you must set up an SA Type as described in the following table:

CIS Division/ SA Type	Service Type	Distrib. Code	Eligible for Billing	Debt Class	Pay Seg Type	Do Not Overpay	One-time
CA/OVERPAY	Other	A/P - OVER	Not billed	N/A	Normal	No	Yes

Notice the following about the new overpayment SA type:

- It has an interesting distribution code. This is because when a payment segment is created for this type of service agreements, the system must credit a liability (an overpayment is a liability).
- It's important to indicate that the overpayment SA is a one-time service agreement. Why? Because this means that the system will automatically close the SA when it's balance falls to zero (i.e., when all of the overpayment has been used to satisfy future bills).
- A bill segment type is not needed because the system never creates bill segments for such service agreements (they exist only to hold excess credits).
- You may also want to turn on the alert message
- You must plug-in a bill completion algorithm on this SA type. This bill completion algorithm will transfer the credit balance to the account's other service agreements when the bill is completed. Refer to [The Credit Transfer Algorithm](#) for more information about this algorithm.
- You must also reference this overpayment SA type as the parameter value on your overpayment algorithm (this algorithm is plugged in on the desired customer classes). Refer to [Overpayment Algorithm](#) for more information about this algorithm.

NOTE:

If overpayment means charitable contribution. Some organizations sponsor a program that works as follows - if a customer overpays a bill by a given amount (say \$5), this amount is assumed to be a charitable contribution. If you have this requirement, you will create another SA type to hold a customer's charitable contributions. This SA type will look similar to the one described below (see [Charitable Contribution Segmentation](#)) except it is not billable. The funds will be credited to this service agreement by creating a new overpayment algorithm that is similar to the base package Overpayment Algorithm. This new algorithm will be very similar to the existing algorithm. The main difference will be that it will have to check if the overpayment amount is an exact value (say \$5). If so, it will create a payment segment for the charitable contribution SA type; otherwise it will create a payment segment for the overpayment SA.

Write Off Segmentation

When you write off non-collectable debt, you transfer the receivable from a "normal" service agreement onto one or more write-off service agreements. When the debt is transferred to a write-off service agreement, the distribution code on the "normal" service agreement is credited (typically an A/R GL account), and the distribution code on the write-off service agreement is debited.

You will almost always need a write-off service agreement whose distribution code is the write-off expense. However, you probably don't book all of the write-off amount to a write-off expense account. Why? Because the debt that you're writing off typically contains both revenue and liabilities. At write-off time, you want to book the written off revenue to a write-off expense account and you want to reduce the liabilities (you don't owe the liability if you don't get paid). This means you'll need another SA type for the liabilities. Refer to [The Ramifications of Write Offs in the General Ledger](#) for a complete explanation.

The following table contains the minimum number of SA Types that you'll need to hold your write-offs.

CIS Division/ SA Type	Service Type	Distrib. Code	Bill Seg Type	Debt Class	Pay Seg Type	Do Not Overpay
CA/WO-STD	Other	EXP-W/O	Not billed	WO	Normal	Yes
CA/WO-LIA	Other	LIA-General	Not billed	WO	Normal	Yes

Notice the following about the new write-off SA types:

- They have interesting distribution codes. This is because when debt is transferred to these types of service agreements, the system must debit either an expense account (i.e., write-off expense) or a liability account. It's important to note that in [The Ramifications of Write Offs in the General Ledger](#) we explain how this liability account may be overwritten with the liability account that was originally booked.
- Neither needs a bill segment type because the system never creates bill segments for such service agreements (they exist only to hold uncollectable debt)
- Even though the debt is not collectable, it still has a debt class. Why? Because the system shows a customer's debt on many inquiries by debt class and it's important to show write-off debt on these queries.
- The combination of Payment Segment Type and Do Not Overpay are important. Refer to [The Ramifications of Write Offs in the General Ledger](#) for a complete explanation.

NOTE:

The adjustment type used to set the offending service agreement's current balance equal to its payoff balance is defined on each write-offable SA type. The adjustment type used to transfer the delinquent debt to the write-off service agreement is defined on the write-off SA type.

An Alternative. If you have a limited number of liability accounts, you may decide to have a separate write-off service agreement for each liability account. Doing this would proliferate the number of service agreements created at write-off time. However, it would simplify the remittance of payment to the taxing authority if the reversed liability is ever paid.

Connection Charge Segmentation

If you levy connection charges, you have two options:

- You can create a SA type that exists purely to handle connect charge debt. After doing this, you'd create a start option for this SA type that causes an adjustment to be levied as part of the start service process. This adjustment would contain your standard connection charge. This approach would be used by a utility that had multiple services (e.g., a combined electric, gas, water utility) that only levies a single connection charge regardless of the number of services started. If you use this approach, make sure to indicate the SA type is non billable.
- You can levy a start adjustment on one of your existing SA types (e.g., CA/E-RES). The easiest way to do this is with a start option. On the start option you'd indicate an adjustment to be levied as part of the start service process. This adjustment would contain your standard connection charge. This approach would be used by a utility that had a single service offering (e.g., an electric-only utility). Refer to [Setting Up Start Options](#) for more information.

In the table below, we show what would be necessary if you want to have a separate service agreement for the connection charge.

CIS Division/ SA Type	Service Type	Distrib. Code	Bill Seg Type	Debt Class
CA/CONNECT	Other	A/R-UTIL	Not billed	REGU

Notice the following about the new connection charge SA type:

- It has a normal receivable distribution code.
- It doesn't need a bill segment type because the system never creates bill segments for such service agreements (its charged via an adjustment).
- The debt class is interesting - REGU (for regulated). We are intentionally linking the connection charge debt to the same debt class as the regulated debt from which it originates. This way, the C&C process will consider the connection charge debt the same as regulated debt and therefore perform the regulated collection (which results in the severance of all regulated service agreements).

Charitable Contribution Segmentation

If your organization accepts charitable contributions made by your customers, you must create a SA type to hold these contributions.

CIS Division/ SA Type	Service Type	Distrib. Code	Debt Class	Bill Seg Type	Recurring Charge Control Info
CA/CHARITY	Other	A/P-CHAR	CHAR	RECUR	Amount to bill is Not Allowed Amount is Required Frequency is Monthly Recurring Amount Label is Contrib. Amount

Notice the following about the new charitable contribution SA type:

- It has an interesting distribution code. This is because when a payment is distributed to these types of service agreements, the system must credit a payable account (i.e., charitable contribution payable) rather than a receivable account. Note well, we have assumed a receivable is not incurred when the bill segment for the charitable contribution is created.
- It uses an interesting bill segment type - RECUR. This bill segment type was set up to create recurring charges that don't automatically stop at some point in time.
- The debt class is interesting - CHAR (for charity). This is done so that past due charitable contribution debt is treated separately from other types of debt.
- The recurring charge control information is set up as defined.

FASTPATH:

Refer to the Description of Page under [SA Type - Billing](#) for the definition of the recurring charge attributes. Refer to [Start Option Considerations For SA Types That Use Recurring Charges](#) for how you can use start options to automatically populate a service agreement's recurring charge fields with appropriate values when service is started.

WARNING:

It's important that you assign the charitable contribution SA type with a payment segment type that only affect current balance (as opposed to affecting current AND payoff balance). This is because there is no receivable recognized when the contribution is billed and therefore there is no payoff balance to relieve when it's paid.

Payment Arrangement Segmentation

If your organization allows customers to payoff outstanding debt using payment arrangements (e.g., current bill plus \$X), you will need a new SA type for every debt class that can have a payment arrangement. If we assume you can have payment arrangements for both regulated and unregulated debt, then you'll need at least two more SA types (you may have more SA types if you need to segregate the payment arrangement receivable amount by utility type (or some other type)).

CIS Division/ SA Type	Service Type	Distrib. Code	Debt Class	Bill Seg Type	Recurring Charge Control Info
CA/PA-REGU	Other	A/R-ARRG	REGU	RECUR-AS	Amount to bill is Not Allowed Amount is Required Frequency is Monthly Recurring Amount Label is Arrange Amount
CA/PA-UNRE	Other	A/R-ARRG	UNRE	RECUR-AS	Amount to bill is Not Allowed Amount is Required Frequency is Monthly Recurring Amount Label is Arrange Amount

Notice the following about the new payment arrangement SA types:

- They have an interesting distribution code. This is because when funds are transferred to these types of service agreements, the system must debit a receivable (i.e., payment arrangement receivable).
- They use an interesting bill segment type - RECUR-AS. This bill segment type was set up to create recurring charges that stop when the customer no longer has a payoff balance.
- Each new SA type references the debt class whose debt it will pay off. We are intentionally linking the payment arrangement debt to the same debt class as the regulated debt from which it originates. This way, the C&C process will consider the arrangement debt as the same as regulated debt and therefore perform the regulated collection (which results in the severance of all regulated service agreements).
- The recurring charge control information is set up as defined.

FASTPATH:

Refer to the Description of Page under [SA Type - Billing](#) for the definition of the recurring charge attributes. Refer to [Start Option Considerations For SA Types That Use Recurring Charges](#) for how you can use Start Options to automatically populate a service agreement's recurring charge fields with appropriate values when service is started.

Merchandise Segmentation - Installment Billing

If your organization allows customers to purchase merchandise using an installment plan, you must create a SA type for this.

NOTE:

No installments. If the customer must pay for the merchandise in one lump amount, you'd create an SA type similar to the [Connection Charge Segmentation](#) example.

CIS Division/ SA Type	Service Type	Distrib. Code	Debt Class	Bill Seg Type	Recurring Charge Control Info
CA/MERCH-I	Merch	A/R-MRCH	UNRE	RECUR-AS	Amount to bill is Not Allowed Amount is Required Frequency is Monthly Recurring Amount Label is Install Amount

Notice the following about the new merchandise SA type:

- It has a normal receivable distribution code.
- It uses an interesting bill segment type - RECUR-AS. This bill segment type was set up to create recurring charges that stop when the customer no longer has a payoff balance.
- The recurring charge control information is set up as defined.

FASTPATH:

Refer to the Description of Page under [SA Type - Billing](#) for the definition of the recurring charge attributes. Refer to [Start Option Considerations For SA Types That Use Recurring Charges](#) for how you can use start options to automatically populate a service agreement's recurring charge fields with appropriate values when service is started. Refer to [Start Option Considerations For SA Types That Use Initial Adjustments](#) for how you can use start options to automatically populate a service agreement's recurring charge fields with appropriate values when service is started.

Deposit Segmentation - Installment Billing

If your organization allows customers to pay deposits using an installment plan, you must create an SA type for this.

NOTE:

No installments. If the customer must pay for the deposit in one lump amount, you'd create an SA type similar to the [Connection Charge Segmentation](#) example. Just make sure the adjustment that's levied to charge for the deposit amount doesn't affect payoff balance (when you bill a deposit, the customer doesn't really owe anything because it's not a true receivable from an accountant's perspective).

CIS Division/ SA Type	Service Type	Distrib. Code	Debt Class	Bill Seg Type	Recurring Charge Control Info
CA/DEP-I	Other	A/P-DEPO	DEP	RECURATB	Amount to bill is Required Amount is Required Frequency is Monthly Recurring Amount Label is Install Amount

Notice the following about the new deposit SA type:

- It has an interesting distribution code. This is because when a payment is distributed to these types of service agreements, the system must credit a payable account (i.e., deposit payable) rather than a receivable account. Note well, we have assumed a receivable is not incurred when the bill segment for the deposit is created.
- It uses an interesting bill segment type - RECURATB. This bill segment type was set up to create recurring charges that stop when the system has billed the Total Amount to Bill.
- The debt class is interesting - DEP (for deposit). This is done so that past due deposit "debt" is treated separately from other types of debt.
- The recurring charge control information is set up as defined. Note well, the Amount to bill is Required.

FASTPATH:

Refer to the Description of Page under [SA Type - Billing](#) for the definition of the recurring charge attributes. Refer to [Start Option Considerations For SA Types That Use Recurring Charges](#) for how you can use start options to automatically populate a service agreement's recurring charge fields with appropriate values when service is started.

NOTE:

Bill messages on receipt of deposit in full. The base package includes a special FT Freeze algorithm that can be specified on deposit SA Types. It recognizes when a deposit has been paid in full, and creates a bill messages to inform the customer. Refer to algorithm DEP PIF MSG in [Algorithm Types](#) for more information.

Billable Charge Segmentation

You create a billable charge whenever a customer should be charged for a service that occurs outside the normal course of business. For example, you would create a billable charge to charge a contractor for the repair of a ruptured gas line. You can also use billable charges to "pass through" other bill ready charges generated outside the system, by another application, or by a 3rd party supplier.

A billable charge must reference a service agreement. This service agreement behaves just like any other service agreement:

- **Bill segments are created for the service agreement.** Whenever billing is performed for an account with billable charge service agreements, the system creates a bill segment for each service agreement with unbilled charges. If multiple unbilled charges exist for a given service agreement, only one bill segment will be created and it will contain details about all of the billable charges.
- **Payments are distributed to the service agreement.** Payments made by an account are distributed to its billable charge service agreements just like any other service agreement.

- **Overdue debt is monitored.** The credit and collections process monitors billable charge service agreements for overdue debt and responds accordingly when overdue debt is detected.

Therefore, you must set up at least one SA type to hold your billable charge debt. You may have multiple charges based on billing frequencies, A/R booking, debt monitoring, etc. It's really up to you.

The easiest way to determine how many billable charge SA types you'll need is to define every conceivable billable charge (which you should have done when you designed your [billable charge templates](#)). Then ask yourself if they have the same billing and payment behavior, if so, you'll have one SA type. If not, you'll need one SA type for each combination.

We will assume your billable charges are all used to levy unusual one-off charges that can be collected in the same way, therefore we'll need one SA type.

CIS Division/ SA Type	Service Type	Distrib Code	Debt Class	Bill Seg Type	Billable Charge Templates	Rate
CA/ONETIME	Other	A/R-UTIL	UNRE	BILLCHRG	TREETRIM DAMAGE	None
CA/PASSTHRU	Electricity	A/R-OTHER	UNRE	BILLCHRG	None	None
CA/ADDON	Electricity	A/R-OTHER	EXTERNAL	BILLCHRG	None	TAXES

Notice the following about the new one time SA type:

- It has a normal receivable distribution code.
- Its debt class is unregulated.
- It uses an interesting bill segment type - BILLCHRG. This bill segment type was set up to create bill segments using billable charges.
- It references the valid billable charge templates that can be used on this SA type.

NOTE:

One Time Charge. The ONE TIME example shown above implies this SA type exists to hold one-time charges.

Because of this, you should turn on the One Time Charge switch on the SA type so that service agreement's of this type are automatically closed when final payment is received. You don't have to do this because a customer could have a single billable charge service agreement that is perpetually active for pass through charges (i.e., it doesn't have a stop date). If you do this, the system will create a bill segment for this service agreement whenever it finds an unbilled billable charge linked to the service agreement.

Notice the following about the pass through SA Type:

- It doesn't use the normal distribution code or debt class. This is done so that the debt and receivable can be tracked separately. If these charges were being pass through from another system, you might want to track these financial values separately.
- It still uses the normal bill segment type - BILLCHRG. From a billing perspective, there is no difference between this and the one time SA Type.
- Templates are not relevant - these charges are not created on-line using templates, but are loaded via the [Billable Charge Upload Staging](#).

Notice the following about the add on charges SA Type:

- This is an example of bill-ready charges (similar to pass through) to which the system adds on other charges, for example, taxes.
- It still uses the normal bill segment type - BILLCHRG. From a billing perspective, there is no difference between this and the one time SA Type.

- It also uses a Rate. In this case, the bill creation algorithm (specified on the bill segment type) will take any billable charge lines and attach them to a bill. In addition, these billable charges will include billable charge service quantities (SQs). These service quantities will also be swept onto the bill segment, and the Rate (TAXES in this example) will be applied. In order for taxes to be calculated, the billable charge SQs must include the total taxable amount - the system is not able to apply the rate on top of the other billable charges. But, it can apply the tax rate to the SQs that are supplied.
- You can also use this technique to bill other rate-ready service quantities, like kWh, CCF, *etc.* This is a way to process rate-ready data for which you have a contract, but you do not know the meter (and therefore, cannot collect real meter reads).
- If the rate has pre-processing calculation groups, these will be applied as well.

FASTPATH:

For more information about billable charge templates, refer to [Setting Up Billable Charge Templates](#).

Over/Under Cash Drawer Segmentation

In order to balance a tender control that is out-of-balance, your organization must set up an account with a service agreement whose SA type references the over/under expense account. You will probably only have one service agreement that references this SA type, but you still must have it if you remit funds via a cash drawer.

FASTPATH:

For more information about over/under processing, refer to [How To Get An Unbalanced Tender Control In Balance \(Fixing Over/Under\)](#).

CIS Division/ SA Type	Service Type	Distrib. Code	Debt Class	Bill Seg Type
CA/OVR UNDR	Other	EXP-OV/UND	N/A	Not billed

Notice the following about the new SA type:

- It has an interesting distribution code. This is because when a payment segment is applied to this type of service agreement, the system must debit an expense account for under amounts (and credit it for over amounts).
- It doesn't need a bill segment type because the system never creates bill segments for such service agreements (it only has over/under payment segments linked to it).
- It uses the N/A debt class because the credit and collections process should never consider debt associated with service agreements of this type (because it's not really debt).

Payment Upload Error Segmentation

If the payment upload process detects an invalid account on a payment upload record, it will create a payment for the suspense service agreement defined on the upload process' tender source (see [Setting Up Tender Sources](#)). You should create a special SA type for this service agreement.

FASTPATH:

For more information about the payment upload process, refer to [Phase 3 - Create Payment Events, Tenders, Payments, and Payment Segments](#).

CIS Division/ SA Type	Service Type	Distrib. Code	Debt Class	Bill Seg Type
CA/SUSPENSE	Other	EXP-MISC	N/A	Not billed

Notice the following about the new SA type:

- It has an interesting distribution code. This code should probably be a suspense account. All payment segments that are created for this service agreement will eventually be transferred to a "real" service agreement and therefore this GL account's balance should be zero when no payments are in suspense.
- It doesn't need a bill segment type because the system never creates bill segments for such service agreements (it only has invalid account payment segments linked to it).
- It uses the N/A debt class because the credit and collections process should never consider debt associated with service agreements of this type (because it's not really debt).

CIAC Segmentation

If your company bills and refunds Contribution In Aid of Construction (CIAC) contracts, you must create one or more SA types. CIAC contracts are typically used to levy charges associated with line extensions. These types of service agreements are different from other service agreements because the initial amount charged is refunded to the original payee when new properties (or extensions) are added to the extension (or when the new properties are subsequently billed for service).

NOTE:

Billable charges are used for the original CIAC service agreement. CIAC SA types are always Billable Charge SA types because an operator must specify the exact amount to charge the contractor using a billable charge. Refer to [Billable Charge Segmentation](#) for more information.

The following points describe how CIAC processing is implemented in the system:

- When a new line extension is build, you will create a new service agreement that references your CIAC SA type. This service agreement should be linked to a service point associated with the extension. The easiest way to create this service agreement and link it to the service point is by using the Start Account transaction. It's important to remember to define your CIAC SA type as a valid SA type for the SP type used to represent the line extension.
- When a new premise / service point is built that "hangs" off the original extension, the new service point should be linked to the original service point. This can be done by referencing the original service point as the "parent" service point of the new service point using a [foreign key value characteristic](#).
- The system periodically monitors the original CIAC service agreement. The process that performs this monitoring is referenced on the original CIAC service agreement's SA type. The exact processing that takes place during this monitoring is up to your organization's specific business requirement. For example, if you refund 10% of every bill produced for the "downstream" service points to the original contractor, you would have logic in your CIAC monitoring process that looks for recent bill segments produced for the "downstream" service agreements and then creates an adjustment for the master service agreement.

NOTE:

CIAC refunds are idiosyncratic. Because CIAC refund processing is idiosyncratic, we do not supply any CIAC monitoring processes in the base package. This is because the likelihood that they could be used is extremely low because of your organization's unique requirements.

Therefore, if your organization performs CIAC processing, you should create a special SA type.

CIS Division/ SA Type	Service Type	Distrib. Code	Debt Class	CIAC Process	Bill Seg Type
CA/CIAC	Other	A/R - CIAC	UNRE	Refund based on percent of future bills	Billable Charge

Loan Segmentation

If you loan money to customers that is recouped using an amortization schedule, you need to set up an SA type for the loan service agreement.

CIS Division/ SA Type	Service Type	Distrib. Code	Loan A/R Distrib. Code	Debt Class	Bill Seg Type
CA/LOAN	Other	A/R - LOAN	A/R - STLN	UNRE	LOAN

FASTPATH:

Refer to [Setting Up The System To Enable Loans](#) for more information.

Non-Billed Budget Segmentation

If you allow your customers to pay set amounts at specified intervals (e.g. every two weeks), you need to set up SA types for Non-Billed Budget service agreements. Non-billed budgets are typically used when your company bills on an infrequent basis and you want to provide your customers with a mechanism to make smaller payments more frequently. You may implement two types of Non-Billed Budgets monitored and unmonitored, each type requiring a different SA type. You may also implement different renewal options for Non-Billed Budgets.

CIS Division/ SA Type	Service Type	Distrib. Code	Non Billed Budget Monitoring	Debt Class	Renewal	Bill Seg Type
CA/NBB-MON	Other	A/P - OVPY	Monitored	NBB	Optional	Not billed
CA/NBB-UNMON	Other	A/P - OVPY	Unmonitored	N/A	Optional	Not billed

FASTPATH:

For more information about monitored and unmonitored Non-Billed Budgets, refer to [Defining Non-Billed Budget Options](#).

Designing SA Type For Other Segmentations

The earlier parts of this discussion described the most common factors that cause the creation of SA Types. However, many obscure factors could cause the introduction of more SA Types. In this section, we explain these more obscure factors.

WARNING:

We strongly recommend not being too pedantic when considering the factors described in this section. If you can only think of a few strange situations that would necessitate a SA type, think carefully before you introduce it. It's better to be a little less than perfect than end up with large number of obscure SA types.

Cash Distribution Segmentation

Every SA Type has a payment segment type. The payment segment type defines the cash account to which the SA type's payments should be booked. If different service agreements have different cash accounts, you will need to split the SA types accordingly.

Adjustment Profile Segmentation

Every SA Type has one or more adjustment profiles. These profiles define the valid adjustment types that can be booked to the SA type's service agreements. If different service agreements within an SA type have different mixtures of valid adjustment types, you must split the SA types accordingly.

Late Payment Charge Segmentation

An option exists on SA Type that causes the system to generate a late payment charge if payment is not received on time. If you don't levy late payment charges on all service agreements, you will need to determine when you do and design your SA types accordingly.

In addition, if you levy late payment charges, the percentage levied and the algorithm that defines the amount of the outstanding balance subject to the charge is defined on the SA type.

Debt Classification Segmentation

Every SA Type has a debt class. The debt class is used to categorize a service agreement's debt for the purpose of credit and collections (C&C) analysis. If a given SA Type has different categories of debt from C&C's perspective, you must split the SA Type.

FASTPATH:

For more information about debt class, refer to [Designing Your Collection Procedures](#).

NOTE:

Write Off Debt Class vs. Normal Debt Class. An SA type references both write off debt class and normal debt class. An SA type's write-off debt class controls the write-off rules imposed on service agreements of a given type. An SA type's normal debt class controls the collection rules imposed on service agreements of a given type. Refer to [Different Collection Criteria For Different Customers And Different Debt](#) for more information about collection rules. Refer to [Different Write-Off Criteria For Different Customers And Different Debt](#) for more information about write-off rules.

Allow Estimates Segmentation

Every SA Type has a switch that controls whether the system should have Oracle Utilities Meter Data Management estimate consumption if meter reads are missing at billing time. If a given SA Type has different situations when the system should and should not estimate, you will have to split the SA Type.

NOTE:

Override. You can override the value of the SA Type's estimation switch on an individual service agreement. This means that if only a few service agreements don't abide by the SA Type's estimation switch, you can change the switch value of these service agreements.

Severance Criteria Segmentation

Every SA Type has severance criteria. The severance criteria define the severance process used to sever service if the customer doesn't pay. You can have multiple severance processes if different conditions warrant a different process. For example, you may have a different severance process if the customer has life support.

If you have a SA Type that requires different severance conditions other than those currently supported, you can make a programmatic change to introduce the additional conditions OR you can split the SA Type.

FASTPATH:

For more information about severance, refer to [Designing Your Severance Procedures](#).

Deposit Class Segmentation

Every SA Type that exists to hold a cash deposit will reference a deposit class. The deposit class defines the business rules that control various functions including interest calculation and refund criteria. You will need multiple deposit SA Types if any of the deposit class' rules / conditions differ for different types of deposits. For example, if residential customers use a different recommended deposit algorithm as compared to commercial customers, you'd need one SA type for residential deposits and another for commercial deposits (where the residential deposit SA type will reference the residential deposit class and the commercial deposit SA type will reference the commercial deposit class).

You will need additional deposit SA types if your customers can have multiple deposits where each deposit is restricted to a specific type of debt. For example, if separate deposits are held for regulated and unregulated debt (and a customer could hold a combination of regulated and unregulated debt), you'd need one SA type for regulated deposits and another for unregulated deposits.

FASTPATH:

For more information about deposit class, refer to [Designing and Defining Deposit Classes](#).

Sub SA Types

If you operate in a deregulated environment AND if you provide billing services for other service providers, you will need to create SA types to handle the billing of the service providers' charges.

FASTPATH:

Refer to [Designing Your SA Types And Start Options For Sub SAs](#) for more information.

Financial Settlement SA Types

If you operate in a deregulated environment, you may have to create financial settlement service agreements for the service providers. As explained in [Service Providers Have Service Agreements Too, We Bill For Them and They Bill For Us](#) service providers require a service agreement to hold adjustments used to increase how much you owe the service provider (or how much they owe you).

FASTPATH:

Refer to [Designing SA Types For Service Provider Financial Settlements](#) for more information.

Usage Request SA Types

Oracle Utilities Meter Data Management stores meter reading information and is responsible for calculating bill determinants during billing. The SA types for these customers will require special setup.

FASTPATH:

For more information about usage requests, refer to [The Big Picture Of Usage Requests](#).

Initial Consumption Period Considerations

Bill segments produced for a service agreement have two time periods:

- The bill segment period. The bill segment period defines the entire period of time covered by a bill segment's charges.
- The consumption period. The consumption period defines the period of time used to calculate the number of days for daily charges.

The consumption period almost always starts one day after the bill segment period. The consumption period always ends on the bill segment's end date. For example, a bill segment period that spans 5-Jan-2002 through 6-Feb-2002 will almost always have a corresponding consumption period of 6-Jan-2002 through 6-Feb-2002. The reason that the start dates don't match is because a bill segment's start date equals the end date of the prior bill segment (i.e., the start date was already counted in the previous bill segment's consumption period and we don't want to count it twice).

The only time when the previous paragraph isn't true is the first bill segment that's produced for a new service agreement. This is because different utilities count the first day of a new service agreement differently than others. Because of this, a flag exists on SA Type called **Initial Start Date Option**. This flag controls whether the service agreement's start date is included in the consumption period in a service agreement's first bill segment.

The following table describes the ramifications of the options you can set for this flag.

Flag Value	Consumption Period Calculation	Use This Option When
Add 1 Day Always	The consumption period's start date is calculated by adding 1 day to the service agreement's start date. (The SA start date is never included in the consumption period for the first bill segment.)	You want the initial bill and all subsequent bills to have a consistently calculated consumption period (i.e., the consumption period for the first and all other bills is always one day less than the bill segment's period).
Add 1 Day for Back-to-back	A back-to-back occurs when any service point for this service agreement was previously linked to a different service agreement that	You want to flexibly handle consumption period calculation. If you start customers on the same date as the stop date of the

was stopped on the same date that the new service was started (i.e., there is no gap in the service).

If a back-to-back is detected, the consumption period start date is calculated by adding 1 day to the SA start date.

If no back-to-back is detected, the start date of the consumption period is the SA start date.

previous customer, billing does not include the SA start date in the consumption period. However, if you start a new customer one day (or more) after the stop date of the previous customer, billing includes the first day of the service agreement in the consumption period.

Include First Day	The start date of the consumption period is the service agreement start date. (The SA start date is always included in the consumption period.)	You want to always include the first day AND you will never encounter a back-to-back situation.
-------------------	---	---

The example below shows how the consumption period would be calculated with the various options for a customer who starts service on January 1.

	First Bill Meter Read: Jan 31 Bill Segment Period: Jan 1 to Jan 31	Second Bill Meter Read: Feb 28 Bill Segment Period: Jan 31 to Feb 28	Third Bill Meter Read: Mar 31 Bill Segment Period: Feb 28 to Mar 31
Consumption period using Add 1 Day Always	Jan 2 to Jan 31 (30 days)	Feb 1 to Feb 28 (28 days)	Mar 1 to March 31 (31 days)
Consumption period using Add 1 Day for Back-to-back when back-to-back is detected	Jan 2 to Jan 31 (30 days)	Feb 1 to Feb 28 (28 days)	Mar 1 to March 31 (31 days)
Consumption period using Add 1 Day for Back-to-back when back-to-back is NOT detected	Jan 1 to Jan 31 (31 days)	Feb 1 to Feb 28 (28 days)	Mar 1 to March 31 (31 days)
Consumption period using Include First Day	Jan 1 to Jan 31 (31 days)	Feb 1 to Feb 28 (28 days)	Mar 1 to March 31 (31 days)

There may be SA types for which the value of this flag does not affect the consumption period calculation and still other SA types where this flag is never used. For example,

- For billable charge service agreements, the consumption period is equal to the start and end dates on the billable charge and therefore this flag is not applicable.
- A sub SA either inherits the consumption period from the master SA or it uses billable charges. As a result, billing does not use this flag.
- For some service agreements, the charges on the rate are not affected by the consumption period. For example, if you have a customer with a simple meter and a simple usage-based charge, billing calculates the amount of consumption between the start reading and end reading and applies the rate (i.e., the number of days in the consumption period doesn't impact the charges in some rates).
- Some service agreements are not billed, for example, [overpayment service agreements](#). For this type of service agreement and other types of service agreements that are not billed, this flag is not applicable. However, the system does not prevent a value from being entered in these cases to allow for an implementation process to use the flag if needed.

Setting this flag to an appropriate value is significant for certain types of service agreements.

- For services whose rate includes daily charges, the configuration of this flag may impact the first bill segment for the service agreement. For example, if the first bill period is October 1st through October 31st, do you consider consumption period to be 31 days or 30 days? How you want to bill the customer on the first bill determines how you set this flag.

- For service agreements that request usage (or bill determinants) based on interval data, the interval usage recordings typically begin on the first day of service. If you add 1 to the start date, you miss billing for intervals on the first day. In this case, you should set the value to Add 1 Day for Back-to-back.

Processing Sequence Considerations

You may have customers with a complex collection of contracts such that the calculation for one bill segment relies on information calculated by another bill segment for the same account. For example, perhaps you need to process your bill segments as follows:

- Step 1: Calculate bill segments for all the account's "single site" service agreements (i.e., each service agreement related to a single premise)
- Step 2: Calculate the bill segment for additional charges for the "head office" service agreement where the charges are based on the aggregated consumption of all premises from all bill segments (calculated in the first step).

To create the "head office" bill segment for the account, you must control the order in which the system creates the bill segments for each service agreement.

The SA type allows you to indicate a billing processing sequence that controls the order in which the service agreements are processed. The processing sequence is optional and service agreements are processed in ascending order of their SA type's billing processing sequence. As a result, SA Types with a processing sequence of zero are processed first, then 1, then 2, etc.

NOTE:

If you have sub SAs linked to a master SA, the billing processing sequence is used first to order the creation of bill segments for the master SAs. If you populate a processing sequence on an SA type for a sub SA, it is used to control the order in which the sub SAs for a given master SA are processed relative to each other. Refer to [Designing Your SA Types And Start Options For Sub SAs](#) for more information.

The billing processing sequence also controls the order of service agreements in the following other processes:

- Execution of pre bill completion algorithms. The system processes each service agreement in the billing processing sequence order. Within each service agreement, the pre bill completion algorithms on its [SA type](#) are processed in the order of the algorithm's sequence.
- Execution of bill completion algorithms. The system processes each service agreement in the billing processing sequence order. Within each service agreement, the completion algorithms on its [SA type](#) are processed in the order of the algorithm's sequence.

Designing Prepayment Billing Options

This section provides guidelines describing how to design service agreements that handle smart meter prepaid billing.

When a customer is subject to prepayment, normal cycle-based billing is not used to calculate the bill segments for their service. Rather, a prepay billing (PPB) process creates bill segments frequently (for example, daily) and periodically requests funds to maintain an adequate payoff balance. Bills will only be used to periodically inform the customer of the various financial transactions that have occurred since the last bill was produced.

Implementing prepayment billing requires the configuration of the following objects:

- SA Type
- Adjustment Types
- Bill Segment Type
- Service Task Type

These configuration tasks are described below.

NOTE: For additional information, see the detailed descriptions in the application for the C1-PrepayBillerTaskType and C1-PrepayBillerTask business objects.

SA Type for Prepay Billing

To configure a prepay billing SA Type, create a new SA type with the following attributes:

- Set the Special Role flag to **Bill Determinants Required**. The Prepay Option should be set to **Prepaid Smart Meter**.
- Specify the SA Creation system event with the algorithm CI_CREATEPPB to create the service agreement's prepay biller.
- Specify the Payment Freeze system event with the algorithm STPZ-RMVC to set current amount to zero on a payment.
- If required, specify the Bill Completion system event with an algorithm of the type C1-CREPPBBM to add a bill message that informs an end customer of their prepaid charges for the period. You may need to create an algorithm of this type if it does not exist in your system.
- **Eligible for Budget** should be set to false.
- Reference a new **Prepay Bill Segment Type**, which is described below.

The following adjustment types must also be defined on the prepay SA type:

- **Adjustment Type (Xfer)** specifies the type of adjustment used to transfer funds from the delinquent service agreements to the prepaid service agreement
- **Adjustment Type (Current=0)** specifies the type of adjustment used to set the prepaid current balance to zero after debt has been transferred
- **NSF Adjustment Type** specifies the type of adjustment used to levy an NSF charge. The NSF Adjustment Type is described in greater detail below.

The new SA types must be added to the data value mapping between CCB and MDM. This is to enable the synchronization of SAs of this type to MDM. The new CCB SA types can be mapped to existing US types in MDM. For additional information about this configuration, please see the integration documentation.

Adjustment Types for Prepay Billing

- **Funds Request Adjustment Type:** This adjustment type captures the type of adjustment used to request more prepaid funds. This adjustment type is specified on the prepaid biller task type. Specify the following algorithms on this adjustment type:
 - **Adj. Financial Algorithm** should reference the Adjustment FT creation algorithm ADJT-CA (Payoff=0/Current=Adj Amount (No GL)).
 - **Adjustment Freeze Algorithm** should reference an algorithm of the type C1-PPBADJFRZ (Set Prepaid Funds Request FT Details). You may need to create an algorithm of this type if it does not exist in your system.
- **NSF Adjustment Type:** For prepaid customers on autopay, when a user cancels an autopay tender the cancel reason must indicate that an NSF charge should be levied. The system invokes the NSF Charge algorithm specified on the tender's account's customer class which creates the NSF adjustment on the appropriate SA. The charge is levied using the NSF Adjustment Type specified on the SA's SA type. This adjustment type must reference the new adjustment freeze algorithm that will disable automatic payments on the PPB. This algorithm must be based on the algorithm type C1-DISPPBAP (Disable PPB's Automatic Payment). You may need to create an algorithm of this type if it does not exist in your system.

Bill Segment Type Required for Prepay Billing

Configure a new bill segment type for prepaid service agreements. This bill segment type should have the following attributes:

- **Create Algorithm** should be set to C1-BSBS-UR to create bill segment using a usage request.

- **Financial Algorithm** should be set to a new algorithm with algorithm type C1-NEM-GL (Payoff Amt = Bill Amt / Current Amt = 0 (GL affected)). You may need to create an algorithm of this type if it does not exist in your system.
- **Get Consumption Algorithm** should be set to C1-BSGC-USG to get bill segment consumption using a usage request.

Service Task Type for Prepay Billing

Configure a new service task type for prepay billing. This task type should reference the Prepay Biller (PPB) Task Type Business Object (C1-PrepayBillerTaskType). The task type must be specified on the new prepay billing SA creation algorithm. The task type captures the adjustment type used when an adjustment is created to request additional funds from the customer. Ensure that this adjustment type references the adjustment freeze algorithm (C1-PPBADJFRZ) that populates the financial transaction's arrears date.

SA Types And The Financial Design

In this section, we provide an example of how our SA Types map to Bill Segment Types, Payment Segment Types, and Adjustment Profiles. This example is meant to help solidify the power of the financial model, it is not necessarily indicative of how your specific implementation will look.

WARNING:

If you are not comfortable with the topics described in [Defining Financial Transaction Options](#), the following table will not make sense.

Division/SA Type	Distribution Code	Bill Segment Type	Payment Segment Type	Adjustment Profiles
CA/G-RES	A/R-UTIL	BD-RATED	NORMAL	BALXFER, MISCFEES, BUDGET
CA/G-COM	A/R-UTIL	BD-RATED	NORMAL	BALXFER, MISCFEES
CA/G-IND	A/R-UTIL	BD-RATED	NORMAL	BALXFER, MISCFEES
CA/W-RES	A/R-UTIL	BD-RATED	NORMAL	BALXFER, MISCFEES
CA/W-COM	A/R-UTIL	BD-RATED	NORMAL	BALXFER, MISCFEES
CA/W-IND	A/R-UTIL	BD-RATED	NORMAL	BALXFER, MISCFEES
CA/E-RES	A/R-UTIL	BD-RATED	NORMAL	BALXFER, MISCFEES, BUDGET
CA/E-COM	A/R-UTIL	BD-RATED	NORMAL	BALXFER, MISCFEES
CA/E-IND	A/R-UTIL	BD-RATED	NORMAL	BALXFER, MISCFEES
CA/WW-RES	A/R-UTIL	BD-RATED	NORMAL	BALXFER, MISCFEES
CA/WW-COM	A/R-UTIL	BD-RATED	NORMAL	BALXFER, MISCFEES
CA/WW-IND	A/R-UTIL	BD-RATED	NORMAL	BALXFER, MISCFEES
CA/CABLE	A/R-UTIL	BD-RATED	NORMAL	BALXFER, MISCFEES
CA/E-COY	E-COMP	COMPUSAG		
CA/G-COY	E-COMP	COMPUSAG		
CA/W-COY	E-COMP	COMPUSAG		
CA/VO-STD			NORMAL	BALXFER
CA/VO-LIA			NORMAL	BALXFER
CA/CONNECT			NORMAL	BALXFER, MISCFEES
CA/CHARITY	A/P-CHAR	RECUR	CHARITY	CHARITY

CA/PA-REGU	A/R-ARRG	RECUR-AS	NORMAL	BALXFER, MISCFEES, DPA
CA/PA-UNRE	A/R-ARRG	RECUR-AS	NORMAL	BALXFER, MISCFEES, DPA
CA/MERCH-I	A/R-MRCH	RECUR-AS	NORMAL	BALXFER, MISCFEES, MERCH
CA/DEP-I	A/P-DEPO	RECUR-AS	NORMAL	BALXFER, MISCFEES, DEPOSIT
CA/ONETIME	A/R-UTIL	BILLCHRG	NORMAL	BALXFER, MISCFEES
CA/OVR UNDR	EXP-OV/UND		NORMAL	
CA/OVERPAY	A/P-OVER		NORMAL	BALXFER
CA/SUSPENSE	A/R-SUSP		NORMAL	
CA/NBB	A/P-OVPY		NORMAL	BALXFER, MISCFEES, NBB

If you operate in a deregulated environment, you will also have additional SA types as described under [Designing Your SA Types And Start Options For Sub SAs](#) and [Designing SA Types For Service Provider Financial Settlements](#) you may have additional SA types.

Setting Up SA Types

In the previous section, Designing SA Types, we presented a case study that illustrated a mythical organization's SA types. In this section, we explain how to use the windows on the SA Type window group to maintain your SA Types.

SA Type - Main Information

Open **Admin > Customer > SA Type > Add** to define core information about your SA Types.

WARNING:

Every SA Type is owned by a CIS Division. This Division controls many values that can be referenced on the SA Type. If you don't understand Divisions and their place in the application, do NOT attempt to set up your SA Types. Rather, refer to [Setting Up CIS Divisions](#) before proceeding.

Description of Page

Enter a unique combination of **CIS Division** and **SA Type** for every service agreement type.

Enter a **Description** for the SA type.

Service Type defines the type of service associated with the SA type. If the SA type has rates, only rates belonging to this service type may be linked to the SA type.

Select the **Distribution Code** and **GL Division** that defines the receivable account for receivable-oriented service agreements. For non-receivable oriented service agreements, this distribution code is typically as follows:

- Charitable contributions. The distribution code is a charity payable account.
- Deposits. The distribution code is a deposit payable account.
- Non-Billed Budgets. The distribution code is an overpayment payable account.

- Company usage. The distribution code is a company usage expense account.
- Write off. The distribution code is a write-off expense account.
- Payment arrangements. The distribution code is a payment arrangement receivable account.

FASTPATH:

For more information about GL accounts, refer to [The Source Of GL Accounts On Financial Transactions](#).

Select the **Revenue Class** associated with the SA Type (and its service agreements). The revenue class may affect the revenue account(s) generated by the service agreement's rate.

FASTPATH:

Refer to [Designing Calculation Groups and Rules](#) for more information about revenue class.

Turn on **Start Options Required** if you want to force a customer service rep to choose a start option when they start service for this SA Type (on the Start Account window). If this switch is off and a rate is required for the SA Type, the system defaults the SA type's default rate on new service agreements. The default rate is defined on the SA Type - Rate page.

FASTPATH:

Refer to [Setting Up Start Options](#) for more information about the pros and cons of requiring start options.

Select the **Pay Segment Type** that defines how payment segments linked to service agreements of this type affect:

- The service agreement's payoff and current balances

FASTPATH:

For more information about payment segment types, refer to [Setting Up Payment Segment Types](#).

When a tender is canceled, a cancellation reason must be supplied. If the cancellation reason indicates a NSF (non sufficient funds) charge should be levied, the system invokes the Levy an NSF Charge algorithm specified on the tender's account's [customer class](#). Because adjustments must be linked to a service agreement, the algorithm must determine the appropriate service agreement to use to levy the adjustment based on business rules. The charge is levied using the **NSF Adjustment Type** of the appropriate service agreement's SA type.

WARNING:

You must specify adjustment type profiles on the SA type (on the Adjustment Type window) before adjustment types will appear in the above drop downs.

FASTPATH:

For more information about adjustment types, refer to [Setting Up Adjustment Types](#). For more information about cancellation reasons, refer to [Setting Up Payment Cancellation Reasons](#).

Select the **Payment Priority**. This field is available for use by the algorithms that distribute partial payments amongst an account's service agreements. Higher priority service agreements will have their debt relieved before lower priorities. Refer to Distribution Based on Payment Priority and Delinquent Payment Distribution Algorithm for information about payment distribution algorithms that use this field.

NOTE:

The values for this field are customizable using the Lookup table. This field name is PAY_PRIORITY_FLG.

FASTPATH:

For more information about distribution priority, refer to [Distributing A Payment Amongst An Account's Service Agreements](#).

Select the **Delinquent Payment Priority**. This field is available for use by the algorithms that distribute partial payments amongst an account's service agreements. Higher priority service agreements will have their debt relieved before lower priorities. Refer to [Delinquent Payment Distribution Algorithm](#) for information about a payment distribution algorithm that uses this field.

NOTE:

The values for this field are customizable using the Lookup table. This field name is DEL_PRIORITY_FLG.

Turn on **Do Not Overpay** if the system is not allowed to distribute an overpayment to this type of service agreement (i.e., the service agreement is not allowed to have a system-created credit balance). This field is available for use by algorithms that distribute overpayments. Refer to [Overpayments Held On Highest Priority Service Agreement](#) for information about an overpayment algorithm that uses this field.

Turn on **Late Payment Charge** if the system should generate a late payment charge for this type of service agreement if payment is not received on time. If this is turned on, you must define the **LPC Calc. Algorithm** used to calculate the late payment charge amount. Refer to [Defining Late Payment Charge Options](#) for more information about late payment charges. Examples of algorithm types used for calculating late payment charges are BILPC-SPRC and BILPC-TOTAL.

Define the **Adjustment Type (Synch Curr)** that will be used to synchronize (make equal) the current amount with the payoff amount on a service agreement of this type. This type of processing happens as follows:

- Most [write-off](#) algorithms that perform financial efforts (e.g., writing off debt), will issue an adjustment of this type if the service agreement's current and payoff balances are not equal.
- If a user stops a customer on a [budget plan](#), the system issues adjustments of this type to synchronize the customer's current and payoff balances.
- If a user stops a service agreement covered by a [Non-Billed Budget](#), the system issues adjustments of this type to synchronize the customer's current and payoff balances.
- If a [cancellation of a bill segment](#) occurs after a customer has stopped participating in a budget plan, an adjustment of this type is issued to synchronize the imbalance created when the bill segment's financial transaction is canceled.

Turn on **CIAC SA Type** and specify an appropriate **CIAC Refund Process** if service agreements of this type are used to bill for Contribution In Aid of Construction (CIAC) charges. Refer to [CIAC Segmentation](#) for more information.

SA Type - Detail

Open **Admin > Customer > SA Type > Search** and navigate to the **Detail** page to define additional details about a given SA type.

Description of Page

Turn on **Display As Alert** if Control Central should display an alert if an account has a service agreement of this type that isn't Closed or Canceled. If this switch is on, also enter the **Alert Information** to appear on Control Central. We recommend only using this feature on unusual SA types (e.g., payment arrangements, write-offs) so that a CSR is not presented with an alert for every SA type.

If this SA Type is used for any of the **Special Roles**, defined in the dropdown, indicate which one. Valid values are: Billable Charge, Cash Deposit, Loan, Non-Billed Budget, Payment Arrangement, Write Off, Bill Determinants Required. This information is used on windows with functionality that can only be used by service agreements used for specific roles. For example, the Billable Charge window group can only reference Billable Charge service agreements.

If Special Role is Cash Deposit, you must define the **Deposit Class** of the deposit. You should also define a **Deposit Class** on every SA type to which a given deposit can be distributed.

FASTPATH:

Refer to [What Do Deposit Classes Do?](#) for more information.

If the Special Role is Loan, you must also define the following fields:

- Use the **Interest Bill Factor** to define the bill factor code for the loan interest rate.
- Use **Override Interest** to indicate whether the interest rate defined on the interest bill factor may be overridden at the SA level. If you select Allowed, the interest rate may be overridden by a contract value on a start option or the SA.
- Use the **Loan A/R Distribution Code** to define the distribution code to be used when posting the short-term receivable amount to the general ledger (the normal distribution code is used for the long-term receivable). If the normal distribution code is the same as the **Loan A/R Distribution Code**, the SA type does not differentiate between long- and short-term receivables. If the two distribution codes are different, the SA type differentiates between long- and short-term receivables.

FASTPATH:

Refer to [Defining Loan Options](#) for more information about **Interest Bill Factor**, **Override Interest** and **Loan A/R Distribution Code**.

If the Special Role is Non-Billed Budget , you must also define the following:

- Use **Adjustment Type (Xfer)** to specify the type of adjustment used to the transfer accumulated credit from the Non-Billed Budget SA to the SAs covered by the Non-Billed Budget when the account is billed or the Non-Billed Budget SA is stopped.
- Use the **Non-Billed Budget Monitoring** to specify whether the Non-Billed Budget is monitored by the account debt monitor.

If the SA type is defined as Eligible for Non-billed Budget, you must also define the following:

- Use **Adjustment Type (Current=0)** to specify the type of adjustment used to set the service agreement's current balance to zero when a service agreement of this type is linked to an active, monitored Non-Billed Budget.

If the Special Role is Payment Arrangement and you have not enabled Use Alternate PA Creation Logic, you must also define two adjustment types:

- Use **Adjustment Type (Xfer)** to specify the type of adjustment used to transfer funds from the delinquent service agreements to the payment arrangement service agreement.
- Set **Use Alternate PA Creation Logic** if your payment arrangement SA Types share a debt class with other SA Types. When this is set, the current balance on the transfer adjustment on the payment arrangement SA is set to zero instead of using the below adjustment type to set the current balance to zero. When payment arrangements are in their own debt class, the additional credit adjustment offsets the transfer adjustment. This results in an offsetting credit and debit in the payment arrangement debt class and a single credit on the non-payment arrangement debt class. However, when a single debt class is used, the two credits inaccurately impact the way debt age (arrear) is calculated and presented. Using the alternate PA creation logic ensures that debt age is calculated and displayed accurately when a single debt class is used.
- Use **Adjustment Type (Current=0)** to specify the type of adjustment used to set the payment arrangement's current balance to zero after funds have been transferred.

If the Special Role is Write Off, you must also define the following adjustment types:

- Use **Adjustment Type (Xfer)** to specify the type of adjustment used to transfer funds from the uncollectable service agreements to the write off service agreement.

NOTE:

It may be important to your organization to track the original source of debt that is being written off. The system is delivered with three characteristic types: C1-WODST, C1-WOCHT, and C1-WOCHV that can record the distribution code, characteristic type and characteristic value from the FT GL(s) being written off onto the write off adjustment. To

enable this logic, specify these characteristic types as allowable characteristic types on your write off transfer adjustment type.

If the Prepay Option is **Prepaid Smart Meter**, you must also define two adjustment types:

- Use **Adjustment Type (Xfer)** to specify the type of adjustment used to transfer funds from the delinquent service agreements to the prepaid service agreement.
 - Use **Adjustment Type (Current=0)** to specify the type of adjustment used to set the prepaid current balance to zero after debt has been transferred.
-

WARNING:

You must specify adjustment type profiles on the SA type (on the Adjustment Type window) before adjustment types will appear in the above drop downs.

The **Stop Option** can be used to automatically stop a service agreement when all other service agreements of an account are stopped. Valid values are: Automatically Stop SA. When all service point related service agreements of an account are stopped then all additional service agreements where the **Stop Option** is set to Automatically Stop SA will also be stopped. This is useful, for example, with charitable contribution service agreements. The charity service agreement should be stopped when all utility related services are stopped.

FASTPATH:

Refer to [The Lifecycle of a Service Agreement](#) for more information on the **Stop Option**.

Turn on **One Time Charge** if this SA type is used for one-time invoices. When a one-time invoice service agreement is created, the system sets the stop date of the SA to be equal to the start date.

Turn on **Sub SA** if this SA type is used to define the business rules for sub service agreements.

FASTPATH:

Refer to [Sub Service Agreements](#) for more information about sub service agreements.

Renewal of SAs of this type may be Optional, Not Allowed or Required depending on your business processes. If renewal is not allowed, the SA expires on the expiration date. Renewal treatment is an important consideration for SAs that require an expiration date, such as [non-billed budget SAs](#).

If renewal is required or optional, specify the **Days Before Expiration for Renewal**. Note that currently this is only used by Non-Billed Budgets to calculate the renewal date based on the expiration date.

If the Special Role is Non-billed Budget, **Non-Billed Budget Monitoring** must indicate whether the Non-Billed Budget is monitored by the account debt monitor.

FASTPATH:

Refer to [Credit and Collections and Non-Billed Budgets](#) for more information about monitoring Non-Billed Budgets.

Set **Eligible for Payment Arrangement** to Eligible if this SA type can be included in a payment arrangement.

NOTE: This is automatically set to Ineligible on SA types with a Special Role of Payment Arrangement.

Where Used

The alert information is used by Control Central to alert a CSR when unusual service agreements exist for an account. Refer to [Control Central - Search](#) for more information.

Only SA types designated as being Billable Charge may have billable charges linked to them. Refer to [Maintaining Billable Charges](#) for more information.

Only SA types designated as being Cash Deposit are processed by the various deposit-related background processes (e.g., interest calculation, automatic refund, etc.). Refer to [The Big Picture Of Deposits](#) for more information.

Only SA types designated as Loan are used to define the loan terms for a loan SA. Refer to [Loans](#) for more information.

Only SA types designated as Non-billed Budget may be used to set up Non-Billed Budgets. Refer to [Non-Billed Budgets](#) for more information.

Only SA types designated as being Payment Arrangement may be used on the payment arrangement window group. Refer to [Setting Up Payment Arrangements](#) for more information.

Only SA types designated as being Write Off may be specified as the write off SA type on distribution codes. Refer to [Setting Up Distribution Codes](#) for more information.

Only service agreements whose SA type is designated as being Write Off appear on the Write Off SAs query. Refer to [Write Off - Write Off SAs](#) for more information.

SA Type - Billing

Open **Admin > Customer > SA Type > Search** and navigate to the **Billing** page to define how the system manages bill segments for service agreements of a given SA type.

Description of Page

Turn on **Eligible for Billing** if the system should create bill segments for service agreements of this type. This will typically be turned on for all service agreements except for those used to hold write-off amounts or to levy one-off adjustments.

Define the minimum number of days a bill segment (other than the final segment) must span using **Minimum Days for Billing**. This is useful to prevent initial bill segments that span only a few days.

FASTPATH:

For more information about minimum days, refer to [Preventing Short Bill Segments](#).

Select the **Bill Segment Type** that controls both how bill segments for this SA Type will be created and how the related financial transaction affects the general ledger and the customer's debt.

FASTPATH:

For more information about bill segment types, refer to [Setting Up Bill Segment Types](#).

Use **Default Description on Bill** to define the verbiage that should print on the customer's bill.

NOTE:

Rates overwrite this description. The Default Description on Bill is not applicable for service agreements whose charges are calculated using a rate. Why? Because the description that appears on the bill segment is defined on the rate schedule's rate version calculation group.

Billable charges overwrite this description. The Default Description on Bill is not applicable for service agreements whose charges are calculated using a billable charge. Why? Because the description that appears on the bill segment is defined on the billable charge.

Use the **Billing Processing Sequence** if you need to control the order in which service agreements linked to this SA type are processed by billing.

FASTPATH:

Refer to [Processing Sequence Considerations](#) for more information.

Use **Bill Print Priority** to define the order in which the SA type's bill segments should appear on bills (relative to the other SA types that appear on a bill).

NOTE:

The values for this field are customizable using the Lookup table. This field name is BILL_PRT_PRIO_FLG.

Use **Max Bill Threshold** if you want the system to generate a bill error when a bill segment is produced in batch that exceeds a given value. These bill errors will appear on the standard billing queries and To Do lists. If, after reviewing the high value bill segment, an operator truly intends to send the bill out, they should regenerate the bill. Refer to [How To Correct A Bill Segment That's In Error](#) for more information.

WARNING:

The value entered in this field will DEFAULT onto service agreements of this type when they are first created. An operator may change the default value on a service agreement in case a specific customer has unusually high bills that continually error out. It's important to be aware that if you change the value of High Bill Amount on an SA type and there already exist service agreements of this type, the existing service agreements will contain the original value (the new value on the SA type will not be propagated on the existing service agreements).

Use **Graph Unit Of Measure** to define the unit of measure of the graphed consumption on the bill (if any).

Turn on **Allow Estimates** if the system should indicate to Oracle Utilities Meter Data Management whether to generate estimated consumption if meter reading(s) cannot be found at billing time. This value is defaulted onto service agreements and can be overridden on an individual service agreement.

Turn on **Characteristic Premise Required** if a characteristic premise must be linked to the service agreement when the service agreement is activated. The characteristic premise is used to define the taxing authorities associated with the service agreement's bill segments. It is also used to identify where the service agreement's service is located on various windows.

FASTPATH:

For more information about how characteristic premise is used, refer to [An Illustration Of A Bill Factor And Its Characteristics](#).

Use the **Initial Start Date Option** to control how billing should calculate the consumption period for the very first bill for service agreements of this type. This field is not applicable for sub SA types or SA types with a special role of Billable Charge. Valid values are Include First Day, Add 1 Day Always and Add 1 Day for Back-to-back. Refer to [Initial Consumption Period Considerations](#) for more information.

Non-metered service agreements may have the end date of their bill segments defined on a user-maintained bill period schedule. This option is used when bill segments must fall on strict calendar boundaries (e.g., quarterly bills that end on the last day of the quarter). If this SA type should be billed like this, select Use Bill Period in the **Use Calendar Billing** field. When this option is used, you must define the **Bill Period** whose schedule defines the bill segment end dates.

FASTPATH:

For more information about bill period schedules, refer to [Designing Bill Periods](#). For more information about other bill end date methods, refer to [Ways To Control The End Date Of A Bill Segment](#).

Instead of the Use Bill Period method, non-metered service agreements may have their bill segment end date based on the first day of service. For example, if service started on the 16th of some month, the ongoing bill segments will start on roughly the 16th of each month. This option is frequently used to bill for garbage or cable service. If this SA type should be billed like this, select Anniversary Future Billing or Anniversary Past Billing in the **Use Calendar Billing** field. When either option is used, you must define the **Anniversary Bill Frequency**. This frequency defines the amount of time between bill segments.

FASTPATH:

For more information about anniversary billing, refer to [Using The Anniversary Method](#). For more information about other bill end date methods, refer to [Ways To Control The End Date Of A Bill Segment](#).

Total Bill Amount indicates whether service agreements of this type can use the total amount to bill field on the service agreement page. Valid values are Not Allowed and Required. Only SA types used to bill for deposits or loans should have this field set to Required.

If Required is selected, you must enter the **Total Amount To Bill Label**. The **Total Amount To Bill Label** defines the label that prefixes the total bill amount on the service agreement page for service agreements of this SA type.

FASTPATH:

For more information about total amount to bill and deposit service agreements, refer to [Total Amount To Bill](#). For more information about total amount to bill and loan service agreements, refer to [Setting Up The System To Enable Loans](#).

Recurring Charge indicates whether service agreements of this type can use the recurring charge field on the service agreement window. Valid values are Not Allowed, Optional and Required. If either Optional or Required are used, you must enter:

- **Recurring Chg Amt Label**. This defines the label that prefixes the recurring charge amount on the service agreement window for service agreements of this SA type.
 - **Recurring Charge Frequency**. This defines the following:
 - Specifies the frequency at which the Recurring Charge Amount specified on service agreements of the SA Type is to be billed.
 - Serves as the basis for proration of the Recurring Charge Amount.
 - Specifies the frequency at which service agreements of the SA Type without a rate and/or meters will be billed.
-

FASTPATH:

For more information about how to use the recurring charge information, refer to [Charitable Contribution Segmentation](#), [Merchandise Segmentation - Installment Billing](#), [Deposit Segmentation - Installment Billing](#), [Payment Arrangement Segmentation](#), [Budget Billing Segmentation](#), [The Terms Of A Loan Are Stored On A Service Agreement](#).

Turn on **Eligible for Budget** if service agreements of this type can participate in budget billing. If this switch is turned on, then you must define the **Adjustment Type (Synch Current)** that will be used to synchronize (make equal) the current amount with the payoff amount on a service agreement of this type when a budget is cancelled. (The Adjustment Type (Synch Current) field is on the main page.)

FASTPATH:

Refer to [Budget Billing](#) for more information about budgets in general. Refer to [Budget Billing Segmentation](#) and [Designing and Defining Budget Plans](#) for more information.

Set the **Eligible for Non-Billed Budget** flag to Eligible for Non-Billed Budget if you want SAs of this type to be eligible to be covered by a Non-Billed Budget. If this flag is set to Eligible for Non-Billed Budget, you must also define the **Adjustment Type (Current = 0)** field (on [SA Type - Detail](#)).

FASTPATH:

Refer to [Current Amount For SAs Covered By A Non-Billed Budget](#) and [SA Types for SAs Covered by Non-Billed Budgets](#) for more information.

Require Total Amount Switch versus Bill Segment Algorithm

The following table shows valid combinations of the SA type's required total amount switch and the bill segment creation algorithm defined on the SA type's bill segment type. If N/A appears in a cell, the combination is not supported in the system. Otherwise, we list typical types of service agreements that will use a combination.

Bill Segment Create Algorithm	SA Type Require Total Amount Switch:	SA Type Require Total Amount Switch:
	Not allowed	Required
Apply Rate To Usage Request	Metered services. Lamp services. Misc item services. Company usage. Misc recurring charges whose value is specified in a rate or is taxable.	N/A
Recurring Charge With Auto Stop	Payment arrangements. Merchandise installment plans. Zero-interest loans.	N/A
Recurring Charge For Amount To Bill	N/A	Deposit installment plans.
Recurring Charge	Charitable contributions.	N/A
Billable Charge	One time invoices. Pass through charges	N/A
Loan	N/A	Loans.

Allow Recurring Charge Switch versus Bill Segment Algorithm

The following table shows valid combinations of the SA type's allow recurring charge switch and the bill segment creation algorithm defined on the SA type's bill segment type. If N/A appears in a cell, the combination is not supported in the system. Otherwise, we list typical types of service agreements that will use a combination.

Bill Segment Create Algorithm	SA Type Recurring Charge Switch:	SA Type Recurring Charge Switch:	SA Type Recurring Charge Switch:
	Not allowed	Optional	Required
Apply Rate To Usage Request	Metered services - no budget Lamp services Misc item services. Company usage. Misc recurring charges whose value is specified in a rate or is taxable.	Metered services - budget optional	Metered services - budget required
Recurring Charge With Auto Stop	N/A	Payment arrangements. Merchandise installment plans.	Payment arrangements. Merchandise installment plans.

		Zero-interest loans. SEE NOTE!	Zero-interest loans. SEE NOTE!
Recurring Charge For Amount To Bill	N/A	Deposit installment plans. SEE NOTE!	Deposit installment plans. SEE NOTE!
Recurring Charge	Charitable contributions	N/A	N/A
Billable Charge	One time invoices. Pass through charges	N/A	N/A
Loan	N/A	N/A	Loans.

NOTE:

Most recurring charge SA types require a recurring charge amount on their service agreements. However, the above matrix indicates you can have recurring charge SA types where this value is optional. Why? A special algorithm exists in billing that says if the recurring charge amount is 0 (zero) the system will bill the remaining payoff balance or total amount to bill. This algorithm exists so that you can easily bill the amount in one lump sum (i.e., don't bill it in installments).

Where Used

The billing information is used when the system creates a bill segment for service agreements of this type.

SA Type - Rate

Open **Admin > Customer > SA Type > Search** and navigate to the **Rate** page to define the rates that may be referenced on service agreements of a given type.

Description of Page

Turn on **Rate Required** if the bill segment creation algorithm for the SA type expects a rate schedule to be referenced on service agreements of this type.

FASTPATH:

For more information, refer to [Rates](#).

When a rate changes within a bill segment's consumption period, the period is divided into separate usage periods – one for each active rate schedule during that period. The usage periods and their related consumption (or billable quantities) are then prepared for billing, and the rate schedule calculations are applied to their associated periods.

This feature is possible if the usage subscription type is configured with the base Dynamic Usage Group Determination algorithm, which determines the applicable usage group for each effective rate schedule. This algorithm requires that the CCB rate schedule has usage group extendable look-ups configured for the rate schedule and device configuration type combinations.

A typical use case is when there is a smart meter rollout in the middle of billing period and there are rate schedule changes that coincide with the meter exchange date. The usage group that is tied to the old meter will have rules that calculate scalar consumption, and the usage group that is tied to the new meter will have rules that calculate interval consumption. The end result is that the customer is billed with scalar consumption for the period where old meter was installed, and billed with interval consumption for the period where new meter is installed.

If the Contract Management module is not [turned off](#), which includes [umbrella agreement management](#), indicate the **Rate Source**. Check SA Only indicates that the rate schedule currently in effect for the service agreement should always be

used. Check TOS First, then SA indicates that if the service agreement is linked to a terms of service record, the service agreement's rate could be [overridden by one linked to the terms of service](#) record.

The information in the **Rate Schedules** collection defines the rates that may be referenced on service agreements of this type. The following fields are required for each SA Type:

Rate Schedule Specify the rate schedule; its description is displayed adjacent.

Use As Default Turn on this switch for the rate to be defaulted on new service agreements.

Rate Required versus Bill Segment Algorithm

The following table shows appropriate combinations of the SA type's rate required switch and the bill segment creation algorithm defined on the SA type's bill segment type. If N/A appears in a cell, the combination is not applicable. Otherwise, we list typical types of service agreements that will use a combination. Be aware that no cross validation exists between the rate required switch and the bill segment creation algorithm when setting up the SA type.

Bill Segment Create Algorithm	SA Type Rate Required Switch:	SA Type Rate Required Switch:
	Not allowed	Rate required on SA
Apply Rate To Usage Request	N/A	Metered services. Lamp services. Misc item services. Company usage.
Recurring Charge With Auto Stop	Payment arrangements. Merchandise installment plans. Zero-interest loans.	N/A
Recurring Charge For Amount To Bill	Deposit installment plans.	N/A
Recurring Charge	Charitable contributions.	N/A
Billable Charge	One time invoices.	Billable charges that require a rate to add-on extra charges (like taxes) or billable charges where the consumption is interfaced and the system is responsible for calculating the charges.
Loan	Loans.	N/A

Where Used

This information is used to default and validate the rate specified on a service agreement. Refer to [Service Agreement - Rate Info](#) for more information.

SA Type - SP Type

Open **Admin > Customer > SA Type > Search** and navigate to the **SP Type** page to define the service point types that may be referenced on service agreements of a given type.

Description of Page

Turn on **Service Points Required** if at least one service point should be linked to service agreements of this type in order to properly bill the service agreements.

The information in the **SP Types** collection defines the service point (SP) types that may be referenced on this SA type's service agreements. The following fields are required for each SA Type:

SP Type Specify the SP type; its description is displayed adjacent.

FASTPATH:

For more information about SP types, refer to [Designing SP Types](#).

Where Used

This information is used to validate the types of service points linked to a service agreement. Refer to [Service Agreement - SA / SP](#) for more information.

SA Type - Adjustment Profiles

Open **Admin > Customer > SA Type > Search** and navigate to the **Adj Profile** page to define the adjustment profiles that define adjustment types that may be referenced on service agreements of a given type.

Description of Page

Define the **Adjustment Type Profiles** that, in turn, define adjustment types that may be referenced on service agreements of a given type.

FASTPATH:

For more information about adjustment type profiles, refer to [Setting Up Adjustment Type Profiles](#).

Where Used

This information is used to validate the adjustments linked to the service agreement. Refer to [Adjustment - Main Information](#) for more information.

SA Type - C&C

Open **Admin > Customer > SA Type > Search** and navigate to the **C&C** page to maintain attributes that affect how the system severs the service agreement when collection attempts fail.

FASTPATH:

Refer to [Designing Your Severance Procedures](#) for more information.

Description of Page

Select the **Debt Class** associated with the SA Type. Any debt on a service agreement of this SA Type will be categorized under this debt class.

Select the **Write Off Debt ClassCode** associated with the SA Type. Any debt on a service agreement of this SA Type will be categorized under this debt class during write-off processing.

NOTE:

Write Off Debt Class vs. Regular Debt Class. It's important to be aware that a SA type references both a regular debt class and a write-off debt class. The regular debt class controls the collection criteria applied against an account's service agreements. The regular debt class is also used to segregate an account's outstanding balance on several queries in the system. The write-off debt class controls the write-off criteria applied against an account's stopped service agreements. The reason the system supports two different debt classes is because you may categorize your service agreements

differently when you try to collect overdue debt versus when you write-off debt. Refer to [The Big Picture Of Write Off Processing](#) for more information.

The information in the **Severance Criteria** collection defines the SA Type's severance criteria. Severance criteria define the severance process to be executed for service agreements of a given SA type. The severance process may differ depending on some attribute of the customer or premise. For example, you may have a different severance process if the customer has life support equipment.

FASTPATH:

The following information is not intuitively obvious. Refer to [Designing Your Severance Procedures](#) for more information.

The following fields are required for each instance:

Priority The priority controls the order in which the system determines if the severance process should be applied (the first severance process whose algorithm applies is used). Higher priorities are checked before lower priorities.

Severance Criteria Algorithm Select the algorithm to be used to check if the severance process should be initiated for service agreements of this type. If a condition is met, a severance process is created using the associated severance process template.

If you haven't done so already, you must set up this algorithm in the system. To do this:

- Create a new algorithm (refer to [Setting Up Algorithms](#)).
 - On this algorithm, reference an Algorithm Type that determines if the severance of a service agreement should be processed using the associated **Severance Process Template**.
-

IMPORTANT:

You must have at least one entry in this collection otherwise the system will not start a severance process when a service agreement of this type needs to be stopped due to non payment. This entry should have the lowest priority code and should reference a **Severance Criteria Algorithm** that references the SV CRIT DFLT algorithm type.

Severance Process Template Specify the severance process template to use to sever the service agreement; its description is displayed adjacent.

Where Used

The debt class has multiple uses:

- The system summarizes an account's debt by debt class on [Account - Main Information](#) and [Account - Financial Balances](#).
- Debt class is one component that controls how the system analyzes an account's overdue debt (the others are the account's collection class and currency). Refer to [Different Collection Criteria For Different Customers And Different Debt](#) for more information.
- Write off debt class is one component that control how the system writes off an account's stopped service agreements. Refer to [Different Write-Off Criteria For Different Customers And Different Debt](#) for more information.

The severance criteria are used when a collection event is activated that indicates that service should be severed.

SA Type - Billable Charge Template

Open **Admin > Customer > SA Type > Search** and navigate to the **BC Template** page to define the billable charge templates that can be used on service agreements of a given type.

NOTE:

Only billable charges have billable charge templates. Only service agreements that are defined as Billable Charges (in the Special Role on the Details window) may use the grid on this window.

Description of Page

The information in the **Billable Charge Template** collection defines the SA Type's permissible billable charge templates. A billable charge template contains the default bill lines, amounts and distribution codes used to levy a one-off charge. The following fields are required for each template:

Billable Charge Template Specify the billable charge template. Its description is displayed adjacent.

Use As Default Turn on this switch for the template to be defaulted on new billable charges linked to service agreements of this type (if any).

FASTPATH:

For more information about billable charge templates, refer to [Setting Up Billable Charge Templates](#).

Where Used

This information is used to limit the billable charge templates that can be used for a given SA type.

SA Type - Characteristics

To define characteristics common to all service agreements of a given type, open **Admin > Customer > SA Type > Search** and navigate to the **Characteristics** page.

Description of Page

Use the characteristics collection to define a **Characteristic Type**, **Sequence**, and **Characteristic Value** common to all service agreements of this type.

NOTE:

You can only choose characteristic types defined as permissible on a SA Type record. Refer to [Setting Up Characteristic Types & Their Values](#) for more information.

SA Type - Algorithms

Open **Admin > Customer > SA Type > Search** and navigate to the **Algorithm** page to define the algorithms that should be executed for service agreements of a given type.

Description of Page

The grid contains **Algorithms** that control important functions in the system. You must define the following for each algorithm:

- Specify the **System Event** with which the algorithm is associated (descriptions of all possible events are provided below).
 - Specify the **Sequence** and **Algorithm** for each system event. You can set the **Sequence** to 10 unless you have a **System Event** that has multiple **Algorithms**. In this case, you need to tell the system the **Sequence** in which they should execute.
-

WARNING:

These algorithms are typically significant processes. The absence of an algorithm may prevent the system from operating correctly.

The following table describes each **System Event** for which you can define algorithms.

System Event	Optional / Required	Description
Bill Completion	Optional	<p>These algorithms are executed whenever a bill is completed for an account that contains a non-canceled service agreement of this type. The following situations necessitate the definition of a completion algorithm on an SA type:</p> <ul style="list-style-type: none"> - As explained under Technical Implementation of A/R Transfer and Technical Implementation of Routing Billable Charges To Service Providers, when a bill is completed, the system needs to set up the data necessary to interface any "master" SA's charges to the service provider and to transfer the receivable balance from the customer to the service provider. The system will only do this if you specify an appropriate algorithm on the master SA types. - As explained under Billing For SAs Covered By The Non-Billed Budget, when a bill is completed for accounts that have a Non-Billed Budget SA, the system needs to distribute the Non-Billed Budget's credit balance to the covered SAs. The system will only do this if you specify an appropriate algorithm on the NBB SA types. - As explained under Overpayment Segmentation, when a bill is completed, the system may apply an excess credit from a prior overpayment to an account's service agreements. <p>Note. Algorithms of this type are called for all non- Canceled service agreements, regardless of whether or not they are billed. If your algorithms should only be processed under certain conditions (for example, only process this algorithm for Active service agreements), then it is the responsibility of the algorithm to check the conditions before continuing.</p>
Bill Eligibility	Optional	<p>These algorithms are executed during billing and allow logic to be introduced to check additional criteria to determine if an SA is eligible for billing.</p>

Break NBB SA	Optional	<p>These algorithms are executed when a Non-Billed Budget is manually stopped via the Non-Billed Budget maintenance page.</p> <p>Note that the Payment Arrangement algorithm and the Break Pay Arrangement algorithm are mutually exclusive.</p>
Break Pay Arrangement	Optional	<p>These algorithms are by executed by severance events when the event is created for payment arrangement SAs. This algorithm should be specified on SA types with a special role of Payment Arrangement to perform special actions that take place when a customer breaks a payment arrangement. Refer to Monitoring Payment Arrangements for more information about breaking payment arrangements.</p>
Budget Eligibility	Optional	<p>These algorithms are executed when determining in a service agreement is eligible for budget. Algorithms of this type are only applicable on SA types that are marked as eligible for budget and may be used to override that setting and indicate that the service agreement is not eligible.</p> <p>For example, maybe service agreements in a certain rate are not eligible. Or perhaps service agreements with a given characteristic value are not eligible.</p>
Cut Process Rule	Optional	<p>These algorithms are executed to create a cut process for service agreements of this type. Refer to The Big Picture Of Cut Processes for more information.</p>
FT Freeze	Optional	<p>These algorithms are executed whenever a financial transaction is frozen that is linked to a service agreement of this type. The following situations necessitate the definition of an FT freeze algorithm:</p> <ul style="list-style-type: none"> - As explained under Technical Implementation of Routing Consumption To Service Providers, when a master SA's bill segment is frozen, the system must check if there are any service providers who need the bill segment's consumption. If so, it sets up the data necessary to interface the master SA's consumption (snapshot on the bill segment) to the service provider(s). The system will only do this if you specify an appropriate FT Freeze Algorithm on the master SA types. - As explained under Technical Implementation of Paying The Service Provider, when a financial transaction (FT) is

frozen that is associated with a sub SA, the system must check if this FT should trigger the "payment" of a service provider. If so, it has to create an adjustment to increase how much we owe the service provider. The system will only do this if you specify an appropriate FT Freeze Algorithm on the sub SA types.

High Bill Amount	Optional	<p>This algorithm type checks for high bill amounts during batch billing. A bill threshold amount can be defined on a service agreement. By default the system compares this threshold amount to the bill segment amount during batch billing. If the bill segment amount exceeds the given threshold value, a bill error is generated. No proration takes place on the threshold amount if the bill segment's consumption period falls outside of the rate frequency's normal period.</p> <p>This algorithm may be used to override the default system behavior. It will prorate the SA's bill threshold amount before comparing it to the batch bill segment amount if the consumption period falls outside of the rate frequency's normal period.</p>
Landlord Reversion	Optional	<p>These algorithms are used to create, update or cancel a service agreement for a landlord when service is started, stopped or updated for a premise that references a landlord agreement.</p> <p>Algorithms of this type are called:</p> <ul style="list-style-type: none"> - When starting a new SA (start initiation) - When stopping an SA (stop initiation) - When canceling a pending start SA - When changing the stop / start dates of back-to-back service agreements
Loan Interest Charge	Optional	<p>These algorithms are executed whenever the interest charge needs to be calculated for a loan, such as when the loan amortization schedule is created and when a bill segment is created for a loan SA. This algorithm should be specified on SA types with a special role of Loan. Refer to Defining Loan Options for more information.</p>
Loan Periods and Amount	Optional	<p>These algorithms are executed whenever a user clicks the Calculate button on Loan - Main or on the Start SA Confirmation dialog for a loan SA. It calculates either the number of periodic payments or the payment amount (depending on whether the user specifies the number of payments or the payment amount</p>

		as input). This algorithm should be specified on SA types with a special role of Loan. Refer to Defining Loan Options for more information.
Loan Schedule	Optional	These algorithms are executed whenever the system needs to create a loan amortization schedule for a loan, such as when you renegotiate the terms of a loan on Loan - Main . This algorithm should be specified on SA types with a special role of Loan. Refer to Defining Loan Options for more information.
Override Proration Days	Optional	This algorithm is invoked from rate application, right after base has determined if proration applies. It is used to override base days, normal days and "is within proration window" indicator, which were determined by base logic. Only one algorithm may be plugged-in to this system event. This is available only in the calculation rule based rating engine.
Payment Arrangement	Optional	These algorithms are by executed to handle the creation, breaking and canceling of payment arrangement SAs. This algorithm should be specified on SA types with a special role of Payment Arrangement to perform special actions that take place during the lifecycle of a payment arrangement. Refer to Monitoring Payment Arrangements for more information about payment arrangements. Note that the Payment Arrangement algorithm and the Break Pay Arrangement algorithm are mutually exclusive.
Payment Freeze	Optional	These algorithms are executed whenever a payment is frozen. The following situations necessitate the definition of such an algorithm: - For a loan SA, such an algorithm is required to create a frozen adjustment that transfers any credit balance resulting from an overpayment to the loan's principal balance. Refer to Defining Loan Options for more information.
Pre-Bill Completion	Optional	These algorithms are executed immediately prior to bill completion when a bill contains a bill segment for a service agreement whose SA type has such an algorithm. The following situations necessitate the definition of such an algorithm: - If you want to delete a bill segment that's in error on the last night of a bill cycle when there are other bill segments that aren't in error, use such an algorithm.

Process NBB Scheduled Payment	Optional	These algorithms are executed by the NBB Scheduled Payment Processing background process whenever a scheduled payment is due. If the Non-Billed Budget SA is unmonitored, this algorithm is not called. This algorithm should be specified on Non-Billed Budget SA types to create the necessary adjustments for the Non-Billed Budget SA.
Proposal SA Acceptance	Optional	These algorithms are executed when a proposal service agreement is accepted. Refer to Enabling The Creation Of A Real Service Agreement for more information.
Proposal SA Bill Segment Generation	Optional	These algorithms are executed to generate simulated bills segments for a proposal service agreement . Refer to Enabling The Generation Of Simulated Bill Segments for more information.
Proposal SA Creation	Optional	These algorithms are executed when a proposal service agreement is created. Refer to Enabling The Automatic Generation Of Billing Scenarios for more information.
SA Activation	Optional	<p>These algorithms are executed when a service agreement status changes from Pending Start to Active. It performs any additional activities that are necessary to activate an SA. The following situations necessitate the definition of such an algorithm:</p> <p>If you want to create a customer contact to indicate that a non-billed budget has been activated, use such an algorithm.</p>
SA Cancel	Optional	<p>These algorithms are executed when a service agreement status changes to Canceled. It performs any additional activities that are necessary to cancel an SA.</p> <p>An example of when you may use this algorithm is that perhaps your business rules dictate that the creation of a payment arrangement should create a credit rating history transaction. When a payment arrangement SA is canceled, the credit rating should be updated with an end date.</p>
SA Creation	Optional	<p>These algorithms are executed when a service agreement is created. The following situations necessitate the definition of such an algorithm on an SA type:</p> <ul style="list-style-type: none"> - If you want to create a To Do entry whenever a new service agreement of a given type is added, specify such an algorithm.

		<p>- If you want to automatically activate SAs of a given type (instead of waiting for the background SA activation process to run), specify such an algorithm.</p> <p>- If you want to create a Workflow Process when a service agreement of a given type is added, specify such an algorithm.</p>
SA Information	Optional	<p>We use the term "SA information" to describe the basic information that appears throughout the system to describe a service agreement. The data that appears in "SA information" is constructed using this algorithm.</p> <p>Plug an algorithm into this spot to override the "SA information" algorithm on installation options or the system default "SA information" if no such algorithm is defined on installation options.</p>
SA Renewal	Optional	<p>These algorithms are executed by the Service Agreement Renewal background process whenever an SA is due for renewal or when the user clicks the Renew button (for Non-Billed Budgets). It performs any activities that are necessary to renew an SA and returns the new renewal and expiration dates for the SA.</p>
SA Stop	Optional	<p>These algorithms are executed whenever a service agreement's status changes from pending stop to stopped. The following situations necessitate the definition of a SA stop algorithm:</p> <ul style="list-style-type: none"> - For Non-Billed Budgets to distribute any remaining credit balance from the Non-Billed Budget SA to the covered SAs, you must specify such an algorithm. - For service credit memberships that have a refundable membership fee, an SA Stop algorithm attempts to refund the fee if this is the last SA linked to the membership that is being stopped.
SA Stop Initiation	Optional	<p>These algorithms are executed whenever a service agreement's status becomes pending stop. The following situations necessitate the definition of a stop initiation algorithm on an SA type:</p> <ul style="list-style-type: none"> - As explained under Finalizing Pending Stops, service agreements are normally transitioned from pending stop to stopped by a background process (or manually). For Non-Billed Budget SAs to transition to stopped automatically (without waiting for the

background process), you must specify such an algorithm.

When does a SA become pending stop?

Service agreements typically become pending stop when a user initiates a request to stop service on [Start Stop - Main](#). A [severance process](#) with an Expire SA [severance event](#) causes a service agreement to become pending stop (when the event is executed). Additionally, the [Stop Expired Service Agreements](#) background process starts the process to initiate the stop of an SA when the expiration date is on or before the process date.

Start Stop Field Work

Optional

These algorithms are executed to create the field activities necessary to start and stop service. Refer to [Starting Service and Field Activities](#) and to [Stopping Service and Field Activities](#) for a description of when algorithms of this type are called. The following situations necessitate the definition of a start stop fieldwork creation algorithm:

- If a service agreement has field activities created to start and stop service at its service points, its SA type must have an appropriate start stop field work creation algorithm.

SA Type - Billable Charge Overrides

The [BCU2 - Create Billable Charge](#) background process is responsible for creating billable charges for each billable charge upload staging record interfaced into the system. This process will override the values of the various switches referenced on a billable charge upload staging line if the respective service agreement's SA type has an override value for the billable charge upload staging line's billable charge line type.

NOTE:

This information is optional. If you don't need to override the values of a [Billable Charge Line Type](#) you don't need to set up this information.

Open **Admin > Customer > SA Type > Search** and navigate to the **BC Upload Override** page to define override values for a given SA Type / Billable Charge Upload Staging Line Type.

Description of Page

Use the **Billable Charge Overrides** collection to define values to be overridden on billable charge lines uploaded from an external system (refer to the description above for the details). The following switches may be overridden for a given **SA Type** and **Billable Charge Line Type**.

- Use the **Show on Bill** switch to define the value to be defaulted into the Show on Bill indicator on billable charge upload lines that reference this line type.
- Use the **Appear in Summary** switch to define the value to be defaulted into the App in Summary indicator on billable charge upload lines that reference this line type.

- Use **Memo Only, No GL** switch to define the value to be defaulted into the Memo Only, No GL indicator on billable charge upload lines that reference this line type.
- Use **Distribution Code** to define the value to be defaulted into the Distribution Code on billable charge upload lines that reference this line type.

SA Type - Contract Option Type

Open **Admin > Customer > SA Type > Search** and navigate to the **Contract Option Type** page to define the contract option types, which are valid for service agreements of a given type.

NOTE:

This tab may not appear. This tab is suppressed if the interval billing Contract Options module is [turned off](#).

Description of Page

If the SA Type's special role flag is set to Bill Determinants Required, you may define the **Contract Option Types** that are valid for contract options linked to a service agreement of this type.

Where Used

This information is used to validate the contract options linked to the service agreement. Refer to [Service Agreement - Contract Options](#) for more information.

SA Type - NBB Recommendation Rule

Open **Admin > Customer > SA Type > Search** and navigate to the **NBB Rec'n Rule** page to define the recommendation rules that are valid for Non-Billed Budget SAs of this type.

Description of Page

If the SA Type's special role is Non-Billed Budget, you may define the **Recommendation Rules** that are valid on non-billed budget SAs of this type. Check the **Use As Default** box to indicate the default recommendation rule for service agreements of this type.

FASTPATH:

For more information about Non-Billed Budgets, refer to [Defining Non-Billed Budget Options](#).

Where Used

The Non-Billed Budget recommendation rules are used to recommend the payment amount and payment schedule for Non-Billed Budget service agreements. Refer to [Maintaining Non-Billed Budgets](#) for more information.

Setting Up Start Options

Start options save users time and prevent data entry errors because they default many values on a service agreement (e.g., the rate schedule, recurring charge amount, contract riders, contract terms, characteristics, terms and conditions, etc. can all be defaulted onto a service agreement from a start option).

A SA type may have zero or more start options.

- A SA type without start options is usually one that has a very limited number of options. For example, if a SA type has a single valid rate and no customer-specific contract values, you don't need to setup a start option (the SA's default rate can default based on the information defined when you setup the SA type).
- A SA type with multiple start options is one where many different permutations are possible. For example, a SA type that can have multiple rates and each rate can have multiple riders is a good candidate for start options (where each start option will default, for example, a specific rate and set of contract riders).

When the [Start/Stop](#) transaction is used to start service AND the service being started uses a SA type with start options, the user is asked to select one of the start options. The service agreement that's created is populated with fields from the start option.

When the [Order](#) transaction is used to start service, the user selects start options, but only indirectly. It works like this:

- A user selects a "package" of services to start service for a customer.
- A "package" contains one or more start options.
- When a user selects a package, the system creates a service agreement for each start option on the package (and defaults the information on each service agreement from the respective start option).

A start option's default values may change over time (i.e., the information on a start option is effective-dated). The start service logic uses the version of the start option that is effective on the day service starts.

Start options can cause a great deal of information to be populated on a service agreement. There are several ways to change this default information:

- A user may override this information using the [Service Agreement](#) transaction.
- If the service agreement is in the pending start state, you can use the [Start/Stop - Pending SAs](#) page to change the service agreement's SA type and/or start option.
- If the service agreement is in active or pending stop states, a button appears on [Service Agreement - Main](#) called **Apply New Start Option**. When pressed, the user is allowed to define a start option and the date its terms become effective on the service agreement. Refer to [Changing A Start Option](#) for the details of this functionality.

The topics in this section describe how to setup start options.

NOTE:

The merge transaction can save setup time. The [Start Options Merge](#) transaction can be used to construct a start option by copying pieces from other start options.

Start Option Considerations - Rate-Oriented SA Types

To understand the following discussion, you should be familiar with the following concepts:

- SA types that use rates have one or more valid rate schedules. Only these rate schedules may be defined on service agreements of a given type.
- One of a SA type's rate schedules may be designated as the "default" rate. The system assigns the "default" rate to new service agreements when a CSR doesn't choose a start option.
- Start options may be used by customer service reps when a service is started for a customer. A start option causes the customer's new service agreement to be populated with a specific rate and contract terms (e.g., contract riders, contract values). The use of start options is not allowed if the service's SA type does not require a start option. The use of start options is required if the service's SA type requires a start option.

Whether or not a SA Type has start options is dependent on the following factors:

- If a SA Type has only one valid rate and the rate doesn't use customer-specific contract terms (e.g., contract riders, contract values), the SA Type does not need any start options. Why? Because the system default's the SA type's default rate on new service agreement when no start option is used at start time.

- If a SA Type has only one valid rate, but under unusual circumstances, it uses customer-specific contract terms, you'll want an option for every situation (both the standard one and the unusual ones).
- If a SA Type has a single rate with a variety of contract terms (which, by definition, are different for each customer), then you'd want a start option for each permissible combination of contract terms. You'd also want to turn on the SA type's Start Option Required switch to make your CSR's pick one of the start options when service is started (rather than let the system use the SA type's default rate).
- If a SA type has multiple valid rates and a variety of contract terms (a combination of the previous two points), you'd need a start option for each permissible combination. You'd also want to turn on the SA type's Start Option Required switch to make your CSR's pick one of the start options when service is started (rather than let the system use the SA type's default rate).

Start Option Considerations - SA Types That Use Recurring Charges

To understand the following discussion, you should be familiar with the following concepts:

- Many SA types use the recurring charge algorithms to generate the bill segments. For example, if you let a customer pay for a \$900 heat pump in 3 installments of \$300, you'd have an SA type called CA/MERCH-I and indicate it uses the recurring charge algorithm.
- When a CSR creates an SA type that uses recurring charge algorithms, they can enter the recurring charge amounts on [Start/Stop Service - Start Confirmation](#) window OR they can specify a start option on this window and let the system populate the recurring charge amount. For example, if you let a customer pay for a \$900 heat pump in 3 installments of \$300, you can set up a start option called HP 3PAY with an installment amount of \$300.
- Depending on the type of service being started, you might also need to generate an adjustment when service is started in order to initialize the total debt. For example, when a customer buys a heat pump we'll need an adjustment issued to realize the entire \$900 of revenue.

The following table provides examples of recurring charge SA types with several typical start options:

CIS Division/ SA Type	Start Option	Adjustment Type	Install Amount	Comments
CA/CHARITY	DONATE \$5		5	This causes a charitable contribution to be created with an installment amount of \$5.
CA/CHARITY	DONATE \$10		10	This causes a charitable contribution to be created with an installment amount of \$10.
CA/PA-REGU	PAY \$10 PM		10	This causes a payment arrangement to be created with an installment amount of \$10.
CA/PA-REGU	PAY \$20 PM		20	This causes a payment arrangement to be created with an installment amount of \$20.
CA/PA-UNRE	PAY \$10 PM		10	This causes a payment arrangement to be

				created with an installment amount of \$10.
CA/PA-UNRE	PAY \$20 PM		20	This causes a payment arrangement to be created with an installment amount of \$20.
CA/MERCH-I	HP 3PAY	HEATPUMP	300	This causes a merchandise service agreement to be created with an installment amount of \$300. It also causes an adjustment to be issued to realize the \$900 of revenue.
CA/MERCH-I	BBQ 3PAY	BBQ	250	This causes a merchandise service agreement to be created with an installment amount of \$250. It also causes an adjustment to be issued to realize the \$750 of revenue.
CA/DEP-I	PAY \$40 PM		40	This causes a deposit service agreement to be created with an installment amount of \$40. The CSR would be required to define the total deposit amount to be billed over the life of the service agreement on the secondary SA window on the Start Account window.

Start Option Considerations - Initial Adjustment SA Types

To understand the following discussion, you should be familiar with the following concepts:

- Some SA types depend on an adjustment to book their initial debt. For example, the CA/MERCH-I SA type requires an initial adjustment to book the payoff amount for the entire cost of the merchandise. Another example would be a loan service agreement (refer to [Booking The Principal Amount Using An Adjustment](#) for the details).
- When a CSR starts an SA type that requires an initial adjustment, they can create the adjustment immediately after starting service OR then can specify a start option when they start service and let the system generate the adjustment. You could let the system create the adjustment to book the \$900 associated with the heat pump as shown in the previous section.

The following table provides examples of SA types that use adjustments with several typical start options:

CIS Division/	Start Option	Adjustment Type	Install Amount	Comments

SA Type

CA/MERCH-I	HP 3PAY	HEATPUMP	300	This causes a merchandise service agreement to be created with an installment amount of \$300. It also causes an adjustment to be issued to realize the \$900 of revenue.
CA/MERCH-I	BBQ 3PAY	BBQ	250	This causes a merchandise service agreement to be created with an installment amount of \$250. It also causes an adjustment to be issued to realize the \$750 of revenue.
CA/CONNECT	CONNECT	CONNECT		This causes an adjustment to be issued to realize the connection charge.

Start Option - Main

Open **Admin** > **Customer** > **SA Type Start Option** > **Add** to define a SA type's start options.

Description of Page

Every start option is uniquely identified by the following fields:

CIS Division & SA Type Enter the Division and SA type to which the start option is linked.

Start Option Enter the unique identifier of the option. Pick something easy to recognize as this will be used by CSRs to pick an option when they start service.

Effective Date Enter the earliest effective date. It should be the same as the earliest effective date of the start option's rate (although it doesn't hurt for it to be earlier). The date defaults to the current date. (The status, below, should be Active.)

The remaining fields further describe a start option.

Enter a **Description** for the start option.

Indicate its **Status**. For new start options, the status should be Active. When it's no longer applicable, change it to Inactive.

Enter the primary **Rate Schedule** that should be defaulted onto service agreements created using this option. Refer to [Start Option Considerations For SA Types That Use Rates](#) for more information.

FASTPATH:

For more information about a service agreement's rates, refer to [Service Agreement - Rate Info](#).

Enter the **Adjustment Type** that should be generated, if any, when service is started using this option. Refer to [Start Option Considerations For SA Types That Use Initial Adjustments](#) for more information.

Enter the **Recurring Charge Amount** that should be defaulted onto service agreements created using this option. This field is only visible when the SA type allows recurring charges. In addition, the prompt for this field is defined on the SA type

table on the billing window (e.g., it could appear as Payment Amount, Budget Amount, or Installment Amount). Refer to [Start Option Considerations For SA Types That Use Recurring Charges](#) for more information.

Enter the **Currency Code** in which monetary amounts are denominated.

NOTE:

The currency code defaults from the [installation record](#).

Enter the **Total Amount to Bill** that should be defaulted onto service agreements created using this option. This is useful to initiate either a loan or a deposit. The prompt for this field is defined on the SA type table on the billing window (e.g., it could be Deposit Amount or Loan Amount).

Use **Number of Periods** to default the number of payment periods of service agreements created using this option. This field is only allowed for SA types with special role of Loan. Refer to [The Terms Of A Loan Are Stored On A Service Agreement](#) for more information.

If your SA Type has a special role of Billing Determinants Required, you may enter the **Cutoff Time** and **Start Day Option** that should be defaulted onto service agreements that are created using this option. For start day option, you may choose **Current Day** or **Previous Day**.

If your SA Type has a special role of Billable Charge, then you can setup the start option to automatically create a billable charge when a service agreement is created using this start option. For example, you might have a start option that automatically creates a "one-time invoice" service agreement along with a "tree trimming" billable charge. To use this feature you should turn on the **Create Billable Charge** switch and specify the **Billable Charge Template** that will be used to create the billable charge. These fields are only allowed for SA types with special role of Billable Charge.

FASTPATH:

Refer to [Setting Up Billable Charge Templates](#) for more information about templates. Refer to [An Easier Way To Create One Time Charges](#) for an example of how you can setup a campaign with packages that use this type of start option.

NOTE:

The duplicate action in the page actions toolbar enables you to copy another start option. Refer to [Duplicate Button](#) in the system wide standards document for more information.

Start Option - Rate Info

Open **Admin > Customer > SA Type Start Option > Search** and navigate to the **Rate Info** page to define the start option's default values for contract riders and contract values.

Description of Page

The information in the **Contract Riders** collection defines the contract riders to be defaulted onto service agreements created using this start option. The following fields are required for each instance:

Bill Factor The bill factor defines the type of rider. You may only reference bill factors designated as being applicable for contract riders.

Number of Days The number of days the rider should be in effect. This value is used by the system to set the stop date on the service agreement's contract rider. If the rider has no expiration, set this field to 0. Default note: this field will be set to 0 if left blank.

FASTPATH:

For more information about a service agreement's contract riders, refer to [Service Agreement - Contract Riders](#).

The information in the **Contract Values** collection defines the contract values to be defaulted onto service agreements created using this start option. The following fields are required for each event:

Bill Factor The bill factor defines the type of value. You may only reference bill factors designated as allowing values in contract terms.

Number of Days The number of days the value should be in effect. This value is used by the system to set the stop date on the service agreement's contract value. If the value has no expiration, set this field to 0.

Value The amount of the contract value.

FASTPATH:

For more information about a service agreement's contract values, refer to [Service Agreement - Contract Values](#).

Start Option - Characteristics & Qty

Open **Admin > Customer > SA Type Start Option > Search** and navigate to the **Characteristics & Qty** page to define the start option's default values for characteristics and contract quantities.

Description of Page

The information in the **Characteristics** collection defines the characteristics to be defaulted onto service agreements created using this start option. The following fields are required for each instance:

Characteristic Type This defines the type of characteristic. Note: you may only define characteristics valid on service agreements.

Characteristic Value This defines the characteristic value that will be defaulted.

FASTPATH:

For more information about a service agreement's characteristics, refer to [Service Agreement - Characteristics](#).

The information in the **Contract Quantity** collection defines the contract quantities to be defaulted onto service agreements created using this start option. The following fields are required for each instance:

Contract Quantity Type This defines the type of contract quantity.

Contract Quantity The amount of the contract quantity.

FASTPATH:

For more information about a service agreement's contract quantities, refer to [Service Agreement - Contract Quantity](#).

Start Option - Contract Option

NOTE:

This tab may not appear. This tab is suppressed if the interval billing Contract Options module is [turned off](#).

Open **Admin > Customer > SA Type Start Option > Search** and navigate to the **Contract Option** page to define the start option's contract option default values.

Description of Page

The collection of contract option types will be used to link contract options to a service agreement that will be created with this start option. If the contract option to create for the service agreement will be SA Specific, simply indicate the **Contract**

Option Type. This will cause a new contract option to be created with this contract option type and the new contract option will be linked to the new SA at start time. If the contract option to create for the service agreement will be Shared, indicate the contract option type and the **Contract Option ID**. This will cause the specified contract option to be linked to the new SA at start time.

Start Option Merge

Use this page to modify an existing start option by copying information from other start options. This page may be used to copy records from the contract rider, contract value, contract quantity, characteristic, contract option and TOU contract value collections from one or more existing start options to another.

NOTE:

The target start option must exist prior to using this page. If you are creating a new start option, you must first go to the [Start Option](#) page to add the new start option and then navigate to the merge page to copy collection information.

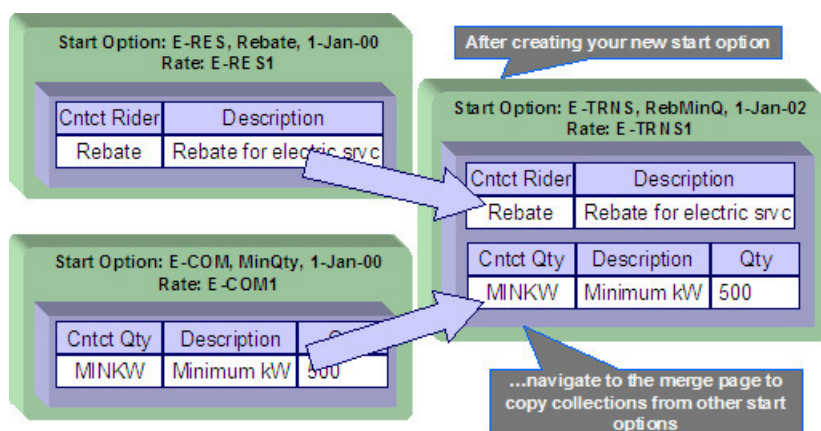

NOTE:

Duplicate versus Merge. The [Start Option](#) page has [Duplication](#) capability. You would duplicate a start option if you want to a) create a new start option AND b) populate it with all the information from an existing start option. You would use the start option merge page if you want to build a start option using pieces of one or more start options.

Start Option Merge - Main

Open **Admin > Customer > SA Type Start Option Merge**.

Description of Page

Select the **Original Start Option**, which is the target for merging the start option collection information.

Select the **Merge From Start Option**, which is your template start option to copy the collections from.

NOTE:

You may only copy information from one Merge From start option at a time. If you wish to copy information from more than one start option, select the first Merge From start option, copy the desired records, Save, then select the next Merge From start option.

The left portion of the page will display any existing records in the collections for the original start option. The right portion of the page will display the existing records in the collections for the Merge From start option.

You may use the **Copy All** button to copy all the records in all the collections from the Merge From start option to the Original start option. If you do not choose to copy all, you may copy records individually as described below.

The left portion of the **Contract Riders** collection initially displays existing contract riders linked to the original start option. In the **Merge Type**, you will see the word Original, for any of these records. The **Bill Factor** and **Number of Days** for each contract rider is displayed. In the right portion of the collection, the existing records in the merge from start option are displayed initially.

The left portion of the **Contract Values** collection initially displays existing contract values linked to the original start option. In the **Merge Type**, you will see the word Original, for any of these records. The **Bill Factor**, **Number of Days** and **Value** for each contract value is displayed. In the right portion of the collection, the existing records in the merge from start option are displayed initially.

The topics, which follow, describe how to perform common maintenance tasks:

Removing A Row From A Grid

If you wish to remove a record linked to the Original start option, click the "-" button to the left of the record.

Adding A New Row To A Start Option

You may move any of the records from the Merge From start option to the original start option by selecting the left arrow adjacent to the desired row. Once a record is moved it will disappear from the Merge From information and appear in the Original information with the word Merge in the Merge Type column.

Removing An Uncommitted Row From A Start Option

If you have copied a row across by mistake, you may remove it by clicking on the right arrow adjacent to the appropriate record.

Start Option Merge - Characteristics and Quantities

Open **Admin > Customer > SA Type Start Option Merge** and navigate to the **Characteristics and Quantities** page to copy rows in the characteristic and contract quantity collections.

Description of Page

The left portion of the **Characteristics** collection initially displays existing characteristics linked to the original start option. In the **Merge Type**, you will see the word Original, for any of these records. The **Characteristic Type** and **Characteristic Value** for each characteristic are displayed. In the right portion of the collection, the existing records in the merge from start option are displayed initially.

The left portion of the **Contract Quantity** collection initially displays existing contract quantities linked to the original start option. In the **Merge Type**, you will see the word Original, for any of these records. The **Contract Quantity Type** and **Contract Quantity** for each contract quantity are displayed. In the right portion of the collection, the existing records in the merge from start option are displayed initially.

FASTPATH:

Refer to [Start Option Merge - Main](#) for more information about how to perform common maintenance tasks for the grids displayed on this page.

Start Option Merge - Contract Option

Open **Admin > Customer > SA Type Start Option Merge** and navigate to the **Contract Option** page to copy rows in the contract options collection.

NOTE:

This tab may not appear. This tab is suppressed if the interval billing Contract Options module is [turned off](#).

Description of Page

The left portion of the **Contract Option** collection initially displays existing contract option information linked to the original start option. In the **Merge Type**, you will see the word Original, for any of these records. The **Contract Option Type**, **Contract Option ID** and **Description** of the contract option for each contract option row are displayed. In the right portion of the collection, the existing records in the merge from start option are displayed initially.

FASTPATH:

Refer to [Start Option Merge - Main](#) for more information about how to perform common maintenance tasks for the grids displayed on this page.

Start Option Merge - Terms and Conditions

Open **Admin > Customer > SA Type Start Option Merge** and navigate to the **Terms and Conditions** page to copy terms and conditions (T&Cs).

Description of Page

The left side of the **Terms and Conditions** grid initially displays the T&Cs linked to the original start option. On the right side, the T&Cs linked to the merge from start option are displayed initially.

FASTPATH:

Refer to [Start Option Merge - Main](#) for a description of how to perform common maintenance tasks for the grids displayed on this page.

Defining SA Relationship Options

We use the term "SA Relationship" to describe functionality that supports the following situations:

- When companies other than your own provide a service to your customers AND you have some type of interaction with these companies. For example, in a deregulated market, customers deal with both distribution and energy supply companies. These companies typically exchange a great deal of information about their joint customers.
- When multiple rates are associated with a service (where each rate corresponds with a sub-category of service). For example, most water companies charge for both water and wastewater service using separate rates for each. While it is possible to set up water and wastewater as separate service agreements, the SA relationship functionality allows you to set up a single "master" service agreement (for the water service) and associate with it a "sub" service agreement (for the wastewater service).

- When a party representing a group of customers negotiates a contract that is applied over and above those of the individual service agreements. For example, the head office of a national chain may negotiate for additional discounts that should be calculated together or individually. The SA relationship functionality may be used to track the covered service agreements and to calculate and transfer discounts to the head office's service agreement. Refer to the special discounts section.

WARNING:

Setting up the SA relationship control tables is as challenging as your organization's business rules. If you don't have requirements similar to those described above, you don't have to set up anything. If you have these types of requirements, your setup process will be taxing as you must design and set up control tables that manage the financial and consumption interactions that take place between you, your customers, and the various service providers.

The topics in this section describe tables that control your SA relationship functionality.

The Big Picture of SA Relationships and Service Providers

You must set up service providers if companies other than your own provide a service to your customers AND you have some type of interaction with these companies. You will have one service provider for each such company. For example, if you are a distribution company in a deregulated market, you will have a service provider for each company that provides any of the following services:

- Energy (commonly referred to as Energy Supply Companies, Energy Service Providers, Retailers, and Suppliers)
- Meter service (commonly referred to as Meter Service Providers and Meter Agents)
- Meter reading (commonly referred to as Meter Data Management Agencies and Meter Reading Service Providers)
- Billing (commonly referred to as Billing Agents)

The topics in this section provide background information about service providers.

Persons and Service Providers

A great deal of information about your service providers is defined using a person. For example, a service provider's name, address, phone numbers, electronic ID's, etc. are all defined on the person object.

In addition, every service provider must have a service provider object created for it. The service provider object contains information about a provider's relationships with the customer and your organization, for example:

- Do you calculate bills for the service provider? If so, do you have their rates or do they interface their charges to you? Refer to [Billing Relationships](#) for more information.
- Do you send the customers' consumption to the service provider? Do they send it to you? Refer to [Consumption Relationships](#) for more information.
- How are financial settlements between your organization and the service provider implemented (do you pay them when you get paid?, do you purchase the receivable for them?, etc.). Refer to [Service Providers Have Service Agreements Too](#) for more information.
- Etc.

FASTPATH:

Refer to [Designing Your SA Relationship Types and Service Providers](#) for more information.

NOTE:

In some situations, you will need to set up a service provider for your own company. Refer to [When Your Company Is A Service Provider](#) for the details.

Service Providers Are Linked To Service Agreements

The following diagram illustrates a customer's bill for electric service in a deregulated market. Notice that there are separate sections for energy, distribution and meter service.

NOTE:

Consolidated billing. The following is an example of a bill that consolidates charges from many service providers. Rather than receive a consolidated bill, it is possible for the customer to receive 3 separate bills, one from each service provider (we refer to this as Dual billing).

Customer's Electric Bill	
Energy Supply - Cheap Power	\$12
Distribution - LG&E	\$9
Meter Service - MeterCo	\$2

If we were to look at this customer's service agreement in the distribution company's CIS system, we'd find a service agreement for distribution charges, and linked to it would be information about the meter service and energy service providers:

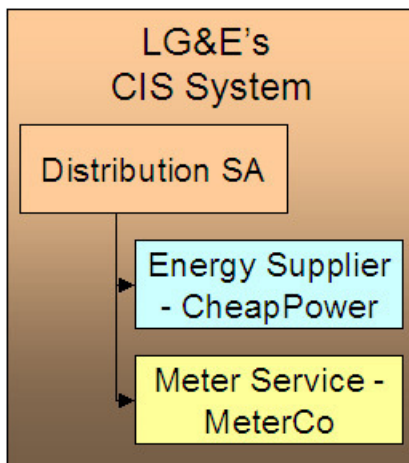

If we look at this customer's service agreement in the energy supply company's CIS system, we'd find a service agreement for energy charges, and linked to it would be information about the distribution and meter service providers:

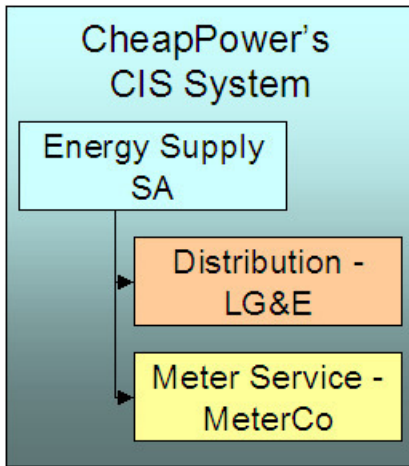

And finally, if we look at this customer's service agreement in the meter service company's CIS system, we'd find a service agreement for meter service charges, and linked to it would be information about the distribution and energy providers:

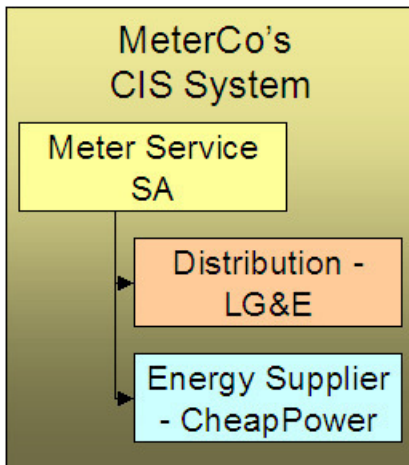

NOTE:

Bottom line. A customer's service providers keep track of the customer and each other in their respective CIS systems. A customer will have a service agreement (or the equivalent) in each service provider's CIS system. A customer's service agreement defines the service providers who supply each type of service.

FASTPATH:

Because information about customers and their services needs to be kept up-to-date in many different CIS systems, there is a need for automated communications between service providers. Refer to [Service Providers Have To Communicate About Customers](#) for more information.

Service Providers May Change Over Time

A customer typically has a choice of service providers. Over time, their choice may change. The system keeps track of a customer's service providers throughout time so that it can accurately cancel / rebill historical bills. This means that the service provider relationship is *effective-dated*.

The following diagram illustrates how a distribution company's system keeps track of a customer's service providers (notice the customer changed energy suppliers):

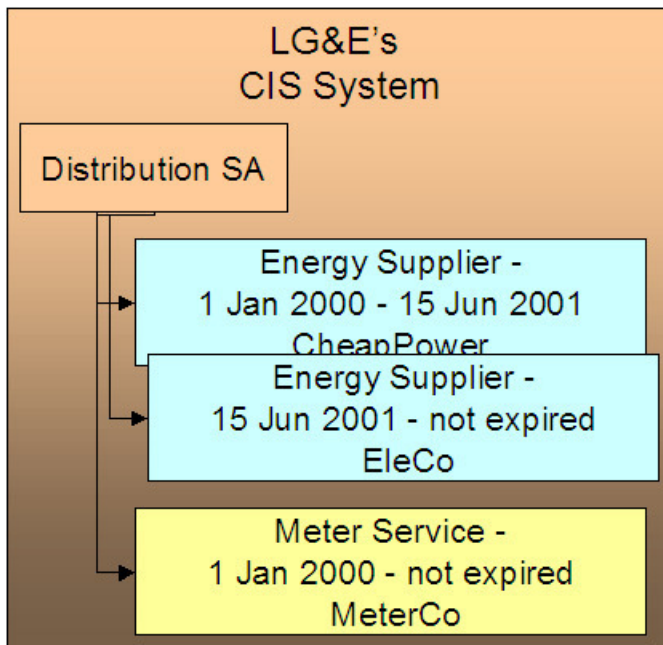

How To Set Up SA Relationships On A Customer's Service Agreement

There are three ways to set up a customer's service providers:

- **Manually.** An operator can manually change a service agreement's SA relationships. The manual method is NOT recommended as changing service providers typically involves many events (e.g., you have to notify the current service provider that they will be dropped).
- **Use Default Service Providers.** The system will default a service provider on a required SA relationship when a service agreement is activated. Refer to [Defaulting Relationship Types And Defaulting Service Providers](#) for more information.

When Your Company Is A Service Provider

Besides setting up service providers for other companies that provide services to your customer, you may have to set up a service provider for your own company. You have to do this when:

- **Your organization can supply one of the services.** Refer to the illustration in [Service Providers Are Linked To Service Agreements](#). If you are LG&E and you supply energy in addition to distribution, you would need to set up a service provider for your own organization. Why? Because whenever you have a subcategory of service (e.g., energy supply), you must indicate the service provider who provides this service; even when it's you.
- **You decide to break up a service into subcategories** (and have a separate service agreement for each category). For example, a water company may choose to break up service charges into water, wastewater and storm water (they may do this because there are different rates for each category of service). The following is an example of the segregated charges associated with this water company's service charges.

Customer's Water Bill	
Water Service - WaterCo	\$15
Wastewater - WaterCo	\$6
Storm Water - WaterCo	\$5

This water company system may benefit by creating a single service (for water) and indicating there are subcategories of service (for wastewater and storm water). Whenever you have a subcategory of service, you must indicate the service provider who provides this service. And, in this example, the water company would be the sole service provider for each subcategory of service.

Customer's Water Bill	
Water Service - WaterCo	\$15
Wastewater - WaterCo	\$6
Storm Water - WaterCo	\$5

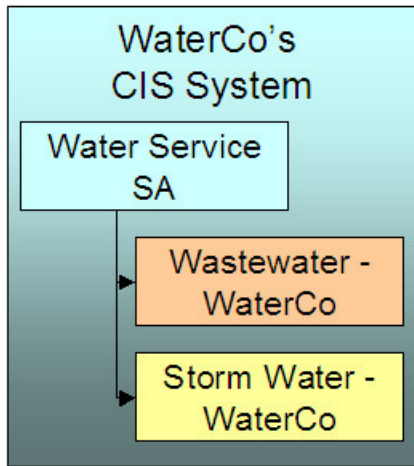

NOTE:

Refer to [We Bill For Them - Rate Ready Bill Segments Are Special](#) for restrictions in respect of using subcategories of service.

Service Providers Have To Communicate About Customers

The providers of service typically have to communicate with each other in respect of the customer's service. The following diagram illustrates the major interfaces of information between your system and your service providers.

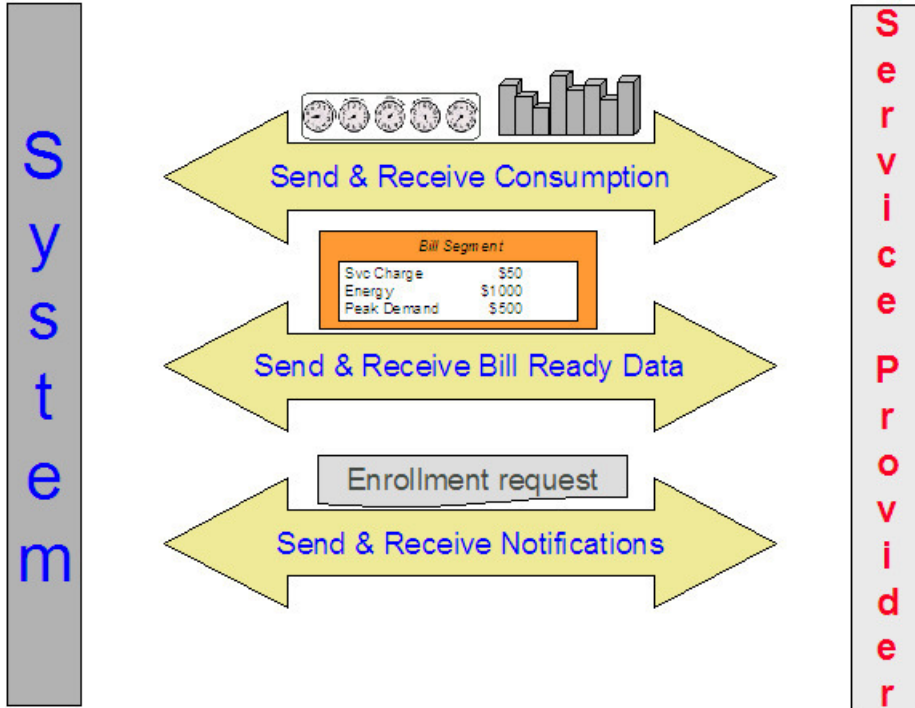

Depending on where your organization fits in the service provider hierarchy, you may:

- Bill for other service providers (or they may bill for you). Refer to [Billing Relationships](#) for more information about billing communications.
- Send the customer's consumption to service providers (or they may send it to you). Refer to [Consumption Relationships](#) for more information about consumption communications.
- Apprise service providers of the changes to the customers' service (or they may apprise you). Refer to [How Do You Communicate With Service Providers?](#) for more information about communications between service providers.

Relationships Between Service Providers

Service providers may arrange contractual relationships with other service providers to provide additional services, e.g., an energy service provider may work with a specific meter data management agency to gather and report interval meter read data.

The system does nothing special to enforce or record these inter-relationships. Why? Because most service provider switches are received by notification records. Notification records indicate all the associated service providers. There is no need for the system to maintain the inter-service provider associations.

A Service Agreement Can Have Many Types Of Relationships

As described in the previous sections, a given service can be subdivided into subcategories. Each type of service can have zero, one or more subcategories. We call each subcategory a **SA Relationship Type**. The topics in this section provide information about SA relationship types.

An Example

We'll use the following example of a customer in a municipal utility's CIS system to explain SA Relationship types:

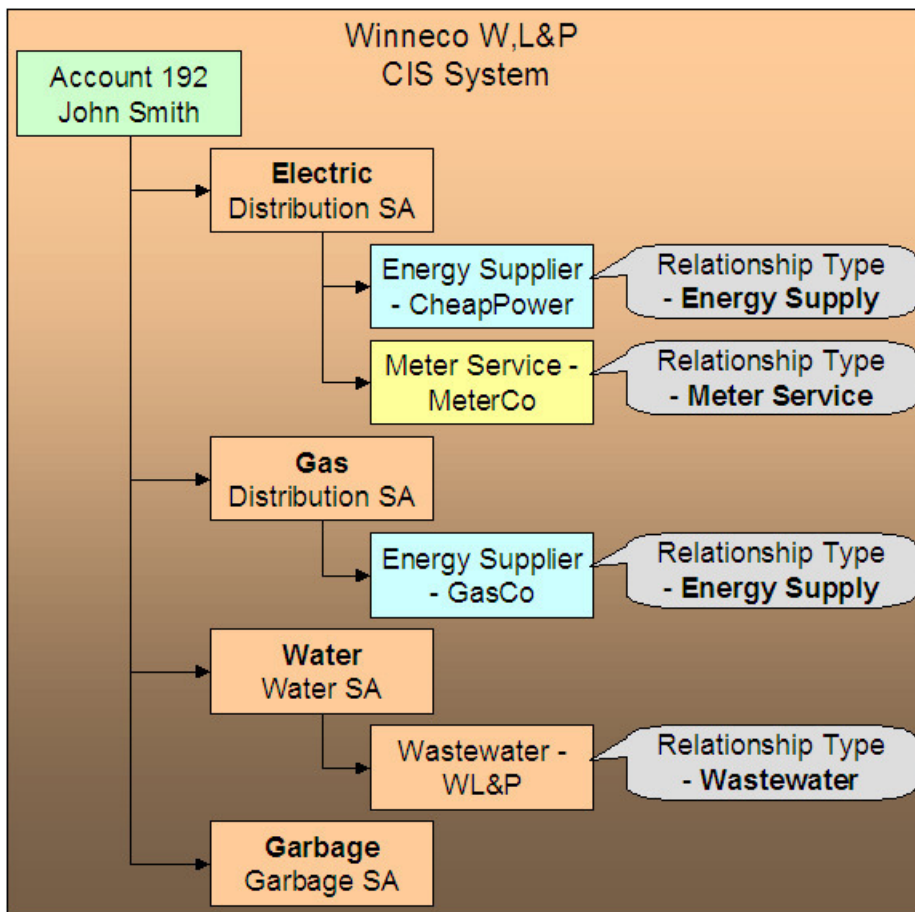

Note the following:

- Electric service has 2 SA relationship types: energy supply and meter service.
- Gas service has 1 SA relationship type: energy supply.
- Water service has 1 SA relationship type: waste water.
- Garbage service has no SA relationship types.

NOTE:

Bottom line. Service providers are related to the customer via "your" service agreement. Each service provider linked to a service agreement is defined in respect of a SA Relationship Type. This relationship is effective-dated because we care about how it changes over time.

Your relationship type is implied. The SA relationship type of "your" service agreement is implied, e.g., if you are a distribution company, "your" service agreement's implied SA relationship type is "distribution".

Valid Relationship Types and Service Providers Are Defined On SA Types

You control which services have SA relationships (and which don't) when you set up your SA types. Each SA type can have zero, one or more SA relationship types. Each relationship type, in turn, can have one or more valid service providers.

FASTPATH:

Refer to [Setting Up SA Relationships For SA Types](#) for the page used to define the service providers and SA relationship types for each SA type.

Defaulting Relationship Types And Defaulting Service Providers

Please be aware of the following:

- A SA relationship type for a given SA type can be marked as being **Required**.
- A service provider for a given SA relationship type / SA type can be marked as being the **Default**.

If, at activation time, the customer's master SA is missing a **Required** SA relationship that has a **Default** service provider, the activation process automatically creates the SA relationship type and links to it the **Default** service provider. If a master service agreement doesn't have all **Required** SA relationships, the service agreement cannot be activated. This is handy when your organization is the default service provider for a relationship type.

FASTPATH:

Refer to [Automatic Creation of Sub SAs](#) for information about how the system will automatically create sub service agreements for the defaulted SA relationship / service provider if your organization provides billing services for the service provider. Refer to [Setting Up SA Relationships For SA Types](#) for the page used to define the service providers and SA relationship types for each SA type.

Required Relationship Types and Billing

When the system attempts to create a bill segment for a service agreement whose SA type has **Required** relationship types, it checks if all such relationships are defined for the service agreement. If not, a bill segment error will be generated.

The reason this restriction exists is to handle the situation when your required relationship types change over time. For example, assume on your first day of production you only need energy suppliers defined on electric service agreements. After several months, gas deregulates. When this happens, you will need to change your control tables to indicate that your gas SA types require an energy supplier. If you don't write a default program to update your existing gas service agreements, billing will complain.

Relationship Types Do Not Impact Start/Stop

Customer service representatives (CSR's) are typically not involved with the customer's choice of service providers. Most organizations hear about a customer's service providers from the service providers or from a central body. This means that the start/stop dialog is not impacted by SA relationships. This also means that CSR's are not impacted by SA relationships

(unless something goes wrong). If something goes wrong, the CSR's may need to manually correct SA relationships. Refer to [How To Set Up Service Providers On A Customer's Service Agreement](#) for more information.

Billing Relationships

When you set up a service provider, you must define your organization's billing relationship with the service provider. The following points provide examples of the billing relationships supported in the system,

- If you are an energy supply company, you may provide billing services for the distribution company. This means that your bill contains both your charges and the distribution company's charges. We refer to this as the **We Bill For Them** billing relationship.
- Alternatively, the distribution company may provide billing services for you. This means that the distribution company's bill contains your charges and their charges. We refer to this as the **They Bill For Us** billing relationship.
- Alternatively, you may both send bills to the customer. We refer to this as the **Dual Billing** relationship.
- Alternatively, if you subcategorize your services OR if your company provides one of the services that is provided by your service providers, then the system will create a separate bill segment for the subcategory of service. We refer to this as the **It's Us** billing relationship.

If you provide billing services for another service provider (i.e., you bill for them), there are two ways to determine the service provider's charges:

- You can load the service provider's rates in your system and calculate the charges for the service provider. We call this the **Rate Ready** calculation method.
- You can let the service provider calculate their own charges and interface them to you. We call this the **Bill Ready** calculation method.

If a service provider provides billing services for you (i.e., they bill for you):

- If the service provider has a suitable CIS system, they can load your rates in their system and calculate your charges for you. We call this the **Rate Ready** calculation method.
- You can calculate your charges and interface them to them. We call this the **Bill Ready** calculation method.

If you don't have a billing relationship with a service provider, you still need a service provider record to define such. Why? Because the system needs to know that it doesn't have to worry about a particular service provider in respect of billing. In addition, you may have other interactions with a service provider that have nothing to do with billing, e.g., you may send or receive consumption.

The topics in this section provide a wealth of information about the various billing relationships and the ramifications of each.

Sub Service Agreements

If you provide billing services for another service provider OR if you subcategorize your own charges, there will be a separate service agreement (SA) linked to the customer's account that holds these unique charges. We refer to this new service agreement as a **Sub SA**. We use the term "sub" because this service agreement is subservient to the "master" service agreement. By subservient we mean:

- A sub SA's start and stop dates are the same as the master SA. This statement may seem odd, but it's true – all sub SAs linked to a master service agreement have the same start and stop dates as the master.
- A sub SA's status (i.e., *pending start*, *active*, *pending stop*, *stopped*, etc.) is controlled by its master service agreement. As a rule, the master SA transitions its status first and the sub SA(s) follow.

NOTE: There are situations where the master service agreement transitions its status and the sub service agreement(s) does not. One example of this is when both the master and sub SAs are closed and a payment cancellation occurs that only affects the master SA. In this scenario, the master SA becomes reactivated and the sub SA remains closed. Another example is when a straggling billable charge posts to a sub SA; the master SA is not affected.

- Refer to [The Rate Ready Calculation Method](#) for additional examples of subservience.
-

NOTE:

You may find it helpful to keep in mind that sub SAs are only used for service providers with a billing relationship of It's Us and We Bill For Them. This is because these are the only relationships that have implicit billing responsibilities.

The topics in this section provide additional information about sub SAs.

Only Some Service Providers Have Sub SAs

If you do not provide billing services for a service provider, there will be no sub SAs associated with the service provider's SA relationships. Let's use an example to make the point; assume:

- Service is divided into distribution, energy and meter service charges.
- You are the distribution company and you provide billing services for the energy supply company.
- The meter service company bills the customer independently.

In this situation, the customer will receive two bills: one from you (LG&E), the other from MeterCo. Notice that your bill (LG&E) contains your distribution charges AND CheapPower's energy charges:

Customer's Electric Bill from LG&E	
Energy Supply - Cheap Power	\$12
Distribution - LG&E	\$9

Customer's Electric Bill from Meter Co	
Meter Service - MeterCo	\$2

If we were to look at the customer information in the three service providers' respective CIS systems, we'd find the following service agreements and SA relationships for the customer:

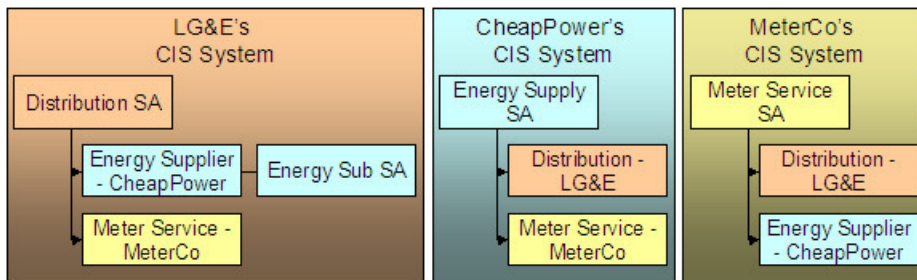

Notice the following:

- The customer has a service agreement in each supplier's CIS system.
- Because LG&E (the distribution company) bills for CheapPower, all customers who have their energy supplied by CheapPower will have a sub SA in LG&E's system. This sub SA maintains the charges (and receivable balance) associated with CheapPower's energy charges.
- Notice that neither CheapPower's nor MeterCo's CIS systems use sub SAs. This is because neither company bills for other service providers.

NOTE:

Sub SAs are needed if you subcategorize your charges. The above example shows sub SAs being used when a company provides billing service for another company. Sub SAs are also used when you subcategorize your charges - each sub SA contains the rate associated with each subcategory.

Automatic Creation of Sub SAs

The system creates sub SAs for customers choosing service providers where the billing option is It's Us or We Bill For Them. The system creates sub SAs via the following mechanisms:

- The [analyze SA relationships](#) background process (ANLYZSAR) monitors newly activated SA relationships. If the respective service provider is It's Us or We Bill For Them, this process creates the sub SA(s) using the information defined on SA Type SA Relationship Type. Refer to [Setting Up SA Relationships For SA Types](#) for more details.

NOTE:

The [analyze SA relationships](#) background process also activates and stops sub SAs. Refer to [Sub SA State Transition](#) for the details.

- A button exists on the [SA Relationships](#) page. This button, when pressed, creates sub SAs real-time. This button would only be used if the operator couldn't wait for the background process to run.

The SA type associated with the new sub SAs is defined when you set up each SA Type / SA Relationship Type. Refer to [Setting Up SA Relationships For SA Types](#) for more information.

If the SA type uses start options, the start option contains additional values (e.g., rates, contract riders) that are used to populate the newly created sub SAs. Note: start options are typically not used for We Bill For Them - Bill Ready service provider because we don't need to default rates, contract riders and/or contract values on billable charge sub SAs. Refer to [Setting Up SA Relationships For SA Types](#) for more information.

NOTE:

Manually created sub SAs. In very unusual situations, an operator may create a sub SA manually. An operator would do this using the [SA Relationship](#) transaction.

Sub SA State Transition

Sub SAs follow normal SA state transition rules, but have a few additional rules about when the transitions can take place.

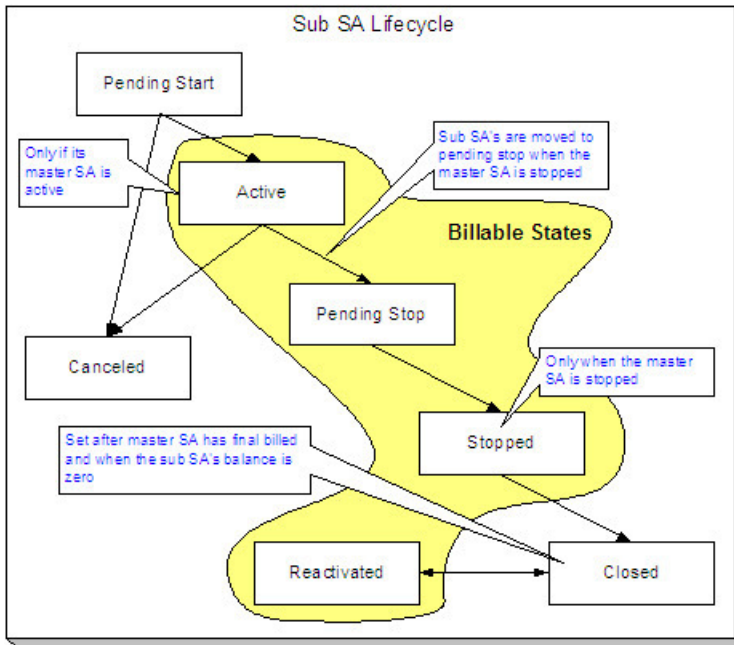

The following points highlight the additional state transition rules:

- A sub SA can only become Active if its master SA is Active. Most sub SAs are activated by the [analyze SA relationships](#) background process. However, a user can manually activate a sub SA using the activate button on the [SA maintenance](#) page.
- Sub SAs become Pending Stop when their master becomes Stopped. This typically occurs when the [SA activation background process](#) stops the master SA. However, this can happen real time if a user manually stops a master SA using the stop button on the [SA maintenance](#) page.
- A sub SA can only become Stopped if its master SA is Stopped. Most sub SAs are stopped by the [analyze SA relationships](#) background process. However, a user can manually activate a sub SA using the stop button on the [SA maintenance](#) page.
- A sub SA becomes Closed if its master has been final billed and it has a balance of zero. Most sub SAs are closed when their balance becomes zero after the master SA is final billed. However, a user can manually close a sub SA using the close button on the [SA maintenance](#) page. Note, if additional billable charges are interfaced after the master has been closed, the sub SA will be Reactivated.

We Bill For Them

If you provide billing services for another service provider, then you have a We Bill For Them billing relationship with the service provider. The topics in this section provide information about this type of billing relationship.

Sub SAs Are Used When We Bill For Them

As described under [Sub Service Agreements](#), sub SAs are used for We Bill For Them service providers. The sub SAs hold the service providers charges. It's important to note that the system allows more than one sub SA to be created for a given service provider.

The Rate Ready Calculation Method

If you provide billing services for a service provider (i.e., the service provider has a billing relationship of We Bill For Them), you can load the service provider's rates in your system and calculate the charges for the service provider. We call this the **Rate Ready** calculation method.

NOTE:

It's Us **can be Rate Ready**. The prior paragraph indicated that the Rate Ready billing option was used for We Bill For Them service providers. If you subcategorize your services and use rates to calculate each subcategory's charges, the service provider(s) set up for your own organization will also be subject to the Rate Ready rules described below.

If a customer uses a We Bill For Them - Rate Ready service provider, the system will create a separate bill segment for the service provider's charges. Keep in mind the following in respect of these types of bill segments:

- The consumption is copied from the "master" service agreement (note: we copy item details and read details after pre-processing calculation groups, if any exist, have been applied). This means that the bill period on the sub SA's bill segment is identical to that on the normal SA. This also means that if the "master" SA is in error, bill segments for the sub SA will not be created.
- The rate defined on the sub SA is applied against this consumption. All pre-processing calculation groups defined on the service provider's rate will be used to manipulate this consumption. If you have pre-processing calculation group on your master SA's rate to apply a line loss or convert a cubic foot to a therm, you don't have to have these pre-processing calculation group on the sub SA's rate (because we copy the consumption from the master to the sub after pre-processing calculation group, if any exist, have been applied).

The following illustration should help:

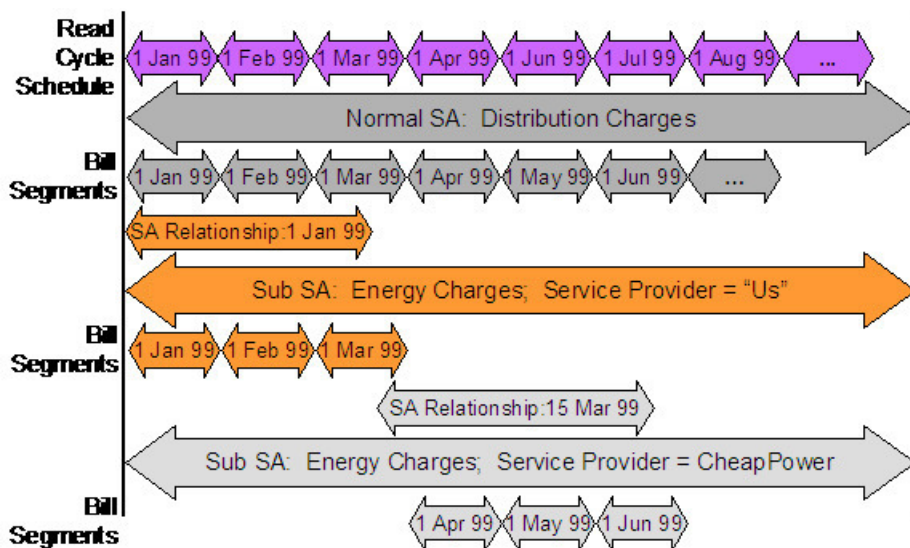

Be aware of the following:

- This example is from a distribution company's perspective.
- From 1 Jan 99 through 15 Mar 99, the distribution company distributes power AND supplies energy (i.e., the distribution company is the service provider of energy).

- On 15 Mar 99, CheapPower becomes the energy supplier. However, the next bill period ends on 30 Mar 99. This means that CheapPower will only start supplying energy on 1 Apr 99. See the following note for why the effective date of the supplier switch is not the true effective date from billing's perspective.

NOTE:

Service Provider Changes Take Effect On The Next Bill. If the service provider is changed within a customer's billing period, the system assumes that the service provider in effect at the START of the period is effective the entire billing period. This means that a change of service providers will only take effect on the bill whose start date follows the change date.

Please be aware of the following characteristics of Rate Ready bill segments:

- You cannot cancel a Rate Ready bill segment independently from the master bill segment. If you need to cancel / rebill the sub SA's bill segment, you must cancel / rebill the master SA's bill segment.
- You cannot delete a Rate Ready bill segment independently from the master bill segment. If you need to delete the sub SA's bill segment, you must delete the master SA's bill segment.
- Similarly, if you cancel / rebill the normal SA's bill segment, all Rate Ready bill segments will be cancelled / rebilled.

NOTE:

Bottom line. Creating, freezing, deleting, and canceling a "master" bill segment does the same with all Rate Ready bill segments. You cannot create, freeze, delete or cancel a Rate Ready bill segment independent of its master bill segment.

The Bill Ready Calculation Method

If a customer uses a We Bill For Them - Bill Ready service provider, the service provider calculates their own charges and interfaces them to the system. We then present their charges on our bill; we don't actually calculate anything (sometimes this is referred to as "pass through" billing).

The sub SA linked to a We Bill For Them - Bill Ready must be a billable charge SA. Why? Because billable charge SAs exist to hold bill lines until such time as a bill is created for the customer's account. Refer to [Setting Up Billable Charge Templates](#) for more information.

Please be aware of the following characteristics of Bill Ready bill segments:

- Unlike Rate Ready bill segments, Bill Ready bill segments can span different time periods than the master SA. This is because you cannot predict when a service provider will interface their billable charges to you. In fact, a given bill could contain billable charges that span different periods and these charges could have been interfaced from historic and existing service providers.
- Unlike Rate Ready bill segments, Bill Ready bill segments can be created and deleted independently from the master bill segment.
- Unlike Rate Ready bill segments, Bill Ready bill segments can be cancelled independently from the master bill segment.

[Sending Consumption And Waiting For The Charges](#)

[Uploading Consumption \(Rather Than Uploading Calculated Charges\)](#)

[Calculating Taxes On Uploaded Charges](#)

Sending Consumption And Waiting For The Charges

If your organization supports We Bill For Them - Bill Ready service providers AND you are the source of consumption used by these service provider to calculate their charges, you need to be aware of the following:

- We do NOT recommend sending raw meter reads to service providers. Rather, we recommend sending these service providers the same consumption that you use on your bill segments. Remember, the system maintains a snapshot of billed consumption on bill segments associated with service agreements that are linked to service points.
- But to implement our recommendation (of only interfacing billed consumption to service providers), we need to create a bill segment for the master SA and then wait until the service provider returns the billable charge before sending out the bill. The following points describe how this works:
 - Early in the bill cycle, the system creates a bill segment for the master SA (remember, the system maintains a snapshot of billed consumption on bill segments linked to service points). When the master bill segment is frozen, the system interfaces the snapshot consumption to all service providers associated with the master service agreement who need consumption (this is defined on the service provider). Refer to [We Can Send Billed Consumption To Any Service Provider](#) for more information about interfacing consumption to service providers.
 - The bill associated with the bill segment will not be completed. Why? Because the bill segments associated with the We Bill For Them - Bill Ready service providers will be in Error. This only happens if you use the Billable Charge bill segment creation algorithm (this algorithm is plugged in on the sub SA's SA type). On the algorithm, make sure to specify a value of Y for the parameter **Wait For The Last Day Of The Bill Cycle**. By doing this, a bill segment in the Error state will exist for the sub SA until the last night of the bill cycle's window.
 - On the last night of the bill cycle window, when the system attempts to create a bill segment for the billable charge SA associated with the We Bill For Them - Bill Ready, it will either find recently interfaced billable charges or it won't. If it finds unbilled, billable charges, a bill segment will be created for the sub SA and the billable charges will be swept onto it. If it doesn't find unbilled billable charges, the bill will be completed (i.e., sent out) without the service provider's charges.

NOTE:

Bottom line. If a customer's account uses We Bill For Them - Bill Ready service providers, the bill will not be completed (i.e., sent out) until the last night of the bill cycle (if you use the appropriate algorithm). Why? Because we wait until the last night of the bill cycle before trying to sweep on recently interfaced billable charges. If no billable charges have been interfaced from the service provider by the last night of the bill cycle, the bill will be sent out without the service provider's charges.

Batch versus Online Bill Creation. If you create a bill online, the system will NOT create an Error bill segment for the We Bill For Them - Bill Ready service provider. Why? Because if you want to create an online bill, either the service provider has interfaced their charges or they haven't. If they have, they should be swept on the bill (via the creation of a bill segment). If they haven't, it shouldn't prevent you from completing the bill.

[Top of the Page](#)

Uploading Consumption (Rather Than Uploading Calculated Charges)

We understand this is confusing, but it is quite possible to set up the system so that the We Bill For Them - Bill Ready service provider passes in CONSUMPTION rather than the calculated bill lines. They would only do this if they are not able to calculate the charges in their system and have therefore provided you with their rates. To do this, you would set up everything as described above. In addition, when you upload the billable charges, you must specify the consumption to be rated in the billable charge's service quantity (SQ) collection.

[Top of the Page](#)

Calculating Taxes On Uploaded Charges

It is possible to set up the system to calculate taxes for billable charges. You would do this if the service providers are passing through the charges and want you to calculate the taxes.

If you want taxes calculated on top of billable charges:

- Create a service quantity (SQ) on the billable charge that contains the total monetary amount that taxes will be calculated on. Note, you would not have to do this if you have a pre-processing calculation group in your rate that calculates the total monetary amount to which taxes should be applied.

- Specify a rate on the billable charge service agreement. This rate will contain calculation rules that calculate taxes. Note, the calculation rules will be simple SQ calculation rules that apply a percentage to the value of the SQ that represents the monetary amount on which taxes should be calculated.

When the system creates the bill segment for the billable charge, it will call the rate and the rate will calculate the taxes and add additional lines (actually, bill calculation headers) to the bill segment.

Pay At Bill Time vs. Pay At Pay Time

If you provide billing services for another service provider (i.e., the service provider has a billing relationship of We Bill For Them), you will owe them money because you will be receiving money from their customers for their service. You have two options in respect of when the system increases the amount you owe the service provider:

- You can tell the system to increase how much you owe the service provider when you freeze the customer's bill segment. Some people refer to this method as "purchasing the receivable from the service provider". We call this the **Pay At Bill Time** method.
- You can tell the system to increase how much you owe the service provider only when you are paid for by the customer. We call this the **Pay At Pay Time** method.

The method used for a service provider is defined on the service provider's record.

FASTPATH:

Refer to [When We Bill For Them, We Owe Them Money](#) for more information.

Paying The Service Provider - Technical Implementation

WARNING:

This section describes, technically, how we increase the amount we owe a We Bill For Them service provider. If you aren't technically inclined, skip this section.

The following illustration shows the logical steps involved with increasing how much we owe a We Bill For Them service provider.

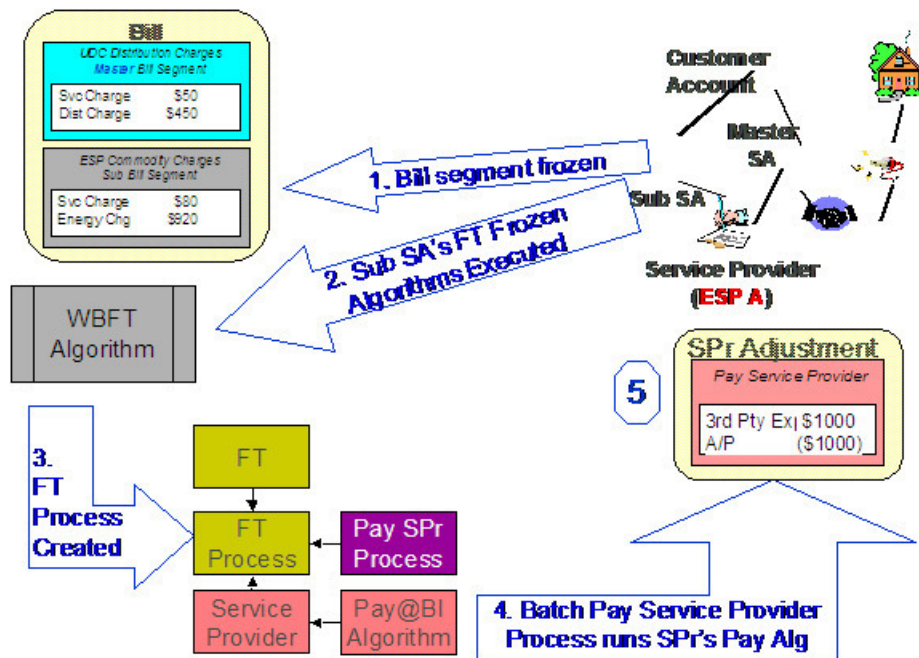

The following points explain the steps:

- When a financial transaction (FT) is frozen, the system executes the FT Freeze algorithms defined on the SA(s) SA type.
- If you've set up the system properly (i.e., you've put the appropriate FT Freeze algorithm on the sub SA's SA type), one of these algorithms will determine if there is a WBFT service provider associated with the sub SA. If so, it will insert a row on the FT Process table.
- Rows on the FT process table are used as "triggers" for batch processes. In this case, the batch process that is triggered is the one that looks at new FT's and determines if a related "payable" adjustment should be created for the We Bill For Them service provider. This batch process uses the service provider's Payment Relationship and Pay Service Provider algorithm to determine when and how to create these "payable" adjustments.

Service Providers Have Service Agreements Too

Most service providers need service agreements as explained in the following topics.

When We Bill For Them, We Owe Them Money

When you bill on behalf of a service provider (i.e., the service provider has a billing relationship of We Bill For Them), you will eventually owe them money (because the customer pays you for the service provider's service). You have two options in respect of when the system increases the amount you owe the service provider:

- You can tell the system to increase how much you owe the service provider when you create the customer's bill. Some people refer to this method as "purchasing the receivable from the service provider".
- You can tell the system to increase how much you owe the service provider only when you are paid for by the customer.

The system keeps track of how much you owe a service provider on a service agreement linked to the service provider's account. The system creates adjustments against this service agreement to increase how much you owe them.

If you "purchase the receivable" (i.e., you owe them when you bill the customer), an adjustment is created when the customer is billed. If you owe them only when you are paid by the customer, an adjustment is created when the customer

pays. The following example illustrates an adjustment being created when the bill is frozen (illustrating the "purchase the receivable" scenario):

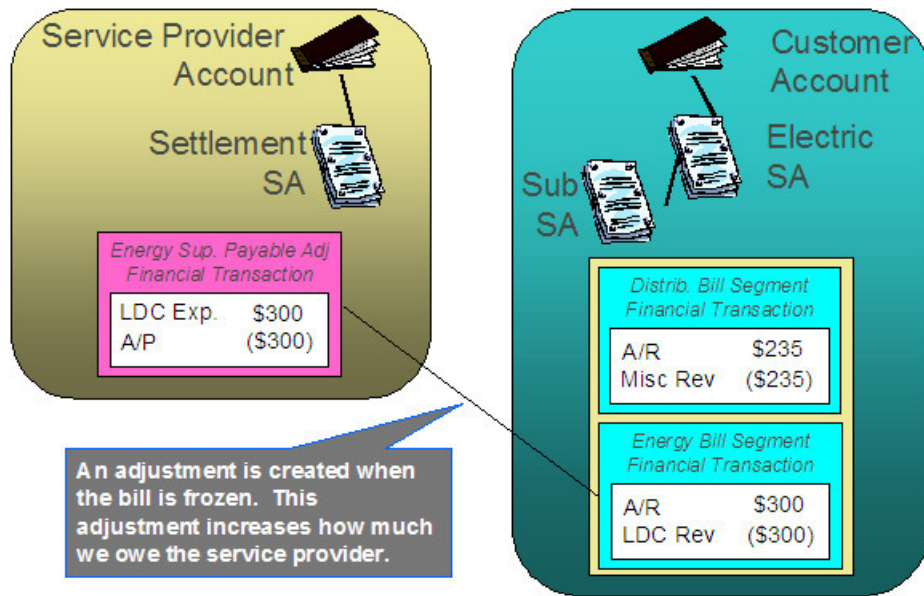

If you only pay the service provider when you are paid, the example would look as follows:

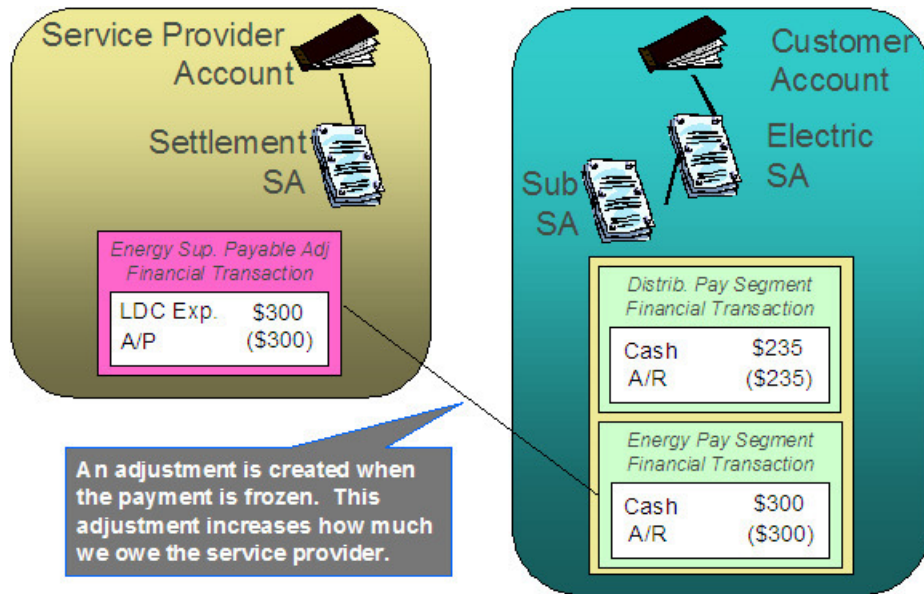

Adjustments and We Bill For Them Service Providers

FASTPATH:

It's important that you are comfortable with the information described under [When We Bill For Them, We Owe Them Money](#) before reading this section.

Adjustments associated with We Bill For Them sub service agreements are tricky. The following points describe how the system "pays" the related service provider when adjustments are issued against the customer's sub service agreement:

- For Pay At Bill Time service providers, most adjustments are treated just like bill segments, i.e., when the adjustment's FT is frozen, a payable adjustment is created for the respective service provider. The reason "most" is underlined in the previous sentence is because A/P adjustments (i.e., adjustments used to interface check requests to your A/P system) are excluded. Why? Because A/P adjustments are used to refund overpayments to the customer. Overpayments are purely between the customer and your company (you never transferred the overpayment to the service provider because it's associated with a Pay At Bill Time service provider).
- For Pay At Pay Time service providers, A/P adjustments are treated just like payment segments, i.e., when the adjustment's FT is frozen, a payable adjustment is created for the respective service provider. All other types of adjustments are ignored. Why? Because A/P adjustments are used to refund overpayments to the customer. Think of it like this - when the customer originally overpaid, you transferred this overpayment to the Pay At Pay Time service provider; therefore, when you refund the overpayment, you get to take the money back from the service provider.

When They Bill For Us, They Owe Us Money

When a service provider bills on behalf of your organization, they will eventually owe you money (because the customer pays them for your service).

The system keeps track of how much a service provider owes you on a service agreement linked to the service provider's account. The question is, How does the system determine how much you are owed when you don't produce a bill? Well, you do produce a bill, it just doesn't get sent to the customer. We understand this is a little confusing, but think about it like this:

- The service provider is presenting your charges on their bill.
- You still have to calculate how much the customer owes your organization otherwise you'll never know how much you are owed by the service provider.

As illustrated below, when a bill is completed, the system determines if there are bill segments and/or adjustments associated with service agreements with a service provider who "bills for us". If it finds these, it transfers the receivable from the customer's service agreement to the service provider's service agreement. If all financial transactions have been transferred to the service provider, no bill is produced for the customer.

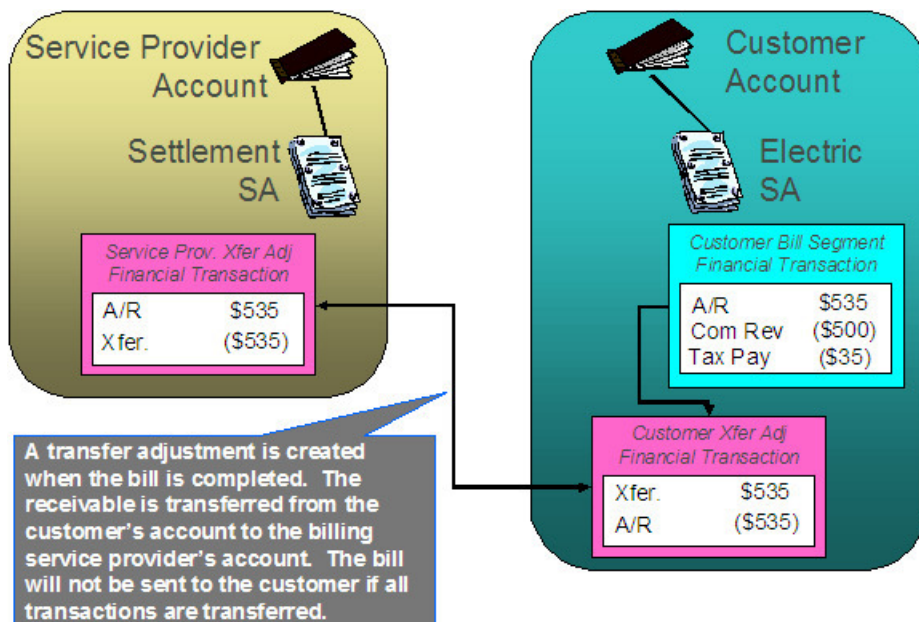

NOTE:

Bottom line. We always generate a bill for "us", even though we don't send it to the customer.

They Bill For Us

If a service provider provides billing services for you, then you have a They Bill For Us billing relationship with the service provider. The topics in this section provide information about this type of billing relationship.

The Customer Still Needs A Service Agreement

If a service provider bills for you, you still need a service agreement for the customer. Why? Because:

- As explained under [Service Providers Are Linked To Service Agreements](#), service providers are defined in respect of a customer's service agreement (therefore the customer must have a service agreement).
- As explained under [When They Bill For Us, They Owe Us Money](#), you still have to calculate bills for the customer.

NOTE:

A customer's bill history still exists. Be aware that even when a service provider bills for us, you will still be able to see the customer's billing history. It's just that the customer won't owe you anything because the receivable balance will be transferred to the service provider's account.

They Bill For Us - Bill Ready

At bill completion time, the system determines if there are bill segments and/or adjustments associated with service agreements with a service provider who "bills for us". If it finds these,

- It transfers the receivable from the customer's service agreement to the service provider's service agreement. If all financial transactions have been transferred to the service provider, no bill is produced for the customer.
- Note that payments and A/P adjustments are not transferred. Why? Because payments and A/P adjustments are purely between the customer and your company.
- Each bill segment and adjustment is marked to be interfaced to the service provider (via a separate background process).

They Bill For Us - Rate Ready

The They Bill For Us - Rate Ready option is not a recommended option. Why? Because you really have to compute how much the customer owes as explained above. If you go to the trouble of figuring out how much the customer owes, then it makes sense to interface this to the billing service provider.

The only difference between this option and They Bill For Us - Bill Ready is that the system will not interface the bill segments and adjustments to the billing service provider.

A/R Transfer - Technical Implementation

WARNING:

This section describes, technically, how a customer's A/R balance is transferred to a They Bill For Us service provider. If you aren't technically inclined, skip this section.

The following illustration shows the logical steps involved with the transference of a customer's A/R balance to a They Bill For Us service provider.

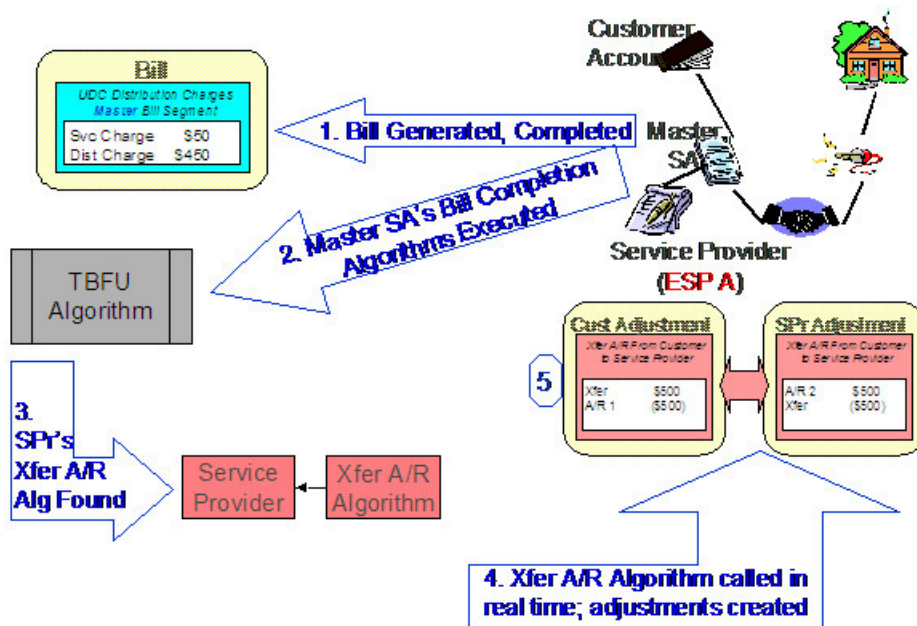

The following points explain the steps:

- When a bill is completed, the system executes the bill completion algorithms defined on the bill's master SA(s) SA types.
- If you've set up the system properly (i.e., you've put the appropriate Bill Completion algorithm on the master SA's SA type), one of these algorithms will determine if there is a They Bill For Us service provider associated with each master SA on the bill. If so, it will execute the Transfer A/R algorithm defined on the service provider's record. This algorithm causes a transfer adjustment to be created (transferring the financial transaction's affect on the customer's balance from the customer to the service provider).

NOTE:

If there are multiple master SAs on a bill, the financial details associated with each respective master SA could be transferred to different service providers (e.g., one service provider could receive the financial details for gas and another for electricity). Refer to [Different Service Providers Can Bill Different Services](#) for more information.

Routing Billable Charges To Service Providers - Technical Implementation

WARNING:

This section describes, technically, how we send billable charges to service providers. If you aren't technically inclined, skip this section.

The following illustration shows the logical steps involved with sending billable charges to service providers.

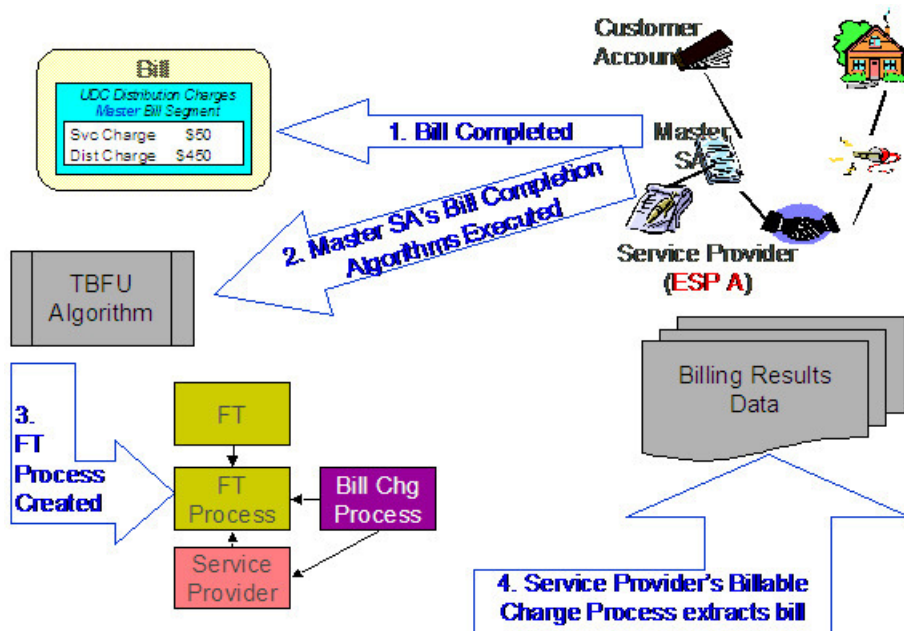

The following points explain the steps:

- When a bill is completed, the system executes the bill completion algorithms defined on the bill's master SA(s) SA types.
- If you've set up the system properly (i.e., you've put the appropriate Bill Completion algorithm on the master SA's SA type), one of these algorithms will determine if there is a They Bill For Us service provider associated with each master SA on the bill. If so, it will insert a row on the FT Process table.
- Rows on the FT process table are used as "triggers" for batch processes. In this case, the batch process that is triggered is the one that downloads billable charges to the service provider. The ID of the batch process that is referenced on the trigger comes from the Service Provider's Billable Charge Download Process.

NOTE:

If there are multiple master SAs on a bill, the financial details associated with each respective master SA could be routed to different service providers (e.g., one service provider could receive the financial details for gas and another for electricity). Refer to [Different Service Providers Can Bill Different Services](#) for more information.

Bill Routings Are Changed

If all of an account's "master" SAs have a SA relationship with a service provider who bills for us (i.e., the service provider's billing relationship is They Bill For Us), then we have nothing to send to the customer. The system still creates bill routings, but with a couple of differences:

- The Batch Process Id and Run Number are reset.
- The Customer's Name is prefixed with the text from a bill message code 6, 10103. This message code's text is *** Bill not sent.

This way, the operators can easily see that that the bill was not routed and why.

FASTPATH:

Refer to [Different Service Providers Can Bill Different Services](#) for information about how the various services under an account could be billed by different service providers.

Combinations Of Service Provider Billing Methods

Consider the following situation:

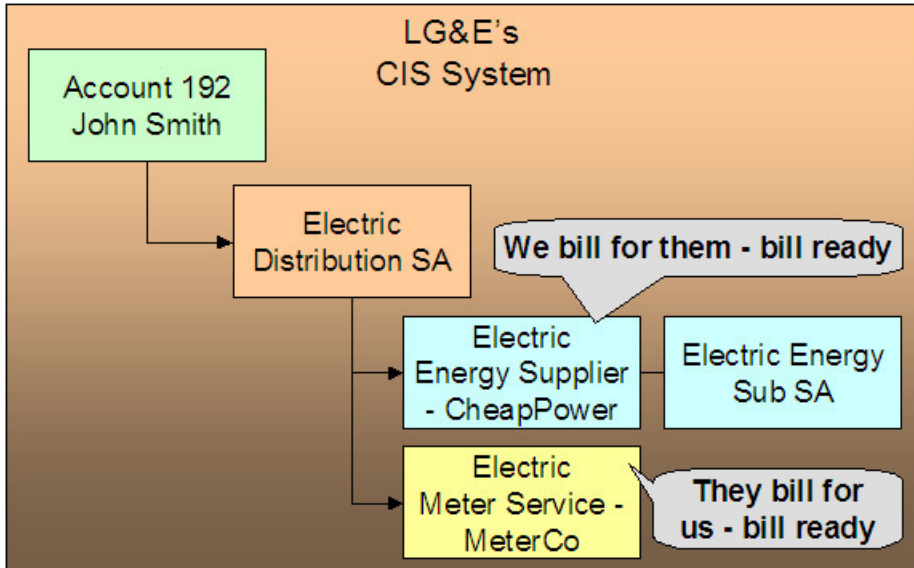

In the above example, we are billing for the energy service provider and the meter service provider is billing for us. This means that we will calculate the charges for ourselves, interface charges from CheapPower, and then interface our charges and CheapPower's charges to MeterCo. MeterCo will then produce a bill for the customer that contains our distribution charges, CheapPower's energy charges, and MeterCo's service charges. To help solidify this point, let's look at how this customer would look in MeterCo's CIS system.

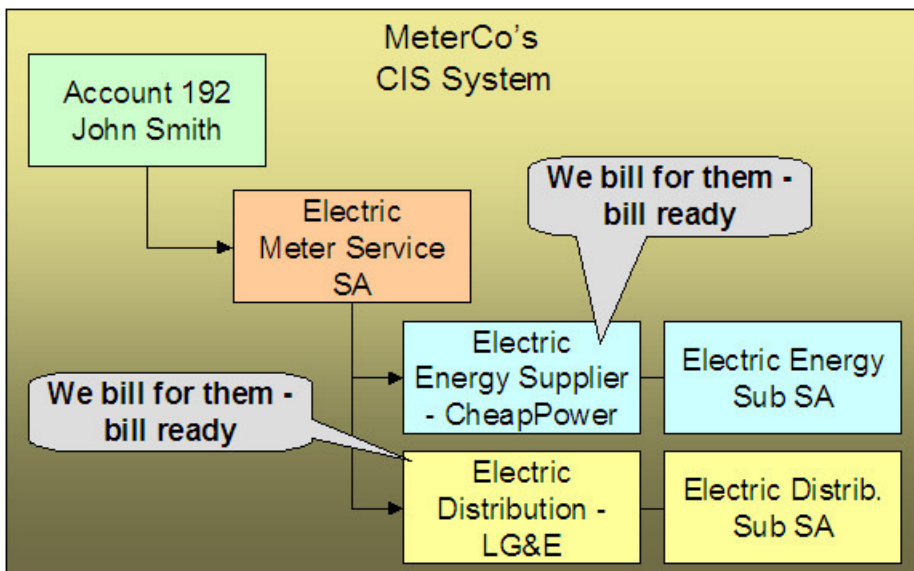

There are some restrictions in respect of permissible combinations of service providers that may supply service to a customer as described in the following points:

- If the system encounters a customer with a We Bill For Them (WBFT) - Bill Ready service provider and another service provider that is They Bill For Us (TBFU) - Rate Ready, a billing error will be produced. Why? Because TBFU - Rate Ready means they have everything they need to calculate our bills and therefore we do not interface bill lines to them.

If we don't interface our bill lines to them, then we can't interface the charges that were interfaced from the WBFT - Bill Ready service provider. You may wonder why we don't prohibit WBFT - Rate Ready and TBFU - Rate Ready, because it's conceivable for the TBFU service provider to have our rate and the WBFT service provider's rate.

- If the system encounters a WBFT - Pay At Pay Time service provider and another service provider that is TBFU, a billing error will be produced. Why? Because when the system detects a TBFU service provider, it transfers the receivable from the customer to the service provider (and therefore the customer's account will never be paid).

Different Service Providers Can Bill Different Services

Be aware that the system determines billing relationships at the service agreement level, NOT at the account level. To make the point, check out the following customer in a distribution company's system:

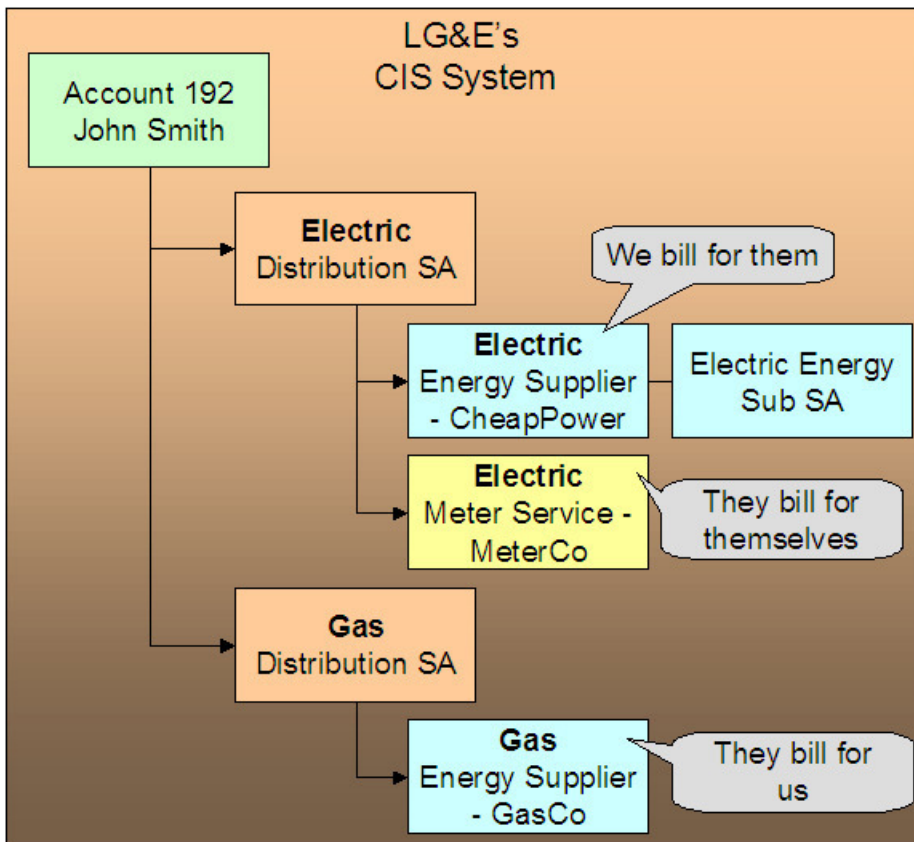

Be aware of the following in respect of the above illustration:

- The distribution company (LG&E) distributes both electricity and gas.
- The customer has a choice of energy service providers for both gas and electricity.
- This customer - John Smith - purchases electricity from CheapPower, and purchases gas from GasCo.
- LG&E provides billing services for CheapPower.
- GasCo provides billing service for LG&E.

In this situation, LG&E will send bills to the customer that contain both electric distribution and energy charges (but no gas distribution charges). GasCo will also send bills to the customer; these will contain both LG&E's gas distribution charges as well as their own energy charges.

If You Deal With TBFU Service Providers, You Cannot Reopen Bills

FASTPATH:

Refer to [Bill Lifecycle](#) for information about reopening previously completed bills.

If your organization deals with They Bill For Us (TBFU) service providers, a great deal happens when a bill is completed (e.g., the receivable is transferred from the customer to the service provider, we may mark the bill segments and adjustments for routing to the service provider, etc.). These things cannot be undone and therefore the system will not let you reopen bills when these things have occurred.

NOTE:

Technical rule. The specific rule that prevents the reopening of bills is as follows: if a bill contains a service agreement whose SA type has one or more bill completion algorithms, the system will not allow the bill to be reopened. Refer to [SA Type - Algorithms](#) for more information about bill completion algorithms.

Consumption Relationships

When you set up a service provider, you must define your organization's consumption relationship with the service provider - a service provider may send the customers' consumption to you, you may send consumption to them, or you may have no consumption relationship with a given service provider.

The topics in this section provide a wealth of information about the various consumption relationships and the ramifications of each.

Only The Master SA Is Linked To Service Points

The following diagram makes the point that service points cannot be linked to sub SAs (i.e., service agreements that exist to hold charges associated with We Bill For Them service providers). This is because all service points associated with our "master" SA are implicitly linked to all sub SAs.

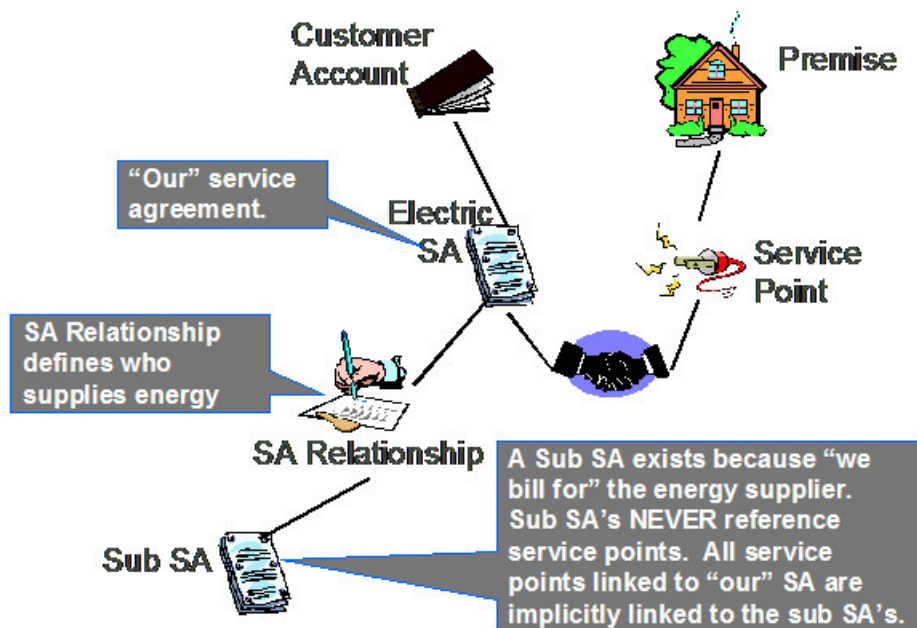

It's important to understand why the system does not allow sub SAs to reference service points:

- The consumption associated with all service providers should be the same, otherwise the customer will receive inconsistent bills from different service providers.
- The easiest way to ensure consumption is the same for all service providers is to make sure that they all have the same service points (which they must if sub SAs "inherit" their service points from their master).

We Can Send Billed Consumption To Any Service Provider

You can send consumption to any service provider. It doesn't matter what their billing relationship is. Information on the service provider object tells the system if AND how to send consumption to a service provider.

Rather than send raw reads to service providers, we download consumption that has been calculated and snapshot onto the "master" bill segment. We send this billed consumption because:

- It is clean and validated
- Register indexes have been subtracted
- Multiple registers have been summed

NOTE:

We only send consumption after a bill segment is Frozen. If your organization supports We Bill For Them - Bill Ready service providers AND you are the source of consumption used by these service providers to calculate their charges, please refer to [The Bill Ready Calculation Method](#) for an explanation of how the system waits a given amount of time for the recipient of the consumption to interface their charges back to the system before sending the bill to the customer. In other words, the bill sent to the customer should contain the bill segment that triggered the consumption download as well as bill segments containing uploaded billable charges.

Routing Consumption To Service Providers - Technical Implementation

WARNING:

This section describes, technically, how we send consumption to service providers. If you aren't technically inclined, skip this section.

The following illustration shows the logical steps involved with sending consumption to service providers.

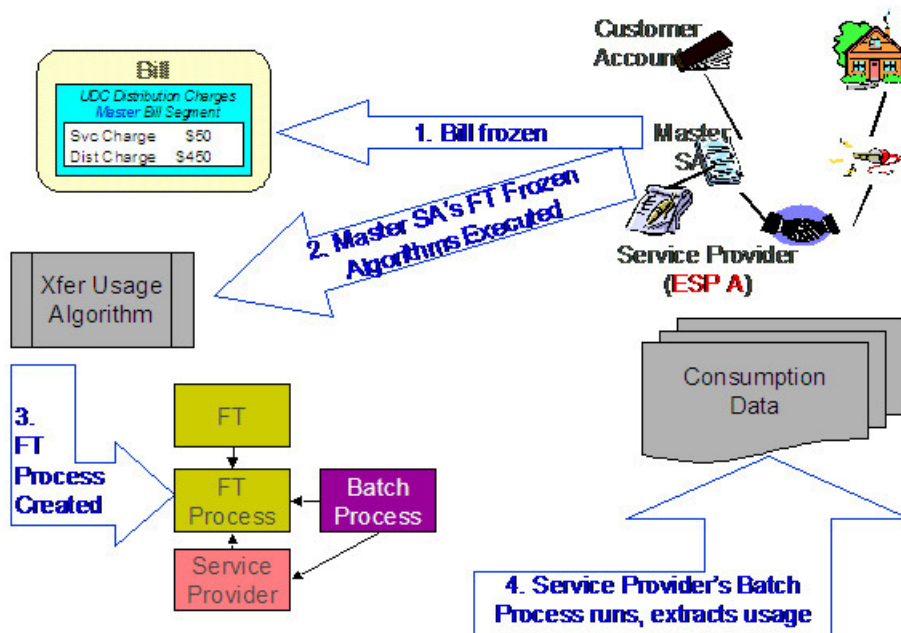

The following points explain the steps:

- When a financial transaction (FT) is frozen, the system executes the FT Freeze algorithms defined on the SA(s) SA type.
- If you've set up the system properly (i.e., you've put the appropriate FT Freeze algorithm on the master SA's SA type), one of these algorithms will determine if there are service providers associated with the master SA who need consumption. If so, it will insert a row on the FT Process table.
- Rows on the FT process table are used as "triggers" for batch processes. In this case, the batch process that is triggered is the one that downloads billable consumption to the service provider. If multiple service providers need consumption, multiple rows will be inserted. The ID of the batch process that is referenced on the trigger comes from the Service Provider's Consumption Download Process.

We Can Receive Consumption From Service Providers

We can receive consumption from any source. The system can receive consumption from service providers. Each customer must have:

- A premise
- A service point
- A device with measuring components sufficient to hold the interfaced consumption

NOTE:

You don't have to perfectly model the service points and meters. If you are not the distribution company, you may be worried about how to keep devices and service point information up-to-date. Be aware that you don't have to model the SPs and devices perfectly. Why? Because you just need to set up enough information so that consumption can be received accurately.

MDMAs And Service Cycles

WARNING:

This section uses terminology and concepts described in [The Cyclical Meter Read Process](#).

A Meter Data Management Agency (MDMA) is a service provider who reads meters. In some locales, a meter can be read by a variety of MDMAs, in other locales there is no MDMA as the meter is read by the distribution company. If your organization has MDMAs, then you need to be aware of the following:

- MDMAs must be linked to service agreements as a service provider. Like all service providers, they can change over time.
- When an MDMA is reading a service agreement's meters, the MDMA may override the customer's service cycle (and schedule) with their own cycle. If they do this, the customer's service cycle in the MDMA's system is defined on the service agreement's SA relationship information for the MDMA. Note: whether or not a service provider can override a service cycle is controlled by a switch on the service provider's record. Refer to [Setting Up Service Providers](#) for more details.
- A service provider's service cycle schedules are maintained using the system's normal service cycle schedule. The ID of the service provider associated with each schedule is defined on the service cycle; in other words, if a service provider reads meters and they can override the customer's service cycle, the service provider's service cycles must be defined in the system. Refer to [Designing Service Cycles, Routes, And Schedules](#) for more information.
- At billing time, the system determines if a service agreement is covered by an MDMA. If so, it uses the service cycle defined on the service agreement's MDMA SA relationship record.
- If your organization ever reads the customers' meters, your regular read cycle should be maintained on your service points. You can think of the service cycle that is defined on a service agreement's MDMA SA relationship record as an override of your service points normal service cycle.
- If the meter read download process detects that a service point is linked to a service agreement with an active MDMA, it still creates a meter read download staging record; however, it marks it as Do Not Need To Read. This means that when a service point is no longer read by an MDMA, the meter read will be downloaded normally.
- Refer to [We Can Receive Consumption From Service Providers](#) for a description of how a service provider interfaces consumption into the system.

Deposits Issues

WARNING:

This section uses terminology and concepts described in [The Big Picture Of Deposits](#).

Deposits should be held using normal deposit service agreements (SAs). You should NOT use the [Sub Service Agreements](#) (sub SA) functionality to hold or bill for deposits because deposit service agreements do not have the same state transition as do master SAs (e.g., you can activate or stop a deposit independent from its master).

However sub SAs can be covered by a deposit. If so, their SA type must reference a deposit class. To make the point, let's examine a few scenarios:

- Assume you have a sub SA for your own charges (this can happen when we use sub SAs to unbundle charges from the Master SA). In this case, it is likely that the sub SA and master SA will be in the same deposit class. This means that a single deposit SA would cover both the master and the sub SA.

- Assume They Bill For Us (Bill or Rate Ready). In this situation, we still have a master SA for our charges and we transfer the charges to the service provider who does the billing. In this case, it is likely that we would be holding the deposit for the service provider, not on the end-use customer. If we are in a situation where 1) we cannot hold a deposit against the service provider, and/or 2) we are not assured of the service provider paying us when the customer doesn't pay them, then we might want to put the master SA in a deposit class and hold a deposit against the customer's account using a normal deposit SA. We would not expect the service provider to bill the customer for the deposit, so we don't need a sub SA. We bill the customer directly for the deposit using our normal deposit SA.
- Assume We Bill For Them (Bill or Rate Ready). In this situation, we could hold a normal deposit SA for the customer's master SA. For sub SAs, we have two scenarios:
 - **We pay at billing time.** Since we purchase the receivable, we would want to increase our normal deposit to cover the Sub SA. To do this, the sub SA's SA type's deposit class should be the same as our master SA's deposit class.
 - **We pay at payment time.** It seems unlikely that we would want to hold a deposit on behalf of a service provider when we don't purchase the receivable. However, it is possible to do so by putting the sub SA into its own deposit class. If you did this, the system will require a separate deposit SA for the service provider's deposit. The system would calculate and refund such deposits using the algorithms defined on the new deposit SA's SA type's deposit class. It's important to be aware that the deposit is not held with respect to the specific service provider. Rather, it is just held in the system as separate deposit that could be used for any service agreement that belongs to its deposit class.

Credit and Collection Issues

WARNING:

This section uses terminology and concepts described in [The Big Picture Of Credit & Collections \(C&C\)](#).

C&C is only tricky if you deal with We Bill For Them service providers. We'll run through the service provider billing relationships to explain why:

- If we have a Dual relationship with a service provider, we don't have their debt, so we only have a responsibility to tell them when we cut a customer (via a Notification). We don't have to worry about collecting their debt.
- If we have a They Bill For Us relationship with a service provider, there is no debt on the customer's SA because it gets transferred to the service provider (and the service provider's SA will fall into arrears if they don't pay us).
- If we have a We Bill For Them or It's Us relationship with a service provider, the customer's debt associated with the service provider's service is maintained on a sub SA (i.e., it is segregated from our debt). This segregation of debt is both a powerful feature and a cause of administrative difficulties. The topics in this section provide more information about this issues.

Debt Class Recommendations

A service agreement's debt class is an important element in determining how a customer's debt is collected. In general, we recommend the following:

- If the service provider has a billing relationship of It's Us, we recommend the sub SAs belong to the same debt class as the "master". Why? Because both SAs' overdue debt should probably be grouped together under a single collection process.
- If you buy the receivable from the service provider (i.e., the service provider has a payment relationship of Pay at Billing Time), we recommend the sub SAs belong to the same debt class as the "master". Why? Because both SAs' overdue debt should probably be grouped together under a single collection process.

- If you don't buy the receivable from the service provider (i.e., the service provider has a payment relationship of Pay at Pay Time), you may want to use a different debt class on the sub SA. Why? Because you may collect the service provider's debt differently.

NOTE:

Bottom line. If both the "master" and the sub SAs fall into arrears, you will have 1 or 2 collection processes, it all depends on the debt class assigned to each SA type.

FASTPATH:

Refer to [Automating Your C&C Activities](#) for information describing how debt class plays a part in this processing.

Severing Service

Sub SAs and severance is tricky. Why?

- Because it's possible for the master SA to be in arrears when the sub SA isn't (for all the standard reasons - directed payments, cancel / rebills, etc.).
- Because it's possible for the sub SA to be on one collection process and the master to be on another (due to different debt classes or different time lines).

Both of these situations could result in severance starting for only one of the service agreements in the master / sub relationship. However, **YOU CAN'T CUT SERVICE FOR ONE WITHOUT CUTTING THE OTHER** because there is only one service point.

Before we describe how to deal with this conundrum, we'd like to remind you that the system starts a unique severance process for each SA (sub or normal) to be severed. It only creates a severance process for those service agreements linked to a collection process when the collection process' Start Severance event is activated. The type of severance process that is created is controlled by each service agreement's SA Type's severance criteria. Please keep in mind the following when designing these severance processes:

- **Only The "Master" Service Agreement Is Linked To Service Points.** This means only master SAs should have a "cut for non payment" severance event. Note: typically, such a severance process will expire the "master SA" several days after the cut event if funds are NOT received.
- As described under [Sub SA State Transition](#), a sub SA becomes Pending Stop (and eventually Stopped) when its "master" is stopped. This means the sub SAs will be finalized when the master is finalized.
- If you start severance on a sub SA when the master isn't being severed, you have a problem because you can't cut the sub SA independent from the master SA.

We'll use an example to illustrate how you should design your severance processes to deal with the above challenge. Assume you have a master and a sub SA where both are being managed under the same collection process. Also assume that the Start Severance event kicks off on 18-Dec-1999. In this situation, we'd recommend the following severance processes to be kicked off.

Master SA Severance Process		
Trigger Dt.	Event Type	Status
18-Dec-99	Set door hanger	Pending
Pending	Cut for non pay	Pending
Pending	Expire SA	Pending

Sub SA Severance Process		
Trigger Dt.	Event Type	Status
3-Jan-00	Create To Do Entry	Pending

Notice that the sub SA's severance process contains a single event that generates a To Do Entry on a date in the future of the Expire SA event on the Master SA. This entry should be something like "sub being severed independent of its master". This event will only be triggered if the master SA is paid off and the sub SA isn't. Why? Because if the master SA's Expire SA event is executed, the Sub SA will be Stopped and stopping a SA cancels outstanding severance processes. If the sub gets paid, the system will cancel the sub's severance process.

Let's change the example and assume that the master starts severance and the sub doesn't. In this situation, the master SA will eventually hit the Expire SA event and the sub SA will also stop. There's no alternative.

And let's change the example again and assume the sub starts severance and the master doesn't. In this situation, the To Do Entry will only be created X days after the start of severance. If you can't stand this date being X days in the future of the creation of the severance process, create an "Severance Criteria Algorithm" that checks if the master is not being severed or collected and generates a different severance process (with a different start date). Refer to [Designing Your Severance Procedures](#) for more information about Severance Criteria Algorithms.

An Object-Oriented Perspective Of Service Providers

WARNING:

Skip this section if you are not technically inclined.

The following object diagram illustrates in a concise format the various types of service providers and the plug in algorithms and processes available for each.

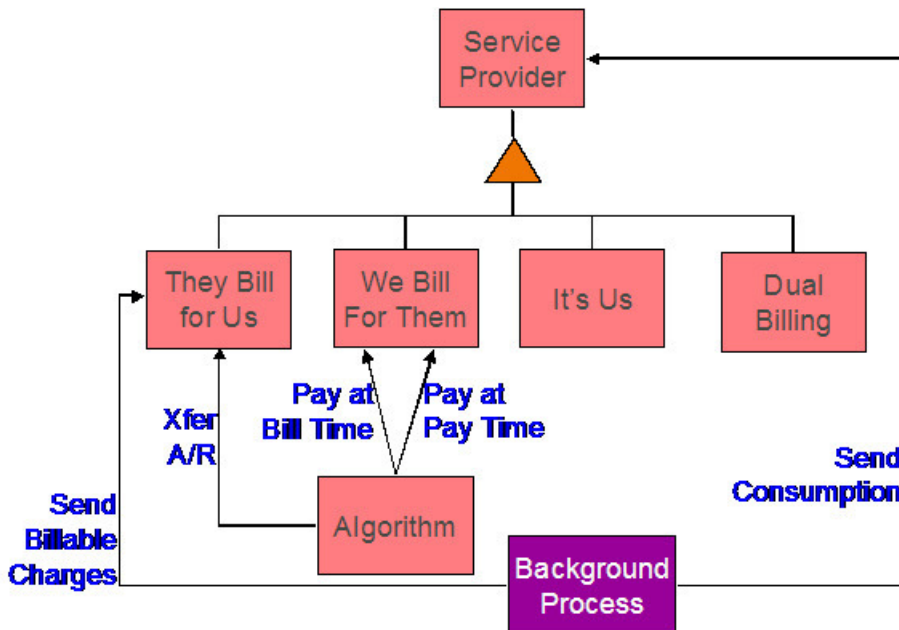

How Do You Communicate With Service Providers?

You communicate with service providers (and they communicate with you) using the following mechanisms:

- You can use traditional interface techniques. For example, if you send consumption to service providers every month (so they can compute their charges), you could use the Consumption Download interface.

- You can use "notifications" to communicate with service providers. Notifications are electronic transactions that service providers exchange to communicate information about a customer. For example, you could use a notification to send a message to an energy supplier when a customer stops service. Note: the term "Direct Access Service Request" (DASR) is synonymous with Notification.

The difference between notifications and traditional interfaces is subtle. Think of notifications as a generic interface that can be used to communicate many different things (e.g., you can use notifications to advise stops, meter exchanges, supplier switches). Traditional interfaces communicate only one thing (and you need one traditional interface for each "thing"). For example, one interface is devoted to downloading consumption, another is responsible for uploading pass through charges, etc.

Off Cycle Switch

If the customer care and billing application integrates with meter data management (mdm) system, it may be set up to generate sub-bill segments for each and every service provider having **We Bill for Them - Rate Ready** or **It's Us** billing relationship, that is effective in the billing period. This requires that the meter data management system can calculate the consumption for each effective SA relationship period.

If the switch is from or to a service provider having **They Bill for Us** billing relationship, separate bills have to be generated manually for each relationship effective in the billing period. This restriction is due to requirement for CCB application to generate a bill for a **They Bill for Us** relationship, so that the customer's charges are calculated and eventually transferred to the service provider. The generated bill for **They Bill for Us** billing relationship is not sent to the customer.

Billing Master Configuration

To enable Off Cycle Switch, navigate to **Admin > General > Master Configuration** and add a new entry for Billing Master Configuration.

Specify the values for **Off Cycle Switch Option**, **Implementation Date** and **Off Cycle Switch Option for Old Bill**. Refer to the embedded help on billing master configuration portal for details.

Rate Schedule

Rate schedules assigned to the sub-SA of service provider, having **We Bill for Them - Rate Ready** or **It's Us** billing relationship, must be configured with an SQ rule (for component-based engine) or a pre-processing calculation rule (for rule-based engine) that will obtain the sub-usage's consumption and load it into the bill segment SQ collection during rate application.

For more information, refer to the base package algorithm types provided for this purpose: US (component based engine) and C1-ACRSUBUSG (rule based engine).

Sub-SA Type

When implementing this feature, sub-SA types of service provider having **We Bill for Them - Rate Ready** or **It's Us** billing relationship must be configured as non-bill determinant.

Usage Request

Usage request is sent to the Oracle Utilities Meter Data Management (MDM) system, to obtain the calculated consumption for the billing period - this is used to calculate master bill segment's charges.

In addition, sub-usage request is sent to the mdm system, for each relationship that is effective during the billing period. Calculated consumption on these sub-usage requests is used to calculate sub-bill segment charges.

Sending Consumption to Service Providers

Calculated consumption on these sub-usage requests also serves as the source for consumption download process if consumption is required to be sent to the service provider. A base package algorithm type - C1-STGCNSMP, stages the download by creating an entry in the general process table, capturing the sub-usage id, batch control for consumption download and the batch number.

NOTE: It is implementation responsibility to build the consumption download batch process that will extract the consumption for sub-usage request as required.

Designing Your SA Relationship Types and Service Providers

As explain in [A Service Agreement Can Have Many Types Of Relationships](#), SA relationship types and service providers are only required when you subcategorize your service agreements.

The topics in this section describe how to design your SA relationship types.

Designing SA Relationship Types

The easiest way to design SA relationship types is to start with the matrix of SA types designed in [SA Types And The Financial Design](#). For each SA type in the matrix, determine if either of the following questions is true:

- Can companies other than your own provide some subcategory of the service (and do you have some type of interaction with these companies)? For example, this would be true if you are an energy supply company because a different company is responsible for distributing the power to the customer (and you probably exchange consumption and financial transactions with this company).
- Does your organization use different rates for subcategories of the service? For example, this would be true if you use separate rates for water and wastewater service (even though both are based on the customer's water consumption).

If either of the above is true, you will need a SA relationship type for each subcategory of service.

We'll use an example to help make the point. Using the SA types we designed earlier (see [SA Types And The Financial Design](#)), we'll assume the following:

- We are designing the system for an electric, gas, water, waste water, and cable utility.
- Residential electric customers have a choice of energy supplier.
- Commercial and industrial electric customers can choose an energy supplier and a meter service provider.
- Commercial and industrial gas customers have a choice of energy supplier.

NOTE:

We are not showing most of the SA types that we designed earlier because they do not have subcategories of service.

CIS BU/ SA Type	SA Relationship Type
G/COM	Energy supply
G/IND	Energy supply
E/RES	Energy supply

E/COM	Energy supply
	Meter service
E/IND	Energy supply
	Meter service

NOTE:

Notice that we did not design a SA relationship type for our own distribution service. This is because our relationship type is implied (e.g., if you are a distribution company, you do not have to set up a SA relationship type for distribution service because the customer's "master" service agreement is implicitly associated with distribution service).

Designing Service Providers

After you design your SA relationship types, you need to list every potential service provider for each SA relationship type.

CIS BU/ SA Type	SA Relationship Type	Service Provider
G/COM	Energy supply	AmeriGas
		TransGas
		Green Power
G/IND	Energy supply	AmeriGas
		TransGas
		Green Power
E/RES	Energy supply	Green Power
		Cheap Power
		Us
E/COM	Energy supply	ElectriCorp
		Cheap Power
		TeniCorp
	Meter service	MeterCorp
		Us
E/IND	Energy supply	ElectriCorp
		Cheap Power
		TeniCorp
	Meter service	MeterCorp
		Us

Next, list each unique service provider identified above:

Service Provider
AmeriGas
TransGas

Green Power

Cheap Power

Us

ElectriCorp

TeniCorp

MeterCorp

You will have at least one service provider for each entry in the above list. However, you may have to set up more than one service provider in the system for a given company. The topics below explain how this happens.

Billing Relationship Segmentation

As described under [Billing Relationships](#), a service provider may bill for you, you may bill for them, or you may each send a separate bill to the customer. In the table below, we have shown the assumed billing relationships for each service provider.

Service Provider	Billing Relationship
AmeriGas	We Bill For Them - Bill Ready
TransGas	We Bill For Them - Bill Ready
Green Power	We Bill For Them - Rate Ready
Cheap Power - Res	We Bill For Them - Rate Ready
Cheap Power - Com/Ind	Dual Billing
Us - Billable	It's Us
Us - Non billable	None
ElectriCorp	They Bill For Us - Bill Ready
TeniCorp	We Bill For Them - Bill Ready
MeterCorp	Dual Billing

Notice that we had to introduce additional service providers:

- Cheap Power has two service providers - one for residential customers, the other for commercial/industrial customers. This is necessary because we provide billing service for them for residential customers (We Bill For Them - Rate Ready), but for commercial and industrial customers they bill for themselves (Dual Billing).
- Our own service provider (the service provider known as "Us") has two service providers - one for energy supply because we bill for the energy we supply (It's Us), and another for meter service because we don't create bills for meter service (None).

We Bill For Them - Payment Relationship Segmentation

As described under [Pay At Bill Time vs. Pay At Pay Time](#) when you provide billing service for a service provider you have to define if you pay the service provider when you bill the customer OR only later, when the customer pays you.

In the table below, we have shown the payment relationships for each service provider.

Service Provider	Billing Relationship	Payment Relationship
------------------	----------------------	----------------------

AmeriGas	We Bill For Them - Bill Ready	Pay At Billing Time
TransGas	We Bill For Them - Bill Ready	Pay At Billing Time
Green Power	We Bill For Them - Rate Ready	Pay At Billing Time
Cheap Power - Res	We Bill For Them - Rate Ready	Pay At Billing Time
Cheap Power - Com/Ind	Dual Billing	N/A
Us - Billable	It's Us	N/A
Us - Non billable	None	N/A
ElectriCorp	They Bill For Us - Bill Ready	N/A
TeniCorp - Com	We Bill For Them - Bill Ready	Pay At Billing Time
TeniCorp - Ind	We Bill For Them - Bill Ready	Pay At Pay Time
MeterCorp	Dual Billing	N/A

Notice that we had to introduce an additional service provider for TeniCorp because for commercial customer we purchase the receivable (Pay At Bill Time), but for industrial customers we only pay them when we're paid by the customer (Pay At Pay Time).

Consumption Relationship Segmentation

As described under [Consumption Relationships](#) a service provider may send the customers' consumption to you, you may send consumption to them, or you may have no consumption relationship with a given service provider.

In the table below, we have shown the consumption relationships for each service provider.

Service Provider	Billing Relationship	Payment Relationship	Consumption Relationship
AmeriGas	We Bill For Them - Bill Ready	Pay At Billing Time	We Send Consumption
TransGas	We Bill For Them - Bill Ready	Pay At Billing Time	We Send Consumption
Green Power	We Bill For Them - Rate Ready	Pay At Billing Time	N/A
Cheap Power - Res	We Bill For Them - Rate Ready	Pay At Billing Time	N/A
Cheap Power - Com/Ind	Dual Billing	N/A	N/A
Us - Billable	It's Us	N/A	N/A
Us - Non billable	None	N/A	N/A
ElectriCorp	They Bill For Us - Bill Ready	N/A	N/A
TeniCorp - Com	We Bill For Them - Bill Ready	Pay At Billing Time	We Send Consumption
TeniCorp - Ind	We Bill For Them - Bill Ready	Pay At Pay Time	We Send Consumption
MeterCorp	Dual Billing	N/A	N/A

Notice that we didn't have to proliferate service providers due to consumption relationships.

Other Segmentations

The earlier parts of this discussion described the most common factors that cause the creation of service providers. However, many obscure factors could cause the introduction of more service providers. In this section we explain these more obscure factors.

Payment Method

As described under [Pay At Bill Time vs. Pay At Pay Time](#), when you provide billing service for a service provider you have to pay the service provider at some point in time. The algorithm that defines the amount to pay (and how the related adjustment is generated) is defined on the service provider record. If a service provider has different payment algorithms for different customer segments, you must split the service provider accordingly.

Transfer Receivable Method

As described under [When They Bill For Us, They Owe Us Money](#), a service provider will owe you money if they provide billing service for you. The algorithm that defines how to transfer the customer's receivable to the service provider is defined on the service provider record. If a service provider has different transfer A/R algorithms for different customer segments, you must split the service provider accordingly.

Billable Charge Download Process

As described under [They Bill For Us - Bill Ready](#), billable charges are interfaced to service providers who provide billing service for you. The background process that performs the interface of billable charges is defined on the service provider record. If a service provider has different billable charge interfaces for different customer segments, you must split the service provider accordingly.

Consumption Download Process

As described under [We Can Send Billed Consumption To Any Service Provider](#), consumption can be sent to any service provider. The background process that performs the interface of consumption is defined on the service provider record. If a service provider has different consumption interfaces, you must split the service provider accordingly.

Notification Upload Processing

A service provider can send you notifications. Whenever a notification is uploaded, the system creates a workflow process to process each such notification. The type of workflow process that's created is controlled by the service provider's workflow process profile. If a service provider requires a different workflow process for a given type of notification (for whatever reason), you must split the service provider accordingly.

Notification Download Processing

The system will send notifications to service providers when something noteworthy happens and when information is needed from a service provider. The type of notification that is sent to a service provider and the background process that interfaces the notification to the service provider is defined on the service provider's notification download profile. If a service provider requires a different type of notification to be sent or they have different interface protocols for a given type of notification, you must split the service provider accordingly.

Financial Settlement Service Agreement

As described under [Service Providers Have Service Agreements Too](#), service providers have service agreements. These service agreements contain how much you owe the service provider (if you bill for them) and how much they owe you (if they bill for you). If you want to have separate service agreements for financial settlements associated with distinct customer segments, you must split the service provider accordingly.

Geographic Area Segmentation

The following table reflects the new service providers that were added since we started [Designing Service Providers](#).

CIS BU/ SA Type	SA Relationship Type	Service Provider
G/COM	Energy supply	AmeriGas
		TransGas
		Green Power
G/IND	Energy supply	AmeriGas
		TransGas
		Green Power
E/RES	Energy supply	Green Power
		Cheap Power - Res
		Us - Billable
E/COM	Energy supply	ElectriCorp
		Cheap Power - Com/Ind
		TeniCorp - Com
	Meter service	MeterCorp
	Us - Non billable	
E/IND	Energy supply	ElectriCorp
		Cheap Power - Com/Ind
	Meter service	MeterCorp
	Us - Non billable	

Next, determine the postal code ranges in which a service provider is allowed to provide service.

CIS BU/ SA Type	SA Relationship Type	Service Provider	Postal Range
G/COM	Energy supply	AmeriGas	94000 - 95999
		TransGas	94000 - 95999
		Green Power	94000 - 95999
G/IND	Energy supply	AmeriGas	94000 - 95999

		TransGas	94000 - 95999
		Green Power	94000 - 95999
E/RES	Energy supply	Green Power	94000 - 95999
			93000 - 93999
		Cheap Power - Res	94000 - 95999
		Us - Billable	94000 - 95999
E/COM	Energy supply	ElectriCorp	94000 - 95999
		Cheap Power - Com/Ind	94000 - 95999
		TeniCorp - Com	94000 - 95999
	Meter service	MeterCorp	94000 - 95999
		Us - Non billable	94000 - 95999
E/IND	Energy supply	ElectriCorp	94000 - 95999
		Cheap Power - Com/Ind	94000 - 95999
		TeniCorp - Ind	94000 - 95999
	Meter service	MeterCorp	94000 - 95999
		Us - Non billable	94000 - 95999

Next, we need to strip off the SA types because the postal ranges are defined for combinations of service provider and SA relationship type. Notice the problem - we have a service provider - Green Power has different postal ranges for the same SA relationship type. You have two ways to fix this problem, you can split your service provider (have one for the gas and another for the electric), or you can split the SA relationship type (have one for the gas and another for the electric). We've chosen the former in our example.

SA Relationship Type	Service Provider	Postal Range
Energy supply	AmeriGas	94000 - 95999
	TransGas	94000 - 95999
	Green Power - Gas	94000 - 95999
Energy supply	AmeriGas	94000 - 95999
	TransGas	94000 - 95999
	Green Power - Gas	94000 - 95999
Energy supply	Green Power - Electric	94000 - 95999
		93000 - 93999
	Cheap Power - Res	94000 - 95999
	Us - Billable	94000 - 95999
Energy supply	ElectriCorp	94000 - 95999
	Cheap Power - Com/Ind	94000 - 95999
	TeniCorp - Com	94000 - 95999
Meter service	MeterCorp	94000 - 95999
	Us - Non billable	94000 - 95999
Energy supply	ElectriCorp	94000 - 95999
	Cheap Power - Com/Ind	94000 - 95999

	TeniCorp - Ind	94000 - 95999
Meter service	MeterCorp	94000 - 95999
	Us - Non billable	94000 - 95999

In the table below, we have shown the final list of service providers.

Service Provider	Billing Relationship	Payment Relationship	Consumption Relationship
AmeriGas	We Bill For Them - Bill Ready	Pay At Billing Time	We Send Consumption
TransGas	We Bill For Them - Bill Ready	Pay At Billing Time	We Send Consumption
Green Power - Electric	We Bill For Them - Rate Ready	Pay At Billing Time	N/A
Green Power - Gas	We Bill For Them - Rate Ready	Pay At Billing Time	N/A
Cheap Power - Res	We Bill For Them - Rate Ready	Pay At Billing Time	N/A
Cheap Power - Com/Ind	Dual Billing	N/A	N/A
Us - Billable	It's Us	N/A	N/A
Us - Non billable	None	N/A	N/A
ElectriCorp	They Bill For Us - Bill Ready	N/A	N/A
TeniCorp - Com	We Bill For Them - Bill Ready	Pay At Billing Time	We Send Consumption
TeniCorp - Ind	We Bill For Them - Bill Ready	Pay At Pay Time	We Send Consumption
MeterCorp	Dual Billing	N/A	N/A

Designing Your SA Types And Start Options For Sub SAs

When you were [Designing Service Providers](#), you defined the service providers that were valid for every combination of SA type and SA relationship type. If you provide billing services for another service provider or if you subcategorize your own services, you another task - you have to design the SA types for your sub SAs.

As described earlier, there will be a separate [Sub Service Agreement](#) for every SA relationship for which we calculate a bill segment. Every sub SA must reference an SA type. The following table shows sample SA types (notice that they are only used for We Bill For Them and It's Us service providers).

CIS BU/ SA Type	SA Relationship Type	Service Provider	SA Type(s) for Sub SAs
G/COM	Energy supply	AmeriGas	AG1
		TransGas	TG1
		Green Power - Gas	GP-GC1
G/IND	Energy supply	AmeriGas	AG1
		TransGas	TG1
		Green Power - Gas	GP-GI1
E/RES	Energy supply	Green Power - Electric	GP-ER1
		Cheap Power - Res	CP-ER1
		Us - Billable	US-ER1
E/COM	Energy supply	ElectriCorp	Not applicable - they bill for us

		Cheap Power - Com/Ind	Not applicable - dual billing
		TeniCorp - Com	TC1
	Meter service	MeterCorp	Not applicable - dual billing
		Us - Non billable	Not applicable - no billing
E/IND	Energy supply	ElectriCorp	Not applicable - they bill for us
		Cheap Power - Com/Ind	Not applicable - dual billing
		TeniCorp - Ind	TC1
	Meter service	MeterCorp	Not applicable - dual billing
		Us - Non billable	Not applicable - no billing

The design steps required to set up these SA types are similar to those described under [Designing SA Types For Service Agreements With Service Points](#). The following points provide a few suggestions that will help you design your SA types for sub SAs:

- The business unit should be the same as defined for the master service agreement.
- Service type should be set up as per [Service Segmentation](#).
- Distribution code should be set up as per [Receivable Segmentation](#).
- Obviously, the sub SA switch should be turned on.
- Start options:
 - If the SA type is used for a We Bill For Them - Rate Ready service provider or for yourself, the start options should be Required because rates, contract riders and/or contract values will be populated on the sub SA from a start option. Refer to [Automatic Creation of Sub SAs](#) for more information.
 - If the SA type is used for a We Bill For Them - Bill Ready service provider, the start options should be not allowed because we don't need to default rates, contract riders and/or contract values on billable charge sub SAs.
- The payment distribution and late payment information should be set up as for any SA type. Refer to [Cash Distribution Segmentation](#) and [Late Payment Charge Segmentation](#) for more information.
- If the SA type is used for We Bill For Them - Bill Ready service provider, the special role should be Billable Charge, otherwise it should not be used. Remember, you should not use sub SAs for Cash Deposits.
- Deposit class should be used if the sub SA is covered by a deposit. Refer to [Deposits Issues](#) for more information.
- The one time charge switch should be off.
- Bill segment type:
 - If the SA type is used for a We Bill For Them - Bill Ready service provider, the bill segment type should reference a bill segment creation algorithm that creates bill segments from billable charges (and generates bill segment errors until the last night of the bill cycle). Refer to [The Bill Ready Calculation Method](#) for more information.
 - If the SA type is used for a We Bill For Them - Rate Ready service provider, the bill segment type should reference a get consumption algorithm that gets consumption from the master SA, and a bill segment creation algorithm that applies a rate.
- Specify a characteristic premise is required if the sub SA is associated with premise-oriented service.
- The calendar billing options should not be used.
- The recurring charge information should not be used.
- Sub SAs used for We Bill For Them - Rate Ready service providers should NOT be eligible for budgets and therefore the eligible for budget switch should be off. This admonition is given because budget billing causes current amount due to be out-of-sync with payoff amount due and we don't want this to happen for sub SAs. Why? Because we use the bill segments associated with these sub SAs to determine how much we owe the service provider.

- If the SA type is used for a We Bill For Them - Rate Ready service provider or for your own company, rates need to be set up; otherwise they should not be used.
- Sub SAs never reference service points. Refer to [Only The "Master" Service Agreement Is Linked To Service Points](#) for more information.
- Adjustment types profiles should be set up accordingly.
- Refer to [Credit and Collection Issues](#) for recommendations in respect of the debt class, write off debt class, and severance criteria associated with these SA types.
- Billable charge templates should not be used.
- Completion algorithms cannot be used for sub SAs.
- If the SA type is used for a We Bill For Them service provider, you should link to the SA type the FT freeze algorithm that controls how we pay the service provider. Refer to [Pay At Bill Time vs. Pay At Pay Time](#) for how this algorithm is used.
- The creation of bill segments for the sub SAs occurs after the bill segment for the related master SA is created. If you populate a [billing processing sequence](#) on an SA type for a sub SA, it is used to control the order in which the sub SAs for a given master SA are processed relative to each other.

Refer to [Setting Up SA Types](#) for how to set up these new SA types in the system.

Reference Send Consumption Algorithm On Master SA Types

As explained under [We Can Send Billed Consumption To Any Service Provider](#), when a master SA's bill segment is frozen, the system must check if there are any service providers who need the bill segment's consumption. If so, it sets up the data necessary to interface the master SA's consumption (snapshot on the bill segment) to the service provider(s). The system will only do this if you specify an appropriate FT Freeze Algorithm on the master SA types. Refer to [SA Type - Algorithm](#) (FT Freeze Algorithm) for more information.

Reference TBFU Algorithm On Master SA Types

As explained under [They Bill For Us](#), when a bill is completed, the system needs to check if there are any service providers who bill for us associated with the bills "master" SAs. If so, it sets up the data necessary to interface the master SA's charges to the service provider and to transfer the receivable balance from the customer to the service provider. The system will only do this if you specify an appropriate FT Completion Algorithm on the master SA types. Refer to [SA Type - Algorithm](#) (Bill Completion Algorithm) for more information.

NOTE:

If there are multiple master SAs on a bill, the financial transactions associated with each respective master SA could be routed to different service providers (e.g., one service provider could bill for gas and another could bill for electricity). Refer to [Different Service Providers Can Bill Different Services](#) for more information.

Designing SA Types For Service Provider Financial Settlements

As explained in [Service Providers Have Service Agreements Too](#), We Bill For Them and They Bill For Us service providers require a service agreement. You must create SA types for these types of service agreements. The following points provide a few suggestions that will help you design these financial settlement SA types:

- Service type should probably be a non-service oriented service type.

- Distribution code for We Bill For Them settlement SAs should be a payable account (or treat it as a "contra" receivable. Refer to [Receivable Segmentation](#) for more information.
- The sub SA switch should be turned off.
- Start options are not allowed.
- The payment distribution and late payment information should be set up as for any SA type. Refer to [Cash Distribution Segmentation](#) and [Late Payment Charge Segmentation](#) for more information.
- Special role should not be used.
- Deposit class should be used if the settlement service agreement is covered by a deposit. This would probably only be used for They Bill For Us service providers (because they will owe us money).
- The one time charge switch should be off.
- These service agreements are not billable and therefore none of the billing information should be specified.
- The characteristic premise switch should be off.
- Rates should not be used.
- Service points should not be used.
- Adjustment types profiles should be set up accordingly.
- Debt class, write off debt class, and severance criteria should be set up accordingly.
- Billable charge templates should not be used.
- Completion algorithms should not be used.
- Freeze algorithms should not be used.

Refer to [Setting Up SA Types](#) for how to set up these new SA types in the system.

Setting Up SA Relationship Information

In the previous section, *Designing Your SA Relationship Types and Service Providers*, we presented a case study that illustrated a mythical organization's SA relationship information. In this section we explain how to set up this information.

Setting Up SA Relationship Types

Open **Admin** > **Open Market** > **SA Relationship Type** to define your SA relationship types. Refer to [Designing SA Relationship Types](#) for more information.

Description of Page

Enter an **SA Relationship Type** code, **Description** and **Service Provider Model** for every relationship type.

Specify the **Market Service ProviderService Provider Model** if the SA relationships of the type reference a Service Provider Market Option — i.e. Market, Provider Configuration Option and Market Relationship Service Provider are specified in addition to SA Relationship Type and Service Provider.

Otherwise, specify the **Service ProviderService Provider Model** .

Setting Up Service Providers

This portal is used to maintain Service Providers.

Refer to [The Big Picture of SA Relationships and Service Providers](#) for more information.

You can access the portal from **Admin > Open Market > Service Provider**. You are brought to a query portal with options for searching for a specific service provider. Once a service provider is selected, you are brought to the maintenance portal to view and maintain the selected record.

The **Service Provider** zone shows the details of the service provider. Refer to the zone's embedded help for more information.

Setting Up SA Types and Start Options For Sub SAs

The SA types and start options described under [Designing Your SA Types And Start Options For Sub SAs](#) must be set up. Refer to [Setting Up SA Types](#) for how to do this.

Setting Up SA Types For Financial Settlements

The SA types described under [Designing SA Types For Service Provider Financial Settlements](#) must be set up. Refer to [Setting Up SA Types](#) for how to do this.

Update Master SA Types With FT Freeze and Bill Completion Algorithms

Refer to [SA Type - Algorithm](#) for more information.

Setting Up SA Relationships For SA Types

This portal is used to maintain SA Type SA Relationship Types.

Refer to [Designing Your SA Relationship Types and Service Providers](#) for more information.

You can access the portal from **Admin > Open Market > SA Type SA Relationship Type**. You are brought to a query portal with options for searching for a specific SA Type SA Relationship Type. Once a record is selected, you are brought to the maintenance portal to view and maintain the selected record.

The **SA Type SA Relationship Type** zone shows the details of the SA Type SA Relationship Type. Refer to the zone's embedded help for more information.

Setting Up Market SA Relationship Options

The following sections describe how to set up Provider Configuration Options, Market Provider Configuration Options and Service Provider Market Options.

Setting Up Provider Configuration Options

This portal is used to maintain Provider Configuration Options.

You can access the portal from **Admin > Open Market > Provider Configuration Option**.

The following zones may appear as part of the portal's **Main** page:

- **Provider Configuration Option List** zone lists all Provider Configuration Option records. Broadcast a record to display the details of the selected record.
- **Provider Configuration Option** zone provides information about the selected Provider Configuration Option.

- **Market Provider Configuration Options** zone lists the existing Market Provider Configurations for the selected Provider Configuration Option. Maintenance actions are available on this zone.

Setting Up Market Provider Configuration Options

This portal is used to maintain Market Provider Configuration Options.

You can access the portal from **Admin > Open Market > Market Provider Configuration Option**. You are brought to a query portal with options for searching for a specific Market Provider Configuration Option. Once a record is selected, you are brought to the maintenance portal to view and maintain the selected record.

The following zones may appear as part of the portal's **Main** page:

- **Market Provider Configuration Option** zone shows the details of the Market Provider Configuration Option.
- **Service Provider Market Options** zone shows the service providers with their start dates, end dates (if applicable) and statuses. Maintenance actions are provided. A broadcast icon appears if the Service Provider Market Option has sub-SA(s) and/or entries in the Status History log. Clicking on the broadcast icon displays the following zones:
 - **Service Agreements** zone shows the Service Provider Market Option's sub-SAs.
 - **Status History** zone shows the history of changes to the Service Provider Market Option, which can include changes to Start Date, End Date and/or Status.

Negotiated Terms

The topics in this section describe the use of SA relationship functionality for applying certain types of negotiated terms. It assumes that you are familiar with SA relationship functionality in general.

NOTE:

Negotiated terms are optional. The functionality described in this section is only relevant if your organization offers this functionality.

Umbrella agreements. If the Contract Management module is not [turned off](#), you may also choose to use umbrella agreements to manage the functionality described here.

Imagine that the head office for a multi-site organization negotiates special terms that cover a number of its sites, each of whom have their own account and service agreement. The negotiated terms typically involve discounts. These discounts may be realized

- Under a single service agreement, separate and distinct from the service agreements that are covered, or
- Individually, for each covered service agreement. In this case, two sub-scenarios exist:
 - The discounts may be reflected on the bill segment of each service agreement, or
 - The discounts may be transferred to another service agreement (the group's service agreement). The discount does NOT appear on the individual bill segment for the service agreements that are covered by the negotiated terms.

SA relationships track and manage complex business relationships between a customer and a service provider. You can define the above relationships using service agreement relationship functionality. This is a special type of SA relationship in which the head office is the service provider.

Examples Of Special Discounts

The following topics illustrate examples of how your organization may configure the system to handle this business functionality.

Example Using Aggregated Consumption

A customer, Fresh Foods has 10 stores each with its own account and electric service agreement, i.e., each store is billed separately. Fresh Food's head office decides to negotiate a group discount that applies to one or more of the individual stores.

In the following diagram, one store's account is shown.

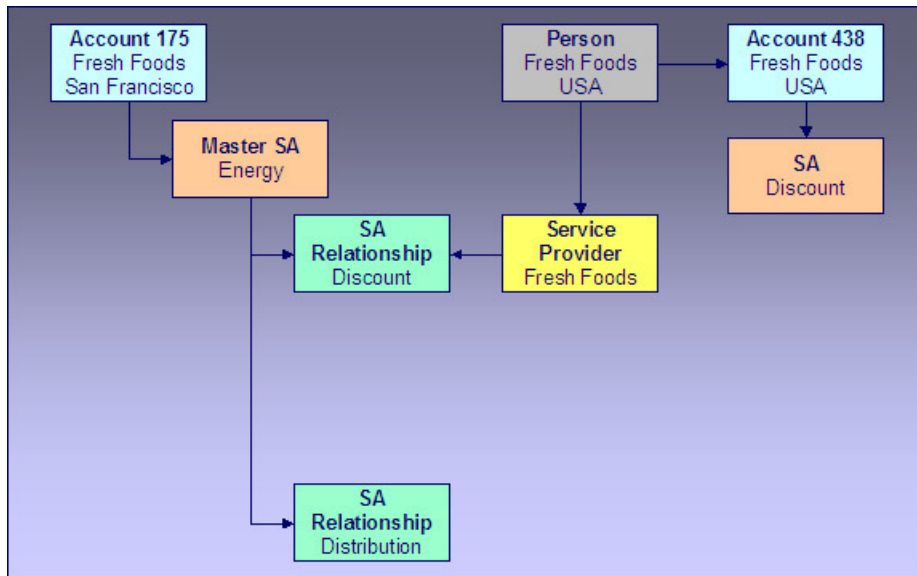

Example Using Aggregated Consumption

Note the following:

- An SA relationship is created for the energy SA covered by the negotiated terms.
- The service provider in the relationship is the head office.
- This relationship does not have a sub-SA because no additional billing services are provided for each individual covered service agreement.
- Discounts are calculated using the head office discount service agreement and affect only this service agreement and therefore only the head office's account.
- The master SA may have other deregulated relationships, such as the distribution relationship shown.

NOTE:

Aggregated consumption algorithm. In this scenario, the service provider's service agreement amalgamates the group's consumption and applies a rate to calculate the discount. This algorithm is not provided - you get to write this algorithm to meet your needs.

Example Using Site-by-site Discount

In this scenario, the discount is calculated on a site-by-site basis.

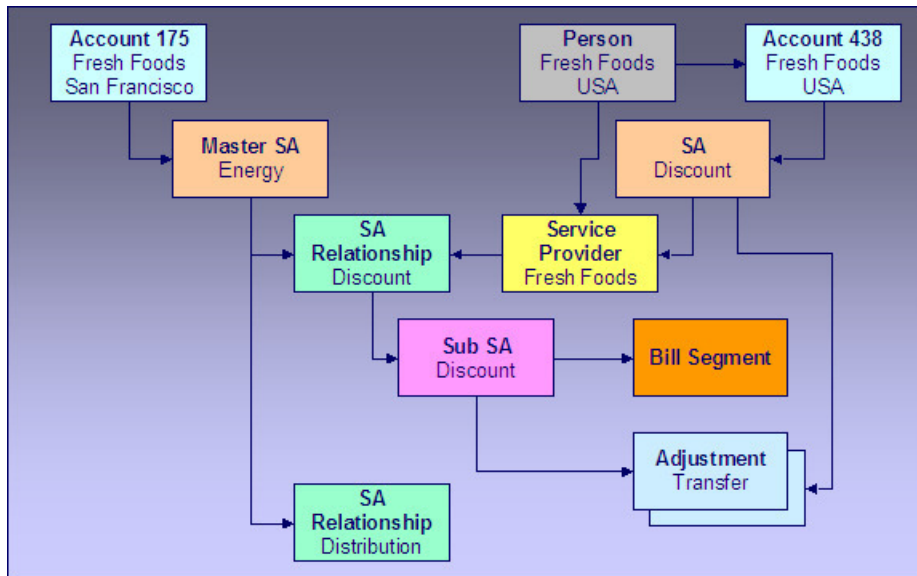

Example Using Site By Site Discount

Note the following differences between this example and the one where consumption is aggregated:

- Each service agreement participating in the discount has an SA relationship with a sub SA.
- Discounts are calculated on a site-by-site basis by the sub SA for each service agreement covered by the discount agreement.
- The discounts may be transferred to the head office service agreement using transfer adjustments. In this case, you may choose to not show the discount on the individual site's bills.

Setting Up The System To Enable Negotiated Terms

The above topics provided background information about how special negotiated terms could be supported in the system. The following discussion summarizes the various setup tasks alluded to above. These notes highlight the setup required in addition to that detailed in [Setting Up SA Relationships Information](#).

Algorithm

If you use sub SAs to calculate charges / discounts for each covered service agreement individually and you want to transfer the charges / discounts to the service provider's service agreement at bill completion, you will need to set up a bill completion algorithm to do this.

Refer to the algorithm type BCMP-TR for more information.

SA Relationship Type

You will need an SA relationship type that will be used for each type of negotiated term or discount.

Service Provider

Set up a service provider using the principal party of the negotiated discount. For example, if a head office negotiates a special agreement for its sites, you should set up a new service provider representing the head office.

- **Billing Relationship** will depend on the type of negotiated terms you choose to set up. For terms where debits / credits are calculated for each covered service agreement individually, select We Bill For Them, Rate Ready. We are effectively billing on behalf of the principal party. For terms where the discount is calculated on an amalgamated SA there is no billing relationship because no additional billing services are provided for each covered service agreement.
- Select a **Payment Relationship** of Pay SPR Not Applicable if debits / credits to the sub-SA should not be transferred to the service provider. If you want to transfer charges at bill completion time using a bill completion algorithm, you should also select Pay SPR Not Applicable because you will not be creating adjustments to pay the principal party service at payment time or at billing time.
- Enter a **Transfer A/R Algorithm** to transfer the debit / credit from the sub-SA to the principal party's service agreement. If you do not want to transfer the debit / credit to the principally party's service agreement, you do not need to specify a transfer algorithm.

SA Type SA Relationship Type

Associate the SA relationship type setup for negotiated terms with the SA type(s) of the service agreements that are covered by the terms. The following are suggested values for the SA type SA relationship type:

- **Required.** Relationships of this type should not be required for the SA type because the negotiated terms will only cover selected service agreements with that SA type.
- **Gaps in SA Relationship** are Allowed if service agreements of this type do not have to have an SA relationship of this type with a service provider throughout the effective period of the SA.
- Add the service provider set up above to the list of valid service providers for this SA type and SA relationship type combination.

SA Type

Set up an SA type for the sub SAs that will be used to calculate discounts. This SA type should use the BCMP-TR bill completion algorithm if you want to transfer the discounts to the head office.

NOTE:

TBFU Deregulated Relationship with WBFT Negotiated Terms Relationship. If you have the unusual situation where a master service agreement has a relationship with a TBFU service provider as well as a negotiated term "relationship" with a WBFT service provider, and you transfer charges / discounts from the discount agreement sub SA to the WBFT service provider, you will not be able to use the algorithms provided to transfer receivables to the service providers. This is because bill completion algorithms associated with the SA type of a master service agreement are executed before any bill completion algorithms associated with the SA types of sub service agreements. Consequently the TBFU XFER algorithm associated with the master service agreement will transfer all receivables from related sub SAs to the TBFU service provider before the BCMP-TR algorithm can transfer the discount agreement receivables. You will need to modify the TBFU XFER bill completion algorithm that transfers receivables from the customer to the TBFU service provider to exclude the discount agreement receivables.

Defining Service Credit Options

Some companies allow their customers to participate in a special rewards program. The term "service credits" is used to describe a program that rewards customers for their business. The topics in this section provide details to help you set up the control tables required to support any service credit program that your company supports.

NOTE:

Penalty Points. The service credits functionality is described in the documentation with the assumption that it is used for accumulating points to reward your customers. However, if your company has a business need to record penalty points for a customer, the service credits functionality may be used for that purpose as well.

The Big Picture Of Service Credits

The topics in this section provide background information about service credit functionality.

Service Credit Membership

Let's look at some examples of special programs that may use service credits functionality:

- Capital credits - When customers receive their utility service from a cooperative, they are considered "members" of the cooperative and may over time receive capital credit allocations from the cooperative based on their service history and the cooperative's profits allocated during that time period.
- Frequent flier miles - Perhaps your company has made an agreement with one or more airlines to allow customers to accumulate frequent flier miles for every x amount spent on service.
- Free pay-per-view movies - Maybe your cable service offers free pay-per-view movies under certain conditions. Using service credits, you can set up your system to accumulate the free pay-per-view movies and use the free movies to offset actual movies viewed by the customer.
- Any other type of loyalty program where the customer earns credits that may later be redeemed in some way.

To participate in a program such as those described above, the customer is linked to a service credit membership. The membership record provides the following functionality:

- It defines the accounts that are linked to the membership.
-

FASTPATH:

Refer to [Who are the Members?](#) for information about linking persons and accounts to a membership.

- It defines a [membership type](#), which controls certain behavior about the membership.
 - It may define an external ID if the membership is associated with an external program, such as a frequent flier mile program.
 - It may define a [service agreement](#) to use for miscellaneous financial transactions that may get created.
 - It may define characteristics used to capture miscellaneous information about the membership.
 - Over time, service credit events are created for a membership. The events indicate an amount that either adds or subtracts credit units (i.e., points, miles, movies, dollars, etc) for the membership.
-

FASTPATH:

Refer to [The Big Picture of Service Credit Membership](#) for more information about functionality related to a membership.

How Are Service Credits Earned?

Service credits may be monetary rewards for service or they may be non-monetary rewards such as free movies or frequent flier miles. In any case, how the membership earns the points or rewards depends on the business rules for the program you are offering.

A typical scenario is that the service credits are earned for a membership as a result of other services linked to the membership's accounts. For example:

- Perhaps free pay-per-view movies are earned when signing up for cable service. In this case, the pay-per-view movie membership is related to the membership account's cable service agreement. Refer to [Service Credits Earned When Starting Service](#) for more information.
- Perhaps one frequent flier mile is earned for every \$10 spent on electricity. In this case, the frequent flier membership is related to the membership account's electricity service agreements (for example, electricity distribution, electricity retail and lamp service). Refer to [service credits earned through billing](#) for more information.
- For a capital credits membership, capital credit allocations are calculated based on the amount spent by the customer for standard service, for example electricity and/or gas service. In this case, the capital credit membership is related to the membership account's electricity and/or gas service agreements. For capital credits, a background process is used to calculate the allocated amounts. Refer to [Allocating Capital Credit](#) for more information.

It is also possible to earn service credits irrespective of other service for the membership's accounts. (Again, it depends on the business rules for the program you are offering.) For example, perhaps you offer 500 frequent flier miles for signing up for service with your company, regardless of the type of service chosen. In addition, assume that no additional miles are earned for ongoing service. In this example, there is no need to link the membership to any service agreements.

FASTPATH:

Refer to [Service Agreements Contribute to a Membership](#) for more information.

Each earned service credit amount is linked to the membership via a [service credit event](#).

How Are Service Credits Redeemed?

Once service credits have been earned for a membership, how may a customer redeem these credits? The method by which the credits are redeemed depends on the business rules for the program you are offering. Here are some examples of how a service credit may be redeemed:

- For free pay-per-view movies, perhaps your customer's monthly cable bill is credited for any pay-per-view movies until all free movies are used. Refer to [Service Credits Redeemed Through Billing](#) for more information.
- For frequent flier miles, the information about the earned miles is exported to the appropriate airline. The miles are actually redeemed by the customer through the airline, not through your company. Refer to [Interface Membership Information to a Third Party](#) for more information.
- For a capital credit membership, the company periodically (maybe once a year) decides if credits should be redeemed (referred to as "retired") and if so, how much. The company runs a background process to calculate the "retirement" amount. When an amount is retired, the membership balance is reduced by the retirement amount and the amount is transferred to service agreements related to the membership. Refer to [Capital Credit Retirement](#) for more information.

NOTE:

Tracking Membership Balances. If service credits are redeemed via the system, your membership should probably be configured to keep track of a balance. Refer to [Event Amounts May Contribute to a Balance](#) for more information.

Each service credit amount redeemed through the system is linked to the membership via a [service credit event](#).

Service Agreements For a Membership

There are three types of service agreements that may be associated with a service credit membership. The following sections describe these types.

SAs Contribute to the Membership

As described in [how are service credits earned](#), many memberships are related to specific service agreements for the membership's accounts. We refer to these service agreements as the SAs that contribute to the membership because often the service credit amounts earned for the membership are based on amounts spent by the customer for these services.

During the lifetime of a membership, service agreements that contribute to a membership may be stopped and other service agreements started. For example, perhaps you have a frequent flier membership that is related to electric service. Imagine that the customer starts out with a certain rate for electric service, but later decides to opt for a different type of rate that requires expiring the old service agreement and creating a new one. How does this affect your frequent flier mile calculation? It depends on how you design the [algorithm](#) that creates the frequent flier events. Essentially, the algorithm must cater for this situation. The following diagram illustrates the scenario.

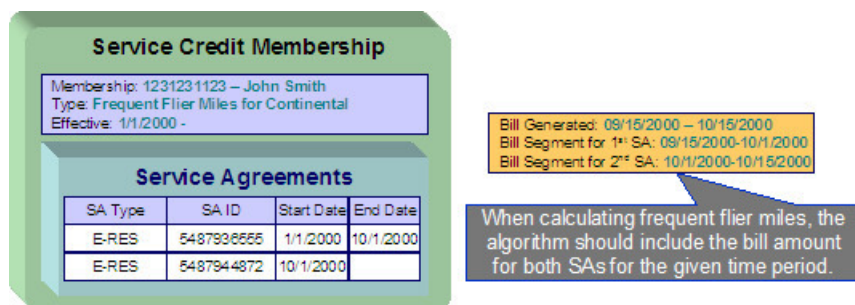

The service agreements that contribute to a membership are not linked directly to the membership record. This would cause a maintenance burden, requiring links to be updated when service is stopped or started for applicable service agreements. Rather, this link is indirect. The list of service agreement types is defined for the membership type. The system can determine which service agreements are "linked" to the membership by looking at the SA types for the membership type.

FASTPATH:

Refer to [Determine The Types of Service Agreements That Contribute to the Membership](#) for more information on designing your membership type to include appropriate SA types.

SA Used for Miscellaneous Transactions

For some memberships, you may need to define a special service agreement to use for miscellaneous transactions. For example:

If events created for a membership cause an adjustment to be created to affect the general ledger, rather than allowing the system to arbitrarily pick a service agreement to use for this adjustment, the SA to use should be indicated on the membership. Refer to [An Event May Cause Other Actions to Occur](#) for more information.

Membership Fee SAs

For some memberships, a [membership fee](#) may be applicable. A special service agreement is used to hold the fee. This service agreement is not linked directly to the membership, but is simply a service agreement linked to one of the membership's accounts.

NOTE:

Some fees may be refundable. The refunding of a fee must be handled by an algorithm. Refer to SAST-RF for information about the algorithm type provided with the base product.

Designing Your Service Credit Options

This section helps you to determine how to design your service credit membership types and service credit event types.

Designing Your Membership Types

This section discusses the options to consider when designing your service credit membership types.

First consider the type of unit that your membership's service credit events represent.

- Is it related to a currency? If so, ensure that your currency is correctly defined on the [currency](#) page.
- Is it a non-currency unit, such as movies, points or miles? If so, you need to define the unit on the [credit unit](#) page.

Next, consider other behavior that your membership may exhibit.

- Should your membership [calculate an overall balance](#) ?
- Will miscellaneous financial transactions be created for you membership over its lifetime? If so you may need to link a [service agreement to your membership](#).
- Should events linked to your membership reference a [fiscal year](#) ?

The table below illustrates three types of memberships: one for capital credits, one for frequent flier miles and one for free pay-per-view movies.

Membership Type	Description	Unit Type / Currency or Credit Unit	Has Balance?	Require SA?	Fiscal Year?
STDCAPCR	Standard capital credit membership	Currency / \$	Yes	Yes	Yes
FFDELTA	Delta frequent flier miles	Credit Unit / Miles	No	No	No
FREEPPV	Free pay-per-view movies	Credit Unit / Movies	Yes	No	No

The following points explain the settings for each membership above:

- The capital credit membership uses a currency of US dollars for its units. Over time, capital credits are allocated and retired. The overall balance of the credits and debits should be calculated and displayed for information purposes. It is common for the allocation and retirement of capital credits to affect the GL, and as a result, a membership SA is required for posting these financial effects. Finally, in a capital credit situation, the allocation is typically related to a specific

fiscal year. When calculating and displaying balances, the balance for each fiscal year must also be available. As a result, the fiscal year must be set to required.

- For the frequent flier membership type, a separate membership type must be created for each different airline. This is because a separate membership must exist for each separate airline in order to keep track of the accumulated miles correctly. The membership type does not have a balance because the accumulated miles are interfaced to the airline and the airline keeps track of the balance. In this example, no SA is required because an assumption is being made that the creation of frequent flier miles does not affect the GL. (Accumulating miles is no liability or expense for the company. The miles are simply accumulated on behalf of a third party.) Finally, the frequent flier miles do not need to indicate a fiscal year.
- For the free pay-per-view movies membership, we assume that the credits are redeemed from within the system. For example, perhaps a calculation rule calculation algorithm or pre-processing calculation rule redeems the free pay-per-view movies over time as customers are billed for the movies. As a result, the membership should have a balance. In this example, no SA is required because an assumption is being made that any affect on the GL is posted at the time the free movies are redeemed (i.e., when calculating a bill). (This is just an example. It's possible that you may want to post to the GL when free movies are accumulated to mark a payable for the company.) Finally, free pay-per-view movies do not need to indicate a fiscal year.

More options must be considered for each membership type.

Consider Whether the Membership Should Indicate Subcategories

For some types of memberships, the amount of each service credit event is further grouped by a subcategory. Refer to [Events May Indicate a Subcategory](#) for more information.

Use subcategories if multiple subtypes of credits may be accumulated and redeemed and if balances need to be tracked for each subcategory.

For our sample membership types, only the capital credits type should indicate subcategories.

Membership Type	Description	Subcategories
STDCAPCR	Standard capital credit membership	Distribution Transportation
FFDELTA	Delta frequent flier miles	
FREEPPV	Free pay-per-view movies	

Determine the Types of Service Agreements Linked to the Membership

Memberships typically exist to reward customers for participating in standard service with the company. Refer to [How Are Service Credits Earned?](#) for more information. If memberships of this type are related to standard service for your company, determine the SA types for these service agreements.

NOTE:

Standard Service SA Types. These service agreement types are probably different from the type of service agreement you may link as the membership SA. The membership SA is used for miscellaneous charges like general ledger posting. These SA types are related to electricity service, gas service, etc.

For our three examples, assume that the company provides electric service and cable. The capital credits are related only to electric service, frequent flier miles are accumulated for a combination of services, and free pay-per-view movies are related only to cable service.

Membership Type	Description	SA Types
STDCAPCR	Standard capital credit membership	E-RES (Electric Residential) AL-RES (Area Lighting)
FFDELTA	Delta frequent flier miles	E-RES (Electric Residential) AL-RES (Area Lighting) CABLE -RES (Cable Residential)
FREEPPV	Free pay-per-view movies	CABLE-RES (Cable Residential)

Consider Special Functionality Needed When Adding, Activating or Inactivating a Membership

Should a letter or bill message be generated when a membership is created or activated? Should anything happen when a membership is inactivated? If so, you may need to define one or more algorithms to be plugged in on the membership type.

For our examples, let's say that a bill message is generated when a frequent flier or free pay-per-view membership is created. Let's say that a letter is generated when a capital credits membership is activated. We also assume that when a capital credits membership becomes inactive, any outstanding balance is redeemed. For the frequent flier miles and pay-per-view memberships, we assume nothing special occurs when the membership becomes inactive.

FASTPATH:

Refer to [Lifecycle of a Membership](#) for more information about the various status values for a membership.

Membership Type	Description	Algorithm System Event	Algorithm
STDCAPCR	Standard capital credit membership	Membership Activation	Send Letter
		Membership Inactivation	Redeem Balances
FFDELTA	Delta frequent flier miles	Membership Creation	Generate Bill Message
FREEPPV	Free pay-per-view movies	Membership Creation	Generate Bill Message

NOTE:

Sample Algorithms. The base package does not provide sample algorithms for all the above examples. Refer to [Service Credit Membership Type - Algorithm](#) for more information about the algorithms provided with the system.

Determine Whether The Membership Requires Additional Information

Is there any information about your membership that you need to capture that is not already provided by the base system logic? If the answer is yes, you may need to define characteristics for your membership. Use the [characteristic collection](#) on the membership type to define the types of characteristics allowed for memberships of this type. You may also define default values for you membership's characteristics.

Designing Your Service Credit Event Types

Now that you have designed your membership types, you need to design the types of service credit events that may be created for your membership.

In many cases, a credit event should cause additional functionality to occur. Algorithms are executed when an event is completed and when an event is canceled and are used to perform additional functionality. The following points illustrate possible algorithms that may be needed when a credit event is completed.

- Validate the event as compared to other events. For example, perhaps a new event should never cause the overall membership balance to fall below zero. You could use an algorithm on the service credit event type to check this condition.
- Create an adjustment that posts to the general ledger. Your credit event may not affect the customer's balance when created, but perhaps it should have an effect on the general ledger. For these types of credit events, you may need to create an adjustment to post to the GL.
- Create adjustments to affect the customer's balance. When "redeeming" a credit, you may need to transfer a monetary amount to one or more of the customer's service agreements.
- Create a bill message. Perhaps when a credit is accumulated, you want to inform the customer via a message on the bill indicating the credit amount. A temporary bill message is added to one of the membership's accounts.

NOTE:

One Account Message of the Same Message Type. The temporary bill message collection on the account allows only one bill message of the same bill message type. If it's possible for multiple types of events to be generated for the same account, consider creating a different bill message type for each event type.

- Stamp a batch code and batch run number onto the event. This would be used when your event information needs to be interfaced to an external system.

The following points illustrate possible algorithms that may be needed when a credit event is canceled.

- Validate the event as compared to other events. For example, perhaps canceling an event should never cause the overall membership balance to fall below zero.
- Cancel adjustments that may have been created when the event was completed.

To illustrate examples of when to use some of the algorithms above, we'll design event types for the membership types designed above.

Designing Capital Credit Event Types

The following event types illustrate typical events for a capital credits membership.

SC Event Type	Description	Membership Type	Algorithm System Event	Algorithm
ALLOCATECCR	Capital credit allocation	STDCAPCR	Event Creation	Create Simple Adjustment
			Event Creation	Generate Bill Message
			Event Cancellation	Validate Balance Not < Zero
			Event Cancellation	Cancel Related Adjustments
RETIRECCR	Retire capital credit (apply to customer's balance)	STDCAPCR	Event Creation	Validate Balance Not < Zero
			Event Creation	Create Adjustments to Affect Customer's Balance
			Event Cancellation	Cancel Related Adjustments

FORFEITCCR	Forfeit capital credit (retirement not applied to customer's balance)	STDCAPCR	Event Creation	Validate Balance Not < Zero
			Event Creation	Create Simple Adjustment (affect GL only)
			Event Cancellation	Validate Balance Not < Zero
			Event Cancellation	Cancel Related Adjustments

These event types assume the following:

- When credit events are allocated, the customer is notified via a bill message, the general ledger is affected so a simple GL only adjustment is created. If an event of this type is canceled, any adjustments that were created should be canceled. The event amount should always be positive, so checking that the membership balance does not fall below zero is only checked for event cancellation.
- When capital credits are retired, it's possible that the full membership balance is not applied to the customer's balance. For the portion of the retirement that does affect the customer's balance, you need an algorithm that applies the credits to the customer's service agreements via adjustments. Cancellation of this event should cause any related adjustments to be canceled. It's assumed that the amount of this event is a credit so checking that the membership balance does not fall below zero is only checked for event completion.
- For the portion of the retirement that is not applied to the customer's balance, the event amount should simply affect the GL so a GL only adjustment is created. Cancellation of this event should cause any related adjustments to be canceled. It's assumed that the amount of this event is a credit so checking that the membership balance does not fall below zero is only checked for event completion.

NOTE:

Service credit event types are independent of subcategories. A capital credits membership typically uses subcategories. When events are created for different subcategories, the same service credit event type may be used. As a result, all subcategories use the same event completion and event cancellation algorithms.

Designing Frequent Flier Event Types

The following event types illustrate typical events for a frequent flier membership:

SC Event Type	Description	Membership Type	Algorithm System Event	Algorithm
ADDMILES	Add miles to the membership	FFDELTA	Event Creation	Generate Bill Message
			Event Creation	Populate Batch Information
			Event Cancellation	Event may not be canceled.

This event type assume the following:

- A new event should generate a bill message.
- Information about the event amount should be interfaced to an external system so batch information should be populated when the event is completed.
- Events of this type may not be canceled because the information is interfaced to an external system. Rather, to reverse an event, simply create a new event whose amount is a credit. This credit amount is also interfaced to an external system.

NOTE:

Sample Algorithm. The system does not provide a sample cancellation algorithm that prevents the event from being canceled.

- There is no validation to ensure that the balance does not fall below zero. Recall that this membership was defined as not requiring a balance.

Notice that only one type of event has been defined for this membership. That is because the credits for this membership are not redeemed via this system. Rather they are accumulated on behalf of an external system.

Designing Pay-per-view Event Types

The following event types illustrate typical events for a free pay-per-view movies membership:

SC Event Type	Description	Membership Type	Algorithm System Event	Algorithm
ADDPV	Free pay-per-view movies	FREEPPV	Event Creation	Generate Bill Message
			Event Cancellation	Validate Balance Not < Zero
REDEEMPPV	Redeem pay-per-view movies	FREEPPV	Event Creation	Validate Balance Not < Zero
			Event Creation	Generate Bill Message

These event types assume the following:

- Any type of new event should generate a bill message.
- For adding free movies, it is assumed that the quantity is positive so when the event is cancelled, the algorithm verifies that the balance does not become negative.
- For redeeming free movies, it is assumed that the quantity is negative so when the event is completed, the algorithm verifies that the balance does not become negative.
- These events do not affect the general ledger and they do not directly affect the customer's balance so no adjustment algorithm is needed.

How Are Service Credit Events Created?

Now that you have designed the behavior of your service credit events, an important issue is to determine how these events are created. Consider your business practice for each type of membership.

Let's use our sample memberships to work through different ways that you may create service credits.

Service Credits for Capital Credit Memberships

For a capital credit membership, capital credit allocations are calculated once a year based on billing history and the cost of service. To accomplish this, a background process calculates the amount and creates the service credits. Refer to [allocating capital credits](#) for a sample process provided with the base package.

Credits are redeemed via the retirement process. The company determines when to retire capital credits based on analysis of their financial situation. This retirement process is also handled by a background process. Refer to [capital credit retirement](#) for a process provided with the base package.

For capital credits memberships, special functionality is required when a member dies. The capital credits are considered part of the person's estate and may need to be retired and applied to a beneficiary's account. This process depends on the company's business practice. However, typically, the membership status would change to inactive so that new capital credit allocations are not created for the membership. The system provides a sample inactivation algorithm called SCMI-RB that transfers part or all of the outstanding credit balance to the member's service agreements. From there, a user can cut a check to the beneficiary.

NOTE:

Some Credits Are Never Retired. For many cooperatives, some types of allocated credits are never retired. Refer to [Partial Retirement](#) for more information.

Service Credits for Frequent Flier Memberships

In our example, frequent flier miles were related to both the electricity and phone service. Let's assume that frequent flier miles are accumulated every \$x spent on electricity and phone service. In this example, a bill completion algorithm creates service credits based on the bill segment amounts for these service agreements. Refer to [Service Credits Earned Through Billing](#) for more information.

As mentioned before, the frequent flier miles are not redeemed using this system, but are interfaced to a third party for redemption.

Service Credits for Free Movies Memberships

NOTE:

Sample Algorithms. No base package algorithm types are provided to support the logic described in this example.

In this scenario, let's suppose that a customer receives three free pay-per-view movies when signing up for new service. To handle this, perhaps an SA creation algorithm creates the membership and the service credits when the service is started. Or perhaps you want to wait until the first bill is generated and a bill completion algorithm is used to generate the first credit. It depends on your business practice.

For redeeming the free pay-per-view movies, it is assumed that the movies are credited during billing after it is determined that the customer has been billed for a movie. The number of movies used for the membership is reduced until all the free movies are used.

FASTPATH:

Refer to [Service Credits Redeemed Through Billing](#) for more information.

Setting Up Service Credit Options

Setting Up Credit Units

Credit unit is used for service credit membership types whose [events](#) record non-monetary units. Open **Admin > Service Credit > Credit Unit** to set up credit units.

Description of Page

The following fields display for each credit unit:

Credit Unit The unique identifier of the credit unit.

Description The description of the unit. This also acts as a label for the unit when displaying information about a service credit event.

Symbol / Label Position Indicates whether or not the label for this credit unit appears as a Prefix or as a Suffix to the service credit event amount.

Decimal Positions Indicates the number of decimal positions used for this credit unit. This information should be used by any algorithm or background process that creates a service credit event to determine how to store the event amount. It is also used to correctly display the service credit amounts.

Setting Up SC Membership Inactive Reasons

The service credit membership inactive reason must be specified when the status of a service credit membership changes to inactive. Open **Admin > Service Credit > Service Credit Membership Inactive Reason** to set up service credit inactive reasons.

Description of Page

The following fields display for each inactive reason:

Inactive Reason The unique identifier of the service credit membership inactive reason.

Description The description of the inactive reason.

Setting Up Service Credit Membership Types

SC Membership Type - Main

Service credit memberships have a membership type. Open **Admin > Service Credit > Service Credit Membership Type > Add** to define the membership type.

Description of Page

Enter a unique **Service Credit Membership Type** and **Description** for each membership type.

Use the **SA Requirement** flag to indicate whether a [miscellaneous SA](#) must be linked to memberships of this type. The possible values are SA Required and SA Not Allowed .

NOTE:

The value defaults to SA Required.

Use the **Fiscal Year Requirement** flag to indicate whether events linked to memberships of this type should indicate a [fiscal year](#). The possible values are Fiscal Year Required and Fiscal Year Not Allowed.

NOTE:

Default Note. The value defaults to Fiscal Year Not Allowed.

Use the **SCM Event Balance** flag to indicate whether or not a [balance of service credit events](#) linked to memberships of this type should be calculated and displayed. The possible values are Has a Balance and No Balance.

NOTE:

Default Note. The value defaults to Has a Balance.

Use the **SC Membership Type Unit** flag to indicate whether or not the unit for the event amounts for events linked to memberships of this type is Currency or Credit Unit. When the unit is currency, indicate the **Currency Code**. When the unit is credit unit, indicate the **Credit Unit**.

If events linked to memberships of this type must indicate a subcategory, enter a valid **Subcategory Name** and **Description** for each subcategory applicable to this membership.

FASTPATH:

Refer to [Events May Indicate a Subcategory](#) for more information.

Use the **SA Types** grid to indicate the types of [service agreements that contribute to memberships](#) of this type. Indicate the **CIS Division** and **SA Type** for each type of service agreement that is related to a membership of this type.

SC Membership Type - Algorithm

Open **Admin > Service Credit > Service Credit Membership Type > Search** and navigate to the **Algorithm** page to define any algorithms that are associated with a membership type.

Description of Page

The grid contains **Algorithms** that control important functions in the system. You must define the following for each algorithm:

- Specify the **System Event** with which the algorithm is associated (descriptions of all possible events are provided below).
- Specify the **Sequence** and **Algorithm** for each system event. You can set the **Sequence** to 10 unless you have a **System Event** that has multiple **Algorithms**. In this case, you need to tell the system the **Sequence** in which they should execute.

The following table describes each **System Event** for which you can define algorithms.

System Event	Optional / Required	Description
Membership Creation	Optional	Use this system event for algorithms that are executed when a membership is created.
Membership Activation	Optional	Use this system event for algorithms that are executed when a membership becomes active.

NOTE:**Creating Memberships In Active**

Status. A membership may be created in either pending status or in active status, based on your business practice. For memberships created in active status, the system executes the membership creation algorithms and the membership activation algorithms.

SC Membership Type - Characteristics

To define characteristics that can be defined for service credit memberships of a given type, open **Admin > Service Credit > Service Credit Membership Type > Search** and navigate to the **Characteristics** page.

Description of Page

Use the characteristics collection to define characteristics that can be defined for service credit memberships of a given type. Use **Sequence** to control the order in which characteristics are defaulted. Turn on the **Required** switch if the **Characteristic Type** must be defined on service credit memberships of a given type. Turn on the **Default** switch to default the **Characteristic Type** when service credit memberships of the given type are created. Enter a **Characteristic Value** to use as the default for a given **Characteristic Type** when the **Default** switch is turned on.

Setting Up Service Credit Event Types

Service credit events created for a service credit membership have an event type. Open **Admin > Service Credit Event Type > Add** to set up service credit event types.

Description of Page

Enter a unique **Service Credit Event Type** and **Description** for each event type.

Indicate the **Service Credit Membership Type** to which this event type belongs.

The grid contains **Algorithms** that control important functions in the system. You must define the following for each algorithm:

- Specify the **System Event** with which the algorithm is associated (descriptions of all possible events are provided below).
- Specify the **Sequence** and **Algorithm** for each system event. You can set the **Sequence** to 10 unless you have a **System Event** that has multiple **Algorithms**. In this case, you need to tell the system the **Sequence** in which they should execute.

The following table describes each **System Event** for which you can define algorithms.

System Event	Optional / Required	Description
Event Completion	Optional	Use a system event of Event Completion for algorithms that are executed when an event is completed. Refer to An Event May Cause Other Actions to Occur for more information.
Event Cancellation	Optional	Use this system event for algorithms that are executed when an event is canceled.

Service Credit Examples

In this section, we provide examples of how to define your control tables to support functionality related to different types of service credit memberships. While your company may not define your environment exactly the same way, this section should help solidify your understanding of how to set up your company's service credit options.

Defining Control Tables for a Refundable Fee

If your membership requires payment of a [fee](#) that is refundable, you must define an SA type to use for the refundable fee.

Adjustment Type for Refundable Fee

This example assumes that the fee is set up similarly to a deposit. The adjustment used to charge the fee would affect the current balance, but not the payoff balance or the general ledger because the fee is not considered a "receivable", rather it is an amount collected and held for the customer.

Create an [adjustment type](#) for levying the fee. Indicate the fee amount and indicate the ADJT-CA adjustment FT creation algorithm, which affects the current balance, but not the payoff balance or the general ledger.

NOTE:

Adjustment Type Profiles. Be sure to add this adjustment type to an appropriate adjustment type profile and ensure this profile is linked to your SA type.

SA Type for Refundable Fee

Create an SA type to use for the fee. This SA type should be marked as not billable.

Indicate the appropriate adjustment type profile that includes the adjustment type to levy the fee.

Indicate an appropriate payment segment type that references the PSEG-NM payment segment FT algorithm. This algorithm affects the payoff amount and current amount by the payment amount, which should cause the current amount to become zero and the payoff amount to become a credit for the fee amount when the fee is paid.

Start Option for Refundable Fee

For this SA type, define a start option that causes an adjustment to be levied as part of the start service process.

FASTPATH:

Refer to [Including The Membership Fee](#) on campaigns and packages for more information about levying the fee via the order transaction.

Algorithm for Refunding the Fee

The base product provides an algorithm type SAST-RF that refunds a fee when [service agreements that contribute to the membership](#) are stopped. You must create an algorithm for this algorithm type and enter the SA type created above as an input parameter.

This SA stop algorithm must be plugged in on all SA types that you defined for the [membership type](#).

Defining Control Tables for a Nonrefundable Fee

If your membership requires payment of a [fee](#) that is not refundable, you can set this up in two ways:

- You can create a special SA type to handle charging the fee. For this SA type, define a start option that causes an adjustment to be levied as part of the start service process. This adjustment contains your fee. You may use this option if the membership is related to multiple types of services and not all services need to be present in order to create the membership.
- You can levy an adjustment on one of the other service agreements that is being started. To do this, you would use a start option to define an adjustment to be levied as part of the start service process. You may use this option if the membership is related to a single service (for example, free pay-per-view movies).

For our example, we will set up the SA for the nonrefundable fee with a separate 'fee' SA type.

Adjustment Type for Nonrefundable Fee

Create an [adjustment type](#) for levying the fee. Indicate the fee amount and indicate the ADJT-NM adjustment FT creation algorithm, which affects the current balance and payoff balance by the adjustment amount, and affects the general ledger.

NOTE:

Adjustment Type Profiles. Be sure to add this adjustment type to an appropriate adjustment type profile and ensure this profile is linked to your SA type.

SA Type for Nonrefundable Fee

Create an SA type to use for the fee. This SA type should be marked as not billable.

Indicate the appropriate adjustment type profile that includes the adjustment type to levy the fee.

Indicate an appropriate payment segment type that references the PSEG-NM payment segment FT algorithm. This algorithm affects the payoff amount and current amount by the payment amount, which causes the current amount to become zero and the payoff amount to become a credit for the fee amount when the fee is paid.

Start Option for Nonrefundable Fee

For this SA type, define a start option that causes an adjustment to be levied as part of the start service process.

FASTPATH:

Refer to [Including The Membership Fee](#) on campaigns and packages for more information about levying the fee via the order transaction.

Defining an SA Type for Miscellaneous Transactions

Does your membership require a [service agreement](#) to support miscellaneous transactions? If so, you need to consider the SA type to use for this service agreement. This SA type should be marked as not billable.

If you choose to use the order transaction to set up the membership, this SA type must be defined on the [algorithm that creates the membership](#).

It is possible that you may require a start option for this SA type, for example if you want to define a characteristic for service agreements of this type.

Using Campaigns/Packages to Set Up Membership

If enrollment in a membership is a common occurrence for your customers when starting service, you should consider using the [order](#) page to start service for the customer and to create the membership as well.

NOTE:

This section only makes sense if you are familiar with the [Sales and Marketing](#) chapter.

The recommendation is to use a question/miscellaneous field to ask the customer service representative to indicate the appropriate membership type. Algorithms validate this membership type and use it to create a membership of that type.

This section walks you through how to set up the campaign / package required to support this.

Column Reference for Membership Type

In order to ask the customer service representative to define an appropriate service credit membership type, you must define a column reference for the membership type.

Add a new column reference with the following information:

- Column Reference: SCM-TYPE
- Description: SC Membership Type
- FK Reference: SCM TYPE
- Long Description: Service Credit membership type to use when creating a service credit membership at start time.

NOTE:

Column Reference Algorithms. This column reference indicates a validation algorithm and a posting algorithm. However, we have not defined them yet so for now simply save this information.

Algorithms to Create Membership via Order

The base product provides two algorithm types to support the creation of a membership record via the order page: a validation algorithm type and a posting algorithm type.

Validate Membership Information

This algorithm is a column reference validation algorithm that checks that an input membership type is valid. Refer to CRVL-ME for more information. You must define an appropriate algorithm for this algorithm type, and on that algorithm you must define the column reference used to identify the membership type. For example:

- Algorithm: VAL MEM TYPE
- Description: Validate SC Membership Type
- Algorithm Type: CRVL-ME
- Parameter1: (Column Reference for Membership Type): SCM-TYPE

Post Membership Information

This algorithm is a column reference posting algorithm that creates a membership using the membership type indicated by the user. Refer to CRPS-ME for more information. You must define an appropriate algorithm for this algorithm type, and on that algorithm you must define the column reference used to identify the membership type. For example:

- Algorithm: CREATE MEMBRSH
- Description: Validate SC Membership Type
- Algorithm Type: CRPS-ME
- Parameter1: (Column Reference for Membership Type): SCM-TYPE
- Parameter2: (Service Credit Membership Status): 10 -Pending or 20 -Active. Refer to [Lifecycle of a Membership](#) for more information.
- Parameters3-5: (Division, SA Type, Start Option): Indicate the information needed to create an SA for miscellaneous transactions.

NOTE:

This algorithm first looks for an existing service agreement of this division / SA type linked to the membership's accounts. If one exists, it uses that SA to link to the membership. If an SA does not exist, it creates one with the input division, SA and (optional) start option.

Update the Column Reference. Now that you have defined the validation and posting algorithms, return to your [column reference for membership type](#) and define the algorithms there.

Although your company may support multiple types of memberships, this column reference and its algorithms have been designed such that only one column reference for membership type would be needed to set up any type of membership. Although the posting algorithm for the membership type column reference indicates an SA type to use for miscellaneous transactions, a service agreement is only created and linked if your membership type indicates that an SA is required. As a result, you may use the same column reference for both memberships that require an SA and those that don't require an SA. However, if you have different membership types that require an SA and each uses a different SA type or a different start option for the membership SA, you need to define more than one posting algorithm and, as a result, more than one column reference.

Define a Campaign for Creating a Membership When Starting Service

Many factors must be considered when [designing your campaigns and packages](#). The possible creation of a membership when using the order page is simply another factor to consider.

If you plan to define a question/miscellaneous field to capture a service credit membership type, the available packages linked to the campaign should be ones that are related to memberships. For example, if your membership is related to electric service, it doesn't make sense to create a membership for a campaign designed to generate a one-time charge.

When defining a question/miscellaneous field, you must indicate its applicability. Consider whether a membership type is required, optional or only applicable for certain packages. This helps ensure that your users capture this information when appropriate.

Including the Membership Fee

You must determine the best way to setup your campaign/package to handle the levying of your membership fee, if applicable. Consider some of the following questions.

- If the membership has a fee, is it a refundable fee or a non-refundable fee?

- Is the fee always applicable for the membership? Or is it waived under certain conditions? For example, maybe the fee is applicable if a customer signs up for a single service, but the fee is waived if the customer signs up for two or more services.

The SCM type column reference and question/miscellaneous field are set up to ask the user what type of membership to create. Because the applicability of the fee may differ for each membership type, you should carefully consider the campaign / package setup to levy the fee correctly.

- If a fee is always applicable for a membership, you may consider creating a membership creation algorithm that creates a fee SA with a start option to levy the fee when the membership is created.

NOTE:

Sample Algorithm. The base product does not provide a membership creation algorithm to do this.

- If the fee is not always applicable for a membership, you must determine when the fee is applicable. The recommendation is to include the fee SA type in the SAs-to-create collection for the appropriate package. For example,
 - If the fee is applicable when the customer signs up for a single service, you should define a package for each single service that includes one SA to create for the single service and the fee SA as another SA to create.
 - If the fee is waived when the customer signs up for two or more services, you should define a package for each combination of the multiple services. These packages do not include the fee SA in the SAs to create.
- If the customer signing up for service is a former customer who has returned, perhaps the fee was paid earlier when the customer originally had service. In this case, maybe your business practice is to waive the fee at this time. To do this, you should set up a question/miscellaneous field for the user to mark that this is a returning customer. Based on the answer to this question, perhaps only packages that do not levy any fee are eligible for selection.

Defining Another Person for Your Account

It is common for a capital credit membership to define more than one person for the account being turned on and linked to a membership. A typical example is a married couple. Both spouses are indicated on the account and financially responsible persons and as a result, both are considered [members](#).

Column reference algorithms have been provided by the base product to enable linking a second person to your account via the [order](#) page.

This section walks you through how to set up the column reference and campaign to support this.

NOTE:

Linking A Second Person to the Account. This logic is not restricted to service credit functionality. Any campaign may be designed to include the ability to link a second person to the account being started.

Column References for Additional Person

In order to ask the customer service representative to link an additional person for the account, you must define several column references to use as questions/miscellaneous fields.

- We should assume that the person may already exist in the database. As a result, a question to record the person ID is needed.
- If the person does not already exist, the user should capture the person's name, an ID type and an ID number. Questions for these three fields are needed. The system uses this information to create a new person.

- Whether we are using an existing person or creating a new one, the person's link to the account must include an account relationship type. A question to record the account relationship type is needed.

Add a new column reference for person ID:

- Column Reference: PERSON-ID
- Description: Person ID
- FK Reference: PER
- Long Description: Person ID of the additional person to link to the order's account.

Add a new column reference for person name:

- Column Reference: PERSON-NAME
- Description: Person Name
- FK Reference: not applicable
- Long Description: Name of a new person to create.

Add a new column reference for identifier type:

- Column Reference: PER-ID-TYPE
- Description: Person Identifier Type
- FK Reference: ID TYPE
- Long Description: Person Identifier type for the primary ID of the additional person to link to the order's account.

Add a new column reference for identifier number:

- Column Reference: PER-ID-NUM
- Description: Person ID Number
- FK Reference: not applicable
- Long Description: Identifier number for the primary ID of the additional person to link to the order's account.

Add a new column reference for account relationship type:

- Column Reference: ACCT-REL-TYPE
- Description: Account Relationship Type
- FK Reference: ACCT REL
- Long Description: Relationship type to use for the link between the additional person and the order's account.

NOTE:

Column Reference Algorithms. One of the column references above must indicate a validation algorithm and a posting algorithm. However, we have not defined them yet so for now simply save this information. We recommend using the account relationship type record because that is used for all additional persons.

Algorithms to Link Additional Person via Order

The base product has provided two algorithm types to support the linking of an additional person to the account via the order page: a validation algorithm type and a posting algorithm type.

Validate Addition Person Information

This algorithm is a column reference validation algorithm which checks that either a person id or person name, a valid ID type and ID number are provided and that a valid account relationship type is provided. Refer to CRVL-PE for more

information. You must define an appropriate algorithm for this algorithm type and on that algorithm you must define the column reference used for the five fields required for this validation. For example:

- Algorithm: VAL ADD PER
- Description: Validate Additional Person Info
- Algorithm Type: CRVL-PE
- Parameter1: (Column Reference for Person ID): PERSON-ID
- Parameter2: (Column Reference for Person Name): PERSON-NAME
- Parameter3: (Column Reference for Person ID Type): PER-ID-TYPE
- Parameter4: (Column Reference for Person ID Number): PER-ID-NUM
- Parameter5: (Column Reference for Account Relationship Type): ACCT-REL-TYPE

Post Addition Person

This algorithm is a column reference posting algorithm that may link an existing person to the order's account or create a new person and link that person to the order's account. Refer to CRPS-PE for more information. You must define an appropriate algorithm for this algorithm type, and on that algorithm you must define the column reference used for the five fields required for this logic. For example:

- Algorithm: LINK ADDNTL PER
- Description: Link additional person to order's account
- Algorithm Type: CRPS-PE
- Parameter1: (Column Reference for Person ID): PERSON-ID
- Parameter2: (Column Reference for Person Name): PERSON-NAME
- Parameter3: (Column Reference for Person ID Type): PER-ID-TYPE
- Parameter4: (Column Reference for Person ID Number): PER-ID-NUM
- Parameter5: (Column Reference for Account Relationship Type): ACCT-REL-TYPE

NOTE:

Update the Column Reference. Now that you have defined the validation and posting algorithms, return to your [column reference for account relationship type](#) and define the algorithms there.

Design a Campaign to Include Linking an Additional Person

Any campaign related to a specific account may include the questions and miscellaneous fields defined here to create/link an additional person to the account.

Simply create entries in the questions and miscellaneous fields collection to prompt the user to ask for the required information. A question should exist for each column reference created above. The following table illustrates a possible setup.

Seq	Description	Prompt on Order	Column Reference	Dependency
10	Account relationship type for additional person.	If you would like to link another person to this account, please enter an account relationship type.	ACCT-REL-TYPE	Must have account
20	Person ID for additional person	If the additional person already exists in the	PERSON-ID	Must have account

		database, enter the person id.		
30	Person name for additional person	If you would like to create a new person, please enter the person name.	PERSON-NAME	Must have account
40	ID type for additional person	Please enter the ID type of the new person.	PER-ID-TYPE	Must have account
50	ID Number for additional person	Please enter the ID number of the additional person.	PER-ID-NUM	Must have account

Service Credits Earned When Starting Service

For some memberships, you may want to add service credits when starting the program. For example, the customer gets three free pay-per-view movies when signing on for cable service. Or a customer receives 500 frequent flier miles for signing up for a combination of gas and electric service.

There are various ways that you can accomplish this. You should work with your implementers to consider the various options to determine the method that best suits your business practice.

- You could use an SA activation algorithm to create a membership and an event for the initial points. Use this method if the points are related to a single type of service agreement and the points are earned automatically when starting service (i.e., without any human decision to be made).
- You could use a membership creation or membership activation algorithm to generate a service credit event automatically. This method assumes that the decision to create the membership has been made and that the free initial points are always earned for this type of membership (i.e., regardless of the type of service created).
- You could use questions and miscellaneous fields for a campaign/package to determine a customer's eligibility for participation in the membership and for the initial free points. A column reference posting algorithm could create the membership and/or the service credit event for the free points based on the answers to the questions.
- Perhaps the initial free points are only earned after the first bill is generated. Use a bill completion algorithm to generate the initial points.

You may think of other plug-in spots that could be used to generate free initial points based on your business needs.

Service Credits Earned Through Billing

For some memberships, you may accumulate points as a result of billed amounts for other services. For example, perhaps your customers earn one frequent flier mile for every \$10 spent on the combined electricity, gas and water bills each month.

To accomplish this, you must design an algorithm to be executed at billing time. There are various plug-in spots executed at billing time that you may use, but the recommended plug-in is a post completion algorithm on the customer class. This plug-in is executed after all bill segments are frozen and most of the completion logic has occurred.

Your algorithm should determine the [service agreements that contribute to the membership](#) and calculate the service credit amount for those service agreements bill segments.

This algorithm should also consider what to do when bill segments that contributed to the event are canceled. The algorithm provide with the base product CBCM-SC checks to see if any canceled bill segments are referenced on any previous events. If so, it includes the canceled amount on the new event. This may cause the new event to be a negative amount.

The assumption is that over time, earned credits will compensate for the negative event amount. For a membership that [interfaces information to a third party](#), it is assumed that the negative event amount is also interfaced.

Service Credits Redeemed Through Billing

For some memberships, your customer may redeem their earned points by receiving a discount on their bill. For example, if your cable customer has earned one free pay-per-view movie, you can give them a credit the next time they get billed for a pay-per-view movie.

The base product has not provided any algorithms to credit a bill based on earned service credits. This section will identify considerations your implementers should follow when designing algorithms to redeem service credits through billing.

The recommendation is to credit the customer's bill by generating an adjustment using a pre-bill completion algorithm. This algorithm's responsibilities are as follows:

- Determine if the appropriate bill segment(s) contain the charges that need to be credited. For example, if the service credit is for a free pay-per-view movie, determine if the customer has been billed for a pay-per-view movie.
- Determine if the customer's current service credit balance for this program. For example, how many free pay-per-view movie credits are left?
- Create an adjustment to credit the appropriate service agreement by the eligible credit amount.
- Update the service credit membership balance by creating a new SC event with a credit for the number of points redeemed. Link the adjustment to the event as a contributed to FT.
- Consider cancel/rebill situations. If a cancel/rebill has occurred, determine if there is a change to the redeemed credits. For example, if the original bill had one pay-per-view movie that was credited and the new bill also has one pay-per-view movie, no change is needed to the service credit balance. If the original bill had more pay-per-view movies than the new bill, perhaps one or more redeemed service credit points should be reinstated. If the original bill had fewer pay-per-view movies than the new bill, perhaps more points should be redeemed.

You may wonder why we don't recommend crediting the customer's bill while generating the bill segment. For example, use pre-processing calculation rule to determine if any points should be redeemed and use a calculation rule to generate a bill calculation line with the credit amount.

The reason for this is that cancel/rebill logic is not straightforward. Algorithms executed during rate application should NOT perform any updates, such as updating the service credit membership balance. The balance should be updated using a bill segment freeze algorithm or a bill completion algorithm.

When a cancellation occurs, the service credit balance should be updated to reinstate the redeemed points. Again, this should occur when the cancellation is frozen or at bill completion time. If you perform a cancel/rebill, the calculation of the rebill segment does not have the up-to-date information about the service credit balance because the reinstatement of the points by the canceled segment has not occurred yet.

Designing Your Rate Options for Capital Credits

The capital credit allocation background process relies on certain data configuration in order to function correctly. This section identifies the required data setup.

FASTPATH:

Refer to [Allocating Capital Credits](#) for more information.

Identifying SQ and Sales Information for Historical Bill Segments

To allocate capital credits, the background process retrieves billing history for each SA that contributes to the membership for the given fiscal year. The process needs to calculate the service quantity (SQ) amount billed and the sales amount billed for the SA in that year.

NOTE:

Sales Amount. The sales amount refers to the monetary amount billed. For a capital credit allocation, this amount would generally exclude taxes and may exclude other line item amounts from the bill.

In order to calculate the amounts correctly, the background process must determine which bill calculation lines for each bill segment contain the SQ and/or sales information. Characteristics on the bill calculation lines identify which bill lines should be used.

The rest of this section uses examples to illustrate how you may configure your rate options to support this.

Define Characteristics for SQ and Sales

Char Type for identifying bill lines that hold **SQ information**

- Char Type: CCA-SQ
- Description: Capital credit allocation usage
- Type of Char: Pre-defined
- Values: Y
- Char Entities: Calculation Rule, Bill Calculation Line

Char Type for identifying bill lines that hold **sales information**

- Char Type: CCA-SALES
- Description: Capital credit allocation sales
- Type of Char: Pre-defined
- Values: Y
- Char Entities: Calculation Rule, Bill Calculation Line

Define Calculation Rules

Identify each rate schedule that may be linked to a service agreement that contributes to a capital credit membership.

For each of these rate schedules, identify the calculation rules whose resulting bill calculation line will contain a billable service quantity that should be included in the SQ calculation for allocating capital credits. For each calculation rule that qualifies, define the CCA-SQ char type (defined above) and a char value of Y.

For each rate schedule, identify the calculation rules whose resulting bill calculation line amount should be included in the sales calculation for allocating capital credits. For each calculation rule that qualifies, define the CCA-SALES char type (defined above) and a char value of Y.

NOTE:

Characteristic Information. The system automatically copies characteristic info from a calculation rule to its resulting bill calculation line if the char type entities include both calculation rule and bill calc line.

Define Batch Control Parameters

The background process to allocate capital credits [CPCRALOC](#) receives the char type and char value to identify the bill calculation lines that contain the SQ and sales amounts. Once you have your characteristics defined, update your batch control to include these values as default parameter values.

Designing Bill Factors for Credit Allocation

The [capital credit allocation](#) process uses an allocation factor in its calculation. A typical capital credit membership may define multiple subcategories, meaning that allocation amounts are calculated each year for the multiple subcategories. The calculation is the same for each subcategory, but the allocation factor differs.

The process has been designed to calculate the allocation for a single subcategory. If your organization requires allocations calculated for multiple subcategories, the process must be run for each subcategory. The allocation process receives a bill factor as an input parameter. As a result, a different bill factor should be set up to define the allocation factor for each subcategory.

For each subcategory, the allocation factor may differ further for the type of customer. For example, the allocation for a commercial customer may differ from the allocation factor for a residential customer. The allocation background process expects the bill factor for each subcategory to define a characteristic type of revenue class. The process determines each service agreement's revenue class by looking at the value defined on its SA type.

Following is an example of bill factors set up for a capital credit membership with two subcategories: transportation and generation.

Characteristic Type for Allocation Bill Factor

Char Type: REV-CLASS

Description: Revenue Class

Type of Char: Pre-defined

Values: (define all the valid revenue class values)

Char Entity: Bill Factor

Bill Factor for Transportation

Bill Factor Id: CCAF-TRANS

Description: Transportation Allocation Factor

Char Type: REV-CLASS

Char Source: Characteristic Collection

Char Values: (for each year, the new transportation allocation factor for each revenue class must be defined)

Bill Factor for Generation

Bill Factor Id: CCAF-GEN

Description: Generation Allocation Factor

Char Type: REV-CLASS

Char Source: Characteristic Collection

Char Values: (for each year, the new generation allocation factor for each revenue class must be defined)

NOTE:

The characteristic source is characteristic collection. It is the responsibility of the background process to determine the SA's revenue class and to pass this value into the bill factor routines to retrieve the correct bill factor value.

Estimating Allocation Factors. Often the company needs to estimate the allocation factors for the new fiscal year and may adjust the values several times until the calculated allocation amounts are satisfactory. Refer to [Allocating Capital Credit](#) for more information.

Partial Retirement

In the cooperative business, it is common to never retire certain capital credit allocation amounts. The amounts that do not retire should be assigned their own subcategory.

When executing the retirement background process, the subcategory to retire may be input to the process. If you have certain subcategories that you do not retire, you would simply run the background process for the subcategories that do retire.

Cooperatives typically retire amounts and transfer the amounts to a beneficiary when a member dies. This is known as "estate retirement". Refer to [Service Credits for Capital Credit Memberships](#) for more information. If your business practice designates that certain subcategories of allocated amounts do not get retired, this probably holds true for estate retirement as well. If that is the case, your membership inactivation algorithm should be designed to only retire the appropriate amounts by subcategory.

Interface Membership Information to a Third Party

For some memberships, you may accumulate points for a third party, for example accumulating frequent flier miles for an airline. For these types of memberships, you must interface the event information to the third party.

To interface information to a third party, you may choose one of the following options:

- Design an extract program to interface the information
- Use workflow and notification to interface the information via the XAI tool

Interface Via an Extract Program

The service credit event may indicate a batch code and batch run number. Design a program to extract event information to a third party. This extract program would select service credit events marked with its batch code and the current run number.

Your service credit event must define a completion algorithm that stamps the appropriate batch code and run number. The base product provides an algorithm type to perform this logic. Refer to SCEC-BT for more information.

Other Considerations For Interfacing Info to a Third Party

Because event information is extracted to a third party, you must consider how to handle adjustments to the event amount. For example, if your event is generated based on the creation of a bill segment, what should happen if that bill segment is cancelled?

You may want to prevent these types of events from getting canceled. Validation like this may be added via a user exit or using an event cancellation algorithm.

NOTE:

Sample Algorithms. The product does not provide any base algorithms to prevent an event from being canceled.

You should allow negative event amounts to be created so that this information may also be sent to the third party's system.

Defining Loan Options

The topics in this section describe how to set up the system to enable loan functionality.

NOTE:

Loans are optional. The system configuration requirements described in this section are only relevant if your organization loans money to customers.

The Terms Of A Loan Are Stored On A Service Agreement

Loans are initiated by creating a loan service agreement for a customer. The loan service agreement (and its SA Type) contains the loan's terms:

- The **loan amount** is held in the service agreement's Total Amount to Bill.
- The **customer's periodic payment amount** is held in the service agreement's Recurring Charge Amount.
- The **number of amortization periods** (e.g., 36 months, 240 months, etc.) is held in the service agreement's Number of Payment Periods.
- If the **interest rate** is the same for all customers with this type of loan service agreement, the interest rate is defined on the service agreement's SA type (using a bill factor). A specific interest rate can be defaulted from a start option contract value. If a specific interest rate applies to the customer, the SA type's interest rate can be overridden by specifying a bill factor value on the customer's service agreement (where the bill factor value contains the specific interest rate for the customer).
- The SA type controls the **periodicity of the bills** (e.g., monthly or bi-weekly).

Because a loan is defined using a service agreement, the typical functionality that is controlled by the service agreement's SA type is supported, including:

- How and when it is billed.
- How payments are booked in the GL (and the payment priority relative to other service agreements).
- How its debt is monitored by credit and collections.

- How late payment charges are calculated.

Loan service agreements are created using [Start/Stop](#) just like all other service agreements. The start/stop transaction has special loan functionality that allows an operator to specify the service agreement-specific loan terms described above. A start option can be specified to override the SA type's interest bill factor.

NOTE:

Automatic calculation of periodic payment amount / number of periods. The system calculates a loan's periodic payment amount or number of payments (whichever is left blank). You can have the system do this on [Start/Stop Maintenance](#) (using the **Calculate** button that appears on the [start service confirmation window](#)), and on [Loan - Main](#) (by clicking the **Calculate** button). Regardless of where you do this, the calculation is performed by an algorithm on the loan's SA type. Refer to the LPDA-SI algorithm type for more information about the base package algorithm.

Payoff Balance and Current Balance for Loans

As described under [Current Amount versus Payoff Amount](#), a loan service agreement's current balance and payoff balance differ during the lifetime of the loan. Current balance contains how much the customer owes to remain current (typically their periodic payment amount), and payoff balance contains the amount the customer would have to pay to payoff the loan (typically the principal balance plus any accrued interest charges).

Unlike other SAs, loans have two accounts receivable distribution codes: long term and short term. These two codes allow the general ledger to differentiate between unbilled loan receivables (long term) and billed loan receivables (short term). The current balance for a loan is always the amount of the short-term receivables. The payoff balance for a loan is always the net of the short-term receivables and the long-term receivables.

If the SA has a [special role](#) of Loan, the financial transaction algorithms supplied with the base package transfer the current amount between the long-term receivables and the short-term receivables in the GL. For example, when a bill segment is generated for the loan SA, the amount of the periodic payment is transferred from the long-term receivables to the short-term receivables. Don't worry, the examples in the following sections show exactly what these transactions look like.

An operator can see the how the bills, payments and adjustments have affected the GL, current balance and payoff balance using [SA Financial History](#).

The following sections provide examples of how adjustments, bills and payments are recorded in the GL and the subsequent effect on the current and payoff balances. When reading the examples, remember that the payoff balance is always the net of the short-term receivable and the long-term receivable balances.

Booking The Principal Amount Using An Adjustment

When a loan service agreement is activated (i.e., when its status changes from pending start to active), an adjustment is created to book the principal amount. If the customer takes out a loan of 10,000, the adjustment's financial transaction looks as follows:

Event	GL Accounting	Effect On Current Balance	Effect On Payoff Balance	Current Balance	Payoff Balance
Loan service agreement is activated (and an adjustment is created to book the principal)	Long Term Loan Receivable 10,000 Cash <10,000>	0	10,000	0	10,000

This adjustment is issued if:

- The service agreement's SA type indicates a [special role](#) of Loan.
- The loan service agreement's Total Amount to Bill contains an amount (i.e., the loan amount).
- The loan service agreement was created using a [start option](#) on [Start/Stop Maintenance](#) AND the start option references an [adjustment type](#) and this adjustment type has been set up as follows:
 - The adjustment type's distribution code should reference the GL account to credit (e.g., Cash).
 - The adjustment type's FT algorithm reference $\text{Payoff Amt} = \text{Adj Amt} / \text{Current Amt} = 0$ (booking principal only impacts a customer's payoff balance).

Note that because this financial transaction doesn't have a current amount (the customer doesn't actually owe a current amount yet), there is no need to book anything to the short-term receivables distribution code.

Loan Amortization Schedule Calculation

The amortization schedule is a projection of the amount of principal and interest in each payment over the life of the loan. The amortization schedule may change, for example if the interest rate changes or the customer makes an overpayment (reducing the principal balance).

A loan's amortization schedule is calculated when an operator clicks the **Calculate** button on [Loan - Main](#). Please be aware that when this button is clicked, an algorithm plugged in on the loan [SA type](#) actually calculates the amortization schedule (refer to the algorithm type LSCH-SI for more information).

Billing For Loans And Interest Calculation

A bill segment is produced for a loan when its service agreement's account is next billed.

Factors on a loan's SA type controls when a bill segment is produced for a loan. Typically SA types for loan service agreements are set up to use anniversary [calendar billing](#). For this configuration:

- You must indicate the type of anniversary billing in the calendar billing option. Currently, we only support the Anniversary Future Billing (meaning that loans are billed in advance just like a classic home loan is). Refer to [Using The Anniversary Method](#) for more information about how this billing method controls the end date of the loan bill segment.
- You must reference an [anniversary billing frequency](#) consistent with the [recurring charge frequency](#) (e.g., monthly, quarterly, etc.).

To set up for a loan that is billed on a monthly basis, you would define the following fields in SA Type - Billing:

- **Use Calendar Billing:** Anniversary Future Billing
- **Anniversary Bill Frequency:** Monthly
- **Total Bill Amount:** Required
- **Recurring Charge:** Required
- **Recurring Charge Frequency:** Monthly
- **Total Amount To Bill Label:** Loan Amount
- **Recurring Chg Amt Label:** Payment Amount

If your type of loan must be billed on an exact date (for example, always on the 15th of the month) or with an exact number of days between each bill (for example, every 14 days), then your loan should be set up to use the calendar billing option of Use Bill Period. In order for your loan bills to be created on specific dates, the system makes the following assumptions:

- Your [bill cycle schedule](#) for the loan's account is defined with the dates that you want the loan to bill and is defined with the window start date equal to the window end date.
- You define a [bill period](#) schedule corresponding to your bill cycle schedule. Each bill period schedule's bill date should match your bill cycle window start date and each bill period schedule's bill segment end date should be set to the loan period end date.
- Considerations for the first bill. If the loan SA Type's Initial Start Date Option indicates that the first day of the service agreement should be billed, then the loan SA's start date should match the window start date of the next bill cycle schedule for the account. If the loan SA Type's Initial Start Date Option indicates that first day of the service agreement should not be included, then the loan SA's start date should be one day prior to the window start date of the next bill cycle schedule for the account.
- Define your [recurring charge frequency](#) to match the frequency of your bill periods.

How the bill segment affects the customer's balance, and how it affects the general ledger are controlled by several algorithms defined on the loan service agreement's [SA type](#) and [bill segment type](#):

- The SA type's loan schedule algorithm controls how the [loan amortization schedule](#) is calculated.
- The SA type's loan interest charge algorithm controls how interest is calculated.
- The bill segment type's create algorithm controls how the bill lines are constructed.
- The bill segment type's financial algorithm controls how the general ledger is affected by the bill.

The second entry in the following table contains an example of the financial transaction produced by the base package algorithms (note, the first financial transaction in the table was described under [Booking The Principal Amount Using An Adjustment](#)).

Event	GL Accounting	Effect On Current Balance	Effect On Payoff Balance	Current Balance	Payoff Balance
Loan service agreement is activated	Long Term Loan Receivable 10000 Cash <10000>	0	10,000	0	10,000 long-term: 10,000
First bill segment is produced	Interest: Long Term Loan Receivable 41.66 Interest Revenue <41.66> Transfer Long Term To Short Term: Short Term Loan Receivable 438.71 Long Term Loan Receivable <438.71>	438.71	41.66	438.71	10,041.66 short-term: 438.71 long-term: 9,602.95

Several important points are illustrated above:

- When a bill segment is produced for a loan service agreement, the following takes place (if you use a bill segment creation algorithm of Create Bill Segment for Loans):
 - The loan SA type's bill segment creation algorithm calls the SA type's loan interest charge algorithm.
 - The base package loan interest charge algorithm calculates simple interest based on: 1) unbilled principal (i.e., the service agreement's payoff balance minus the current balance), 2) the number of billing periods covered by the bill, and 3) the [interest rate](#). Refer to the algorithm type LINT-SI for more information about the base package interest calculation algorithm.

NOTE:

No interest on interest and no interest on past due amounts. Just like a classic home loan, the base package algorithms do not calculate interest on interest, nor do they calculate interest on past due amounts. If you want to levy a late payment charge, use the SA type's late payment processing. If your organization calculates interest differently, you must develop your own algorithm(s).

- The SA type's bill segment creation algorithm uses the calculated interest to format the bill segment's bill lines. It creates one bill line to show the amount of interest in the payment, and another bill line to show the amount of principal. The principal amount is equal to the service agreement's periodic payment amount minus the amount of calculated interest.
- The financial transaction illustrated above is created if you use a bill segment financial algorithm of $\text{Payoff Amt} = \text{Interest} / \text{Current Amt} = \text{Bill Amount}$ on the loan's bill segment type. The following explains how this algorithm works:
 - The SA's current balance increases by the amount of the loan's periodic payment amount (i.e., its recurring charge amount). In other words, the amount the customer thinks they owe increases by 438.71.
 - The SA's payoff balance increases by the amount of interest. In other words, if the customer wanted to payoff the loan, they'd owe 10,041.66.
 - The *Interest* portion of the GL accounting is straightforward (if you're an accountant). It simply takes the amount of interest and debits it to the SA type's receivable distribution code (long-term receivables) and credits it to the distribution code defined on the interest rate's bill factor (typically interest revenue).
 - The *Transfer* portion of the GL accounting transfers moneys from long-term receivables (i.e., the unbilled principal) to short term receivables (the billed portion of the debt). The amount transferred is equal to the FT's effect on the service agreement's current balance, allowing the general ledger to differentiate between unbilled loan receivables (long term) and billed loan receivables (short term). Remember that the payoff balance is the net of the short-term and long-term receivables.

Paying What Is Owed

When a payment is made for a loan:

- The service agreement's payoff amount is reduced by the payment amount.
- The service agreement's current amount is reduced by the payment amount.

The events that happen when a customer makes a payment against a loan is controlled by the FT algorithm plugged in on the loan service agreement's payment segment type. We'll use an example to help explain how this algorithm works. The 3rd entry in the following table illustrates the financial transaction produced when a payment is made (note, the first two financial transactions were described above).

Event	GL Accounting	Effect On Current Balance	Effect On Payoff Balance	Current Balance	Payoff Balance
Loan service agreement is activated	Long Term Loan	0	10,000	0	10,000
	Receivable 10000				long-term: 10,000
	Cash <10000>				
First bill segment is produced	Interest:	438.71	41.66	438.71	10,041.66
	Long Term Loan				short-term: 438.71
	Receivable 41.66				long-term: 9,602.95
	Interest Revenue <41.66>				
	Transfer Long Term To Short Term:				

	Short Term Loan				
	Receivable 438.71				
	Long Term Loan				
	Receivable <438.71>				
Payment is made	Affect Cash	-438.71	-438.71	0	9,602.95
	Cash 438.71				short-term: 0
	Long Term Loan				long-term: 9,602.95
	Receivable <438.71>				
	Transfer Long Term				
	To Short Term:				
	Long Term Loan				
	Receivable 438.71				
	Short Term Loan				
	Receivable <438.71>				

The financial transaction illustrated above is created if you use a payment segment FT creation algorithm of $\text{Payoff Amt} = \text{Current Amt} = \text{Pay Amt}$ on the loan's payment segment type. The following explains how this algorithm works:

- The SA's current balance decreases by the amount of the payment amount. In other words, the customer thinks they owe 0 after the payment. Note refer to [Overpayments](#) for information about how an overpayment affects the SA's balances and the general ledger.
- The SA's payoff balance decreases by the amount of the payment. In other words, if the customer wanted to payoff their loan, they'd owe 9,602.95.
- The *Cash* portion of the GL accounting is straightforward (if you're an accountant). It simply takes the amount of the payment and debits it to the payment segment type's distribution code (typically cash) and credits it to the SA type's receivable distribution code (long-term receivable).
- The *Transfer* portion of the GL accounting effectively reduces short-term receivables by the FT's effect on the customer's current balance. This reduction is handled by an offsetting increase to long-term receivables (to make up for reduction made when the cash was applied). Again, this differentiation between short-term and long-term receivables allows the general ledger to differentiate between unbilled loan receivables (long term) and billed loan receivables (short term).

Overpayments On Loans

You can determine whether you want to accept loan overpayments. Overpayments reduce the principal amount (the amount owed on the loan), which follows the philosophy adopted by a typical home loan.

When the payment is made, any overpayments are distributed according to the overpayment distribution algorithm defined for the customer class. Any customer classes for which you want to allow loan overpayments should use an overpayment distribution algorithm that keeps the overpayment on the loan SA.

When the payment transaction is frozen, the system checks to see if there is a credit amount on the loan SA's current balance. If a credit exists, the customer has made an overpayment and an adjustment is created to zero out the current balance and transfer the amount of the credit from the SA's short-term receivable to long-term receivable. The adjustment may appear on the customer's next bill to show the additional amount paid against the principal.

The algorithm that controls this adjustment to remove the credit on current balance is plugged in on the loan service agreement's SA type and is applied on the SA Type - Payment Freeze system event.

The third and fourth entries in the following table illustrate an overpayment (note, the first two financial transactions were described above).

Event	GL Accounting	Effect On Current Balance	Effect On Payoff Balance	Current Balance	Payoff Balance
Loan service agreement is activated	Long Term Loan	0	10,000	0	10,000
	Receivable 10000				long-term: 10,000
	Cash <10000>				
First bill segment is produced	Interest:	438.71	41.66	438.71	10,041.66
	Long Term Loan				short-term: 438.71
	Receivable 41.66				long-term: 9,602.95
	Interest Revenue <41.66>				
	Transfer Long Term To Short Term:				
	Short Term Loan Receivable 438.71				
Payment is made (with an overpayment of 200.00)	Long Term Loan Receivable <438.71>				
	Affect Cash	-638.71	-638.71	-200.00	9,402.95
	Cash 638.71				short-term: <200.00>
	Long Term Loan Receivable <638.71>				long-term: 9,602.95
	Transfer Long Term To Short Term:				
	Long Term Loan Receivable 638.71				
Create adjustment to remove SA's credit.	Short Term Loan Receivable <638.71>				
	Transfer Short Term Credit to Long Term:	200.00	0	0	9,402.95
	Short Term Loan Receivable 200.00				short-term: 0
	Long Term Loan Receivable <200.00>				long-term: 9,402.95

In the third financial transaction illustrated above, the billed amount of the payment works essentially the same as that illustrated under [Paying What Is Owed](#). If the Keep Overpayment on Loan SA algorithm is plugged in on the overpayment distribution event on the customer class, the overpayment amount is applied to the loan SA, creating a credit on the SA's current balance. The following explains how this algorithm works:

- If the account has an loan SA and there is an excess credit, the credit is applied to the loan SA (as long as this does not cause the loan SA to have a credit payoff balance).
- If there is not a loan SA to which the credit can be applied, the algorithm checks to see if there is an open excess credit SA for the account.
 - If so, the excess credit amount is applied to the excess credit SA.
 - If not, the algorithm creates an excess credit SA and applies the amount to this SA.

The fourth financial transaction illustrated above is created if the Create Adjustment to Remove SA's Credit algorithm is plugged in on the loan's SA type's payment freeze event. The following explains how this algorithm works:

- If the SA's current balance is less than zero, the algorithm creates a frozen adjustment that removes the credit by transferring the credit from the short-term receivable to the long-term receivable. This adjustment ID is captured on the pay segment so the adjustment can be canceled if the payment is later canceled. Note that the adjustment cancel reason used by the system in this case is specified on the Financial Transaction Options [Feature Configuration](#) using the Adjustment Cancel Reason For Payment Linked To Adjustment option type.
- The SA's current balance increases by the amount of the credit transfer. In other words, the customer thinks they owe 0 after the transfer.
- The SA's payoff balance doesn't change because the payoff balance is always the net of the short-term and long-term receivables. In other words, if the customer wanted to payoff their loan, they'd still owe 9,402.95.

NOTE:

Overpayments and interest. The base package interest calculation algorithm (plugged in on the loan's SA type) does not take into consideration the exact date that the overpayment is made when calculating the interest for the period. It only takes into consideration the outstanding principal amount (payoff balance - current balance) at the time of the interest calculation.

Adjusting Loan Amounts

You would issue ad hoc adjustments if you need to change a loan's payoff and/or current balance outside of the normal billing / payment functions.

An adjustment can:

- Reduce a loan's payoff balance.
- Reduce a loan's current balance (i.e., how much the customer thinks they currently owe).
- Reduce both the loan's payoff and current balance.

For adjustments that affect payoff amount only:

- These adjustments are used to change the principal owed, e.g., if an additional amount is loaned.
- The adjustment's adjustment type should reference the Payoff Amt = Adj / Current Amt = 0 FT algorithm.
- GL lines will be generated to reflect the change to principal.

For adjustments that reduce current amount only:

- These adjustments can be used to change the amount that the customer must pay as part of the next bill.
- The adjustment's adjustment type should reference the Payoff Amt = 0 / Current Amt = Adj Amount (no GL) FT algorithm.
- Typically, GL lines are not generated for FTs that only affect the customer's current balance. However, moneys must be transferred from long to short in the amount of the adjustment (as described above under [Payoff Balance and Current Balance for Loans](#)).

For adjustments that reduce both payoff and current amount:

- These adjustment types can be used to levy additional charges, such as late fees, or to correct interest calculations.
- The adjustment's adjustment type should reference the Payoff Amt = Adj / Current Amt = Adj FT algorithm.
- GL lines are generated to reflect the change to principal. In addition, GL lines must be generated to transfer money from long to short in the amount of the adjustment (as described above under [Payoff Balance and Current Balance for Loans](#)).

NOTE:

Adjustments that affect the principal balance (payoff balance - current balance) affect the term of the loan because interest is based on the principal balance.

Adjustments can cause credit balances to exist. If you credit the loan SA, it is possible for the current balance to become negative. You may need to create additional adjustments that affect the current amount, depending on whether the customer needs to pay this amount as part of the next payment.

Writing Off Loans

Loans are written off using the standard write-off processing.

FASTPATH:

Refer to [The Big Picture Of Write Off Processing](#) for background information.

We illustrate the classic financial transactions that transpire to financially write-off a loan to help illustrate important points (these are the fourth and fifth entries in the following table):

Event	GL Accounting	Effect On Current Balance	Effect On Payoff Balance	Current Balance	Payoff Balance
Loan service agreement is activated	Long Term Loan Receivable 1000 Cash <1000>	0	10,000	0	10,000 long-term: 10,000
First bill segment is produced	Interest: Long Term Loan Receivable 41.66 Interest Revenue <41.66> Transfer Long Term To Short Term: Short Term Loan Receivable 438.71 Long Term Loan Receivable <438.71>	438.71	41.66	438.71	10,041.66 short-term: 438.71 long-term: 9,602.95
Payment is made (with an overpayment of 200.00)	Affect Cash Cash 638.71 Long Term Loan Receivable <638.71> Transfer Long Term To Short Term: Long Term Loan Receivable 638.71 Short Term Loan Receivable <638.71>	-638.71	-638.71	-200.00	9,402.95 short-term: <200.00> long-term: 9,602.95
Create adjustment to remove SA's credit.	Transfer Short Term Credit to Long Term: Short Term Loan Receivable 200.00 Long Term Loan Receivable <200.00>	200.00	0	0	9,402.95 short-term: 0 long-term: 9,402.95

Sync up current with payoff balance	Transfer Long Term To Short Term: Short Term Loan Receivable 9,402.95 Long Term Loan Receivable <9,402.95>	9,402.95	0	9,402.95	9,402.95
					short-term: 9,402.95 long-term: 0
Transfer balance to a write-off SA	Transfer From Loan SA: Write Off Xfer Clearing 9,402.95 Long Term Loan Receivable <9,402.95> Long Term Loan Receivable 9,402.95 Short Term Loan Receivable <9,402.95> Transfer To Write Off SA: Bad Loans Expense 9,402.95 Write Off Xfer Clearing <9,402.95> Note, these will cause a balance of 9,402.55 to exist on the write-off service agreement.	-9,402.95	-9,402.95	0	0

The only unusual portion of the last two financial transactions is the impact on short and long term receivables. Please see the examples above under [Billing For Loans And Interest Calculation](#) and [Paying What Is Owed](#) to understand how any impact to a loan's current balance causes this type of financial transfer to occur.

Distribution Codes for Loans

As explained above under [Payoff Balance and Current Balance for Loans](#), loans have two accounts receivable distribution codes: long term and short term. These two codes allow the general ledger to differentiate between unbilled loan receivables (long term) and billed loan receivables (short term). Both receivables distribution codes are defined on the loan SA type.

In addition, loans have a distribution code used to book interest revenue. The interest revenue distribution code is defined on the loan's bill factor value for a revenue class (defined on the loan's SA type). For example, on the bill factor you can use one distribution code to book interest revenue from the residential revenue class and another distribution code to book interest revenue from the commercial revenue class. In this example, you create two loan SA types, one for residential revenue and the other for commercial revenue.

Loans may also have a bad loan debt (expense) distribution code that is used when writing off a loan. The bad loan debt distribution code is defined on the loan's write-off service agreement type. Refer to [Defining Credit & Collections Options](#) for more information.

Setting Up The System To Enable Loans

The above topics provided background information about how loans are supported in the system. The following discussion summarizes the various setup tasks alluded to above.

Distribution Code

You must set up the following [distribution codes](#):

- Long term receivables
- Short term receivables
- Interest revenue
- Bad loan debt

Adjustment Types

The following adjustment types are needed:

- Activate a loan. This should reference a distribution code associated with cash or the cash equivalent and an FT algorithm of $\text{Payoff Amt} = \text{Adj} / \text{Current Amt} = 0$.

NOTE:

Creating Checks for Loan Amounts. If you want the system to initiate a check to the customer for the loan amount, the loan activation adjustment type should indicate an **A/P Request Type Code**. Refer to [Controls The Interface To A/P & 1099 Reporting](#) for more information.

- Remove Credit (Overpayment). This adjustment should reference an FT algorithm of $\text{Payoff Amt} = 0 / \text{Current Amt} = \text{Adj Amount (no GL)}$. Even though this algorithm indicates that there is no effect on the GL, there is a special exception built in for loan SAs. The special exception creates GL details to transfer the current balance (short-term receivable) to the long-term receivable. Refer to [Overpayments](#) for more information.

NOTE:

Printing Overpayments on Bills. If you want the overpayment adjustment to appear on customers' bills, turn on **Print by Default** and enter a **Description on Bill** (e.g. "Additional Principal"). For more information, refer to [Controls Information Printed On The Bill](#).

- Adjustment types to perform any of the adjustments described under [Adjusting Loan Amounts](#).

Adjustment Type Profile

Create an adjustment type profile that references the adjustment types used on a loan. Besides the above adjustment types, it should also reference adjustment types to levy late payment charges (if applicable), levy non-sufficient funds charges

(if applicable), refund overpayments (if applicable), sync current balance with payoff balance at write-off time, transfer balances to a write-off service agreement, and write-down small balances.

Algorithms

Add the following [algorithms](#):

- Overpayment Distribution. This algorithm is later plugged in on the customer class for the Overpayment Distribution system event. Refer to the algorithm type OVPY-LO-CSA for more information about the base package algorithm.
- Bill Segment Creation for Loans. This algorithm is later plugged in on the loan's bill segment type. Refer to the algorithm type BSBS-LO for more information about the base package algorithm.
- Bill Segment Financial Transaction Creation for Loans. This algorithm is later plugged in on the loan's bill segment type. Refer to the algorithm type BSBF-LO for more information about the base package algorithm.
- Amortization Schedule. This algorithm is later plugged in on the SA type for the Loan Schedule system event. Refer to the algorithm type LSCH-SI for more information about the base package algorithm.
- Interest Calculation. This algorithm is later plugged in on the SA type for the Loan Interest Charge system event. Refer to the LINT-SI algorithm type for more information about the base package algorithm.
- Payment Periods/Payment Amount Calculation. This algorithm is later plugged in on the SA type for the Loan Periods and Amount system event. Refer to the algorithm type LPDA-SI for more information about the base package algorithm.
- Loan SA Payment Freeze. This algorithm has a parameter that must reference the Remove Credit adjustment type defined above. This algorithm is later plugged in on the SA type for the Payment Freeze system event. Refer to the algorithm type STPZ-RMVCR for more information about the base package algorithm.

Bill Factor

You must set up a [bill factor](#) that defines the interest rate. If you have different interest rates for different types of loans, you can create a separate bill factor for each or you can use start options to override the interest rate.

On the bill factor's [bill factor value](#), make sure to reference the GL distribution code used to book interest revenue for the revenue class specified on the loan's SA type.

Customer Class

Any [customer class](#) on which you want to allow overpayments for a loan must use the overpayment distribution algorithm defined above. The overpayment distribution algorithm keeps the overpayment on the loan SA rather than transferring it to an excess credit SA, allowing a subsequent adjustment to apply the overpayment to the principal balance.

Bill Segment Type

Create a bill segment type that references the bill segment creation algorithm defined above and the FT creation algorithm defined above.

Frequency

Create [frequency](#) codes to correspond to the frequency of your loans. When setting up your SA types, you must indicate a recurring charge frequency and, if you use the Anniversary Billing Option, you must indicate an anniversary frequency.

Bill Period

If you use the Use Bill Period option, set up a bill period with an appropriate schedule of dates for billing your loan.

Bill Cycle Schedule

If you use the Use Bill Period option, the bill cycle schedule for these types of loans should be defined with an appropriate schedule of dates for billing your loan.

Collection, Severance and Write Off Processes

You should set up the appropriate credit and collections information. Refer to [Defining Credit & Collections Options](#) for more information.

SA Type

You must set up a [SA type](#) for your loan service agreements (you may need multiple SA types if you have different business rules for different types of loans). The following points describe the minimal requirements for a loan SA type.

SA Type - Main

Define the following options:

- **Distribution Code** should be a long-term receivable code.
- **Service Type** should reference something like "Miscellaneous Service".
- Specify the **Revenue Class** that, together with the interest bill factor, determines the distribution code used to book the loan interest revenue.
- **Start Option** should be turned on.
- The Payment Segment Type should reference the Normal Payment. The base package payment segment financial algorithm ($\text{Payoff Amt} = \text{Current Amt} = \text{Pay Amt}$) used for Normal Payment pay segment types creates the additional GL details to transfer the credit from long-term receivables to short-term receivables if the SA's special role is Loan.
- Turn on **Late Payment Charge** if applicable.
- Define an appropriate **Adjustment Type (Synch Current)** that will cause current balance to be synchronized with payoff balance (if the loan is [written off](#)).

SA Type - Detail

Define the following options:

- **Special Role** is Loan.
- Specify the **Interest Bill Factor** set up above. You can use start options to override.
- Use **Override Interest** to indicate whether the interest rate defined on the interest bill factor may be overridden at the SA level. If you select Allowed, the interest rate may be overridden by a contract value on a start option or the SA.
- Use the short-term receivable account defined above as the **Loan A/R Distribution Code**. If you do not want the system to differentiate between short-term receivables and long-term receivables, make the loan A/R distribution code the same as the distribution code (above).

SA Type - Billing

FASTPATH:

For an overview of some of these options, be sure to refer to [Billing For Loans And Interest Calculation](#) for more information.

Define the following options:

- The **Bill Segment Type** should reference the value created above.
- **Characteristic Premise Required** should not be checked. (A loan SA is not a premise-based service. SA types that have this box checked are filtered out of the SA type search when the start method is Start a SA, so users will never be able to start a loan SA that requires a characteristic premise.)
- **Use Calendar Billing** must equal Anniversary Future Billing or Use Bill Period.
- **Bill Period** is required for the Use Bill Period option.
- **Anniversary Billing Frequency** is required for the Anniversary Future Billing option and must equal the periodicity of the bills (monthly, weekly, etc.).
- **Total Bill Amount** is required (it holds the principal).
- **Total Amount To Bill Label** should reference something like "Loan Amount".
- **Recurring Charge** is required (it holds the periodic payment amount).
- **Recurring Chg Amt Label** should reference something like "Payment Amount".
- **Recurring Charge Frequency** is required (it defines the periodicity associated with the recurring charge amount) and must be the same as the bill period frequency or the anniversary billing frequency (based on your **Use Calendar Billing** option).

SA Type - Rate

Turn off the **Rate Required** switch as loans do not use rates.

SA Type - SP Type

Turn off the **Service Points Required** switch as loans do not have service points.

SA Type - Adjustment Profile

Adjustment Type Profile should reference the profile set up above.

SA Type - Credit and Collections

The credit and collections information should reference a **Severance Process Template** that simply expires the loan. The **Debt Class** and **Write Off Debt Class** should reference an appropriate value consistent with your credit and collections rules. Refer to [Defining Credit & Collections Options](#) for more information.

SA Type - Algorithms

The Loan Schedule, Loan Interest Charge, Loan Periods, and Amounts and Payment Freeze [algorithms](#) defined above must be set up.

Start Options

Loans require a start option to define the adjustment type that is used to create the adjustment to book the initial principal amount when the loan is activated. Loan start options can also specify default values for loan amount, payment amount, and number of periods.

Create at least one start option for each loan SA type. The following information should be defined:

- **Adjustment Type** should reference the adjustment type defined above to book principal.
- **Recurring Charge Amount** (Payment Amount) should only be defined if you have standard loan payments.
- **Total Amount To Bill** (Loan Amount) should only be defined if you have standard loan amounts.
- **Number of Payment Periods** should be the number of payment periods in the loan (if you have a standard loan period).
- If you want to define a set of standard APRs for a loan SA Type, set up a **Contract Value** on the Rate Info page. The **Bill Factor** should match the interest bill factor specified on the [SA Type](#).

Defining Non-Billed Budget Options

A Non-Billed Budget (NBB) is a payment plan that allows your customers to pay set amounts at specified intervals (e.g. every two weeks). Non-Billed Budgets are typically used when your company bills on an infrequent basis and you want to provide your customers with a mechanism to make smaller payments more frequently. As the name suggests, bills are not created for the Non-Billed Budget's scheduled payments; customers must remember to make their payments at the scheduled intervals. The topics in this section describe how to design and set up non-billed budgets.

NOTE:

Non-Billed Budgets are optional. The system configuration requirements described in this section are only relevant if your organization offers Non-Billed Budgets.

What Is A Non-Billed Budget?

A Non-Billed Budget is a special type of budget or payment plan that encompasses three major elements:

- A set of scheduled payments
- The business rules used to recommend and potentially renew the payment schedule
- The business rules that govern the financial impact on the current and payoff balances of the SAs covered by the payment schedule

Non-Billed Budgets are managed via a service agreement whose SA type has a special role of Non-Billed Budget. If an SA type has a special role of Non-Billed Budget it must have one or more recommendation rules, and SAs of that type are allowed to have payment schedules.

The Financial Impact Of Non-Billed Budgets

When you set up the Non-Billed Budget SA type, you can indicate whether the Non-Billed Budget is monitored by the [account debt monitor](#) process. The following sections contain examples of financial transactions for Non-Billed Budgets that are monitored by the account debt monitor.

NOTE:

Unmonitored Non-Billed Budgets. SAs that are covered by unmonitored Non-Billed Budgets are subject to different financial treatment than those that are monitored. The [financial transactions relevant for unmonitored Non-Billed Budgets](#) are discussed later.

Current Amount For SAs Covered By A Non-Billed Budget

As described under [Current Amount versus Payoff Amount](#), the values of the current balance and payoff balance are the same for most financial transactions. One exception is for SAs that are covered by a Non-Billed Budget in which case the current balance is always zero and the payoff balance is always the amount the customer really owes.

When a Non-Billed Budget is activated or an SA is added to a Non-Billed Budget, the system creates adjustments for all affected SAs to set the current amount equal to zero. The adjustment type that references the Payoff Amt = 0 / Current Amt = Adj Amount (no GL) algorithm is taken from the SA's SA type.

NOTE:

Non-Billed Budgets and Open Item Accounts. If the Non-Billed Budget is for an open item account, no match event is created for the financial transaction that reduces the current amount to zero. This FT must be manually matched if required.

The following example shows the effect of activating a Non-Billed Budget that covers an electric SA with a current balance of 25. The transactions for the electric SA are illustrated on the right and the transactions for the non-billed budget SA are illustrated on the left.

Event	Effect On	Effect On	Current	Payoff	Effect On	Effect On	Current	Payoff
	Current	Payoff			Current	Payoff		
	Balance	Balance	Balance	Balance	Balance	Balance	Balance	Balance
	Electric SA				Non-Billed Budget SA			
Starting balance	0	0	25	25				
Non-Billed Budget is activated	-25	0	0	25				

By setting the current balance for the covered SAs to zero, the SAs are insulated from the regular debt monitoring process. Depending on the Non-Billed Budget [recommendation algorithm](#), the payoff balance can be ignored, divided evenly between the scheduled payments or added to the first scheduled payment.

Activating a Non-Billed Budget has no affect on its own current or payoff balances.

Scheduled And Actual Payments On The Non-Billed Budget

When a scheduled payment is due, an adjustment is created to increase the Non-Billed Budget's current balance by the expected amount. The current balance on the SA can be monitored to ensure that payments are being made on time.

When the payment is made, the Non-Billed Budget's current balance is reduced to zero and the Non-Billed Budget's payoff balance reflects the accumulated credit from the payment. This accumulated credit is transferred to the covered SAs when the next bill for the account is completed.

The following example illustrates scheduled and actual payments for the Non-Billed Budget in the previous example. The amount of the scheduled Non-Billed Budget payments is 10. Note that the first two transactions were described above.

Event	Effect On	Effect On	Current	Payoff	Effect On	Effect On	Current	Payoff
	Current	Payoff			Current	Payoff		
	Balance	Balance			Balance	Balance		
	Electric SA				Non-Billed Budget SA			
Starting balance	0	0	25	25				
Non-Billed Budget is activated	-25	0	0	25				
First scheduled payment is due					10	0	10	0
Payment					-10	-10	0	-10

An algorithm (Process NBB Scheduled Payment) plugged in on the Non-Billed Budget SA type creates the appropriate financial transactions when the scheduled payment is due. The algorithm is called by the Non-Billed Budget Scheduled Payment Processing ([NBBPS](#)) background process.

The normal payment processing handles the adjustments created when the payment is made.

NOTE:

Non-Billed Budget Payment Cancellation. If a payment is canceled, the financial transaction is reversed.

Automatic Payments And Non-Billed Budgets. Users may set up a Non-Billed Budget to use [automatic payments](#) by setting up the account's auto pay options. Users may also exclude the Non-Billed Budget from automatic payment if the account is set up for automatic payment. The [NBB Scheduled Payment Automatic Payment Create](#) background process calls the Auto Pay Creation algorithm to create the auto payment for a Non-Billed Budget.

Overpayments for Non-Billed Budgets

Typically, payments in excess of the Non-Billed Budget's current balance are credited to an overpayment (excess credit) SA. When the next adjustment is created for a scheduled payment, the credit on the overpayment SA is used to relieve the non-billed budget current balance.

NOTE:

Overpayment Distribution Algorithm. The overpayment distribution is a function of the overpayment distribution algorithm plugged in on the account's customer class. We strongly recommend that the Non-Billed Budget SA type be set up so that overpayment is not allowed. Any excess payments should go to an overpayment SA. For more information about overpayment distribution, refer to [Overpayment Segmentation](#).

In the example below, the customer pays 20 for a scheduled payment instead of 10. The non-billed budget SA is illustrated on the right and the overpayment SA is illustrated on the left. The electric SA is not illustrated in the example below because scheduled payments, payments and overpayments have no effect on covered SAs. The first four transactions were illustrated above.

Event	Effect On		Current Balance	Payoff Balance	Effect On		Current Balance	Payoff Balance
	Current Balance	Payoff Balance			Current Balance	Payoff Balance		
	Non-Billed Budget SA				Overpayment SA			
Starting balance								
Non-Billed Budget is activated								
First scheduled payment is due	10	0	10	0				
Payment	-10	-10	0	-10				
Second scheduled payment is due	10	0	10	-10				
Over-payment	-10	-10	0	-20	-10	-10	-10	-10
Third scheduled payment is due	10	0	10	-20				
Transfer Adjustment	-10	-10	0	-30	10	10	0	0

After the Process NBB Scheduled Payment algorithm creates the next scheduled payment, it looks for a credit amount on the overpayment SA and creates an adjustment to transfer the credit balance (or the amount of the payment if the credit is more than the scheduled payment amount) from the overpayment SA to the non-billed budget SA. The overpayment transfer adjustment type and the overpayment SA type are specified as parameters to the algorithm.

Underpayments For Non-Billed Budgets

An insufficient payment or a canceled payment leaves a current balance on the Non-Billed Budget SA.

In the example below, the customer makes a payment of 7 for the fourth scheduled payment. The example below does not show the overpayment SA (illustrated above). The first eight transactions are discussed above.

Event	Effect On	Effect On	Current	Payoff	Effect On	Effect On	Current	Payoff
	Current	Payoff			Current	Payoff		
	Balance	Balance	Balance	Balance	Balance	Balance	Balance	Balance
	Electric SA				Non-Billed Budget SA			
Starting balance	0	0	25	25				
Non-Billed Budget is activated	-25	0	0	25				
First scheduled payment is due					10	0	10	0
Payment					-10	-10	0	-10
Second scheduled payment is due					10	0	10	-10
Over-payment					-10	-10	0	-20
Third scheduled payment is due					10	0	10	-20
Transfer Adjustment					-10	-10	0	-30
Fourth scheduled payment					10	0	10	-30
Underpayment					-7	-7	3	-37

The Process NBB Scheduled Payment algorithm creates a trigger to ensure that the current balance is monitored by the account debt monitor. Refer to [Credit And Collections And Non-Billed Budgets](#) for more information.

Billing For SAs Covered By The Non-Billed Budget

When the next bill for the account is completed, the credit on the Non-Billed Budget is transferred to the covered SAs. The credit is prorated over the covered SAs according to the relative payoff balances on each SA.

In the example below, the electric SA's bill is 33. The first ten transactions are discussed above.

Event	Effect On Current Balance	Effect On Payoff Balance	Current Balance	Payoff Balance	Effect On Current Balance	Effect On Payoff Balance	Current Balance	Payoff Balance
	Electric SA				Non-Billed Budget SA			
Starting balance	0	0	25	25				
Non-Billed Budget is activated	-25	0	0	25				
First scheduled payment is due					10	0	10	0
Payment					-10	-10	0	-10
Second scheduled payment is due					10	0	10	-10
Over- payment					-10	-10	0	-20
Third scheduled payment is due					10	0	10	-20
Transfer Adjustment					-10	-10	0	-30
Fourth scheduled payment					10	0	10	-30
Underpayment					-7	-7	3	-37
Bill	0	33	0	58				
Bill completion (transfer adjustment)	0	-37	0	21	0	37	3	0

When a bill segment financial transaction is created, the current amount is set to zero for SAs that are covered by the Non-Billed Budget (if you use a bill segment FT algorithm of $\text{Payoff Amt} = \text{Bill Amt} / \text{Current Amt} = \text{Amt Due}$). Though not evident by the name, the $\text{Payoff Amt} = \text{Bill Amt} / \text{Current Amt} = \text{Amt Due}$ algorithm does set the current amount to zero for monitored Non-Billed Budgets. (For SAs with other roles, the current amount is equal to the amount due or the recurring charge.)

A bill completion algorithm transfers money from the Non-Billed Budget to the covered SAs (if you plug in the NBB Credit Transfer bill completion algorithm on the Non-Billed Budget SA type). The algorithm type supplied with the base package distributes the credit using the method described in [Distributing Non-Billed Budget Credit](#).

NOTE:

Canceled Bill Segments. No new processing occurs when a bill segment is canceled; any credit balance remains on the covered SA.

Distributing Non-Billed Budget Credit

Both the NBB Credit Transfer bill completion algorithm type and the Non-Billed Budget SA stop algorithm type supplied with the base package use the same method of distributing a credit from a Non-Billed Budget SA to the covered SAs. The following points describe how the credit is distributed:

- Covered SAs that are already in credit (due to some other circumstance, such as a cancellation and rebill) are excluded from the distribution.
- The distribution to each covered SA will not exceed its total payoff to ensure that none of the covered SAs have a credit balance.
- The credit is prorated over the covered SAs according to the relative payoff balances on each SA.
- The calculation of the payoff balance is adjusted to exclude the current balance to ensure that the credit is prorated over the debt covered by the budget, not any ad-hoc debt for the SA.

NOTE:

The current balance on covered SAs should always be zero. The only exception occurs if an adjustment has been added that directly affected the SA balance. In this case, the distribution assumes that the balance is outside the non-billed budget and needs to be paid separately.

- Any excess credit remains on the Non-Billed Budget SA until the next distribution takes place or until the [Non-Billed Budget SA is stopped](#).
- The type of adjustments created is determined by the **Adjustment Type (Xfer)** specified on the Non-Billed Budget SA type.

The examples in the table below illustrate the points above.

NBB SA Credit	SA 1 Payoff	SA 1 Current	SA 2 Payoff	SA 2 Current	SA 1 Credit Xfer	SA 2 Credit Xfer
-100.00	-100.00	0.00	-200.00	0.00	0.00	0.00
-100.00	150.00	0.00	-50.00	0.00	-100.00	0.00
-300.00	150.00	0.00	50.00	0.00	-150.00	-50.00
-100.00	150.00	0.00	250.00	0.00	-37.50	-62.50
-100.00	150.00	0.00	250.00	50.00	-42.86	-57.14

The first example above shows that covered SAs with a credit balance are excluded from the distribution. Any excess credit remains on the Non-Billed Budget.

The second example shows that one covered SA has a credit balance, so the entire credit is distributed to the remaining SA.

The third example shows the amount distributed to a covered SA does not exceed its payoff balance. Again, any excess credit remains on the Non-Billed Budget SA.

The fourth example illustrates how the credit is prorated based on the payoff balance. The fifth example illustrates the same prorating but with a current balance on one of the SAs (SA 2). (Remember that the prorating excludes any current balance.)

The prorated amount is calculated by subtracting the current balance from the payoff balance then multiplying the result by the distribution amount and dividing by the total payoff owing of all covered SAs.

Stopping an SA Covered By a Non-Billed Budget

If a service agreement covered by a Non-Billed Budget is stopped, the system must bring the current balance and payoff balance of the covered SA back in synch. The system creates an adjustment using the Synch Current adjustment type from the SA's SA type.

In the example below, the electric SA's payoff balance is 21. The first twelve transactions are discussed above.

Event	Effect On	Effect On	Current	Payoff	Effect On	Effect On	Current	Payoff
	Current Balance	Payoff Balance	Balance	Balance	Current Balance	Payoff Balance	Balance	Balance
	Electric SA				Non-Billed Budget SA			
Starting balance	0	0	25	25				
Non-Billed Budget is activated	-25	0	0	25				
First scheduled payment is due					10	0	10	0
Payment					-10	-10	0	-10
Second scheduled payment is due					10	0	10	-10
Over-payment					-10	-10	0	-20
Third scheduled payment is due					10	0	10	-20
Transfer Adjustment					-10	-10	0	-30
Fourth scheduled payment					10	0	10	-30
Underpayment					-7	-7	3	-37
Bill	0	33	0	58				
Bill completion (transfer adjustment)	0	-37	0	21	0	37	3	0
SA is stopped	21	0	21	21				

NOTE:

In addition to synching the current and payoff balance, the SA being stopped is removed from the covered SAs collection. When the last covered SA is removed from the collection, the Non-Billed Budget is also [stopped](#).

Financial Transactions For Unmonitored Non-Billed Budgets

Some companies have the concept of non-billed budgets where the payments made by the customer are optional. This functionality is implemented as an unmonitored Non-Billed Budget. Unmonitored Non-Billed Budgets allow a customer to make optional prepayments towards a bill.

As explained previously, unmonitored Non-Billed Budgets receive different financial treatment than monitored Non-Billed Budgets. The financial transaction algorithms use the **Non-Billed Budget Monitor** flag on the Non-Billed Budget's SA type to create the appropriate financial transactions. The following table describes the differences in the financial treatment of monitored and unmonitored Non-Billed Budgets.

System Event	Monitored Non-Billed Budgets	Unmonitored Non-Billed Budgets
When a Non-Billed Budget is activated or an SA is added to a Non-Billed Budget...	The system creates adjustments for all affected SAs to set the current balance equal to zero.	The current balances for covered SAs are not zeroed. The activate SA and Non-Billed Budget maintenance processing do not create any adjustments if the Non-Billed Budget is unmonitored.
When a scheduled payment is due...	An adjustment is created to increase the Non-Billed Budget's current balance by the expected amount.	There is no change to the Non-Billed Budget's current balance; it is always zero. The scheduled payment processing background process does not execute the NBB process scheduled payment algorithm .
When the payment is made...	The Non-Billed Budget's current balance is reduced to zero and the Non-Billed Budget's payoff balance reflects the accumulated credit from the payment.	Typically the payments are distributed to an excess credit (overpayment) SA. Refer to Distributing Payments for Unmonitored Non-Billed Budgets for more information.
When a bill segment financial transaction is created...	The current amount is set to zero for SAs that are covered by the Non-Billed Budget.	The covered SAs' current amounts are equal to their payoff amounts.
At bill completion...	Money from the Non-Billed Budget is transferred to the covered SAs. Customers may receive a bill for information purposes, but they are not required to pay it.	Money from the overpayment SA is transferred to the account's SAs. The customer is still liable to pay the outstanding balance.
When the Non-Billed Budget is stopped or an SA is removed from a Non-Billed Budget...	The system creates adjustments for all affected SAs to synchronize their current balances with their payoff balances, thus removing the zero current balance and replacing it with the actual current balance.	There is no change to the current balances for covered SAs as the balances already reflect the actual current balance.

Unmonitored Non-Billed Budgets also receive different credit and collections treatment. Refer to [Credit and Collections and Unmonitored Non-billed Budgets](#) for more information.

Distributing Payments for Unmonitored Non-Billed Budgets

For Non-Billed Budgets, payments are distributed according to the payment and overpayment algorithms on the customer class. The base package payment distribution algorithm applies a payment first towards any SAs that have overdue or current balances (refer to [Distributing A Payment](#) for more information). Since the unmonitored Non-Billed Budget SA doesn't have a current balance, it is not considered by the payment distribution algorithm. If there aren't any SAs with a current balance, the overpayment distribution algorithm handles the remaining credit. You can elect to:

- Apply the overpayment to an excess credit SA. This is the method that we strongly recommend because all financial transactions are then a function of the normal payment, overpayment and billing processes.
- Apply the overpayment to the highest priority SA that is eligible for overpayment (as specified on the SA type). You can use this method to apply the overpayment to the unmonitored Non-Billed Budget SA. If you use this method, you must also set up the system to [transfer the credit from the unmonitored Non-Billed Budget](#).

NOTE:

Use An Excess Credit SA. We strongly recommend that payments for unmonitored Non-Billed Budgets are distributed to an excess credit SA. In this case, the Non-Billed Budget is just a shell to hold the covered SAs and recommend a payment schedule; all financial transactions are a function of the normal payment, overpayment and billing processes.

FASTPATH:

Refer to [Overpayment Segmentation](#) for a detailed discussion of overpayment distribution options.

Transferring Credit from Unmonitored Non-Billed Budgets

If you distribute an overpayment to an unmonitored Non-Billed Budget SA (i.e. the unmonitored non-billed budget maintains a credit balance instead of an overpayment SA), you must plug-in a bill completion algorithm on the SA type to transfer the credit balance to the covered SAs at bill completion time. The bill completion algorithm type (BCMP-NB) supplied with the base package transfers the credit balance to the covered service agreements when the bill is completed. Additionally, the **Adjustment Type (Xfer)** on unmonitored Non-Billed Budget SA types should reference a FT algorithm of $\text{Payoff Amt} = \text{Adj} / \text{Current Amt} = \text{Adj}$ to ensure that the credit is removed from both the current and payoff balances.

WARNING:

You must create your own SA stop algorithm type for correctly stopping an unmonitored non-billed budget that maintains a credit balance. The SA stop algorithm that is supplied with the base package does NOT transfer remaining credit from the unmonitored Non-Billed Budget SA. (The base package SA stop algorithm transfers the remaining credit using the overpayment distribution algorithm on the customer type, which you have set up to transfer to back to the unmonitored non-billed budget.)

Designing Non-Billed Budgets

The topics in this section describe functionality that you must consider when designing non-billed budgets.

Making SAs Eligible For Non-Billed Budgets

A billable SA may be covered by a Non-Billed Budget when its SA type is flagged as Eligible for Non-Billed Budget.

All SAs that are eligible for non-billed budgets should reference a bill segment type that uses the $\text{Payoff Amt} = \text{Bill Amt} / \text{Current Amt} = \text{Amt Due}$ bill segment FT algorithm. This algorithm sets the SA's current amount to zero if it is covered by a monitored Non-Billed Budget.

A list of the SAs covered by a Non-Billed Budget is maintained with the non-billed budget SA. This list is used at bill completion to determine the financial transactions that should occur.

Designing Recommendation Rules

Users (and the renewal process) ask the system to recommend the scheduled payments for a Non-Billed Budget. In general, this recommendation process must establish:

- The amount to be paid
- The dates on which the payments are due

We envision many different types of recommendation rules. For example:

- Recommend 26 scheduled payments to be made on a fortnightly basis that are due on Tuesdays.
- Recommend monthly payments that are due on the nearest workday after the 10th of the month.
- Recommend scheduled payments where the customer pays their annual charges in 10 out of 12 months where the payments are not due in November and December.
- Recommend bi-monthly payments where the payments are due on the first workday following the 5th and 20th of the month.

Additionally, the recommendation rules must determine how to handle any outstanding payoff balances for covered SAs. The true-up rule provided with the base package payment schedule algorithm type can ignore the payoff balance, divide the payoff balance evenly between the scheduled payments, or add the payoff balance to the first scheduled payment.

A recommendation rule comprises three elements:

- An algorithm to calculate an average daily amount (the NBDA-DA algorithm type provided with the base package uses premise billing history)

NOTE:

Calculating an Amount for Non-utility SAs. The algorithm type supplied with the base package only handles service-point oriented SAs. For example, the average daily amount algorithm calculates an average daily amount. For non-utility SAs, you must develop the appropriate algorithm types.

- Two algorithm types are provided with the base package to calculate a schedule of payments. NBPS-MON calculates a monthly schedule and NBPS-PS calculates a scheduled based on a specified number of days.
- A collection of default parameter values for the payment schedule algorithm type

A recommendation rule (based on the algorithm types provided with the base package) is illustrated below.

Rule: Weekly		
Avg Daily Amt Alg: Use premise history		
Pay Schedule Alg Type: Number of days		
Parameter	Value	Override
Number of days in period	7	Y
Number of payments	52	N
True-up rule	Spread	N

Weekly Payments Recommendation Rule

NOTE:

Additional Parameters. Not all of the parameters associated with the weekly payment schedule algorithm type are illustrated. Refer to the NBPS-PS algorithm type for a detail description of the parameters.

The default parameter values for the payment schedule algorithm type may change over time, so the collection contains an effective date. If default values are changed, these changes do not affect Non-Billed Budgets already in effect. Existing Non-Billed Budgets keep the parameter values that were used when the Non-Billed Budget was started.

A user may override the default parameter values for the payment schedule algorithm type to customize the schedule if an override is allowed for a parameter. Additionally, a user may edit the payment schedule details at any time (provided the payment has not yet been processed).

The parameter values used for the recommendation rule are kept with the Non-Billed Budget SA, so that any customized parameter changes can be re-applied to a renewed Non-Billed Budget. For example, the parameter that determines the payment due day may default to the first of the month. To customize the schedule, this value may be changed to the fifth of the month. This amended value is kept with the Non-Billed Budget SA to ensure that the renewed budget follows the same monthly schedule.

NOTE:

Normally parameter values for an algorithm type are kept with the algorithm. Because the parameters may vary for each Non-Billed Budget, the parameter values are kept with the SA in the case of Non-Billed Budgets.

Refer to [Non-billed Budgets Recommendation Rule - Main](#) for information on creating recommendation rules.

Example Recommendation Rules

The following examples may be helpful in designing and implementing your recommendation rules.

NOTE:

Developing Your Own Payment Schedule Algorithms. The base package comes supplied with a monthly payment schedule algorithm type. You can use this algorithm as an example when creating payment schedule algorithm types for your implementation.

Fortnightly Payments Recommendation Rule Example

The following diagram illustrates a recommendation rule where the customers pay every two weeks. The current balance for any covered SAs is added to the first payment.

The screenshot shows a configuration window for a recommendation rule. It includes several sections: 'Rule: Fortnightly', 'Avg Daily Amt Alg: Use premise history', and 'Pay Schedule Alg Type: Number of days'. Below these is a table with three columns: 'Parameter', 'Value', and 'Override'.

Parameter	Value	Override
Number of days in period	14	Y
Number of payments	26	N
True-up rule	Spread	N

Fortnightly Payments Recommendation Rule

Monthly Payments Recommendation Rule Example

The following diagram illustrates a recommendation rule where the customers pay twice monthly on the first of the month. The current balance for any covered SAs is spread out over the scheduled payments.

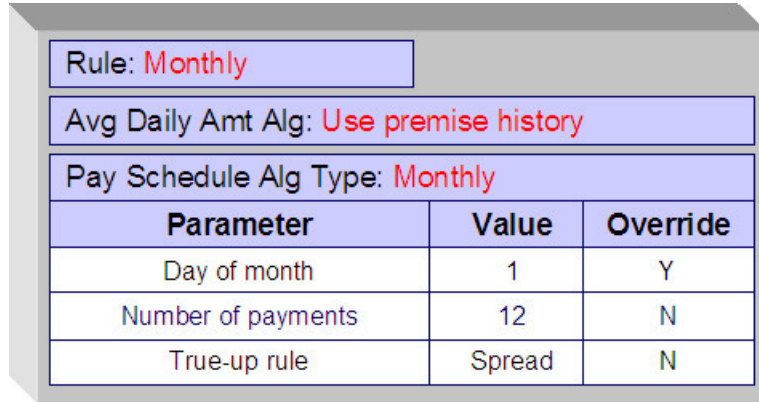

Monthly Payments Recommendation Rule

Ten Out of Twelve Months Recommendation Rule Example

The following diagram illustrates a recommendation rule where the customers pay one a month except for months during a holiday season (November and December). The current balance for any covered SAs is added to the first payment.

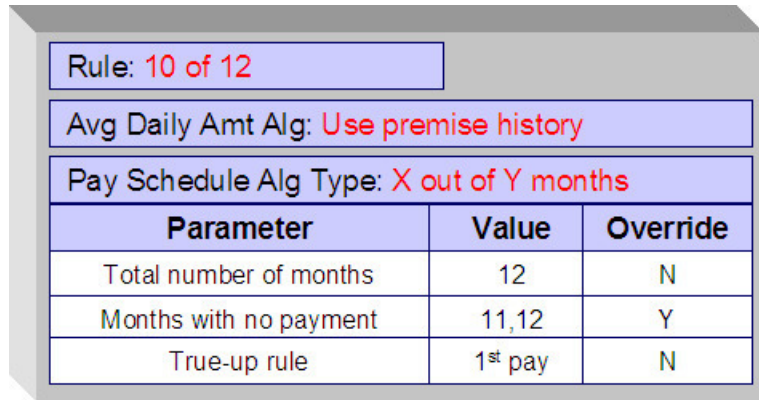

Ten Out of Twelve Months Recommendation Rule

Activating Non-Billed Budgets

You can plug in an algorithm (of type SACR-AT) on the SA Creation system event on the Non-Billed Budget SA type to automatically activate the Non-Billed Budget (i.e. transition it from pending start to active status). If you don't use a SA Creation algorithm to activate the Non-Billed Budget, it is activated the next time the [SA activation background process](#) runs.

When a Non-Billed Budget is activated, you can perform special processing using an algorithm plugged in on the SA Activation system event on the Non-Billed Budget SA type. The special processing can be developed to do anything that you would like, for example you could:

- Create a customer contact that with an appropriate letter template can generate a letter to inform the customer of their payment amount and payment schedule.
- Initiate the creation of a payment coupon book for a customer.

The system comes supplied with a sample algorithm type (called SAAT-CC) that simply creates a customer contact to indicate that the Non-Billed Budget is activated.

Renewing Non-Billed Budgets

A Non-Billed Budget can be renewed either manually or via a background process. When the Non-Billed Budget SA is created, the expiration date, renewal date and the recommendation rule used to create the initial budget are kept with the SA. A renewal flag on the Non-Billed Budget SA type controls if a renewal is required, optional or not allowed. If renewal is required, a user must specify a renewal date when creating the service agreement. The renewal date is defaulted on to an SA based on the value of the **Days Before Expiration for Renewal** field on the SA type.

An algorithm on the SA type can customize the processing required to renew an SA.

The [SA renewal background process](#):

- Executes the SA renewal algorithm (specified on the SA type) when the renewal date is reached (i.e., it is on or before the process date). The base package comes with an algorithm type (SARN-NB) that determines the current recommendation rule for a non-billed budget and executes the associated payment schedule algorithm using the Non-Billed Budget SA-specific parameter values to generate a new schedule. It returns new expiration and renewal dates.
- If the renewal algorithm is successful, the renewal and expiration date fields on the SA are updated with the new values.
- If the renewal process is not successful, a To Do list entry (of type TD-SARN) is created for the account and SA.

The new payment schedule that is returned from the renewal process for a Non-Billed Budget is appended to the current schedule.

A user can manually launch the renewal process for a Non-Billed Budget SA by clicking the **Renew NBB** button on the [Non-Billed Budget maintenance page](#).

Expiring Non-Billed Budgets

Non-Billed Budget service agreements may specify an expiration date. The [SA expiration background process](#) initiates the stop process for all pending start or active SAs where the expiration date is reached (before or on the process date).

Stopping Non-Billed Budgets

When a Non-Billed Budget stop is initiated, either on request or because it has expired and is not being renewed, the Non-Billed Budget is transitioned to pending stop status. You can plug in an algorithm (of type SAIS-ST) on the SA Stop Initiation system event on the Non-Billed Budget SA type to automatically finalize and stop the SA (i.e. transition it to stopped status). If you don't use a SA Stop Initiation algorithm, the Non-Billed Budget is stopped the next time the [SA activation background process](#) runs.

To finalize a pending stop SA, the system first calls the stop SA algorithm plugged-in on the SA Stop system event on the SA type. The stop SA algorithm type (SAST-NB) supplied with the base package:

- Distributes any credit on the Non-Billed Budget to the covered SAs (using the method described in [Distributing Non-Billed Budget Credit](#))
- Distributes any excess credit remaining on the non-billed budget using the [overpayment distribution](#) algorithm for the account's customer class and the overpayment transfer adjustment type (specified as a parameter to the algorithm)
- Creates a trigger to cause the account to be reviewed by the account debt monitor
- Creates a customer contact (if the customer contact class and customer contact type parameters are populated)

WARNING:

If you do not plug in an SA stop algorithm that transfers the credit balance from the non-billed budget to its covered SAs (or an excess credit SA), the stopped Non-Billed Budget may have a credit balance. You must then manually distribute this credit.

After the SA stop algorithm is finished, the SA stop processing performs the following steps if the SA type has a special role of Non-Billed Budget:

- If the Non-Billed Budget is monitored, create adjustments to synchronize the current and payoff balance of covered SAs using the **Adj. Type (Synch Current)** adjustment type from the covered SAs' SA types
- Remove the covered SAs from the Non-Billed Budget
- Remove all the scheduled payments from the non-billed budget
- Create an adjustment to synchronize current and payoff on the Non-Billed Budget SA using the **Adj. Type (Synch Current)** adjustment type from the Non-Billed Budget's SA type

NOTE:

Synchronizing current and payoff effectively sets the current amount to zero on the Non-Billed Budget SA, as the payoff amount should have been reduced to zero by the distribution and overpayment processing in the algorithm for SA Stop.

FASTPATH:

Refer to [The Lifecycle Of A Service Agreement](#) for more information about how a pending stop SA is stopped and closed.

Automatic Payment and Non-Billed Budgets

If a customer wants to pay their non-billed budget scheduled payments automatically, the account must be set up for automatic payment. In addition, the Non-Billed Budget must indicate that automatic payment is being used.

FASTPATH:

Refer to [How To Set Up Automatic Payment For A Non-Billed Budget](#) for more information.

When this is done, a background process referred to as NBBAPAY creates automatic payments on the scheduled payment date by calling the automatic payment creation algorithm plugged in on the installation record.

NOTE:

You must ensure that your auto pay creation algorithm supports Non-Billed Budget scheduled payments. The APAY-CREATE algorithm type supplied with the base package supports non-billed budget scheduled payments.

Credit and Collections and Non-Billed Budgets

Unless the Non-Billed Budget is [unmonitored](#), the [account debt monitor](#) (ADM) monitors a Non-Billed Budget SA's current amount just as it does for any other SA. The scheduled payment algorithm creates a trigger to ensure that the account debt monitor reviews the account the next time it runs. The review date on the trigger record is set to the process business date.

A separate [debt class](#) is needed for Non-Billed Budget SA types, thus allowing you to define collection class controls, debt criteria and collection process templates specifically for Non-Billed Budgets. The debt criteria should be set up to trigger a collection process when the arrears amount exceeds \$0.01 for more than n payment periods plus the number of grace days that you want to allow.

The collection process template can perform any of the events in standard collection processes, such as sending letters to customers and creating severance processes. At a minimum, the collection process template should be set up to start a severance process for all service agreements in the debt class. (Since the debt class is specifically for Non-Billed Budgets, the Non-Billed Budget is the only SA that will be subject to a severance process.)

The Non-Billed Budget severance process template should include the following event types:

- Populate a characteristic on the SA to indicate that the SA is broken. The base package comes supplied with a severance event algorithm type (SVEV-NB) that sets an SA characteristic to indicate that it was "severed".
- [Expire Severance Agreement](#) to move the SA to the pending stop state.

When the system subsequently stops the Non-Billed Budget, the system removes the covered SAs from the Non-Billed Budget and synchronizes their current balances with their payoff balances. Since the SAs have current balances again, they are subject to the account debt monitor, which can start subsequent collection processes for any of the SAs that meet the debt criteria for their debt class.

FASTPATH:

Refer to [Stopping Non-billed Budgets](#) for a complete description of the events that occur when a Non-Billed Budget is stopped.

Customers can catch up on their payments and avoid having their Non-Billed Budget broken as long as their current balance doesn't violate the debt criteria for the Non-Billed Budget's collection process.

Credit and Collections and Unmonitored Non-Billed Budgets

If the **Non-Billed Budget Monitor** flag on the Non-Billed Budget's SA type is set to Unmonitored, the [NBB Scheduled Payment Processing](#) background process does not create a trigger for the account debt monitor. Additionally, the Non-Billed Budget's current amount is always equal to zero, so it never violates any debt collection criteria. We recommend using a debt class that has the **Eligible for Collection** flag turned off, such as the N/A debt class.

For unmonitored Non-Billed Budgets, the current balance is kept on the covered SAs so they are subject to the account debt monitor and any debt criteria for their SA types' debt classes. For more information, refer to [Financial Transactions for Unmonitored Non-Billed Budgets](#).

Non-Billed Budget Status

A Non-Billed Budget SA's status is just like any other SA's status. In addition, you can use a characteristic to keep an explicit status relevant to the Non-Billed Budget:

- A base package severance event algorithm type (SVEV-NB) creates a characteristic value to indicate if a Non-Billed Budget is "broken" (i.e. stopped as a result of a severance process).
- A base package break Non-Billed Budget algorithm type (NBBR-BRK) creates a characteristic value to indicate if a Non-Billed Budget is "canceled" (i.e. manually stopped by a user).

An active Non-Billed Budget implicitly has a "kept" status (i.e. all scheduled payments have been made).

Alerts For Non-Billed Budgets

The system provides [alerts](#) to highlight the existence of Non-Billed Budgets. These alerts are important to assist the customer service representatives:

- An alert is displayed if the account has a Non-Billed Budget that is not stopped (e.g., pending start, active or pending stop).
- When a user denies a Non-Billed Budget (for whatever reason), the user should create a [customer contact](#) with a given [customer contact type](#). This type of alert prevents the customer from shopping around. An existing alert algorithm type (CC BY TYPCL) can highlight these customer contacts.
- For customers who are permanently forbidden from having a Non-Billed Budget, the user should put a permanent [alert on the account](#).
- Use an algorithm to highlight cancelled or severed non-billed budgets with an entry in the alert zone. The algorithm type to do this is not provided. Use PP BY STATUS and CCAL-WF as examples of how to create this type of algorithm.

FASTPATH:

For more information about introducing alert conditions on Control Central, refer to [Installation Options - Algorithms](#).

Non-Billed Budget Recommendation Rule

Recommendation rules are used to recommend scheduled payments for Non-Billed Budgets. For information about designing recommendation rules, refer to [Designing Recommendation Rules](#).

To define recommendation rules, navigate to **Admin > Financial > NBB Recommendation Rule > Add**.

Description of Page

Enter an easily recognizable **Recommendation Rule** code and **Description** for each recommendation rule.

Specify the **Average Daily Amount Algorithm** used to calculate the average daily amount for this recommendation rule.

Specify the **Payment Schedule Algorithm Type** used to create the recommended payment scheduled for Non-Billed Budgets that use this recommendation rule. The Payment Schedule Algorithm Type cannot be modified if a Non-Billed Budget SA that is not stopped or cancelled is using this recommendation rule.

Payment Schedule Parameters enables you to define collections of default parameter values for the payment schedule algorithm type that are effective dated. For each collection:

- **Effective Date** defines the date on which the collection of parameter values becomes effective.
- **NBB Rule Parameter Value** specifies the default value of each parameter supplied to the algorithm. Note that the payment schedule algorithm type controls the number and type of parameters.
- **Override** indicates whether the user can override the default value for the parameter.

Setting Up The System To Enable Non-Billed Budgets

The above topics provided background information about how Non-Billed Budgets are supported in the system. The topics in this section describe how to set up the system to enable Non-Billed Budget functionality.

NOTE:

Example Setup. This section describes typical non-billed budget configurations. Your set up and configuration may differ depending on your business needs. This section is provided for guidance only. Read the descriptions of Non-Billed Budget functionality above to understand the implications of the described setup.

NBB Distribution Codes

You must set up a Non-Billed Budget Clearance [distribution code](#) that is used on the Non-Billed Budget SA type to credit non-billed payments.

NBB Adjustment Types

NOTE:

Non-Billed Budget Financial Transaction Algorithms. The Non-Billed Budget adjustment types use the standard FT algorithm types that are provided with the base package. If you have not yet defined algorithms for these types in your system, do so before creating the Non-Billed Budget adjustment types.

The following adjustment types are needed:

- Add SA To Non-Billed Budget. This adjustment type should reference an FT algorithm of Payoff Amt = 0 / Current Amt = Adj Amount (no GL). Because the adjustment affects the current balance only, there is no entry in the GL. This adjustment type is referenced on **Adjustment Type (Current=0)** on SA types that are eligible for Non-Billed Budgets. Note that this adjustment type is never used if the SA is added to an unmonitored Non-Billed Budget.
- Bill Complete for Monitored Non-Billed Budget. This adjustment type should reference a distribution code used for balance transfer clearing. It should reference a FT algorithm of Payoff Amt = Adj / Current Amt = 0. This adjustment type is referenced on **Adjustment Type (Xfer)** on SA types that are monitored Non-Billed Budgets.
- Synch Balance for Non-Billed Budget. This adjustment type should be set up for **Sync. Current Amount** and should reference a FT algorithm of Payoff Amt = 0 / Current Amt = Adj Amount (no GL). This adjustment type is referenced on the **Adj. Type (Synch Current)** on Non-Billed Budget SA types. It is used when a Non-Billed Budget SA is stopped to synch the current balance with the payoff balance.
- Scheduled Payment. This adjustment type should reference an FT algorithm of Payoff Amt = 0 / Current Amt = Adj Amount (no GL). Because the adjustment affects the current balance only, there is no entry in the GL. This adjustment type is referenced on the Non-Billed Budget process scheduled payment algorithm.
- Overpayment Transfer. This adjustment type should reference a transfer distribution code and a FT algorithm of Payoff Amt = Adj / Current Amt = Adj. This adjustment is referenced on the non-billed budget process scheduled payment algorithm and the stop non-billed budget algorithm. Note that if there is already a transfer adjustment type created in your system, you do not need to create a new one.

If you are setting up an unmonitored Non-Billed Budget that maintains a credit balance (as opposed to maintaining the credit balance on an overpayment SA), you need to create an adjustment type for Bill Complete for Unmonitored Non-Billed Budget. (Refer to [Transferring Credit from Unmonitored Non-billed Budgets](#) for more information.) The adjustment

type should reference a transfer distribution code and a FT algorithm of $\text{Payoff Amt} = \text{Adj} / \text{Current Amt} = \text{Adj}$. This adjustment type is referenced on **Adjustment Type (Xfer)** on SA types that are unmonitored Non-Billed Budgets.

NBB Adjustment Type Profiles

Create an adjustment type profile for Non-Billed Budgets that references the following adjustment types:

- Bill complete for monitored Non-Billed Budget
- Bill complete for unmonitored Non-Billed Budget (if used)
- Synch balance for Non-Billed Budget
- Scheduled payment
- Overpayment transfer

Create an adjustment type profile for eligible SAs that references the following adjustment types:

- Add SAs to monitored Non-Billed Budgets
- Bill complete for monitored Non-Billed Budget
- Bill complete for unmonitored Non-Billed Budget (if used)

NOTE:

Bill Complete Adjustment Types. Because the bill complete adjustment types transfer amounts between two SAs, they must be in profiles for both Non-Billed Budget and eligible SA types.

Overpayment Transfer Adjustment Type. The overpayment transfer adjustment type created above is used to transfer funds from an excess credit SA to a Non-Billed Budget when the scheduled payment is processed. It is also used to transfer excess funds from a Non-Billed Budget that is being closed to an excess credit SA. The transfer adjustment should therefore be added to an adjustment type profile that is referenced on the excess credit SA type.

NBB Characteristic Types

Create a Non-Billed Budget status characteristic type that specifies Service Agreement as its characteristic entity. The characteristic type should include the following predefined values:

- Non-Billed Budget Canceled
- Non-Billed Budget Severed

NBB Customer Contact Class And Types

Create a Non-Billed Budget customer contact class. The contact class may include the following customer contact types:

- Non-Billed Budget Activate
- Non-Billed Budget Renewal
- Non-Billed Budget Stop

NOTE:

Customer Contact Letters. If you want to send letters to your customers when a contact of any of these types is created, you must create an appropriate [letter template](#) and attach it to the contact type.

NBB Algorithms

You must define the following [algorithms](#):

- On [NBB recommendation rule](#), the Non-Billed Budget Daily Amount Calculation. Refer to the NBDA-DA algorithm type for more information about the base package algorithm.
- On [SA type](#):
 - Non-Billed Budget Process Scheduled Payment. This algorithm has parameters that must reference the Scheduled Payment and Overpayment Transfer adjustment types defined above. Another parameter references an overpayment SA type (that you may need to create if there is not already one in your system). Refer to the NBPA-PS algorithm type for more information about the base package algorithm.
 - Non-Billed Budget SA Renewal. Refer to the SARN-NB algorithm type for more information about the base package algorithm.
 - Break Non-Billed Budget SA. Refer to the NBBR-BRK algorithm type for more information about the base package algorithm.
 - SA Activation - automatically activate SA (if you want to automatically activated Non-Billed Budgets when they are created). Refer to the SACR-AT algorithm type for more information about the base package algorithm. Note that this same algorithm may be used on many SA types.
 - SA Activation - create customer contact (if you want the system to create a customer contact when NBB SAs are activated). Refer to the SAAT-CC algorithm type for more information about the base package algorithm.
 - SA Stop - automatically stop SA (if you want to automatically transition Non-Billed Budgets from pending stop to stop when their stop is initiated). Refer to the SAIS-ST algorithm type for more information about the base package algorithm. Note that this same algorithm may be used on many SA types.
 - SA Stop - Stop Non-Billed Budget. Refer to the SAST-NB algorithm type for more information about the base package algorithm.
 - Bill Completion - Non-Billed Budget Credit Transfer. Refer to the BCMP-NB algorithm type for more information about the base package algorithm.
- On [bill segment type](#), the Bill FT Algorithm (for all SAs that are eligible for NBB). Refer to the BSBF-BA algorithm type for more information about the base package algorithm. Note this is the standard bill FT algorithm type used for common bill transactions. It supports bill FT for non-billed budgets and other SA types. You only need to create it if it doesn't already exist in your system.
- On [severance event type](#), an algorithm for Non-billed Budget Severance. Refer to the SVEV-NB algorithm type for more information about the base package algorithm.

NOTE:

Payment Schedule Algorithm Types. For Non-Billed Budget payment schedule algorithm types, you need to define the algorithm types (if you add your own algorithm types). You do not need to define algorithms because the parameter values for the algorithm are defaulted on the recommendation rule and stored with the Non-Billed Budget SA. (Normally the algorithm holds the parameter values.) Refer to the NBPS-MON algorithm type for more information about the base package payment schedule algorithm.

NBB Debt Class And Collection Process

Set up a separate debt class, collection class control, collection process template and severance process template for Non-Billed Budgets according to the information in [Credit and Collections and Non-Billed Budgets](#).

SA Types for SAs Covered by NBBs

You must modify the SA type for any SAs that you want to allow to be covered by a Non-Billed Budget.

- Verify that the specified **Bill Segment Type** (on the Billing page) references a financial transaction algorithm to set the current amount to zero for monitored Non-Billed Budgets. The FT creation algorithm type BSBF-BA (i.e., $\text{Payoff Amt} = \text{Bill Amt} / \text{Current Amt} = \text{Amt Due}$) supplied with the base package sets the current amount to zero for SAs that are covered by monitored non-billed budgets, though this is not evident by the name. (For SAs that are not covered by a Non-Billed Budget, the current amount is equal to the amount due or the recurring charge.) Refer to [Billing For SAs Covered By The Non-Billed Budget](#) for more information.
- Set the **Eligible for Non Billed Budget** flag (on the Billing page) to Eligible for Non-Billed Budget .
- Populate the **Adjustment Type (Current = 0)** (on the Detail page) to indicate the adjustment to be used to zero out the current amount on the covered SAs when the Non-Billed Budget SA is activated. Use the Add SA To Non-Billed Budget [adjustment](#) created above. This adjustment type is only called for SAs that are covered by a monitored Non-Billed Budget.
- Reference an **Adjustment Type Profile** (on the Adjustment Profile page) that includes the Add SA To Non-Billed Budget adjustment type referenced in the **Adjustment Type (Current = 0)** field above.
- If not already specified (for write off), an **Adj. Type (Synch Current)** (on the Main page) is also required. It is used to synchronize (make equal) the current amount with the payoff amount when the SA is removed from (i.e. no longer covered by) a Non-Billed Budget.

NBB Recommendation Rules

Set up any [NBB Recommendation Rules](#) that you want to be available for your Non-Billed Budget SAs. Use any Non-Billed Budget Daily Amount Calculation algorithms defined above. Also use the Non-billed Budget Monthly Payment Schedule (NBPS-MON) algorithm types and specify the default parameters.

Non-Billed Budget SA Types

You must set up a [SA types](#) for your Non-Billed Budget service agreements. You may need multiple Non-Billed Budget SA types if you have different business rules for different types of Non-Billed Budgets, for example, if you have both monitored and unmonitored Non-Billed Budgets or if you support Non-Billed Budgets with different renewal requirements. The following points provide guidelines for creating a non-billed budget SA type.

SA Type - Main (NBB)

Service Type should reference something like "Miscellaneous Service".

Distribution Code should be the one you set up to book credits for Non-Billed Budgets.

Revenue Class should be set to N/A. (Revenue classes are not applicable because Non-Billed Budgets do not apply a rate and revenue classes are only relevant for SA types that use a rate.)

The **Payment Segment Type** should reference the Normal Payment.

Do Not Overpay should be on. Any excess payments should go to the overpayment SA, not the Non-Billed Budget SA.

Late Payment Charge is not applicable and should not be turned on because Non-Billed Budgets are not billed.

Adj. Type (Synch Current) should reference the Synch Balance for Non-Billed Budget adjustment type created above.

SA Type - Detail (NBB)

- **Special Role** is Non-Billed Budget.
- **Adjustment Type (Xfer)** must be populated to indicate the adjustment to be used for transferring accumulated credit from the Non-Billed Budget SA to the covered SAs. This field is not used for unmonitored Non-Billed Budgets.
- **Renewal** may be optional, not allowed, or required depending on your business processes.
- If Renewal is required, specify the **Days Before Expiration for Renewal**.
- **Non-Billed Budget Monitoring** must indicate whether the Non-Billed Budget is monitored by the account debt monitor.

SA Type - Billing (NBB)

Non-Billed Budget SAs do not get billed, so the **Eligible for Billing** flag should be off.

Additionally, the **Characteristic Premise Required** should not be checked for Non-Billed Budgets.

SA Type - Rate (NBB)

Non-Billed Budget SAs do not use rates, so the **Rate Required** flag should be off.

SA Type - SP Type (NBB)

Non-Billed Budget SAs do not have service points, so the **Service Points Required** flag should be off.

SA Type - Adjustment Profile (NBB)

Adjustment Type Profile should reference the [adjustment type profile](#) for Non-Billed Budgets (set up above).

SA Type - Credit and Collections (NBB)

The credit and collections information should reference a **Severance Process Template** that calls the Non-Billed Budget Severance algorithm created above and expires the Non-Billed Budget SA. The **Debt Class** should reference an appropriate value consistent with your credit and collections rules. Typically, monitored Non-Billed Budgets should be in their own debt class. Unmonitored Non-Billed Budgets should have a **Debt Class** that is not Eligible for Collection.

The **Write Off Debt Class** is not applicable because the Non-Billed Budget contains no debt to be written off. Reference a debt class such as N/A. Refer to [Defining Credit & Collections Options](#) for more information.

SA Type - Algorithms (NBB)

The SA type [algorithms](#) defined above must be set up:

- The Non-Billed Budget Credit Transfer algorithm created above should be specified for the Bill Completion system event (not used on unmonitored Non-Billed Budgets).
- The Break Non-Billed Budget SA algorithm created above should be specified for the Break NBB SA system event.
- The Non-Billed Budget Process Scheduled Payment algorithm created above should be specified for the Process NBB Scheduled Payment system event (not used on unmonitored non-billed budgets).
- The Non-Billed Budget SA Renewal algorithm created above should be specified for the SA Renewal system event.
- If you created the Automatic SA Activation algorithm above, it should be specified for the SA Creation system event.
- The Non-Billed Budget SA Activation algorithm created above should be specified for the SA Activation system event.
- If you created the Automatic SA Stop algorithm above, it should be specified for the SA Stop Initiation system event.
- The Stop Non-Billed Budget algorithm created above should be specified for the SA Stop system event.

SA Type - NBB Recommendation Rule (NBB)

Add the recommendation rules defined above that are valid for SAs of this type. Also, indicate which recommendation rule should be used as the default.

NBB Background Processes

Ensure that the following background processes are scheduled:

- Non-Billed Budget Scheduled Payment Processing ([NBBPS](#))
- Non-Billed Budget Scheduled Payment Automatic Payment Create ([NBBAPAY](#))
- Service Agreement Renewal ([SARENEW](#))
- Stop Expired Service Agreements ([SAEXPIRE](#))

Defining Quotation Options

This section describes tables that must be set up before quotations can be created.

FASTPATH:

For more information, refer to [The Big Picture of Quotations](#).

Setting Up SA Types For Quotes

The topics in this section describe additional setup responsibilities required on SA types that can have proposal service agreements.

NOTE:

Assumption. We have assumed that you've already designed your SA types for the services that you sell. If you haven't done this, refer to [Defining Service Agreement Types](#).

Enabling The Automatic Generation Of Billing Scenarios

As described under [Proposal SAs Contain Billing Scenarios And Template Consumption](#), a proposal SA requires billing scenarios before a quote detail can be generated. The system can automatically create billing scenarios when a proposal SA is created. If this is required for your implementation, create a Proposal SA Creation algorithm type, and plug in the appropriate algorithm on each applicable Proposal SA type. Refer to PSAC-CBS for an example algorithm (*note, this algorithm is not applicable for C2M but may be used as a reference only*).

Enabling The Generation Of Simulated Bill Segments

As described under [Creating Quotes And Quote Details](#), in order for the system to generate simulated bill segments for a proposal SA, you must plug-in a Proposal SA Bill Segment Generation algorithm on the proposal SA's [SA type](#). Refer to CBSP-AR for an example algorithm that creates a simulated bill segments for each billing scenario linked to the proposal SA by calling rate application.

Enabling The Creation Of A Real SA When A Quote Detail Is Accepted

As described under [Accepting / Declining Quote Details](#), in order for the system to create a real SA when a proposal SA is accepted, you must plug-in a Proposal SA Acceptance algorithm on the proposal SA's [SA type](#). Refer to PSAA-PS for an example algorithm that creates a real SA by copying the proposal SA.

NOTE:

Interval pricing service agreements. are not supported. PSAA-PS has a parameter for creating interval profiles, time-of-use maps and contract options when the real SA is created. This specific parameter/option is not applicable for C2M.

Setting Up Quote Route Types

Quote route types control how quotes are [routed](#) to customers and prospects. To define a quote route type, open **Admin > Sales & Marketing > Quote Route Type**.

FASTPATH:

Refer to [Printing Quotes](#) for more information about how quotes are routed to customers and prospects.

Description of Page

Enter a unique **Quote Route Type** and **Description** for every quote route type.

Quote Routing Method controls the type of information that may be defined when the respective **Quote Route Type** is selected on [Account - Person Information](#). The following options are available:

- **Postal:** Use this method if the routing is via the postal service.

- Fax: Use this method if the routing is via fax.
- Email: Use this method if the routing is via email.

NOTE:

The values for **Quote Routing Method** are customizable using the [Lookup](#) table. This field name is QTE_RTG_METH_FLG .

- The next two fields control how quotes that are routed using this method are [printed](#) (both in batch and online).
 - Use **Batch Control** to define the process that creates the flat file that is passed to your quote printing software. Refer to [Technical Implementation of Printing Quotes In Batch](#) for more information about these processes.
 - Use **Extract Algorithm** to define the plug-in that constructs the "flat file records" that contain the information merged onto quotes routed using this method. Refer to [Printing Quotes](#) for more information.

Setting Up Terms and Conditions

As described under [Legal Terms and Conditions May Be Specified On SAs](#), your **SA type start options** can reference terms and conditions (T&C's) that should be defaulted onto new service agreements (both real and proposal). Each T&C is identified with a terms and condition code. To define a terms and conditions code, open **Admin > Sales & Marketing > Terms and Conditions > Add**.

NOTE:

T&C print order. The value of the T&C code controls the order in which the T&C appears on the printed quote. This means you should assign these codes in some type of structured format (e.g., 01...) if you would like them to appear in a certain order.

Description of Page

Enter a unique **Terms and Condition** code and **Description**. Use **Text** to describe the exact terms.

Setting Up Decline Reasons

A proposal SA decline reason must be supplied when a proposal SA is declined. Open **Admin > Sales & Marketing > Proposal SA Decline Reason** to define your reason codes.

Description of Page

Enter an easily recognizable **Decline Reason** and **Description** for each proposal SA decline reason.

Where Used

Decline reasons are used when a [quote detail is declined](#).

Setting Up Customer Classes For Quotes

An optional plug-in spot exists on [customer class](#) where you can introduce additional logic to be executed when a quote is completed for an account that belongs to this customer class. The base package comes supplied with a sample algorithm that creates a workflow process when a quote is completed (refer to the algorithm QTEC-WP for more information).

Defining Case Management Options

Case management functionality is a highly configurable tool your organization can use to manage many situations, including (but certainly not limited to) the following:

- a high-bill complaint,
- a bankruptcy,
- an inspection of a premise,
- a customer's request for literature,
- an application for new service,
- a contractor's request to extend a line,
- a customer's rejection of a quote,
- a customer's request to change service providers on a future date,
- the processing of a market message in a deregulated environment,
- ... (the list is only limited by your time and imagination)

Obviously the steps involved in the resolution of the above cases are very different. The topics in this section describe how to configure the system to manage your cases as per your organization's desires.

NOTE:

Separate module. The Case Management functionality is associated with a separate module. If the Case Management module is not applicable to your business you may turn it off. Refer to [Turn Off A Function Module](#) for more information.

FASTPATH:

Refer to [Case Management](#) for a description of how end-users use cases.

The Big Picture Of Cases

The topics in this section provide background information about how to configure the system to support your case management requirements.

Case Type Controls Everything

Whenever a user creates a case, they must specify the type of case (e.g., high-bill complaint, literature request, etc.). The case type controls how the case is handled.

Case types hold the business rules that control cases. Since these business rules can sometimes be quite complicated, setting up case types requires planning and foresight. The topics in this section describe the type of business rules that can be configured on your case types.

Person / Account / Premise Applicability

Some types of cases may be person-oriented, others may be premise-oriented, and still others may be account-oriented. For example:

- Cases used to keep track of a literature request would reference the person who requested the literature.
- Cases used to keep track of the inspection of a property would reference the premise being inspected.
- Cases used to keep track of a high-bill complaint would reference the account associated with this bill(s) being disputed.

When you set up a case type, you define if its cases must reference a person, account, and/or premise. Note, any combination of these objects is permitted on a case.

Contact Information Applicability

When a case is created, you may want to keep track of how to contact its originator. For example, you may want to record the originator's email address or phone number. When you set up a case type, you define if contact information is required, optional or not allowed on its cases.

Business Object Association

A case type may reference a Business Object, which serves as a link between cases of that type and the options that are associated with the business object.

Additional Information

Some of your cases may require additional information (in the form of [characteristics](#)). For example, a high-bill complaint may require at least one bill. When you set up a case type, you can define the additional fields that are required. In addition, you can define default values for these fields.

The case functionality also allows you to require characteristics when a case enters a given state. Refer to [Required Fields Before A Case Enters A State](#) for the details.

NOTE:

Requiring supporting documents. Because any [type of characteristic](#) can be referenced on a case, you can require references to supporting documents by requiring a file location characteristic.

Access Rights

You can take advantage of the system's [security](#) to restrict cases of a given type to certain users. For example, you can restrict high-bill complaints to specific user groups.

The following points describe how to implement this type of security:

- Create an [application service](#) for each type of case you need to secure
- Define the access modes Add, Inquire and Change for each application service
- Define the applicable application service on each case type

- Link the appropriate [user groups](#) to each application service
 - For user groups that are allowed to add cases of a given type, define Add as a valid access mode.
 - For user groups that are allowed to view cases of a given type, define Inquire as a valid access mode
 - For user groups that are allowed to change cases of a given type, define Change as a valid access mode

If you restrict access to a case type's cases, you can further restrict which users can work on cases given the status of the case. Refer to [Which Users Can Transition A Case](#) for more information.

NOTE:

Restricting access to cases is optional. If you don't specify an application service on a case type, all users (who have access to the case transaction) may access its cases.

Lifecycle

Many objects in the system have predefined lifecycles whose rules are governed by the base-package and cannot be changed. For example, a service agreement starts out in the Pending Start state and eventually becomes Closed when it's been final billed (and paid). You can't change the system to allow a service agreement to start its life in the Closed state.

The lifecycle of cases is not governed by the base package. Rather, you define the lifecycle of your cases when you set up their case types. Examine the following diagrams; the one on the left shows the potential lifecycle of a case that manages a high-bill complaint, the one on the right shows the potential lifecycle of a case that manages a customer's literature request.

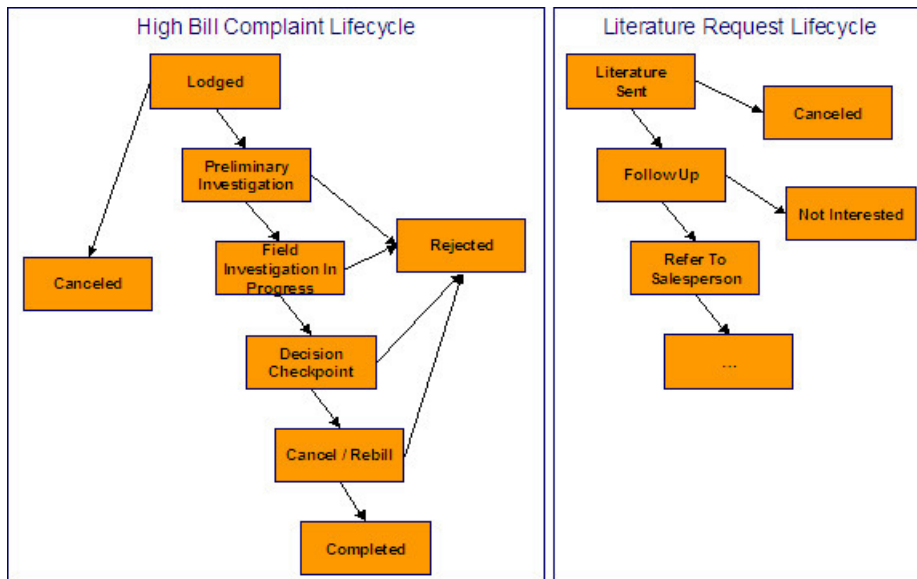

Potential Lifecycles Of Two Types Of Cases

NOTE:

Just examples. The above lifecycles are just examples. When you set up your case types, you must define the valid states for your case type.

The topics that follow describe important concepts that are illustrated in the above diagrams.

Valid States versus State Transition Rules

The orange boxes in the above diagram show the potential valid states a given case can have. The lines between the boxes indicate the state transition rules. These rules govern the states a case can move to while it's in a given state. For example, the above diagram indicates a high bill complaint that's in the Lodged state can be either Canceled or moved into the Preliminary Investigation state.

When you set up a case type, you define both its valid states and the state transition rules.

Transitory States

You can define a state in a case type as **Transitory** if you do not wish the case to exist in a particular state. For example, let's assume that an algorithm is associated with the Decision Checkpoint state (Enter Processing) that would automatically determine the next state for the case (i.e. Cancel/Rebill or Reject) and also contains logic to transition the case accordingly. In this scenario, you may not ever want the case to exist in the Decision Checkpoint state, so that a user won't ever see a high bill complaint in that state. If the other states were marked as non-transitory, and an error were to occur during the transition from Decision Checkpoint to Cancel/Rebill, the case would roll back any changes to data made in the Cancel/Rebill (Enter Processing) state along with the changes made in the Decision Checkpoint state, and would end up in the Field Investigation In Progress state - the last non-transitory state prior to Decision Checkpoint.

One Initial State and Multiple Final States

When you set up a case type's states, you must pick one as the initial state. The initial state is the state assigned to new cases of a given type. For example, high-bill complaint cases have an initial state of Lodged, whereas literature request cases have an initial state of Literature Sent.

You must also define which statuses are considered to be "final". When a case enters a "final" state, it is complete and no further action is necessary. You might want to think of the "final" states as the potential outcomes of a case. For example, a high-bill complaint has potential outcomes of Completed, Rejected, and Canceled.

The "final" states are used by the system to differentiate between open and closed cases. For example, an alert highlights when the person / account / premise in context has open cases (this alert only exists if you've plugged-in the appropriate installation [alert](#)).

Allowing A Case To Be Reopened

You can set up your state transition rules to allow a case to be reopened (i.e., to be moved from a final state to a non-final state). Neither of the above examples allows this, but it is possible if you configure a case type accordingly.

Make Sure To Have A Canceled State

The system does not allow you to delete a case. Therefore, if you want to support logical deletion, you should have a status of Canceled early in a case type's lifecycle. Doing this allows a user to cancel (i.e., logically delete) a case.

NOTE:

Cancel reason. You might want to consider setting up your case types to require a cancel reason (in the form of a [predefined value characteristic](#)) when a user cancels a case. Refer to [Required Fields Before A Case Enters A State](#) for more information.

Buttons Are Used To Transition A Case From Status To Status

When a case is displayed on [Case - Main](#), a separate button is shown for each state into which the case can be transitioned. For example, a high-bill complaint case that is in the Lodged state would show two buttons: **Start Investigation** and **Cancel**. If the user presses the **Start Investigation** button, the case is transitioned to the Preliminary Investigation state. If the user presses the **Cancel** button, the case is moved to the Canceled state.

You may define the text displayed on the button differently for each state transition. This allows the action description to be varied according to the previous status. For example, the button to transition from New to Active may be labeled **Activate**, but the button to change from Closed to Active may be labeled **Reactivate**.

Refer to [Which Users Can Transition A Case](#) for instructions describing how to restrict users to specific actions.

State Transitions Are Audited

The system maintains an audit trail whenever a case transitions from one state to another. This audit is shown in the case's [log](#).

Reports and Analytics Highlight Productivity

When you set up a case type's lifecycle, keep in mind that several reports and analytics highlight how long it took cases to transition into a state. For example, you can use a report to see how long it took high-bill complaints to be completed (or initially actioned or ...). Refer to the [Reports](#) chapter for the details of case reports.

Status-Specific Business Rules

As described in [Lifecycle](#), when you set up a case type, you define the possible states its cases can pass through. The following topics describe business rules that can be configured for each state.

A Script That Helps A User Work Through A Case

You can define a [Business Process Assistant script](#) that helps a user work a case while it's in a given state. For example, when you set up the Preliminary Investigation state for the high-bill complaint case type, you can define a script. A user can then easily launch this script to help them work through a case in this state.

Please keep the following in mind when you're designing how to integrate BPA scripts with your cases:

- You can have a different script for each state. For example, you could develop a script to help a user work on a case while it's in the Preliminary Investigation state and a different script to help them work in a case while it's in the Decision Checkpoint state.
- Rather than make a user launch a script by pressing a hyperlink on the [case page](#), you can have the system automatically launch the script while the case is in a given state. Refer to [Script Launching Option](#) for more information.
- You can also have the system automatically launch a script when a user selects a To Do entry. Refer to [Launching Scripts When To Do Entries Are Selected](#) for more information.

FASTPATH:

Refer to [Scripts and Cases](#) for more information about how to streamline your case processing with scripts.

Required Fields Before A Case Enters A State

You can define additional fields (i.e., characteristics) that are required before a case can enter a given state. For example,

- You can indicate a high-bill complaint must reference at least one bill before it enters the Preliminary Investigation state.
- You can indicate a case must reference a cancel reason before it enters the Canceled state.

You do this by indicating that [characteristics](#) (that were optional when the case was added) are required when a case enters a given state.

Validation Before A Case Enters A State

You can define validation that executes before a case can enter a given state. For example, you can indicate the case must have been assigned a responsible user before it can enter the Preliminary Investigation state. This validation logic is held in algorithms that are plugged in on the case type and therefore you can define any type of validation.

Additional Processing When Entering A State

You can define additional processing that should happen when a case enters a given state. For example, you can have a [letter](#) created when a high-bill complaint case is Rejected. Similarly, you can have a [To Do entry](#) created when a high bill complaint enters the Preliminary Investigation state. This additional processing is held in algorithms that are plugged in on the case type and therefore you can define any type of additional processing.

You can also incorporate state transition logic within routines that are executed when a case enters a state, so that you do not need to rely upon CASETRAN to transition your cases. For example, when the state entry routines of the Preliminary Investigation status for a high-bill complaint are executed, they may be designed to transition the case into either the Rejected or Field Investigation In Progress state without waiting. Note that your Exit Validation and Exit Processing logic, if configured for the case state, will still be executed as part of the state transition. Auto-Transition logic for this state will be ignored during this transition.

Validation Before A Case Exits A State

You can define validation that executes before a case can exit a given state. For example, you might want to check the account's balance is less than a given value before a case can exit a given state. This validation logic is held in algorithms that are plugged in on the case type and therefore you can define any type of validation.

Additional Processing When Exiting A State

You can define additional processing that should happen when a case exits a given state. For example, you can have a [To Do entry](#) automatically completed when a high bill complaint leaves the Decision Checkpoint state. This additional processing is held in algorithms that are plugged in on the case type and therefore you can define any type of additional processing.

Automatic Transition Rules

You can define rules that automatically transition a case into a different state. For example, you can indicate a literature request should be transitioned to the Follow Up state 1 week after the literature is sent. Similarly, you can indicate a high-bill complaint should transition to the Decision Checkpoint state after the fieldwork is complete. These rules are held in algorithms that are plugged in on the case type and therefore you can define any type of automatic transition rules.

Cases in a state with automatic transition rules are monitored by the [CASETRAN](#) background process. Each time this program runs, the respective automatic transition plug-in is called for each such case and it transitions the case if the condition applies.

NOTE:

When to execute CASETRAN. Because your automatic transition rules will be dependent on your business requirements, you need to think carefully about when you run the [CASETRAN](#) background process. For example, if you have automatic transition rules that transition a case to a new state when a related field activity is completed, you would want to schedule this job to run after field activities are uploaded. If you have rules to transition a case after a customer pays a deposit, you'd want to schedule this job to run after payments are uploaded. Bottom line - your business rules will dictate the frequency of execution.

When the user adds a new case or changes the state of a case manually the system attempts to auto-transition the case to subsequent statuses as necessary. If auto-transition rules apply to the new state (and to subsequent ones) they would be executed right away. In other words, you don't need to wait for the auto-transition background process to be executed. An indication that the case was auto-transitioned online is displayed right below the action buttons section.

NOTE:

Auto-Transition Errors. Online auto-transition is performed recursively committing each successful state transition to the database. It is performed up to 100 times or until an error is encountered during the process. If this happens, auto-transition stops at the last **non-transitory** state into which a successful transition had occurred. Two case log entries will be generated automatically - one containing the message that a transition error has occurred, and a second containing the actual error message. A To Do entry will also be generated automatically upon rollback. The type of this To Do entry will be taken from 1) the Case Transition Exception To Do Type **option** for the **Business Object** associated with the case type, and if this is not populated, 2) the Exception To Do Type indicated on the Case Options Feature Configuration. All of the above error handling is true for both batch and online processing of cases.

NOTE:

Triggering Auto-Transition. If you have a customized process that affects the state of a case and you want the case to be auto-transitioned right away, i.e. not wait for the next scheduled [CASETRAN](#) background process to execute, you can customize that process to trigger auto-transition for the specific case, or you can put the state transition logic into the routines that execute at state entry time.

Script Launching Option

You can define whether the script associated with a given state is to be automatically launched while the case is in that state. The system supports the following options:

- Launch the script only if no script is currently active.
- Always launch the script unless this specific script is currently active.

WARNING:

With this option, if a script is currently open in the page's BPA script area then it will be automatically closed and the case script will open.

- Do not automatically launch the script.

You do this by plugging-in a Script Launching algorithm for the given state. If no such plug-in is provided the script is not automatically launched.

Which Users Can Transition A Case Into A State

If you have [restricted access](#) to a case type, you can further restrict which user groups are allowed to transition a case into specific states. For example, you can control which user group can transition a high bill complaint into the Preliminary Investigation state. The following points describe how this is done:

- Define actions on the [application service](#) defined on the case type. You must define an action for each status that you need to secure.
- Define each status's corresponding action. Note, you only need to link a status to an action if it's secured. Any user with [access](#) to the case type can perform statuses that aren't linked to actions.
- Define the transition role for each status's valid next status. You can assign valid next statuses to be reachable via system (only), or system and user.
- Define which [user groups](#) have access to the actions (i.e., statuses). In addition, these user groups should have access to the Change action.

Responsible User Applicability

Some of your cases may require a "responsible user". This is the user who has overall responsibility for the case. When you set up a case type, you define if a responsible user is required, optional or not allowed on its cases.

The following points describe how to set up the system if a responsible user is not required when a case is first created, but is later in its lifecycle:

- Indicate that a responsible user is optional on the case type
- Plug-in either an [exit validation](#) or [entry validation](#) algorithm on one of the case type's states to require a responsible user at some point in a case's lifecycle

NOTE:

Address To Do entries to the responsible user. If you use the base-package algorithm to create a To Do entry when a case enters a given state, you can indicate that the To Do entry should be addressed to the responsible user on the case.

Scripts and Cases

There are three ways [Business Process Assistant scripts](#) can be used to manage cases:

- You can create a BPA script to help users create a case. For example, a script can help a user create a new high-bill complaint.
- Using a script to create a case can save a user a lot of time (and training efforts). This is because the script can automatically populate many fields on the case based on answers to questions.

Refer to [Initiating Scripts](#) for a description of how end-users initiate scripts.

- You can create a script to help users work on a case when it's in a given state. Refer to [A Script That Helps A User Work A Case](#) for more information.
- You can [set up your case types to create To Do entries](#) to notify users when cases exist that require their attention. Users can complete many of these ToDo entries without assistance. However, you can set up the system to automatically launch a script when a user selects a ToDo entry. For example, consider a ToDo entry that highlights a high-bill complaint that requires investigation. You can set up the system to execute a specific script when a user selects this ToDo entry. This script might guide the user through the investigation process (and help them update the case). Refer to [Executing A Script When A To Do Entry Is Selected](#) for more information.

To Do's and Cases

The topics in this section provide background information about how to facilitate case management with [To Do entries](#).

Creating and Completing To Do Entries

You can configure your case types to create and complete [To Do entries](#) when a case enters or exits a state. Let's use the following [lifecycle diagram](#) to illustrate a potential use of To Do's:

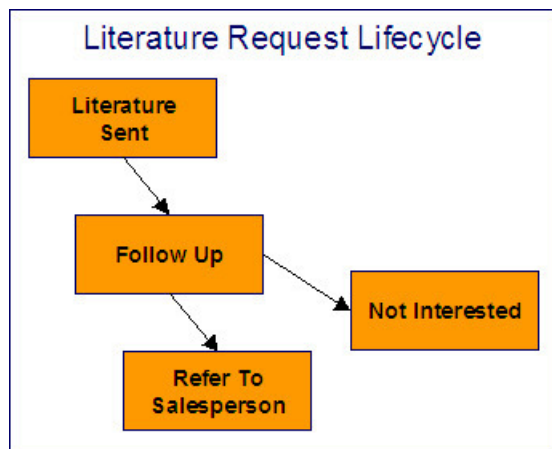

Let's assume the following:

- You want a To Do entry created when a literature request case enters the Follow Up state. You want this To Do automatically completed when the case enters either the Refer To Salesperson or Not Interested states. Note, we refer to this as the "first" To Do entry below.
- You want a different To Do entry created when a case enters the Refer To Salesperson state. You do not want the system to automatically complete this entry (the sales person must manually do this). Note, we refer to this as the "second" To Do entry below.

To implement the above, you would set up a case type as follows:

- Plug-in an [entry processing](#) algorithm on the Follow Up status to create the first To Do entry.
- Plug-in an [exit processing](#) algorithm on the Follow Up status to complete the first To Do entry.
- Plug-in an [entry processing](#) algorithm on the Refer To Salesperson status to create the second To Do entry.

While the case type illustrated above had a single To Do entry "active" at any point in time, you can easily configure a case type to have multiple To Do entries active at any point in time. Let's use the following lifecycle diagram to illustrate this point:

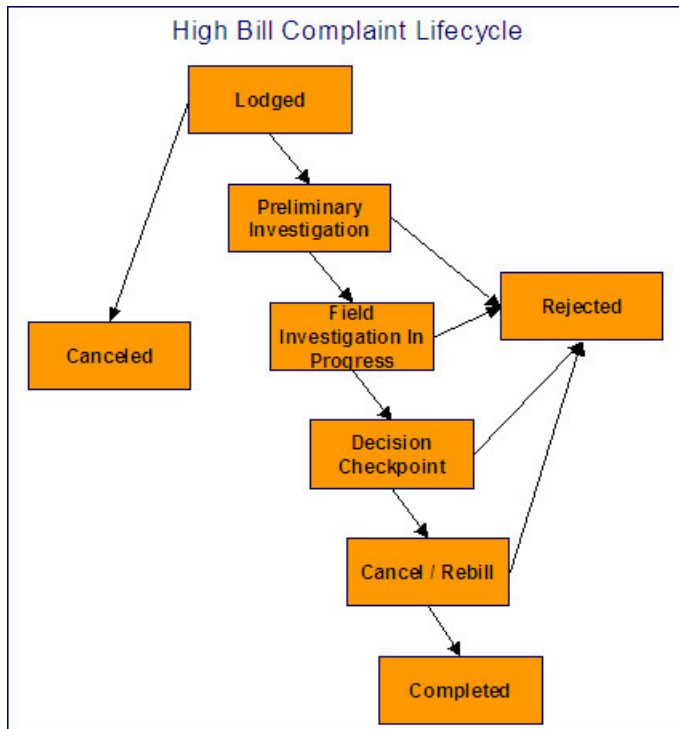

Let's assume the following:

- You want a To Do entry created when a high bill complaint is created and you want it completed when the case reaches the Canceled, Rejected or Approved states. This To Do entry could be used by a supervisor to monitor the number of high-bill complaints being worked. Note, we refer to this as the "first" To Do entry below.
- You want a different To Do entry created when the case enters the Preliminary Investigation state and you want this entry automatically completed when the case leaves this state. Note, we refer to this as the "second" To Do entry below.
- You want a different To Do entry created when the case enters the Decision Checkpoint state and you want this entry automatically completed when the case leaves this state. Note, we refer to this as the "third" To Do entry below.

To implement the above, you would set up the case type as follows:

- Plug-in an [entry processing](#) algorithm on the Lodged status to create the first To Do entry. Plug-in an [entry processing](#) algorithm on the Canceled, Rejected and Completed statuses to complete this entry.
- Plug-in an [entry processing](#) algorithm on the Preliminary Investigation status to create the second To Do entry. Plug-in an [exit processing](#) algorithm on the Preliminary Investigation status to complete this entry. We elected to use an exit processing algorithm because we only have to plug it in on one status. If we'd used an entry processing algorithm, we would need to plug it in on the 2 statuses into which a Preliminary Investigation status can transition.
- Plug-in an [entry processing](#) algorithm on the Decision Checkpoint status to create the third To Do entry. Plug-in an [exit processing](#) algorithm on the Decision Checkpoint status to complete this entry.

Launching Scripts When To Do Entries Are Selected

You can set up your case types to create To Do entries to notify users when cases exist that require their attention. Users can complete many of these To Do entries without assistance. However, you can set up the system to automatically launch a script when a user selects a To Do entry. For example, consider a To Do entry that highlights a high-bill complaint that requires investigation. You can set up the system to execute a specific script when a user selects this type of To Do entry. This script might guide the user through the investigation process. Refer to [Executing A Script When A To Do Entry Is Selected](#) for more information.

All To Do Entries Are Visible

When a case is displayed on [Case Maintenance](#), the system summarizes the number of To Do entries associated with the case (if you've [set up your To Do types](#) appropriately).

Examples of Case Types

The topics that follow provide examples of case types related to several business processes. Use the information in this section to form an intuitive understanding of case types. After attaining this understanding, you'll be ready to design your own case types.

High Bill Complaint

Some organizations will set up a case to manage a high-bill complaint. The following diagram illustrates how such a case type might look:

Case Type – High Bill Complaint

Person / Account / Premise Applicability	
Field	Applicability
Person	Required
Account	Required
Premise	Optional

Secured

Yes, all actions

Fields To Be Captured		
Field	Required / Optional	Default Value
Bill ID	Optional	..
Cancel reason	Optional	..
Reject reason	Optional	..

Applicability Rules	
Field	Applicability
Responsible User	Optional
Contact Information	Optional

Note the following about the High Bill Complaint case type:

- Notice that we set up the case type to require a person and an account, but premise is optional. This is because a bill can span multiple premises and knowing the premise isn't so important on cases of this type.
- We need to restrict high-bill complaints to specific user groups. This means we need to [set up a specific application service](#) for this case type (that has a separate "action" for each status).
- Cases of this type have 3 additional fields over their lifetime. Notice the following:

- The **Bill ID** characteristic is set up to be optional. This is because we've assumed that sometimes a high-bill complaint case can be lodged when you can't find the bill in question and you still want to log the case.
- Later in this section, you'll see that we've configured the Preliminary Investigation status to require a **Bill ID** before a case can enter this state.
- Both the **High Bill Complaint Cancel Reason** and **Reject Reason** are optional. Later in this section, you'll see that we've configured the Canceled and Rejected statuses to require these fields, respectively.
- Cases of this type do not need a **Responsible User** when first created. Later in this section, you'll see how we've configured the Preliminary Investigation status to require a **Responsible User** before a case can enter this state.
- Cases of this type do not need **Contact Information**. This was a subjective decision and depends on your organization's philosophy.

The topics that follow describe each of the statuses in a high-bill complaint's [lifecycle](#). We have assumed the following state transition rules:

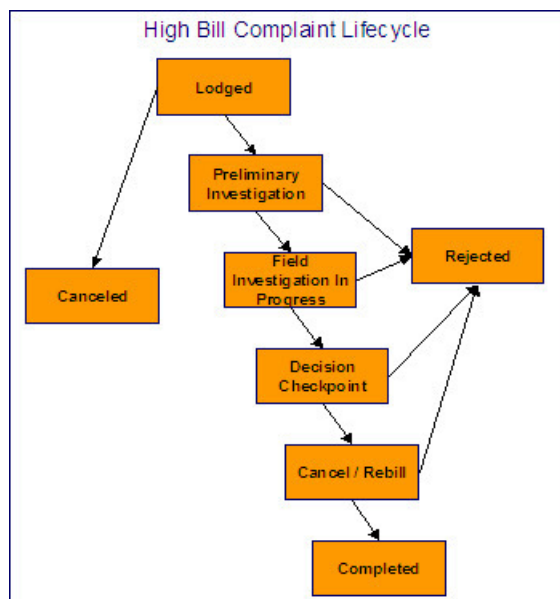

Lodged High Bill Complaint

The following is an example of the configuration of the Lodged status for high bill complaint cases.

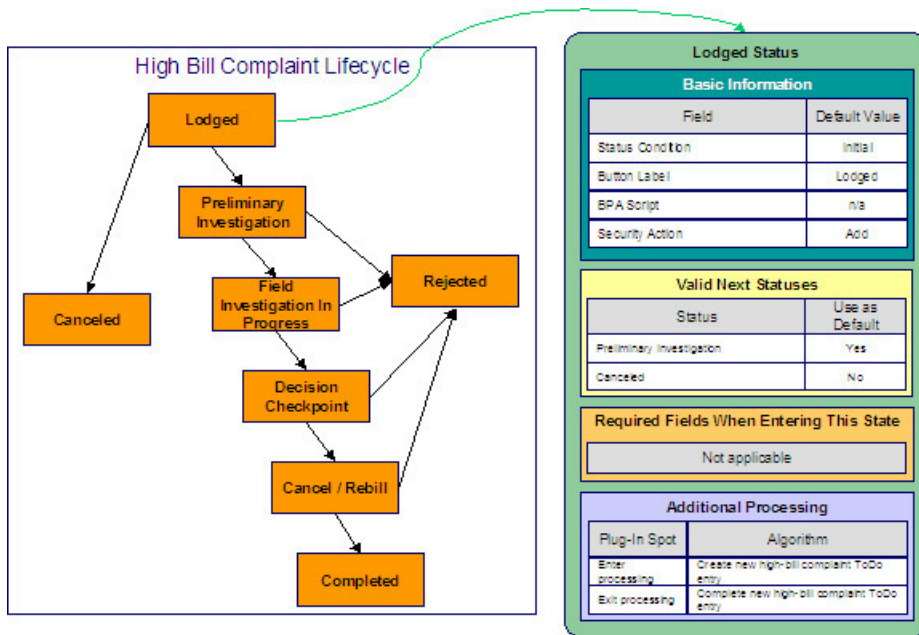

Note the following about this status:

- Lodged is the initial state. The initial state is the state populated on new cases of a given type. Remember that only one status can be defined as the initial state.
- It has a button label even though it's the initial state. The above diagram doesn't allow a user to ever transition a case into this state and therefore there will never be a button with such a label. However, it's a required field just in case you change your business rules.
- We have decided not to use a BPA script to help a user work on a high-bill complaint when it's in this state (this is probably not the best decision as BPA scripts can be quite useful).
- We have associated the Add action with this status. This means that only users with rights to the add action for the application service defined on the case type can add cases of this type.
- Notice that Valid Next Statuses are what restricts a case in this state to be transitioned to the Canceled and Preliminary Investigation states.
- Notice that the Additional Processing plug-ins create and complete a To Do entry when a case enters and exits this state, respectively.

Preliminary Investigation High Bill Complaint

The following is an example of the configuration of the Preliminary Investigation status for high bill complaint cases.

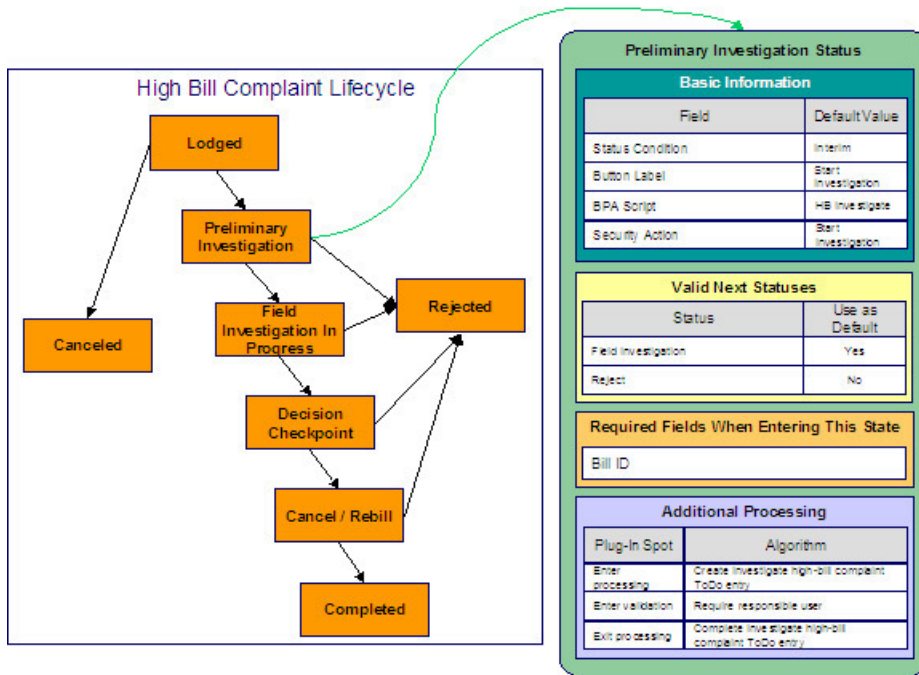

Note the following about this status:

- Preliminary Investigation is an interim state (meaning that it's not an initial or final state).
- It has a button label of **Start Investigation**. This is the label on the button that a user presses to move a case into this state. This button will only appear on cases that are in the Lodged state as this is the only state that can transition into the Preliminary Investigation state.
- We have decided not to specify a BPA script on this status. Rather, we're going to set up the To Do type used to highlight cases in this state to automatically launch an appropriate BPA script when a user selects the To Do entry.
- We have associated the Start Investigation action with this status. This means that only users with rights to this action for the application service defined on the case type can move a case into this state.
- Notice that Valid Next Statuses are what restricts a case in this state to be transitioned to the Field Investigation and Rejected states.
- Notice that a **Bill ID** must be specified on the case before it can be moved into this state.
- Notice that the Additional Processing plug-ins do the following:
 - Create and complete a To Do entry when a case enters and exits this state, respectively
 - Require a responsible user before a case can enter this state

Field Investigation High Bill Complaint

The following is an example of the configuration of the Field Investigation In Progress status for high bill complaint cases.

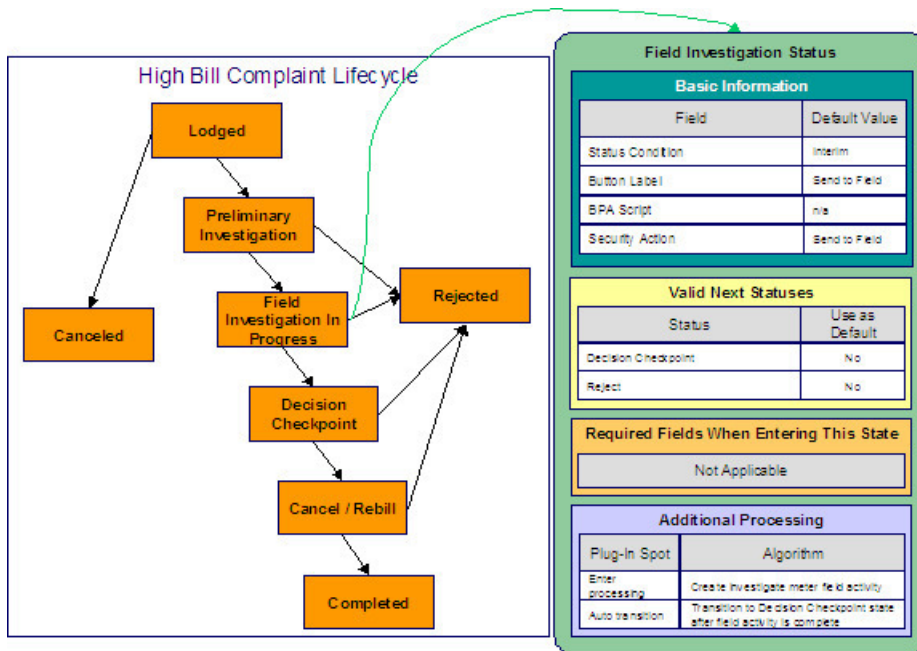

Note the following about this status:

- Field Investigation In Progress is an interim state (meaning that it's not an initial or final state).
- It has a button label of **Send to Field**. This is the label on the button that a user presses to move a case into this state. This button will only appear on cases that are in the Preliminary Investigation state as this is the only state that can transition into the Field Investigation in Progress state.
- We have decided not to specify a BPA script on this status because users don't work cases in this state (see the Additional Processing notes below for why this is the case).
- We have associated the Send to Field action with this status. This means that only users with rights to this action for the application service defined on the case type can move a case into this state.
- Notice that Valid Next Statuses are what restricts a case in this state to be transitioned to the Decision Checkpoint and Rejected states.
- Notice that the Additional Processing plug-ins do the following:
 - Create a field activity when a case enters this state
 - Cause the case to automatically transition to the Decision Checkpoint state when the field activity is completed

Decision Checkpoint High Bill Complaint

The following is an example of the configuration of the Decision Checkpoint status for high bill complaint cases.

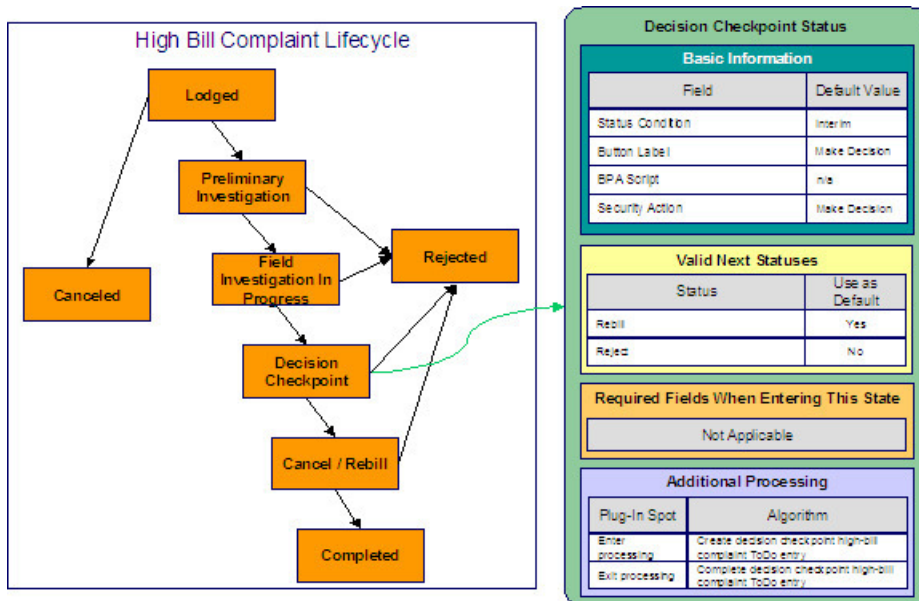

Note the following about this status:

- Decision Checkpoint is an interim state (meaning that it's not an initial or final state).
- It has a button label of **Make Decision**. This is the label on the button that a user presses to move a case into this state. This button will only appear on cases that are in the Field Investigation in Progress state as this is the only state that can transition into the Decision Checkpoint state.
- We have decided not to specify a BPA script on this status. Rather, we're going to set up the To Do type used to highlight cases in this state to automatically launch an appropriate BPA script when a user selects the To Do entry.
- We have associated the Make Decision action with this status. This means that only users with rights to this action for the application service defined on the case type can move a case into this state. Because the system will automatically transition cases into this state when the related field activity is complete, users will probably never press this button (and you may wish to prevent users from pressing this button by restricting security rights to the related action).
- Notice that Valid Next Statuses are what restricts a case in this state to be transitioned to the Cancel / Rebill and Rejected states.
- Notice that the Additional Processing plug-ins create and complete a To Do entry when a case enters and exits this state, respectively.

Cancel Rebill High Bill Complaint

The following is an example of the configuration of the Cancel / Rebill status for high bill complaint cases.

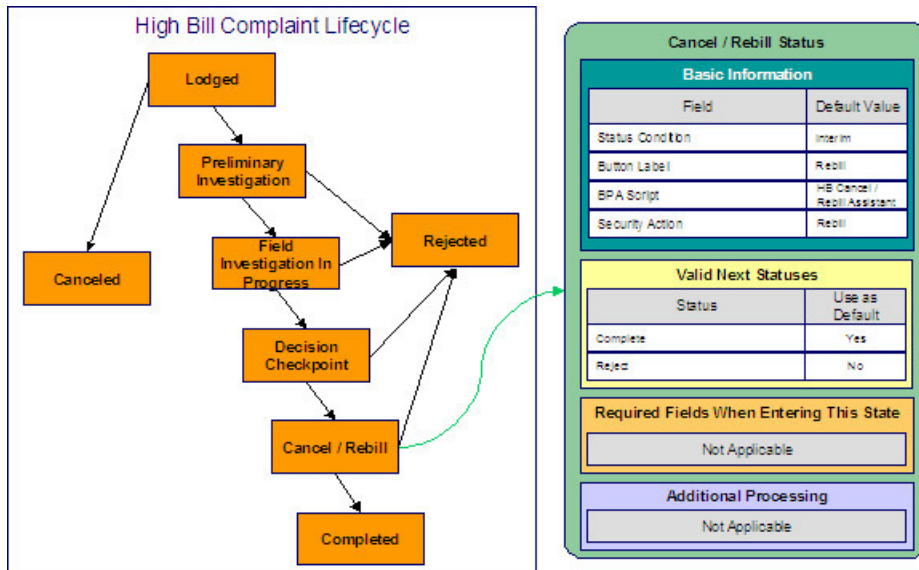

Note the following about this status:

- Cancel / Rebill is an interim state (meaning that it's not an initial or final state).
- It has a button label of **Cancel / Rebill**. This is the label on the button that a user presses to move a case into this state. This button will only appear on cases that are in the Decision Checkpoint state as this is the only state that can transition into the Cancel / Rebill state.
- We have referenced a BPA script that can assist a user in the cancel / rebill efforts.
- We have associated the Rebill action with this status. This means that only users with rights to this action for the application service defined on the case type can move a case into this state.
- Notice that Valid Next Statuses are what restricts a case in this state to be transitioned to the Completed and Rejected states.

Completed High Bill Complaint

The following is an example of the configuration of the Completed status for high bill complaint cases.

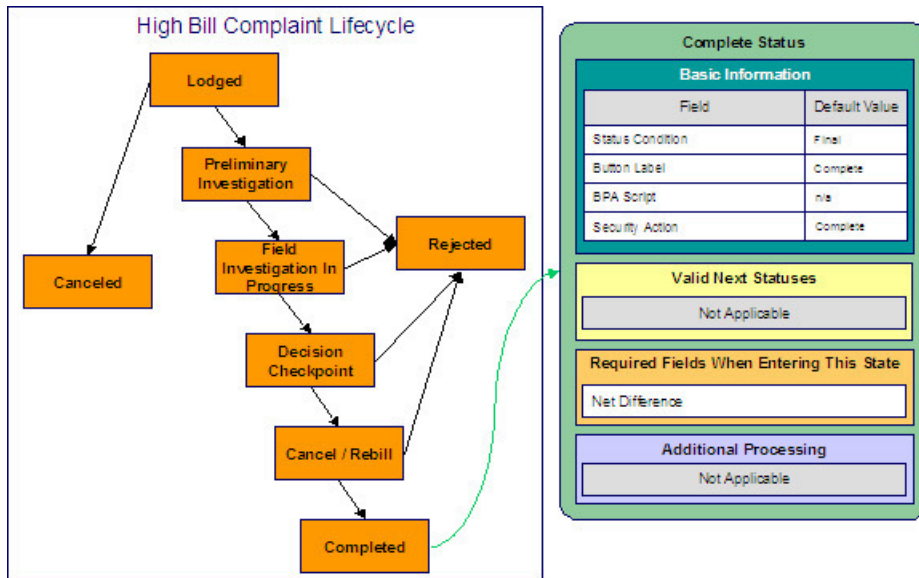

Note the following about this status:

- Completed is a final state (meaning that no further action is necessary).
- It has a button label of **Complete**. This is the label on the button that a user presses to move a case into this state. This button will only appear on cases that are in the Cancel / Rebill state as this is the only state that can transition into the Completed state.
- We have not referenced a BPA script because this is a final state (and no additional user action is necessary).
- We have associated the Complete action with this status. This means that only users with rights to this action for the application service defined on the case type can move a case into this state.
- Notice that there are no Valid Next Statuses (because this is a final state). If you wanted to allow a Completed case to be reopened, you would need to define the state into which a Completed case could be transitioned.
- Notice that the **Net Difference** must be specified on the case before it can be moved into this state. This would be the difference to the customer's balance after the cancel/rebill took place.

Rejected High Bill Complaint

The following is an example of the configuration of the Rejected status for high bill complaint cases.

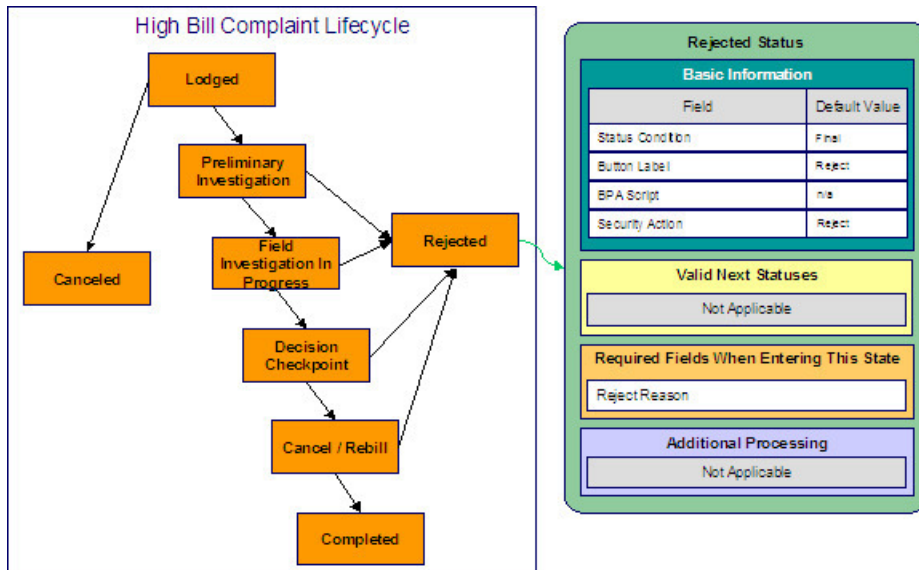

Note the following about this status:

- Rejected is a final state (meaning that no further action is necessary).
- It has a button label of **Reject**. This is the label on the button that a user presses to move a case into this state. This button will appear on cases that are in the Preliminary Investigation, Field Investigation in Progress , Decision Checkpoint and Cancel / Rebill states.
- We have not referenced a BPA script because this is a final state (and no additional user action is necessary).
- We have associated the Reject action with this status. This means that only users with rights to this action for the application service defined on the case type can move a case into this state.
- Notice that there are no Valid Next Statuses (because this is a final state). If you wanted to allow a Rejected case to be reopened, you would need to define the state into which a Rejected case could be transitioned.
- Notice that a **Reject Reason** must be specified on the case before it can be moved into this state.

Canceled High Bill Complaint

The following is an example of the configuration of the Canceled status for high bill complaint cases.

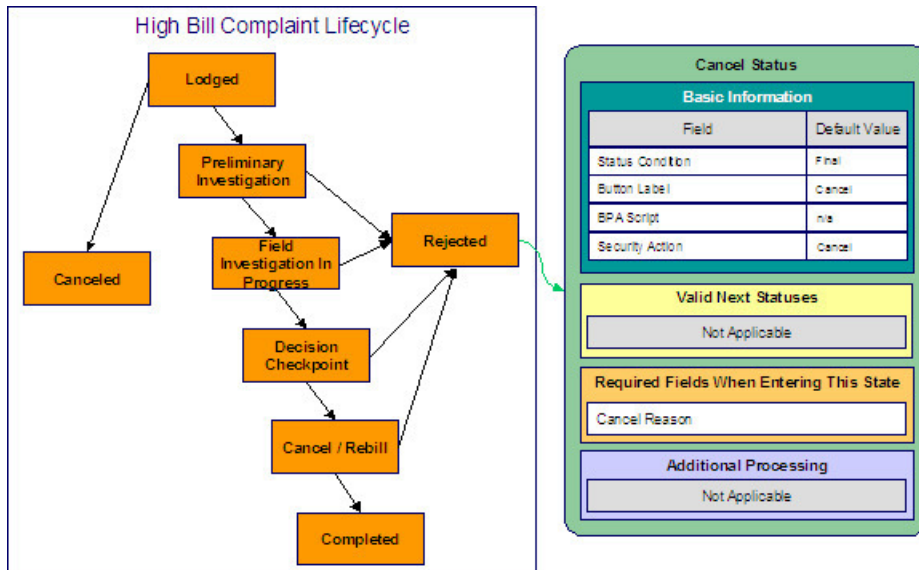

Note the following about this status:

- Canceled is a final state (meaning that no further action is necessary).
- It has a button label of **Cancel**. This is the label on the button that a user presses to move a case into this state. This button will only appear on cases that are in the Lodged state as this is the only state that can transition into the Completed state.
- We have not referenced a BPA script because this is a final state (and no additional user action is necessary).
- We have associated the Cancel action with this status. This means that only users with rights to this action for the application service defined on the case type can move a case into this state.
- Notice that there are no Valid Next Statuses (because this is a final state). If you wanted to allow a Canceled case to be reopened, you would need to define the state into which a Canceled case could be transitioned.
- Notice that a **Cancel Reason** must be specified on the case before it can be moved into this state.

Setting Up Case Management Options

The topics in this section describe how to set up the system to enable case management.

WARNING:

The following topics assume you thoroughly understand the concepts described under [The Big Picture Of Cases](#).

Installation Options

Case Info May Be Formatted By An Algorithm

An algorithm may be plugged in on the [installation record](#) to format the standard case information that appears throughout the system. Refer to CSIN-DFLT for an example of this algorithm.

This algorithm may be further overridden by a "Case information" plug-in on the [Case Type](#). Refer to C1-CT-INFO for an example of this algorithm.

Alert Info Is Controlled By An Installation Algorithm

An algorithm that is plugged in on the [installation record](#) is responsible for formatting the alerts that highlight if the person / account / premise in context has open cases. Refer to CCAL-CASE for an example of this algorithm.

Setting Up Application Services

As described under [Access Rights](#), you can prevent unauthorized users from accessing cases. The following points describe how to implement this type of security:

- Create an [application service](#) for each case type that needs to be secured
- Create an action on the application service for each status you need to secure
- Link the valid [user groups](#) to the application service and define which actions they can perform
- Define the application service on the [case type](#)
- Define the related action for each status on the [case type / status](#)

Setting Up Scripts

As described under [Scripts and Cases](#), BPA scripts can facilitate the creation and working of cases. Refer to the [Defining Script Options](#) for instructions describing how to set up scripts.

Setting Up To Do Types

As described under [To Do's and Cases](#), To Do entries can be used to highlight cases that require user attention.

The following points provide a high-level description of how to create (and complete) To Do entries for a case type:

- Create a To Do type for each different type of To Do entry used during a case's lifecycle
 - On the To Do type, think carefully about the roles whose users can work on the entries
 - Also consider if you would like a BPA script launched when a user selects the entry
- Specify the To Do type on the appropriate [entry processing](#) or [exit processing](#) algorithm
- If you want the system to automatically complete To Do entries, specify the To Do type on the appropriate [entry processing](#) or [exit processing](#) algorithm

Please be aware that the case maintenance transaction highlights the number of open and being worked To Do entries linked to the case being displayed on the page. However, the system can only do this if the To Do entries reference a [foreign-key characteristic](#) whose foreign key references the case table. If you use the CSEN-TD algorithm to create To Do entries when a case enters a given state, this algorithm will do this for you if:

- You have set up a [foreign-key characteristic type](#) whose [foreign key](#) references the case table
- In addition, the characteristic type must reference a characteristic entity of To Do Entry

Setting Up Characteristic Types

As described under [Additional Information](#), some of your cases may require additional information (in the form of [characteristics](#)). If this is true, you must set up the characteristic types before setting up the case types.

Refer to [Setting Up To Do Types](#) for instructions regarding a characteristic type that must be set up in order for the system to know the To Do entries that are associated with a case.

If you use the CSEN-CC algorithm to create customer contacts when a case enters a given state, you should set up a [foreign-key characteristic type](#) as follows:

- Its [foreign key](#) must reference the case table
- In addition, the characteristic type must reference a characteristic entity of Customer Contact

Setting Up Case Types

The case type maintenance transaction is used to maintain your case types. The topics in this section describe how to use this transaction.

FASTPATH:

Refer to [The Big Picture Of Cases](#) for more information about how a case type encapsulates the business rules that govern a case.

Case Type - Main

Use this page to define basic information about a case type.

Open the case type page by selecting **Admin > Customer > Case Type > Case Type > Add**.

NOTE:

Recommendation. Before using this transaction, we strongly recommend that you review the [Examples of Case Types](#).

Main Information

Enter a unique **Case Type** code and **Description** for the case type.

Use **Long Description** to provide a more detailed explanation of the purpose of the case type.

If your implementation requires restricting case types by CIS Division, specify a **CIS Division** on the case type.

Person Usage controls the applicability of a person on cases of this type. Select Required if a person must be defined on this type of case. Select Optional if a person can optionally be defined on this type of case. Select Not Allowed if a person is not allowed on this type of case.

Account Usage controls the applicability of an account on cases of this type. Select Required if an account must be defined on this type of case. Select Optional if an account can optionally be defined on this type of case. Select Not Allowed if an account is not allowed on this type of case.

Premise Usage controls the applicability of a premise on cases of this type. Select Required if a premise must be defined on this type of case. Select Optional if a premise can optionally be defined on this type of case. Select Not Allowed if a premise is not allowed on this type of case.

Entity Relationship controls the validation of relationships on cases of this type. *All* ensures that the account belongs to the person and that the account and premise are related. *Person and Account Only* disables the account and premise validation. *Premise and Account Only* disables the person and account validation. *None* disables all validation and allows any values. This setting only impacts the validation of values entered and works in conjunction with the three usage fields described above.

If you need to restrict access to cases of this type to specific user groups, reference the appropriate **Application Service**. Refer to [Setting Up Application Services](#) for the details of how to secure access to your cases.

If you are configuring a case type to handle the processing of data defined via a **Business Object**, associating the case type with a business object serves to link the properties of the business object (e.g. BO options) with cases of that type. Refer to [Business Objects](#) for further information. In addition, refer to [Automatic Transition Rules](#) for information on the role of BO options in case auto-transition errors.

Responsible User Usage controls the applicability of a responsible user on cases of this type. Select Required if a responsible user must be defined on this type of case. Select Optional if a responsible user can optionally be defined on this type of case. Select Not Allowed if a responsible user is not allowed on this type of case. Refer to [Responsible User Applicability](#) for more information.

Contact Information Fields

There are three contact information fields: **Contact Person & Method Usage**, **Contact Instructions Usage**, and **Case Phone Usage**. These fields are used to determine whether or not each type of contact information must be entered on case records with this case type. Select Required if the contact information must be entered, select Optional if the user can choose whether or not to include the contact information on this type of case, or select Not Allowed if the contact information cannot be entered on this type of case.

Algorithms

The **Algorithms** grid contains algorithms that control functions for cases of this type. You must define the following for each algorithm:

- Specify the **System Event** with which the algorithm is associated (see the table that follows for a description of all possible events).
- Specify the **Sequence Number** and **Algorithm** for each system event. You can set the **Sequence Number** to 10 unless you have a **System Event** that has multiple **Algorithms**. In this case, you need to tell the system the **Sequence** in which they should execute.

The following table describes each **System Event**.

System Event	Optional / Required	Description
Case Information	Optional	<p>We use the term "Case information" to describe the basic information that appears throughout the system to describe a case. The data that appears in "case information" is constructed using this algorithm.</p> <p>Plug an algorithm into this spot to override the "Case information" algorithm on installation options or the system default "Case information" if no such algorithm is defined on installation options.</p>

Case Type Tree

The tree summarizes the case type's lifecycle. You can use the hyperlinks to transfer you to the **Lifecycle** tab with the corresponding status displayed.

Case Type - Case Characteristics

To define characteristics that can be defined for cases of this type, open **Admin > Customer > Case Type > Search** and navigate to the **Case Characteristics** page.

Description of Page

Use **Sequence** to control the order in which characteristics are defaulted. Turn on the **Required** switch if the **Characteristic Type** must be defined on cases of this type. Turn on the **Default** switch to default the **Characteristic Type** when cases of this type are created. Enter a **Characteristic Value** to use as the default for a given **Characteristic Type** when the **Default** box is checked. Refer to [Required Fields Before A Case Enters A State](#) for a description of how you can make option characteristics required at later stages in a case's lifecycle.

Case Type - Lifecycle

Case types that involve multiple users and multiple potential outcomes have complex lifecycles. Before you can design a case type's lifecycle, it's important that you thoroughly understand the concepts described under [Lifecycle](#) and [Status-Specific Business Rules](#). After thoroughly understanding these concepts, we recommend you perform the following design steps:

- Draw a "state transition diagram" as illustrated above under [Lifecycle](#). Keep in mind that if your state transition diagram is complex, your cases will be complex. While some cases warrant complexity, you should always ask yourself if there aren't better ways to achieve the desired results if your first effort results in complexity.
- Determine which characteristics (if any) are required during each stage of a case's lifecycle
- Determine when To Do entries (if any) should be created (and completed) during a case's lifecycle
- Determine additional validation (if any) that should be executed before a case enters and exits each state
- Determine additional processing (if any) that should transpire when a case enters or exits each state
- Determine if scripts are warranted to help users work the cases and, if so, design the scripts for each applicable state

When the above tasks are complete, you will be ready to set up a case type's lifecycle.

Open the Lifecycle page by selecting **Admin > Case Type > Case Type > Search** and navigate to the **Lifecycle** page.

NOTE:

You can navigate to a status by clicking on the respective node in the tree on the Main tab. You can also use the hyperlinks in the Next Statuses grid to display a specific status in the accordion.

Main Information

The **Status** accordion contains an entry for every status in the case type's [lifecycle](#).

Use **Status** to define the unique identifier of the status. This is NOT the status's description, it is simply the unique identifier used by the system.

Use **Description** to define the label that appears on the lifecycle accordion as well as the status displayed on the case.

Use **Script** to reference a BPA script that can assist a user work on a case while it's in this status. Refer to [A Script That Helps A User Work Through A Case](#) for the details.

Use **Access Mode** to define the action associated with this status. This field is disabled if an application service is not specified on the Main page. Refer to [Access Rights](#) for the details of how to use this field to restrict which users can transition a case into this state.

Use **Batch** to specify a batch control that will auto-transition the case. Any case in a status configured with a batch control will be transitioned when the batch job runs (rather than when CASETRAN is executed). For this purpose, batch process C1-CSTRS (**Case Scheduled Transition**) is supplied with base package, which will execute all Exit Status logic for the current status, and Enter Status logic for the destination status. You may choose to create a batch process with your own transition logic.

NOTE:

If you wish to defer transitioning a case in a particular status until the batch process on your case type status is executed, you should not populate an Auto-Transition algorithm on that status. Otherwise, CASETRAN will transition the case according to your Auto-Transition logic.

Use **Comment** to describe the status. This is for your internal documentation requirements.

Use **Sequence** to define the relative order of this status in the tree on the Main page.

Use **Status Condition** to define if this status is an Initial, Interim or Final state. Refer to [One Initial State and Multiple Final States](#) for more information about how this field is used.

Use **Transitory State** to indicate whether a case should ever exist in this state. Only Initial or Interim states can have a transitory state value of No.

The **Alert Flag** is used to indicate whether or not an alert should be displayed for customers with cases in the state. (The alert is shown via the base package Installation - Alert algorithm.)

Algorithms

The **Algorithms** grid contains algorithms that control important functions for cases of this type. You must define the following for each algorithm:

- Specify the **System Event** with which the algorithm is associated (see the table that follows for a description of all possible events).
- Specify the **Sequence Number** and **Algorithm** for each system event. You can set the **Sequence Number** to 10 unless you have a **System Event** that has multiple **Algorithms**. In this case, you need to tell the system the **Sequence** in which they should execute.

The following table describes each **System Event** (note, all system event's are optional and you can define an unlimited number of algorithms for each event).

System Event	Description
Auto Transition	This algorithm is executed to determine if a case that's in this state should be transitioned into another state. Refer to Automatic Transition Rules for the details.
Enter Processing	This algorithm holds additional processing that is executed when a case is transitioned into this state. You can also specify state transition logic within Enter Processing routines. Refer to Additional Processing When Entering A State for the details.
Enter Validation	This algorithm holds validation logic that executes before a case can enter a given state. Refer to Validation Before A Case Enters A State for the details.
Exit Processing	This algorithm holds additional processing that is executed when a case is transitioned out of this state. Refer to Additional Processing When Exiting A State for the details.
Exit Validation	This algorithm holds validation logic that executes before a case can be transitioned out of a given state. Refer to Validation Before A Case Exits A State for the details.

Next Statuses

Use the **Next Statuses** grid to define the statuses a user can transition a case into while it's in this state. Refer to [Valid States versus State Transition Rules](#) for more information. Please note the following about this grid:

- Use **Action Label** to indicate the verbiage to display on the action button used to transition to this status.
- **Sequence** controls the order of the buttons that appear on [Case - Main](#). Refer to [Buttons Are Used To Transition A Case Into A State](#) for more information.
- **Use as Default** controls which button (if any) is the default button.
- **Transition Condition** may be configured to identify a common transition path for cases of this type in the current state. This transition condition may then be referenced across multiple case types. You'll need to add values to Look Up table field **TR_COND_FLG** that fit the typical transitions for your case types (e.g. Ok, Error, etc.).

By assigning the transition condition value to a given "next status", you can design your Enter State transition or Auto-Transition logic to utilize those flag values *without specifying a status particular to a given case type*. Thus, similar logic may be used across a range of case types to transition a case into, for example, the next Ok state for the case's current status.

- **Transition Role** controls whether only the System or both System and User have the ability to transition a case into a given "next status".
- You can use the status description hyperlink to open the Status accordion to the respective status.
- When you initially set up a case type, none of the statuses will reside on the database and therefore you can't use the search to define a "next status". We recommend working as follows to facilitate the definition of this information:
 - Leave the Next Statuses grid blank when you initially define a case type's statuses
 - After all statuses have been saved on the database, update each status to define its Next Statuses (this way, you can use the search to select the status).

Required Characteristics

Use the **Required Characteristics** grid to define characteristics that are required when a case enters this state. Only Optional characteristics defined on the main page appear in this grid. Refer to [Required Fields Before A Case Enters A State](#) for more information.

Defining Umbrella Agreement Options

Your organization may use umbrella agreement functionality to manage many situations, including (but not limited to) the following:

- Creating a "negotiated contract" with a large customer with many sites.
- Creating a "negotiated contract" with all customers in a common geographic area, for example a specific city or an apartment complex
- Grouping and managing the proposal service agreements created during the quoting process
- Managing the renewal process for special contracts
- Applying override rate terms to one or more service agreements for a given effective period
- more...

NOTE:

Separately module. The umbrella agreement functionality is part of the Contract Management module. If this module is not applicable to your business you may turn it off. Refer to [Turn Off A Function Module](#) for more information.

The Big Picture Of Umbrella Agreements

The topics in this section provide background information about how to configure the system to support your umbrella agreement requirements.

Renewable Umbrella Agreements

When defining your umbrella agreement types, you must determine if umbrella agreements of this type are renewable. If so, you must set the renewal flag on the UA type to Renewable and determine the number of days prior to the end date of the umbrella agreement that the renewal process should start.

In addition, you must decide on your renewal procedure and design an appropriate renewal [algorithm](#). You may use one of the sample renewal algorithms provided by the system.

- The sample algorithm URNW-TD creates a To Do entry. Using this algorithm you can direct the To Do entry to an appropriate role to determine if the umbrella agreement should be renewed. If the umbrella agreement is associated with an account management group, the To Do entry could be assigned to a role defined for that AMG.
- The sample algorithm URNW-CA creates a [case](#). Using this algorithm you can create an appropriate case to help track the steps required for renewing an umbrella agreement.

If the base algorithms do not provide the logic your organization needs, you may create a new algorithm.

NOTE:

It is the responsibility of the renewal algorithm to change the renewal date as per the business requirements. If renewal requires manual review, the algorithm should reset the date to blank. If the algorithm can determine a new renewal date, the date should be changed to the appropriate value.

Terms Of Service Covered Entities

For each terms of service type you design, consider whether or not a TOS created for this type should reference one or more entities in the system that are "covered" by the terms of service. Following are some examples of covered entities:

- A special contract is created for all the McDonalds franchises in your service area. When creating the terms of service record for the umbrella agreement used for this contract, you want the user to link the person record representing the McDonalds corporate entity as a covered entity for the TOS.
- An umbrella agreement is created for a large customer with several types of services. Perhaps you want to group the services in the contract based on type of service. The service type may be set up as a covered entity.

The covered entities could also be used to denote eligibility. Refer to [Linking To A UA For A Group Of Premises](#) for an example of using the covered entity collection for eligibility.

The covered entities are actually characteristics. You must define the desired characteristic types if they do not already exist. In this case, they would be foreign key characteristic types. The characteristic types that you want to use must reference a characteristic entity of TOS covered entity.

A terms of service record may only reference covered entity types that you designate on the Terms of Service type record. When designing the covered entities that are allowed for TOS records of a given type, you may also configure the Terms of Service type to indicate that one or more covered entity types are required.

Refer to [Terms Of Service Type - Main](#) for more information.

Overriding Rate Terms

If your organization has business rules that require a service agreement's rate terms to be overridden, you can accomplish this using umbrella agreements and terms of service records. There are two levels of overriding that are possible:

- Override rate schedule
- Override other terms on the rate, including contract riders, contract terms and tax exemptions

To override any rate terms, the service agreement must be linked to a terms of service record that references a template service agreement. In addition, you must configure settings in the system to indicate whether or not overriding of terms is allowed.

- The [SA type](#) for the customer's service agreement indicates whether or not the rate schedule may be overridden using the rate source flag.
 - If the rate source value is Check TOS First, then SA, when applying the rate, the system determines if the SA is linked to a TOS effective at the time of the bill with a template SA. If so, the rate schedule on the template SA is used.
 - If the rate source value is Check SA Only, when applying the rate, the always uses the rate schedule on the customer's SA (regardless of whether or not the SA is linked to a TOS effective at the time of the bill with a template SA).
- If any bill factor on one of calculation rule indicates that it is eligible for tax exemptions, contract terms or contract riders, the terms of service usage flag on the bill factor indicates where the system should look for the appropriate value. The flag tells the system to find applicable information either on the TOS's template SA only, on the customer's SA only or it should first check the TOS, then check the customer's SA.

The following table illustrates the different scenarios possible when configuring your bill factors and the resulting behavior. The term "standard behavior" in the tables below indicate that the standard behavior as described in [Defining Bill Factors](#) is followed.

	TOS Usage	Template SA	Customer SA	BF Char Source
Contract Rider Applicability is checked	Check TOS First, then SA	Found	Not checked	If source = SA, the template SA's characteristic collection is checked. If source <> SA, the standard behavior is followed.
		Not Found	Found	If source = SA, the customer SA's characteristic collection is checked. If source <> SA, the standard behavior is followed
		Not Found	Not Found	N/A
	Check TOS Only	Found	Not checked	If source = SA, the template SA's characteristic collection is checked. If source <> SA,

		Not Found	Not checked	the standard behavior is followed	
Check SA Only		Not checked	Standard behavior	N/A	
TOS Usage	Template SA	Customer SA	BF Value Source	BF Char Source	
Value in Contract Term is checked	Check TOS First, then SA	Found	Not checked	Template SA	N/A
		Not Found	Found	Customer SA	N/A
		Not Found	Not Found	Bill Factor Value (based on Char Source)	If source = SA, the template SA's characteristic collection is checked. If source <> SA, the standard behavior is followed
Check TOS Only	Found	Not checked	Template SA	N/A	
	Not Found	Not checked	Bill Factor Value (based on Char Source)	If source = SA, the template SA's characteristic collection is checked. If source <> SA, the standard behavior is followed	
Check SA Only		Not checked	Standard behavior		
TOS Usage	Template SA	Customer SA	BF Value Source		
Tax Exemption is checked	Check TOS First, then SA	Found	Not checked	Template SA	
		Not Found	Found	Customer SA	
		Not Found	Not Found	No value	
	Check TOS Only	Found	Not checked	Template SA	
		Not Found	Not checked	No value	
Check SA Only		Not checked	Standard behavior		

Note that [proration](#) logic is followed for the above functionality as expected. For example, imagine that a bill factor with Value in Contract Terms is prorable and the TOS usage value is Check TOS First, then SA. If the template SA has a contract value that is only in effect for the first 10 days of a bill, that value is used for the first 10 days and the remaining days in the bill take the value from the SA (if applicable) or the bill factor value as per the table rules above.

NOTE:

When designing your terms of service type, you must indicate whether a template service agreement is optional, required or not allowed. When the template SA is required, the user setting up the TOS record for this TOS type must link the correct service agreement as the template SA. If a new template service agreement is required, the new SA must be created first.

Setting Up Umbrella Agreement Options

The topics in this section describe how to set up umbrella agreement options.

Configure SA Types for Umbrella Agreements

For each type of service agreement that may be linked to a terms of service record, you must configure the Rate Source for the [SA type](#) to indicate if the rate should always be taken from the service agreement ([Check SA Only](#)) or if the rate should be taken from the terms of service record for the service agreement, if any ([Check TOS First, then SA](#)).

FASTPATH:

Refer to [Overriding Rate Terms](#) for more information.

NOTE:

The rate source is only visible on SA type if the Contract Management module is not [turned off](#).

Configure Bill Factors for Umbrella Agreements

For each bill factor that has a value in contract term, contract rider applicability or tax exemption applicability, you must indicate where the system should look for a value when a service agreement is linked to a terms of service with a template SA and where this bill factor is referenced by the rate being applied. Using the terms of service usage flag, tell the system to [Check TOS Only](#), [Check SA Only](#) or [Check TOS First, then SA](#).

FASTPATH:

Refer to [Overriding Rate Terms](#) for more information.

NOTE:

The terms of service usage flag is only visible on bill factor if the Contract Management module is not [turned off](#).

Configure A Campaign To Link An SA To A Terms Of Service

The system provides a pair of column reference algorithm types that support linking a new service agreement to an existing terms of service record via an [order](#). The pair includes a validation algorithm type CRVL-SATOS and a posting algorithm type CRPS-SATOS.

In order to take advantage of this functionality, you must:

- Create an algorithm for each of the above algorithm types. Only one algorithm is needed for each algorithm type because there are no parameters for either one.
- Setup a unique [column reference](#) for the terms of service ID column reference code and plug in the new validation and posting algorithms on the record.

- For campaigns whose orders link a new service agreement to an existing umbrella agreement, make sure to define a [miscellaneous field](#) for the terms of service ID. Note, the miscellaneous field must reference the column reference that you setup above.

Based on your business practice, you may want to further configure your campaign / package for linking a service agreement to an existing terms of service. Refer to [Linking A Service Agreement To A TOS Through Orders](#) for more information.

Setting Up Umbrella Agreement Types

The umbrella agreement type transaction is used to maintain your UA types. The topics in this section describe how to use this transaction.

Umbrella Agreement Type - Main

Open **Admin > Umbrella Agreement > Umbrella Agreement Type > Add** to define basic information about an umbrella agreement type.

Description of Page

Enter a unique **Umbrella Agreement Type** code and **Description** for the UA type.

Use **Renewal** to indicate whether an umbrella agreement of this type is Renewable or Not Renewable. For renewable UA types, indicate the **Renewal Days Before Expiration**. The renewal date for umbrella agreements of this type are calculated based on this number of days before the end date.

Use the characteristics collection to define characteristics that can be defined for umbrella agreements of a given type. Use **Sequence** to control the order in which characteristics are defaulted. Turn on the **Required** switch if the **Characteristic Type** must be defined on umbrella agreements of a given type. Turn on the **Default** switch to default the **Characteristic Type** when umbrella agreements of the given type are created. Enter a **Characteristic Value** to use as the default for a given **Characteristic Type** when the **Default** switch is turned on.

NOTE:

Characteristic Types. You can only choose characteristic types defined as permissible on an umbrella agreement record. Refer to [Setting Up Characteristic Types & Their Values](#) for more information.

Enter the valid **Terms of Service Types** that may be referenced for umbrella agreements of this type.

Umbrella Agreement Type - Algorithms

Open **Admin > Umbrella Agreement > Umbrella Agreement Type > Search** and navigate to the **Algorithms** page.

Description of Page

The grid contains **Algorithms** that control important functions in the system. You must define the following for each algorithm:

- Specify the **System Event** with which the algorithm is associated (descriptions of all possible events are provided below).
- Specify the **Sequence** and **Algorithm** for each system event. You can set the **Sequence** to 10 unless you have a **System Event** that has multiple **Algorithms**. In this case, you need to tell the system the **Sequence** in which they should execute.

The following table describes each **System Event** for which you can define algorithms.

System Event	Description
UA Renewal	Algorithms of this type are executed by the UARENEW background process when an umbrella agreement has reached its renewal date. Only one renewal algorithm is allowed for a given UA type.

Setting Up Terms Of Service Types

The terms of service type transaction is used to maintain your Terms of Service types. The topics in this section describe how to use this transaction.

Terms Of Service Type - Main

Open **Admin** > **Umbrella Agreement** > **Terms of Service Type** > **Add** to define basic information about terms of service types.

Description of Page

Enter a unique **Terms of Service Type** code and **Description** for the TOS type.

Use **Template SA Usage** to indicate whether a template SA is Optional, Required or Not Allowed. Refer to [Overriding Rate Terms](#) for more information about using template SAs.

Use the characteristics collection to define characteristics that can be defined for terms of service records of a given type. Use **Sequence** to control the order in which characteristics are defaulted. Turn on the **Required** switch if the **Characteristic Type** must be defined on terms of service records of a given type. Turn on the **Default** switch to default the **Characteristic Type** when terms of service records of the given type are created. Enter a **Characteristic Value** to use as the default for a given **Characteristic Type** when the **Default** switch is turned on.

NOTE:

Characteristic Types. You can only choose characteristic types defined as permissible on a terms of service record. Refer to [Setting Up Characteristic Types & Their Values](#) for more information.

Use the **Covered Entities** collection to define the types of entities that are "covered" by terms of service records of this type. Refer to [Terms Of Service Covered Entities](#) for more information

NOTE:

Characteristic Types. You can only choose characteristic types defined as permissible for TOS covered entity. Refer to [Setting Up Characteristic Types & Their Values](#) for more information.

Terms Of Service Type - UA Types

Open **Admin** > **Umbrella Agreement** > **Terms of Service Type** > **Add** and navigate to the **UA Types** page.

Description of Page

Enter the valid **Umbrella Agreement Types** that may reference this terms of service type.

Setting Up Terms of Service Cancel Reasons

Whenever a terms of service record is canceled, a cancel reason must be specified. Open **Admin > Terms of Service Cancel Reason** to specify such cancellation reasons.

Description of Page

Enter an easily recognizable **Terms of Service Cancel Reason** and **Description** for the terms of service cancellation reason.

Umbrella Agreements Configuration Examples

This section provides examples of how you would configure the system to support various business scenarios.

Linking A Service Agreement To A TOS Through Orders

As described in [Configure A Campaign To Link An SA To A Terms Of Service](#), the system has provided a pair of column reference algorithms to enable your users to link a new service agreement to an existing terms of service record (and its umbrella agreement) when starting service via the order transaction.

When designing your campaign and packages to use this option, consider the scenarios where you may use this to determine whether or not you require additional configuration. The following topics describe some possible scenarios.

Linking To A UA For A Given Account

Imagine that you would use this logic when an important customer is starting additional service and has an existing umbrella agreement for other services that the new service should be added to. The user creating the order is probably the account manager for that account and would know the correct terms of service record to link the new service to.

For this scenario, you do not need to provide any "help" to the user to indicate that linking to a TOS is an option or to help select the correct TOS. You simply need to ensure that the campaign that would be used by this account manager to start service for the important customer simply includes a question / miscellaneous field to [link the SA to the terms of service](#).

Linking To A UA For A Group Of Premises

Imagine you have created an umbrella agreement for a group of premises that are not actively managed by a specific user. For example, perhaps there are several apartment complexes that have negotiated a special rate with your company. When new customers sign up for service at a premise that belongs to one of these apartments, the user should be informed that there is a special contract for this premise. The user may also need help selecting the correct terms of service record. To accomplish this logic, you must define additional algorithms to help your users.

For example, perhaps your standard campaign for residential electric customers includes a package to be used by premises linked to one of these apartment buildings and should only be eligible to one of those premises. You must create an eligibility algorithm for this package. Its logic could be designed based on the following assumptions:

- The qualifying premises are linked to a parent premise
- The parent premise is linked to the appropriate terms of service record in its covered entity collection

The eligibility algorithm checks to see if the order's premise is linked to a parent premise that is referenced on a terms of service record for an umbrella agreement that is currently in effect. It could also be restricted to search for a specific umbrella agreement type or terms of service type if appropriate.

NOTE:

The campaign for this scenario must include a question / miscellaneous field to [link the SA to the terms of service](#). It should be configured with an applicability of only applicable on package. The package that is used to include the SA into the terms of service for the apartment complex would include this question / miscellaneous field.

Once the user chooses this package, user is prompted to provide the correct terms of service record via the question / miscellaneous field. To help the user, you should create a column reference retrieval algorithm to default the correct terms of service record for this premise. It would use the same logic as the eligibility algorithm described above. In other words, it would find the parent premise for this premise and then find the terms of service record covered entity collection includes this parent premise and whose umbrella agreement is currently in effect.

Reports Addendum

This chapter is an addendum to the general [Defining and Designing Reports](#) chapter.

Configuring the System to Invoke Oracle BI Publisher Enterprise Real-Time

In order to invoke Oracle BI Publisher Enterprise from within the system, it must be configured. This topic describes the steps at a high level that are required to configure your system to enable BI Publisher..

Specify Reporting Tool Options

The following information should be defined on Reporting Tool Options table:

- **Reporting Server** is the web server URL where the reporting tool is installed.
- **Reporting Folder** defines the name of the directory on the Oracle BI Publisher server where reports are located. The system's reporting tool algorithm constructs the URL to open Oracle BI Publisher Enterprise based on the information provided on Reporting Options. The same folder name should be used as a report folder in Oracle BI Publisher Enterprise where reports are published.

Reporting Tool Algorithm

The base product provides an installation algorithm plug-in spot called Reporting Tool. This plug-in spot should contain an algorithm that invokes the reporting tool real-time. The corresponding algorithm type, called algorithm reference: F1-BIPR-INV, invokes Oracle BI Publisher Enterprise.

This algorithm relies on information defined in the Reporting Options table: the reporting server and folder names for accessing the reporting tool. The algorithm constructs several strings, for example, the URL of the BI Publisher, information about the report being requested and user info in the format expected by Oracle BI Publisher Enterprise. The Java program returns the correct URL to the browser. The browser then opens a BI Publisher Enterprise window with the appropriate URL.

To use the algorithm reference: F1-BIPR-INV algorithm type to invoke Oracle BI Publisher Enterprise, perform the following steps:

1. Create an algorithm for this algorithm type.
2. In the installation options, add an entry to the algorithm collection with an algorithm entity of Reporting Tool and indicate the algorithm created in the previous step.

Interface with Oracle BI Publisher Enterprise Batch Scheduler

Presently the base product does not provide support for batch jobs with Oracle BI Publisher. Please use Oracle BI Publisher directly in order to schedule reports to run in batch.

Configuring the System for Batch Bill Print

This section describes the steps for configuring the applications to print bills in batch.

Configure Oracle BI Publisher for Batch Bill Print

1. Configure the Oracle BI Publisher Scheduler to allow report job submission.

NOTE:

Refer to the Oracle Fusion Middleware Administrator's Guide for Oracle Business Intelligence Publisher for more information.

2. Ensure that the CI_BILLPR report artifacts (CI_BILLPR.rtf, CI_BILLPR.xdo, CI_BILLPR.xdm) are deployed to corresponding BI Publisher catalog folder:

Configure Oracle Utilities Customer Care and Billing for Batch Bill Print

1. Go to **Admin > Reporting > Reporting Options** and configure the following values:
 - **Reporting Server from Browser** should point to the correct BI Publisher Server URL; for example, `http://<hostname>:port`
 - **Reporting Folder** is the name as the Catalog Folder in BI Publisher where CI_BILLPR is located; for example, CCB
 - **Reporting Engine User ID** is the BI Publisher User ID.
 - **Reporting Engine Password** is the BI Publisher Password.
2. Create a custom Bill Route Type Extract Algorithm using the C1-BLEX-BIP Algorithm Type. Ensure that the following algorithm soft parameters are set:
 - **Output Directory** is the directory in BI Publisher server where the generated output files will be placed, for example, `/tmp/`
 - **Report Absolute Path** is the path where CI_BILLPR.xdo is located in the BI Publisher Catalog, for example, `/CCB/CI_BILLPR/CI_BILLPR.xdo`

- **Report Format** is the format of the generated output files; for example, pdf
- **Report Code** is the CI_BILLPR report code; for example, CI_BILLPR

3. **Go to Admin Menu, B, Bill Route Type** and configure the corresponding Bill Route Type (such as, POSTAL) to use the RTTYPOST Batch Control and the custom Bill Route Type Extract Algorithm.

Description of Sample Reports

This section provides an overview of each sample report supplied with Oracle Utilities Customer Care and Billing that may be found in the demonstration database. They may be used by your organization as they are or as a starting point for creating a [new report](#).

NOTE:

Account Security. The sample reports provided with the product do NOT incorporate account security. If a user has been given security to view the report, then all the data in the report is available for viewing.

Active Severance Processes - CI_ACSVPR

Parameters

Parameter	Parameter Code	Description
Start Date	P_FROM_DT	Start date to use for reporting severance processes. If not defined, start date is set to 1900-01-01.
End Date	P_TO_DT	End date to use for reporting active severance processes. If not defined to date is set to the current date.

Report Description

This report is used to aid in the monitoring of active severance processes. The report details are used to review how the company is doing as far as the collection of outstanding debt, as well as to monitor the progress of currently active severance processes.

The report selects active severance processes whose creation date is between the input start and end dates.

Bill Print in BI Publisher - CI_BILLPR

Parameters

Parameter	Parameter Code	Description
CC&B user	P_USER_ID	No default value. Required. Returns an error message if user ID is null, empty or does not exist in database.
Batch Switch	P_BATCH_SW	For a single bill print, Batch Switch is 'No' and for multiple bill print, Batch Switch is 'Yes'.

First Bill	P_FROM_BILL_ID	First Bill Id to print for the Bill Range.
Last Bill	P_TO_BILL_ID	Last Bill Id to print for the Bill Range.
Batch Code	P_BATCH_CD	Passed in by the system the report is submitted in batch. Only bills with a Bill Routing that references this batch code are selected.
Batch Number	P_BATCH_NBR	Passed in by the system the report is submitted in batch. Only bills with a Bill Routing that references this batch number are selected.
Extract Algorithm	P_EXTRACT_ALG	Passed in by the system the report is submitted in batch. Only bills with a Bill Routing whose bill route type references this extract algorithm are selected.

Report Description

This report is used with BI Publisher to display all the information that appears on the customer's printed bill for the bill ID entered in the input parameters. Refer to the description of the parameters above. The bill is only displayed if the bill is complete.

See below for details of the information extracted for the report. In addition, the sample report layout provided for the base product includes:

- Payment coupon.
- Form for change of address.
- A graph of consumption for current charges.

The following sections highlight the data that is extracted for this report.

Bill Information

Field Name	Format	Source/Value/Description
SORT_KEY	A12	Primary sort for the report - currently sorted by Bill Id
BILL_ID	A12	CI_BILL
SEQNO	N5	CI_BILL_ROUTING
PER_ID	A10	CI_BILL_ROUTING
NBR_BILL_COPIES	N1	CI_BILL_ROUTING
ENTITY_NAME1	A64	CI_BILL_ROUTING. Mailing Entity Name 1.
ENTITY_NAME2	A64	CI_BILL_ROUTING. Mailing Entity Name 2.
ENTITY_NAME3	A64	CI_BILL_ROUTING. Mailing Entity Name 3.
COUNTRY	A3	CI_BILL_ROUTING
ADDRESS1	A254	CI_BILL_ROUTING
ADDRESS2	A254	CI_BILL_ROUTING
ADDRESS3	A254	CI_BILL_ROUTING
ADDRESS4	A254	CI_BILL_ROUTING

CITY	A30	CI_BILL_ROUTING
COUNTY	A30	CI_BILL_ROUTING
STATE	A6	CI_BILL_ROUTING
POSTAL	A12	CI_BILL_ROUTING
IN_CITY_LIMIT	A1	CI_BILL_ROUTING
BATCH_CD	A8	CI_BILL_ROUTING
BATCH_NBR	N10	CI_BILL_ROUTING
NO_BATCH_PRT_SW	A1	CI_BILL_ROUTING
ACCT_ID	A10	CI_BILL
BILL_STAT_FLG	A2	CI_BILL
BILL_DT	Date	CI_BILL
DUE_DT	Date	CI_BILL
ACCT_ENTITY_NAME	A64	Get Main Person from CI_PER_NAME. Account Entity Name
LANGUAGE_CD	A3	Person's Language from CI_PER
CURRENCY_CD	A3	CI_ACCT
CUR_SYMBOL	A4	CI_CURRENCY_CD
DECIMAL_POSITIONS	N1	CI_CURRENCY_CD
CUR_POS_FLG	A2	CI_CURRENCY_CD
OPEN_ITEM_SW	A1	CI_CUST_CL
BILL_COPY	A1	Bill copy number

Bill Segment Information

Field Name	Format	Source/Value/Description
BSEG_ID	A12	CI_BSEG
SA_ID	A10	CI_BSEG
START_DT	Date	CI_BSEG
END_DT	Date	CI_BSEG
BILL_CYC_CD	A4	CI_BSEG
WIN_START_DT	Date	CI_BSEG
EST_SW	A1	CI_BSEG
CLOSING_BSEG_SW	A1	CI_BSEG
PREM_ID	A10	CI_BSEG
CIS_DIVISION	A5	CI_SA
SA_TYPE_CD	A8	CI_SA
SAT_DESCR	A60	CI_SA_TYPE_L
BILL_PRT_PRIO_FLG	A2	CI_SA_TYPE

GRAPH_UOM_CD	A4	CI_SA_TYPE
HEADER_SEQ	N3	CI_BSEG_CALC
BCALC_START_DT	Date	CI_BSEG_CALC
BCALC_END_DT	Date	CI_BSEG_CALC
RS_CD	A8	CI_BSEG_CALC
EFFDT	Date	CI_BSEG_CALC
BILLABLE_CHG_ID	A12	CI_BSEG_CALC
CALC_AMT	N15.2	CI_BSEG_CALC
BCALC_DESC_BILL	A80	CI_BSEG_CALC
SEQNO	N5	CI_BSEG_CALC_LN
PRT_SW	A1	CI_BSEG_CALC_LN
APP_IN_SUMM_SW	A1	CI_BSEG_CALC_LN
CALC_LN_AMT	N15.2	CI_BSEG_CALC_LN
DST_ID	A10	CI_BSEG_CALC_LN
MSR_PEAK_QTY_SW	A1	CI_BSEG_CALC_LN
DESCR_LN	A80	CI_BSEG_CALC_LN
STATE	A6	CI_PREM
CITY	A30	CI_PREM
POSTAL	A12	CI_PREM
SIBLING_ID	A12	CI_FT

Account Summary Information

Field Name	Format	Source/Value/Description
CURRENCY_CD	A3	Derived from CI_BILL_SA or CI_FT.
SUM_CUR_AMT	S15.2	Get Bill's Current Balance from CI_BILL_SA Bill's Current Charge from CI_FT Bill's Current Correction Charge from CI_FT Bill's Current Adjustment from CI_FT Bill's Current Payment from CI_FT
SUM_TOT_AMT	S15.2	Get Bill's Total Balance from CI_BILL_SA Bill's Total Charge from CI_FT Bill's Total Correction Charge from CI_FT Bill's Total Adjustment from CI_FT Bill's Total Payment from CI_FT
BILL_PRT_FLG	A4	Set as follows: ASBL - Indicator for Bill's Balance from CI_BILL_SA

ASBS - Indicator for Bill's Current Charge from CI_FT

ASBC - Indicator for Bill's Correction from CI_FT

ASAD - Indicator for Bill's Adjustment from CI_FT

ASPS - Indicator for Bill's Payment from CI_FT

Current Charge Information

Field Name	Format	Source/Value/Description
SUM_CUR_AMT	S15.2	Derived from CI_FT (Only the current charge bill segments.)
SUM_TOT_AMT	S15.2	Derived from CI_FT (Only the current charge bill segments.)
CURRENCY_CD	A3	CI_BILL_SA or CI_FT
DEBT_CL_CD	A4	Debt Class of SA Type
DESCR	A60	Debt Class Description

Premise Information

One record for every premise linked to the bill.

Field Name	Format	Source/Value/Description
PREM_ID	A10	Premise Id obtained from Bill Segment
PREM_TYPE_CD	A8	CI_PREM
LL_ID	A10	CI_PREM
MAIL_ADDR_SW	A1	CI_PREM
TREND_AREA_CD,	A8	CI_PREM
COUNTRY	A3	CI_PREM
ADDRESS1	A254	CI_PREM
ADDRESS2	A254	CI_PREM
ADDRESS3	A254	CI_PREM
ADDRESS4	A254	CI_PREM
CITY	A30	CI_PREM
NUM1	A6	CI_PREM
NUM2	A4	CI_PREM
HOUSE_TYPE	A2	CI_PREM
COUNTY	A30	CI_PREM

STATE	A6	CI_PREM
POSTAL	A12	CI_PREM
GEO_CODE	A11	CI_PREM
IN_CITY_LIMIT	A1	CI_PREM

Auto Pay Information

Field Name	Format	Source/Value/Description
BILL_ID	A12	CI_APAY_CLR_STG
APAY_SRC_CD	A12	CI_APAY_CLR_STG
EXT_ACCT_ID	A50	CI_APAY_CLR_STG
SCHED_EXTRACT_DT	Date	CI_APAY_CLR_STG. The date that the automatic payment will be downloaded.
APAY_SRC_NAME	A30	CI_APAY_SRC_L
APAY_SRC_DESCR	A60	CI_APAY_SRC_L
TNDR_TYPE_DESCR	A60	CI_TENDER_TYPE_L
TENDER_TYPE_CD	A4	CI_TENDER_TYPE

Bill Segment Readings

Field Name	Format	Source/Value/Description
BSEG_ID	A12	CI_BSEG_READ
SP_ID	A10	CI_BSEG_READ
SEQNO	N5	CI_BSEG_READ
REG_CONST	S12.6	CI_BSEG_READ
USAGE_FLG	A2	CI_BSEG_READ
USE_PCT	S3	CI_BSEG_READ
HOW_TO_USE_FLG	A2	CI_BSEG_READ
MSR_PEAK_QTY_SW	A1	CI_BSEG_READ
UOM_CD	A30	CI_BSEG_READ
TOU_CD	A30	CI_BSEG_READ
SQI_CD	A30	CI_BSEG_READ
START_REG_READ_ID	A12	CI_BSEG_READ
START_READ_DTTM	DTTM	CI_BSEG_READ
START_REG_READING	S15.6	CI_BSEG_READ
END_REG_READ_ID	A12	CI_BSEG_READ
END_READ_DTTM	DTTM	CI_BSEG_READ

END_REG_READING	S15.6	CI_BSEG_READ
MSR_QTY	S18.6	CI_BSEG_READ
FINAL_UOM_CD	A4	CI_BSEG_READ
FINAL_TOU_CD	A8	CI_BSEG_READ
FINAL_SQI_CD	A30	CI_BSEG_READ
FINAL_REG_QTY	S18.6	CI_BSEG_READ
BADGE_NBR	A30	CI_MTR
NBR_OF_DGTS_RGT	S2	CI_REG

Bill Segment Consumption History

Field Name	Format	Source/Value/Description
SA_ID	A10	CI_BSEG
START_DT	Date	CI_BSEG
BSEG_ID	A12	CI_BSEG
END_DT	Date	CI_BSEG
UOM_CD	A30	CI_BSEG_SQ
TOU_CD	A30	CI_BSEG_SQ
SQI_CD	A30	CI_BSEG_SQ
QTY	S18.6	Service Quantity from CI_BSEG_SQ

Payment Information

One record for every payment linked to the bill.

Field Name	Format	Source/Value/Description
PAY_DT	Date	CI_PAY_EVENT
FT_TYPE_FLG	A2	Pay or Pay Cancel ('PS' or 'PX')
CAN_RSN_CD	A4	CI_PAY
CURRENCY_CD	A3	CI_FT.
CUR_AMT	S15.2	Derived from CI_FT. Sum of CUR_AMT for the bill with FT Type Flag = (PS or PX) and Show on Bill Switch = 'Yes'
TOT_AMT	S15.2	Derived from CI_FT. Sum of CUR_AMT for the bill with FT Type Flag = (PS or PX) and Show on Bill Switch = 'Yes'
TOT_PREV_BAL	S15.2	Calculated as Previous Balance = Ending Balance - (current charges + payments + adjustments + corrections)

PAY_CAN_RSN_DESCR	A60	Description of cancel reason code. (Note, that this is retrieved in a special stored procedure that retrieves all the cancel reason codes and descriptions.)
-------------------	-----	--

Adjustment Information

One record for every adjustment linked to the bill.

Field Name	Format	Source/Value/Description
BILL_ID	A12	CI_FT
ACCOUNTING_DT	Date	CI_FT
ARS_DT	Date	CI_FT
PARENT_ID	A12	CI_FT
SIBLING_ID	A12	CI_FT
FT_ID	A12	CI_FT
CUR_AMT	S15.2	CI_FT
TOT_AMT	S15.2	CI_FT
FT_TYPE_FLG	A2	Adjustment or Adjustment Cancel ('AD' or 'AX')
SHOW_ON_BILL_SW	A1	CI_FT
CURRENCY_CD	A3	CI_FT
XFERRED_OUT_SW	A1	CI_FT
ADJ_TYPE_CD	A8	CI_ADJ
CAN_RSN_CD	A4	CI_ADJ
SA_ID	A10	CI_ADJ
CHAR_PREM_ID	A10	CI_SA
DESCR_ON_BILL	A254	CI_ADJ_TYPE_L
ADJ_CAN_RSN_DESCR	A60	Description of cancel reason code. (Note that this is retrieved in a special stored procedure that retrieves all the cancel reason codes and descriptions.)

Bill Message Information

One record for every bill message linked to the bill.

Field Name	Format	Source/Value/Description
MSG_PRIORITY_FLG	A12	CI_BILL_SA or CI_FT
INSERT_CD	S15.2	CI_BILL_SA or CI_FT

Billed Revenues by Rate - CI_BILREV

Parameters

Parameter	Parameter Code	Description
Accounting Period	P_ACCT_PERIOD	Defines the accounting period used for the report. A valid fiscal year and accounting period for a valid accounting calendar must be provided.
Account Type Characteristic	P_CHAR_TYPE	Defines a Characteristic Type for a characteristic linked to the Distribution Code to define an Account Type.
Account Type	P_REV_ACCTY_CHAR	Account Type Char Value for Revenue related GL Accounts. The char type defined for this parameter should match the Char Type code defined as parameter #2. The parameter value indicated for this parameter should be one that represents revenue accounts.

Report Description

This is an analysis report for the billed revenues for an accounting period according to the various rates, which were in effect in the system. The information in this report helps to adjust rates in order to achieve better financial results and comply with regulations and market trends.

This report selects all records in the financial transaction GL collection that satisfy the following criteria:

- The financial transaction is frozen.
- The Accounting Date on the financial transaction within input accounting period (parameter 1)
- The distribution code associated with the GL entry has a characteristic type and value that matches the input Account Type Characteristic and Account Type (parameters 2 & 3)

NOTE:

Performance Consideration. If your implementation chooses to use this report, you may consider adding an index to the CI_FT table on ACCOUNTING_DT to aid in performance. When making this decision, carefully weigh the benefit of improving report performance against the possible degradation to the performance of day-to-day processing as a result of defining a new index. In addition, many companies opt to create a reporting database that is a shadow of production to ensure that indexes defined to benefit reports may be created without any affect on the production environment.

Case Statistics By Case Type - CI_CSESTS

Parameters

Parameter	Parameter Code	Description
-----------	----------------	-------------

Start Date	P_FROM_DT	See the report's description for how this field is used. If start date is not specified, it is defaulted to 7 days prior to the end date.
End Date	P_TO_DT	See the report's description for how this field is used. If end date is not specified, it is defaulted to the current processing date.
Case Condition (Open, Closed)	P_COND_FLG	If specified, only cases in this condition are included in the report. If left blank, the reports produces statistics for both open and closed cases.

Report Description

This report provides two types of statistics:

1. Open cases whose creation date falls between the input Start Date and End Date (inclusive)
2. Closed cases whose closing date falls between the input Start Date and End Date (inclusive)

The third parameter is only used if you want to restrict the statistics to only open or closed cases. If you leave this parameter blank, both open and closed statistics will be produced.

The following information is provided in graphical format:

- Number of cases by case type
- Percentage of cases by case type

Case Statistics for a Given Status - CI_CSESGS

Parameters

Parameter	Parameter Code	Description
Start Date	P_FROM_DT	See the report's description for how this field is used. If start date is not specified, it is defaulted to 7 days prior to the end date.
End Date	P_TO_DT	See the report's description for how this field is used. If end date is not specified, it is defaulted to the current processing date.
Case Type/Status	P_CASE_STATUS_CD	This is the desired Case Type and Status that will be reported on.
Responsible User	P_CASE_OWNER	If specified, only cases with this responsible user are included in the report.
First Bucket High Limit	P_B1_LIMIT	Cases that took <= this number of days to reach the given status will be grouped together for statistical reporting.
Second Bucket High Limit	P_B2_LIMIT	Cases that took <= this number of days but more than the first bucket high limit to reach

the given status will be grouped together for statistics reporting.

Third Bucket High Limit	P_B3_LIMIT	Cases that took <= this number of days but more than the second bucket high limit to reach the given status will be grouped together for statistics reporting. Cases that took more than this number of days are included in another group.
-------------------------	------------	---

Report Description

This report shows cases of a given case type that transitioned to a given status during a given date range.

Graphs are printed to show the number and percentage of cases grouped by the time it took to reach the status. These statistics are grouped into age buckets whose size is controlled by the last 3 parameters.

Summary statistics are also printed showing the minimum, maximum, average and median times for these cases.

Collection Summary - CI_CLLSUM

Parameters

Parameter	Parameter Code	Description
Start Date	P_FROM_DT	If from date is not set, the default is one month prior to the current date.
End Date	P_TO_DT	End date of the date range. If not defined by user, it is set to one month after the current date

Report Description

This report provides detailed monthly summary information of all collection activities. The report is typically used by a collection department for resource planning and performance review purposes.

This report selects pending and completed collection events whose event trigger date falls between the input start and end dates.

Customer Contacts by Type - CI_CUSTCN

Parameters

Parameter	Parameter Code	Description
Start Date	P_FROM_DT	Start date to use for reporting customer contacts. If not defined, the start date is set to the current date minus 7 days.
End Date	P_TO_DT	End date to use for reporting customer contacts. If not defined, End Date is set to the current date.

Customer Contact Class / Type

P_CC_TYPE_CD

Specify a Customer Contact Class / Type to restrict the report output to a specific class / type.

Report Description

This report lists all customer contacts in the system created within the input date range. You may optionally restrict the report to customer contacts for a given Customer Contact Class / Type (parameter 3).

NOTE:

Graphs. The information on this report is shown in both textual and graphical formats.

Performance Consideration. If your implementation chooses to use this report, you may consider adding an index to the CI_CC table on CC_DTTM to aid in performance. When making this decision, carefully weigh the benefit of improving report performance against the possible degradation to the performance of day-to-day processing as a result of defining a new index. In addition, many companies opt to create a reporting database that is a shadow of production to ensure that indexes defined to benefit reports may be created without any affect on the production environment.

Customers with Life-Support / Sensitive-Load - CI_PMLSSL

Parameters

Parameter	Parameter Code	Description
Service Type	P_SERVICE_TYPE	Service type used to restrict the report to premises with services of this type.

Report Description

This reports displays a detailed list of premises that are coded with Life-Support (LS) or Sensitive-Load (SL) information. It may optionally restrict the output to premises with service points for input service type.

This information is used by a company to make sure that customers at these premises are dealt with appropriately in the case of an outage (planned and unplanned) or service cut due to non-payment.

The report provides detailed information about the premise and the related facility elements providing service to that premise (e.g. substation, feeder and node for electric service).

NOTE:

If ANY person connected to an account has an LS/SL indication in the Person record, then all the premises connected to this account will be treated as LS/SL. This means, for example, that a premise connected to an account that has a 3rd party guarantor with LS/SL is treated as a premise with LS/SL.

GL Accounting Summary - CI_GLACSM

Parameters

Parameter	Parameter Code	Description
Accounting Period	P_ACCT_PERIOD	Defines the accounting period used for the report. A valid fiscal year and accounting period for a valid accounting calendar must be provided.

Account Type Characteristic

P_CHAR_TYPE

Defines a Characteristic Type for a characteristic linked to the Distribution Code to define an Account Type. The account types for the GL accounts are used for grouping the output to the report.

Report Description

This is a financial audit report used to check the financial details in Oracle Utilities Customer Care and Billing for an accounting period against the GL system. The report summarizes all financial transaction (FT) information for a given accounting period according to the different operating and GL divisions and according to various levels of the account GL information.

NOTE:

Performance Consideration. If your implementation chooses to use this report, you may consider adding an index to the CI_FT table on ACCOUNTING_DT to aid in performance. When making this decision, carefully weigh the benefit of improving report performance against the possible degradation to the performance of day-to-day processing as a result of defining a new index. In addition, many companies opt to create a reporting database that is a shadow of production to ensure that indexes defined to benefit reports may be created without any affect on the production environment.

Letter Print - BI Publisher Sample Welcome Letters - CI_LTRGN_ENG REPORT

NOTE:

Generating letters in batch is not supported yet.

Parameters

Parameter	Parameter Code	Description
Batch Switch	P_BATCH_SW	For reports accessed online, set the switch to 'No'. Otherwise, it should be set to 'Yes'.
Customer Contact	P_CC_ID	References the customer contact associated with the main customer linked to the account.

Report Description

This sample report template for BI Publisher produces letters that are not associated with any other object (i.e., the template does not have to extract information from another object to merge into a letter). You can use this template as a welcome letter for a new customer.

By default, the English versions of the report templates are provided with the base product. If multilingual report templates are required, your implementation should provide reports for each language. When a letter is generated, the system uses the report template based on the customer's language.

The address and name for the company are extracted from the [installation options](#). The text for the letter is defined in the report layout and not provided by Oracle Utilities Customer Care and Billing. Reports are printed according to the customer's language definition and not based on the user's language definition.

This sample report uses the following text:

Welcome to %1. You have been filed with ID Number %2.

We hope to provide you with our best possible service. If you experience any problems or have any questions, please contact one of our customer service representatives at (800)1234567.

%1 is the company name stored as a message on the [installation options](#).

%2 is Person Id stored on the Customer Contact.

Open Cases By Type - CI_CSEOPN

Parameters

Parameter	Parameter Code	Description
Start Date	P_FROM_DT	See the report's description for how this field is used. If start date is not specified, it is defaulted to 7 days prior to the end date.
End Date	P_TO_DT	See the report's description for how this field is used. If end date is not specified, it is defaulted to the current processing date.
Case Type	P_CASE_TYPE_CD	If specified, only cases of this type are included in the report.
Responsible User	P_CASE_OWNER	If specified, only cases with this responsible user are included in the report.
First Bucket High Limit	P_B1_LIMIT	Cases that are open for less than or equal to this number of days will be grouped together for statistical reporting.
Second Bucket High Limit	P_B2_LIMIT	Cases that are open less than or equal to this number of days but more than the first bucket high limit will be grouped together for statistics reporting.
Third Bucket High Limit	P_B3_LIMIT	Cases that are open less than or equal to this number of days but more than the second bucket high limit will be grouped together for statistics reporting. Cases that took more than this number of days are included in another group.

Report Description

This is a report on open cases that were created between a given date range.

The report can be limited to a specific type and/or responsible user.

For each case type, the report shows the following:

- Number of open cases by age bucket (the last 3 parameters control the size (in days) of each bucket)
- Percentage of open cases by age bucket
- Details of the open cases

Payments Balance - CI_PMTBAL

Parameters

Parameter	Parameter Code	Description
Start Date	P_FROM_DT	Report gets all the payments that have been received during a given date range (from and to date parameters). If start date is not defined by the user, it is set to 7 days prior to the current date.
End Date	P_TO_DT	End date of the date range. If not defined by user it is set to the current date

Report Description

This report provides an overall view of all payments created within the input date range. It is typically used for financial control and audit purposes. The report provides summary information about valid payments received and about canceled payment. Data is summarized by the tender source and the type of payment.

Receivables Aging - CI_RCVAGA

Parameters

Parameter	Parameter Code	Description
Cutoff Date	P_CUTOFF_DATE	The date from which the arrears buckets are calculated. If no value is entered, the default is the current date minus 7 days.
First Bucket High Limit	P_B1_LIMIT	High limit of first bucket.
Second Bucket High Limit	P_B2_LIMIT	High limit of second bucket.
Third Bucket High Limit	P_B3_LIMIT	High limit of third bucket.

Report Description

This report lists all accounts and their arrears information as of the input cutoff date using a balance forward accounting method.

Outstanding debt is placed into the buckets provided as input using the age of the debt as of the cutoff date. Credits are applied to the oldest debt first. For each account a separate bucket is used to display new charges. In addition, the total accounts receivable balance is displayed for each account.

NOTE:

Performance Consideration. If your implementation chooses to use this report, you may consider adding an index to the CI_FT table on ARS_DT to aid in performance. When making this decision, carefully weigh the benefit of improving report performance against the possible degradation to the performance of day-to-day processing as a result of defining a new index. In addition, many companies opt to create a reporting database that is a shadow of production to ensure that indexes defined to benefit reports may be created without any affect on the production environment.

Tax Payables Analysis - CI_TXPYBL

Parameters

Parameter	Parameter Code	Description
Start Date	P_FROM_DT	Show summary of the tax amounts starting from this date. If not specified, the system will default this value to the current date minus 7 days.
End Date	P_TO_DT	Show summary of the tax amounts up to this date. If not specified, the system will default this value to the current date.
Account Type Characteristic	P_CHAR_TYPE	Defines a Characteristic Type for a characteristic linked to the Distribution Code to define an Account Type.
Account Type	P_TAX_ACCTY_CHAR	Account Type Char Value for tax related GL Accounts. The char type defined for this parameter should match the Char Type code defined as parameter #3. The parameter value indicated for this parameter should be one that represents tax liability accounts.

Report Description

This report displays a summary of the tax amounts that were levied by the company to customers within the input date range. It also includes the tax exemption information for that period.

This report select all records in the financial transaction GL collection that satisfy the following criteria:

- The financial transaction is frozen.
- The Accounting Date on the financial transaction within the input date range
- The distribution code associated with the GL entry has a characteristic type and value that matches the input Account Type Characteristic and Account Type (parameters 3 & 4)

The report also provides tax exemption information for bill segments whose financial transactions satisfy the above criteria. The tax exemption information is retrieved by looking at the bill calculation lines associated with the FT's bill segment.

NOTE:

Performance Consideration. If your implementation chooses to use this report, you may consider adding an index to the CI_FT table on ACCOUNTING_DT to aid in performance. When making this decision, carefully weigh the benefit of improving report performance against the possible degradation to the performance of day-to-day processing as a result of defining a new index. In addition, many companies opt to create a reporting database that is a shadow of production to ensure that indexes defined to benefit reports may be created without any affect on the production environment.

To Do Entries - CI_TDENTR

Parameters

Parameter	Parameter Code	Description
ToDo Entry Status	P_ENTRY_STATUS_FLG	Defines if the To Do entries on the report should be limited to those with a given status value. If this parameter is left blank, the report will show all open and being worked To Do entries.
ToDo Type	P_TD_TYPE_CD	Defines if the To Do entries on the report should be limited to those of a given ToDo type. If this parameter is left blank, the report will show all ToDo type that have at least one open or being worked entry.

Report Description

The report shows open and being worked To Do entries.

You can limit the report to entries in a given status by specifying the desired **To Do Status** (open or being worked). If you don't specify a status, all open and being worked To Do entries will appear on this report.

You can also limit the report to entries of a given To Do Type by specifying the desired To Do Type. If you don't specify a To Do Type, all To Do Types with at least one entry in the open / being worked state will appear on this report.

NOTE:

Graphs. The information on this report is shown in both textual and graphical formats.

Umbrella Agreement Summary - CI_UASUMM

Parameters

At least one parameter is required. If the umbrella agreement is entered, no other parameter value is allowed. The report definition uses the validation algorithm RPTV-UASUMM to check these conditions.

Parameter	Parameter Code	Description
Umbrella Agreement	P_UA_ID	Specify the Umbrella Agreement to restrict the report to this umbrella agreement (regardless of its status). When this parameter is specified, all other parameters are not allowed.
Account Management Group	P_AMG	Specify a value for this parameter to restrict the report to umbrella agreements related to this Account Management Group.
Umbrella Agreement Characteristic Type	P_CHAR_TYPE	Specify a value for this parameter to restrict the report to completed umbrella agreements related to this Characteristic type and value (parameter 4).
Umbrella Agreement Characteristic Value	P_CHAR_VALUE	Specify a value for this parameter to restrict the report to completed umbrella agreements related to this Characteristic type (parameter 3) and value.
Number of Days Before Expiration	P_EXPIRE_IN_X_DAYS	Specify a value for this parameter to restrict the report to completed umbrella agreements

whose End Date is on or before the current date less the Number of Days before Expiration.

Report Description

This report provides summary information about one or more [umbrella agreements](#).

If the user does not supply an umbrella agreement ID, but enters one or more of the other parameters, the report only selects umbrella agreements that match the input criteria AND the match the following criteria:

- The status of the umbrella agreement is complete
- The start and end dates of the umbrella agreement include the current date

The report does not include canceled terms of service records or canceled service agreements linked to the above umbrella agreements.

For each umbrella agreement that is included in the report, the output includes information about the umbrella agreement, its collection of terms of service records and for each TOS record, its collection of service agreements.

In addition, the report includes the following graphs:

- Umbrella agreement summary graph showing billing history by accounting period for the effective dates of the umbrella agreement for all service agreements linked to the umbrella agreement's terms of service records.
- Terms of service summary graph showing billing history by accounting period for the effective dates of the umbrella agreement for all its service agreements

Unbilled Revenues - CI_UBLREV

Parameters

Parameter	Parameter Code	Description
Accounting Period	P_ACCT_PERIOD	Defines the accounting period used for the report. A valid fiscal year and accounting period for a valid accounting calendar must be provided.
Account Type Characteristic	P_CHAR_TYPE	Defines a Characteristic Type for a characteristic linked to the Distribution Code to define an Account Type.
Account Type	P_REV_ACCTY_CHAR	Account Type Char Value for Revenue related GL Accounts. The char type defined for this parameter should match the Char Type code defined as parameter #2. The parameter value indicated for this parameter should be one that represents revenue accounts.

Report Description

This report provides a simplified calculation of estimated unbilled revenue for a given month.

It processes frozen financial transactions associated with bill segments and canceled bill segments whose bill segment end date is within the **Accounting Period** (parameter 1). It determines the billed revenue for the FT and then uses this information to calculate the unbilled revenue.

To determine "revenue", the report summarizes amounts posted to any distribution code with a characteristic entry that matches the input **Account Type Characteristic** type and **Account Type** characteristic value (parameters 2 and 3).

The estimate for the unbilled portion is calculated as (Bill Amount / Number of Days in the Bill Period) * Number of Unbilled Days for the Accounting Period.

For example, consider a bill segment on a monthly-billed cycle for the period of 3/10/03 - 4/9/03, and for \$150 (revenue part of the bill). Assume we are in the April/03 accounting period, which covers 4/1/03 through 4/30/03. This means 21 days are unbilled for April. The unbilled revenue is calculated as $150/31*21 = \$101.61$.

The following are some points to note about this report.

- If the report runs for an historical date, it still estimates the unbilled revenue portion based on the above formula even if actual data exists. In other words, it will not try to find actual bills for subsequent months. As a result, this report always shows what would have been the estimated unbilled revenue for a particular month if that month is the most recent one.
- Services can be billed monthly bi-monthly, quarterly or in any desired frequency. This report only performs the revenue recognition estimation using actual bills that were created in the report's accounting period. As a result, it does not estimate unbilled revenue for accounts that were not billed in any portion of the input accounting period.
- Revenue recognition practices are unique and may vary from customer to customer. In a given month we can produce current bills (e.g. for electric service) or future bills (e.g. cable services). In addition in some cases we can have bills that started before the accounting period and ending after it (for example in a cancel-rebill situation). This report will only estimate unbilled revenues for bills with the accounting period equals to the report's accounting period.

NOTE:

Performance Consideration. If your implementation chooses to use this report, you may consider adding an index to the CI_BSEG table on START_DT, END_DT to aid in performance. When making this decision, carefully weigh the benefit of improving report performance against the possible degradation to the performance of day-to-day processing as a result of defining a new index. In addition, many companies opt to create a reporting database that is a shadow of production to ensure that indexes defined to benefit reports may be created without any affect on the production environment.

Defining Overdue Processing Options

The system periodically monitors how much your customers owe to ensure they haven't violated your collection rules. When a violation is detected, the system initiates the appropriate activities (e.g., letters, disconnect notices, collection agency referrals, and eventually write off). The topics in this section describe how to configure the system to manage your overdue processing requirements.

NOTE:

The overdue processing module has been designed to collect on virtually anything from an unpaid bill to an unmatched financial transaction. You tell the system what you collect on by configuring the various overdue processing control tables. In this release, the base-package is delivered with algorithms that support collecting on overdue bills. If your organization practices balance-forward accounting (i.e., collection is based on overdue service agreement balances), you will not use this functionality. Rather, you will use the functionality described under [Defining Credit and Collections Options](#).

WARNING:

Setting up this module is as challenging as your organization's collection rules. If you have simple rules, the set up process will be straightforward. If your rules are complicated (e.g., they differ based on the type of customer, the age of debt, the type of service, etc.), your setup process will be more challenging.

Case Study - Collecting On Overdue Bills

The following topics introduce a case study that describes how overdue processing can be used to collect on overdue bills. This is just an example as virtually every aspect of overdue processing is configurable. Use this case study to familiarize yourself with the overdue processing core concepts.

Monitoring Overdue Bills

The following diagram illustrates the objects and processes involved with collecting overdue bills.

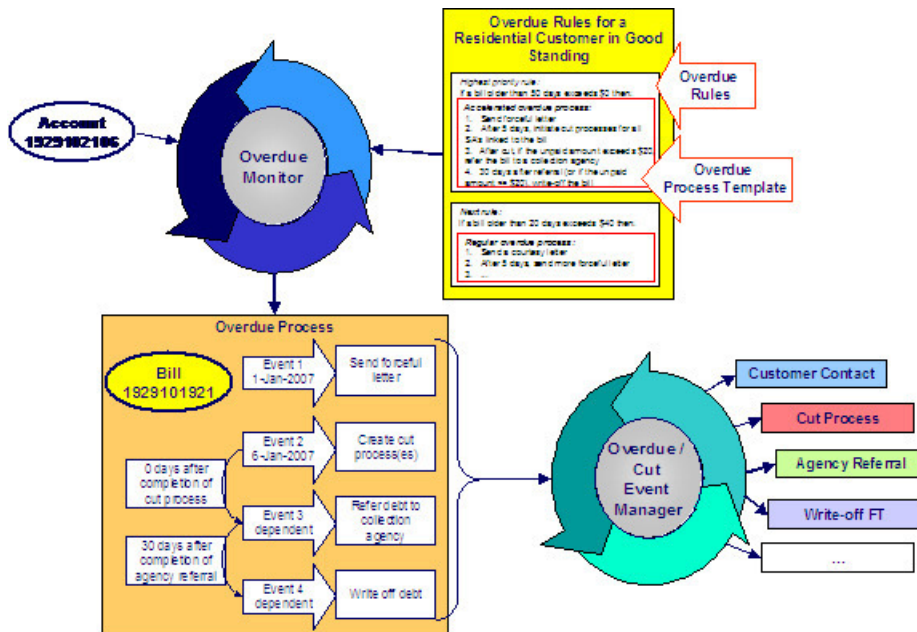

There are many important concepts illustrated above:

The **Overdue Monitor** checks if your accounts have bills that violate your overdue rules

The **Overdue Monitor** is a background process that periodically reviews your account's financial obligations.

Note well: every account belongs to a collection class. There are two types of collection classes: those whose accounts are monitored by the **Account Debt Monitor**, and those that are monitored by the **Overdue Monitor**. This chapter describes the **Overdue Monitor**.

Overdue rules define when and how unpaid bills are collected

An account's **collection class overdue rules** have algorithms that monitor an account's financial obligations. These algorithms are invoked by the **Overdue Monitor** when it's **time to review** an account's obligations.

These algorithms can contain any type of criteria. However, most are defined using a combination of a threshold age and monetary amount. For example, a classic algorithm would check if a bill has unpaid financial transactions more than 20 days old that exceed \$50.

In the case of bill-oriented collection, the monitoring algorithms look at each of the account's bills to determine if they are paid. Note, a

bill is considered paid if its financial transactions (FTs) are linked to a balanced match event. If a monitoring algorithm finds an unpaid bill, it can check if it old enough (and large enough) to be considered a violation.

When you set up a monitoring algorithm, you define the type of overdue process that should be created when an overdue bill is detected. You do this by defining the appropriate "overdue process template".

An overdue process template defines how to handle an overdue bill

An [overdue process template](#) contains one or more [overdue event types](#). These define the number and type of events that are created to prod the customer to pay. For example, you might set up an overdue process template with event types to send a series of letters followed up by a call.

The overdue process template has contains the rules defining [when events are activated](#).

The specific action that's performed by an overdue event is controlled by the Activation algorithm defined on its event type. Refer to [Overdue Event Type - Main](#) for a list of the various Activation algorithms delivered with the base package.

Multiple objects can be associated with a single process

The above diagram shows a single bill linked to an overdue process. It should be noted that an overdue process is capable of referencing multiple bills (or other objects).

Note well: while a single overdue process can reference many overdue objects, all such objects must be of the same type. For example, you cannot commingle bills and service agreements under a single overdue process. The type of object managed by an overdue process is defined on its [overdue process template](#).

If a customer pays the bill, the overdue process is cancelled

If an overdue bill is paid, the [overdue process is canceled](#) real-time. You control if and how an overdue process is cancelled by setting up the appropriate rules on the [overdue process template](#).

The Overdue / Cut Event Manager activates and triggers overdue events

The [Overdue / Cut Event Manager](#) is a background process that activates overdue events on the appropriate date. On this date, the event's Activation algorithm(s) are called.

This Overdue / Cut Event Manager also has the responsibility of recursively activating later events that are dependent on the completion of earlier events.

Events can be activated real-time

[Overdue Process - Main](#) has a button that allows users to activate (and recursively trigger) overdue events online / real-time. This means you don't have to wait for a batch job to activate events.

Overdue events can wait for related activities to complete

As described above, an overdue event's Activation algorithm can create virtually any object. What wasn't explained is that the event can be set up to [wait](#) for the ancillary object to finish before it completes. For example, an event can create a To Do entry and wait for it to complete before the next event is triggered. You can introduce plug-ins to create and wait on virtually any object.

While an overdue event is in the Wait state, the Overdue / Cut Event Manager monitors the state of the related object(s). When the related object completes, the event is transitioned to the Complete sate (thus

triggering dependent overdue events). Please see [Some Events Wait For Something Before Completing](#) for more information.

Cutting Service Agreements

An overdue process may contain an overdue event that creates a cut process(es). A cut process is used to cut (i.e., stop) a service agreement. The following diagram illustrates the objects and processes involved with cutting a service agreement.

NOTE:

Cut processes aren't required. It's quite conceivable to design an overdue process that doesn't cut service. For example, the overdue process may just contain an event that creates a case and the case manages the collection activities.

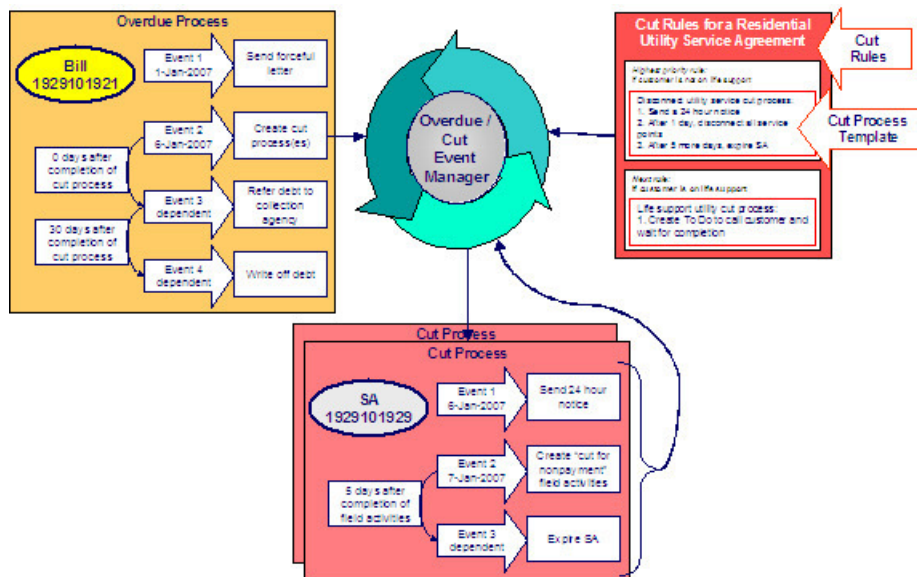

An overdue process may contain an overdue event that cuts (i.e., stops) service

If an overdue process's bill remains unpaid, one of the latter overdue events typically creates one or more [cut processes](#). A cut process contains the activities to stop a service agreement (in the hopes that lack of service will inspire the customer to pay). It should be noted that a separate cut process is created for each service agreement.

Cut rules define how to sever service agreements

The system allows you to define rules to control the type of cut process created. For example, you may have a different cut process if the customer has life support equipment, or if it's winter, or ...

The cut rules are defined on the service agreement's [SA type](#). This allows different rules for different types of service agreements.

Overdue events can "wait" for related activities to complete

When an overdue event creates cut process(es), it typically enters the Wait state. It enters this state as it is waiting for the cut process(es) to complete before it can itself complete. While in the Wait state, the Overdue / Cut Event Manager monitors the state of the related cut process(es). When the cut process(es) complete, the system transitions the originating overdue event to the Complete state (thus triggering dependent events).

A cut process template defines how to cut a service agreement

Cut processes and events are created using a [cut process template](#). A cut process template defines the actions involved in cutting a given type of service agreement. A cut process template usually contains several cut events. These events are a series of letters and / or disconnection field activities that eventually result in the expiration of a service agreement if payment is not received.

An Activation algorithm controls the specific action associated with a cut event and therefore an event can do practically anything. Refer to [Cut Event Type - Main](#) for a list of the various Activation algorithms delivered with the base package.

Cut events are also managed by the Overdue / Cut Event Manager

The same [background process](#) that manages the activation of overdue events manages cut events. This means you only have to submit one batch job to activate and trigger both overdue and cut events.

Events can be activated real-time

[Cut Process - Main](#) has a button that allows users to activate (and recursively trigger) cut events online / real-time. This means you don't have to wait for a batch job to activate events.

Cut events can "wait" just like overdue events

Cut events support the ability to wait for something to complete just like overdue events. For example, if a cut event creates a field activity, it enters the Wait state. While in the Wait state, the Overdue / Cut Event Manager monitors the state of the related field activities. When the field activities complete, the system transitions the originating cut event to the Complete state.

And, just like for overdue events, the notion of a cut event creating something and then waiting for it to complete is not limited to field activities. For example, you could have a cut event create a To Do entry and wait for it to complete before the next event is triggered.

Please see [Some Events Wait For Something Before Completing](#) for more information.

After a service agreement is stopped, it will be final billed

Many cut processes are configured so their last cut event [expires the service agreement](#). What happens at expiration depends on the type of service agreement. However, eventually the service agreement is transitioned into the Stopped state.

When the last active service agreement linked to an account is stopped, the system changes the account's bill cycle to bill that evening. If only one of many SAs is stopped, the SA will only be final billed as per the account's original bill cycle schedule.

If a customer doesn't pay their final bill, the final bill will be processed using a different type of overdue process

Final bills only differ from ongoing bills in that the service agreements associated with the bill's FTs are not active. This means that there is nothing to cut. This means that the type of overdue process used to handle a "final" bill should differ from that used to handle "ongoing" bills.

As described above, overdue rules define how unpaid bills are handled (both ongoing and final). We recommend configuring your overdue rules to use different overdue process templates for final versus ongoing bills.

The last overdue event typically causes the debt to be written off

Ultimately, if the overdue and cut events fail to inspire payment, the debt will be written off. The method used to write-off a bill is controlled by an overdue event Activation algorithm.

How Does The Overdue Monitor Work?

This section describes how the Overdue Monitor background process (C1-ADMOV) uses your overdue rules to collect overdue debt.

This process has an optional input parameter for CIS Division. It can be used if your implementation requires processing of data by CIS Division. You will need to create a copy of this process's batch control for each CIS Division.

NOTE:

Recommendation. We recommend that you familiarize yourself with the concepts described in the [case studies](#) before reading this section.

Collecting overdue bills. The examples in the following section frequently refer to how the Overdue Monitor is configured for an organization that collects on unpaid bills. It should be noted that these are just examples as the Overdue Monitor can be used to collect on virtually anything (if you create the appropriate plug-in algorithms).

Different Overdue Rules For Different Customers

The Overdue Monitor uses rules to control how it monitors an account's debt. The system allows you to define different rules for different combinations of collection class, division and currency code. For example,

- You probably have different collection rules for different jurisdictions (i.e., CIS Divisions). For example, if you have customers in different states / provinces, you may have different rules applied to each jurisdiction's debt. The **CIS division on each customer's account** defines the jurisdictional rules applied to the account's debt.
- You probably have different collection rules for different customer segments. For example, bills for large customers might be overdue if they are more than 10 days late, whereas small customers might have 24 days. You differentiate your customers in respect of the overdue via the **collection class on the customers' accounts**. An account's initial collection class is defaulted from its customer class. You may override an account's collection class at will.
- You will have different criteria for every currency in which you work because the monitoring process always compares a customer's debt against some value and this value must be denominated in the customer's currency. A customer's currency is defined using a **currency code on the account**.

The above means that every combination of CIS division, collection class, and currency code can have different rules. The following matrix is used to illustrate a sample organization's rules (note, we assume a single currency and therefore avoid the third dimension):

Account's Division	Account's Collection Class:	
	Commercial Customer	Residential Customer
North	Highest Priority: If a bill exists with unpaid FT's > \$0 that is older than 45 days, create the commercial 45 days late overdue process. Next Priority: If a bill exists with unpaid FT's > \$100 that is older than 30 days, create the commercial 30 days late overdue process.	Highest Priority: If a bill exists with unpaid FT's > \$0 that is older than 50 days, create the accelerated overdue process for residential customers. Lower Priority: If a bill exists with unpaid FT's > \$25 that is older than 25 days, create the courtesy reminder overdue process for residential customers.
South

Notice that there can be multiple criteria for each cell in the matrix. What differentiates one criteria from another is its priority. The higher priority criteria will be compared first. If the debt violates the criteria, the overdue process is initiated and no further comparisons are performed.

Overdue Rules Are Embodied In Algorithms

Your organization's overdue rules are defined in algorithms plugged in on [Collection Class Overdue Rules](#) (in the Overdue Monitor Rule system event). When the Overdue Monitor analyzes an account, it uses the rules associated with the account's collection class, CIS division and currency code. To analyze an account, it simply invokes these algorithms in sequence order, i.e., the lower the sequence, the higher its priority.

An Overdue Monitor Rule algorithm has two responsibilities:

- it determines if an account violates its overdue rules,
- if so, it creates one or more overdue processes using an [overdue process template](#)

When Is An Account Monitored?

The Overdue Monitor determines if an account violates your overdue rules at least every X days, where X is defined on the [Customer Class - Controls](#) associated with the account's customer class and division (in the field Min Credit Review Freq (Days)).

In addition, the Overdue Monitor examines an account's debt as follows:

- X days after an account's bill due date (X is defined in the field Credit Review Grace Days on [customer class control](#)).
- If a payment is canceled with a cancellation reason that indicates non-sufficient funds.
- If a payment arrangement is broken (assuming you use the base package's break payment arrangement plug-in). Refer to [Breaking A Bill Oriented Payment Arrangement](#) for more information.
- If a pay plan is broken. Refer to [The Pay Plan Monitor](#) for more information.
- If a [match event](#) is added, changed or deleted.
- When a written off bill is [reversed](#).

NOTE:

Additional events. Your implementation can have other events trigger the analysis of an account by the Overdue Monitor. To do this, add logic to insert a row on the CI_ADM_RVW_SCH table when the event occurs. This row simply references the account ID to be reviewed and the desired review date.

Collection Class Defines If And How Accounts Are Monitored

As described above, every account references a collection class. The collection class defines if and how its accounts are monitored. There are three options:

- The accounts are monitored by the [Account Debt Monitor](#)
- The accounts are monitored by the Overdue Monitor (this is described in this chapter).
- The accounts are not monitored for overdue debt.

NOTE:

Migration. If you plan to migrate from the Account Debt Monitor (ADM) method of collection to the Overdue Monitor method, a special Overdue Monitor algorithm (C1-ACT-CSW) has been supplied that will skip accounts that are eligible for review by the Overdue Monitor if they have an active collection, severance or write-off process. This algorithm should be plugged in the applicable Collection Class Overdue Rules so that it will be invoked first. This allows accounts with active ADM-oriented collection activities to work themselves through the system. When an account no longer has any active ADM-oriented activities, monitoring responsibilities will be assumed by the Overdue Monitor.

The Big Picture Of Overdue Processes

As described above, the Overdue Monitor subjects your accounts to overdue rules. If a rule is violated, an overdue process is created. The topics in this section provide background information about overdue processes.

How Are Overdue Processes Created?

As described [above](#), the system creates an overdue process when an account violates your overdue rules. In addition, a user can manually create an overdue process at their discretion.

The Components Of An Overdue Process

The following topics describe the major components of an overdue process.

Overdue Objects

When an overdue process is created, the system links the overdue object(s) to the process. For example, if an overdue bill is detected, the bill is linked to the overdue process.

When you set up an [overdue process template](#), you define the type of object it collects on by defining the [foreign key characteristic type](#) used to reference the object. For example, when you set up an overdue process template to collect on bills, you define a foreign key characteristic type that references the bill object.

Overdue Events

An overdue process has one or more overdue events. These events are the actions designed to encourage the customer to pay. For example, you might set up overdue events that:

- Send letters (via the creation of a customer contact)
- Create To Do entries
- Impact the account's credit rating
- Create a case (e.g., to seize the customer's assets)
- ... (the list is only limited by your imagination as algorithms are used to perform the event's actions)

You define the number and type of events by configuring [overdue process templates](#). When the system creates an overdue process, it copies the events defined on the specified template.

It's important to note that all overdue events are created when the overdue process is created. A separate background process, the [Overdue / Cut Event Manager](#), is responsible for activating, monitoring, and triggering overdue events. Activation of an event causes the system to do whatever the event indicates (e.g., send a letter, send a To Do entry to a user, start a cut process, refer debt to a collection agency, write-off debt, etc.).

Overdue Log

Every overdue process has a log holding its history. Entries are added to the log when meaningful events occur, for example:

- When the process is created, a log entry is created to describe why the process was started.
- When an overdue event is activated, a log entry is created. These entries frequently contain a foreign key to the object that the event created so that users can easily drill down to the object from the log. For example, if an event creates a To Do entry, the To Do entry's foreign key is placed on the log and this allows a user to drill down on the log entry to see the To Do entry.
- When a process is canceled, a log entry is created to describe the circumstances of the cancellation (e.g., manual versus automated).
- Users can manually add log entries (you might want to think of these as "diary" entries) as desired.
- ...

Many of the base-package algorithms involved in overdue processing insert log entries so that a thorough audit trail is maintained. These algorithms have been designed to allow you to control the verbiage in each log entry by defining the desired message number using an algorithm parameter.

The log is viewable on the [Overdue Process - Log](#) page.

NOTE:

More than just an audit trail. The log entries are more than just an audit trail. The system makes use of the log entries to know what it did. For example, when an overdue event needs to monitor the state of the To Do entries that it created, it uses the log to determine the identity of these To Do entries.

Experimenting With Alternative Overdue Process Templates

The system allows you to determine the efficacy of proposed overdue process templates using a small subset of customers before implementing the templates on the entire customer base. We use the term "champion / challenger" to reference this functionality.

We'll use an example to explain. Let's assume your prevailing overdue process template for residential customers starts with a "gentle reminder" letter followed 10 days later by a letter threatening collection agency referral if payment is not received. You may want to experiment with the impact of a change to this template. For example, you may want to change the "gentle reminder" to something more assertive and follow this up 5 days later with an even sterner warning. You can use the "champion / challenger" functionality to perform this experiment.

The following points describe how to implement "champion / challenger" functionality:

- Set up a "challenger" overdue process template for each template that you want to experiment with.
- Insert a new **Champion/Challenger** option on the Overdue Processing [Feature Configuration](#) for every champion template. Each option's value defines:
 - the "champion" overdue process template code
 - the "challenger" overdue process template code

- the percentage of the time the system should use the "challenger" template
- Keep in mind that you can only experiment with one challenger template per champion template. For example, let's assume you have two prevailing overdue process templates - one for residential customers and another for commercial customers. You can experiment with different challenger templates for the residential and commercial templates. However, you cannot experiment with two different challenger templates for the residential champion template (i.e., a champion template can have 0 or 1 challenger template).

After setting up the above, your implementation's [Overdue Rule Plug-In](#) may include logic to use the challenger template X % of the time rather than the champion template. The sample plug-in provided in the base product, called C1-CB-CR-RAT, includes this logic.

If you are using the Oracle Utilities Analytics product, you can configure analytic zones in innumerable ways to compare the efficacy of the champion versus the challenger. For example,

- You can set up a graph to show the average duration of each type of process.
- You can set up a graph to show the average dollars that were successfully collected.
- You can set up a dimensional scorecard to show how each template performed in different regions (or customer classes or ...).
- Etc (the list is limited by your imagination)

Overdue Process Information Is Overridable

"Overdue process info" is the concatenated string of information that summarizes an overdue process throughout the user interface. The base-package logic constructs this string by concatenating the following information:

- The description of its overdue process template
- Its status
- For active processes, the number of days since it was created. For inactive processes, the number of days since it was inactivated.
- For active processes, the unpaid amount of the objects being collected

If you'd prefer a different info string, you can develop a new algorithm and plug-it in on your [overdue process templates](#). This design allows some / all overdue process templates to have an override info string.

Original and Unpaid Amounts

There are two amounts associated with each overdue object linked to an overdue process: its Original Amount and its Unpaid Amount. These amounts are used throughout overdue processing.

You control how these amounts are calculated by defining the appropriate algorithm on your [overdue process templates](#). For example, you can plug in a base-package algorithm (C1-CUAOA) if you collect on overdue bills and the original amount is the amount of financial transactions linked to the bill, and the unpaid amount is the sum of financial transactions that are not linked to balanced match events.

Overdue Processes Are Highlighted Elsewhere

The topics in this section describe how other parts of the system highlight the existence of overdue and cut processes.

Alert Zone

If you plug-in the appropriate alert algorithm (C1-OD-PROC) on the Installation record, alert(s) will be shown for active overdue processes in the Alert Zone that appears in the Dashboard and on Control Central - Account Information.

Credit and Collections Zone

The Credit and Collections zone on [Control Central - Account Information](#) shows active overdue and cut processes.

Account Activity History Zone

The Account Activity History Zone on [Control Central - Account Information](#) shows pending and waiting events and inactive processes.

How Are Overdue Processes Cancelled?

A user may cancel an overdue process at their discretion, online / real-time using [Overdue Process - Main](#).

The system will automatically cancel an overdue process when the object(s) associated with the overdue process are sufficiently paid. Exactly when the system checks if an overdue process should be cancelled is dependent on your organization's billing and accounting rules. For example, if you practice [open-item accounting](#), you'd want to analyze an account's active overdue processes whenever a match event is added, changed or deleted (as match events are the only objects that impact if debt is considered paid in an open-item world). The base-package supports this specific example. If you need additional events to check if an overdue process should be canceled (e.g., the creation of a pay plan), a base-package change MAY be necessary. Please check with customer support if you have questions.

Two algorithms plugged-in on the [overdue process template](#) handle the cancellation:

- The Cancel Criteria algorithm is responsible for determining if an overdue process should be canceled. Algorithms of this type analyze the outstanding debt on the objects linked to the overdue process and indicate whether a process can be cancelled.
- The Cancel Logic algorithm is responsible for actually canceling the process. The logic involved in cancellation can be quite sophisticated as canceling an overdue process can result in the cancellation of its pending events and cut processes.

NOTE:

Why two algorithms? The reason two algorithms are involved in cancellation is because we want the cancellation logic to be encapsulated in one place so it can be called during both manual and automated cancellation.

Different logic for different templates. Because both the Cancel Criteria and Cancel Logic algorithms are plugged-in on the overdue process's template, you can have different cancellation criteria and logic for different templates.

Overdue Processes Are Created From Templates

As described above, you set up [overdue process templates](#) to define the types of events and when they are executed. When an overdue process is created, its events are created by copying the event types from an overdue process template. The remaining topics in this section provide background information to assist you in setting up your templates.

The Big Picture Of Overdue Events

This section describes the various types of overdue events and their lifecycle.

How Are Overdue Events Created?

Overdue events are created as follows:

- The [Overdue Monitor](#) invokes Overdue Monitor Rules to periodically check your accounts (refer to [Overdue Rules Are Embodied In Algorithms](#) for how this works). An Overdue Monitor Rule creates an overdue process when an account violates your overdue rules. The overdue process has one or more overdue event(s). The number and type of events is controlled by the overdue process template specified on the Overdue Monitor Rule.
- Users can create an overdue process manually on [Overdue Process - Main](#). To do this, they specify an overdue process template. The number and type of overdue events is defaulted from the template.
- An overdue event may be manually added to an existing overdue process by a user on [Overdue Process - Events](#).

NOTE:

Bottom line. Most overdue events are created by the system when it creates an overdue process for delinquent obligations. If you need to create an ad hoc overdue event, you can either create an overdue process whose template contains the desired event OR link the desired event to an existing process.

Overdue Events Can Do Many Things

An overdue event can perform a wide number of activities as the logic is embodied in an algorithm. The following points describe how this works:

- Every overdue event references an [overdue event type](#).
- The overdue event type, in turn, references an Event Activation algorithm.
- The Event Activation algorithm is invoked when the event is [triggered](#).

Overdue Event Information Is Overridable

"Overdue event info" is the concatenated string of information that summarizes an overdue event throughout the system. The base-package logic constructs this string by concatenating the following information:

- The event type's description
- The event's status
- If it's pending:
 - If the event has a trigger date, the number of days until it's triggered plus the verbiage day(s) from today
 - Otherwise, the verbiage dependent on other events
- If it's waiting, the number of days, hours and minutes that it's been waiting
- If it's canceled, the cancel reason code's description
- If it's complete, the number of days, hours and minutes that it's been complete

If you'd prefer a different info string, you can develop a new algorithm and plug-it in on your event types. This design allows some / all event types to have an override info string.

Overdue Event Lifecycle

The following diagram shows the possible lifecycle of an overdue event:

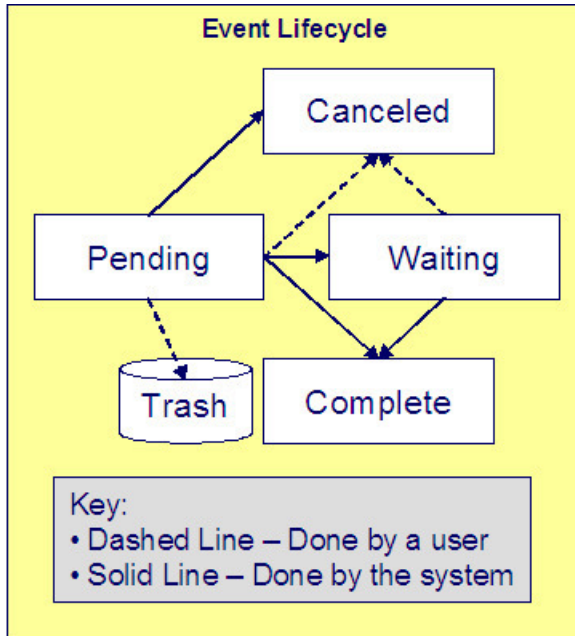

Overdue events are initially created in the Pending state. An event can take myriad paths after it's created; it all depends on how you've configured the system. The following topics describe an event's lifecycle:

How and When Events Are Activated

An overdue event contains the date it should be activated; this is referred to as its trigger date. On this date, the Overdue / Cut Event Manager (a background process (C1-ODET)) invokes the Event Activation algorithm plugged-in on the event's event type. The Event Activation algorithm, in turn, will decide on the state in which to leave the overdue event (e.g., it may transition it to the Complete state or the Waiting state).

If a user can't wait for the Overdue / Cut Event Manager real-time, they can click a button on [Overdue Process - Main](#) to activate (and recursively trigger) events online / real-time.

You control how an event's trigger date is populated by configuring the [overdue process template](#). You are given two choices when you link an event type to an overdue process template:

- You can indicate the event should be assigned a trigger date when it is first created. You'd use this approach on the first event and events with no dependencies on earlier events. The following points describe how to configure the overdue process template to do this:
 - Indicate the event type is NOT dependent on other events, and
 - Define the number of days after the process's creation to use when calculating the trigger date.
- You can indicate the event should be assigned a trigger date only after earlier events are Complete. This technique should be used whenever you have an event that is only executed after other events are Complete. The following points describe how to configure the overdue process template to do this:

- Indicate the event is dependent on other events, and
- Define the number of days after the completion / cancellation of all dependent event(s) that the trigger date should be set to. The Overdue / Cut Event Manager sets the trigger date on such an event when it detects that all of its dependent events are complete / canceled.

NOTE:

Calendar vs Workdays. When an overdue event is created by the system, its trigger date is set in accordance with your date arithmetic preferences. Refer to [Calendar vs. Work Days](#) for more information.

Activating Events Should Add a Log Entry

As described [above](#), an overdue process has a log holding a history of meaningful events in the process's life. Most Event Activation algorithms will add an entry to the process's log.

These log entries are more than just an audit trail as they also reference the objects that are created during activation. For example, if an activation algorithm creates a customer contact, the ID of the customer contact will be referenced on the log (and end-users will be able to drill down on the log entry to see the customer contact).

Holding Events

You can prevent a pending event with a trigger date on / before the current date from activating by plugging-in a Hold Event Activation plug-in on the overdue process template. This might prove useful, for example, if you want to suspend an overdue process while a [case](#) used to investigate the assertion of a customer is outstanding. Then, when the case closes, the overdue process can start up where it left off.

This technique would prove useful, for example, if your users can grant ad hoc suspend periods (e.g., if a customer wants a few extra days to pay before a cutoff). To do this, create a case type that has two states: Open and Close. Make sure to set up the Open state to have an automatic transition algorithm to close the case after X days. Then, all a user has to do is create a case of this type when they want to provide a suspend period. When the suspend period is over and payment isn't received, the case will close and the overdue process will start up where it left off.

Some Events Wait For Something Before They Activate

Consider this scenario - you want an overdue event to create a To Do entry so a user can authorize the next phase of an overdue process. When this event activates, the event's activation algorithm will create a To Do entry, but it will NOT transition the event to complete. Rather, the overdue event will exist in the waiting state. While in the waiting state, the Overdue / Cut Event Manager will monitor the state of the To Do entry. When the To Do entry completes, the original overdue event can transition to the complete state and then latter dependent events can be triggered. The following points describe how to configure the system to support this type of event:

- The event type's Event Activation algorithm should behave as follows:
 - It creates the object on which the overdue event waits.
 - It must link this object to the overdue process by creating a log entry where the prime-key of the related object is referenced (in a foreign-key characteristic). This log entry should also reference the event.
 - It should leave the overdue event in the waiting state.
- The event type must have a Monitor Waiting Event algorithm. This algorithm is invoked each time the [Overdue / Cut Event Manager](#) executes. If the related object has transitioned to a "final" state, the originating overdue event is transitioned to the complete state (and then latter dependent events are triggered).

NOTE:

Bottom line. Two algorithms must be set up on an overdue event type to implement waiting functionality: an Event Activation algorithm that creates the monitored object and a Monitor Waiting Event algorithm to check on the state of the monitored object. The Overdue / Cut Event Manager has the dual responsibility of activating the event and monitoring its related object for completion (and then triggering the dependent events when it completes).

While the above example illustrated how an overdue event could create and then monitor a To Do entry, you can use this functionality to create and monitor any object that has an initial and final state. If the base package does not contain the algorithms you need, simply develop new ones using the base-package algorithms as examples.

How Are Events Canceled

A pending event will be cancelled automatically by the system when the overdue process is canceled. Refer to [How Are Overdue Processes Cancelled](#) for more information.

A user may cancel a pending or waiting event at their discretion.

Regardless of what triggers the cancellation, the Cancel Logic algorithm plugged in on the overdue event type handles the cancellation. This allows you to introduce additional cancellation logic should the need arise. Please note that the base package cancel algorithms insert a [log entry](#) when a user manually cancels an event.

The Big Picture Of Cut Processes

While not required, many overdue processes will contain one or more events that will cut (i.e., stop) service. When such an event activates, it creates a "cut process". A cut process is very similar to an overdue process; the major difference is that a cut process is linked to a specific service agreement (the one being cut), whereas an overdue process is linked to the object(s) in arrears.

The topics in this section provide background information about cut processes.

How Are Cut Processes Created?

The activation of an overdue event can create one or more cut processes.

In addition, a user can manually create a cut process at their discretion using [Cut Process - Main](#).

Overdue Events Wait For The Cut Process To Conclude

Overdue events that create cut processes are perfect examples of events that [wait](#) for the object they create to complete before they, in turn, complete. After the cut process concludes, the originating overdue event will complete thus triggering its dependent events.

Cut Processes Exist Under An Overdue Process

It's important to note that a cut process exists in respect of an overdue process. In other words, you can't create a cut process without referencing a parent overdue process. There are two reasons why:

- A cut process's overdue process defines the objects in arrears. It is these objects that are monitored to determine if the cut process (and overdue process) can be cancelled.
- The [log](#) associated with a cut process's overdue process contains the history of the cut process(es) and their events; there is no log specific to a cut process.

The Components Of A Cut Process

Cut processes are simpler than overdue processes as they simply contain one or more "cut events". These events are the service agreement-specific actions designed to encourage the customer to pay. For example, you might set up cut events that:

- Create [field activities to cut service](#)
- Send letters (via the creation of a customer contact)
- Create To Do entries
- Impact the account's credit rating
- Create a case (e.g., to manage a customer with life support issues)
- ... (the list is only limited by your imagination as algorithms are used to perform the event's actions)

You define the number and type of events by configuring [cut process templates](#). When the system creates a cut process, it copies the events defined on the related template.

It's important to note that all cut events are created when the cut process is created. The Overdue / Cut Event Manager is responsible for activating the cut events at the appropriate time. Activation of an event causes the system to do whatever the event indicates (e.g., send a letter, send a To Do entry to a user, create a field activity, etc.)

Cut processes do not have their own log as their history is maintained on the parent overdue process's [log](#).

Cut Process Information Is Overridable

"Cut process info" is the concatenated string of information that summarizes a cut process throughout the system. The base-package logic constructs this string by concatenating the following information:

- Its cut process template's description
- Its status
- For active processes, the number of days since it was created. For inactive processes, the number of days since it was inactivated.
- For active processes, the unpaid amount of the objects being collected on the cut process's overdue process

If you'd prefer a different info string, you can develop a new algorithm and plug-it in on your cut process templates. This design allows some / all cut process templates to have an override info string.

How Are Cut Processes Cancelled?

A user may cancel a cut process at their discretion, online / real-time using [Cut Process - Main](#).

The system will automatically cancel a cut process when the overdue process is cancelled.

Regardless of what triggers the cancellation, the Cancel Cut Process algorithm plugged in on the cut process's [template](#) handles the cancellation.

If a cut process is canceled and the cut process's events created field activities, the cancel logic embodied in the algorithm can be quite sophisticated. Refer to [Field Activities To Cut And Reconnect Service](#) for an example.

Cut Processes and Events Are Created From Templates

When a cut process is created, its cut events are created by copying a cut process template's event types. Cut events follow the same lifecycle and possess the same behavior as [overdue events](#).

Cut Events Are Like Overdue Events

Cut events almost identical to [overdue events](#). The major difference is that cut events exists under a cut process and therefore are oriented towards the cut process's service agreement. The following topics describe other differences between cut events and overdue events.

Field Activities To Cut and Reconnect Service

A cut process that's created for a service agreement whose service can be severed will typically contain a cut event that creates field activity(s) to cut service. The base-package cut event activation algorithm will create field activities for the service points linked to the service agreement being cut. The type of activity is defined on the [field activity type profile](#) defined on each service point's SP type. Please see C1-CE-CR-FA for the exact details of the base-package algorithm.

If the cut process is canceled after field activity(s) are created and before the cut process completes, different activities can transpire. The specifics of what happens are controlled by a Cancel Logic algorithm plugged in on the [cut process template](#). The following points summarize how a base-package algorithm (C1-CP-DWFA) works:

- It assembles all Pending, Held and Complete cut for nonpayment field activities (FA) created by the cut process (these are defined in the overdue process's [log](#)).
- Each FA is processed as follows:
 - If the FA is Pending or Held and it is not linked to a field order (i.e., it hasn't been dispatched):
 - The FA is cancelled
 - An entry is added to the overdue process log to indicate the cancellation
 - If the FA is Pending or Held and it is linked to a field order (i.e., it has been dispatched):
 - A To Do entry is created (the To Do Type is defined on the algorithm)
 - If the FA is Complete and the Cut Process's SA is pending start or active (i.e., it hasn't been expired yet):
 - Reconnect field activity(s) are created for every service point that had a cut for non-payment field activity. The type of activity is defined on the [field activity type profile](#) defined on each service point's SP type.

A Cut Event Expires Service Agreements (and May Trigger Final Billing)

The last cut event is typically set up with an activation algorithm that expires the cut process's service agreement. If earlier cut events created "cut for non-payment" field activities, these field activities will be used as the basis for stopping service. Refer to [Finalizing Pending Stops](#) for how the system use the meter reads on these field activities as the "stop reads" on the service agreement. Note, you can see the field activities that are used to "cut" and "stop" service by viewing the Field Activities grid on [Service Agreement - Service Point](#).

NOTE:

Final billing. When the last service agreement linked to an account is expired, the system will schedule the account for billing (outside of its normal bill cycle schedule).

Write Offs Are Implemented Using Overdue Events

The system has been designed to allow overdue events on the original overdue process to write-off the objects being collected. Refer to [Writing Off Bills](#) for a case-study explaining how to do this.

Calendar vs. Work Days

When you set up your overdue and cut process templates, you supply information that controls how each event's trigger date is calculated. You have two options:

- You can say that an event's trigger date can only be populated after earlier, dependent events are complete. For example, the 2nd event (cut service) is triggered 2 days after the 1st event is complete (48 hour warning letter).
- You can say that an event's trigger date is populated when the process is first created. You simply define the number of days after the start of the process when each such event should be triggered. For example, the 2nd event (send cutoff warning) can be triggered 7 days after the start of the process.

In addition to the above, an option defined on the [Feature Configuration for Overdue Processing](#) plays a part in the calculation of an event's trigger date:

- If you set the option to use calendar days, the trigger date of events will be set to the first workday on / after the calculated date. For example, if you indicate that the 2nd event is triggered 7 days after the 1st event, the system will add 7 days to the 1st event's completion date. It then checks if this is a workday (and not a holiday); if so, this is the trigger date of the event; if not, it assigns the trigger date to the next workday.
- If you set the option to use workdays, the trigger date will be calculated by counting workdays. For example, if you indicate that the 2nd event is triggered 7 days after the 1st event, the system will count 7 workdays and set the trigger date accordingly.

NOTE:

Account's division controls the work calendar. The system uses the above information in conjunction with the [work calendar](#) associated with the account's division to determine workdays.

Bill-Oriented Collection - Advanced Topics

The topics in this section provide information on features designed to facilitate the collection of overdue bills.

Miscellaneous Bill-Oriented Collection Topics

The topics in this section provide background information about a variety of bill-oriented collection topics.

Highlights Of The Sample Overdue Monitor Rule Algorithm

A base-package Overdue Monitor Rule algorithm exists to support many different types of overdue rules (see C1-CB-CR-RAT). Keep in mind that multiple such algorithms can be plugged in on [Collection Class Overdue Rules](#). When the [Overdue Monitor](#) analyzes an account, it calls these algorithms until there are no more to invoke (or until an algorithm tells it that there is nothing more to check). The following points describe its various options:

- **Different rules based on credit ratings.** You can set up algorithms to only be applied to accounts with a credit rating \leq a given value. We anticipate such algorithms will be used in conjunction with other such algorithms to apply different rules based on the customer's credit rating.
- **Different rules based on an account or service agreement characteristic.** You can set up algorithms to only be applied if an account or one of its service agreements has a given characteristic type and value effective within the last X days. For example, you could set up an algorithm that would process an account if it had a broken payment arrangement service agreement within the last 365 days (broken payment arrangement service agreements are marked with a given char type and value). You could set up a different algorithm that treated strategic customers more leniently (given that the definition of "strategic" could be held in an account or service agreement characteristic).
- **Skipping a bill if it has a future postpone date.** You can set up algorithms to ignore an unpaid bill if it has a "postpone date" that's in the future. This date would be defined on the bill using an ad hoc characteristic. The characteristic type is defined as a parameter on the algorithm.
- **Special process for bills with disputed debt.** You can set up an algorithm to create a given type of overdue process if the bill has disputed debt. By "disputed debt", we mean a bill with a financial transaction that's linked to an unbalanced match event that's marked as Disputed.
- **Special process for bills with credit balances.** You can set up an algorithm to create a special overdue process if the bill's total charges are negative (i.e., a credit bill). Such bills should be very unusual as we strongly recommend that credit bills should have their credit balance applied to an overpayment service agreement during bill completion.
- **Different rules when all service agreements are inactive.** You can set up an algorithm that should only be applied if all service agreements are inactive. We anticipate this can be used to differ the type of overdue process as if an account does not have active service agreements; there is nothing to stop to encourage them to pay.
- **Different rules based on age and amount of a bill.** You can set up an algorithm to create different types of overdue processes based on the age and amount of the bills.

NOTE:

You are not limited by the base-package's rules. If your implementation requires options that are not supported by the base-package algorithm, simply develop your own.

Holding A Process's Events

Refer to [Holding Events](#) for a description of how to prevent the activation of an overdue / cut processes events while a given condition is true. The condition is defined in an algorithm so you can set up the system to prevent event activation for practically any condition. For example, you might want to hold event activation while the bill's account has an active case (e.g., a user might set up a case to conduct an ad hoc investigation of billing discrepancies). When the case closes, you'd want the process to start up where it left off.

Bill Info Shows Unpaid and Write-off Amounts

The base-package Bill Information algorithm (plugged in on the [Installation](#) record) is responsible for constructing a bill's summary information that appears throughout the system. This algorithm can be configured to show the unpaid and write-off amounts of each bill.

Writing Off Bills

The topics in this section provide background information on how to write off bills.

After Service Is Cut, Write-Off Oriented Events Can Commence

After the last service agreement has been stopped, overdue events to manage the write-off of the overdue process's bill(s) should be triggered. Please note that a separate overdue process is NOT created to manage write-offs. Rather, events associated with the original overdue process will handle the write-off activities.

Collection Agency Referrals

Before debt is written off, many implementations refer the unpaid bills to a collection agency. The following points describe how to implement this.

- Set up an overdue event type with an activation algorithm that refers an overdue process's bill(s) to a collection agency.
- When such an event is activated, the system creates a [Collection Referral](#) record for a collection agency. The specific agency to which the debt is referred is controlled by the event type's activation algorithm. The sample algorithm simply refers debt to the collection agency with the least amount of referred debt. If you prefer different logic, you must develop your own algorithm.
- A collection agency referral history record is linked to an account. It contains the amount of debt referred to the collection agency. It is the creation of this record that triggers the interface of information to the collection agency. The method used to interface the information to the agency is defined on the collection agency's record. Refer to [Setting Up Collection Agencies](#) for more information.
- If the collection agency is successful in obtaining the funds, a payment will be added. If the payment satisfies the cancel criteria defined on the overdue process template's cancellation plug-in, the overdue process will cancel. When an overdue process is cancelled, the cancel criteria on the overdue process's template are executed. We strongly recommend plugging in an algorithm that will cancel collection agency referrals when an overdue process is cancelled.
- If the collection agency is not successful in obtaining your funds after a given amount of time, you probably want to cancel the referral and write-off the debt. The cancellation of the referral will happen automatically if you set up your overdue process template to have an event that creates a collection agency cancellation X days after the referral. You can cancel a referral manually by simply creating a new collection agency referral history record (with a type of cancel).
- Collection agencies are notified of the cancellation of a referral by the creation of a new collection agency referral history record (with a type of cancel). This record will be interfaced to the agency in the same manner used to interface a new referral (see above).

NOTE:

Log entry. The base-package overdue event activation algorithms that make and cancel collection agency referrals insert rows in the overdue process's [log](#) to audit these events.

Writing Off Bills Will Create Write-Off Adjustments And Possibly A Match Event

Most overdue process templates will be configured to contain an event that writes-off the unpaid balance of bills.

NOTE:

Processing is redirected to another algorithm. The base-package overdue event activation algorithm that writes off bills simply redirects the call to the Write-Off Bill algorithm plugged in on the account's [Collection Class Overdue Rules](#). The reason for this redirection is because users can manually write-off a bill (using [Bill - Main](#)) and when they do this, we want to invoke the same logic as when an overdue process writes-off a bill.

The base-package Collection Class Overdue Rules - Write-Off Bill algorithm determines the amount that should be written off for each distribution code on each unpaid financial transaction. It then creates a separate adjustment for each service agreement where the lines on the adjustment contain the amount to be written off for each distribution code. If the unpaid financial transactions are not linked to a match event, the write-off adjustments plus the unpaid financial transactions will be linked to a new match event. If the unpaid financial transactions were linked to an unbalanced match event, the write-off adjustments will be added to the existing match event (thus making it balanced).

If partial payments were made against a bill, the amount written off will be prorated in light of the partial payments. For example, if 20% of a bill had been paid, 80% of each distribution code will be written off.

For example, assume the original bill's FT looked as follows (note, if the bill has multiple service agreements this will need to be done for each SA's FT's):

- Debit A/R \$110.00
- Credit Flat Charge Revenue (\$50)
- Credit Usage Revenue (\$50)
- Credit City Tax Payable (\$5)
- Credit State Tax Payable (\$5)

Assume the customer had made a partial payment of \$11 and it was matched to this FT. At write-off time, the system will create an adjustment whose adjustment lines will cause each distribution code to be written off by 90% (100% - \$11 / \$110). For example:

- Debit Flat Charge Revenue (or some W/O Expense) \$45
- Debit Usage Revenue \$45
- Debit City Tax Payable \$4.50
- Debit State Tax Payable \$4.50
- Credit A/R \$99

This adjustment will then be linked to the original match event on which the payment was linked (thus making it Balanced).

NOTE:

Log entry. The base-package overdue event activation algorithm that writes off bills inserts a row into the overdue process's [log](#) for each bill written off.

Small Amount Write-Downs

Many organizations will write-down a bill whose value is small early in an overdue process. The base-package overdue event activation algorithm has parameters to support this requirement (this algorithm allows you to write-off an overdue process's bill(s) if their value is less than a threshold amount).

If your organization writes-down small amounts differently than large amount, simply set up an overdue event type to reference such an activation algorithm and position it in the appropriate place in the overdue process template.

Bill Info Shows Written Off Amounts

The base-package Bill Information algorithm (plugged in on the [Installation](#) record) is responsible for constructing a bill's summary information that appears throughout the system. This algorithm can be configured to show the amount written-off for each bill.

Online Write Off Of Bills Is Performed On Bill-Main

If a bill's account is associated with a [Collection Class Overdue Rule](#) that has a Write Off Bill algorithm, a button appears on [Bill - Main](#) if the bill hasn't been written off. When clicked, the Write Off Bill algorithm is invoked to write-off the bill.

Online Reversal Of Written Off Bills Is Performed On Bill-Main

If a bill's account is associated with a [Collection Class Overdue Rule](#) that has a Write Off Bill algorithm, a button appears on [Bill - Main](#) if the bill has been written off. When clicked, the Write Off Bill algorithm is invoked (in reversal mode). The algorithm cancels the write-off adjustments (thus making the bill payable again). It also schedules the account for review by the [Overdue Monitor](#) the next time it runs.

Write Offs And Overdue Process Cancellation

It should be stressed that writing-off a bill may cause an overdue process to be canceled because the bill's FT will be linked to a balanced match event (note, the specific [cancel criteria](#) are in a plug-in so this is not a hard rule).

The following points highlight interesting aspects of bill write-off and overdue process cancellation:

- If a user writes off a bill [real time](#) and the bill has an Active overdue process, the process's cancel criteria will be invoked. This typically results in the cancellation of the overdue process.
- If an overdue event writes off a bill, the state of the process depends on your cancel criteria and where the overdue event is positioned in the overdue process. For example,
 - Imagine an overdue process that has an overdue event that writes off small amounts of debt early in the process. If such a process is applied against bill with a small amount of debt, the process will be canceled (when the event activates).
 - Contrast this to an overdue process where the last event writes off the bill. Because there are no other events to activate, the process will complete (i.e., it will not be canceled).

An Alert Can Show Written Off Bills

A base-package Control Central Alert algorithm (C1-WO-BILL) can be set up to highlight if the account in context has written off bills. This algorithm is plugged in on the [Installation](#) record.

Bill-Oriented Payment Arrangements

A payment arrangement is an agreement with a customer to payoff severely overdue debt in **billed** installments. Bills sent to customers with payment arrangements contain charges for both their current services and their payment arrangement installment amount.

NOTE:

Nomenclature. Some organizations refer to payment arrangements as "current bill plus" agreements because the customer's bills contain charges for both their current debt plus their installment amount. After the customer has paid off their overdue debt, the payment arrangement closes and the customer's bills only contain charges for their current debt.

The topics in this section describe how to set up a payment arrangement and how the system monitors the ongoing arrangements.

Creating Payment Arrangements

When you create a payment arrangement, you are actually creating a service agreement. This service agreement is just like other service agreements in that:

- It holds debt.
- It is periodically billed (thus creating unmatched bill segment financial transactions).
- When a payment is received, the payment segment financial transactions are matched to the bill segment financial transactions.

Debt is transferred to a payment arrangement service agreement (PA SA) from the customer's delinquent bills at the inception of the payment arrangement.

When you transfer debt from the overdue bills to a PA SA, transfer adjustments are created to transfer debt from the delinquent SAs to the PA SA. Match events are created to link the "transfer from" adjustments to the original unpaid financial transactions (FT). When all FT's on a bill are linked to balanced match events, the bill is no longer considered overdue and any active overdue process (and its related cut processes) will be cancelled. Refer to [How Are Overdue Processes Canceled](#) for more information.

NOTE:

Use the Payment Arrangement Transaction. Use the [Payment Arrangement - Bill Oriented](#) to set up bill-oriented payment arrangements. This transaction creates a PA SA, transfers overdue bills to it, and sets up the installment amount. This transaction is also used if you need to break or cancel the payment arrangement.

Installment, Payoff and Current Amounts

WARNING:

If you do not understand the difference between payoff balance and current balance, refer to [Current Amount versus Payoff Amount](#).

When you set up a payment arrangement service agreement (PA SA), you transfer delinquent debt to the PA SA using transfer adjustments. After moneys are transferred, the system sets the PA SA's current balance to zero. At this point, there

will be no overdue bills. If the customer neglects to pay bills containing charges associated with the payment arrangement, an overdue process will ensue.

PA SAs start their life with a non-zero payoff balance (i.e., they have debt when first started). This debt is transferred from the bills whose outstanding debt necessitated the creation of the PA SA.

The installment amount that the customer is billed is determined by the number of installments used to payoff the debt. For example, if the customer owes \$500 and they want to pay this off in 10 installments, you'd set up the installment amount to be \$50. The installment amount is saved on the PA SA's recurring charge amount. If the customer again falls into arrears on their bills, you can transfer additional bills to the PA SA. You can also change the installment amount as needed.

A PA SA's payoff balance typically differs from its current balance. The payoff balance is the amount of debt remaining to be paid off under the terms of the payment arrangement. The current balance is the installment amount that has been billed but not paid. For example, a customer who is paying off \$500 with 10 installments of \$50 would have an initial payoff balance of \$500 and a current balance of \$0. After the first bill, the PA SA would still have a payoff balance of \$500, but its current balance would be \$50. When the customer pays, the PA SA's payoff balance would fall to \$450 and its current balance would return to \$0.

The following table contains a financial example of a customer who sets up a payment arrangement to payoff \$1,000 of debt in \$10 installments.

Event	Normal SA's GL Accounting	PA SA's GL Accounting	Normal SA's Current Balance	Normal SA's Payoff Balance	PA SA's Current Balance	PA SA's Payoff Balance
Prior to creation of payment arrangement	N/A	N/A	1000	1000	N/A	N/A
Transfer debt from normal SA(s) to PA SA	Xfer 1000 A/R <1000>	PA A/R 1000 Xfer <1000>	0	0	1000	1000
Set current balance to zero on PA SA	N/A	N/A	0	0	0	1000
Customer is billed (\$50 for new debt and \$10 of payment arrangement debt)	A/R 50 Revenue <50>	N/A	50	50	10	1000
Customer pays \$60	Cash 50 A/R <50>	Cash 10 PA A/R <10>	0	0	0	990

When the customer pays off the payment arrangement debt, the system automatically closes the PA SA after it final bills (assuming the PA SA's SA type references a bill segment type that has a bill segment creation algorithm of Recurring Charge With Auto Stop).

Breaking A Bill-Oriented Payment Arrangement

If a customer neglects to pay a bill, an overdue process is created. If the bill contains charges from a payment arrangement, you'll want to "break" the payment arrangement. By "break", we mean cancel the arrangement and reinstate the debt under the originating bills. To do this, you must configure the [cut process template](#) used to cut the PA SA to contain a cut event that breaks the payment arrangement.

NOTE:

Processing is redirected to another algorithm. The base-package cut event activation algorithm that breaks a payment arrangement simply redirects the call to the Bill-Based Payment Arrangement algorithm plugged in on the account's [Collection Class Overdue Rules](#). The reason for this redirection is that users can manually break a payment arrangement (using [Payment Arrangement - Bill Oriented](#)). When they do this, we want to invoke the same logic as when a cut event activation algorithm breaks a payment arrangement.

The base-package Collection Class Overdue Rule - Bill-Based Payment Arrangement algorithm does the following:

- Creates "cancel adjustments" for all unpaid financial transactions associated with the payment arrangement (e.g., billed, but not paid installments).
- Cancels ALL adjustments that were used to transfer the debt to the payment arrangement. When these are cancelled, the original bills will become unpaid (and the debt will be rather old by this point).
- Syncs up current balance with payoff balance on the PA SA.
- Makes the PA SA pending stop and expires it (SA activation will stop the SA when it next runs).
- If there is a credit left on the PA SA (because payments were made against the arrangement), the credit will be distributed amongst the bills that contributed debt to it (the oldest bills are paid off first). This relief will occur via transfer adjustments from the PA SA to the original SAs.
- Note, if there is a debit left (e.g., because LPC were issued or some other type of adjustment was created by an operator), an error is issued as we don't handle new debit on a payment arrangement.
- Inserts a characteristic on the PA SA to indicate that it has been broken (you might want to use this to cause more strict overdue rules to be applied to accounts with broken payment arrangements).
- Marks the account so it will be reviewed by the [Overdue Monitor](#) the next time it runs.

NOTE:

The PA SA must final bill before it closes. It's important to note that the PA SA will only close after the PA SA is final billed. This is OK as it won't have any money left on it.

When the Overdue Monitor next runs, it will analyze the account's reinstated bills. We recommend setting up a Collection Class Overdue Rule - Overdue Monitor Rule algorithm that has more stringent rules if the account has a broken payment arrangement within the last X days. The base-package algorithm (C1-CB-CR-RAT) supports this type of processing.

NOTE:

Log entry. The base-package overdue event activation algorithm that breaks a payment arrangement SA inserts a row into the overdue process's [log](#).

Online Breaking

A user can click a button on the [Payment Arrangement - Bill Oriented](#) page to break a payment arrangement real time. When clicked, the Collection Class Overdue Rule - Bill-Based Payment Arrangement algorithm is called to break the payment arrangement. This is the same algorithm called when a cut event break a payment arrangement.

Online Canceling

A user can click a button on the [Payment Arrangement - Bill Oriented](#) page to cancel a payment arrangement real time. Cancellation should be used when you want to "logically delete" a PA SA because it shouldn't have been created.

The logic described above for breaking a payment arrangement is executed when a user cancels a payment arrangement; the only difference is that the PA SA is marked with a different characteristic type / value than when it is broken. The "broken" characteristic type / value can be used to apply stricter rules to the account when it's next reviewed by the [Overdue Monitor](#).

Creating Overdue and Cut Procedures

Your overdue procedures define how your organization collects overdue debt. Your cut procedures define how your organization cuts (i.e., stops) service agreements when collection attempts fail. In this section, we describe how to set up the data that controls these procedures.

WARNING:

There are numerous ways to design your overdue and cut procedures. Some designs will result in easy long-term maintenance; others will result in maintenance headaches. In this section, we provide information to help you understand the ramifications of the various options. Before you set up your overdue and cut procedures, we encourage you to gain an intuitive understanding of these options by using the system to prototype the alternatives.

Designing Your Overdue Procedures

The design of your overdue procedures is an iterative process. Over time, you will develop skills that will allow you to skip some steps. However, when you're starting out, we recommend you use the following matrix as your guide. When the matrix is complete, you're ready to set up the overdue processing control tables.

Account's Division	Account's Collection Class:	Account's Collection Class:

The topics discussed below will gradually complete this matrix using a simple case study.

FASTPATH:

For more information about how the information in this matrix is used to monitor your customers' debt, refer to [How Does The Overdue Monitor Work](#).

Your Divisions Are Frequently Preordained

An account's division defines the jurisdiction whose rules govern the account. For example, an account's division controls how its payments are distributed, if / how late payment charges are levied, etc. Divisions have typically been designed in advance of designing your overdue rules.

In our example, we assume you have two divisions: North and South.

Account's Division	Account's Collection Class:	Account's Collection Class:
North		
South		

Designing Your Collection Classes

Multiple collection classes are needed when your organization has different overdue rules and / or procedures based on the type of customer. If all customers are treated the same way, you'll have a single collection class (call it Generic). However, if you're like many organizations, you will have multiple collection classes.

For example, for commercial/industrial customers, you probably don't worry until they owe you more than, say, \$100 after 20 days. For residential customers, you probably don't worry until they owe you more than, say, \$5 after 20 days. In this situation, you will have at least two collection classes: one for commercial/industrial customers, the other for residential customers.

In our example, we assume you have two collection classes: Residential and Commercial/Industrial.

Account's Division	Account's Collection Class:	Account's Collection Class:
	Residential	Commercial/Industrial
North		
South		

NOTE:

There are two very different ways to monitor your accounts for overdue debt. This chapter describes the method referred to as Overdue Processing. Refer to [Collection / Severance / Write Off](#) for a description of the other method. We anticipate that most organizations will only use a single method. If your organization opts to use both methods, you will need to set up the corresponding collection classes.

Designing Overdue Monitoring Rules

At this point, we have the rows and columns defined in our matrix. Now it's time to work on the individual cells.

NOTE:

Single currency. We've assumed that your implementation works in a single currency. If this is not true, you will need to add a 3rd dimension that will have a value for each currency code.

Each cell will contain the rules that the [Overdue Monitor](#) uses to determine if an account has overdue debt. These rules will eventually be configured using one or more algorithms on [Collection Class Overdue Rules](#).

Account's Division	Account's Collection Class:	Account's Collection Class:
	Residential	Commercial/Industrial
North		
South		

NOTE:

If the Overdue Monitor encounters an account whose collection class and division does not have overdue rules set up, it will issue an error.

Determining the rules in each cell can be straightforward or complicated; it depends on how your organization works. Our case study assumes the following:

- For residential debt (regardless of division) we have the following rules:
 - Highest priority. If a bill exists with unpaid FT's > \$0 that is older than 50 days, create the "accelerated overdue process" for residential customers. We'll talk more about this process later.

- Medium priority. If the account's has a broken payment arrangement within the last 60 days with an unpaid bill > \$0 that is older than 20 days, create the "broken payment arrangement overdue process".
- Lower priority. If a bill exists with unpaid FT's > \$25 that is older than 25 days, create the "courtesy reminder overdue process" for residential customers. We'll talk more about this overdue process later.
- For commercial-industrial debt (regardless of division) we have the following rules:
 - Highest priority. If a bill exists with unpaid FT's > \$0 that is older than 45 days, create the "commercial 45 days late overdue process". We'll talk more about this process later.
 - Medium priority. If the account's credit rating is < 550 and has an unpaid bill > \$0 that is older than 20 days, create the "risky commercial customer overdue process".
 - Lower priority. If a bill exists with unpaid FT's > \$100 that is older than 30 days, create the "commercial 30 days late overdue process". We'll talk more about this overdue process later.

Given the above, our matrix will look as follows:

Account's Division	Account's Collection Class:	
	Residential	Commercial/Industrial
North	<p>Highest Priority: If a bill exists with unpaid FT's > \$0 that is older than 50 days, create the accelerated overdue process for residential customers.</p> <p>Medium Priority: If the account has a broken payment arrangement within the last 60 days with an unpaid bill > \$0 that is older than 20 days, create the broken payment arrangement overdue process.</p> <p>Lowest Priority: If a bill exists with unpaid FT's > \$25 that is older than 25 days, create the courtesy reminder overdue process for residential customers.</p>	<p>Highest Priority: If a bill exists with unpaid FT's > \$0 that is older than 45 days, create the commercial 45 days late overdue process.</p> <p>Medium priority. If the account's credit rating is < 550 and has an unpaid bill > \$0 that is older than 20 days, create the risky commercial customer overdue process.</p> <p>Lowest Priority: If a bill exists with unpaid FT's > \$100 that is older than 30 days, create the commercial 30 days late overdue process.</p>
South	Same as above	Same as above

NOTE:

The rules are limited by your imagination (and business requirements). While the base-package Overdue Monitor Rule algorithm (C1-CB-CR-RAT) supports the above scenarios, we'd like to stress these are just examples. Your implementation can operate using very different rules by either configuring the base-package algorithm (it has many parameters that you can use to tailor your rules) OR by introducing a new algorithm. Refer to [Highlights Of The Sample Overdue Monitor Rule Algorithm](#) for the options delivered with the base-package.

Designing Overdue Process Templates and Event Types

The following table shows a sample overdue process template for one of the rules in the Residential / North cell in the previous section's matrix.

Overdue Process Template	Overdue Event Type	When Triggered
Accelerated overdue process for residential customers	Old debt letter	At inception of process
	Cut active service agreements	10 days after inception

Reduce customer's credit rating	10 days after inception (i.e., at the same time the cut process is created)
Write down small debt	0 days after completion of the cut process(es)
Refer debt to collection agent	0 days after attempting the small write down (this means that either the small write-down or the agency referral will take place as if the write-down is successful, the bill's FTs will be matched to balanced match events and the overdue process will stop)
Cancel collection agent referral	45 days after referral
Write-off debt	0 days after collection agent cancellation

You should create a similar table for each of the distinct overdue process templates in your matrix.

At this point, you've designed the distinct overdue process templates. Next, you'll need to design the algorithms that control their overdue processes:

- A template's Calculate Unpaid and Original Amount algorithm calculates the original and unpaid amounts of the objects being collected by a process. These values are used throughout the overdue processing module.
- A template's Cancel Criteria algorithm is executed to determine if a process should be cancelled. Refer to [How Are Overdue Processes Cancelled](#) for the details.
- A template's Cancel Logic algorithm is executed to cancel a process. Refer to [How Are Overdue Processes Cancelled](#) for the details. Please note that the logic embodied in this type of algorithm can be sophisticated because it is responsible for stopping an ongoing process's activities (e.g., this could involve cancelling field activities or cases). Cancellation algorithms are also responsible for inserting [log](#) entry(s).
- A template's Hold Event Activation algorithm is invoked to determine if the [Overdue / Cut Event Manager](#) should [suspend the activation](#) of the process's events.
- A template's Information algorithm is invoked to construct the [override "info string"](#).

Next, extract each unique event type from the above table:

Overdue Event Type	Action
Old debt letter	Create a customer contact
Cut active service agreement(s)	Start a cut process for every active SA with an unpaid FT on the bill
Reduce customer's credit rating	Insert an account credit rating history record
Write down small debt	Create write-down adjustments if unpaid debt is less than \$x
Refer debt to collection agent	Create a collection agency referral
Cancel collection agent referral	Cancel the collection agency referral
Write off unpaid debt	Create adjustments to write-off unpaid debt

At this point, you know the distinct event types. Next, you'll need to design the algorithms that control the lifecycle of each event type:

- The event type's Event Activation algorithm(s) are executed by the [Overdue / Cut Event Manager](#) on its trigger date. The following points describe the logic embodied in such an algorithm:
 - The activity that happens on the trigger date (e.g., creation of a customer contact, To Do, etc.). Refer to [Overdue Events Can Do Many Things](#) for the details.

- Whether the event is transitioned into the Waiting or Complete state when it's triggered. Refer to [Some Events Can Wait](#) for the details.
- How the log entry(s) associated with event activation will be constructed. The base-package algorithms allow you to control the verbiage in the log entry by defining the desired message number on the algorithm. This means that you may have to set up new messages. Refer to [Activating Events Should Add A Log Entry](#) for the details.
- The event type's Cancel Logic algorithm(s) are invoked when [an event is cancelled](#). The following points describe the logic embodied in such an algorithm:
 - If the event is allowed to be canceled. This logic may be necessary if some conditions prevent events of this type from canceling. For example, you may want to prevent an event from canceling when there are later dependent events that aren't canceled.
 - Any ancillary actions that take place during cancellation.
 - How the [log entry\(s\)](#) associated with event cancellation will be constructed.
- The event type's Monitor Waiting Event algorithm(s) are invoked to [monitor a waiting event](#). These algorithms are responsible for transitioning a Waiting event to Complete if the object on which it's waiting is complete.
- The event type's Event Information algorithm is invoked to construct the [override "info string"](#).

Once you've designed each event type's algorithms, you're ready to design your cut processes.

Designing Cut Process Templates and Event Types

While not required, many overdue processes will contain an overdue event that cuts (i.e., stops) service (in the hopes that stopping service will inspire the customer to pay). When such an event activates, it creates one or more cut process(es).

The system allows you to control if and how service is cut by setting up Cut Process Rule algorithms on your SA types. This allows different rules for different types of service agreements. In addition, because these rules are embodied in algorithms, a given SA type can have conditional logic that controls the type of cut process created. For example, you may have a different cut process if the customer has life support equipment, or if it's winter, or ...

NOTE:

If a service agreements of a given type should never be cut. If you have certain SA types that should never be cut, do NOT define an algorithm in the SA type's Cut Process Rule .

Determining your Cut Process Rules can be straightforward or complicated; it depends on how your organization works. Our case study assumes the following:

- For service agreements associated with metered service, we have the following rules:
 - Highest priority. If the customer has life support requirements, create "cut process in light of life support" process.
 - Lowest priority. Otherwise, create a "metered service" cut process.
- For service agreements associated with charitable contributions, create an "expiration only" cut process.

Once you've determined if / how each SA type is cut, you need to design your cut process templates (you'll need one for each unique method of cutting a service agreement). The following table shows the cut process templates referenced above. Adjacent to each process are its events and an indication of when they are triggered.

Cut Process Template	Event Number	Cut Event Type	Dependent On Event(s)	Trigger Date Set To X Days After Completion Of Dependent Events

Metered service	10	Letter - 48 hour disconnect for non-payment warning	N/A - first event	0
	20	Field activity - disconnect for non-payment	10	2
	30	'Service has been disconnected' letter	20	0
	40	Expire service agreement	20	10
Cut process in light of life support	10	Generate delinquent life support customer To Do entry (seeking approval for the cut)	N/A - first event	0
	20	Letter - 72 hour disconnect for non-payment warning	10	0
	30	Generate impending life support cutoff To Do entry to C&C rep	20	3
	40	Field activity - cut for non-payment	30	0
	50	Service has been disconnected letter	40	0
	60	Expire service agreement	40	10
Expiration only	10	Expire service agreement	N/A - first event	

At this point, you've designed the distinct cut process templates. Next, you'll need to design the algorithms that control the lifecycle of their cut processes:

- A template's Cancel Logic algorithm is executed to cancel a process. In addition to cancelling the event, these algorithms are also responsible for inserting [log](#) entry(s).
- A template's Information algorithm is invoked to construct the [override "info string"](#).

Next, extract each unique event type from the above table:

Cut Event Type	Action
48-hour warning letter	Create a customer contact - 48-hour warning letter (letters are created via customer contacts)
72-hour warning letter	Create a customer contact - 72-hour warning letter
Disconnect for non payment	Create a cut for non-payment field activity
Permission to start a cut process for a life support customer	Create To Do seeking permission to send 72 hour letter
Permission to create a cut field activity for a life support cutoff	Create To Do seeking permission to issue a cut field activity
Service has been disconnected letter	Create a customer contact - service cut letter
Expire service agreement	Expire service agreement

At this point, you know the distinct event types. Next, you'll need to design the algorithms that control the lifecycle of their events:

- The event type's Event Activation algorithm(s) are executed by the [Overdue / Cut Event Manager](#) on its trigger date. The following points describe the logic embodied in such an algorithm:
 - The activity that happens on the trigger date (e.g., creation of a customer contact, To Do, etc.). Refer to [Cut Events Can Do Many Things](#) for the details.
 - Whether the event is transitioned into the Waiting or Complete state when it's triggered. Refer to [Some Events Can Wait](#) for the details.
 - How the log entry(s) associated with event activation will be constructed. The base-package algorithms allow you to control the verbiage in the log entry by defining the desired message number on the algorithm. This means that you may have to set up new messages. Refer to [Activating Events Should Add A Log Entry](#) for the details.
- The event type's Cancel Logic algorithm(s) are invoked when [an event is cancelled](#). The following points describe the logic embodied in such an algorithm:
 - If the event is allowed to be canceled. This logic may be necessary if some conditions prevent events of this type from canceling. For example, you may want to prevent an event from canceling when there are later dependent events that aren't canceled.
 - Any ancillary actions that take place during cancellation.
 - How the [log entry\(s\)](#) associated with event cancellation will be constructed.
- The event type's Monitor Waiting Event algorithm(s) are invoked to [monitor a waiting event](#). These algorithms are responsible for transitioning a Waiting event to Complete if the object on which it's waiting is complete.
- The event type's Event Information algorithm is invoked to construct the [override "info string"](#).

Set Up Tasks

The above topics provided background information about how overdue processing works. The following discussion summarizes the various set up tasks.

Cut Event Types

You will find that most of the time spent setting up your cut event types is spent setting up the objects that are referenced on the cut event type algorithms. For example, if you use the base-package algorithms, you may need to set up the following:

- The various "types" for the objects created by the plug-ins. For example, if a cut event type creates a To Do entry, you must supply the desired To Do type.
- [Foreign key characteristic types](#) that are used to reference the ancillary objects in the [log entries](#) (e.g., if an event creates a customer contact, the log references this customer contact using a FK characteristic type). Note, many of these will exist in the base-package.
- [Messages](#) that are used to define the verbiage in the [log entries](#). For example, if you use the base-package algorithm that creates a customer contact, you must supply the desired message category and number that contains the verbiage that appears in the log when customer contacts are created. Note, messages have been set up for all base-package algorithms (this means you should not have to set up new messages).
- Etc.

The only way to compile the complete list is to design the parameters for each cut event type algorithm. Refer to [Cut Event Type - Main](#) for the supported plug-in spots.

After you've set up the objects referenced on the algorithms, you can then set up the algorithms. Only then can you set up the cut event types.

Cut Process Templates

After your cut event types exist, you can set up your cut process templates. You will find that most of the time spent setting up your cut process templates is spent setting up the objects that are referenced on the cut process template algorithms. Refer to [Cut Process Template - Main](#) for the supported system events.

SA Type - Cut Process Rules

After you've created your cut process templates, you can set up the algorithms that hold your [cut process rules](#). These are plugged-in on [SA Type - Algorithm](#) in the Cut Process Rule system event.

Overdue Event Types

You will find that most of the time spent setting up your overdue event types is spent setting up the objects that are referenced on the overdue event type algorithms. For example, if you use the base-package algorithms, you will set up the following:

- The various "types" for the objects created by the plug-ins. For example,
 - If an overdue event type creates a To Do entry, you must set up the To Do type.
 - If an overdue event type creates a customer contact, you must set up the customer contact type.
 - If an overdue event type writes off debt, you must set up the adjustment types.
 - Etc.
- [Foreign key characteristic types](#) that are used to reference the ancillary objects in the [log entries](#) (e.g., if an event creates a customer contact, the log references this customer contact using a FK characteristic type). Note, many of these will exist in the base-package.
- [Messages](#) that are used to define the verbiage in the [log entries](#). For example, if you use the base-package algorithm that creates a customer contact, you must supply the desired message category and number that contains the verbiage that appears in the log when customer contacts are created. Note, messages have been set up for all base-package algorithms (this means you should not have to set up new messages).
- Etc.

The only way to compile the complete list is to design the parameters for each overdue event type algorithm. Refer to [Overdue Event Type - Main](#) for the supported plug-in spots.

After you've set up the objects referenced on the algorithms, you can then set up the algorithms. Only then can you set up the overdue event types.

Overdue Process Templates

After your overdue event types exist, you can set up your overdue process templates. You will find that most of the time spent setting up your overdue process templates is spent setting up the objects that are referenced on the overdue process template algorithms. Refer to [Overdue Process Template - Main](#) for the supported system events.

Collection Classes

Set up [collection classes](#) as per your [overdue procedures](#). Make sure to indicate that these collection classes use the Overdue collection method (only accounts linked to collection classes designated as using the Overdue collection method or processed by the Overdue Monitor).

Collection Class Overdue Monitor Rules

After your overdue process templates exist, you can set up your Overdue Monitor Rules. These rules are algorithms plugged in on [Collection Class Overdue Rules](#). You will find most of the time spent setting up these algorithms is spent setting up the objects referenced on the base-package algorithm.

Feature Configuration

You must set up a [Feature Configuration](#) to define parameters that control various overdue processing options.

The following points describe the various **Option Types** that must be defined:

- Trigger Date: Y-Workdays, N-Calendar Days. This option controls how the system computes the trigger dates on overdue and cut events. Enter Y if the system should use workdays. Enter N if the system should use calendar days. Refer to [Calendar vs Work Days](#) for the details.
- Payment Arrangement Type (B/S/A). This option indicates whether your implementation uses the [Balance-Oriented Payment Arrangements](#) (value **S**), [Bill-oriented Payment Arrangements](#) (value **B**) or both (value **A**). The value governs the navigation path for the payment arrangement lines in the [Account History](#) and [Credit & Collection](#) zones.
- Champion Template\$Challenger Template\$Percentage(1-100). You need only set up options of this type if your implementation implements [Champion / Challenger](#) functionality. Options of this type are entered in the format A \$B\$nnn where A is the overdue process template of the champion template, B is the overdue process template of the challenger template, and C is the percent of the time that the system should create the challenger template. The overdue monitor uses this option to override the champion overdue process template X% of the time with the challenger template. You may enter any number of these options (but only one per Champion Template).

Overdue and Cut Event Cancellation Reasons

Overdue events can be cancelled automatically and manually (at the discretion of a user). Regardless of the method of cancellation, a cancellation reason must be supplied. You set up your overdue event cancellation reasons using [Overdue Event Cancellation Reason - Main](#) and [Cut Event Cancellation Reason - Main](#).

Collection Agencies

If you refer debt to collection agents, you must set up your [collection agencies](#).

Alert To Highlight Active Overdue Processes

If you want an alert to appear if the account has active overdue processes, you must configure an appropriate Control Central Alert algorithm (C1-OD-PROC). This algorithm is plugged in on the [Installation](#) record.

Bill-Oriented Collection - Additional Set Up

The topics in this section provide information on additional set up requirements if you collect on unpaid bills.

One Bill Per Match Event

As mentioned earlier, a bill is considered paid if its financial transactions (FTs) are linked to a balanced match event. To determine a bill's outstanding amount, FTs from different bills cannot be commingled on the same match event (but it's OK for a bill's FTs to be on multiple match events). If you stick by the rule of "just one bill per match event" you will then be able to determine the outstanding balance of a partially paid bill. However, if you mix more than one bill under a match event, a particular bill's balance may become indeterminate.

The following Open-Item algorithm types have been provided by the base package to help enforce this rule:

- The Distribute by Bill Due Date Payment Distribution algorithm (C1-PYDS-BDU).
- The match by Bill ID Payment Distribution Override algorithm (C1-PDOV-PYBL).
- The FT cancellation FT Freeze algorithm (C1-CFTZ-COFT).

If any of your customized plug-ins and processes create match events, it is important that these too enforce this rule. You may want to refer to the base package algorithms as an example of how to do this.

Bill-Based Payment Arrangements

If you set up [payment arrangements for unpaid bills](#), you must configure the Bill-Based Payment Arrangement algorithm and plug it in on your [Collection Class Overdue Rules](#).

It's important to set up the adjustment types used during payment arrangement creation to NOT print on bills. This is because the base-package algorithm will match the adjustments used to transfer debt to the payment arrangement with the adjustment used to reduce the payment arrangement's current amount by the amount of the transfer if all adjustment types are set up to not print.

Bill-Based Write-off

If you [write-off unpaid bills](#), you must set up the following:

- Set up the adjustment type that will be used to write-off an unpaid financial transaction. This adjustment type must be configured as follows:
 - **Adjustment Amount Type** must be Calculated Amount
 - Its distribution code is irrelevant as a separate calculation line will be created for each distribution code on the FT's that is written off and these lines will reference the appropriate distribution code.
 - It must reference an adjustment type char type / value that identifies it as one used to write-off a bill's FTs
 - The following algorithms must be defined on the adjustment type:
- The Generate Adjustment system event must reference an algorithm that has the responsibility of determining how to write-off a FT. This algorithm should be determining the FT's GL details and creating a separate adjustment calculation line for each GL detail. The base package is supplied with a sample algorithm that does this (C1-ADJG-WO).

- The Adjustment Financial Transaction system event should reference an algorithm that impacts current, payoff and the GL by the amount being written off.
- The distribution codes referenced on the financial transactions must be set up with a characteristic that holds the distribution code used to write-off the original amounts. For example,
 - Distribution codes used to record tax liabilities will typically reference the same distribution code for write-off (most organizations reverse tax liabilities at write-off time)
 - Distribution codes used to record revenue will typically reference a write-off distribution code used to record a write-off expense.
 - Distribution codes used to record receivables will typically not reference a write-off distribution code because receivables are implicitly written off when revenue and tax liabilities are written off.
- Set up an adjustment cancellation code used when a users reverses a written-off bill (reversal involves canceling the write off adjustments).
- Set up a Write Off Bill algorithm and plug it in on your [Collection Class Overdue Rules](#). This algorithm will reference the adjustment type described in the previous point.

Alert To Highlight Written Off Bills

If you want an alert to appear if the account has bills with written-off debt, you must configure an appropriate Control Central Alert algorithm (C1-WO-BILL). This algorithm is plugged in on the [Installation](#) record.

Open-Item Bill Amount Plug-In

You must set up the algorithm that computes the original, unpaid, and write-off amounts of your open-item bills. This algorithm is called by other algorithms when these amounts are needed. This algorithm is plugged-in on [Installation](#) in the Determine Open Item Bill Amounts spot.

Setting Up Overdue Processing

The topics in this section describe how to set up the control tables to implement your overdue processing.

Setting Up Overdue Event Types

An overdue event type encapsulates the business rules that govern a given type of overdue event. Open **Admin > Credit & Collection > Overdue Event Type > Add** to set up overdue event types.

NOTE:

Recommendation. Before using this transaction, we strongly recommend that you review [The Big Picture Of Overdue Events](#).

Description of Page

Enter a unique **Overdue Event Type** code and **Description** for the overdue event type.

Use **Long Description** to provide a more detailed explanation of the purpose of the overdue event type.

The **Algorithms** grid contains algorithms that control important functions. You must define the following for each algorithm:

- Specify the algorithm's **System Event** (see the following table for a description of all possible events).
- Specify the **Algorithm** to be executed when the System Event executes. Set the **Sequence** to 10 unless you have a **System Event** that has multiple **Algorithms**. In this case, you need to tell the system the **Sequence** in which they should execute.

The following table describes each **System Event** (note, all system event's are optional and you can define an unlimited number of algorithms for each event).

System Event	Optional / Required	Description
Cancel Logic	Required	This algorithm is executed to cancel an overdue event. Refer to How Are Events Canceled for the details.
Event Activation	Required	This algorithm is executed to activate an overdue event on its trigger date. Refer to Overdue Events Can Do Many Things and How and When Events Are Activated for the details.
Event Information	Optional - only used if you want to override an overdue event's info string	This algorithm is executed to construct an overdue event's override info string. Refer to Overdue Event Information Is Overridable for the details.
Monitor Waiting Events	Optional - only used if events of this type can enter the Waiting state	This algorithm is invoked by the Overdue / Cut Event Manager for events in the Waiting state. Refer to Some Events Wait For Something Before Completing for the details.

Setting Up Overdue Process Templates

An overdue process template encapsulates the business rules that govern a given type of overdue process. Open **Admin > Credit & Collection > Overdue Process Template > Add** to set up overdue process templates.

NOTE:

Recommendation. Before using this transaction, we strongly recommend that you review [The Big Picture Of Overdue Processes](#).

Description of Page

Enter a unique **Overdue Process Template** and **Description** for the overdue process template.

Collecting On Object defines the type of object managed by this overdue process. This field actually references a [foreign key characteristic type](#) that references the managed object. For example, if this overdue process template manages overdue bills, you'd reference a foreign key characteristic that references the bill object.

The **Algorithms** grid contains algorithms that control important functions. You must define the following for each algorithm:

- Specify the algorithm's **System Event** (see the following table for a description of all possible events).

- Specify the **Algorithm** to be executed when the System Event executes. Set the **Sequence** to 10 unless you have a **System Event** that has multiple **Algorithms**. In this case, you need to tell the system the **Sequence** in which they should execute.

The following table describes each **System Event** (note, all system event's are optional and you can define an unlimited number of algorithms for each event).

System Event	Optional / Required	Description
Calculate Unpaid & Original Amount	Required	This algorithm is executed to calculate the unpaid and original amounts of the objects associated with the overdue process. These amounts are shown on the overdue process page and in the base-package overdue info string .
Cancel Criteria	Required	This algorithm is executed to determine if an overdue process can be cancelled. Refer to How Are Overdue Processes Cancelled for the details.
Cancel Logic	Required	This algorithm is executed to cancel an overdue process. Refer to How Are Overdue Processes Cancelled for the details.
Hold Event Activation Criteria	Optional - only used if overdue processes of this type can be suspended while some condition is true	This algorithm is executed to determine if the activation of overdue and cut events should be suspended. Refer to Holding Events for the details.
Overdue Process Information	Optional - only used if you want to override an overdue process's info string	This algorithm is executed to construct an overdue process's override info string. Refer to Overdue Process Information Is Overridable for the details.

The **Event Types** control the number and type of overdue events linked to an overdue process when it is first created. The information in the scroll defines these events and the date on which they will be triggered. The following fields are required for each event type:

- Event Sequence.** Sequence controls the order in which the overdue event types appear in the scroll.
- Overdue Event Type.** Specify the type of overdue event to be created.
- Days After.** If **Dependent on Other Events** is on, events will be triggered this many days after the completion of the dependent events (specified in the grid). Set this value to 0 (zero) if you want the event triggered immediately after the completion of the dependent events. If **Dependent on Other Events** is off, events will be triggered this many days after the creation of the overdue process. Refer to [How and When Events Are Activated](#) for the details.
- If **Dependent on Other Events** is on, define the events that must be completed or cancelled before the event will be triggered.
 - Sequence** is system-assigned and cannot be specified or changed.
 - Dependent on Sequence** is the sequence of the dependent event.

Setting Up Cut Event Types

A cut event type encapsulates the business rules that govern a given type of cut event. Open **Admin > Credit & Collection > Cut Event Type > Add** to set up cut event types.

NOTE:

Recommendation. Before using this transaction, we strongly recommend that you review [Cut Events Are Like Overdue Events](#).

Description of Page

Enter a unique **Cut Event Type** code and **Description** for the cut event type.

Use **Long Description** to provide a more detailed explanation of the purpose of the cut event type.

The **Algorithms** grid contains algorithms that control important functions. You must define the following for each algorithm:

- Specify the algorithm's **System Event** (see the following table for a description of all possible events).
- Specify the **Algorithm** to be executed when the System Event executes. Set the **Sequence** to 10 unless you have a **System Event** that has multiple **Algorithms**. In this case, you need to tell the system the **Sequence** in which they should execute.

The following table describes each **System Event**.

System Event	Optional / Required	Description
Cancel Logic	Required	This algorithm is executed to cancel a cut event. Refer to How Are Events Canceled for the details.
Event Activation	Required	This algorithm is executed to activate a cut event on its trigger date. How and When Events Are Activated for the details.
Event Information	Optional - only used if you want to override a cut event's info string	This algorithm is executed to construct a cut event's override info string. Refer to Cut Event Information Is Overridable for the details.
Monitor Waiting Events	Optional - only used if events of this type can enter the Waiting state	This algorithm is invoked by the Cut / Cut Event Manager for events in the Waiting state. Refer to Some Events Wait For Something Before Completing for the details.

Setting Up Cut Process Templates

A cut process template encapsulates the business rules that govern a given type of cut process. Open **Admin > Credit & Collection > Cut Process Template > Add** to set up cut process templates.

NOTE:

Recommendation. Before using this transaction, we strongly recommend that you review [The Big Picture Of Cut Processes](#).

Description of Page

Enter a unique **Cut Process Template** and **Description** for the cut process template.

The **Algorithms** grid contains algorithms that control important functions. You must define the following for each algorithm:

- Specify the algorithm's **System Event** (see the following table for a description of all possible events).
-

- Specify the **Algorithm** to be executed when the System Event executes. Set the **Sequence** to 10 unless you have a **System Event** that has multiple **Algorithms**. In this case, you need to tell the system the **Sequence** in which they should execute.

The following table describes each **System Event**.

System Event	Optional / Required	Description
Cancel Logic	Required	This algorithm is executed to cancel a cut process. Refer to How Are Cut Processes Cancelled for the details.
Cut Process Information	Optional - only used if you want to override a cut process's info string	This algorithm is executed to construct a cut process's override info string. Refer to Cut Process Information Is Overridable for the details.

The **Event Types** control the number and type of events linked to a cut process when it is first created. The information in the scroll defines these events and the date on which they will be triggered. The following fields are required for each event type:

- **Event Sequence.** Sequence controls the order in which the cut event types appear in the scroll.
- **Cut Event Type.** Specify the type of cut event to be created.
- **Days After.** If **Dependent on Other Events** is on, events will be triggered this many days after the completion of the dependent events (specified in the grid). Set this value to 0 (zero) if you want the event triggered immediately after the completion of the dependent events. If **Dependent on Other Events** is off, events will be triggered this many days after the creation of the cut process. Refer to [How and When Events Are Activated](#) for the details.
- If **Dependent on Other Events** is on, define the events that must be completed or cancelled before the event will be triggered.
 - **Sequence** is system-assigned and cannot be specified or changed.
 - **Dependent on Sequence** is the sequence of the dependent event.

Setting Up Collection Class Overdue Rules

Collection class overdue rules contain algorithms that impact accounts associated with a given collection class, division and currency code are managed. Open **Admin > Credit & Collection > Collection Class Overdue Rules > Add** to set up collection class overdue rules.

NOTE:

Recommendation. Before using this transaction, we strongly recommend that you review [Different Overdue Rules For Different Customers](#).

Description of Page

Enter the **Collection Class**, **CIS Division** and **Currency Code** to which the rules apply.

The **Algorithms** grid contains algorithms that control important functions. You must define the following for each algorithm:

- Specify the algorithm's **System Event** (see the following table for a description of all possible events).
- Specify the **Algorithm** to be executed when the System Event executes. Set the **Sequence** to 10 unless you have a **System Event** that has multiple **Algorithms**. In this case, you need to tell the system the **Sequence** in which they should execute.

The following table describes each **System Event**.

System Event	Optional / Required	Description
Bill-Based Payment Arrangement	Optional - only specified if your implementation uses bill-oriented payment arrangements	This algorithm is executed to handle the creation, breaking and canceling of a Bill-Oriented Payment Arrangements .
Overdue Monitor Rule	Required	This algorithm is invoked by the Overdue Monitor to analyze an account's debt. Refer to How Does The Overdue Monitor Work for the details. If you have multiple rules (and therefore multiple algorithms), please take care when assigning the sequence number, as the Overdue Monitor will invoke these rules in sequence order.
Write Off Bill	Option - only specified if your implementation writes-off bills	This algorithm is executed to handle the write-off and write-off reversal of a bill. Refer to Writing Off Bills .

Setting Up Overdue Event Cancellation Reasons

An overdue event cancel reason must be supplied before an overdue event can be canceled. Open **Admin > Credit & Collection > Overdue Event Cancel Reason** to define overdue event cancellation reasons.

Description of Page

Enter an easily recognizable **Overdue Event Cancel Reason** and **Description** for each cancellation reason.

Setting Up Cut Event Cancellation Reasons

A cut event cancel reason must be supplied before a cut event can be canceled. Open **Admin > Credit & Collection > Cut Event Cancel Reason** to define cut event cancellation reasons.

Description of Page

Enter an easily recognizable **Cut Event Cancel Reason** and **Description** for each cancellation reason.

Defining Prepaid Metering Options

The topics in this section describe how to set up the system to enable prepaid metering functionality.

NOTE:

Prepaid metering is optional. The system configuration requirements described in this section are only relevant if your organization offers prepaid metering service.

The Big Picture of Prepaid Metering

Prepaid metering allows customers to pay for energy before it is actually used.

How Does Prepaid Metering Work?

A traditional electronic prepaid metering system typically operates at three levels:

- Meters that are installed at the customer's home. These meters dispense energy up to the amount that the customer prepaid.
- Vending stations located at the utility's offices or designated payment agencies. These stations/agencies sell prepaid credits to customers.
- Master stations that group vending stations together for administration, reporting and control purposes. Master stations communicate information - e.g. customer information, tariff changes, etc - to the vending stations. The vending stations, in turn, report detailed customer sales and other transaction information to the master station.

A prepaid customer goes to a vendor and purchases credits for their meter to dispense energy. The vendor has knowledge of the customer and the rate that the customer is paying. The vendor issues the credits in any of the following forms: a prepaid card, a token (to be inserted into the meter) or a series of numbers (to be keyed into the meter).

Debit Meter vs. Credit Meter

Prepaid meters are commonly referred to as debit meters. Billed meter types are also called credit meters. A meter's state of being 'credit' or 'debit' translates to a specific meter configuration. Having this property set at the meter configuration level enables meters to be switched between 'credit' and 'debit' if needed.

Prepaid credits may be purchased for either new premises or existing premises. In the latter case, the existing premise could initially have a typical 'credit' meter. In this case, fieldwork may be involved in getting the meter switched from 'credit' to 'debit' (prepaid).

Prepaid Metering Transactions Result in Adjustments

There could be numerous types of prepaid transactions. But the most common types are prepaid sales and cancellations.

A sale or cancellation transaction includes a total amount that usually includes tax. In order to post to the general ledger, the prepaid transaction must result in a financial transaction. Moreover, separate GL entries must be created for the breakdown of revenue and tax. In some cases, it may also be necessary to calculate the usage from the revenue amount.

[Calculated Adjustments](#) are used to book revenue from these types of transactions. A base Generate Adjustment algorithm is available to let rate application generate the appropriate GL calculation lines and calculate the corresponding usage, if needed.

Prepaid adjustments do not affect a customer's balance.

Interfacing Prepaid Transactions

An adjustment upload batch process exists for uploading prepaid transactions that result in adjustments. Refer to [Interfacing Adjustments From External Sources](#) for more information.

Prepaid metering options need only be set up if your organization offers prepaid metering service to your customers. Refer to [Defining Prepaid Metering Options](#) for more information.

Prepaid Transactions Can Go Into Suspense

A prepaid transaction goes into suspense if a prepaid SA could not be determined for any of the following reasons:

- The badge number on the transaction is not a valid meter in the system
- The badge number on the transaction is a valid meter in the system, but is:
 - Not linked to a prepaid meter configuration type
 - Not linked to a non-closed, non-canceled prepaid SA

This can be a common occurrence because of the likelihood that transactions get uploaded prior to meter installation/exchange or service agreement information being updated in the system.

When this situation happens, you probably still want to recognize the revenue by posting an adjustment to a suspense SA that you designate. Refer to the base sample Get Prepaid SA Using Badge Number (C1-SABYBADGE) algorithm for an example of how the suspense SA is specified.

A batch process exists for automatically resolving suspense adjustments. Refer to [How Are Suspense Adjustments Resolved](#) for more information.

Setting Up The System To Enable Prepaid Metering

The following sections describe the steps in setting up control information for prepaid metering.

Meter Types

Prepaid meters are set up just like any other meter - i.e. the meter must reference a meter type and the meter's configuration must reference a meter configuration type.

To set up prepaid meter types you must do the following:

- Define the meter configuration types that will be used for recording prepaid usage. Mark each of these configuration types as Prepaid . Define one register with the appropriate UOM (e.g. kWh).
- Define the meter types that will be used for prepaid metering. For each meter type, associate one of the Prepaid meter configuration types that you defined. You can also mark each meter type as Prepaid Capable.

NOTE:

Base logic does not require the meter type to be marked as Prepaid Capable. The Prepaid indicator on the meter configuration type is used to identify prepaid meters.

Characteristic Types

The following characteristic types are needed if you are going to upload prepaid transactions as adjustments and need the system to determine the prepaid SA given a prepaid meter's badge number.

Refer to [Setting Up Characteristic Types](#) for more information.

Prepaid Entity Characteristic Type

Create a characteristic type that identifies whether an SA Type is used for prepaid metering. For example:

- Characteristic Type = `<code>`
- Description = Prepaid Entity
- Char Entities = SA Type
- Subclass = predefined list
- Values = Y, N

Badge Number Characteristic Type

Create a characteristic type for specifying a badge number. For example:

- `<code>`
- Description = Badge Number
- Char Entities = Adjustment, Adjustment Type
- Subclass = Adhoc

Algorithms

The following algorithms need to be set up in order to store prepaid transactions in the system.

Refer to [Setting Up Algorithms](#) for more information.

NOTE:

The following sections describe basic set up needed for uploading 'sale' and 'cancellation' types of prepaid transactions. Your implementation team may have to define additional specific algorithms types for any other prepaid transaction type that you need to upload into or store in the system.

Calculation Rule - Calculation Algorithm

Create an algorithm of type Determine Percent Given Total (C1-PCTGVNTOT) specifying your parameter values for UOM / TOU / SQI.

Create an algorithm of type Back Into Revenue (C1-BACKINREV) specifying your parameter values for UOM / TOU / SQI.

Adjustment Type - Generate Adjustment

Create an algorithm of type Adjustment Generation - Apply Rate (ADJG-RT), specifying your [prepaid rate](#) and parameter values for UOM / TOU / SQI.

Adjustment Type - Determine SA

Create an algorithm of type Get Prepaid SA Using Badge Number (C1-SABYBADGE), specifying your badge number characteristic type, prepaid characteristic type and suspense SA ID (i.e. SA to which the adjustment needs to post when a valid prepaid SA is not found).

Adjustment Type - Resolve Suspense

Create an algorithm of type Cancel Suspense Adjustment (C1-CANSUSADJ) specifying the following:

- [Badge number characteristic type](#)
- [Prepaid entity characteristic type](#)
- [Prepaid adjustment type](#)
- Adjustment cancel reason

If you want this algorithm to create to do entries for adjustments that have been in suspense for too long, specify additional parameter values for number of days and to do type and to do role (optional).

Adjustment Type - Adjustment Information

Specify the SUSPENSE_DESCR parameter on your adjustment information algorithm if you want the information to include an indication of suspense.

Installation - Adjustment Information

Specify the SUSPENSE_DESCR parameter on your adjustment information algorithm if you want the information to include an indication of suspense.

Rate

In order to generate separate calculation lines for the revenue and tax breakdown of the prepaid amount, you need to set up a prepaid rate with components that calculate revenue amount and tax amount given just a total amount.

Create a rate schedule with the following components:

- Tax Calculation Rule
 - Calculation Rule Type = Calculation Algorithm
 - Value Type = Percentage
 - Value Source = Bill Factor
 - Bill Factor = your tax bill factor
 - Calculation Algorithm = the one created for algorithm type C1-PCTGVNTOT. Refer to [Calculation Rule - Calculation Algorithm](#) for information.
 - Distribution Code = *your distribution code for tax liability*

- Revenue Calculation Rule
 - Calculation Rule Type = Calculation Algorithm
 - Derive SQ = checked
 - Value Type = Unit Charge
 - Value Source = Bill Factor
 - Bill Factor = your rate/kWh bill factor
 - UOM/TOD/SQI to use for the resulting calculated usage, for example kWh
 - RC Cross Reference = indicate the sequence for the tax calculation rule (above)
 - Calculation Algorithm = the one created for algorithm type C1-BACKINREV. Refer to [Calculation Rule - Calculation Algorithm](#) for information.
 - Distribution Code = your distribution code for revenue

Adjustment Types

You must define an adjustment type for each type of transaction that you want to store in the system. Refer to [Setting Up Adjustment Types](#) for more information.

For prepaid sales and cancellation transactions, you need to define [calculated adjustment types](#). In addition, plug-in the following algorithms:

- Adjustment FT Creation - GL Only algorithm - so that transaction amounts do not affect the customer's balance. Specify calc lines as the source for adjustment distribution codes.
- [Generate Adjustment](#)
- [Determine SA](#)
- [Resolve Suspense](#), if applicable.
- [Adjustment Information](#), if applicable

Adjustment Type Profiles

Create appropriate [adjustment type profiles](#) for your prepaid service agreements.

Service Agreement Types

You must create a prepaid [SA Type](#) for each unique CIS Division. Each SA Type must be set up as non-billable and requiring a characteristic premise. The SA Types must also indicate that they are used for prepaid by specifying a [prepaid entity characteristic](#) value.

Bill Cycle

Create at least one bill cycle that will be used for prepaid accounts. This bill cycle should not have a schedule defined.

Vendor Information

A vendor could be a vending station, payment agency or master station.

You must create a [person](#) for each of your vendors. Information about the vendor may include names, an address, phone numbers, etc.

Any other miscellaneous information about the vendor can be stored as characteristics on the person.

Hierarchical relationships between vendors can be established through characteristics. For instance, a vending station's person record may contain a foreign key characteristic that points to the master station that the vending station reports to.

Defining Conservation Program Options

Oracle Utilities Customer Care and Billing allows you to define conservation (or energy efficiency) programs and provide rebates to customers.

The Big Picture of Conservation Programs

The purpose of using conservation programs is to provide rebates to customers based on eligibility and verification of newly purchased appliances and hardware that are rated to conserve the demand for energy. To redeem their rebates, customers have to submit a rebate application to the utility with receipts, and the utility has to administer and report on the programs.

Admin and transaction objects are provided in the product to support the definition of conservation programs (admin data) and the subsequent rebate claims (transaction data). Portals and BPA scripts are used to maintain the conservation programs and rebate claims. Adjustments are used to recognize the expense and to process refunds.

The following sections discuss the maintenance objects that support this functionality.

Conservation Program Maintenance Object

A conservation program is an admin maintenance object (MO) used to support the definition of a conservation program. It holds rules that control how the claims for a conservation program are managed. If your organization wishes to use this MO, you can either use the business object (BO) supplied in the base product or configure your own BO.

This MO provides the following functionality:

- A business object option Display Statistics Service Script is provided for business objects of this type. The script plugged into this option retrieves information displayed on the **Conservation Program Statistics Zone**.
- A business object option Display Statistics UI Map is provided for business objects of this type. This is the map used on the **Conservation Program Statistics Zone** to display statistics.
- A separate maintenance object is provided to capture rebate definitions for a conservation program
- Logs are not provided.
- The standard characteristics collection is provided.

FASTPATH:

For more information, about this MO and to review the business objects defined for this MO, navigate to **Admin > Database > Maintenance Object > Search** and view the MO C1-CPROG.

Conservation Program Rebate Definition Maintenance Object

A conservation program has rebate definitions that define the rebate amounts and energy savings for different types of products. The superset of such lines is the "rebate matrix". Each row in the matrix defines the rebate and presumed energy savings for a product purchased by the consumer. If your organization wishes to use this maintenance object (MO), you can either use the business object (BO) supplied in the base product or configure your own BO.

This MO provides the following functionality:

- The Rebate Definition table can be used to capture information for rebate claim lines such as, appliance type, refund amount, energy savings, and applicable manufacturers and models.
- Logs are not provided for the Rebate Definition.
- A characteristics collection is not provided.

FASTPATH:

For more information, about this MO and to review the business objects defined for this MO, navigate to **Admin > Database > Maintenance Object > Search** and view the MO C1-RDEF.

Rebate Claim Maintenance Object

When a customer files a claim for a rebate, a rebate claim will be created. The rebate claim maintenance object (MO) is used to support the definition of a claim. If your organization wishes to use this MO, you can either use the business object (BO) supplied in the base product or configure your own BO.

This MO provides the following functionality:

- Depending on the utility's requirements, you can specify single or multiple items on the Rebate Claim. A separate maintenance object is provided to capture rebate claim lines for a rebate claim.
- The standard characteristics collection is provided.
- A log is provided. This can be used to track approval information for the claim, to capture adjustments created as the claim is processed, etc.

FASTPATH:

For more information, about this MO and to review the business objects defined for this MO, navigate to **Admin > Database > Maintenance Object > Search** and view the MO C1-RCLAIM.

Rebate Claim Line Maintenance Object

A rebate claim has a rebate claim line for each product eligible for a refund. You use the rebate claim line maintenance object (MO) to create a rebate line. If your organization wishes to use this MO, you can either use the business object (BO) supplied in the base product or configure your own BO.

This MO provides the following functionality:

- SA (service): The SA table is the real service SA. There is a separate SA under which the rebate adjustments are stored.

- Logs are not provided for Rebate Claim Line
- The standard characteristics collection is provided.

FASTPATH:

For more information, about this MO and to review the business objects defined for this MO, navigate to **Admin > Database > Maintenance Object > Search** and view the MO C1-REBLN.

GL Accounting Example

The following table shows the financial transactions that are issued when processing energy conservation rebates. This example shows the financial transactions when a customer files a claim for a dishwasher and insulation.

Notice how the expense adjustments are atomized:

- Separate adjustments are created to expense each item individually.
- A single adjustment is created for the A/P check request.

Event	GL Accounting
Rebate adjustment is created - dishwasher	Rebate Expense 35 A/P <35>
Rebate adjustment is created - insulation	Rebate Expense 45.45 A/P <45.45>
A/P check request issued	A/P 80.45 Cash <80.45>

Setting Up Conservation Programs

Conservation Programs allow administrators to create and maintain conservation programs for which customer can submit rebate claims. To set up a conservation program, open **Admin > Customer > Conservation Program > Add**.

FASTPATH:

For additional information on working with rebate claims, see [Rebate Claims](#).

The topics in this section describe the base-package zones that appear on the Conservation Program portal.

Conservation Program List Zone

The Conservation Program [List zone](#) lists every conservation program. The following functions are available:

- Click a [broadcast](#) button to open other zones that contain more information about the adjacent conservation program.
- Click the Add link in the zone's title bar to add a new conservation program.

This zone displays the following for each conservation program defined in the system:

- Conservation Program Information (Description, Status, Start Date, End Date)

- The number of Complete Claims
- The total Complete Claims Amount
- The number of Incomplete Claims
- The Statistics Date/Time is the date that the statistics were last calculated

Use the following procedure to create a new conservation program:

- Select **Admin > Customer > Conservation Program > Add** or click **Add** on the title bar of the Conservation Program [List zone](#).
- Enter basic information about the conservation program in the **Main** section, including:
 - Conservation Program code
 - Description
 - Start Date/End Date
 - Statistic Update Frequency (in hours)
- Enter **Financial Information** about the conservation program, including:
 - CIS Division
 - SA Type
 - A/P Adjustment Type
 - A/P Taxable Adjustment Type
- Enter **Approval Information** about the conservation program, including:
 - Approval To Do Type
 - Duplicate Claim To Do Role
 - Approval Levels and Threshold Amounts
- Click **Save**. To return to the Conservation Program portal without saving the new program, click **Cancel**.

To view a specific conservation program, click the broadcast icon for the conservation program you wish to view. The remaining zones in the Conservation Program portal open displaying details about the selected conservation program.

Conservation Program Zone

You use the Conservation Program zone to view and maintain individual conservation program. The Conservation Program zone displays the following information about the selected conservation program:

- Basic information about the conservation program, including
 - Conservation Program
 - Description
 - Start Date/End Date
 - Statistic Update Frequency (in hours)
 - Status
- Financial Information about the conservation program, including
 - CIS Division
 - SA Type
 - A/P Adjustment Type

- A/P Taxable Adjustment Type
- Approval Information about the conservation program, including
 - Approval To Do Type
 - Duplicate Claim To Do Role
 - Approval Levels and Threshold Amounts

Please see the zone's help text for information about this zone's fields.

Conservation Program Status

The Status of a conservation program indicates the current state of the program within the system. Valid statuses include:

- **Pending** indicates the program is pending. This is the initial state of a conservation program when first created.
- **Active** indicates the conservation program is currently active.
- **Inactive** indicates the conservation program is currently inactive.

Conservation Program Actions

You can perform a number of actions on a conservation program, including:

- **Edit:** Used to edit a conservation program
- **Delete:** Used to delete a conservation program
- **Activate:** Used to activate a pending or inactive conservation program
- **Refresh Statistics:** Used to refresh the statistics of an active conservation program
- **Deactivate:** Used to deactivate a pending or active conservation program
- **Pend:** Used to change the status of an active or inactive conservation program to Pending

The actions available are based on the current status of the conservation program. The table below summarizes the actions available at each status.

Status	Valid Action
Pending	Edit, Delete, Activate, Deactivate
Active	Edit, Refresh Statistics, Deactivate, Pend
Inactive	Activate, Pend

Editing Conservation Programs

Use the following procedure to edit an active or pending conservation program:

- Click **Edit**.
- Edit the details of the conservation program as needed.
- Click **Save**.

Deleting Conservation Programs

Use the following procedure to delete a conservation program:

- Click **Pend** to change the status of the conservation program to Pending (if needed).
- Click **Delete**.
- Click **OK** on the Confirm Delete dialog. To close the dialog without deleting the conservation program, click **Cancel**.

Activating Conservation Programs

To activate an inactive or pending conservation program, click **Activate**.

Deactivating Conservation Programs

To deactivate an active or pending conservation program, click **Deactivate**.

Setting the Status of Conservation Programs to Pending

To set the status of an active or inactive conservation program to Pending, click **Pend**.

Rebate Definition Zone

You use the Rebate Definition zone to add, view, and edit rebate definitions associated with a conservation program. A rebate definition defines the types of rebates allowed for a specific conservation program. The Rebate Definition zone displays the following details for each claim line:

- Rebate Definition
- Status (Active or Inactive)
- Rebate Amount per Unit
- Icons to Edit, Delete, and Activate/Deactivate rebate definitions

Adding Rebate Definitions

Use the following procedure to add a rebate definition:

- Click **Add** in the title bar of the Rebate Definition zone.
- Enter a Description of the rebate definition.
- Select the **Product** for the rebate definition from the dropdown list.
- Select the **Service Type** for the rebate definition from the dropdown list.
- Enter the **Rebate Per Unit Amount** for the rebate definition.
- Enter the **Rebate Unit of Measure** for the rebate definition.

- Select the **Expense Adjustment Type** for the rebate definition from the dropdown list.
- Enter the **Presumed Energy Savings** for the rebate definition.
- Select the **Presumed Energy Savings** Unit of Measure for the rebate definition from the dropdown list.
- Enter the **Manufacturer** and **Model** for each item eligible to be submitted as a rebate claim line.
- To upload manufacturer/model information from a comma-separated-values file, click **CSV File to Upload**.
 - Click **Browse** on the File Upload dialog, and browse to the file to be uploaded.
 - Click **Upload**.
- Click **Save**. To return to the Rebate Definition zone without adding the rebate definition, click **Cancel**.

Editing Rebate Definitions

Use the following procedure to edit a rebate definition:

- Click the edit icon for the rebate definition you wish to delete.
- Edit the details of the claim line as appropriate.
- Click **Save**. To return to the Rebate Definition zone without changing the rebate definition, click **Cancel**.

NOTE:

You can edit a rebate definition only when it is Active.

Deleting Rebate Definitions

Use the following procedure to delete a rebate definition:

- Click the delete icon for the rebate definition you wish to delete.
- Click **OK** on the Confirm Delete dialog. To close the dialog without deleting the rebate definition, click **Cancel**.

Activating Rebate Definitions

To activate an inactive rebate definition, click the **Activate** button for the rebate definition you wish to activate.

NOTE:

You can only activate rebate definition that is currently Inactive.

Deactivating Rebate Definitions

To deactivate an active rebate definition, click the **Deactivate** button for the rebate definition you wish to deactivate.

NOTE:

You can only deactivate rebate definition that is currently Active.

Rebate Claim Statistics Zone

You use the Rebate Claim Statistic zone to view statistics for submitted rebate claims based on the current conservation program. This zone displays the following:

- Conservation Program
- Statistics Date/Time
- Statistics Charts

Statistics Graphs

This zone displays statistics for submitted rebate claims using the following charts:

- **Statistics by Status:** A pie chart that displays the number and percentage of claims for each status.
- **Statistics by Month:** A line chart that displays the number of claims completed each month.
- **Statistics by Product:** A pie chart that displays the total value, percentage, and number of claim lines completed for each product.
- **Statistics by Claim Age:** A line and bar chart that displays the number of new claims per month (line graph) and the number of claims per age grouping (bar graph).

To refresh statistics, click **Refresh Statistics** on the title bar of the Rebate Claim Statistics zone.

Defining Open Market Options

Markets

Understanding Market

The Market object is used to define a deregulated market which is a geographical area operating with a set of rules to manage premises and/or customers for a service type. Separate market instances are created for each geographic area and service type, e.g. Gas New York (GNY), Electric New York (ENY), Electric United Kingdom (EUK).

Each deregulated market has participants (Service Providers) operating within that market. Different types of Service Providers are grouped into Market Relationship Types. There are Service Providers that manage the customer at a premise - e.g. Local Distribution Company, Energy Service Provider (Retailer, Supplier) and some that manage the meter at a premise (Meter Operator, Data Aggregator). Service Providers can operate across several deregulated markets (e.g. Retailers) and they can enter and exit markets independently. Start and End dates are provided to manage Service Providers entering and exiting markets.

Service Provider types can be managed by the market object and others can be managed by Market Provider Configuration. Recommended Market Relationship types managed by the Market object are Meter Owners, Meter Aggregators. There may be markets where no Service Providers are managed by the Market object, even where Meter Owners are present. For example when Meter Owners don't change.

Service Provider types managed by the Market Provider Configuration are recommended for Retailer and Distributor Market Relationship Types. This option provides greater flexibility for market transactions to be sent to service providers based on the market and billing options.

NOTE: Refer to Market Provider Configuration for Service Providers that are managed for each Market Billing Option.

Markets that manage a provider of last resort or fall back service provider will configure the market Fall Back Service Provider, the start and end dates allow a solution to determine who the current Fall Back Service Provider is. Not all markets have a Fall Back Service Provider.

Configuring Market

This portal is used to display and maintain a Market.

Refer to [Understanding Market](#) for more information.

To maintain markets, open **Admin > Open Market > Market**.

This is a standard [All-In-One Portal](#).

Refer to the embedded help text for more information.

Market Participants

Understanding Market Participants

Market Participants are participants in a deregulated environment. Relationships between market participants are defined in a particular market record. Refer to [Understanding Markets](#) for more information.

Each market participant can be associated to an [external system](#) which is used to define the messages that can be sent to that market participant and how each message is sent.

Configuring Market Participants

This portal is used to display and maintain market participants.

Refer to [Understanding Market Participants](#) for more information.

You can access the portal by selecting **Admin**, then **Open Market**, then **Market Participant**.

The following zones may appear as part of the portal's **Main** tab page:

- **Market Participants List:** This zone lists all market participant records. Broadcast a record to display the details of the selected record.
- **Market Participant:** This zone provides information about the selected market participant.
- **Market Participant Characteristics:** This zone lists characteristics defined for the market participant.
- **Market Contracts:** This zone lists market contracts where the market participant is either the Buyer or Seller.
- **Processing Method List:** This zone provides the list of processing methods defined for the market participant.
- **Translation Method List:** This zone provides the list of translation methods defined for the market participant.
- **Inbound BOs Send By Service Provider:** This zone lists inbound business objects that are sent by this market participant. The identification is driven by the business object having a Business Object Option of type "Sent By Service Provider" that references the current market participant.

Defining Consumer Contract Options

The topics in this section describe how to set up the system to enable consumer contract functionality.

Understanding Consumer Contracts

Consumer contracts record customer relationships. These relationships can encompass multiple services, multiple sites and multiple accounts. For example a consumer contract can be for a customer's gas and electricity supply at a single site or for a customer's water supply at multiple sites.

A consumer contract can relate to one or more consumer product versions. A consumer product version records values that are common to all consumer contracts related to that consumer product version. A consumer product version also records rules that are applied by customer service requests to set up a new consumer contract or change an existing consumer contract. These rules can for example create service agreements or stop service agreements. Refer to [Understanding Consumer Products](#) for more details. A consumer contract's consumer contract products record the links between the consumer contract and consumer product versions.

Note a consumer contract relates to consumer product versions not to consumer products. The consumer product version linked to a consumer contract is the version of the required consumer product that is applicable for that consumer contract. This could for example be the consumer product version that is effective for the date the consumer contract was agreed.

Consumer contracts group together service agreements. The relationship between a consumer contract and a service agreement is recorded in the service agreement by linking the service agreement to one of the contract's consumer contract products. A consumer contract can record details that are common for all of the related service agreements.

All consumer contracts have a consumer contract type. A consumer contract type limits which consumer products are valid for a consumer contract of that type. Note the consumer products that are eligible are further limited by the consumer product's eligibility criteria. Refer to [Understanding Consumer Products](#) for more details.

A consumer contract can have milestones where a milestone is a date that is significant to the contract. Milestones can optional trigger an action. Refer to [Understanding Consumer Contract Milestones](#) for more details.

Understanding Consumer Contract Milestones

Dates that are significant to a consumer contract can be recorded as consumer contract milestones. A consumer contract milestone can optionally trigger an action. For example, a consumer contract milestone could record the date when a fixed-priced period ends and trigger a change to the consumer contract when this date is reached. Another example is a consumer contract milestone that sends a notification to the customer one month prior to the end of the fixed-priced period.

A consumer contract milestone can relate to one or more of the contract's consumer contract products. A contract's consumer contract products record the links between the consumer contract and consumer product versions. In the example above of a consumer contract milestone recording the date when a fixed price period ends, the consumer contract milestone would be related to the consumer contract period whose consumer product version has the fixed priced period.

Each milestone has a consumer contract milestone type. The consumer contract milestone type indicates whether or not a milestone is executable, that is whether or not it triggers an action. For executable milestones, the action to be performed is derived from the consumer contract milestone type.

A consumer contract milestone's executable status can be: Pending, Processed, Not Executable or Canceled. Not Executable indicates that the milestone does not have a related action and Canceled indicates that the milestone is no longer applicable.

The Perform Consumer Contract Milestone Actions (C1-CCMP) batch process executes a consumer contract milestone's actions. This batch process selects the consumer contract milestones whose milestone date is today or in the past and whose executable status is Pending. The batch process performs the **Perform Action** algorithms defined on the milestone's Consumer Contract Milestone Type business object. Once a consumer contract milestone's actions have been performed, the batch process changes its executable status to Processed.

NOTE:

This batch process is built using the [Plug-in Driven Background Processes](#) framework. Your implementation can introduce alternate logic, by duplicating this batch control and replacing the select and/or process records algorithms. Adjust the batch parameters according to your custom logic, if needed.

The base product provides a **Contract Milestone Type (BO) – Perform Action** algorithm that sends customer notification. Additional algorithms may exist for your implementation. To see the available algorithm(s), search for algorithm types of the **Contract Milestone Type (BO) – Perform Action** algorithm entity in the application.

Understanding Consumer Products

Consumer products record attributes and rules that are used for consumer contracts. A consumer product can for example record attributes for:

- The duration of a fixed-priced period
- The amount of a contractual change, such as an exit fee
- Prices

These attributes can be used when setting up a new consumer contract or changing an existing contract. They could also be used to display details when a product is being selected or to include details in correspondence with customers.

A consumer product's rules are used to set up new consumer contracts and to change existing consumer contracts.

A consumer product's attributes and rules are recorded in the consumer product's version. Refer to [Understanding Consumer Product Versions](#) for more details.

Consumer product eligibility criteria can be used to determine which consumer products that are eligible in particular circumstances. For example a consumer product could be eligible only when autopay is being used. Consumer product eligibility criteria are optional. If a consumer product has eligibility criteria then the consumer product is eligible or not depending on the criteria. If however a consumer product does not have eligibility criteria then the consumer product is always eligible. The next sections provide more information on this functionality.

Understanding Consumer Product Eligibility Criteria

A consumer product eligibility criteria rule requires the following components:

- Operand to be compared
- Comparison operator
- Comparison value
- Comparison results

The operands to be compared by consumer product eligibility criteria rules are identified using characteristic types. The characteristic types must have a characteristic entity of **Consumer Product Eligibility Operand**. The value of these characteristics are populated by the Operands algorithms that are defined on the related Consumer Contract Type's business object. The base product provides **Consumer Contract Type (BO) – Operands** algorithm that sets a characteristic value to indicate if the customer is or will be on autopay. Additional algorithms may exist for your implementation. To see the available algorithm(s), search for algorithm types of the **Consumer Contract Type (BO) – Operands** algorithm entity in the application.

The comparison operator can be one of the following: <, <=, <>, =, >, >=, Between, In or Is Blank.

The comparison value is recorded in the consumer product eligibility criteria rule.

The comparison results define what action should be taken when the criteria rule is applied. If the comparison is true or false, the result can be that the consumer product is eligible, the consumer product is not eligible or the next eligibility rule

should be checked. If there is insufficient data, that is the operand to be compared was not found, the result can be that the consumer product is eligible, the consumer product is not eligible, the next eligibility rule should be checked or an error should be generated.

Understanding Consumer Product Versions

A consumer product version records the product attributes and rules that are applicable for consumer contracts related to the consumer product version.

NOTE: Consumer contracts relate to consumer product versions not to consumer products. The addition of a new consumer product version will not affect existing consumer contracts.

For a consumer contract that is created or changed using a customer service request, the consumer product version is determined using the Determine Version algorithm defined on the Consumer Product business object. The base package provides an algorithm type that determines the effective consumer product version by comparing the version's offer effective date and the date the new contract or contract change was agreed. Alternative custom algorithms could use one or more of the consumer product version's offer effective date, service effective date, offer end date, service end date and consumer product version selection. To see the list of available algorithm(s), search for algorithm types of the **Consumer Product (BO) – Determine Version** algorithm

Consumer products have two kinds of rules: consumer product rules and consumer contract rules. Consumer product rules are used to perform configurable services for a consumer product version. For example, a consumer product rule can determine the fallback product to use when a contract's product is no longer eligible. Consumer contract rules are used to set up new consumer contracts and make changes to existing consumer contracts. For example, a consumer contract rule can be used to create or stop a service agreement.

Consumer product rules relate directly to a consumer product version. Consumer contract rules are organized into groups using consumer product components. The consumer product components can be linked together into a hierarchy. The consumer product version records the consumer product component at the top of the hierarchy.

A consumer product version's attributes are recorded either as consumer product version characteristics or as consumer product component characteristics. Examples of attributes are: the duration of a fixed-price period and the amount of an exit fee.

Consumer product component eligibility criteria determine whether a consumer product component is applicable. The product attributes retrieved or consumer contract rules applied for a consumer product version will vary depending on the consumer product component eligibility criteria rules.

Understanding Consumer Product Rules

Consumer product rules are standard and custom rules that perform actions for a consumer product version. A consumer product rule class defines the type of action that is performed. A consumer product rule class is recorded in the consumer product version for each related consumer product rule. The base product provides the following consumer product rule classes:

- Determine Fallback Product
- Determine If Reapplication Required

A consumer product rule typically includes the following details:

- Basic information about the consumer product rule, including its name, description and detailed description. This is standard information for most consumer product rules.
- Specific parameters used by the consumer product rule.

The base product provides the following consumer product rules:

- **Determine Fallback Product:** A rule that determines the fallback product using a consumer product class recorded in the rule.
- **Determine if Product should be Reapplied:** A rule that determines if reapplication is necessary by deriving the current consumer product component eligibility criteria operands for the consumer product and comparing these with the previous operand values.

Additional algorithms may exist for your implementation. To see the available algorithm(s), search for algorithm types of the **Consumer Product Rule (BO) – Apply Rule** algorithm entity in the application.

Understanding Consumer Product Components

Consumer product components group together product attributes and consumer contract rules.

Consumer product component eligibility criteria rules can be created for a consumer product component. These eligibility rules will determine if a consumer product component's product attributes are applicable and if a consumer product component's consumer contract rules are applied. A consumer product version could, for example, have one consumer product component that is eligible when a customer is on autopay and another consumer product component that is eligible when a customer is not on autopay.

A consumer product component can, optionally, have one or more child consumer product components. This allows consumer product components to be organized into a hierarchy. If a consumer product component is not eligible, any child consumer product components will also not be eligible.

Understanding Consumer Product Component Eligibility Criteria

A consumer product component eligibility criteria rule requires the following components:

- Operand to be compared
- Comparison operator
- Comparison value
- Comparison results

The operands to be compared by consumer product component eligibility criteria rules are identified using characteristic types. The characteristic types must have a characteristic entity of **Consumer Product Comp Eligibility Operand**. The value of these characteristics are populated by the **Contract Operands** and **Location Operands** algorithms defined on the Consumer Product business object. The base product provides a **Consumer Product (BO) – Contract Operands** algorithm type that sets a characteristic value to indicate if the customer is or will be on autopay. Additional algorithms may exist for your implementation. To see the available algorithm(s), search for algorithm types of the **Consumer Product (BO) – Contract Operands** algorithm entity in the application.

The comparison operator can be one of the following: <, <=, <>, =, >, >=, Between, In or Is Blank.

The comparison value is recorded in the consumer product component eligibility criteria rule.

The comparison results define what action should be taken when the criteria rules is applied. If the comparison is true or false, the result can be that the consumer product component should be applied, the consumer product component should not be applied or the next eligibility rule should be checked. If there is insufficient data, that is the operand to be compared was not found, the result can be that the consumer product component should be applied, the consumer product component should not be applied, the next eligibility rule should be checked or an error should be generated.

Understanding Consumer Contract Rules

Consumer contract rules are standard and custom rules that perform actions to set up a new consumer contract or change an existing consumer contract which is related to the consumer product version. A consumer contract rule could for example create a new service agreement.

Consumer contract rules are grouped together by consumer product components. Consumer product components determine if and when a consumer contract rule will be applied. Refer to [Understanding Consumer Product Components](#) for more details.

Consumer contract rules are applied by a customer service request when a consumer contract is being created or changed. Different consumer product rules can be applied at different stages of the customer service request and for different changes. The consumer product component defines a consumer contract rule usage that determines when a consumer contract rule is applied.

The base product provides the following consumer contract rule usages:

- On Activation – Add: The consumer contract rules are applied during activation set up for the consumer product versions of consumer contract products that have been added.
- On Activation - Remove: The consumer contract rules are applied during activation set up for the consumer product versions of consumer contract products whose end date time has been set.
- On Completion – Add: The consumer contract rules are applied at completion for the consumer product versions of consumer contract products that have been added.
- On Completion – Remove: The consumer contract rules are applied at completion for the consumer product versions of consumer contract products whose end date time has been set.
- Service Location - Add: The consumer contract rules are performed when any action required to add a service point or registration point to a contract, such as field work or a market process, has been performed.
- Service Location – Remove: The consumer contract rules are performed when any action required to remove a service point or registration point from a contract, such as field work or a market process, has been performed.

The base product provides **Consumer Contract Rule (BO) – Apply Rule** algorithms that add a service agreement and that add a consumer contract milestone. Additional algorithms may exist for your implementation. To see the available algorithm(s), search for algorithm types of the **Consumer Contract Rule (BO) – Apply Rule** algorithm entity in the application.

Configuring Consumer Contract Type

This portal is used to display and maintain a Consumer Contract Type.

A Consumer Contract Type defines the Consumer Products that are valid for the type of contract. It also defines the information that is used in determining product eligibility.

Refer to [Understanding Consumer Contracts](#) for more information.

To maintain consumer contract types, open **Admin > Consumer Contract > Consumer Contract Type**.

This is a standard [All-In-One Portal](#).

Refer to the embedded help text for more information.

Configuring Consumer Contract Milestone Type

This portal is used to display and maintain a Consumer Contract Milestone Type.

A Consumer Contract Milestone Type defines milestone dates that can be recorded and whether an action should be performed for the type of milestone.

Refer to [Understanding Consumer Contract Milestones](#) for more information.

To maintain consumer contract milestone types, open **Admin > Consumer Contract > Consumer Contract Milestone Type**.

This is a standard [All-In-One Portal](#).

Refer to the embedded help text for more information.

Configuring Consumer Product

This portal is used to display and maintain a Consumer Product, including the consumer product's versions and eligibility rules.

Refer to [Understanding Consumer Products](#) for more information.

To maintain consumer products, open **Admin > Consumer Contract > Consumer Product**.

This is a standard [All-In-One Portal](#).

Refer to the Consumer Product zone's embedded help text for more information.

This portal also shows zones for Consumer Product Versions and Consumer Product Eligibility.

Configuring Consumer Product Version

This portal is used to display and maintain a Consumer Product Version.

Refer to [Understanding Consumer Product Versions](#) for more information.

To maintain consumer product versions, open **Admin > Consumer Contract > Consumer Product Version**.

This is a standard [All-In-One Portal](#).

Refer to the embedded help text for more information.

Configuring Consumer Product Rule

This portal is used to display and maintain a Consumer Product Rule.

Refer to [Understanding Consumer Product Rules](#) for more information.

To maintain consumer product rules, open **Admin > Consumer Contract > Consumer Product Rule**.

This is a standard [All-In-One Portal](#).

Refer to the embedded help text for more information.

Configuring Consumer Product Component

This portal is used to display and maintain a Consumer Product Component, including child consumer product components, eligibility rules and related consumer product versions.

Refer to [Understanding Consumer Product Components](#) for more information.

To maintain consumer product components, open **Admin > Consumer Contract > Consumer Product Component**.

This is a standard [All-In-One Portal](#).

Refer to the Consumer Product Component zone's embedded help text for more information.

This portal also shows zones for Consumer Product Component Eligibility and Related Consumer Product Versions.

Configuring Consumer Contract Rule

This portal is used to display and maintain a Consumer Contract Rule.

Refer to [Understanding Consumer Contract Rules](#) for more information.

To maintain consumer contract rules, open **Admin > Consumer Contract > Consumer Contract Rule**.

This is a standard [All-In-One Portal](#).

Refer to the embedded help text for more information.

Configuration

This section contains additional configuration topics for Oracle Utilities Customer to Meter and Oracle Utilities Customer Care and Billing.

Configuring Zones

Many zones in Oracle Utilities Customer Care and Billing do not require configuration by your implementation team. For example, the base package is shipped with the Account Financial History zone that appears on the Control Central - Account Information portal. This zone does not require configuration because its zone type has no configurable options (i.e., its behavior is static).

Other zones require configuration before they can be used because their behavior is dynamic. The topics in this section provide tips and techniques on how to configure zones in Oracle Utilities Customer Care and Billing.

FASTPATH:

Refer to [The Big Picture of Portals and Zones](#) in the *Oracle Utilities Application Framework Administration Guide* for a description of portal and zone functionality.

Configuring Timeline Zones

A timeline zone is a zone that may be configured on the account or customer information tabs of Control Central. This type of zone contains one or more "lines" where each line shows when significant events have occurred. For example, you can set up a timeline zone that has two lines: one that shows when payments have been received from a customer, and another that shows when bills have been sent to the customer.

FASTPATH: For a complete description of the numerous features available on a timeline zone, refer to [Timeline Zone](#).

Configuration is required to enable a timeline zone. A timeline zone is made up of one or more algorithms where each algorithm returns "events" for a certain type of record (payment or bill for example). The product delivers several algorithm types for the timeline zone to include "events" for many different transactions in the product. Each algorithm type uses the Account or Person in context to retrieve the related information.

- Refer to [Configuring Timeline Zones](#) in the framework portion of the administration guide for information about the type of detail each event may return. The base provided algorithm types include many parameters to allow the implementation to configure much of this information as desired.

Many of the algorithms support supplying a [BPA script](#) to launch when a user clicks on an event on a timeline. Be sure to review each algorithm type to see what types of events support a BPA script. For each event, determine if your business practice warrants the development of a BPA script.

After configuring the algorithms per your business needs, the following additional steps are needed:

- Set up a [zone](#) that references these algorithms. The zone will reference the **F1-TIMELINE** zone type.
- Link the zone to the appropriate portal(s) (e.g., [Control Central - Account Information](#) or [Control Central - Customer Information](#)).
- Update your users' [portal preferences](#) and [security rights](#) so they can see the zone in the desired location on the portal(s).

You can set up many timeline zones. For example,

- You might want different zones to appear on a portal depending on the type of user. For example, you might want one timeline for billing clerks, and a different one for customer service representatives.
- For aesthetic reasons, you might want multiple simple timeline zones to appear on a given portal rather than one complex timeline zone.
- You might want to set up context specific timeline zones. For example, you might want to have one timeline zone that is premise-oriented and another that is person-oriented.

Content Migration Assistant (CMA) Addendum

This section is an addendum to the general [Content Migration Assistant](#) section in the *Oracle Utilities Application Framework Administration Guide*. This section assumes that you are familiar with the concepts of Content Migration Assistant (CMA).

NOTE: CMA is designed to migrate configuration data only. Since base product data should be updated only through product patching mechanisms, CMA cannot currently be used to migrate master/transactional data that contains system-generated primary keys, such as customer account or billing information.

This addendum describes Content Migration Assistant (CMA) functionality that is specific to Oracle Utilities Customer Care and Billing.

The following sections provide information about what is provided in the C1-owned base package:

Base Package Migration Plans

The C1-owned base package provides a large number of migration plans to support migrating configuration and/or administration data from one environment to another.

Use the following procedure to access the base package migration plans:

1. Navigate to **Admin > Implementation Tools > Migration Plan > Search**.
2. Enter “C1” in the **Migration Plan** field.
3. **Click Refresh**.
4. Select a migration plan in the search results list. The details of the selected migration plan are displayed in the Migration Plan portal.

NOTE: The C1-owned base package plans can also be used as a basis for custom migration plans. To create a custom migration plan, select a plan to base the custom migration plan on, click the Duplicate button, and define the custom plan to meet the implementation’s requirements as described in [Defining a Migration Plan](#) in the *Oracle Utilities Application Framework Administration Guide*.

Base Package Migration Request

The C1-owned base package provides two migration request to support migrating configuration and/or administration data from one environment to another.

Use the following procedure to access the base package migration requests:

1. Navigate to **Admin > Implementation Tools > Migration Request > Search**
2. Enter "C1" in the **Migration Request** field.
3. Click **Refresh**.
4. Click the **Copy and Sync Control Data** link in the search results list.

The details of the migration requests are outlined below. Please use the Migration Request portal to view additional details about this migration request.

Base Admin Data Migration Request

- **Migration Request:** C1-AdminBasic
- **Description:** Base Admin Data
- **Detailed Description:** Base Admin Data.
- **Migration Plans:** This migration request includes base package migration plans used by Oracle Utilities Customer Care and Billing.

Copy and Sync Control Data Migration Request

- **Migration Request:** C1-CopyControlTables
- **Description:** Copy and Sync Control Data
- **Detailed Description:** Copy and Sync Control Data.
- **Migration Plans:** This migration request includes base package migration plans used by Oracle Utilities Customer Care and Billing.

For additional information about these migration plans, see [Base Package Migration Plans](#).

NOTE: The C1-owned base package request can also be used as a basis for custom migration requests. To create a custom migration request, select the base package request, click the Duplicate button, and define the request as to meet the implementation's requirements as described in [Defining a Migration Request](#) in the *Oracle Utilities Application Framework Administration Guide*.

Wholesale and Piecemeal Migrations

There are two general types of migrations used with the Content Migration Assistant: wholesale migrations and piecemeal migrations.

Wholesale Migrations

Wholesale migrations are used when migrating all the configuration and/or administration data from one environment to another. For example, a wholesale migration might be used when migrating admin data from a development or test environment to a production environment. For more on this type of migration, see [Types of Migrations](#) in the *Oracle Utilities Application Framework Administration Guide*.

The following is a high-level overview of the steps involved when executing a wholesale migration.

1. Process the “F1-SchemaAdmin” (FW Foundation) migration request (This request contains migration plans for Field, Lookup, Char Type, Currency Code and FK Ref).
2. Process the “C1-AdminBasic” migration request. This includes copies of framework migration plans (including plans for Business Objects, Algorithms, and Feature Configurations) from the “F1-FrameworkAdmin” migration request, as well as independent base package C1-owned wholesale migration plans which can be run first.
3. Process any of the other delivered framework-based (F1-owned) migration requests as needed (except for the “F1-FrameworkAdmin” migration request which is already incorporated in #2)
4. Process the “C1-CopyControlTables” migration request. This includes base package C1-owned wholesale migration plans with dependency on “C1-AdminBasic” migration request.

Piecemeal Migrations

Piecemeal (or "non-wholesale" or “targeted”) migrations are used when migrating a small portion (or piece) of configuration and/or administration data from one environment to another. For example, a piecemeal migration might be used when migrating groups and rules from a development or test environment to a production environment. For more on this type of migration, see [Types of Migrations](#) in the *Oracle Utilities Application Framework Administration Guide*.

The C1-owned base package does not contain piecemeal migration plans for Oracle Utilities Customer Care and Billing.

Processing Notes for Specific Objects

The following limitations apply to certain Oracle Utilities Customer Care and Billing objects when using Content Migration Assistant:

- An Issuing Center object references a User. If this user does not exist in the target system, Content Migration Assistant cannot apply the requested changes.
- A Case Type object references an Application Service. If this service does not exist in the target system, Content Migration Assistant cannot apply the requested changes.
- Collection Agency and Service Provider objects reference a Person. If this person does not exist in the target system, Content Migration Assistant cannot apply the requested changes.
- Service Provider and Tender Source objects reference a Service Agreement. If this service agreement does not exist in the target system, Content Migration Assistant cannot apply the requested changes.
- If your migrateable object includes log tables, you may add your log entity to the characteristic type F1-MGO. You should also mark the log table as a “Non-Migrateable Table” in the Maintenance Object options.
- Transactions are applied in an unspecified order (and probably in order numerically by a randomly generated ID value). CMA only looks at "hard" constraints when determining what to put into the same transaction. Any "soft" constraints such as characteristics and algorithm parameters that might have FK references to other objects are not processed by CMA. Unless the migration plan ensures that related items go into the same transaction, they will end up in different ones, and must need to apply again and again until eventually all gets applied.

To Do Lists Addendum

This section is an addendum to the general [To Do Lists](#) chapter. This addendum describes the To Do functionality that is specific to Oracle Utilities Customer Care and Billing.

Assigning A To Do Role

As described in [To Do Entries Reference A Role](#), each To Do entry requires a role. To Do entries created in Oracle Utilities Customer Care and Billing may attempt to assign a role based on an account management group or division if it is applicable to the type of data related to the To Do entry.

As described in [The Big Picture of To Do Lists](#), users are informed that something requires their attention by entries that appear in a To Do List. For example, consider what happens when billing can't find a reading (and it's not allowed to estimate):

- The billing process creates a bill segment that is in error (meter read cannot be found).
- This bill segment that's in error, in turn, triggers the creation of a To Do entry.
- The To Do entry is assigned a role. A role is one or more users who can look at / work on the entry.
- When users view a To Do List, they only see entries addressed to roles to which they belong.

You can optionally use account management groups (AMG) to define the respective role to be assigned to To Do entries that are associated with an account and To Do type. For example, you can create an AMG called Credit Risks and assign this to accounts with suspect credit. Then, whenever an account-oriented To Do entry is created for such an account, it will be assigned a role based on the Credit Risks AMG. Refer to [Setting Up Account Management Groups](#) for more information.

By assigning an AMG to an account, you are telling the system to address this account's To Do list entries to the roles defined on the AMG (note, each To Do type can have a different role defined for it on an AMG).

You can optionally use division to define the respective role to be assigned to To Do entries that are associated with an account and To Do type. For example, you may have a division called California Operations and assign this to accounts located in California. Then, whenever an account-oriented To Do entry is created for such an account, it will be assigned a role based on the California Operations division. Refer to [Setting Up CIS Divisions](#) for more information.

A To Do Pre-Creation installation options plug-in is provided to determine the appropriate To Do Role for an account based on AMG and division setup. If plugged in, the logic to determine To Do role for an account is performed whenever a To Do entry is created. Refer to C1-TDCR-DFRL for further details on how this plug-in works.

FASTPATH:

Refer to [To Do Entries Reference A Role](#) for the details of how an initial role is assigned to To Do entries.

Background Processes Addendum

This chapter is an addendum to the general [Defining Background Processes](#) chapter. This addendum describes the background processes that are provided with Oracle Utilities Customer to Meter.

How To Set Up A New Extract Processes

Several background processes delivered with the system are used to interface information out of the system. The topics in this section describe when and how to introduce an additional extract process.

Setting Up Meter Read Extracts

You will need a meter read extract for every mechanism your company uses to route meter read requests to the software that handles your meter reading requests. For example:

- You will need a meter read extract to interface records to your handheld device software. The MDL process delivered with the system is intended to be used to handle this function. This process will have to be populated to format the output records in keeping with the needs of your meter reading software.

- If you interface some meter read requests to automatic meter reading software, you will need a new meter read extract process.

If you need additional meter read extract processes, set up the following information:

- Add a new [batch control](#) record. Populate the fields as follows:
- **ID.** Assign an easily recognizable unique ID for the meter read extract process.
- **Description.** Enter a description of the meter read extract process.
- **Accumulate All Instances.** Turn this switch on.
- Use [Route Type](#) to define the meter read extract process to be used for each route type.
- It may be necessary to register the process with your scheduler software.

Setting Up Automatic Payment Extracts

You will need an automatic payment extract for every mechanism your company uses to route automatic payment requests to a financial institution / clearing house. For example:

- You will need an automatic payment extract to interface records to the Automated Clearing House (ACH) if you allow customer to pay via credit card or direct debit from a checking account. The **APAYACH** and **C1-APACH** processes delivered with the system are intended to be used to handle this function.

If you need additional automatic payment extract processes, set up the following information:

- Add a new [batch control](#) record. Populate the fields as follows:
- **Batch Process.** Assign an easily recognizable unique ID for the automatic payment extract process.
- **Description.** Enter a description of the automatic payment extract process.
- **Accumulate All Instances.** Turn this switch on.
- Use [Auto Pay Route Type](#) to define the auto pay extract process to be used for each route type.

Choosing Which Records Are Selected

The system is delivered with some background processes that utilize the **Select Records** plug-in spot to select the records to be processed. It is important to note that these background processes do not utilize the **Process Records** plug-in spot. This logic is hardcoded as these background processes are some of the core system functions such as billing and collections. This functionality provides flexibility in choosing which records are processed, but not how they are processed.

The background processes delivered with the system optionally selects records based on CIS Division. One example is the batch control (**BILLING**) and algorithm (**C1-BILL-SR**). The background process and select records algorithm work as a pair. The batch control defines the parameter to be used by the select records algorithm. The algorithm defines the thread strategy, key fields, and makes the batch control parameter available to be used in the SQL algorithm parameter.

Customizing Which Records Are Selected

There are two ways to customize what is provided with the system.

If your organization processes records using the same criteria as the samples delivered in the system, in this case CIS Division, simply create a custom batch control for each CIS Division and specify the corresponding parameter value.

If your organization processes records using different criteria, the following points summarize the steps needed to implement a new background process using plug-ins for the specific functionality:

- Duplicate an existing batch control

- Remove the batch parameter not relevant to your organization and replace with the relevant batch parameter. Note: only the batch parameters associated with selecting records should be removed or updated. Parameters used to process records must remain.
- Duplicate the plug-in script associated with the select records algorithm type. Modify the script to pass the new batch parameter(s) to bind variables and remove those that are no longer batch parameters.
- Duplicate the select records algorithm type and associate with the new script.
- Create an algorithm for the new algorithm type. The SQL parameter value should be copied from the original algorithm type's algorithm parameter value and modified to make use of the newly added bind variables. (**Note:** Do not change the fields selected or their order.)
- Update the batch control to use the new select records algorithm.

The Big Picture of Sample & Submit

Sample and Submit refers to the ability to create Activity Requests. This is functionality that enables an implementer to design an ad-hoc batch process using the configuration tools.

Some examples of such processes are:

- Send a letter to customers that use credit cards for auto pay and the credit card expiration date is within 30 days of the current date.
- Stop auto pay for customers that use credit cards as the form of payment if the credit card has already expired. Notify the customer that their auto pay agreement has been terminated and that they need to call to reinstate.
- Select auto pay accounts that have more than X non-sufficient fund penalties, stop the auto pay agreement and notify the customer.

NOTE:

The terms *activity request* and *sample & submit request* may be used interchangeably.

Activity Request Type Defines Parameters

For each type of process that your implementation wants to implement, you must configure an activity request type to capture the appropriate parameters needed by the activity request.

Preview A Sample Prior To Submitting

To submit a new activity request, a user must select the appropriate activity request type and enter the desired parameter values, as applicable.

After entering the parameters, the following actions are possible

- Click **Preview** to see a sample of records that satisfy the selection criteria for this request. This information is displayed in a separate map. In addition, the map displays the total number of records that will be processed when the request is submitted. From this map you can **Save** to submit the request, go **Back** to adjust the parameters or **Cancel** the request.
- Click **Cancel** to cancel the request.
- Click **Save** to skip the preview step and submit the request.

When an activity request is saved, the job is not immediately submitted for real time processing. The record is save in the status Pending and a monitor process for this record's business object is responsible to transition the record to Complete.

As long as the record is still Pending, it may be edited to adjust the parameters. The preview logic described above may be repeated when editing a record.

The actual work of the activity request, such as generating customer contact records to send letters to a set of customers, is performed when transitioning to Complete (using an enter processing algorithm for the business object).

Credit Card Expiration Notice

The base product supplies a sample process to find customers that use credit cards for auto pay and their credit card expiration date is within *X* days of the current date.

To this functionality the following configuration tasks are needed:

- Define an appropriate [customer contact class](#) and [type](#) to use.
- Define appropriate activity request Cancellation Reasons. Cancellation reasons are defined using a customizable [lookup](#). The lookup field name is C1_AM_CANCEL_RSN_FLG.
- Define an activity request type for the business object C1-NotifyExpiringCreditCardTyp . You may define default parameter values for the number of days for expiration and customer contact class and type.

Defining a New Activity Request

To design a new ad-hoc batch job that users can submit via Sample and Submit, first create a new Activity Request Type business object. The base product BO for the activity type C1-NotifyExpiringCreditCardTyp may be used as a sample.

The business object for the activity request includes the functionality for selecting the records to process, displaying a preview map for the user to review and to perform the actual processing. The base product BO for the activity request C1-NotifyExpiringCreditCardReq may be used as a sample. The following points highlight the important configuration for this business object:

- Special BO options are available for the activity request BOs to support the [Preview Sample](#) functionality.
 - Activity Request Preview Service Script. This script is responsible for retrieving the information displayed when a user asks for a preview of a sample of records.
 - Activity Request Preview Map. This is the map that is invoked to display the preview sample results.
- The enter algorithm plugged into the Complete state is responsible for selecting all the records that satisfy the criteria and processing the records accordingly.

Setting Up Activity Request Types

Activity Request Types define the parameters to capture when submitting an activity request through Sample and Submit. To set up an activity request type, open **Admin > Customer > Activity Request Type > Add**.

The topics in this section describe the base-package zones that appear on the Activity Request Type portal.

Activity Request Type List

The Activity Request Type [List zone](#) lists every activity type. The following functions are available:

- Click a [broadcast](#) button to open other zones that contain more information about the adjacent activity type.
- Click the Add link in the zone's title bar to add a new activity type.

Activity Request Type

The Activity Request Type zone contains display-only information about an activity request type. This zone appears when an activity request type has been broadcast from the Activity Request Type List zone or if this portal is opened via a drill down from another page. The following functions are available:

- Click the **Edit** button to start a business process that updates the activity request type.
- Click the **Delete** button to start a business process that deletes the activity request type.
- Click the **Duplicate** button to start a business process that duplicates the activity request type.
- State transition buttons are available to transition the activity request type to an appropriate next state.

Please see the zone's help text for information about this zone's fields.

Maintaining Sample & Submit Requests

Use the Sample and Submit transaction to view and maintain pending or historic activity requests. Navigate using **Menu > Tools > Sample & Submit Request > Search**.

Sample & Submit Request Query

Use the [query portal](#) to search for an existing sample & submit request. Once a request is selected, you are brought to the maintenance portal to view and maintain the selected record.

Sample & Submit Request Portal

This portal appears when a sample & submit request has been selected from the Sample & Submit Request Query portal. The topics in this section describe the base-package zones that appear on this portal.

Sample & Submit

The Sample & Submit zone contains display-only information about an activity (sample & submit) request. The following functions are available:

- Click the **Edit** button to modify the parameters. Refer to [Preview A Sample Prior to Submitting](#) for more information.
- If the activity request is in a state that has valid next states, buttons to transition to each appropriate next state are displayed.

Please see the zone's help text for information about this zone's fields.

Sample & Submit Log

This is a standard [log zone](#).

Security Addendum

This chapter is an addendum to the general [Defining Security and User Options](#) chapter. This addendum describes security functionality that is specific to Oracle Utilities Customer Care and Billing.

Implementing Account Security

CAUTION:

This section assumes you understand [The Big Picture of Row Security](#).

When you create an account, you must define which users can access the account's information. For example,

- If you have customers in two geographic territories, you may need to restrict access to accounts based on the office that manages each territory. For example, only users in the northern office may manage accounts in the northern territory.
- If you have industrial and residential customers, you may need to restrict access to these different customer segments based on the skill set of the users. For example, some users are skilled in dealing with industrial customers, while others are skilled in dealing with residential customers.

By granting a user access rights to an account, you are actually granting the user access rights to the account's bills, payment, adjustments, orders, etc.

FASTPATH:

Refer to [If You Do Not Practice Account Security](#) for setup instructions if your organization doesn't practice account security.

NOTE:

Account security may also affect persons and premises. Refer to [Persons Can Also Be Secured](#) for how access to person information is also restricted by account security. Refer to [Premises Can Also Be Secured](#) for how access to premise information is also restricted by account security.

The topics in this section describe how to implement account security.

Persons Can Also Be Secured

It's important to be aware that persons can also be secured as a result of "account security". It works like this:

- If a person is linked to at least one account, users will not be allowed access to the person (or the person's related information) unless they have access to at least one of the person's accounts.
 - If a person is not linked to any accounts (a rare situation), any user may access the person.
-

NOTE:

How are persons linked to accounts? A person is linked to an account when an account is created using the methods described under [How To Add A New Customer From Control Central](#) and [Order User Interface Flow](#). In addition, you may manually link and unlink persons from account using the [Account - Person](#) page.

Premises Can Also Be Secured

It's important to be aware that premises can also be secured as a result of "account security". It works like this:

- If a premise is linked to at least one account, users will not be allowed access to the premise (or the premise's related information) unless they have access to at least one of the premise's accounts.
- If a premise is not linked to an account (a rare situation), then all users may access the premise.

NOTE:

How are premises linked to accounts? A premise is indirectly linked to an account. For the purpose of access restriction, we deem a premise as being linked to an account if at least one of its service points is linked to at least one of the account's service agreements.

Data Becomes Invisible When Access Is Restricted

The following summarizes the impact of a user not having access to an account:

- [Account Security and Control Central](#)
- [Account Security and Searches \(and Maintenance Pages\)](#)
- [Account Security and To Do Lists](#)

Account Security and Control Central

This section summarizes the impact of account security on [Control Central](#):

- Searches are affected as follows:
- An account will only be visible if a user has access to the account's access group.
- Persons that are not linked to accounts will be visible to all users.
- If a person is linked to an account, the person will only be visible if the user has access to at least one of the person's accounts.
- Premises that are not linked to accounts will be visible to all users.
- If a premise is linked to an account, the premise will only be visible if the user has access to at least one of the premise's accounts.
- The alerts that highlight the existence of "multiple relationships" are not impacted by account security. Specifically:
- The alert Person has multiple accounts will appear if the selected person is linked to multiple accounts, even if the user doesn't have access to every account. Note well, the person couldn't have been selected if the user didn't have access rights to at least one account.
- The alert Premise has multiple accounts will appear if the selected premise is linked to multiple account, even if the user doesn't have access to every account. Note well, the premise couldn't have been selected if the user didn't have access rights to at least one account.
- Only accounts to which the user has access will be displayed in the person tree.
- Only accounts to which the user has access will be displayed in the account tree.
- All other pages contain information related to Control Central's current account context. The current account context can never reference an inaccessible account and therefore these pages are not impacted by account security.

NOTE: If your implementation wishes to allow users to search for all accounts through Control Central without validating the user's access rights, this can be configured by setting up the **Search All Account** option type on the Customer Information Options [Feature Configuration](#) . If the user tries to select an account without having the required access, they will not be able to navigate to the Account Information tab on Control Central for the selected account.

Account Security and Searches (and Maintenance Pages)

Searches are the gateway to the information that appears on maintenance pages. In general, account-related information is suppressed when a user doesn't have access rights to the account. This suppression is true for rows that directly reference an account AND for rows that indirectly reference an account. For example:

- A user can only see bills associated with accounts to which they have access rights.
- A user can only see financial transactions associated with service agreements that are, in turn, associated with accounts to which they have access rights.

NOTE:

Person and premise searches are also impacted. Keep in mind that information will be suppress from both person and premise-oriented searches if the person / premise is related to accounts. Refer to [Persons Can Also Be Secured](#) for how access to person information is also restricted by account security. Refer to [Premises Can Also Be Secured](#) for how access to premise information is also restricted by account security.

Account Security and To Do Lists

Account security does NOT impact the information that appears in a user's To Do list. Rather, we have assumed that your To Do roles (and the users assigned to these roles) are consistent with your account security requirements. This can result in anomalies. For example, it's possible for a supervisor to assign a bill segment error to a user who doesn't have access to the bill segment's account. This user will then see the related To Do entry in their Bill Segments In Error To Do list. However, when they drill down on the entry, account security will manifest itself (i.e., the user won't be able to display the bill segment that's in error). This happens because the drill down causes the bill segment search logic to execute. This logic inhibits the selection of bill segments if the user can't access the related account.

To minimize these anomalies, we recommend the following:

- Setup [To Do Roles](#) consistent with your Data Access Roles.
- Setup [Account Management Groups](#) that are consistent with your Access Groups.
- Setup default To Do Roles on your Account Management Groups for each [To Do type](#).

Restricted Transactions

The following table lists all transactions that have some type of account security. The following notation is used to describe the type of account security:

- **Account-oriented.** This notation is used if the respective transaction uses basic account security (i.e., the user must belong to at least one data access role that has access to the account's access group in order to see the information).
- **Person-oriented.** This notation is used if the respective transaction uses person-oriented account security. Refer to [Persons Can Also Be Secured](#) for more information.
- **Premise-oriented.** This notation is used if the respective transaction uses premise-oriented account security. Refer to [Premises Can Also Be Secured](#) for more information.

- None of the above. Some unusual transactions have unusual implementations of account security. These are described below.

Transaction	Type of Account Security
Account	Account-oriented
Account Bill / Payment History	Account-oriented
Account Financial History	Account-oriented
Account Interval Info	Account-oriented
Account Payment History	Account-oriented
Account Person Replicator	Account-oriented
Account SAs for Debt Class	Account-oriented
Adjustment	Account-oriented
Adjustment Calculation Line Characteristics	Account-oriented
Appointment	Premise-oriented
Bill	Account-oriented
Bill Print Group	Person-oriented
Bill Segment	Account-oriented
Billable Charge	Account-oriented
Budget Review	Account-oriented
Case	Account-oriented, Person-oriented and Premise-oriented
Collection Agency Referral	Account-oriented
Collection Process	Account-oriented
Contract Option	Account-oriented
Control Central	Account-oriented, Person-oriented and Premise-oriented
Customer Contact	Person-oriented
Cut Process	Account-oriented
Declaration	Account-oriented
Deposit Review	Account-oriented
Field Activity	Premise-oriented
Field Order	Premise-oriented
Financial Transaction	Account-oriented
Financial Transaction on a Bill	Account-oriented
Financial Transaction on a Payment	Account-oriented
Interval Profile	Account-oriented (for SA-specific profiles)
Landlord Agreement	Account-oriented
Loan	Account-oriented
Match Event	Account-oriented
Multi-Cancel/Rebill	Account-oriented
Non-Billed Budget	Account-oriented
Order	Account-oriented, Person-oriented and Premise-oriented

Overdue Process	Account-oriented
Pay Plan	Account-oriented
Payment	Account-oriented
Payment Arrangement	Account-oriented
Payment Arrangement for Bills	Account-oriented
Payment Event	The user must have access to ALL accounts linked to the payment event.
Payment Event Quick Add	The user must have access to ALL accounts linked to the payment event(s).
Payment Quick Add	Account-oriented
Payment / Tender Search	Account-oriented
Person	Person-oriented
Premise	Premise-oriented
Premise Management	Premise-oriented
Quote	Account-oriented
SA Billing History	Account-oriented
SA Cash Accounting Balance	Account-oriented
SA Financial History	Account-oriented
SA Relationship	Account-oriented
Service Agreement	Account-oriented
Service Credit Event	The user must have access to ALL accounts linked to the service credit membership that has the service credit event.
Service Credit Membership	The user must have access to ALL accounts linked to the service credit membership.
Service Provider SA Relationship	Account-oriented
Severance Process	Account-oriented
Start/Stop	Account-oriented
Statement	The user can see the statement if they have access to at least one account on the statement's statement construct.
Statement Construct	The user can see the statement if they have access to at least one account on the statement construct.
Terms of Service	Account-oriented (User must have access to at least one account linked to the SA collection in the TOS.)
TOU Map	Account-oriented (for SA-specific TOU maps)
Umbrella Agreement	Account-oriented (User must have access to at least one account linked to the SA collection in the UA's TOS.)
Write Off	Account-oriented
Write Off Process	Account-oriented

Account Security Case Studies

The topics in this section contain examples of how to implement account security. Use these examples to form an intuitive understanding of these objects. Once this intuition is obtained, you'll be ready to design the account security objects for your own company.

Securing Accounts Based On Customer Class

Assume the following security requirement exists:

- You have two broad groups of accounts:
 - Residential accounts.
 - Commercial / Industrial accounts.
- Users can be classified as have one of the following access rights:
 - May access all accounts.
 - May only access residential accounts.
 - May only access commercial / industrial accounts.

The following diagram illustrates the access groups and data access roles required to implement these requirements:

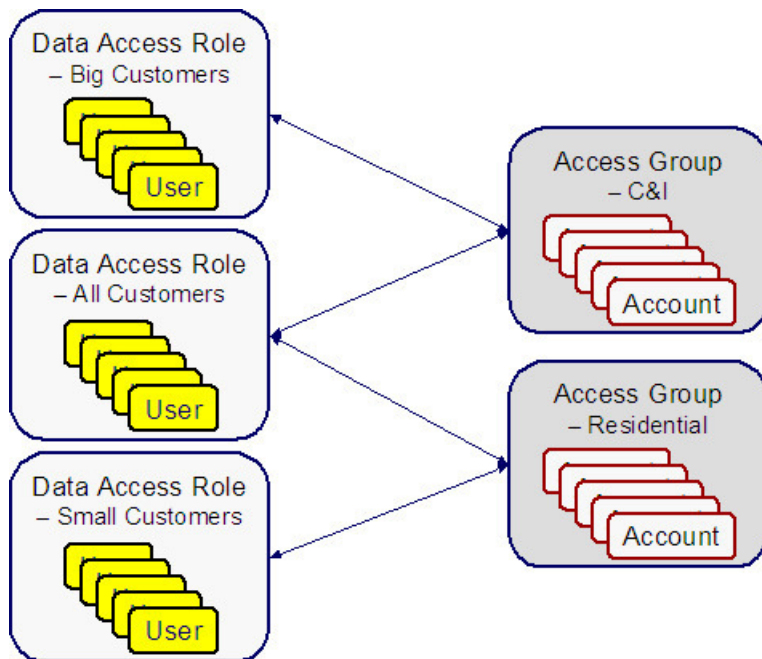

Notice the following about the above:

- There are 2 access groups because access to accounts is based on whether the account is considered to be residential or commercial/industrial.
- The Big Customers data access role is only linked to the C&I access group.
- The Small Customers data access role is only linked to the Residential access group.

- The All Customers access role is linked to both the C&I and Residential access groups. Users with this role can therefore access all accounts.

Securing Accounts Based On Region

Assume that accounts are classified as belonging to one of the following regions:

- Northwestern
- Northeastern
- Southwestern
- Southeastern

Assume the following company hierarchy exists:

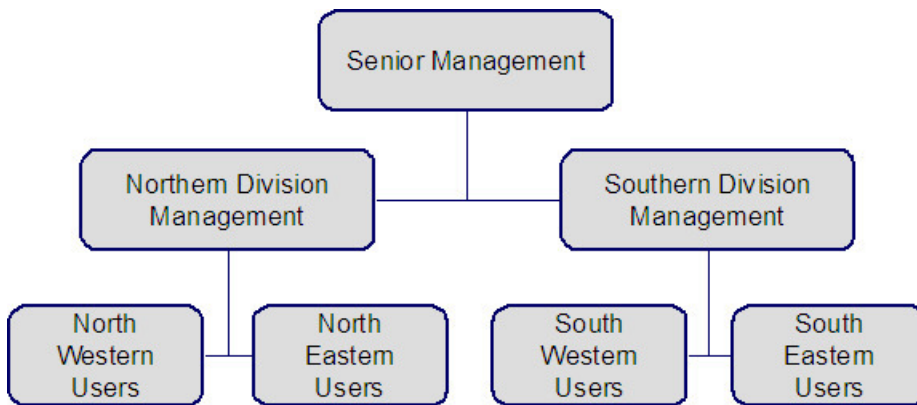

- Senior Management has access to all customers
- Northern Division Management has access to all customers in the Northwestern and Northeastern divisions.
- Southern Division Management has access to all customers in the Southwestern and Southeastern divisions.
- Northwestern Users have access to all customers in the Northwestern division.
- Northeastern Users have access to all customers in the Northeastern division.
- Southwestern Users have access to all customers in the Southwestern division.
- Southeastern Users have access to all customers in the Southeastern division.

The following diagram illustrates the access groups and data access roles required to implement these requirements:

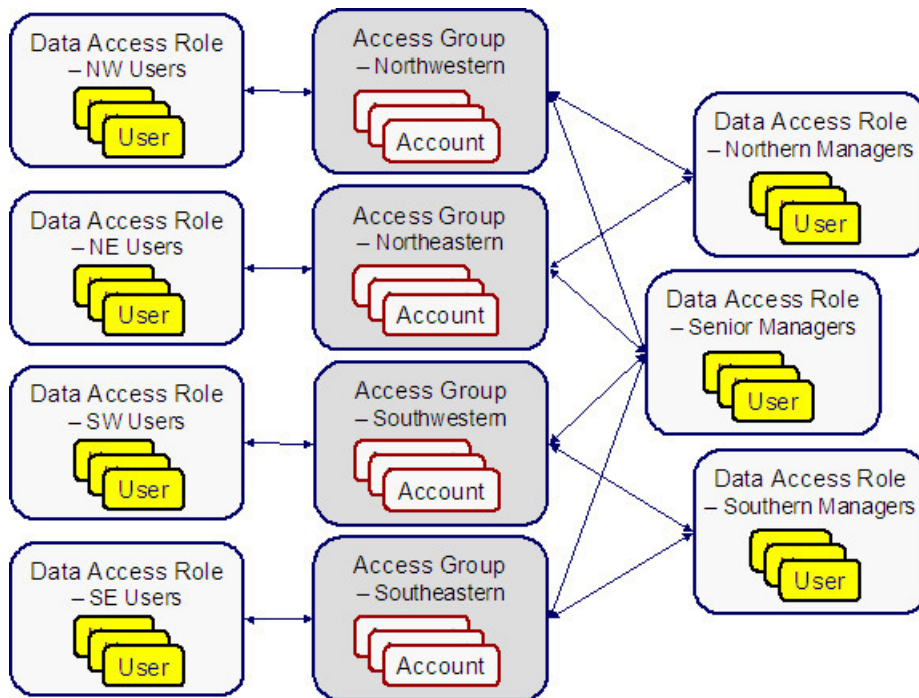

Notice the following about the above:

- There are 4 access groups because access to accounts is based on the region in which they are located (and there are 4 regions).
- There are 7 data access roles because each component of every layer of the access hierarchy requires a separate data access role.

The Default Access Group

There are two ways an access group can be assigned to an account:

- The base package will default an account's access group based on the user who adds the account. It uses the user's [default access group](#) to do this.
- If you can conceive of a rule to assign an appropriate access group to a newly added account, you can have your programming staff introduce a user exit to the account row program to implement this rule. For example, a user exit could be developed that assigns an access group to an account based on its customer class. The name of the user-exit is AFTER-MOVE-CORR-ADD and the name of the account row program is CIPCACCR.

WARNING:

Regardless of the method used to assign an account's access group, please be aware that the user who adds an account must have access to this access group.

NOTE:

Subsequent changes to an account's access group. A user may change an account's access group to any access group to which they have access.

If You Do Not Practice Account Security

If you do not restrict access to accounts (i.e., all users can access all accounts), you must set up one access group and one data access role and then indicate all users are part of this role. You should also define the access group as the default access group on all of your users (so that new accounts are all labeled with this access group).

Masking Sensitive Data

Refer to [Masking Data](#) for instructions describing how to configure the system to mask sensitive data like a customer's social security number or bank account number. If your implementation intends to mask any of the information that appears in the [Customer Information Zone](#) please navigate to this zone's documentation for special instructions.

Encrypting Sensitive Data

The product provides support for encrypting certain sensitive data, which may be necessary if your implementation wants to meet security standards such as those for credit card transactions, as specified by the Payment Card Industry Security Standards Council.

Please be sure that you are familiar with the information documented in [Database Encryption and Masking](#) before reading further.

The remaining details in this section provide information about the fields in the product that support encryption along with the suggested configuration for the **Encryption** feature configuration entry if your implementation opts to encrypt the data.

External Account ID and Credit Card Number Encryption

If your implementation would like to encrypt credit card IDs, the following entry should be added to the Encryption feature configuration so that the data stored in the External ID column on the Account Automatic Payment table is encrypted:

```
table='CI_ACCT_APAY', field='EXT_ACCT_ID', encryptedField='ENCR_EXT_ACCT_ID'
```

NOTE:

- The External Account ID field also exists on other tables such as Auto Pay Clearing Staging table (CI_APAY_CLR_STG) and Payment Event Upload Staging table (CI_PEVT_DTL_ST) . Feature configuration options do not need to be configured for the External Account ID field on these tables as the field on these related tables is encrypted based on the feature configuration specified above for the Account Automatic Payment table (CI_ACCT_APAY).
- A customer's bank account ID or credit card number may also be stored in a column when an order is completed. A field encryption feature configuration for the Order Field table (CI_ENRL_FLD) does not need to be configured if the customer's bank account ID or credit card number is referenced on this table. The encryption for the field should be handled by a Column Reference - Preprocessing algorithm. The base product provides an Encrypt Account Auto Pay External Account Id Column Reference Value algorithm type for this purpose.
- A field encryption feature configuration option needs to be configured for each schema field to be encrypted that represents a customer's bank account ID or credit card number. If the value of an encrypted schema field will later be populated on or compared against an encrypted table field, the schema field and the table field must share the same key alias.

If your implementation is integrated with a self-service application and one time payment details are captured in Person Self-Service Payment Option (CI_PER_SS_PAYOPT) , the product supports encryption of the Credit Card Number and External Account ID fields on this table. In addition, the product supports a hash representation of this fields for searching

purposes. To encrypt Credit Card Number and External Account ID, add the following entries to the Encryption feature configuration:

- **table='C1_PER_SS_PAYOPT', field='CREDIT_CARD_NBR', encryptedField='ENCR_CREDIT_CARD_NBR',hashField='HASH_CREDIT_CARD_NBR'**
- **table='C1_PER_SS_PAYOPT', field='EXT_ACCT_ID', encryptedField='ENCR_EXT_ACCT_ID', hashField='HASH_EXT_ACCT_ID'**

Bank Account Number Encryption

If your implementation would like to encrypt the bank account number stored on the bank account table, the following entry should be added to the Encryption feature configuration:

table='CI_BANK_ACCOUNT', field='ACCOUNT_NBR', encryptedField='ENCR_ACCOUNT_NBR'

MICR ID Encryption

The product provides support for encrypting MICR ID associated with payments. In addition, the product supports capturing a hash representation of this field for searching purposes. This field is captured on three tables and entries should be added to the Encryption feature configuration for each as follows:

- **table='CI_PEVT_DTL_ST', field='MICR_ID', encryptedField='ENCR_MICR_ID', hashField='HASH_MICR_ID'**
- **table='CI_PAY_TNDR_ST', field='MICR_ID', encryptedField='ENCR_MICR_ID', hashField='HASH_MICR_ID'**
- **table='CI_PAY_TNDR', field='MICR_ID', encryptedField='ENCR_MICR_ID', hashField='HASH_MICR_ID'**

NOTE: All configurations must share the same key alias.

Person ID Number Encryption

The product provides support for encrypting an identifier associated with a person. In addition, the product supports capturing a hash representation of this field for searching purposes. Because the ID collection on Person includes an ID type, your implementation may decide to encrypt all IDs captured for the person or may choose to only encrypt IDs of one or more specific ID types. If you want to encrypt multiple ID types, you must configure a field encryption option type for each ID type. The following shows an example of an encryption feature configuration entry for encrypting an ID with the type "SSN":

table='CI_PER_ID', field='PER_ID_NBR', encryptedField='ENCR_PER_ID_NBR', hashField='HASH_PER_ID_NBR', where='ID_TYPE_CD=SSN'

NOTE:

- The Person ID Number also exists on the Order Person ID table (CI_ENRL_PER_ID) table. Feature configuration options do not need to be configured for the Person ID Number field on this table as the field is encrypted based on the feature configuration specified above for the Person Identifier table (CI_PER_ID).
 - The Person ID Number may also be stored in a column when an order is completed. A field encryption feature configuration for the Order Field table (CI_ENRL_FLD) does not need to be configured if the Person ID Number is referenced on this table. The encryption for the field should be handled by a Column Reference - Preprocessing algorithm. The base package provides an Encrypt Column Reference Value algorithm type for this purpose.
 - A field encryption feature configuration option needs to be configured for each schema field to be encrypted that represents a Person ID Number. If the value of an encrypted schema field will later be populated on or compared against an encrypted table field, the schema field and the table field must share the same key alias.
-

Company ID Encryption

The product provides support for encrypting the Company ID that is populated into automatic payment extract files. If your implementation would like to encrypt company IDs on the Auto Pay Route Type table (CI_APAY_RT_TYPE), the following entry should be added to the Encryption feature configuration:

```
table='CI_APAY_RT_TYPE', field='CO_ID', encryptedField='ENCR_CO_ID'
```

In addition, if your implementation allows Company ID overrides by CIS Division, the following entry should be added to the Encryption feature configuration so that the Company ID on the CIS Division Route Type table (C1_CIS_DIV_RTYP) is encrypted.

```
table='C1_CIS_DIV_TRYP', field='OVRD_CO_ID', encryptedField='ENCR_OVRD_CO_ID'
```

Encrypting Legacy Data

If you enable encryption in an existing implementation, you should run the encrypt legacy batch controls to encrypt legacy data that persists in the database:

- F1-ENCRT: Encrypt Legacy Table Field Data
- F1-ENCRS: Encrypt Legacy Schema Field Data
- C1-ECRVL: Encrypt Legacy Order Field Col Ref Value

Before executing the batch processes, you must have a keystore file in the system to hold the keys for encrypting data and define an encryption feature configuration that contains the details for the fields you want to encrypt.

Data Privacy Addendum

This section is an addendum to the general [Data Privacy](#) chapter. This addendum describes Object Erasure functionality that is specific to Oracle Utilities Customer to Meter.

Customer Erasure

A customer's personal information can be erased from the system under certain circumstances - the most common of which is when the information is no longer necessary for the original purposes of which it was collected and processed. This is usually the case when a customer's accounts have been closed for some time and there is no other activity for that customer.

Erasure can be triggered automatically (e.g. as service agreements go into a final state) or manually (e.g. when a customer calls in to request for erasure).

Automatic Trigger Of Customer Erasure

A person's eligibility for erasure can be automatically evaluated when key events occur on that person's accounts. These events include:

- Adding a service agreement
- Closing a service agreement
- Canceling a service agreement
- Reactivating a service agreement
- Accepting a proposal service agreement
- Declining a proposal service agreement
- Reopening a proposal service agreement

- Deleting a proposal service agreement

Monitoring SA Triggers For Customer Erasure

The base product provides an MO Audit algorithm, Monitor SA Manage Erasure Events (C1-SAMNGEREV) that implementations need to plug in on the Service Agreement (SA) MO to enable automatic triggering of erasure.

Note that this algorithm simply creates a General Process record for the Person. This technique allows the system to perform the erasure evaluation (i.e. in the Manage Erasure Schedule algorithm) in batch. This is to minimize the number of times that the Manage Erasure Schedule algorithm is executed for the same Person. For instance, if the customer had one SA closed, another one canceled and another SA created, the erasure evaluation will only be executed once (i.e. when the C1-MNERP batch process runs) even if there were three SA events for that person.

The Manage Erasure Schedule for Person (C1-MNERP) plugin-driven batch process is provided to process the General Process records for managing person erasure. The Process Record algorithm on this batch process invokes the Manage Object Erasure (F1-ManageErasureScheduleDriver) business service. Refer to the C1-MNERP batch control in the application for more details.

Manual Trigger Of Customer Erasure

A customer may call in to request an agent to erase them from the system.

The base product provides a Trigger Customer Erasure (C1-TrgCustEr) BPA script that users can configure as a favorite script in their User Preferences.

This script assumes that the user retrieves the Person before running the script – meaning, the Person is already in the current context. The script pulls in the Person ID and renders the information on the map, which also captures Erasure Date, Erasure Reason and Comments as additional inputs.

A Confirm action will invoke the same Manage Erasure Schedule processing that is executed in automatically triggered person erasures. If the customer is eligible for erasure, the Person and its associated Account(s) and Service Agreement(s) will be scheduled for erasure on the designated Erasure Date. Otherwise, an error will be displayed, indicating ineligibility for erasure.

Refer to the Trigger Customer Erasure (C1-TrgCustEr) BPA script in the application for more details about this script.

The Person MO Controls Customer Erasure

A customer's eligibility for erasure is evaluated at the Person level. This means that only the Person maintenance object will specify a Manage Erasure Schedule algorithm. Eligibility criteria in this algorithm will check the status of the Person's Account(s) and Service Agreement(s) to determine whether or not these objects can be erased. Object Erasure Schedule records are added/updated/discarded, based on the outcome of the eligibility check.

Manage Erasure Schedule Algorithm: Person Erasure Evaluation

The base product supplies a Maintenance Object - Manage Erasure Schedule algorithm – i.e. Person Erasure Evaluation (C1-PEREREVAL) that determines Person Erasure eligibility based on the status of the service agreements (SAs). If all SAs are in some final state - e.g. Closed, Canceled - the Person is deemed eligible for erasure and the corresponding Object Erasure Schedule records are added. Otherwise, the Person is deemed ineligible for erasure. If a person that is already scheduled for erasure happens to have new activity - e.g. started a new SA, reactivated a Closed SA - any existing Object Erasure Schedule records for that Person and its Account(s) and SA(s) will be discarded.

Persons, Accounts And Service Agreements Are Obfuscated

The following sections describe the erasure processing for Person, Account and Service Agreement information.

Purge Versus Obfuscate

Purging involves physical deletion of a record. On the other hand, obfuscation involves updating certain fields in the table that are considered personally identifiable information (PII) – e.g. name, address, etc. The values of these fields are updated to blank or some value that is no longer identifiable to a person – e.g. the random-generated primary key of the Person record.

Base-supplied Person, Account and SA erasure logic performs obfuscation on the root tables of these maintenance objects (MOs). The reasons are:

- Purging could have impacts to external systems
- Purging might cause orphan data or invalid foreign key references within the system

However, base logic does purge most of the data in these MOs' child tables. The exceptions are characteristic tables and some SA child tables that do not contain PII.

Refer to the next sections for details on each object's obfuscation processing.

Person, Account and Service Agreement Erasure BOs

The base product provides the following Object Erasure Business Objects (BOs):

- Person Erasure: C1-ErasureSchedulePerson
- Account Erasure: C1-ErasureScheduleAccoun
- Service Agreement Erasure: C1-ErasureScheduleSA

All are child BOs of the Erasure Root parent BO - F1-ErasureScheduleRoot. These BOs are delivered plugged in on their corresponding maintenance objects.

Refer to the Business Object configuration in the application for more details.

Person, Account and Service Agreement Obfuscation Algorithms

The Person, Account and Service Agreement Erasure business objects include an Enter algorithm (on the Erased state) that is responsible for obfuscating data in the maintenance object's tables. The following sections describe each algorithm.

Person Obfuscation

The Person Erasure (C1-ErasureSchedulePerson) BO is delivered with an enter algorithm on the Erased state - C1-PEROBJERS.

This algorithm performs the following:

- On the Person root table, updates the Address1, City and Postal fields with the PER_ID value.

NOTE: These fields are search fields and are thus indexed.

- Deletes all records in the Person Seasonal Address table
- Deletes all records in the Person Identifier table
- In the Person Name table:
 - The primary name is retained and the name value is replaced with the PER_ID value.

NOTE: Deletion of the primary name makes the Person record and its Account and SA records unsearchable through the user interface - e.g. via Control Central search.

- All other names are deleted
- Deletes all records in the Person Phone table
- Deletes all records in the Person Contact table
- Deletes all records in the Person-to-Person table
- Deletes all records in the Person Self-Service Payment Option table

NOTE: The base algorithm does not obfuscate nor delete any Person Characteristics because this data is implementation-specific. Implementations that store any personally identifiable information (PII) in this table - e.g. in adhoc characteristic values should add their specific obfuscation/delete logic for these characteristics.

Account Obfuscation

The Account Erasure (C1-ErasureScheduleAccount) BO is delivered with an enter algorithm on the Erased state - C1-ACCTOBFS.

This algorithm performs the following:

- In the Account root table:
 - Removes the link to the Mailing Premise Id
 - Clears contents of the Account Data Area
- Deletes all Account Person records except the main Person.

NOTE: Deletion of the 'main' person makes the Account unsearchable through the user interface - e.g. via Control Central search.

- Updates the main Person's Address Source to Person
- Deletes all records in the Person Address Override table
- Deletes all records in the Account Auto Pay table
- Deletes all records in the Account Alerts table
- Deletes all records in the Account Messages table
- Deletes all records in the Account Credit Rating History table
- Deletes all records in the Account Debt Monitor Review Schedule table
- Deletes all records in the Non-Cash Deposit table
- Deletes all records in the Budget Review table
- Deletes all records in the Notification Preferences table and its child tables

NOTE: The base algorithm does not obfuscate nor delete any Account Characteristics because this data is implementation-specific. Implementations that store any personally identifiable information (PII) in this table - e.g. in adhoc characteristic values should add their specific obfuscation/delete logic for these characteristics.

Service Agreement Obfuscation

The Service Agreement Erasure (C1-EraseScheduleSA) BO is delivered with an enter algorithm on the Erased state - C1-SAOBFSCTN.

This algorithm performs the following:

- On the SA root record, removes the link to the Characteristic Premise.
- Deletes all records in the SA/SP table and its child tables: SA/SP Field Activity and SA/SP Characteristics

NOTE: The base algorithm does not obfuscate nor delete any Service Agreement Characteristics because this data is implementation-specific. Implementations that store any personally identifiable information (PII) in this table - e.g. in adhoc characteristic values should add their specific obfuscation/delete logic for these characteristics.

Configuring The System For Customer Erasure

The following are the steps to enable Customer Erasure:

- Plug in the Manage Erasure Schedule - Person Erasure Evaluation algorithm on the Person MO.
- Configure the Erasure Period option on each of the Person, Account and SA MOs.

NOTE: Note: The values for all three MOs should be the same, to ensure the Erasure Dates are the same on the resulting Object Erasure Schedule records.

- Plug in the Monitor SA Manage Erasure Events (C1-SAMNGEREV) Audit algorithm on the SA MO.
- If using the Trigger Customer Erasure (C1-TrgCustEr) script to manually trigger person erasure:
 - Configure values for the Erasure Reason lookup field DP_CUST_ERS_RSN_FLG.
 - Configure the C1-TrgCustEr BPA script as a Favorite Script in User Preferences.

Notifying External Systems About Customer Erasure

When CCB is integrated with a meter data management system (such as Oracle Utilities Meter Data Management) and the Person and SA syncs are used to synchronize Contact and Usage Subscription information with corresponding Person and SA information, the meter data management needs to be notified when such information is already erased in CCB.

The following sync request BO schemas include a Customer Erased switch:

- MDM2 Person Sync Request: C1-MDM2PersonSyncRequest
- MDM2 SA Sync Request: C1-MDM2SASyncRequest

Logic on these BOs sets this switch to true if the related Person/SA has an Object Erasure Schedule record that is in the Erased state.

The meter data management system can use this switch to trigger its own erasure processing for Contact and Usage Subscription information. For an example, refer to the Data Privacy documentation for Oracle Utilities Meter Data Management.

Refer to the Business Object configuration in the application for more details.

Defining Converted COBOL Program Options

The topics in this section describe the transaction that allows you to define the metadata for converted COBOL programs within the current environment's database.

CAUTION: Updating converted COBOL Programs requires technical knowledge of the system. This is an implementation and delivery issue and should not be attempted if you do not have previous experience.

Converted COBOL Program - Main

Use this transaction to define converted COBOL program user exits for your system. Navigate to this page using **Admin > System > Converted COBOL Program > Search**.

Description of Page

The following describes fields that are relevant to defining the user exit code that a converted COBOL Program should use:

Program Component ID represents the internal ID that is given to the converted COBOL program component.

Program Com Name is the physical name of the converted COBOL program component.

Template is the template used to generate the converted COBOL program component.

Location ID (*for development purposes*)

Table (*for development purposes*)

User Exit Program. Specify if you have written user exit code for this converted COBOL program component.

Development Status Flag. Options include Note Generated and Not Regeneratable.

Short Comments provides a short description of the converted COBOL program component.

Long Comments provides more details of the converted COBOL program component.

The **Variable Information** grid (including Variable Name, Occurrence, Variable Sequence, Variable Value, and Variable Alternate Value) is *for development purposes only*.

Advanced Search Options

The product offers an option to perform expanded / fuzzy searching in [Control Central](#) Search by Name and Address. The option is only available if your implementation has appropriately configured your database for fuzzy searching.

Refer to the DBA guide in the installation guide for details on setting up the database to support fuzzy searching. Note that there are some implementations where fuzzy searching will not be possible. For example, it's only available for implementations using the Oracle database. Additionally, not all languages are supported. Refer to the Oracle Database documentation for more information about fuzzy searching.

If your implementation has configured its database to enable fuzzy searching, you must also set up a [Feature Configuration](#) to indicate that feature is supported. Find the Feature Configuration record for the **General System Configuration** feature type. (It may need to be defined if it does not exist). Choose the option type **Enable Expanded Results** and define a value of **Y**.

Integration

Oracle Utilities Customer to Meter provides tools to facilitate the integration with other systems. This section provides technical information needed by your implementers to accomplish this.

CTI-IVR Integration

Oracle Utilities Customer Care and Billing provides tools to facilitate the integration with your Computer Telephony Integration/Interactive Voice Response (CTI/IVR) system. The interface provides the following functionality:

- The ability to launch Control Central for a particular account ID or phone number from an external application
- The ability to accept the next call, as dictated by the CTI software,
- The ability to perform an outbound phone call from within Oracle Utilities Customer Care and Billing

This document provides technical information needed by your implementers to fully integrate with your CTI/IVR system.

CTI-IVR Integration Configuration

The integration with your Computer Telephony Integration/Interactive Voice Response (CTI/IVR) system requires the setup of master configuration data that controls the Next Caller and Automated Dialer functions.

To set up the CTI/IVR integration master configuration, navigate using **Admin > General > Master Configuration**. You are brought to an all-in-one portal with options to add/edit the CTI/IVR Integration master configuration record. Refer to the embedded help for more details on how each section in this record is configured.

Launching The System From an External Application

The following section describes possible options to launch the system from an external system.

Launching The Application Using a URL

You launch the application using a URL. With this option you can set the system to launch a script upon startup. You can also indicate to the system to automatically load an appropriate page (if this information is not part of the script).

The application includes a simple sample html page that can launch CCB Control Central Search by Phone Number or by Central Search Account Id. The page is called CTISample.HTM and is located in /cm_templates.

FASTPATH:

Refer to [Launching A Script When Starting The System](#) for further information.

Receiving the Next Caller in the Queue

If your CTI-IVR system allows users to request the next caller waiting in a queue, the system provides a mechanism to integrate with this functionality.

A BPA script called **Get Next Caller (C1-GtNxtClrC)** is available that can be used to request the next call waiting in an inbound queue managed by a CTI application.

When the **Get Next Caller** BPA is executed, it launches the **CTI Get Next Caller** and **Launch CTI** processing scripts that are defined in the CTI/IVR Integration master configuration. Your implementation creates the **CTI Get Next Caller** script that retrieves the next account in the queue. The base product supplies a sample **Launch CTI** BPA script that launches Control Central using the **C1-CCByAcct** BPA script and passing in the account that was returned by the **CTI Get Next Caller** script.

Customize Integration to Your Next Caller Function

Your implementation needs to create a **CTI Get Next Caller** processing script that will be responsible for getting the next account in the queue, based on your integrated CTI application. The base-supplied **Launch CTI** processing script can be used to navigate to Control Central with the next caller's account passed in.

In order to integrate the next caller functionality with your CTI-IVR system, perform the following steps:

- Create your custom **CTI Get Next Caller** service script that retrieves the next account from the queue.
- Create a **Launch CTI** BPA script if your business rules require additional logic and/or need to launch a different page in the system..
- Plug in the **CTI Get Next Caller** and **Launch CTI scripts** on the CTI/IVR Integration master configuration.

Initiating an External Call

This section describes the automated dialer functionality provided with the system as well as information about integrating with your own automated dialer.

Overview of Automated Dialer

In order to initiate a call to a customer from within the system, a context menu item **Go To Automated Dialer** is available on the Person context menu. To call a customer displayed in the current context, choose this option from the person context menu and a window appears, showing a list of phone numbers defined for that person.

Select the desired phone number and click **Dial**.

NOTE:

Context Entry Secured. The [navigation key](#) for this window `automatedDialer` refers to an application service to facilitate application security. If your installation does not support an integration with external dialer software, configure the security settings to ensure that users do not have access to the application service for this context entry.

Technical Implementation of Automated Dialer

The popup window is implemented as a BPA script (**C1-LAutoDial**) that calls a configurable **Automated Dialer** BPA script that is responsible for retrieving and displaying person contacts and phone numbers (i.e. if the installation option is set to Use Legacy Person Phone and Email feature configuration option is set to 'Y'). The **C1-AutoDial** sample script provided with the system integrates to any soft phone protocol handler that launches a dialer based on overriding the "tel:" protocol from a browser, for example, Cisco IP Communicator. It launches a UI map to display the person contacts and phone numbers (i.e. if the feature option is set).

Phone Dialer Configuration

If your implementation chooses to use the functionality provided with the system and integrate with a soft-phone dialer, plug in the base-supplied **C1-AutoDial** script in the CTI/IVR Integration master configuration.

Customize Integration to Your Automated Dialer Software

In order to integrate with a different automated dialer software application, your implementers must create your own **Automated Dialer BPA** script, to call your specific dialer.

- Copy the **C1-AutoDial BPA** script and make the appropriate changes to integrate with your automated dialer (e.g. change the protocol from “tel:” to “callto:”.
- Plug in your custom Automated Dialer script on the CTI/IVR Integration master configuration.

Customize Automated Dialer User Interface

Your implementation may choose to display a different user interface for the **Go To Automated Dialer** function than the one provided with the system. For example, perhaps there is more information that you would like to display in addition to the person's name and phone numbers. In order to do this, your custom **Automated Dialer** script needs to invoke a custom UI map that you create as follows:

- Copy the base-supplied **C1-AutomatedDialer** UI map and make the necessary changes.
- Invoke your custom UI map from your custom **Automated Dialer** .

Analytics Integration Overview

Oracle Utilities Customer to Meter provides tools to facilitate the integration with Oracle Utilities Analytics.

Analytics Configuration

This section describes functionality provided for integrating with Oracle Utilities Analytics (OUA).

- **Customer Analytics Configuration Portal**

Oracle Utilities Customer to Meter provides a Customer Analytics Configuration portal that holds information on the customer analytics configuration activities. This portal provides a summary of how much configuration has been set up, and also provides links and guidelines for the areas that need configuration, at the minimum, to successfully extract data from Oracle Utilities Customer Care and Billing to OUA. The following provides more information about this functionality.

1. **Customer Analytics Configuration Details** – These data load parameters are used to extract, load, and transform data from Oracle Utilities Customer Care and Billing to Oracle Utilities Analytics. These parameters are used to identify and/or filter data when loading them into the data warehouse. Refer to the *Oracle Utilities Customer Care and Billing* section in the **Configuring Oracle Utilities Analytics** chapter of the *Oracle Utilities Analytics Administration Guide* for detailed information on each extract parameter.
2. **Bucket Configuration List** – This is a summary of the bucket configurations that are needed to classify and group extracted data within Oracle Utilities Analytics. The bucket configurations provide the ability to readily report and analyze data by buckets, or groups. Refer to the *Oracle Utilities Customer Care and Billing* section in the **Configuring Oracle Utilities Analytics** chapter of the *Oracle Utilities Analytics Administration Guide* for detailed information on each bucket configuration supported by Oracle Utilities Customer Care and Billing.

- **Characteristic Mapping**

Oracle Utilities Customer Care and Billing has identified the objects for which characteristic extraction is supported. This includes mapping the source characteristic entity to the target dimension, and defining which target columns are allowed to be mapped for which target dimension. The following table shows the supported mapping.

Object	Supported Target Dimension	Supported Target Columns
Account Characteristic	Account Dimension	User Defined Fields 6 - 15
Person Characteristic	Person Dimension	User Defined Fields 1 - 6
Premise Characteristic	Premise Dimension	User Defined Fields 6 - 18
Premise Characteristic	Address Dimension	User Defined Fields 7 - 16
Service Agreement Characteristic	Service Agreement Dimension	User Defined Fields 9 - 19

Meter Analytics Configuration Portal

The Meter Analytics Configuration portal holds information on the meter data analytics configuration activities. This portal provides a summary of how much configuration has been set up, and also provides links and guidelines for the areas that need configuration, at the minimum, to successfully extract data from Oracle Utilities Meter Data Management to OUA. The following provides more information about this functionality.

- **Analytics - Oriented Master Configuration:** These data load parameters are used to extract, load, and transform data from Oracle Utilities Meter Data Management to Oracle Utilities Analytics. They are used to identify and/or filter data when loading them into the data warehouse. Refer to the *Oracle Utilities Meter Data Management* section in the *Configuring Oracle Utilities Analytics* chapter of the *Oracle Utilities Analytics Administration Guide* for detailed information on each extract parameter
- **Analytics - Oriented Extendable Lookup List:** The meter data analytics related Extendable Lookup Business Objects are listed in this section. It provides a navigation link to the extendable Lookup Maintenance portal where the lookup values can be configured. Refer to the *Oracle Utilities Meter Data Management* section in the *Configuring Oracle Utilities Analytics* chapter of the *Oracle Utilities Analytics Administration Guide* for detailed information on meter data analytics related extendable lookups.
- **Service Point Configuration List:** This lists the service point types within the system and indicates for each whether or not the meter analytics configuration has been setup. It provides a navigation link to the service point type where the necessary configuration can be setup or modified. Refer to the *Oracle Utilities Meter Data Management* section in the *Configuring Oracle Utilities Analytics* chapter of the *Oracle Utilities Analytics Administration Guide* for further information.

Batch Controls

Batch Code	Name / Description
D1-SPSDL	Service Point Snapshot Download
D2-DUGDL	Usage Subscription Usage Group Download
D2-MVREF	Materialized View Refresh
D2-USGDL	Service Point Usage Snapshot Download
D2-UUSDL	SP Unreported Usage Snapshot Download
D2-VEEDL	SP VEE Exception Snapshot Download

References

Refer to the following documentation for more information about Oracle Utilities Analytics:

- *Oracle Utilities Analytics Admin Guide*
- *Oracle Utilities Analytics Dashboards for Oracle Utilities Customer Analytics, Revenue Analytics and Credit & Collections Analytics Metric Reference Guide*
- *Oracle Utilities Analytics Dashboards for Oracle Utilities Exception Analytics Metric Reference Guide*
- *Oracle Utilities Analytics Dashboards for Oracle Utilities Meter Data Analytics Metric Reference Guide*
- *Oracle Utilities Extractors and Schema for Oracle Utilities Customer Care and Billing Data Mapping Guide*
- *Oracle Utilities Extractors and Schema for Oracle Utilities Meter Data Management Data Mapping Guide*

Self-Service Integration

The following sections describe functionality provided for the integration with self-service applications such as Oracle Utilities Customer Self Service (OUCSS).

About Self-Service Tasks

Self-service tasks hold information about self-service operations that customers initiate from an integrated self-service application, such as Oracle Utilities Customer Self-Service (OUCSS).

A few examples of self-service tasks are:

- One time payments
- Account verification
- Start/Stop requests
- Auto pay setup
- Creating customer meter readings

Refer to the Oracle Utilities Customer Self-Service (OUCSS) documentation for more details on supported self-service operations.

The following sections highlight self-service integration functionality.

Self-Service Task Type Defines Self-Service Task Behavior

Each type of self-service operation has specific processing requirements.

Self-service task type controls how a self-service task is processed. It defines the business object to use when creating the self-service task record. The business object defines the lifecycle of self-service task record.

The self-service task type can also specify common configuration data, such as settings for error handling.

Creating Self-Service Tasks

The customer self-service application invokes inbound web services to create self-service tasks. The system supplies an inbound web service for each supported self-service operation.

Refer to the Oracle Utilities Customer Self-Service (OUCSS) documentation for more details on supplied inbound web services.

Each inbound web service references a service script that processes the specific self-service operation. Refer to the service script system data for processing details.

Setting Up Self-Service Task Configuration

Self-Service Integration Configuration

The integration with a self-service application such as Oracle Utilities Customer Self Service (OUCSS) requires the setup of master configuration data that controls the processing of your self-service operations.

To set up self-service integration master configuration, navigate using **Admin > General > Master Configuration**. Two master configurations are required:

- **CCB Self Service Integration:** This master configuration is used for the integration of customer data with a self service application.
- **MDM Self Service Master Configuration:** This master configuration is used for the integration of meter data with a self service application.

Refer to the embedded help for more details on how each section in these records is configured.

Defining Self-Service Task Types

A self-service task type defines properties that control how a self-service task is processed.

Refer to [About Self-Service Tasks](#) for an overview of service task functionality.

To maintain the types applicable to your product, open **Menu > Self-Service > Self-Service Task Type**.

This is a standard [All-in-One portal](#).

The information captured on the self-service task type depends on the business objects supported by your product. Refer to the embedded help text for more information.

Maintaining Self-Service Tasks

This section describes the functionality supported for viewing and maintaining self-service tasks.

Refer to [About Self-Service Tasks](#) for an overview of self-service task functionality.

Navigate using **Menu > Self-Service > Self-Service Task > Search**. You are brought to a query portal with options for searching for self-service tasks.

Once a self-service task record has been selected, you are brought to the maintenance portal to view and maintain the selected record.

The **Self-Service Task** zone provides basic information about a self-service task. Refer to the embedded help for more information.

Configuring Rate Compare Usage Adjustment Profiles

This section describes the steps involved in setting up usage adjustment profiles for use with the Rate Compare feature in Oracle Utilities Customer Self- Service.

1. Create a characteristic type and values for each type of usage adjustment to be made available for rate comparison purposes. For example, if you wanted to allow adjustments for installation of solar panels, use of an energy-efficient appliance, or use of an electric vehicle, you would create three characteristic types (one for each type of adjustment), and values for each option within each type (each type of appliance or electric vehicle supported).
2. Create profile (stand-alone) measuring components that correspond to each characteristic type value.

3. Create profile data for each measuring component. This is interval data that represents the impact of the usage adjustment on a customer's consumption.
4. Create a profile factor for each usage adjustment type.
5. Create factor values for each factor. These values correspond to the characteristic type value, and link characteristic type values to profile measuring components.
6. Create one (or more) [Profile Accumulation](#) usage calculation rules that will apply the usage adjustment profile to the customer's interval consumption when calculating usage for the rate comparison request.
7. Create entries in the Customer Rate Schedule extendable lookup to associate the usage calculation group that contains the "Profile Accumulation" usage calculation rule to a rate schedule.
8. Create entries in the Usage Adjustment Types extendable lookup for each usage adjustment type.
9. Set up the Rate Compare Configuration section of the MDM Self-Service Master Configuration to link usage adjustment factors and usage adjustment types to rate schedules Oracle Utilities Customer Care and Billing (defined in the Customer Rate Schedule extendable lookup).

Characteristic Types

Create a characteristic type and values for each type of usage adjustment you wish to make available to customer self-service users. For example, to create a usage adjustment profile for use of an electric vehicle, you would create an "electric vehicle" characteristic type and define values for each type of electric vehicle users can select.

Example Characteristic Type:

- Characteristic Type: ELEC_VEH
- Description: Electric Vehicles
- Type of Char Value: Predefined Value
- Characteristic Values:

Characteristic Value	Description
LEAF	Nissan Leaf
TESLA	Tesla Model S
VOLT	Chevrolet Volt

Profile Measuring Components

Create profile measuring components for each characteristic type value. These measuring components will be used to store profile data for each type of usage adjustment.

Note: The base package does not include stand-alone measuring component/measuring component type business objects, but the demonstration database contains "Standalone Interval" and "Standalone Interval Measuring Component Type" business objects that can be used to create profile measuring components and types.

Example Profile Measuring Component Type:

- Measuring Component Type: KWH-PROFILE
- Description: KWH Profile
- Measuring Component Business Object: Standalone Interval (demo)
- Measurement Business Object: Measurement
- Service Type: Electric

- Allow Negative Consumption: Allowed
- Consumptive / Subtractive: Consumptive
- Seconds Per Interval: 01:00:00
- Value Identifiers:
- Value Identifier Type: Measurement
- Short-Hand Description: kWh
- UOM: Kilowatt-Hours

Example "Nissan Leaf" Profile Measuring Component:

- Measuring Component Type: KWH Profile
- Number of Digits Left: 5
- Number of Digits Right: 5
- Time Zone: US Pacific Time
- Status: Active
- How To Use: Additive
- External ID: Nissan Leaf

Example "Tesla Model S" Profile Measuring Component:

- Measuring Component Type: KWH Profile
- Number of Digits Left: 5
- Number of Digits Right: 5
- Time Zone: US Pacific Time
- Status: Active
- How To Use: Additive
- External ID: Tesla Model S

Example "Chevrolet Volt" Profile Measuring Component:

- Measuring Component Type: KWH Profile
- Number of Digits Left: 5
- Number of Digits Right: 5
- Time Zone: US Pacific Time
- Status: Active
- How To Use: Additive
- External ID: Chevrolet Volt

Profile Data

Create profile data for each profile measuring component. This data represents the impact of the usage adjustment on a customer's consumption.

Note that this profile data can (and often will) include negative interval values to represent the difference in consumption applicable for the usage adjustment type. For example, if an energy- efficient electric clothes dryer uses an average of 30 kilowatt hours less per month than an average electric clothes dryer, profile data for that appliance might be a "straight line"

hourly profile (a profile in which all intervals are of the same value) in which each value equals "0.042" (30 kWh per month divided by an average of 720 hours per month).

Factors / Factor Values

Create a profile factor for each usage adjustment type. This factor should use the "Factor Characteristic Source N/A Algorithm" to derive the appropriate characteristic type value based on the factor value, and should reference the characteristic type created earlier.

Example Electric Vehicle Factor:

- **Factor:** ELECTRIC_VEHICLE
- **Description:** Electric Vehicle
- **Factor Class:** Profile
- **Characteristic Source Algorithm:** Factor Characteristic Source N/A Algorithm
- **Factor Characteristic Type:** Electric Vehicle

Example "Nissan Leaf" Factor Value

- **Factor:** Electric Vehicle
- **Factor Characteristic Type:** Electric Vehicle
- **Factor Characteristic Value:** LEAF
- **Effective Date/Time:** 01-01-2014 12:00:00AM
- **Profile:** Nissan Leaf, KWH Profile

Example "Tesla Model S" Factor Value

- **Factor:** Electric Vehicle
- **Factor Characteristic Type:** Electric Vehicle
- **Factor Characteristic Value:** LEAF
- **Effective Date/Time:** 01-01-2014 12:00:00AM
- **Profile:** Tesla Model S, KWH - 60 Minutes

Example "Chevrolet Volt" Factor Value

- **Factor:** Electric Vehicle
- **Factor Characteristic Type:** Electric Vehicle
- **Factor Characteristic Value:** LEAF
- **Effective Date/Time:** 01-01-2014 12:00:00AM
- **Profile:** Chevrolet Volt / KWH - 60 Minutes

Profile Accumulation Usage Calculation Group and Rule

Create a usage calculation group that contains a "Profile Accumulation" usage calculation rule. This rule will calculate usage by accumulating historical usage with profile data. based on a selected profile factor value.

Note: Profile Accumulation rules should use eligibility criteria to ensure they are only executed when the "Calculation Mode" on the usage transaction is set to "Hypothetical Calculation" (D2HC).

Example: Profile Accumulation Usage Calculation Rule

- **Usage Calculation Group:** Electric Residential Interval KWH

- **Usage Calculation Rule:** KWH_PROFILE_ACCUMULATION
- **Sequence:** 10
- **Description:** KWH Profile Accumulation
- **Category:** Usage Calculation
- **Vector Source Configuration:**
- **Vector Type:** Channels Linked to Usage Subscription
- **Unit of Measure:** Kilowatt-Hours
- **Time of Use:**
- **Service Quantity Identifier:**
- **Target SPI:** 01:00:00
- **Result Processing Configuration:**
- **Apply TOU Map to Derived Vector:** Yes
- **TOU Map:** Summer / Winter, 15 minute interval
- **Result Storage Configuration:**
- **Insert Primary SQ Entry:** Yes
- **Save Derived Vector:** No
- **Service Quantity Identifier:**
- **Extract Interval Data:** No

Customer Rate Schedule Extendable Lookup

Create an entry in the "Customer Rate Schedule" extendable lookup to associate the usage calculation group that contains the "Profile Accumulation" usage calculation rule to an applicable rate schedule in Oracle Utilities Customer Care and Billing.

Example Customer Rate Schedule extendable lookup:

- **Rate:** E-INT-RES
- **Description:** Electric Residential Interval Rate
- **Default Usage Calculation Group:** Electric Residential Interval KWH (E-INT-RES)

Usage Adjustment Types Extendable Lookup

Create an entry in the "Usage Adjustment Type" extendable lookup for each type of usage adjustment that will be available to customer self-service users. These entries are used in the Rate Compare Configuration section of the Self-Service Master Configuration (see below).

Example Electric Vehicle entry:

- **Usage Adjustment Type:** ELEC_VEHICLE
- **Description:** Purchase of Electric Vehicle
- **Override Description:** Purchase of Electric Vehicle
- **External Reference ID:** Purchase of Electric Vehicle

MDM Self-Service Master Configuration - Rate Compare Configuration

Configure the "Rate Compare Configuration" section of the MDM Self-Service Master Configuration to associate usage adjustment factors and usage adjustment types with an applicable rate schedule in Oracle Utilities Customer Care and Billing (defined in the Customer Rate Schedule extendable lookup).

Example MDM Self-Service Master Configuration:

- **Factor Characteristic Type Indicating No Value Variation: N/A**
- **External Reference Factor Value Characteristic Type: External Reference ID**
- **Minimum Days of Usage Adjustment Data: 2**
- **Rate / Usage Adjustments:**
- **Rate:** Electric Residential - Interval KWH
- **Usage Adjustments:**
- Usage Adjustment Factor: Electric Vehicle
- Usage Adjustment Type: Purchase of Electric Vehicle

Defining DataConnect Options

Oracle Utilities DataConnect facilitates data extraction from Oracle Utilities Customer to Meter for use in external applications; such as, analytics applications and energy management systems.

This section describes how Oracle Utilities DataConnect works and how to implement and configure the system to support data extract processing.

DataConnect Data Extracts

Oracle Utilities DataConnect can be used to extract the following types of data:

- **Customer Data**
(see [Customer and Premise Data Extracts](#) for more information)
 - Account information (including service agreement, account, and person related information)
 - Service agreement's service point information
 - Mailing address information
- **Premise Data**
(see [Customer and Premise Data Extracts](#) for more information)
 - Premise information
 - Service point information
 - Device installation information
 - Device information
 - Measuring component information
- **Billing Data**
(see [Billing Data Extracts](#) for more information)
 - Bill

- Bill segment
- Bill segment calculation lines
- Bill segment service quantities
- **Measurement Data**

(see [Consumption Data Extracts](#) for more information)

The data extracted can be correlated in external systems using the service agreement and/or service point data that is included in each type of extract. All data extracts contain a combination of the following data elements that can be used for this correlation:

- **CCB Service Point ID:** The service point ID in Oracle Utilities Customer to Meter and/or
- **MDM Service Point ID:** The service point ID in Oracle Utilities Meter Data Management and/or
- **Service Agreement ID:** The service agreement ID in Oracle Utilities Customer to Meter

External systems receiving data extracted from the Oracle Utilities DataConnect facilities can use these IDs to associate billing data and measurement data to extracted master data.

NOTE: There is a version 1 and version 1+ for the DataConnect extracts. In the following pages where a system object such as a batch control or data area is noted the objects are listed as (v1/v1+). When only a single object is noted it applies to both v1 and v1+.

Customer and Premise Data Extracts

Customer and premises data extracts are performed through the use of data synchronization, audit algorithms, business objects, and related batch processes.

Batch processes are used to create initial load extracts for service agreement / account / person, service point, device configuration, device, and install event related master data. The initial load includes the historical data in the system (either all or a subset, depending on how the batch process is configured). Following the initial load, data synchronization requests are created when master data is added or changed.

Customer and Premise Data Extracts: Maintenance Object Audit Algorithms

Detecting changes in customer and premise data can be identified by audit algorithms on the following maintenance objects:

- Service Agreement
- Account
- Person
- Service Point (MDM Service Point)
- Install Event
- Device

The Generic Change Data Capture algorithm type (F1-GCHG-CDCCP), which is provided in the base package, can be used to create audit algorithms for following maintenance objects:

- Service Agreement
- Service Point (MDM Service Point)
- Install Event

In addition, the following audit algorithm types can be used to create audit algorithms for customer and premise data:

- Account Change Data Capture (Customer Data Extract) (C1-ACCECDCCU)

- Person Change Data Capture (Customer Data Extract) (C1-PERECDCCU)
- Account Mailing Address Change Data Capture (C1ACCMACDC)
- Device Change Data Capture (SP/Meter-Based) (D1-SPDV-CDCP)
- Install Event Change Data Capture (SP/Meter-Based) (D1-SPIE-CDCP)
- Device Change Data Capture (SP/Meter-Based) (D1-SPDC-CDCP)

The following algorithm types are used with v1 ONLY.

- An **Account Change Data Capture (SA-Based) – Include Reactivated SAs** algorithm type (C1-ACCCDCSAR) is provided in the base package. This algorithm type can be used to create an audit algorithm on the Account maintenance object to determine if a service agreement sync request record is to be created for each of the account's non-closed, non-canceled service agreement(s). A change in a related account's details will instantiate a Service Agreement Extract Sync Request (of the type defined for the SA Sync Request BO algorithm parameter) if one does not already exist in the initial state for the service agreement. The base package also contains an algorithm (C1-ACCECDCSA) that is based on this algorithm type.
- A **Person Change Data Capture (SA-Based) – Include Reactivated SAs** algorithm type (C1-ACCCDCSAR) is provided in the base package. This algorithm type can be used to create an audit algorithm on the Person maintenance object to determine if a service agreement sync request record is to be created for each of the person's non-closed, non-canceled service agreement(s). A change in the main person details linked to the service agreement's account will instantiate a Service Agreement Extract Sync Request (of the type defined for the SA Sync Request BO algorithm parameter) if one does not already exist in the initial state for the service agreement. The base package also contains an algorithm (C1-PERECDCSA) that is based on this algorithm type.

Customer and Premise Data Extracts: Business Objects and Algorithms

The maintenance object audit algorithms create data synchronization requests in the following manner:

- If the Generic Change Data Capture (F1-GCHG-CDCP) algorithm type (provided in the base package) is used, the synchronization requests are based on the Sync Request BO maintenance object options.
- Alternatively, if the base package supplied Maintenance Object – Audit algorithm types, which are outlined in the [Customer and Premise Data Extracts: Maintenance Object Audit Algorithms](#) section are used, the synchronization requests are based on the Sync Request BO defined in the algorithm parameters.

Customer Data

Extraction of customer data, including account, service agreement, and person information, is supported by the following data synchronization business objects.

- **Customer Data Extract for DataConnect** (C1-ExternalRepoPlusCusDataSync): used to extract service agreement / account / person related information. This business object should be defined as a value for the Sync Request BO option on the Service Agreement maintenance object.
- **SA/SP Data Extract for DataConnect** (C1-ExternalRepoPlusSASPSync): used to extract service agreement service point information. This business object should be defined as a value for the Sync Request BO option on the Service Agreement maintenance object.
- **Mailing Address Data for DataConnect** (C1-ExternalRepoPlusMailAddSync): used to extract mailing address information. This business object should be defined as a value for the "Sync Request BO" options on the Person maintenance object.
- **SP/Meter Sync for DataConnect** (D1-ExternalRepositorySPMtrSync): used to extract service point and meter information. This business object should be defined as a value for the "Sync Request BO" options on the Service Point, Device Configuration, and Device maintenance objects.

- **SA/Account/Person Sync for Legacy DataConnect** (C1-ExternalRepoSASync): used to extract service agreement / account / person related information. This business object should be defined as a value for the Sync Request BO option on the Service Agreement maintenance object. (Used with v1)
- **SP Sync for Legacy DataConnect** (D1-ExternalRepositorySPSync): used to extract service point information. This business object should be defined as a value for the "Sync Request BO" options on the Service Point maintenance object. (Used with v1)
- **Install Event Sync for Legacy DataConnect** (D1-ExternalRepositoryIESync): used to extract install event information. This business object should be defined as a value for the "Sync Request BO" options on the Install Event maintenance object. (Used with v1)

These business objects use the following Pre-Processing algorithms to take initial data snapshots, and define the batch control used to extract data and export to a flat file:

- Capture Customer Data's Initial Snapshot for DataConnect(C1-CEXTRCSAD)
- Capture SA/SP Data's Initial Snapshot (C1CAPSASPI)
- Capture Mailing Address Data Initial Snapshot (C1CAPMLADDI)
- Capture SP/Meter Initial Snapshot for Legacy DataConnect (D1-SPMINISNP)
- Capture SP Initial Snapshot for Legacy DataConnect (D1-SPEINISNP)
- Capture SA-Based Initial Snapshot for Legacy DataConnect (C1-CEXTRCSAI)
- Capture Install Event Initial Snapshot for Legacy DataConnect (D1-IEEINISNP)

These algorithms specify the batch control used for the extract process (see below).

The Sync Request Monitor batch control (F1-SYNRQ) monitors synchronization requests in the Pending state and executes Monitor algorithms that check for other pending related synchronization requests, and, if none, transitions them to the Determine if Sync Needed state.

Enter algorithms on the Determine If Sync Needed states verify if a synchronization is needed by capturing the final snapshot of the data and comparing it against the initial snapshot. If changes are detected, the final snapshots of the data are stamped on the synchronization requests for export.

- Capture SA-Based Final Snapshot for DataConnect(C1-CEXTRPSAF)
- Capture SA/SP Data's Final Snapshot (C1CAPSASPF)
- Capture Mailing Address Data's Final Snapshot (C1CAPMLADDF)
- Capture SP and Meter Data's Final Snapshot for DataConnect (C1-CEXTRSPMF)
- Capture SP/Meter Final Snapshot for DataConnect (D1-SPMFINSNP)
- Capture SA-Based Final Snapshot for Legacy DataConnect (C1-CEXTRCSAF)

The Prepare Delimited Extract Data (Ignore Custom Sync Records) Enter algorithm (C1-PRPEXDNCU/C1-PRTBDEXDT) or the Prepare Delimited Extract Data Enter algorithm (D1-PRPEXTDTA) on the Send Request state prepares and formats the data for extraction, and creates a general process record for the synchronization request (based on the batch control defined by the pre-processing algorithm).

Premise Data

Extraction of premise data, including premise, service point, device installation, device, and measuring component informatiob, is supported by the following data synchronization business objects.

- **SP/Meter Sync for DataConnect** (D1-ExternalRepositorySPMtrSync): used to extract service point and device related information. This business object should be defined as a value for the Sync Request BO option on the Service Point, Device Configuration, and Device maintenance objects.

These business objects use the following Pre-Processing algorithms to take initial data snapshots, and define the batch control used to extract data and export to a flat file:

- Capture SP/Meter Initial Snapshot for Legacy DataConnect (D1-SPMINISNP)

These algorithms specify the batch control used for the extract process (see below).

The Sync Request Monitor batch control (F1-SYNRQ) monitors synchronization requests in the Pending state and executes Monitor algorithms that check for other pending related synchronization requests, and, if none, transitions them to the Determine if Sync Needed state.

Enter algorithms on the Determine If Sync Needed states verify if a synchronization is needed by capturing the final snapshot of the data and comparing it against the initial snapshot. If changes are detected, the final snapshots of the data are stamped on the synchronization requests for export.

- Capture SP/Meter Final Snapshot for DataConnect (D1-SPMFINSNP)

The Prepare Delimited Extract Data (Ignore Custom Sync Records) Enter algorithm (C1-PRPEXDNCU/C1-PRTBDEXDT) or the Prepare Delimited Extract Data Enter algorithm (D1-PRPEXTDTA) on the Send Request state prepares and formats the data for extraction, and creates a general process record for the synchronization request (based on the batch control defined by the pre-processing algorithm).

Customer and Premise Data Extracts: Batch Controls

Customer Data

The customer data extraction process uses a set of batch processes to create data synchronization requests and extract files.

The following batch processes are used to create initial synchronization requests:

- **Customer Data Initial Load for DataConnect (C1-CDTIL):** This batch control creates initial synchronization requests for account data (service agreements/accounts/persons) and SA's SP data (SA/SP). The appropriate sync business objects for the two extracts should be plugged in as parameters to the batch job.
- **Mail Address Initial Load DataConnect (C1-MADIL):** This batch control creates initial synchronization requests for accounts.
- **SA-Based Initial Load for Legacy DataConnect (C1-SAEIL):** This batch control creates initial synchronization requests for service agreements / accounts / persons.
- **SP Initial Load for Legacy DataConnect (D1-SPEIL):** This batch control creates initial synchronization requests for service points.

The following batch processes are used to create extract files from synchronization requests.

NOTE: These batch processes should be run to create initial load data synchronization requests based on the Sync for DataConnect business objects.

- **Customer Data Extract for DataConnect (C1-CUDTX):** This batch control creates extract file(s) for service agreements / accounts / persons related information.
- **SA/SP Data Extract for DataConnect (C1-SSDTX)**
- **Mailing Address Extract DataConnect (C1-MADTX):** This batch control creates extract file(s) that contain mailing address information.
- **SA-Based Extract for DataConnect (C1-CUDTX):** This batch control creates extract file(s) for service agreements / accounts / persons related information.
- **SP Extract for Legacy DataConnect (D1-SPESR):** This batch control creates extract file(s) that contain service point information.

These batch controls are defined as values for the Batch Control for Extract algorithm parameters on the Pre-Processing algorithms on the Sync for DataConnect business objects (see above).

Use the Batch Control portal for more information about these batch controls. The extract batch controls contain parameters that can be used to specify details (including path and file name for this file.) for a delimited flat file containing extracted data.

Premise Data

The premise data extraction process uses a set of batch processes to create data synchronization requests and extract files.

The following batch processes are used to create initial synchronization requests:

- **SP/Meter Initial Load for DataConnect (D1-SPMIL):** This batch control creates initial synchronization requests for service points, device configurations, and devices.
-
- **Install Event Initial Load for Legacy DataConnect (D1-IEEIL):** This batch control creates initial synchronization requests for install events.

The following batch processes are used to create extract files from synchronization requests.

NOTE: These batch processes should be run to create initial load data synchronization requests based on the Sync for DataConnect business objects.

- **SP/Meter Extract for DataConnect (D1-SPMSR):** This batch control creates extract file(s) that contain service point, device configuration, and device information.
- **Install Event Extract for Legacy DataConnect (D1-IEESR):** This batch control creates extract file(s) that contain install event information.

These batch controls are defined as values for the Batch Control for Extract algorithm parameters on the Pre-Processing algorithms on the Sync for DataConnect business objects (see above).

Use the Batch Control portal for more information about these batch controls. The extract batch controls contain parameters that can be used to specify details (including path and file name for this file.) for a delimited flat file containing extracted data.

Setting Up and Executing Customer and Premise Data Extracts

Setting up master data extracts involves the following steps:

1. Add audit algorithms on the Service Agreement, Account, Person, MDM Service Point, Install Event, and Device maintenance objects.
 - a) Add the Generic Change Data Capture algorithm as an audit algorithm on the Service Agreement, MDM Service Point, and Install Event maintenance objects.
 - b) Add the Account Change Data Capture (SA-Based) - Include Reactivated SAs algorithm as an audit algorithm on the Account maintenance object.
 - c) Add the Person Change Data Capture (SA-Based) - Include Reactivated SAs algorithm as an audit algorithm on the Person maintenance object.
 - d) Add the Device Change Data Capture (Install Event-Based) algorithm as an audit algorithm on the Device maintenance object.
2. Add the DataConnect synchronization request business objects as Sync Request BO options on the Service Agreement, Service Point and Install Event maintenance objects.
3. Execute initial load batch processes related to service agreements, service points and install events.
4. Once the initial load synchronization has been executed, changes to service agreements, accounts, persons, service points, install events or related devices will trigger the creation of new synchronization requests and resulting extraction files.

5. Execute the sync request monitor process.
6. Execute the extract batch processes related to service agreements, service points and install events.

Billing Data Extracts

When sending billing related data to an external system, both historical and current data needs to be extracted.

Historical data can be extracted as part of an initial load process, and only needs to be provided during initial setup of the integration. Historical data includes data history for all bill segments for a specified historical period that are:

- Linked to completed bills.
- Not linked to bills but are linked to frozen FTs that are linked to completed bills.

Current data should be extracted on a regular ongoing (or incremental) basis. However, in addition to sending current data, any billing corrections should be extracted as well.

Extraction of billing data is performed through use of data synchronization, post bill completion algorithms, business objects and related batch processes.

Billing Data Extracts: Business Objects and Algorithms

Billing generates synchronization requests when bills complete through a Customer Class – Post Bill Completion algorithm. The Change Data Capture of Billing Data for DataConnect (C1-CAPBILLEX) algorithm type provided in the base package can be used to create a Customer Class – Post Bill Completion algorithm that creates a billing synchronization request record for each of the bill’s bill segments if one does not exist in the initial state.

Billing related information extracts are supported by the following data synchronization business objects.

- Bill Sync for DataConnect (C1-ExternalRepoPlusBillSync)
- Bill Segment Sync for DataConnect (C1-ExternalRepoPlusBillSegSync)
- Billing Sync for Legacy DataConnect (Tab-delimited) (C1-ExternalRepoPlusBillingSync)
- Billing Sync for Legacy DataConnect (C1-ExternalRepoBillingSync)

These business objects should be defined as an algorithm parameter on the algorithm based on the Change Data Capture of Billing Data for DataConnect (C1-CAPBILLEX) algorithm type. These business object use the following Pre-Processing algorithms to take an initial data snapshot, and define the batch control used to extract data and export to a flat file. However, since billing data are always synched when it gets completed, no actual initial snapshot is taken. Instead, the parameters used for building the snapshots are taken and stored on the sync request record for later use when building the final snapshot.

Business Object	Pre-Processing Algorithm
Bill Sync for DataConnect (C1-ExternalRepoPlusBillSync)	Capture Bill Data Initial Snapshot (C1EXTCBILLI)
Bill Segment Sync for DataConnect (C1-ExternalRepoPlusBillSegSync)	Capture Bill Segment Data Initial Snapshot (C1EXTRCBSI)
Billing Sync for Legacy DataConnect (C1-ExternalRepoBillingSync)	Capture Billing Data Initial Snapshot for Legacy DataConnect (C1-EXTRCBLIP)
Billing Sync for Legacy DataConnect (Tab-delimited) (C1-ExternalRepoPlusBillingSync)	Billing Data Initial Snapshot for Legacy DataConnect (C1-EXTRCBLIP)

The Sync Request Monitor batch control (F1-SYNRQ) monitors synchronization requests in the Pending state and executes Monitor algorithms that check for pending related synchronization requests, and, if none, transitions them to the Determine if Sync Needed state.

Enter algorithms on the Determine If Sync Needed states extract a final snapshot of the data if the billing related data is to be extracted and exported. These include:

- Algorithms that check if there is a need to export the billing data. It will discard the synchronization request if one of the following is true:
 - The synchronization request is for a cancelled bill segment whose original usage has not been previously sent out.
 - The synchronization request has been marked for non-synchronization (such as, the bill segments related SA Type is not configured to be extracted on the Billing Data Configuration for DataConnect master configuration record).

Business Object	Algorithm
Billing Sync for Legacy DataConnect (Tab—delimited) (C1-ExternalRepoPlusBillingSync)	Determine if the Billing Sync is Needed (C1-DSCANUSNS)
Billing Sync for Legacy DataConnect (C1-ExternalRepoBillingSync)	Determine if the Billing Sync is Needed (C1-DSCANUSNS)

- Algorithms that capture the billing data information and stores it on the synchronization request.

Business Object	Algorithm
Bill Sync for DataConnect (C1-ExternalRepoPlusBillSync)	Capture Bill Data Final Snapshot (C1EXTCBILLF)
Bill Segment Sync for DataConnect (C1-ExternalRepoPlusBillSegSync)	Capture Bill Segment Data Final Snapshot (C1EXTRCBSF)
Billing Sync for Legacy DataConnect (C1-ExternalRepoBillingSync)	Capture Billing Data Final Snapshot for Legacy DataConnect (C1-CAPBILUSN)
Billing Sync for Legacy DataConnect (Tab-delimited) (C1-ExternalRepoPlusBillingSync)	Capture Billing Data Final Snapshot for Legacy DataConnect (C1-CAPBILUSN)

When using Legacy DataConnect, if a single extract file that combines both the billing and master data (customer and premise) information is preferred, the following algorithms can be used to capture the master data information of the bill. These algorithms should be plugged in on the Determine if Sync Needed state after the Capture Billing Data Final Snapshot for DataConnect algorithm.

- Capture Billing’s SA Final Snapshot for DataConnect (C1-CEXTRCSA) - This is the algorithm that captures the service agreement, account and person information associated with the bill.
- Capture Billing’s SP Final Snapshot for DataConnect (C1-CEXTRCSP) - This is the algorithm that captures the service point and premise information associated with the bill.
- Capture Billing’s Installation Event Final Snapshot for DataConnect (X1-CEXTRCIE). This is the algorithm that captures install event information associated with the bill.

When using DataConnect v1, the Prepare Delimited Extract Data (Process All) Enter algorithm (C1-PRPEXDCUS/C1-PRPTDEXDT) on the Send Request state prepares and formats the data for extraction, and creates a general process record for the synchronization request (based on the extract batch control defined by the pre-processing algorithm).

Billing Data Extracts: Batch Controls

The billing data extraction process uses a set of batch processes to create data synchronization requests and extract files.

Creating Initial Synchronization Requests

The following batch processes are used to create initial synchronization requests for bills:

- Bill Data Initial Load for DataConnect (C1-BLDIL)
- Bill Segment Data Initial Load for DataConnect (C1-BSDIL)
- Billing Data Initial Load for Legacy DataConnect (C1-BLEIL)

These batch processes should be run to create initial load data synchronization requests based on the sync business objects described above.

Creating Extract Files

The following batch process is used to create extract files from synchronization requests for billing related information.

- Bill Data Extract for DataConnect (C1-BLDTX)
- Bill Segment Data Extract for DataConnect (C1-BSDTX)
- Billing Data Extract for Legacy DataConnect (C1-BSYEX)

These batch controls are defined as values for the Batch Control for Extract algorithm parameters on the Pre-Processing algorithms on the sync business objects described above.

The following batch controls are used to extract bill segment lines and service quantities:

- Bill Seg Lines Extract - DataConnect (C1-BSLDX)
- Bill Segment SQ Extract - DataConnect (C1-BSSQX)

These should be run after bill segment extract has been run.

Use the **Batch Control** portal for more information about these batch controls. The extract batch controls contain parameters that can be used to specify details (including path and file name for this file) for a delimited flat file containing extracted data.

Setting Up and Executing Billing Data Extracts

Setting up billing data extracts involves the following steps:

1. Configure the Billing Data Configuration for the DataConnect master configuration record. This is used to configure the UOM, TOU, and SQI of the SA Type's service quantity and charges that will be extracted. Additionally, you can also configure the UOM, TOU and SQI at the rate level.
2. Add the Capture Bill and Bill Segment Extract for DataConnect v1+ (C1CAPBILBSEG) related post bill completion algorithm to the applicable customer classes.

If using DataConnect v1, use the Capture Billing Data for DataConnect (Comma-delimited) (C1-CAPBILLEX) algorithm.
3. Execute initial load batch processes related to billing data.
4. Once the initial load synchronization has been executed, current data should be extracted on a regular ongoing (or incremental) basis. In addition to sending current data, any billing corrections will be extracted as well (data related to bill segments not linked to bills but are linked to frozen FTs that are linked to completed bills).
5. Execute the sync request monitor process.
6. Execute the extract batch processes related to billing.

Billing Data DataConnect Master Configurations

The master configuration business objects for billing data Configuration for DataConnect define general configuration details for the DataConnect functionality.

Billing Data Configuration for Legacy DataConnect

The Billing Data Configuration for Legacy DataConnect master configuration is used to configure the UOM, TOU, and SQI of the SA Type's service quantity and charges that will be extracted. Additionally, you can also configure the UOM, TOU and SQI at the rate level.

Billing Extract Master Configuration for DataConnect

The Billing Extract Master Configuration for DataConnect master configuration is used to define the configuration used to extract billing data. This includes the extraction types, including bill and bill segment sync request business objects, as well as CIS Divisions and SA Types for each, the number of historical periods for initial load, and the calculation line's category based on the rating engine used (billing extract assumes that only one rating engine is used by the system).

Navigate using **Admin**, then **General**, then **Master Configuration**. In the Master Configuration list, scroll to the appropriate master configuration and click the add icon if there is no record yet or the edit icon to modify an existing record.

For more information about specific fields in the master configuration, refer to the embedded help.

Consumption Data Extracts

When sending interval measurement usage data to an external system, both historical and current data needs to be extracted. Historical data can be extracted as part of an initial load process, and only needs to be provided during initial setup of the integration. Historical data should include data history for all active service points for a specified historical period. Current data should be extracted on a regular ongoing (or incremental) basis. However, in addition to sending current data, any historical corrections received by the system should be extracted as well.

Extract Requests

There are several types of consumption extract requests:

- **Initial Load:** Initial load extract requests are created and submitted manually via the Consumption Extract Request portal. Consumption extract requests are based on a specified Consumption Extract Type (see below) and extraction date range. An initial load request must be created and submitted for each consumption extract type defined in the system.
- **Incremental / Ongoing (Current Data):** Incremental / ongoing extract requests can be manually created, but more often will be created via a batch process. The "Create Daily Consumption Extract Requests" batch control scans active consumption extract types and creates a request for each one that has Frequency of "Automated Daily." Ad-hoc incremental requests can be created and submitted manually if needed.
- **Historical Correction:** Historical correction extracts are created via batch process. Algorithms on the Finalized state of the initial measurement and measurement business objects determine if a finalized initial measurement or rederived values are historical corrections. These algorithms create records which are evaluated by a batch process which extracts the measurements for the related initial measurements.

Consumption Extract Type

Consumption Extract Types define the specific parameters used when processing a consumption extract request. Consumption Extract Types control the service point type, type of measurement, and how the measurements are grouped into TOU periods if applicable. Consumption extract types also define the algorithm and batch processes to use when extracting data for different types of requests (initial load, incremental, and historical).

There are two consumption extract type business objects provided with the base package:

- **Energy Management Extract (D2-ConsumptionExtractType):** This business object retrieves interval data and converts it to a specified Target UOM and Interval Size. This business object does not support TOU mapping.

- **Energy Management Extract with TOU Mapping (D2-ConsumptionExtractTypeTOU):** This business object retrieves interval data, converts it to a specified Target UOM and Interval Size, and maps it to a specific TOU map prior to extraction.

Historical Versus Current Data

The "Extract Through Date/Time" field on the Consumption Extract Type is used to differentiate between current data (the most recently extracted data) and historical corrections, and is set to the last date on which data was extracted for that extract type. For example, if data is extracted on June 1, 2015, the "Extract Through Date/Time" would be set to "June 1, 2015 12:00AM." If/when data is extracted the next day, "Extract Through Date/Time" would be updated to "June 2, 2015 12:00AM."

When evaluating data for extract:

- Interval data is considered current if its measurement date time is after the "Extract Through Date/Time".
- Interval data is considered a historical correction if its measurement date time is on or before the "Extract Through Date/Time".

Historical data changes to an initial measurement can be detected when it enters the Finalized state. If the initial measurement is determined to be for a historical period by comparing its end date/time against the "Extracted Through Date/Time" on the Consumption Extract Type, a general process record will be written for the initial measurement so that measurements for it can be extracted. In addition, re-derived values on final measurements can also trigger the creation of a general process record for related initial measurements.

The following algorithms are used in this process:

- The "Create General Process Record if IMD is Historical Correction" algorithm is used to determine if a finalized initial measurement data is a historical correction. If it is, the algorithm creates a general process record for the initial measurement. This algorithm is provided in the base package, but not specified on initial measurement business objects by default. This algorithm should be defined as an Enter algorithm on the Finalized state of the initial measurement business objects.
- The "Create General Process Record for Re-derived Values" algorithm creates general process records for initial measurements associated with re-derived values. Processing will proceed as if a historical correction came in through an initial measurement. This algorithm is provided in the base package, but not specified on measurement business object by default. This algorithm should be defined as an Enter algorithm on the Re-derive state of the final measurement business object.

Consumption Extract Requests

Initial load and ongoing consumption extracts are created via Consumption Extract Requests. While extracts of these types can be created via adhoc submission of a batch job, requests are the preferred method for these types of consumption extracts.

The consumption extract request business object lifecycle includes logic that maintains and updates the "Extraction Through Date/Time" field on Consumption Extract Types, which is used to determine if daily requests should be created by the "Create Daily Consumption Extract Requests" batch control, and detect historical corrections.

A single business object is provided in the base package for consumption extract requests:

- **Consumption Request (D2-IntervalDataExtRepository):** This business object contains the information and lifecycle responsible for submitting the extract job, monitoring the run until it's finished, and then updating the Consumption Extract Type's "Extract Through Date/Time" on the Consumption Extract Type. This business object is based on the Request (F1-REQ) maintenance object.

The consumption extract process uses a set of base package algorithms to extract and format the interval data for export. These algorithms are specified in the "Algorithms" section on the Consumption Extract Type as appropriate. These algorithms can be configured to allow for extraction of data for frequently-read scalar measuring components as well as interval measuring components. Frequently-read scalar measuring components are defined as scalar measuring components

whose Read Method is set to "Automatic Read." When extracting measurements for frequently-read scalar measuring components, scalar measurements are converted to interval measurements as part of the extraction process. This conversion uses the profile associated with the measuring component type. If no profile can be found, the interval data uses a flat line profile.

Initial Load / Incremental / Ongoing Requests: the following algorithms are used to extract and format interval data for initial load and incremental / ongoing requests:

- **Extract Initial Load/Ongoing Consumption for DataConnect (D2-IDEXTPRD):** This algorithm retrieves a service point's consumption for a given period and writes the results to a flat file.
- **Extract Tab-Delimited Initial Load/Ongoing Consumption (with UTC Offset) (D2-IDEXTPRDU):** This algorithm retrieves a service point's consumption for a given period and writes the results to a tab-delimited flat file. This algorithm also supports adjusting the consumption based on Daylight Saving Time.
- **Extract Initial/Ongoing Consumption and Apply TOU Map for DataConnect (D2-IDEXTPTOU):** This algorithm retrieves a service point's consumption for a given period, applies a TOU Map to the consumption, and writes the results to a flat file
- **Extract Tab-Delimited Initial/Ongoing Consumption and Apply TOU Map (with UTC Offset) (D2-IDEXTPTUU):** This algorithm retrieves a service point's consumption for a given period, applies a TOU Map to the consumption, and writes the results to a tab-delimited flat file. This algorithm also supports adjusting the consumption based on Daylight Saving Time.

Historical Corrections: the following algorithms are used to extract and format interval data for historical correction requests.

- **Extract Historical Correction Consumption for DataConnect (D2-IDEXTIMD):** This algorithm retrieves historical correction consumption for a service point and writes the results to a flat file.
- **Extract Tab-Delimited Historical Correction Consumption (with UTC Offset) (D2-IDEXTIMDU):** This algorithm retrieves historical correction consumption for a service point and writes the results to a tab-delimited flat file. This algorithm also supports adjusting the consumption based on Daylight Saving Time.
- **Extract Historical Corrections and Apply TOU Map for DataConnect (D2-IDEXTITOU):** This algorithm retrieves historical correction consumption for a service point, applies a TOU map to the consumption, and writes the results to a flat file.
- **Extract Tab-Delimited Historical Corrections and Apply TOU Map (with UTC Offset) (D2-IDEXTITUU):** This algorithm retrieves historical correction consumption for a service point, applies a TOU map to the consumption, and writes the results to a tab-delimited flat file. This algorithm also supports adjusting the consumption based on Daylight Saving Time.

Consumption Extract Requests - Batch Controls

The consumption extraction process uses a set of base package batch controls to extract and format the interval data for export.

- **Create Daily Consumption Extract Requests (D2-CRERQ):** This batch process scans for active Consumption Extract Types, and for each one that has Frequency of Automated Daily creates a pending request. This process should be scheduled to run daily (or at another regular interval).

The following sample batch controls are provided to extract and format interval data. Unique batch controls of each of these is required for each consumption extract type. You should create custom versions of the above batch controls for each consumption extract type in your implementation. Extract type-specific versions of these batch controls should be specified in the "Batch Control" section on the Consumption Extract Type as appropriate.

- **Initial Load/Ongoing Consumption Extract (D2-IDEPD):** This batch process extracts interval data for a specified period. This batch control uses the "Initial Load/Ongoing Extract Algorithm" defined on the Consumption Extract Type.

- **Historical Corrections Consumption Extract (D2-IDEHC):** This batch process extracts interval data for historical corrections. This batch control uses the "Historical Corrections Extract Algorithm" defined on the Consumption Extract Type.

Use the Batch Control portal for more information about these batch controls. The extract batch controls contain parameters that can be used to specify details (including path and file name for this file.) for a delimited flat file containing extracted data.

Consumption Extract Requests - Setup Steps

Example Setup Steps

Setting up consumption extracts involves the following steps:

1. Create Consumption Request Types: you should create a consumption request type for each unique type of request required by your implementation.
2. Create Consumption Extract Types: you should create a consumption extract type for each unique combination of output details (target UOM, target interval size, TOU map/template) and measurement selection criteria.
3. Add the "Create General Process Record if IMD is Historical Correction" historical correction algorithm as an Enter algorithm on the Finalized state of the initial measurement business objects.
4. Add the "Create General Process Record for Re-derived Values" historical correction algorithm as an Enter algorithm on the Finalized state on the measurement business object.
5. Create and submit initial load consumption extract requests for each consumption extract type you created earlier.
6. Set up batch processes for daily extract requests and historical corrections. Batch processing for consumption extracts should include the following:
 1. The **Create Daily Consumption Extract Requests (D2-CRERQ)** batch control should be configured to run on a regular (i.e. daily) schedule to create ongoing consumption extract requests.
 2. The **Request Monitor (Deferred) (F1-SUBRQ)** batch control should be used to monitor for pending requests and transition them to the "Submit Job" state.
 3. **Historical corrections consumption extract batch controls** (based on D2-IDEHC, one for each consumption extract type), should be configured to run on a regular basis to check for and create historical correction extracts.

Extract Flat File Formats

This section outlines the format of output flat files created by master data, billing data, and consumption data extracts.

Data Areas:

- [C1-AcctMailingAddrDataSnapshot](#)
- [C1-BillDataSnapshot](#)
- [C1-BillSegmentDataSnapshot](#)
- [C1-CustomerDataSnapshot](#)
- [C1-ExternalRepoSABasedSnapshot](#)
- [D1-ExternalRepositorySPSnapsht](#)
- [D1-ExternalRepositorySPMtrSnap](#)
- [D1-ExternalRepositoryIESnapsht](#)
- [C1-ExternalRepoBillingSnapshot](#)

- [D2-IntervalDataExtRepoSnapshot](#) (used for interval consumption extract for Legacy DataConnect)
- [D2-IntervalDataExtRepoTOUSnap](#) (used for interval consumption extract mapped to TOU periods for Legacy DataConnect)
- [D2-IntervalDataExtRepoSnpstUTC](#) (used for interval consumption extract)
- [D2-IntervalDataExtRepoTOUSnUTC](#) (used for interval consumption extract mapped to TOU periods)

Specifics for how the flat files are created are defined on batch controls and algorithms used by the extract process.

- **File Name and Path:** Parameters on batch controls define the file name, path, and other details about the output file.
- **File Size and Contents:** Batch controls for initial load/ongoing consumption requests include a parameter to specify the number of service points to be included in each file.

C1-AcctMailingAddrDataSnapshot

C1-AcctMailingAddrDataSnapshot is used for mailing address data extracts, and includes the following information:

Field Name	Schema Element	Metadata Field
Account ID	accountId	ACCOUNT_ID
Person Id	personId	PERSON_ID
Is Seasonal Address	isSeasonalAddress	
Seasonal Address Start Date/Time	seasonStart	IS_SEASONAL_ADDRESS
Seasonal Address End Date/Time	seasonEnd	SEASONAL_ADDRESS_END_DTTM
Mailing Address 1	address1	MAIL_ADDRESS_1
Mailing Address 2	address2	MAIL_ADDRESS_2
Mailing Address 3	address3	MAIL_ADDRESS_3
Mailing Address 4	address4	MAIL_ADDRESS_4
Locality	city	LOCALITY
Postal Code	postal	MAIL_POSTAL_CODE
Admin Area 1	state	ADMIN_AREA_1
Admin Area 2	adminArea2	ADMIN_AREA_2
Admin Area 3	adminArea3	ADMIN_AREA_3
Country	country	COUNTRY
Updated at	personAddressUpdatedAt	PERSON_ADDRESS_UPDATED_AT

[Top of Page](#)

C1-BillDataSnapshot

C1-BillDataSnapshot is used for the bill-based data extracts, and includes the following information:

Field Name	Schema Element	Metadata Field
Bill ID	billId	BILL_ID
Account ID	accountId	ACCOUNT_ID
Bill Date	billDate	BILL_DATE
Due Date	dueDate	DUE_DATE
Currency Code	currencyCode	CURRENCY_CD

Field Name	Schema Element	Metadata Field
Current Balance	currentBalance	CURRENT_BALANCE
Payoff Balance	payoffBalance	PAYOFF_BALANCE
Previous Period Balance	previousPeriodBalance	PREVIOUS_PERIOD_BALANCE
Total Payments	totalPayments	TOTAL_PAYMENTS
Total Adjustments	totalAdjustments	TOTAL_ADJUSTMENTS
Total Bill Corrections	totalBillCorrections	TOTAL_BILL_CORRECTIONS
Total Current Billing Charges	totalCurrentBillingCharges	TOTAL_CURRENT_BILLING_CHARGES
Total Balance Current Period	totalBalanceCurrentPeriod	TOTAL_BALANCE_CURRENT_PERIOD
Last Update Date/Time	lastUpdateDateTime	BILL_UPDATED_AT

[Top of Page](#)

C1-BillSegmentDataSnapshot

C1-BillSegmentDataSnapshot is used for the bill segment-based data extracts, and includes the following information:

Field Name	Schema Element	Metadata Field
Bill ID	billId	BILL_ID
Bill Segment ID	billSegmentId	BILL_SEGMENT_ID
Service Agreement	serviceAgreement	SERVICE_AGREEMENT_ID
Start Date	startDate	BILL_SEGMENT_START_DATE
End Date	endDate	BILL_SEGMENT_END_DATE
Usage Start Date/Time	usageStartDateTime	USAGE_PERIOD_START_DATE
Usage End Date/Time	usageEndDateTime	USAGE_PERIOD_END_DATE
Estimated	isEstimate	ESTIMATED
Closing Billing Statement	isClosingBillSegment	CLOSING
Bill Segment Status	billSegmentStatus	STATUS
Bill Cycle	billCycle	BILL_CYCLE_CODE
Bill Cycle Description	billCycleDescr	BILL_CYCLE_DESCRIPTION
Premise ID	premiseId	PREMISE_ID
Current Amount	currentAmount	CURRENT_AMOUNT
Outstanding Amount	outstandingAmount	OUTSTANDING_AMOUNT
Master Bill Segment ID	masterBillSegmentId	MASTER_BILL_SEGMENT_ID
Last Update Date/Time	lastUpdateDateTime	BILL_SEGMENT_UPDATED_AT

[Top of Page](#)

C1-CustomerDataSnapshot

C1-CustomerDataSnapshot is used for customer data extracts, and includes the following information:

Field Name	Schema Element	Metadata Field
Account ID	accountId	ACCOUNT_ID
Account Name	accountName	ACCOUNT_NAME
Account Setup Date/Time	accountSetUpDateTime	SETUP_DATETIME
Customer Class	customerClass	CUSTOMER_CLASS
Bill Cycle	billCycle	BILL_CYCLE_CODE
Bill Cycle Description	billCycleDescription	BILL_CYCLE_DESCRIPTION
Account Updated at	accountUpdatedAt	ACCOUNT_UPDATED_AT
Person ID	personId	PERSON_ID
Person Type	personOrBusiness	PERSON_TYPE
First Name	firstName	FIRST_NAME
Last Name	lastName	LAST_NAME
Business Name	businessName	BUSINESS_NAME
Language Preference	language	LANGUAGE_PREFERENCE
Is Main Customer	isMainCustomer	IS_MAIN_CUSTOMER
Bill Route Type	billRouteType	BILL_ROUTE_TYPE
Person Updated at	personUpdatedAt	PERSON_UPDATED_AT
Phone Type	phoneType	PHONE_TYPE_
Phone Number	phoneNumber	PHONE_NUMBER_
Phone Extension	phoneExtension	PHONE_EXTENSION_
Email	email	EMAIL_ADDRESS_
Email Type	emailType	EMAIL_TYPE_
Service Agreement ID	sald	SERVICE_AGREEMENT_ID
Service Agreement Name	saName	SERVICE_AGREEMENT_NAME
Start Date/Time	startDateTime	SA_START_DATETIME
End Date/Time	endDateTime	SA_END_DATETIME
Service Type	serviceType	SERVICE_TYPE_CODE
Service Type Description	serviceTypeDescription	SERVICE_TYPE_DESC
SA Status	saStatus	STATUS_CODE
SA Status Description	saStatusDescription	STATUS_DESCRIPTION
SA Type	saType	SERVICE_AGREEMENT_TYPE_CODE
SA Type Description	saTypeDescription	SA_TYPE_DESCRIPTION
Special Role Flag	specialRole	SPECIAL_ROLE_FLAG_CODE
Special Role Flag Description	specialRoleDescription	SPECIAL_ROLE_FLAG_DESCRIPTION
CIS Division	cisDivision	CIS_DIVISION
SIC	sic	BUSINESS_CLASSIFICATION_CODE
SA Updated at	saUpdatedAt	SERVICE_AGREEMENT_UPDATED_AT
SA Rate Code	saRateCode	SA_RATE_CODE
SA Rate Effective Date/Time	saRateEffectiveDateTime	EFFECTIVE_DATETIME

Field Name	Schema Element	Metadata Field
SA Rate Updated at	saRateUpdatedAt	SA_RATE_UPDATED_AT

[Top of Page](#)

C1-ExternalRepoSABasedSnapshot

C1-ExternalRepoSABasedSnapshot is used for the service agreement-based master data extracts, and includes the following information:

For DataConnect v1+ please refer to data area C1-CustomerDataSnapshot in the application for the layout/schema.

Field Name	Schema Element	Metadata Field
Service Agreement Id	sald	SA_ID
Account Id	accountId	ACCT_ID
Person Id	personId	PER_ID
Bill Cycle	billCycle	BILL_CYC_CD
Bill Cycle Description	billCycleDescription	DESCR
Collection Class	collectionClass	COLL_CL_CD
Collection Class Description	collectionClassDescription	DESCR
Account Information	accountInformation	ACCT_INFO
Customer Class	customerClass	CUST_CL_CD
Customer Class Description	customerClassDescription	DESCR
Landlord Indicator	landlordIndicator	C1_LANDLORD_IND
Mailing Address	mailingAddress1	ADDRESS1
Mailing Address 2	mailingAddress2	ADDRESS2
Mailing Address 3	mailingAddress3	ADDRESS3
Mailing City	mailingCity	CITY
Mailing State	mailingState	STATE
Mailing Postal	mailingPostal	POSTAL
First Name	firstName	ENTITY_NAME
Last Name	lastName	ENTITY_NAME
Phone Number 1	phone1	PHONE
Phone Number 2	phone2	PHONE
Email Address	email	EMAILID
Special Role	specialRole	SPECIAL_ROLE_FLG
Special Role Description	specialRoleDescription	DESCR
Service Type	serviceType	SVC_TYPE_CD
Service Type Description	serviceTypeDescription	DESCR
CIS Division	cisDivision	CIS_DIVISION
CIS Division Description	cisDivisionDescription	DESCR
SA Type	saType	SA_TYPE_CD
SA Type Description	saTypeDescription	DESCR

Field Name	Schema Element	Metadata Field
Revenue Class	revenueClass	REV_CL_CD
Revenue Class Description	revenueClassDescription	DESCR
SIC	sic	SIC_CD
SIC Code Description	sicDescription	DESCR
Deposit Class	depositClass	DEP_CL_CD
Deposit Class Description	depositClassDescription	DESCR
Campaign	campaign	CAMPAIGN_CD
Campaign Description	campaignDescription	DESCR
Debt Class	debtClass	DEBT_CL_CD
Debt Class Description	debtClassDescription	DESCR
SA Start Date	startDate	START_DT
SA End Date	endDate	END_DT
SA Status	saStatus	SA_STATUS_FLG
SA Status Description	saStatusDescription	DESCR
Rate Schedule	rateSchedule	RS_CD
Rate Schedule Description	rateScheduleDescription	DESCR
SA's Service Point(s) Id	spId	SP_ID
SA's Service Point(s) Start Date/Time	startDateTime	START_DTTM
SA's Service Point(s) End Date/Time	stopDateTime	STOP_DTTM

[Top of Page](#)

D1-ExternalRepositorySPSNapsht

D1-ExternalRepositorySPSNapsht is used for service point-based master data extracts, and includes the following information:

Field Name	Schema Element	Metadata Field
Service Point ID	spId	D1_SP_ID
CIS Service Point ID	cisSpId	CIS_EXT_SP_ID
Address	address1	DESCR254
City	city	CITY
State	state	STATE
Postal	postal	POSTAL
Service Point Type Code	spType	D1_SP_TYPE_CD
Service Point Type Description	spTypeDescription	DESCR100
Service Type Code	serviceType	D1_SVC_TYPE_CD
Service Type Description	serviceTypeDescription	DESCR100
Market Code	market	MKT_CD
Market Description	marketDescription	DESCR100
Service Point Status Code	boStatus	BO_STATUS_CD

Field Name	Schema Element	Metadata Field
Service Point Status Description	boStatusDescription	DESCR100
Disconnect Location Flag	disconnectLocation	DISCONN_LOC_FLG
Disconnect Location Description	disconnectLocationDescription	DESCR100
Measurement Cycle Code	measurementCycle	MSRMT_CYC_CD
Measurement Cycle Description	measurementCycleDescription	DESCR100
Measurement Cycle Route Code	measurementCycleRoute	MSRMT_CYC_RTE_CD
Measurement Cycle Route Description	measurementCycleRouteDescription	DESCR100
Geocode Latitude	geocodeLatitude	D1_GEO_LAT
Geocode Longitude	geocodeLongitude	D1_GEO_LONG
Facility Level 1	facilityLevel1	FACILITY_LEVEL1
Facility Level 2	facilityLevel2	FACILITY_LEVEL2
Facility Level 13	facilityLevel3	FACILITY_LEVEL3

[Top of Page](#)

D1–ExternalRepositorySPMtrSnap

D1-ExternalRepositorySPMtrSnap is used for service points, device configurations, and devices master data extracts, and includes the following information:

Field Name	Schema Element	Metadata Field
Premise ID	premiseId	D1_PREMISE_ID
Premise Name	premiseName	PREMISE_NAME_LBL
External Premise ID	externalPremiseId	D1_SP_EXT_PREMISE_ID
Parent Premise ID	parentPremiseId	D1_PREMISE_ID
Premise Type	premiseType	D1_PREMISE_TYPE
Premise Type Description	premiseTypeDescription	PREMISE_TYPE_DESCR_LBL
Address 1	address1	SP_ADDRESS1_LBL
Address 2	address2	SP_ADDRESS2_LBL
Address 3	address3	SP_ADDRESS3_LBL
Address 4	address4	SP_ADDRESS4_LBL
City	city	CITY
County	county	DESCR50
Postal	postal	POSTAL
State	state	STATE
Country	country	COUNTRY
Admin Area 3	adminArea3	D1_ADMIN_AREA_3
Division	division	DIVISION_CD
Premise Time Zone	premiseTimeZone	PREMISE_TIME_ZONE_CD
Geocode Latitude	geocodeLatitude	D1_GEO_LAT
Geocode Longitude	geocodeLongitude	D1_GEO_LONG

Field Name	Schema Element	Metadata Field
Landlord Agreement	landlordAgreementId	D1_LL_ID
Premise Updated At	premiseUpdatedAt	D1_PREMISE_UPDATED_AT
Service Point ID	spId	D1_SP_ID
Service Point Name	spName	SP_NAME_LBL
SP Type Description	spTypeDescription	SP_TYPE_DESCR_LBL
Service Point Type Category	spTypeCategory	SP_CATEGORY_FLG
SP Type	spType	D1_SP_TYPE_CD
Most Recent SA ID	mostRecentSAId	US_ID
Service Agreement Start Date/Time	SASStartDateTime	START_DTTM
Service Agreement Stop Date/Time	SASStopDateTime	D2_STOP_DTTM
Measurement Cycle	measurementCycle	MSRMT_CYC_CD
Measurement Cycle Description	measurementCycleDescription	MSRMT_CYCLE_DESCR_LBL
Measurement Cycle Route	measurementCycleRoute	MSRMT_CYC_RTE_CD
Measurement Cycle Route Description	measurementCycleRouteDescription	MSRMT_CYCLE_RT_DESCR_LBL
Facility Level 1	facilityLevel1	FACILITY_LEVEL1
Facility Level 2	facilityLevel2	FACILITY_LEVEL2
Facility Level 3	facilityLevel3	FACILITY_LEVEL3
Life Support / Sensitive Load	lifeSupportSensitiveLoad	D1_LS_SL_FLG
UTC Offset	utcOffset	UTC_OFFSET
Business Object Status	boStatus	SP_BO_STATUS_LBL
Business Object Status Description	boStatusDescription	SP_BO_STATUS_DESCR_LBL
Service Source Status	spSourceStatus	SP_SRC_STAT_FLG
Service Source Status Description	spSourceStatusDescription	SP_SOURCE_STATUS_DESCR_LBL
Disconnect Location	disconnectLocation	DISCONN_LOC_FLG
Disconnect Location Description	disconnectLocationDescription	DISCON_LOC_DESCR_LBL
Service Point Time Zone	spTimeZone	SP_TIME_ZONE_CD
Service Type	erviceType	D1_SVC_TYPE_CD
Service Type Description	serviceTypeDescription	SERVICE_TYPE_DESCR_LBL
Disconnect for NonPay	disconnectForNonPay	D1_DISCONNECT_NON_PAY
Service Point Type Category Description	spTypeCategoryDescription	SP_TYPE_CAT_DESCR_LBL
Remote Disconnect	remoteDisconnect	D1_SGG_DISC_CFG
Install Event ID	installEventId	INSTALL_EVT_ID
Install Event External ID	deviceInstallationExternalId	D1_DVC_INSTALL_EXT_ID
Meter ID	meterId	D1_DEVICE_ID
Meter Name	meterName	D1_DEVICE_NAME
Install Date/Time	installDateTime	D1_INSTALL_DTTM
Removal Date/Time	removalDateTime	D1_REMOVAL_DTTM
Installation Event BO Status	installationBoStatus	IE_BO_STATUS_LBL

Field Name	Schema Element	Metadata Field
Installation Event BO Status Description	installationBoStatusDescription	IE_BO_STATUS_DESCR_LBL
Arming Status	armingStatus	ARMING_REQ_FLG
Device On/Off Status	deviceOnOffStatus	ONOFF_HIST_FLG
Installation Constant	installationConstant	INSTALLATION_CONST
Meter External ID	meterExternalId	D1_DVC_EXTERNAL_ID
Device Type	deviceType	DEVICE_TYPE_CD
Device Type Description	deviceTypeDescription	DEVICE_TYPE_DESCR_LBL
Manufacturer	manufacturer	MANUFACTURER_CD
Manufacturer Description	manufacturerDescription	MANUFACTURER_DESCR_LBL
Model	model	D1_MODEL_CD
Model Description	modelDescription	MODEL_DESCR_LBL
Device Manufacture Date	deviceManufactureDate	D1_DEVICE_MANUFACTURE_DATE
Dial Count	dialCount	D1_DIAL_COUNT
Sub Meter	subMeter	SUB_METER_SW
Net Meter	netMeter	NET_METER_SW
Device Business Object Status	deviceBoStatus	DEVICE_BO_STATUS_LBL
Device BO Status Description	deviceBoStatusDescription	DVC_BO_STATUS_DESCR_LBL
Device Service Type	deviceServiceType	DEVICE_SERVICE_TYPE_LBL
Device Service Type Description	deviceServiceTypeDescription	DEVICE_SERVICE_TYPE_DESCR_LBL
Head End System	headEndSystem	D1_SPR_CD
Head End System Description	headEndSystemDescription	HEAD_END_SYSTEM_DESCR_LBL
Head End Registration Status	headEndRegistrationStatus	HEAD_END_REGISTR_STATUS_FLG
Device Classification	deviceClassification	DVC_CLASS_FLG
Measuring Component ID	measuringComponentId	MEASR_COMP_ID
External ID	externalId	D1_MC_EXTERNAL_ID
Channel ID	channelId	CHANNEL_ID
Number of Digits Left	numberOfDigitsLeft	D1_NBR_OF_DGTS_LFT
Number of Digits Right	numberOfDigitsRight	D1_NBR_OF_DGTS_RGT
Channel Multiplier	channelMultiplier	CHANNEL_MULTIPLIER
Measuring Component Type	measuringComponentType	MEASR_COMP_TYPE_CD
Measuring Component Type Description	measuringComponentTypeDescription	MC_TYPE_DESCR_LBL
Measuring Component Class	measuringComponentClass	MC_CLASS_FLG
Seconds per Interval (SPI)	secondsPerInterval	SEC_PER_INTRVL
Interval/Scalar	intervalScalar	INTERVAL_SCALAR_FLG
UOM	uom	UNIT_OF_MEASR_CD
TOU	tou	TIME_OF_USE_CD
SQI	sqi	SVC_QTY_IDNTRF_CD
Allow Negative Consumption	allowNegativeConsumption	ALLOW_NEG_CONSUMPTION_FLG

Field Name	Schema Element	Metadata Field
CIS Service Point ID	cisSPId	CSI_EXT_SP_ID

[Top of Page](#)

D1-ExternalRepositoryIESnapsht

D1-ExternalRepositoryIESnapsht used for install event-based master data extracts, and includes the following information:

Field Name	Schema Element	Metadata Field
Service Point ID	spld	D1_SP_ID
CIS Service Point ID	cisSpld	CIS_EXT_SP_ID
Meter ID	meterId	D1_DEVICE_ID
Device Type Code	deviceType	DEVICE_TYPE_CD
Device Type Description	deviceTypeDescription	DESCR100
Device Status Code	deviceBoStatus	BO_STATUS_CD
Device Status Description	deviceBoStatusDescription	DESCR100
Manufacturer Code	manufacturer	MANUFACTURER_CD
Manufacturer Description	manufacturerDescription	DESCR100
Model Code	model	D1_MODEL_CD
Model Description	modelDescription	DESCR100
Head-End System Code	headEndSystem	D1_SPR_CD
Head-End System Description	headEndSystemDescription	DESCR100
Badge Number	badgeNumber	D1_BADGE_NBR
Serial Number	serialNumber	D1_SERIAL_NBR
CIS Meter ID	cisMeterId	CIS_EXT_DEVICE_ID
Install Date/Time	installDateTime	D1_INSTALL_DTTM
Install Date/Time with UTC Offset	installDtmUtcOffset	D1_INSTALL_DTTM_UTC_O
Removal Date/Time	removalDateTime	D1_REMOVAL_DTTM
Removal Date/Time with UTC Offset	removalDtmUtdOffset	D1_REMOVAL_DTTM_UTC_

[Top of Page](#)

C1-ExternalRepoBillingSnapshot

C1-ExternalRepoBillingSnapshot is used for the billing-based extracts, and includes the following information:

Field Name	Schema Element	Metadata Field
Billable Service Quantity	billSQ	BILL_SQ
Bill Segment End Date	endDate	END_DT
Consumption Days	duration	CONSUMPTION_DAYS
Bill Segment Estimate Indicator	estimateIndicator	C1_BS_ESTIMATE_IND
Calculated Amount	calculatedAmount	CALC_AMT

Field Name	Schema Element	Metadata Field
Unit of Measure	uom	UOM_CD
Time of Use	tou	TOU_CD
SQI	sqi	SQI_CD
Service Agreement ID	sald	SA_ID
Service Point ID	spId	SP_ID

[Top of Page](#)

D2-IntervalDataExtRepoSnapshot

D2-IntervalDataExtRepoSnapshot is used for interval-based consumption data extracts for Legacy DataConnect, and includes the following information:

Field Name	Schema Element	Metadata Field
CIS Service Agreement ID	cisSAId	CIS_EXT_SA_ID
Service Point ID	spId	D1_SP_ID
CIS Service Point ID	cisSPId	CIS_EXT_SP_ID
Unit of Measure	uom	D1_UOM_CD
Service Quantity Identifier	sqi	SVC_QTY_IDNTR_CD
Seconds Per Interval	secondsPerInterval	SECONDS_PER_INTERVAL
Measurement Value	measurementValue	MSRMT_VAL
Measurement Date	measurementDate	MSRMT_DATE
Measurement Time	measurementTime	MSRMT_TIME
Estimate Indicator	estimateIndicator	ESTIMATION_IND_FLG
Estimate Indicator Description	estimateIndicatorDescription	DESCR100
UTC Offset	utcOffset	UTC_OFFSET

[Top of Page](#)

D2-IntervalDataExtRepoTOUSnap

D2-IntervalDataExtRepoTOUSnap is used for interval consumption data extracts mapped to TOU periods for Legacy DataConnect, and includes the following information:

Field Name	Schema Element	Metadata Field
CIS Service Agreement ID	cisSAId	CIS_EXT_SA_ID
Service Point ID	spId	D1_SP_ID
CIS Service Point ID	cisSPId	CIS_EXT_SP_ID
Unit of Measure	uom	D1_UOM_CD
Time of Use Period	tou	D1_TOU_CD
Service Quantity Identifier	sqi	SVC_QTY_IDNTR_CD
Seconds Per Interval	secondsPerInterval	SECONDS_PER_INTERVAL
Measurement Value	measurementValue	MSRMT_VAL

Field Name	Schema Element	Metadata Field
Start Date	startDate	START_DT
Start Time	startTime	START_TM
Start Time UTC Offset	startUtcOffset	UTC_OFFSET
End Date	endDate	END_DT
End Time	endTime	D2_END_TIME
End UTC Offset	endUtcOffset	UTC_OFFSET

[Top of Page](#)

D2-IntervalDataExtRepoSnpstUTC

D2-IntervalDataExtRepoSnpstUTC is used for interval-based consumption data extracts, and includes the following information:

Field Name	Schema Element	Metadata Field
Service Point ID	spId	D1_¿SP_¿ID
Measurement Value	measurementValue	MSRMT_¿VAL
Measurement Date	measurementDate	MSRMT_¿DATE
Measurement Time	measurementTime	MSRMT_¿TIME
Unit of Measure	uom	D1_¿UOM_¿CD
Estimate Indicator	estimateIndicator	ESTIMATION_¿IND_¿FLG
UTC Offset	utcOffset	UTC_¿OFFSET
Register ID	mclId	REGISTER_ID
CIS Service Point ID	cisSPId	CIS_¿EXT_¿SP_¿ID
Device ID	deviceId	D1_DEVICE_ID
Service Type	serviceType	D1_SVC_TYPE_CD
Service Quantity Identifier	sqi	SVC_¿QTY_¿IDNTFR_¿CD
Time of Use	tou	D1_TOU_CD

[Top of Page](#)

D2-IntervalDataExtRepoTOUSnUTC

D2-IntervalDataExtRepoTOUSnUTC is used for interval consumption data extracts mapped to TOU periods, and includes the following information:

Field Name	Schema Element	Metadata Field
Service Point ID	spId	D1_¿SP_¿ID
Unit of Measure	uom	UNIT
Seconds Per Interval	secondsPerInterval	SECONDS_¿PER_¿INTERVAL
Measurement Value	measurementValue	MSRMT_¿VAL
Start Date	startDate	START_¿DT
Start Time	startTime	START_¿TM

Field Name	Schema Element	Metadata Field
Start Time UTC Offset	startUtcOffset	UTC_¿OFFSET
End Date	endDate	END_¿DT
End Time	endTime	D2_¿END_¿TIME
End UTC Offset	endUtcOffset	UTC_¿OFFSET
Register ID	mcld	REGISTER_ID
CIS Service Point ID	cisSPId	CIS_¿EXT_¿SP_¿ID
Device ID	deviceId	D1_DEVICE_ID
Service Type	serviceType	D1_SVC_TYPE_CD
Service Quantity Identifier	sqi	SVC_¿QTY_¿IDNTFR_¿CD
Time of Use	tou	D1_TOU_CD

[Top of Page](#)

Example Extract File

The following example illustrates comma-separated interval data extracts based on the Consumption Extract Snapshot () data area:

```
19502793-60E-KMUS,714532246966,19502793-60E-KMSP,KWH, ,3,600,1.366,2015-01-01,07.00.00,No
19502793-60E-KMUS,714532246966,19502793-60E-KMSP,KWH, ,3,600,1.366,2015-01-01,08.00.00,No
19502793-60E-KMUS,714532246966,19502793-60E-KMSP,KWH, ,3,600,1.366,2015-01-01,09.00.00,No
19502793-60E-KMUS,714532246966,19502793-60E-KMSP,KWH, ,3,600,1.366,2015-01-01,10.00.00,No
19502793-60E-KMUS,714532246966,19502793-60E-KMSP,KWH, ,3,600,1.366,2015-01-01,11.00.00,No
19502793-60E-KMUS,714532246966,19502793-60E-KMSP,KWH, ,3,600,1.366,2015-01-01,12.00.00,No
19502793-60E-KMUS,714532246966,19502793-60E-KMSP,KWH, ,3,600,1.366,2015-01-01,13.00.00,No
```

Business Flags

It is possible that information detected in one product may be useful or even critical to share with another product. The framework provides functionality for receiving information from an external system that acts as a type of flag or alert that may need investigation. This allows any system to store detected business flags in a common way and share that information with one or more other systems. See [Business Flags](#) for more information.

This section provides further information about business flags and their use in the system.

Understanding Business Flags

This product has implemented business flags that represent situations that exist at a customer's service point that are shared across external applications; such as, Oracle DataRaker and Oracle Utilities Customer Care and Billing. The situations that a business flag can represent ranges from critical knowledge that requires manual analysis for resolution to purely informational notifications.

This sharing of information allows users of each system to quickly understand the status of a service point as it relates to situations that users of the system would benefit from. For example, the analytics system (Oracle DataRaker) may identify potential theft situations that should be investigated prior to sending any usage transactions.

The subsequent sections describe business flag functionality that is specific to the service point business flag as implemented by this product.

When creating a new device type there are the following options:

Name	Details	Business Object
------	---------	-----------------

Service Point Business Flag Type	Provides configuration for business flags associated to a service point. This type offers an ability to hold a business flag for manual analysis.	D1-SPBusinessFlagType
Service Point Monitor Business Flag Type	Provides configuration for business flags that should initiate service issue monitors and convey results of a field activity to the intended subscribers.	D1-SPMonitorBusinessFlagType

Refer to [About Business Flags](#) in the *Oracle Utilities Framework Administration User Guide* for detailed information about the components of business flags.

Important Business Flag Business Object Options

Below are a list of business object options that are defined on the business flag business object associated to a given business flag type:

- **Valid Action:** identifies a BPA script that can be used to guide the user through an action that can be taken on a business flag. Note: this option should be paired with a business object lifecycle option of "Execution of Valid Actions Permitted" with a value of "true" for any lifecycle status that should support the execution of valid actions.

More detail about these options can be found by visiting a measuring component business object and inspecting the business object options.

Field Activities can Determine Business Flag Confidence

When a business flag results in a field activity being issued and a field team is sent to investigate the service point the result of that field activity investigation will determine the confidence of the business flag. This is done through the field remarks left by the field team. The field activity remarks can either be defined as confirming the business flag or rejecting it. By selecting the appropriate field activity remark the field team will conclude the investigation into the business flag and the final confidence will be updated as appropriate.

For those field activity remarks that should either confirm or reject the business flag the Business Flag Confidence Update algorithm type should be provided for the field activity remark - activation plug-in spot.

Refer to algorithm type **Assign Business Flag Final Confidence** (D1-ABFFC) for additional details.

Business Flag Available Actions

Allowed actions are implemented as BPA scripts that will guide the user through a particular method of investigating or resolving the business flag. The following actions are supported:

- **Create Field Activity:** This will initiate a field activity associated to the business flag's service point. The type of field activity will be selected by the user.
- **Create Case:** This will initiate a case associated to the business flag's service point. The type of case will be selected by the user.
- **Create Notification:** This will initiate communication with the customer for the business flag's service point. The type of communication will be determined by the notification type selected by the user.
- **Create Service Issue Monitor:** This will initiate a Service Issue Monitor (SIM) process associated to the business flag's service point. The SIM type is identified on the Business Flag Type configuration. If there are already existing SIM records of this type for the service point, the most recent SIM process will be linked to the business flag.

Business Flag Adding Available Actions

To extend the actions that are available to the user for investigating a business flag the following steps can be taken:

1. A new BPA script should be developed that provides the functionality for your particular business use case.

2. That BPA script will be added to the transactional business object for the business flag using the option type “Valid Action”.
3. Edit the business flag type to include the newly created action in the “Allowed Actions” section of the business flag type.

Making Allowed Actions Available

Allowed actions are only accessible on those business object statuses that have been configured to support them. To permit access to the available actions on a given status one must add a business object status option for the type “Execution of Valid Actions Permitted” with a value of “Y”.

Business Flag Can Prevent Bills from Freezing

Some business flags, particularly those that require investigation, should place a hold on the billing process to prevent potentially incorrect bills from being issued to the customer. When certain types of business flags are present on a service point it indicates that there may be a problem with the reported usage that is underlying the bill and as such it may not be desirable to allow the billing process to complete until the investigation into that usage has been completed. For example, if the business flag indicated potential theft or abnormally high usage it may be preferable to delay issuing the bill until an investigation can be performed and the issue rejected or resolved.

This functionality can be enabled through configuration of the Prevent Bill Segment Freeze Due to Business Flag algorithm.

See algorithm type Prevent Bill Segment Freeze Due to Business Flag (C1-PRVBSFBB) for more detail.

In MDM, Usage Transactions can also be prevented by configuring the *Valid Business Processes for Hold with Usage Processing* on the Service Point Business Flag Type.

Field Activities Can Determine Business Flag Confidence

When a business flag results in a field activity being issued and a field team is sent to investigate the service point the result of that field activity investigation will determine the confidence of the business flag. This is done through the field remarks left by the field team. The field activity remarks can either be defined as confirming the business flag or rejecting it. By selecting the appropriate field activity remark the field team will conclude the investigation into the business flag and the final confidence will be updated as appropriate.

For those field activity remarks that should either confirm or reject the business flag the Business Flag Confidence Update algorithm type should be provided for the field activity remark - activation plug-in spot.

Refer to the **Assign Business Flag Final Confidence** (D1-ABFFC) algorithm type for additional details.

Configuring Business Flags

For information on configuring business flags, see [Setting Up Business Flag Configuration](#) in the Oracle Utilities Application Framework *Administrative User Guide*.

Business Flags Can Require Analysis

For more serious situations a business flag can require manual analysis from a user. These types of business flags will generate a To Do when they are received from the external application. To resolve the To Do a user will investigate the service point based on the type of business flag present. Generally this investigation will result in the business flag being either confirmed or rejected. To reach the conclusion of whether the business flag should be confirmed or denied the user can be provided with a set of available actions that can be performed on the business flag.

See C1-BFANL for more information.

Configuring Business Flag Integration

Oracle Utilities Meter Data Management includes the following components used when integrating with Oracle Utilities Analytics Insights:

Master Configuration

The following master configurations are used to configure the sync process between MDM and Oracle Utilities Analytics Insights:

Master Configuration	Description
Oracle Utilities DataRaker Integration Master Configuration	This master configuration is used to enable deep linking into Oracle Utilities Analytics Insights. Multiple URL patterns are supported with an ability to provide substitution variables to satisfy the URL parameters (e.g. "&searchTech="). This also provides a mapping between Oracle Utilities Meter Data Management service types and the Oracle Utilities Analytics Insights point types.

Service Provider Processing Methods

The following processing methods should be associated to the service provider configured for Oracle DataRaker:

Processing Role	Description
Business Flag Confidence Change	This role will identify the appropriate message to send when a business flag confidence has been changed (e.g. from Suspected to Confirmed). When not configured no message will be sent.
Business Flag Discarded Notification	This role will identify the appropriate message to send when a business flag has been discarded. When not configured no message will be sent.
Business Flag Field Work Details	This role will identify the appropriate message to send when a business flag has completed that initiated field work. When not configured no message will be sent.
Business Flag Added Notification	This role will identify the appropriate message to send when a business flag has been created from within Oracle Utilities Meter Data Management. When not configured no message will be sent.

Extendable Lookups

The following extendable lookups should be reviewed for Oracle DataRaker:

Extendable Lookup	Description
Business Flag Standard Name	If Oracle DataRaker will be communicating business flags using a non-standard name provide an entry in the Valid External Name with the non-standard name for each standard name communicated by Oracle DataRaker.

A Field Activity Can Determine Business Flag Confidence

When a business flag results in a field activity being issued and a field team is sent to investigate the service point the result of that field activity investigation will drive the resolution of the business flag. This is done through the field remarks left by the field team. The field activity remarks can either be defined as confirming the business flag or rejecting it. By selecting the appropriate field activity remark the field team will conclude the investigation into the business flag and the final confidence will be updated as appropriate.

For those field activity remarks that should either confirm or reject the business flag the Business Flag Confidence Update algorithm type should be provided for the field activity remark – activation plug-in spot.

Please refer to algorithm type Business Flag Confidence Update (C1-BSFLGCFUP) for more detail.

Business Flags Can Create Alerts

Some business flags have a high enough importance that they should be highlighted to any user that is viewing data for the service point the business flag is related to. Whether a business flag should create an alert is controlled on the business flag type. Furthermore, the appropriate algorithm must be configured in the “Installation Options – Framework” “Algorithms” page for the “Control Central Alert” system event.

The product delivers the algorithm type “Highlight Open Business Flags”

Please refer to algorithm type *Business Flag Confidence Update (C1-BSFLGCFUP)* for more detail.

Customer Relationship Management Integration

Oracle Utilities Customer Care and Billing provides tools to facilitate the integration with customer relationship management applications such as Oracle Social Relationship Management (SRM).

The following sections describe this functionality.

About Customer Relationship Requests

A customer relationship request is used to process requests that are initiated from an external customer relationship management system.

The following sections highlight customer relationship request functionality.

Social Relationship Management Requests

Oracle Social Relationship Management (SRM) is an example of an external system that can initiate customer relationship requests.

Social network posts cover a vast range of topics, a number of which could be related to the users' concerns with their utility service. For example:

- A Facebook user could post on a community page about a power outage in a specific area.
- A Twitter user might post about specific problems with their utility service (*e.g.*, high bill complaints).

Social conversations of this nature can be monitored and managed via Oracle SRM. Oracle SRM's Engage module allows its users to see all social conversations, identify customer-specific issues and route the messages to the appropriate systems/channels.

Requests from social relationship management systems typically include:

- Information about the original posting on the social network/community (*e.g.*, author's identifier, link to the post, etc.).
- Information about the posting within the social relationship management system (*e.g.*, the user that sent the request to the utility, link to the post, etc.).
- Additional details that will help with processing/resolution (*e.g.*, customer/account numbers, address, bill IDs, etc.).

Creating Customer Relationship Requests

Most customer relationship requests will be initiated from an external system.

The base product provides an Add Customer Relationship Request (C1-AddCustRR) inbound web service that can be used in a customer relationship management integration to create customer relationship request records. This inbound web service invokes a processing script that is configured in Customer Relationship Integration master configuration. The base product supplies an example of this processing script. It maps the inbound service's input data into the customer relationship request record. Refer to the C1-CreCustRR service script system data for processing details.

Setting Up Customer Relationship Request Configuration

The following topics highlight the general configuration steps required to use customer relationship request functionality and to integrate with a customer relationship management application such as Oracle Social Relationship Management (SRM).

Customer Relationship Management Integration Configuration

The integration with a customer relationship management application such as Oracle Social Relationship Management (SRM) requires the setup of master configuration data that controls the processing of your customer relationship requests.

To set up customer relationship integration master configuration, navigate using **Admin > General > Master Configuration**. You are brought to an all-in-one portal with options to add/edit the Customer Relationship Integration master configuration record. Refer to the embedded help for more details on how each section in this record is configured.

Defining Customer Relationship Request Types

A customer relationship request type defines properties that control how a customer relationship request is processed.

Refer to [About Customer Relationship Requests](#) for an overview of customer relationship request functionality.

To maintain customer relationship request types, open **Admin > Integration > Customer Relationship Request Type > Search**.

This is a standard [All-In-One Portal](#).

The information captured on the customer relationship request type depends on the business objects supported by your implementation. Refer to the embedded help text for more information.

Maintaining Customer Relationship Requests

This section describes the functionality supported for viewing and maintaining customer relationship requests.

Refer to [About Customer Relationship Requests](#) for an overview of customer relationship request functionality.

Navigate using **Menu > Integration > Customer Relationship Request > Search**. You are brought to a query portal with options for searching for customer relationship requests.

Once a customer relationship request record has been selected, you are brought to the maintenance portal to view and maintain the selected record.

The **Customer Relationship Request** zone provides basic information about a customer relationship request. Refer to the embedded help for more information.

The **Notes** zone allows users to capture additional notes to the customer relationship request.

RightNow Knowledge Integration

Oracle Utilities Customer Care and Billing provides an integration with Oracle RightNow Knowledge that allows users to view frequently asked questions about business processes/functions that relate to the portal or page that they are currently viewing and/or working on.

The following sections describe this functionality.

Displaying Frequently Asked Questions

The Oracle RightNow Knowledge application can be used to develop content for frequently asked questions about business processes. It also functions within the Oracle Customer Care and Billing application. The RightNow KnowledgeSyndication widget defines the interface for the retrieval of this content.

The Oracle Customer Care and Billing application provides a **Frequently Asked Questions** dashboard zone that uses the RightNow KnowledgeSyndication widget to retrieve content from a RightNow Knowledge base instance. This zone is context-sensitive.

Configuration data controls how information is displayed in the **Frequently Asked Questions** dashboard zone. Refer to [RightNow Knowledge Integration Configuration](#) for more details.

RightNow Knowledge Integration Configuration

The integration with Oracle RightNow Knowledge requires the setup of master configuration data that controls how content from the RightNow Knowledge base is retrieved and presented on the **Frequently Asked Questions** dashboard zone. This configuration includes the following settings:

- The URL of the RightNow Knowledge base instance.
- The list of portals and pages for which the **Frequently Asked Questions** dashboard zone will display.
- Settings for each portal / page:
 - Search terms to pass to the RightNow KnowledgeSyndication widget. The base product supplies a number of common search term types. Implementation-specific search term types can be added.
 - Number of results/answers to display in the **Frequently Asked Questions** dashboard zone.

To set up the RightNow Knowledge Integration master configuration, navigate using **Admin > General > Master Configuration**. You are brought to an all-in-one portal with options to add/edit the RightNow Knowledge Integration master configuration record. Refer to the embedded help for more details on how each section in this record is configured.

External Applications

Understanding External Applications

External applications are applications and systems that are external to the Oracle Utilities meter data products, and can include customer information systems, outage management systems, or other types of applications.

External system service providers utilize processing methods to specify how the system sends and creates data used by the two applications. .

Refer to [Understanding Process Methods](#) for more information about processing methods.

External Applications Impact Data Import and Export

External Applications are configured to identify how a particular external system communicates data with Oracle Utilities Meter Data Management. This includes:

- The identifier type used to locate devices and measuring components. These are used both on import and export of data.
- The date/time format used in various data imports (i.e. whether or not the date/time format includes time zone information).

Please refer to the embedded help for more information about these fields.

Each external application can be associated to an [external system](#) which is used to define the messages that can be sent to that service provider and how each message is sent.

Configuring External Applications

This portal is used to display and maintain External Applications.

Refer to [Understanding External Applications](#) for more information.

You can access the portal from the **Admin**, then **Integration**, then **External Application**.

The following zones may appear as part of the portal's **Main** tab page:

- **External Applications List:** This zone lists all External Application records. Broadcast a record to display the details of the selected record.
- **External Application:** This zone provides information about the selected External Application.
- **Processing Method List:** This zone provides the list of processing methods defined for the External Application.
- **Translation Method List:** This zone provides the list of translation methods defined for the External Application.
- **Inbound BOs Sent By Service Provider:** This zone lists inbound Business Objects that are sent by this External Application. The identification is driven by the Business Object having a Business Object Option of type "Sent By Service Provider" that references the current External Application.

Initiating Smart Meter Commands from an External Application

Though often initiated as part of an orchestration activity (such as Enable Service or Exchange Meter) or from the Oracle Utilities Meter Data Management application, smart meter commands can also be initiated from external applications such as a customer information system such as Oracle Utilities Customer Care and Billing, a self-service application such as Oracle Utilities Digital Self-Service Transactions, or an outage management system such as Oracle Utilities Network Management System.

External applications initiate commands through the use of inbound web services, and outbound messages are used to send the results back to the initiating application. This section describes how smart meter commands can be initiated from external applications.

Command Processing Overview

This section provides a high level overview of how the system processes commands initiated from external applications.

For each step in the process, the table below provides a brief description of the processing that takes place, and lists the specific base package objects used. Note that the process outlined below has been simplified for illustrative purposes, and does not reference every step performed in this process. This example uses an "On-Demand Read - Interval" command.

Table listing the steps of command initiation and processing

Step	Process	Sample Object
1	External application initiates a command request via inbound web service	Inbound Web Service: D1-OnDemandReadInterval
2	Command activity is created in the Pending state.	Activity Business Object: D1-OnDemandReadInterval
3	The command activity goes through it's lifecycle, creating outbound communications as defined by the head end system, receiving the response.	
4	When the command enters the Completed state, an Enter algorithm sends the result to the initiating application.	Algorithm: Send On Demand Read to Edge Application (D1-SNDRDTEA)
5	The algorithm uses a "Response - Success" processing method (based on the the Response - Success (D1SR) processing role) defined for the external application to create an outbound message (based on the outbound message type defined for the processing method).	Processing Method Business Object: How to Send Activity Related O\B Messages (D1-HowToSendActivityResponse) Outbound Message Business Object: Outbound Message for Communication BOs (D1-OutboundMessage)
6	The external system and message sender sends the outbound message to the external application.	

Inbound Web Services

This section provides information about the inbound web services available for initiating smart meter commands from an external application. The table below lists the smart meter commands available, and the specific inbound web services provided for each.

Table listing supported commands and corresponding inbound web services

Command	Inbound Web Service
Device Status Check	Device Status Check (D1-DeviceStatusCheck)
On-Demand Read (Interval)	On Demand Read Interval (D1-OnDemandReadInterval)
On-Demand Read (Scalar)	On Demand Read Scalar (D1-OnDemandReadScalar)
Remote Connect	Remote Connect (D1-RemoteConnect)
Remote Disconnect	Remote Disconnect (D1-RemoteDisconnect)

See [Inbound Web Services](#) for more information about using inbound web services.

Required Data Elements

The inbound web service calls used to initiate commands must include some specific data elements in order to be successfully processed.

The table below lists the specific data elements required when initiating commands via inbound web service calls. Use the **WSDL** link to view the full web service description language definition for each command.

Table listing required data elements

Data Element	Description	Used by
requester	The system or person submitting the command request. This should be the name of the external application.	Device Status Check On-Demand Read (Interval) On-Demand Read (Scalar) Remote Connect Remote Disconnect
utilityDeviceIdentifierNumber	The ID of the device in the external system. This should be based on the Utility Device ID Type defined for the external application. For example, if the external application uses Serial Numbers for their device IDs, this would be the device's serial number.	Device Status Check On-Demand Read (Interval) On-Demand Read (Scalar) Remote Connect Remote Disconnect
measurementDestination	The destination for measurements returned by On-Demand read commands, from the Measurement Destination (MSRMT_DEST_FLG) lookup. Valid values include: <ul style="list-style-type: none"> Calling Edge Application (D1EA) Calling & Subscribing Edge Application (D1ES) Measurement Subscribing Edge Application (D1SE) 	On-Demand Read (Interval) On-Demand Read (Scalar)

Send to Edge Application Algorithms

As noted above, when the command enters the Completed state, an Enter algorithm sends the result to the initiating application. The table below lists the specific algorithms used with each command.

Table listing activity business objects and corresponding algorithms

Activity Business Object	Send to Edge Application Algorithm
Device Status Check (D1-DeviceStatusCheck)	Send Device Status Check Notification to Edge Application (D1-SNDDVSTCK)
On Demand Read Interval (D1-OnDemandReadInterval)	Send On Demand Read to Edge Application (D1-SNDRDTEA)
On Demand Read Scalar (D1-OnDemandReadScalar)	Send On Demand Read to Edge Application (D1-SNDRDTEA)
Remote Connect (D1-RemoteConnect)	Send Remote Connect Notification to Edge Application (D1-SRCNTEA)
Remote Disconnect (D1-RemoteDisconnect)	Send Remote Disconnect Notification to Edge Application (D1-SRDNTEA)

Sending Messages Back to the External Application

Sending outbound communications to an external application involves configuring a number of entities. This section provides an overview of the objects required to send outbound communications to external applications.

Outbound Message Types

Outbound message types define the details of outbound messages sent to the external application. You should create an outbound message type for each different type of message to be sent to the external application.

See [Outbound Messages](#) and [Defining Outbound Message Types](#) for more information about creating outbound message types.

Message Senders

Message senders define details for sending messages to external applications. You must create a message sender for each type of message to be sent to the external application.

Note: The Message Class MUST be set to **SOAPSNDR** (Sender for real-time HTTP / SOAP messages).

See [Message Senders](#) for more information about creating message senders.

External Systems

You must create an external system that represents the external application and defines the outbound message types that can be sent to the external application. The external system will be referenced on the external application.

You must configure an outbound message type on the external system for each type of message you will send to the external application. An external system's outbound message types are defined by the following:

- **Outbound Message Type:** The outbound message type (see above) created for the message
- **Processing Method:** The method by which the message will be sent. This should be set to "Real-time".
- **Message Sender:** The message sender (see above) created for the message.
- **Message XSL / Response XSL:** XSL files used to transform your message and the response to the message into the appropriate format used by the external application (Message XSL) and Smart Grid Gateway (Response XSL).

See [External Systems](#) for more information about creating external systems.

External Applications

The external applications that can initiate smart meter commands must be defined as External Applications. Examples can include:

- A customer information system (such as Oracle Utilities Customer Care and Billing)
- A self-service application (such as Oracle Utilities Digital Self-Service Transactions)

Information defined for external applications include:

- **External System:** The external system (see above) the defines the types of outbound messages to be sent to the external application.
- **Our Name/ID in Their System:** The value that the external application uses to identify our system.
- **Utility Device ID Type:** The Device ID Type that will be used when communicating with the external application and it will be the assumed Device ID Type for any device identifiers sent from the external application.
- **Utility Service Point ID Type:** The Service Point ID Type that will be used when communicating with the external application and it will be the assumed Service Point ID Type for any service point identifiers sent from the external application.
- **Processing Methods:** The external application's processing methods define how data relevant to the application is sent and/or created. At least one processing method should reference the outbound message type used to send responses to the external application. External applications that initiate smart meter commands should use the following processing roles:
 - **Response- Success:** Used to send an acknowledgement that the command was successfully executed and the results of the command, if applicable.

Refer to [Understanding External Applications](#) and [Configuring External Applications](#) for more information about external applications.

Configuring Master Data Synchronization

Refer to [Customer To Meter Master Data Synchronization](#) for more information.

Oracle Utilities Operational Device Management

Overview

This section provides an overview of how Oracle Utilities Meter Data Management supports integrations with Oracle Utilities Operational Device Management. In an integration between Oracle Utilities Meter Data Management and Oracle Utilities Operational Device Management:

- Oracle Utilities Meter Data Management is typically considered the "system of record" for service points (asset locations), contacts, and device installation information (install events)
- Oracle Utilities Operational Device Management is typically considered the "system of record" for assets (devices) and asset specification configuration (device configurations)

Given this breakdown of data between the two systems, any integration between them must account for the passage of data between the two to ensure that each system can accurately perform its business functions. The integration between Oracle Utilities Meter Data Management and Oracle Utilities Operational Device Management is based on data synchronization between the two systems.

Configuring Master Data Synchronization

The specific data synchronization flows supported between Oracle Utilities Meter Data Management (MDM) and Oracle Utilities Operational Device Management (ODM) include the following:

- **Asset-Device Synchronization:** As new assets and asset specification configurations are created or changed in ODM, corresponding devices and device configurations must be created or changed in MDM
- **Service Point/Contact - Asset Location/Contact:** As Service Points and/or Contacts are created or changed in MDM, corresponding Asset Locations and Contacts must be created or changed in ODM
- **Install Events- Asset Location/Disposition:** As devices are installed/removed in MDM, corresponding changes to an asset's Disposition (location and status) must be made in ODM

This synchronization process is supported through a set of business objects, master configurations, batch controls, and pre-configured Inbound Web Services. Refer to the *Oracle Utilities Integration for Device Operations Implementation Guide* for more information about this integration and the data synchronization processes used by this integration.

Master Configuration

The following master configurations are used to configure the sync process between MDM and ODM:

Master Configuration	Name / Description
Master Data Synchronization Configuration	Lists all foreign key references that need resolution. Each one should reference the view that contains the external key / production key cross-reference. For entities that undergo both the initial and the ongoing sync, two views are specified. For entities that undergo the ongoing sync, an external system / ID type mapping is specified to cater for entities that might be synchronizing from more than one external system.

Seeder Sync Request Master Configuration

Lists the maintenance objects (device, device configuration, etc.) that require synchronization. Each references the synchronization business object that needs to be instantiated when processing a synchronization request for that maintenance object. For maintenance objects that undergo both initial and the ongoing synchronization, two business objects are specified.

ODM Integration Master Configuration

Specifies the external system used to represent Oracle Utilities Operational Management, and the URL for the Oracle Utilities Operational Management application.

Also specifies the outbound message types used to send synchronization requests to Oracle Utilities Operational Management.

Inbound Data Synchronization Business Objects

The integration between Oracle Utilities Meter Data Management and Oracle Utilities Operational Device Management uses the following inbound (to Oracle Utilities Meter Data Management) synchronization business objects:

Object Name	Business Object	Description
Device Ongoing Sync Request	D1-OngoingSyncRequestDevice	Used to synchronize devices and device configurations in Oracle Utilities Meter Data Management based on assets and asset specification configurations created/updates in Oracle Utilities Operational Device Management.

Outbound Data Synchronization Business Objects

The integration between Oracle Utilities Meter Data Management and Oracle Utilities Operational Device Management uses the following outbound (from Oracle Utilities Meter Data Management) synchronization business objects (based on the F1-SYNC REQ maintenance object)

Object Name	Business Object	Description
ODM Sync Request	D1-ODMContactSyncRequest	Used to synchronize contacts in Oracle Utilities Operational Device Management based on contacts created/updated in Oracle Utilities Meter Data Management
ODM Install Event Sync Request	D1-ODMInstallEventSyncRequest	Used to synchronize asset location/disposition in Oracle Utilities Operational Device Management based on install events created/updated in Oracle Utilities Meter Data Management
ODM SP Sync Request	D1-ODMSPSyncRequest	Used to synchronize asset locations in Oracle Utilities Operational Device Management based on service points created/updated in Oracle Utilities Meter Data Management. This includes updating asset locations when equipment is attached to or remove from a service point.

Oracle Utilities Analytics Insights

This section describes integrations with Oracle Utilities Analytics Insights (previously known as Oracle DataRaker).

Business Flag Integration

With the business flag integration with Oracle Utilities Analytics Insights:

- Either Oracle Utilities Meter Data Management or Oracle Utilities Analytics Insights can initiate a business flag
- Oracle Utilities Meter Data Management can notify Oracle Utilities Analytics Insights of a change in status of a business flag:
 - if a business flag in error has been discarded
 - if a business flag's confidence has been updated
 - with the results of field work initiated by a business flag

For additional details see [About Business Flags](#) in the Oracle Utilities Application Framework *Administrative User Guide*.

Meter Insights and Investigations

The Meter Insights and Investigations functionality leverages the Oracle Utilities Analytics Insights business flag integration to support receipt of revenue protection events (referred to as "insights") from Oracle Utilities Analytics Insights for research and investigation using Oracle Utilities Meter Data Management (or Oracle Utilities Meter Solution Cloud Service). Revenue protection insights sent from Oracle Utilities Analytics Insights for investigation are events that suggest potential theft or loss of revenue such as unexpected consumption from an inactive meter, evidence of meter tampering, discovery of an improperly installed meter (such as a meter installed upside down or in reverse), and so on. Insights received from Oracle Utilities Analytics Insights create business flags, which in turn create related Meter Insight Investigation service tasks (referred to as "investigations"), which can then be researched and investigated using a dedicated **Meter Insights Investigations Viewer** portal.

See [Business Flags](#) in the *Administrative User Guide* for general information about the business flag functionality provided by the Oracle Utilities Application Framework.

See [Business Flag Integration](#) in the *Administrative User Guide* for more information about the Business Flag integration with Oracle Utilities Analytics Insights.

See [Service Issue Monitors](#) in the *Business User Guide* and [Service Task Types](#) in the *Administrative User Guide* for general information about service issue monitors.

See [Using the Meter Insights Investigations Viewer Portal](#) in the *Business User Guide* for more information about viewing meter insight service issue monitors.

Meter Insights and Investigation Business Objects

Business flags and service issue monitors used by Meter Insights and Investigations functionality are based on specific business objects:

Type of Object	Business Object
Business Flag	Revenue Protection Insight (D1-RevenueProtectionInsight)
Service Issue Monitor (Service Task)	Meter Insight Investigation (D1-MeterInsightInvestigation)
Investigation Type (Service Task Type)	Meter Insight Investigation Type (D1-MtrInsightInvestigationType)

Meter Insights and Investigation Processing

The table below provides a brief description of the process by which insights are received and processed, and lists example objects used by the Oracle Utilities Meter Data Management (and Oracle Utilities Meter Solution Cloud Service). Note that the process outlined below has been simplified for illustrative purposes, and does not reference every step performed in this process.

Step	Process	Example Data
1.	Oracle Utilities Analytics Insights sends events ("insights") to Meter Data Management, via the Business Flag integration, creating business flags based on the business flag type configuration.	Business Flag Business Object: Revenue Protection Insight (D1-RevenueProtectionInsight)
2.	An Enter algorithm on the "Create Service Issue Monitor" state creates a Service Issue Monitor based on the Service Task type defined on the business flag's type. The investigation is created in "Pending" status.	Enter Algorithm: Business Flag - Create Service Issue Monitor (D1-CREATESIM) Note: This algorithm is on the parent business object (D1-SPMonitorBusinessFlag). Service Issue Monitor (Service Task) Business Object: Meter Insight Investigation (D1-MeterInsightInvestigation)
3.	The investigation evaluates the service point (based on configuration of the service task type). <ul style="list-style-type: none"> If there are no issues, the investigation moves into the Discarded (No Investigation Needed) state. Otherwise, the investigation continues to the Open state. 	Evaluate Algorithm: Meter Insight Investigation - Analyze Service Point For Service Issues (D1-MII-ANZ)
4.	An Enter algorithm on the Open state creates a To Do entry.	Open Enter Algorithm: Meter Insight Investigation - Create To Do Entry (D1-MIICRTODO)
5.	Once the investigation is in the Open state, a business user can use the Meter Insights Investigation Viewer portal to examine the issue. See "Using the Meter Insights Investigation Portal" in the <i>Business User Guide</i> for more information about using this portal. The user can add comments and update the investigation to one of the following states: <ul style="list-style-type: none"> Waiting for Field Work Issue Resolved No Issue Discarded When the investigation moves into the Issue Resolved, No Issue, or Discarded states, it	

Step	Process	Example Data
6.	<p>transitions the business flag the Completed state with a Final Confidence based on the investigation's state (see below).</p> <p>If the service issue monitors enters the Waiting for Field Work state, a Monitor algorithm evaluates the Completion Criteria on the Service Task Type and transitions the investigation to one of the following states:</p> <ul style="list-style-type: none"> • Fieldwork Error • Open • Issue Resolved • No Issue • Inconclusive <p>When the investigation moves into the Issue Resolved, No Issue, or Inconclusive states, it transitions the business flag the Completed state with a Final Confidence based on the investigation's state (see below).</p>	<p>Waiting For Field Work Monitor Algorithm: Evaluate Completion Criteria (D1-MIIEVCMCR)</p>
7.	<p>If the service issue monitors enters the Issue Resolved state:</p> <ul style="list-style-type: none"> • An Enter algorithm completes the To Do entry • An Enter algorithm transitions the Business Flag to the Completed state (Final Confidence: Confirmed) 	<p>Enter Algorithm: Generic To Do Completion on Enter (D1-TODOCMPLR) Enter Algorithm: Transition Business Flags - Completed (D1-TRBUSFLGC)</p>
8.	<p>If the service issue monitors enters the No Issue state,</p> <ul style="list-style-type: none"> • An Enter algorithm completes the To Do entry • Transitions the Business Flag to Completed (Final Confidence: Rejected) 	<p>Enter Algorithm: Generic To Do Completion on Enter (D1-TODOCMPLR) Enter Algorithm: Transition Business Flags - Rejected (D1-TRBUSFLGR)</p>
9.	<p>If the service issue monitors enters the Inconclusive state,</p> <ul style="list-style-type: none"> • An Enter algorithm completes the To Do entry • Transitions the Business Flag to Completed (Final Confidence: Suspected) 	<p>Enter Algorithm: Generic To Do Completion on Enter (D1-TODOCMPLR) Enter Algorithm: Transition Business Flags - Suspected (D1-TRBUSFLGI)</p>
10.	<p>If the service issue monitors enters the Discarded state</p> <ul style="list-style-type: none"> • An Enter algorithm completes the To Do entry • Transitions the Business Flag to Completed (Final Confidence: Rejected) 	<p>Enter Algorithm: Generic To Do Completion on Enter (D1-TODOCMPLR) Enter Algorithm: Transition Business Flags - Rejected (D1-TRBUSFLGR)</p>

Configuring Meter Insights and Investigations

Configuring the Meter Insights and Investigations functionality involves creation and configuration of the following:

- [Business Flag Types](#)
- [Extendable Lookup Values](#)
- [To Do Types](#)
- [Service Tasks Types](#)
- [Master Configuration](#)

Business Flag Types

Create a business flag type for each type of revenue protection insight that will be received from Oracle Utilities Analytics Insights, including the following:

- **Business Object:** Service Point Monitor Business Flag Type (D1-SPMonitorBusinessFlagType)
- **Related Transaction BO:** Revenue Protection Insight (D1-RevenueProtectionInsight)
- **Service Issue Monitor Type:** The service task type for investigations created from business flags of this type.

NOTE: Because the **Service Issue Monitor Type** field is required, when initially creating business flag types, select a placeholder Service Issue Monitor Type to enable you to save the business flag type. After you have created the appropriate service task types, return to each business flag type and select the correct Service Issue Monitor Type.

Define other fields based on your business requirements.

Extendable Lookups

The **Meter Insights Investigation Viewer** portal uses the following profile extendable lookups when displaying consumption and insights (events):

- **360 Event Bar Profile:** Defines events to highlight that are pertinent to investigations, including your new business flag types
- **Final Values Overlay Profile:** Defines values to graph that are pertinent to investigations

Use the **Extendable Lookup** portal to create new extendable lookup values:

1. Create a new 360 Event Bar Profile extendable lookup value that includes your business flag types as well as other events pertinent to your investigations.
2. Create a new Final Values Overlay Profile extendable lookup value that includes the values to graph that are pertinent to your investigations.

These extendable lookup values will be referenced by your service task types.

To Do Types

Use the **To Do Type** portal to create a To Do Type (or update an existing To Do Type) with the Set Investigation Priority (D1-STINVSGPR) algorithm defined for the **Calculate Priority** system event.

These To Do Types will be referenced by your service task types.

Service Task Types

Create a service task type for each type of revenue protection insight (each type of investigation) that will be received from Oracle Utilities Analytics Insights, including the following:

- **Business Object:** Meter Insight Investigation Type (D1-MtrInsightInvestigationType)
- **Related Transaction BO:** Meter Insight Investigation (D1-MeterInsightInvestigation)
- **Evaluation Criteria:** The criteria used to evaluate the service point, including the existence of business flags of specified types (the business flag types you created earlier). See the embedded help for more details.
- **Service Investigation Order:** The field activity type and Field Task Type for field activities created by the investigation.
- **Completion Criteria:** The criteria used to determine if the service investigation order (field activity) should be completed and the result to be returned to the investigation. See the embedded help for more details.
- **Consumption Data Source:** Details that specify the types of consumption data will be displayed and how it is displayed in the [Meter Insights Investigation Viewer](#) portal, including the 360 Event Bar Profile and Final Values Overlay Profile extendable lookup values created earlier.
- **To Do Information:** The To Do Type and To Do Role used for To Do Entries created by the investigation. This should reference the To Do Type configured earlier.

Note: After you have created the appropriate service task types, return to the corresponding business flag type and select the correct service task type from the **Service Issue Monitor Type** drop-down list.

Master Configuration

Create a Meter Insights Configuration master configuration to capture key details used by Oracle Utilities Analytics Insights when creating insights including:

- Tolerances details related to specific types of insights (Flipped Meter, Unauthorized Consumption, and Leak Detection)
- Core sources of consumption for electric, gas, and water service types (including service point types, and unit of measure/time of use/service quantity identified combinations for each)

The master configuration is synchronized with Oracle Utilities Analytics Insights, and is used by Oracle Utilities Analytics Insights when generating insights for potential investigation.

Usage and Event Integration

Oracle Utilities Smart Grid Gateway adapters can be configured to publish initial measurement and device event data for use in Oracle Utilities Analytics Insights or other external systems. Published data is posted to a user-defined directory that Oracle Utilities Analytics Insights can monitor for import.

Initial measurement and device event data is published in the “native” data format (the format of the initial measurement and device event seeder business objects). This format includes normalized unit of measure, condition, and device event codes. See the *Oracle Utilities Smart Grid Gateway Adapter Development Kit Administrative User Guide* for more details about this format.

NOTE: Initial measurement data published via this feature is published prior to VEE processing. In addition, filtering can NOT be applied to initial measurement or device event data published via this feature.

Configuring DataRaker Usage and Event Integration

Oracle Utilities Smart Grid Gateway adapters use OSB and BPEL components when publishing initial measurement and device event data for integration with Oracle Utilities Analytics Insights.

OSB Projects

The following “CM” Oracle Service Bus projects are used to configure the integration between SGG and Oracle Utilities Analytics Insights:

Adapter	OSB Projects
---------	--------------

Landis+Gyr	SGG-D3-USAGE-CM (used to publish usage) SGG-D3-EVENT-CM (used to publish device events)
NES	SGG-D4-USAGE-CM (used to publish usage) SGG-D4-EVENT-CM (used to publish device events)
MV90	SGG-D5-USAGE-CM (used to publish usage)
Sensus	SGG-D6-USAGE-CM (used to publish usage) SGG-D6-EVENT-CM (used to publish device events)
Silver Spring Networks	SGG-D7-SSNXML-CM (used to publish usage) SGG-D7-CSV-CM (used to publish device events)
Itron OpenWay	SGG-D8-ITRONXML-CM (used to publish usage) SGG-D8-EXCEPTION-CM (used to publish device events)
Adapter Development Kit	SGG-DG-SEEDER-CM (used to publish usage and device events)

The following components provided with these projects are used in publishing measurement data and device events to Oracle Utilities Analytics Insights:

- The **DataRakerBusinessService** business service is used to send data to a pre-configured JMS queue (defined as an Endpoint URI), from which the data will be published. This business service is specified in the EnvironmentSettings.xq file (see below).
- The **DataRakerServiceAccount** service account is used to define and maintain the user name and password needed to access the JMS queue defined in the **DataRakerBusinessService** business service.

Enabling Data Publishing

Publishing initial measurement and device event data is enabled by referencing a publisher business service (DataRakerBusinessService) in the publishServices/service element in the EnvironmentSettings.xq files provided with the OSB projects listed above as follows:

```
<publishServices>
  <service>[publisherBusinessService]</service>
</publishServices>
```

BPEL Composites

The SGGDRIntegration BPEL composite handles publishing the data to Oracle Utilities Analytics Insights or other systems.

Configuring Publishing Output

The following parameters can be used to configure details of how the data is provided to Oracle Utilities Analytics Insights, including the directory where files are posted for Oracle Utilities Analytics Insights to consume, number of records per file, polling frequency, etc. These parameters are defined during installation. See the *Oracle Utilities Smart Grid Gateway Installation Guide* for more details about defining values for these parameters.

Parameter	Description	Default Value
SGG_DR_INT_QUEUE	JNDI name of queue to publish SGG payloads. This is the JMS queue defined in the DataRakerBusinessService business service. This should NOT be changed.	DataRakerQueue
SOA_DR_PUBLISH_SIZE	The number of records (SGG payloads) to accumulate in a published file.	100

Parameter	Description	Default Value
SOA_DR_FILE_SIZE	The maximum file size for the accumulated (SGG payloads) file in kilobytes.	524288
SOA_DR_ELAPSED_TIME	The period of time in second which, when exceeded, causes a new outgoing file to be created.	600
SOA_DR_POLLING_FREQ	The polling frequency in seconds of the staging directory for new files.	60
SOA_DR_STAGING_DIR	Mount point/directory for the staging directory for accumulated SGG payload files. This is used internally and should NOT be changed.	/spl/sploutput/staging
SOA_DR_INTEGRATION_DIR	Mount point/directory from which Oracle DataRaker will consume the converted XML files.	/spl/sploutput/int

Oracle Utilities Analytics Visualization

Timeliness and Quality Aggregations Overview

Oracle Utilities Meter Solution Cloud Service and Oracle Utilities Customer Cloud Service can be integrated with Oracle Utilities Analytics Visualization (OUAV) to allow users to view analytics data based on the quality and timeliness of measurement data.

This section describes integration of Oracle Utilities Meter Solution Cloud Service and Oracle Utilities Customer Cloud Service with Oracle Utilities Analytics Visualization (OUAV).

See [Operational Analytics](#) in the *Administrative User Guide* for general information about integrating with Oracle Utilities Analytics Visualization.

Base Package Timeliness and Quality Aggregation Measuring Components and Measurement Business Objects

Oracle Utilities Meter Data Management and Oracle Utilities Customer To Meter include a number of standard timeliness and quality aggregation processes delivered as part of the base product that can be used with Oracle Utilities Analytics Visualization (OUAV). These aggregate measurement data (including quantities and counts) for constituent measuring components based on the following dimensions: Postal, City, Head-End, Device Type, Usage Calculation Group, Market and Service Provider, and Service Type.

The table below lists the names (and business object codes) for these aggregators, along with the corresponding Oracle Utilities Analytics Visualization subject area.

Aggregator	Description
Measurement Timeliness Quantity Aggregator Business Object: D2-MsrmtTimelinessQuantityAggr OUAV Subject Area: Meter - Aggregated Timeliness Quantity	Aggregates measurement quantities that arrived on time or are late.
Measurement Timeliness Count Aggregator Business Object: D2-MsrmtTimelinessCountAggr OUAV Subject Area: Meter - Aggregated Timeliness Count	Aggregates measurement counts that arrived on time or are late.

Aggregator	Description
Measurement Quality Count Aggregator Business Object: D2-MsrmtQualityCountAggregator OUAV Subject Area: Meter - Aggregated Measurement Count	Aggregates measurement counts and distributes the constituents' counts across Value Identifiers based on condition codes.
Measurement Measured Quantity Aggregator Business Object: D2-MeasuredQuantityAggregator OUAV Subject Area: Meter - Aggregated Measurement Quantity	Aggregates measurement quantities and distributes the constituents' measurements across Value Identifiers based on condition codes.

Refer to the [Oracle Utilities Analytics Visualization User Guide](#) for more information about Oracle Utilities Analytics Visualization subject areas.

In addition, the base package also includes measurement business objects used to store aggregated measurement data. These include:

- Measured Quantity Measurement (D2-MeasuredQuantityMsrmt)
- Quality Count Measurement (D2-QualityCountMsrmt)
- Timeliness Count Measurement (D2-TimelinessCountMsrmt)
- Timeliness Quantity Measurement (D2-TimelinessQuantityMsrmt)

Configuring Timeliness and Quality Aggregation for Use with Oracle Utilities Analytics Visualization

This topic outlines the configuration needed for timeliness and quality aggregations used with Oracle Utilities Analytics Visualization.

Master Configuration

Create a Timeliness Master Configuration, defining the following:

- **Heating Degree Days Factor:** A number-based factor that contains heating degree days. These are aggregated and stored on the Measurement Measured Quantity Aggregator.
- **Cooling Degree Days Factor:** A number-based factor that contains cooling degree days. These are aggregated and stored on the Measurement Measured Quantity Aggregator.
- **Number of Hours to Consider IMD as Late:** The number of hours after which an initial measurement is considered late.
- **Buckets:** Value Identifiers that specify the late buckets used by the Measurement Timeliness Count and Measurement Timeliness Quantity aggregators.

Extendable Lookup: BI Aggregation — Usage Group Mapping

If your implementation makes use of dynamic usage calculation group determination on usage subscriptions (via the **Calculation Group Determination Override Algorithm** on the usage subscription type, the **Rate History** collection on the usage subscription, and the Customer Rate Schedule extendable lookup (D2-CCBRateScheduleLookup)), you will need to configure the BI Aggregation Usage Group Mapping extendable lookup (D2-UsageCalculationGroupLookup) with the usage calculation groups you wish to aggregate. If in the future you add new usage calculation groups, you will also need to add those usage calculation groups to this extendable lookup if you want them to be aggregated.

Note that an aggregation measuring component will be created for all dimension combinations and each usage calculation group in the extendable lookup (this is done to alleviate the need to execute the usage group determination algorithm for all usage subscriptions during the dimension scanning process).

NOTE: Configuring this extendable lookup is required ONLY if using dynamic usage calculation group determination.

Measuring Component Types

Create a master aggregator measuring component type and sub aggregator measuring component types for the four types of aggregators outlined above. Details for each aggregator measuring component type are listed below.

Measurement Measured Quantity Aggregator

- **Measuring Component Type Business Object:** Master Measurement Aggregator Type (D2-MasterMsrmtAggregatorType)
- **Measuring Component Business Object:** Measurement Measured Quantity Aggregator (D2-MeasuredQuantityAggregator)
- **Measurement Business Object:** Measured Quantity Measurement (D2-MeasuredQuantityMsrmt)
- **Value Identifiers** (recommended):

Value Identifier Type	Description	Unit of Measure
Measurement	kWh	Kilowatt-Hours
Value 01	Regular kWh	Kilowatt-Hours
Value 02	Estimated kWh	Kilowatt-Hours
Value 03	User-Edited kWh	Kilowatt-Hours
Value 06	Count	Count
Value 07	Heating Degree	Fahrenheit
Value 08	Cooling Degree	Fahrenheit
Value 09	Ave kWh	Kilowatt-Hours

- **Sub Aggregator MC Types** (see below):
 - Measurement Quality Count Aggregator Type
 - Measurement Timeliness Count Aggregator Type
 - Measurement Timeliness Quantity Aggregator Type

Measurement Quality Count Aggregator

- **Measuring Component Type Business Object:** Sub Measurement Aggregator Type (D2-SubMeasurementAggType)
- **Measuring Component Business Object:** Measurement Quality Count Aggregator (D2-MsrmtQualityCountAggregator)
- **Measurement Business Object:** Quality Count Measurement (D2-QualityCountMsrmt)
- **Value Identifiers** (recommended):

Value Identifier Type	Description	Unit of Measure
Measurement	kWh	Kilowatt-Hours
Value 01	Regular Count	Count
Value 02	Estimated Count	Count
Value 03	User-Edited Count	Count
Value 04	N Meas/No IMD Count	Count
Value 05	No Meas/IMD Exists Count	Count

Value Identifier Type	Description	Unit of Measure
Value 06	Read Outage Count	Count
Value 07	Read Other Count	Count
Value 08	Missing Count	Count

Measurement Timeliness Count Aggregator

- **Measuring Component Type Business Object:** Sub Measurement Aggregator Type (D2-SubMeasurementAggType)
- **Measuring Component Business Object:** Measurement Timeliness Count Aggregator (D2-MsrmtTimelinessCountAggr)
- **Measurement Business Object:** Timeliness Count Measurement (D2-TimelinessCountMsrmt)
- **Value Identifiers** (recommended):

Value Identifier Type	Description	Unit of Measure
Measurement	kWh	Kilowatt-Hours
Value 01	On Time Count	Count
Value 02	Late Count	Count
Value 03	Very Late Count	Count
Value 04	Very, Very Late Count	Count
Value 05	Missing Count	Count

Measurement Timeliness Quantity Aggregator

- **Measuring Component Type Business Object:** Sub Measurement Aggregator Type(D2-SubMeasurementAggType)
- **Measuring Component Business Object:** Measurement Timeliness Quantity Aggregator (D2-MsrmtTimelinessQuantityAggr)
- **Measurement Business Object:** Timeliness Quantity Measurement (D2-TimelinessQuantityMsrmt)
- **Value Identifiers** (recommended):

Value Identifier Type	Description	Unit of Measure
Measurement	kWh	Kilowatt-Hours
Value 01	On Time kWh	Kilowatt-Hours
Value 02	Late kWh	Kilowatt-Hours
Value 03	Very Late kWh	Kilowatt-Hours
Value 04	Very, Very Late kWh	Kilowatt-Hours

Activity Type

Create a Measurement Quantity Scanner activity type, based on the following business objects:

- **Business Object:** Measurement Quantity Scanner Type
- **Related Transaction Business Object:** Measurement Quantity Scanner

Timeliness and Quality Aggregation Processing for Use with Oracle Utilities Analytics Visualization

This topic describes the processes involved in running timeliness and quality aggregation processing for use with Oracle Utilities Analytics Visualization.

Execute Measurement Quantity Scan

Create an activity of the Measurement Quantity Scanner activity type, and process the activity (by clicking **Scan** in the **Record Action** section in the **Activity** zone).

This process uses the Measurement Quality and Timeliness Dimension Scanner batch control (D1-MQTDS) which creates measuring component aggregators that will also serve as the measuring component dimensions. This process will create a measuring component aggregator for each unique combination of Postal Code, City, Device Type, Head-End System, Usage Group, Market, Service Type, Geographic Code, Manufacturer/Model, Service Provider (where Market Relationship Type is specified on the dimension scanner activity).

NOTE: The Measurement Quality and Timeliness Dimension Scanner batch control (D1-MQTDS) supports multi-threading.

This step will create aggregator measuring components for all **Valid MC Types to Aggregate** defined on the master aggregator type (Measurement Measured Quantity Aggregator).

The created aggregator measuring component's characteristics will contain the Postal Code, City, Device Type, Head-End System, Usage Group, Market, Service Type, Geographic Code, Manufacturer/Model, Service Provider information.

Execute Aggregation

Once the measuring component aggregators have been created, run the Aggregation Monitor (D2-AGG) batch process. This will process ALL active master aggregators (together with the linked sub aggregators) that satisfy the batch filter parameters. Aggregated measurements will be created for the span of the aggregator horizon which is the current date less the horizon days in intervals defined on the master aggregation measuring component type (Measurement Measured Quantity Aggregator).

Condition Top Range and Condition Bottom Range parameters on the Aggregate Measurement Counts and Quantity (D2-AGG-MCQ) algorithm (an Enter algorithm on the Aggregate state of the Measurement Measured Quantity Aggregator (D2-MeasuredQuantityAggregator) business object) define condition ranges for quantity and count aggregation buckets.

This batch process should be run on a scheduled reoccurring basis.

Aggregated Data

Aggregated measurements are created in the Measurement (D1_MSRMT) and Aggregation Measurement (D1_AGG_MSRMT) tables, using the following base package measurement business objects:

- Measured Quantity Measurement (D2-MeasuredQuantityMsrmt)
- Quality Count Measurement (D2-QualityCountMsrmt)
- Timeliness Count Measurement (D2-TimelinessCountMsrmt)
- Timeliness Quantity Measurement (D2-TimelinessQuantityMsrmt)

Oracle Utilities Analytics Visualization Fact views access the Aggregation Measurement table.

Oracle Utilities Analytics Visualization Dimension views access the Measuring Component and Measuring Component Characteristics tables.

Consumption Analytics Aggregations Overview

This section outlines the configuration needed to support integration with Oracle Utilities Analytics Visualization for the following consumption-based analytics:

- Usage by Network Location
- Usage by Region
- Usage by Customer Classification
- Unaccounted for Losses

These analytics are accessed in Oracle Utilities Analytics Visualization (OUAV) via the following subject areas:

Analytics	OUAV Subject Areas
Usage by Network Location	Meter - Distribution Nodes
Usage by Region	
Usage by Customer Classification	Meter - Customer Classification
Unaccounted for Losses	Meter - Downstream Usage Meter - Downstream Service Points Meter - Facility Usage Meter - Facilities

Configuring Dynamic Aggregation for Consumption Analytics

This section outlines the configuration needed for consumption analytics aggregations used with Oracle Utilities Analytics Visualization.

Consumption analytics leverage data generated through dynamic aggregation, and requires configuration of the following objects:

- Data Sources
- Aggregator Measuring Component Types
- Aggregation Groups
- Measuring Component Sets

Refer to [Dynamic Aggregation](#) for more information about configuring dynamic aggregation.

Note: The configuration outlined below is based on data in the demonstration database. This sample configuration uses Electric service for Usage by Network Location, Region, and Customer Classification, and Gas service for Unaccounted for Losses.

Data Sources

Create the following data sources, based on the Measurements from US Service Points (D1-DataSourceMeasurements) business object:

For Usage by Network Location, Usage by Region, and Usage by Customer Classification (Electric)

Field / Section	Value
Data Source	CM-E-KWH-60-TRANS
Description	Electric kWh 60min Transformer Interval Measurements
Status	Active

Field / Section	Value				
Data Source Class	Measurements from US Service Points				
Interval / Scalar	Interval				
Sourced Measuring Component Type	<table border="1"> <thead> <tr> <th>Measuring Component Type</th> <th>Value Identifier Type</th> </tr> </thead> <tbody> <tr> <td>Measuring Component Types for measuring components to be aggregated</td> <td>Measurement</td> </tr> </tbody> </table>	Measuring Component Type	Value Identifier Type	Measuring Component Types for measuring components to be aggregated	Measurement
Measuring Component Type	Value Identifier Type				
Measuring Component Types for measuring components to be aggregated	Measurement				

For Unaccounted for Losses (Gas)

Field / Section	Value				
Data Source	CM-G-CCF-60-FACIL				
Description	Gas CCF 60min Facility Interval Measurements				
Status	Active				
Data Source Class	Measurements from US Service Points				
Interval / Scalar	Interval				
Sourced Measuring Component Type	<table border="1"> <thead> <tr> <th>Measuring Component Type</th> <th>Value Identifier Type</th> </tr> </thead> <tbody> <tr> <td>Measuring Component Types for measuring components to be aggregated</td> <td>Measurement</td> </tr> </tbody> </table>	Measuring Component Type	Value Identifier Type	Measuring Component Types for measuring components to be aggregated	Measurement
Measuring Component Type	Value Identifier Type				
Measuring Component Types for measuring components to be aggregated	Measurement				

Aggregator Measuring Component Types

Create the following aggregator measuring component types, based on the Dynamic Aggregator - Type (D1-AggregationIntervalType) business object:

For Usage by Network Location, Usage by Region, and Usage by Customer Classification (Electric)

Field / Section	Value
Measuring Component Type	CM-E-I-AGG-KWH-60-TRANS
Description	Electric - Interval - Aggregation - kWh 60min Transformer Load
Measuring Component Business Object	Dynamic Aggregator - Interval (D1-AggregatorInterval)
Measurement Business Object	Aggregation Measurement (D1-AggregationMeasurement)
Measuring Component Class	Aggregator
Service Type	Electric
Allow Negative Consumption	Allowed
Consumptive/Subtractive	Consumptive

Field / Section	Value						
Interval Size	01:00:00						
Data Source	Electric kWh 60min Transformer Interval Measurements						
Value Identifiers	<table border="1"> <thead> <tr> <th>Value Identifier Type</th> <th>Short Hand Description</th> <th>Unit of Measure</th> </tr> </thead> <tbody> <tr> <td>Measurement</td> <td>kWh</td> <td>Kilowatt-Hours</td> </tr> </tbody> </table>	Value Identifier Type	Short Hand Description	Unit of Measure	Measurement	kWh	Kilowatt-Hours
Value Identifier Type	Short Hand Description	Unit of Measure					
Measurement	kWh	Kilowatt-Hours					

For Unaccounted for Losses (Gas)

Field / Section	Value																														
Measuring Component Type	CM-G-I-AGG-CCF-60-FACIL																														
Description	Gas - Interval - Aggregation - CCF 60min Downstream																														
Measuring Component Business Object	Dynamic Aggregator - Interval (D1-AggregatorInterval)																														
Measurement Business Object	Aggregation Measurement (D1-AggregationMeasurement)																														
Measuring Component Class	Aggregator																														
Service Type	Gas																														
Allow Negative Consumption	Allowed																														
Consumptive/Subtractive	Consumptive																														
Interval Size	01:00:00																														
Data Source	Gas CCF 60min Facility Interval Measurements																														
Value Identifiers	<table border="1"> <thead> <tr> <th>Value Identifier Type</th> <th>Short Hand Description</th> <th>Unit of Measure</th> <th>SQL</th> <th>Value Calculation Method</th> </tr> </thead> <tbody> <tr> <td>Measurement CCF</td> <td></td> <td>100 Cubic Feet (Gas)</td> <td></td> <td>Sum</td> </tr> <tr> <td>Value 01</td> <td>Count</td> <td>Count</td> <td></td> <td>Count</td> </tr> <tr> <td>Value 02</td> <td>Average</td> <td>100 Cubic Feet (Gas)</td> <td>Average</td> <td>Average</td> </tr> <tr> <td>Value 03</td> <td>Min</td> <td>100 Cubic Feet (Gas)</td> <td>Minimum</td> <td>Min</td> </tr> <tr> <td>Value 04</td> <td>Max</td> <td>100 Cubic Feet (Gas)</td> <td>Maximum</td> <td>Max</td> </tr> </tbody> </table>	Value Identifier Type	Short Hand Description	Unit of Measure	SQL	Value Calculation Method	Measurement CCF		100 Cubic Feet (Gas)		Sum	Value 01	Count	Count		Count	Value 02	Average	100 Cubic Feet (Gas)	Average	Average	Value 03	Min	100 Cubic Feet (Gas)	Minimum	Min	Value 04	Max	100 Cubic Feet (Gas)	Maximum	Max
Value Identifier Type	Short Hand Description	Unit of Measure	SQL	Value Calculation Method																											
Measurement CCF		100 Cubic Feet (Gas)		Sum																											
Value 01	Count	Count		Count																											
Value 02	Average	100 Cubic Feet (Gas)	Average	Average																											
Value 03	Min	100 Cubic Feet (Gas)	Minimum	Min																											
Value 04	Max	100 Cubic Feet (Gas)	Maximum	Max																											

Aggregation Groups

Create the following aggregation groups based on the Aggregation Group (D1-AggregationGroup) business object:

For Usage by Network Location and Usage by Region (Electric)

Field / Section	Value								
Aggregation Group	CM-E-CONS-TRANS								
Description	Electric Dynamic Consumption								
Status	Finalized								
Aggregation Category	Analytics								
Time Zone	US Pacific Time								
Aggregation Schedule	<ul style="list-style-type: none"> • Aggregation Schedule Type: Defined Lag • Aggregation Cut-Off Time: 0:00:00 • Aggregation Horizon: 24:00:00 • Aggregation Lag: 48:00:00 								
Aggregation Measuring Component Sets	<table border="1"> <thead> <tr> <th>Sequence</th> <th>Measuring Component Set</th> <th>Initiation Method</th> <th>Measuring Component Set Class</th> </tr> </thead> <tbody> <tr> <td>10</td> <td>Electric - Consumption - Transformer - Interval</td> <td>Manual</td> <td>Aggregation Foundation</td> </tr> </tbody> </table>	Sequence	Measuring Component Set	Initiation Method	Measuring Component Set Class	10	Electric - Consumption - Transformer - Interval	Manual	Aggregation Foundation
Sequence	Measuring Component Set	Initiation Method	Measuring Component Set Class						
10	Electric - Consumption - Transformer - Interval	Manual	Aggregation Foundation						

For Usage by Customer Classification (Electric)

Field / Section	Value
Aggregation Group	CM-E-CONS-PROF
Description	Consumption - Profile Class
Status	Finalized
Aggregation Category	Analytics
Time Zone	
Aggregation Schedule	<ul style="list-style-type: none"> • Aggregation Schedule Type: Defined Lag • Aggregation Cut-Off Time: 0:00:00 • Aggregation Horizon: 24:00:00 • Aggregation Lag: 48:00:00

Field / Section**Value**

Aggregation Measuring Component Sets

Sequence	Measuring Component Set	Initiation Method	Measuring Component Set Class
10	Consumption - Profile Class - Interval	Manual	Aggregation Foundation

For Unaccounted for Losses (Gas)**Field / Section****Value**

Aggregation Group

CM-G-LOSS

Description

Gas Dynamic Consumption

Status

Finalized

Aggregation Category

Analytics

Time Zone

US Pacific Time

Aggregation Schedule

- **Aggregation Schedule Type:** Defined Lag
- **Aggregation Cut-Off Time:** 0:00:00
- **Aggregation Horizon:** 24:00:00
- **Aggregation Lag:** 48:00:00

Aggregation Measuring Component Sets

Sequence	Measuring Component Set	Initiation Method	Measuring Component Set Class
10	Gas - Consumption - Downstream - Interval	Automatic	Aggregation Foundation

Measuring Component Sets

Create the following measuring component sets based on the Aggregation Foundation Set (D1-AggregationFoundationSet) business object:

For Usage by Network Location and Usage by Region (Electric)**Field / Section****Value**

Measuring Component Set

CM-E-CONS-TRANS

Status

Active

Description

Electric - Consumption - Transformer - Interval

Measuring Component Type

Electric - Interval - Aggregation - kWh 60min Transformer Load

Field / Section	Value
Aggregation Group	Electric Dynamic Consumption
Measuring Component Set Class	Aggregation Foundation
Allow Partial Constituent Aggregation	Yes
Extract	Do Not Extract
General Processing	
Criteria Processing	<ul style="list-style-type: none"> • Non-Individually Managed Formula: TFORM

Source Type	Source Entity	Column/ Type	Represent Missing Data
Table	Service Point - MDM	City	No
Table	Service Point - MDM	Postal	No
Table (Demo)	Service Point Facility - MDM	Facility ID	No
Table (Demo)	Service Point Facility - MDM	Facility Relationship Type	No

Criteria	<ul style="list-style-type: none"> • Criteria Name: TFORM • Source Type: Table (Demo) • Source Entity: Service Point Facility - MDM • Column/Type: Facility Relationship Type • Criteria Type: Include • Value: Commodity Distribution
----------	--

For Usage by Customer Classification (Electric)

Field / Section	Value
Measuring Component Set	CM-E-CONS-PROF
Status	Active
Description	Consumption - Profile Class - Interval
Measuring Component Type	Electric - Interval - Aggregation - kWh 60min Transformer Load
Aggregation Group	Consumption - Profile Class
Measuring Component Set Class	Aggregation Foundation
Allow Partial Constituent Aggregation	Yes

Field / Section	Value																								
Extract	Do Not Extract																								
General Processing	<ul style="list-style-type: none"> • Sequence: 10 • Initiation Method: Manual • Imported from External Source: No 																								
Criteria Processing																									
Dimensions	<table border="1"> <thead> <tr> <th>Source Type</th> <th>Source Entity</th> <th>Column/ Type</th> <th>Represent Missing Data</th> </tr> </thead> <tbody> <tr> <td>Characteristic*</td> <td>Usage Subscription Characteristics*</td> <td>Procurement Class*</td> <td>No*</td> </tr> <tr> <td>Table</td> <td>Service Point - MDM</td> <td>City</td> <td>No</td> </tr> <tr> <td>Table</td> <td>Service Point - MDM</td> <td>Postal</td> <td>No</td> </tr> <tr> <td>Table</td> <td>Usage Subscription</td> <td>Usage Subscription Type</td> <td>No</td> </tr> <tr> <td>Table (Demo)</td> <td>Service Point Facility - MDM</td> <td>Facility ID</td> <td>No</td> </tr> </tbody> </table> <p>* Optional</p>	Source Type	Source Entity	Column/ Type	Represent Missing Data	Characteristic*	Usage Subscription Characteristics*	Procurement Class*	No*	Table	Service Point - MDM	City	No	Table	Service Point - MDM	Postal	No	Table	Usage Subscription	Usage Subscription Type	No	Table (Demo)	Service Point Facility - MDM	Facility ID	No
Source Type	Source Entity	Column/ Type	Represent Missing Data																						
Characteristic*	Usage Subscription Characteristics*	Procurement Class*	No*																						
Table	Service Point - MDM	City	No																						
Table	Service Point - MDM	Postal	No																						
Table	Usage Subscription	Usage Subscription Type	No																						
Table (Demo)	Service Point Facility - MDM	Facility ID	No																						

Criteria

For Unaccounted for Losses (Gas)

Field / Section	Value
Measuring Component Set	CM-G-LOSS
Status	Active
Description	Gas - Consumption - Downstream - Interval
Measuring Component Type	Gas - Interval - Aggregation - CCF 60min Downstream
Aggregation Group	Gas Dynamic Consumption
Measuring Component Set Class	Aggregation Foundation
Allow Partial Constituent Aggregation	Yes
Extract	Do Not Extract
General Processing	
Criteria Processing	Non-Individually Managed Formula: TFORM

Field / Section	Value			
Dimensions	Source Type	Source Entity	Column/Type	Represent Missing Data
	Table	Service Point - MDM	City	No
	Table	Service Point - MDM	Postal	No
	Table (Demo)	Service Point Facility - MDM	Facility ID	No
	Table (Demo)	Service Point Facility - MDM	Facility Relationship Type	No
Criteria	<ul style="list-style-type: none"> • Criteria Name: TFORM • Source Type: Table (Demo) • Source Entity: Service Point Facility - MDM • Column/Type: Facility Relationship Type • Criteria Type: Include • Value: Commodity Distribution 			

Dynamic Aggregation Processing for Consumption Analytics

Processing of dynamic aggregation for consumption analytics uses the standard approach to dynamic aggregation execution. Refer to [Dynamic Aggregation](#) in the *Business User Guide* for more information about dynamic aggregation execution and processing.

Oracle Utilities Network Management System

Outage Care Integration

The following section describes functionality provided for the integration between Oracle Utilities Customer Care and Billing and Oracle Utilities Network Management System.

The Big Picture of Outage Care Integration

Oracle Utilities Customer Care and Billing is the central repository for customer information; for example, name, address, phone number, etc. Oracle Utilities Network Management System is the central repository for outage information; for example, outage calls, affected supply nodes, expected restoration time, etc.

In an integrated environment, each system provides information to the other system so that they can operate together seamlessly.

- The outage system uses the set of current customers to determine and manage outages to minimize their impact.
- The outage system is informed of outages captured in Oracle Utilities Customer Care and Billing.
- Oracle Utilities Customer Care and Billing uses the current status of an outage at a given premise for customer service.

Customer Information Integration

The outage system needs information about current customers to determine and manage outages to minimize their impact. The current customer information must be made available in Oracle Utilities Network Management System. This can be done via data synchronization.

Depending on the specific edge application and version you are using, there are components of the integration that use Sync Request for the change data capture step. The following points highlight how to get more information:

- Refer to your products integration to Oracle Utilities Network Management System Implementation Guide to configure the Sync Request and change data capture functionality.
- Review the Sync Request Business Objects provided by your product for NMS integration.
- Refer to Data Synchronization for a high level understanding of the process.

FASTPATH:

Refer to [The Big Picture of Sync Requests](#) for more information about synchronizing data.

Interfacing Outage Calls

The following points describe the integration:

- Oracle Utilities Customer Care and Billing is able to record trouble calls for a particular service point that exists in the system, as well as for an unknown service point, i.e. a fuzzy call. For a fuzzy call, the caller must provide either a street intersection, or a street segment.
- When an outage call is created and sent to the external system, an algorithm on the outage call business object is responsible for creating an outbound message that's sent to the external system. This is a real-time synchronous interface between Oracle Utilities Customer Care and Billing and Oracle Utilities Network Management System.
- Oracle Utilities Network Management System processes the Calls table and creates Incidents.

FASTPATH:

Refer to the *Oracle Utilities Customer Care and Billing - Network Management System Integration Implementation Guide* for information about outage call integration.

Outage Inquiry

Oracle Utilities Customer Care and Billing provides query transactions that can be used to make real-time synchronous calls to NMS and inquire on one of the following:

- Job History for a particular customer, service point, location or call identifier
- Call History for a particular customer, service point, location or call identifier
- Planned Outage Jobs for a particular service point

FASTPATH:

Refer to the *Oracle Utilities Customer Care and Billing - Network Management System Integration Implementation Guide* for information about outage query integration.

Setting Up The System To Enable Outage Integration

The following section provides an overview of how to enable the integration between Oracle Utilities Customer Care and Billing and Oracle Utilities Network Management System.

External System Setup

An external system must be setup in order integrate Oracle Utilities Network Management System. Define message senders for the following Outbound Message Types and associate them to the external system:

- NMS Outage Call (C1-NMSOUTCAL)
- NMS Job History Query (C1-NMSJOBHST)
- NMS Call History Query (C1-NMSCALHST)
- NMS Planned Outages Query (C1-NMSPLNOUT)

For synchronizing outage related notification preferences to NMS, define a message sender for the Outbound Message to Notify Edge Applications (C1-NTFOUTMSG) Outbound Message Type and associate it to the external system.

Once the external system is defined, configure the so the system knows which external system to use for outage queries.

Define Characteristic Types

The following characteristic types must be defined to facilitate Outage integration:

FASTPATH: Refer to [Defining Characteristic Types](#) for information on how to set up characteristic types.

Outage Group Code Characteristic Type

These characteristics are used to describe the outage problem.

- Create at least one pre-defined characteristic type
- For each characteristic type, define its list of valid values
- Include Service Task Type in the characteristic entity collection

NOTE:

Integration with Outage Management. The outage codes must be defined in both Oracle Utilities Customer Care and Billing and the outage management system. Refer to your Oracle Utilities Network Management System documentation for information about defining the outage codes there.

Critical Customer Characteristic Type

These characteristics are used to associate a service point with one or more critical customer identifiers (e.g., medical, key account, government, etc.).

- Create a pre-defined characteristic type
 - Define one or more critical customer predefined values
 - Include Service Point in the characteristic entity collection
 - Associate the characteristic and pre-defined values to the Critical Customer Types Characteristic Mapping section of the [NMS Sync Integration Mater Configuration](#).
-

NOTE:

Integration with Outage Management. The outage codes must be defined in both Oracle Utilities Customer Care and Billing and the outage management system. Refer to your Oracle Utilities Network Management System documentation for information about defining the outage codes there.

Contact Name Characteristic Type

This is used to link the contact name of the caller associated with an outage call as a characteristic on the outage call.

- Create an ad-hoc characteristic type
- Include Service Task Type in the characteristic entity collection
- Specify this characteristic type on the [Schema Constants Feature Configuration](#) using the Outage Call Contact Name Characteristic Type feature option

Contact Number Characteristic Type

This is used to link the contact number of the caller associated with an outage call as a characteristic on the outage call.

- Create an ad-hoc characteristic type
- Include Service Task Type in the characteristic entity collection
- Specify this characteristic type on the [Schema Constants Feature Configuration](#) using the Outage Call Contact Number Characteristic Type feature option

Call Identifier Characteristic Type

This is used to link the call identifier supplied by the caller associated with an outage call as a characteristic on the outage call.

- Create an ad-hoc characteristic type
- Include Service Task Type in the characteristic entity collection
- Specify this characteristic type on the [Schema Constants Feature Configuration](#) using the Outage Call Identifier Characteristic Type feature option

Street Name Characteristic Type

This is used to link location information supplied by the caller associated with a fuzzy trouble call as a characteristic on the outage call.

- Create an ad-hoc characteristic type
- Include Service Task Type in the characteristic entity collection

- Specify this characteristic type on the [Schema Constants Feature Configuration](#) using the Outage Call Street Name Characteristic Type feature option

Cross Street Name Characteristic Type

This is used to link location information supplied by the caller associated with a fuzzy trouble call as a characteristic on the outage call.

- Create an ad-hoc characteristic type
- Include Service Task Type in the characteristic entity collection
- Specify this characteristic type on the [Schema Constants Feature Configuration](#) using the Outage Call Cross Street Name Characteristic Type feature option

Block Number Characteristic Type

This is used to link location information supplied by the caller associated with a fuzzy trouble call as a characteristic on the outage call.

- Create an ad-hoc characteristic type
- Include Service Task Type in the characteristic entity collection
- Specify this characteristic type on the [Schema Constants Feature Configuration](#) using the Outage Call Block Number Characteristic Type feature option

City Characteristic Type

This is used to link location information supplied by the caller associated with a fuzzy trouble call as a characteristic on the outage call.

- Create an ad-hoc characteristic type
- Include Service Task Type in the characteristic entity collection
- Specify this characteristic type on the [Schema Constants Feature Configuration](#) using the Outage Call City Characteristic Type feature option

State Characteristic Type

This is used to link location information supplied by the caller associated with a fuzzy trouble call as a characteristic on the outage call.

- Create an ad-hoc characteristic type
- Include Service Task Type in the characteristic entity collection
- Specify this characteristic type on the [Schema Constants Feature Configuration](#) using the Outage Call State Characteristic Type feature option

Schema Constants - Feature Configuration

Create a [feature configuration](#) with the type Schema Constants. Populate entries for all the options listed below.

NOTE:

Only one. The system expects only one Schema Constants feature configuration to be defined.

Configure the options for your interaction with the outage system.

NOTE:

Your implementation may define additional options types. You do this by adding new lookup values to the lookup field F1CN_OPT_TYP_FLG.

Option	Description
Outage Call Contact Name Characteristic Type	This is used to link the contact name of the caller associated with an outage call as a characteristic on the outage call. Refer to Defining Service Order Options for more information. Only one value is allowed for this option.
Outage Call Contact Number Characteristic Type	This is used to link the contact number of the caller associated with an outage call as a characteristic on the outage call. Refer to Defining Service Order Options for more information. Only one value is allowed for this option.
Outage Call Identifier Characteristic Type	This is used to link the call identifier supplied by the caller associated with an outage call as a characteristic on the outage call. Refer to Defining Service Order Options for more information. Only one value is allowed for this option.
Outage Call Street Name Characteristic Type	This is used to link the street name supplied by the caller associated with a fuzzy trouble call as a characteristic on the outage call. Refer to Defining Service Order Options for more information. Only one value is allowed for this option.
Outage Call Cross Street Name Characteristic Type	This is used to link the cross street name supplied by the caller associated with a fuzzy trouble call as a characteristic on the outage call. Refer to Defining Service Order Options for more information. Only one value is allowed for this option.
Outage Call Block Number Characteristic Type	This is used to link the block number supplied by the caller associated with a fuzzy trouble call as a characteristic on the outage call. Refer to Defining Service Order Options for more information. Only one value is allowed for this option.
Outage Call City Characteristic Type	This is used to link the city supplied by the caller associated with a fuzzy trouble call as a characteristic on the outage call. Refer to Defining Service Order Options for more information. Only one value is allowed for this option.
Outage Call State Characteristic Type	This is used to link the state supplied by the caller associated with a fuzzy trouble call as a characteristic on the outage call. Refer to Defining Service Order Options for more information. Only one value is allowed for this option.

NMS Outage Integration - Master Configuration

The integration with Oracle Utilities Network Management System (NMS) requires the setup of master configuration data that controls the processing of master data synchronization and outage management operations.

Navigate to **Admin > General > Master Configuration**

Set up the following master configurations:

- **NMS Outage Integration Master Config:** This master configuration relates to the outage call and outage query integration with NMS.
- **NMS Sync Integration Master Config:** This master configuration relates to the service point based master data synchronization to NMS.

Refer to the embedded help for more details on how each section is configured.

Outage Notification Preferences

The system supports the ability to synchronize notification preferences that are owned by other edge applications. For example, during an outage event, Oracle Utilities Network Management System (NMS) is the system responsible for sending notifications to impacted customers that are subscribed or opted-in to receive notifications for these events. To support this functionality, notification preference statuses for outage related notification types that are updated under a customer's account must be synchronized to NMS.

To configure your system to synchronize outage related notification preferences to NMS, perform the following steps:

- Configure the outage notification types that are owned by NMS (e.g. Planned Outage, Unplanned Outage, Outage Started, Estimated Restoration Type, Outage Restored). Notification types can be configured as template based subscription, or template based parent/individual push. Refer to [Setting Up Notification Preference Options](#) for more information.
- Configure the **Notification Preferences** master configuration. Under the master configuration's Edge Application Notification section, add the notification types along with the edge application (Network Management System) and External System/Outbound Message Type for each entry. Refer to the embedded help for more details.

Once configured, the **Notification Preference Sync Initial Load (C1-NCPIL)** batch process is used to create initial synchronization requests. This batch control creates initial synchronization requests for Notification Contact Preference data (Maintenance Object C1-NT-PREF). The maintenance object and sync business object (C1-NtfContactPreferenceSync) are plugged in as parameters to the batch job.

For ongoing synchronization requests, the **Sync Request Monitor batch control (F1-SYNRQ)** is responsible for monitoring synchronization requests in the Pending state and transitions them to the Determine if Sync Needed state. Use the following parameters when running the F1-SYNRQ batch job:

- Maintenance Object: F1-SYNC REQ
-
- Restrict By Business Object: C1-NtfContactPreferenceSync
- Restrict By Status Code: PENDING

FASTPATH:

Refer to the *Oracle Utilities Customer Care and Billing - Network Management System Integration Implementation Guide* for information about outage notification integration.

Asset Management System Integration

The following section describes functionality provided for the integration with an asset management system, such as Oracle Utilities Work and Asset Management (OUWAM).

Interfacing Service Calls

Oracle Utilities Customer Care and Billing is able to record service calls for a particular service point in the system, as well as for an unknown service point, i.e. a fuzzy call. Service call information is sent to the asset management system that will process any work that may be required due to the service call.

When recording a service call, the system creates a service call process flow and assigns it a service call communication type. The process flow type and service call communication type are determined from the action method with Action Method Role of **Service Call**. See [Action Method](#) for more information about setting up action methods. Service call communication type defines the rules and controls for creating service call communication. It also defines the service call communication business object.

The system is delivered with the following objects that are used to record a service call:

- Process Flow Type **C1-SERVICECALL**
- Service Call Communication Type business object **C1-ServiceCallCommTaskType**
- Service Call Communication business object **C1-ServiceCallCommunication**

Refer to [Service Calls](#) for more details.

Setting Up The System To Enable Asset Management System Integration

The following section describes how to enable the integration between Oracle Utilities Customer Care and Billing and your asset management system.

External System Setup

An external system must be setup to integrate with Oracle Utilities Work and Asset Management (WAM).

For sending service call information to WAM, define message senders for the following outbound message types:

- **New Service Call Communication Request Outbound Message (C1-SVCCALNEW)**. This is used to send new service call information.
- **Update Service Call Communication Request Outbound Message (C1-SVCCALUPD)**. This is used to send service call comments and service call cancel request.

For retrieving service call information from WAM, define message senders for the following outbound message types:

- **Service Call Search (C1-SVCCLSRCH)**. This is used by the service call search panel to retrieve service calls from the external system.
- **Service Call Details (C1-SVCCALDTL)**. This is used in the service call details pop up window to retrieve details of a service call from external system.
- **Retrieve Work Documents (C1-RETWRKDOC)**. This is used in the service call details pop up window to retrieve work documents related to a service call.

Once the external system is defined, configure the WAM Integration Master Configuration so the system knows which external system and outbound message types to use.

WAM Integration Master Configuration

The integration with Oracle Utilities Work and Asset Management (WAM) requires the setup of master configuration data that controls the processing of service call information.

To maintain master configuration, open **Admin > General > Master Configuration**

Set up the **CC&B WAM Integration** master configuration, which defines the external system and outbound message types to send and receive service call information. It also defines the URL of the WAM environment. This is used by the service call details pop-up window to render the service call hyperlink. The hyperlink is available if the user has access to the **Go To WAM (C1-GOTOWAM)** application service. Note that the login user to WAM should have access to the service call transaction. This authorization needs to be done in WAM.

Message Formats

Oracle Utilities Meter Data Management supports three core transactional data imports: Initial Measurement Data, Device Event Data, and Usage Transactions. To see the appropriate format for each of these imports please see the following:

- **Initial Measurement Data:** Please see the IMD Seeder (D1-IMDSeeder) business object for the appropriate format
- **Device Events:** Please see the Device Event Seeder (D1-DeviceEventSeeder) business object for the appropriate format
- **Usage Transactions:** Please see the Usage Transaction Seeder (D2-UsgTranSeeder) business object for the appropriate format*

Data Import - Message Driven Bean Configuration

Overview

This section describes the steps for configuring the Message Driven Bean (MDB) feature of Oracle Utilities Meter Data Management and Oracle Utilities Smart Grid Gateway to listen to inbound JMS messages. This feature is used when importing IMDs and device events from head-end systems or when receiving Usage Transactions from CIS.

JMS Configuration

JMS configuration involves setting up JMS queues which will received inbound usage readings and device events. The JMS queues need to be created first on the application server where the OSB component is deployed. This server is referred to as remote server in the sections below. In the following section the JMS queue on the remote server is assumed to be created with the name **DestinationQueueWatch-CM**.

Note: The JMS changes described in the following sections are not persistent during patches or upgrades. They will need to be re-created after applying any patches or upgrades to Oracle Utilities Smart Grid Gateway. It is recommended to keep a backup of the `$SPLEBASE/splapp/config.xml` file.

Create a new JMS Module

Log in to the Oracle Utilities Smart Grid Gateway Weblogic console and create a JMS Module with an appropriate name. Specify the following values for this JMS module:

- **Name:** the name of JMS module. For example, JMSModule-CM
- **Target:** the name of the target server where the Oracle Utilities Smart Grid Gateway application is running. This should be specified as myserver.

Create a Foreign JMS Server

Create a Foreign JMS server under the JMS module created in the above step. Specify the following values for this foreign JMS server:

- **Name:** Name of the foreign server. For example, JMSFAServer-CM
- **Target:** This should be specified as myserver
- **JNDI Initial Context Factory:** This should be specified as `weblogic.jndi.WLInitialContextFactory`
- **JNDI Connection URL:** The URL of the server where OSB is deployed. For example: `t3://osbserver:7001`
- **JNDI Properties Credential:** Password for the OSB server user

- **JNDI Properties:** The `java.naming.security.principal` additional property should be specified and set to the OSB server user. For example, `java.naming.security.principal=weblogic`

Create a Foreign Destination

Create a Foreign destination for each remote queue. Specify the following values for this foreign destination:

- **Name:** Name of foreign destination. For instance, `DestinationQueue-CM`
- **Local JNDI Name:** Local JNDI name for the foreign JMS queue. For example, `ForeignDestinationQueue-CM`
- **Remote JNDI Name:** JNDI name of the queue on the remote server. For example, `DestinationQueueWatch-CM`

Create a Remote Connection Factory

Create a remote connection factory for the foreign JMS server. Specify the following values for this remote connection factory:

- **Name:** Name of remote connection factory. For example, `DestinationQueueConnectionFactory-CM`
- **Local JNDI Name:** Local JNDI name for the Remote Connection Factory. For example, `ForeignDestinationQueueConnectionFactory-CM`
- **Remote JNDI Name:** JNDI name of the JMS Connection Factory on the remote server. For example, `weblogic.jms.XAConnectionFactory`

Message Driven Bean Configuration

Configuration of message driven beans (MDB) involved modifying the `ejb-jar.xml` and `weblogic-ejb-jar.xml` configuration files delivered with Oracle Utilities Smart Grid Gateway. It is recommended that instead of modifying these files directly you create "Customer Modification" (CM) versions of these files to make changes to these configuration files. This ensures that your modifications are not overwritten by future application patches.

The following section describes the changes required in the CM files for configuring the MDBs to read from the foreign JMS queues set up in the steps above. This requires creating the following files under `$$SPLEBASE/templates`:

- `cm_ejb-jar.xml.wls.jms_1.include`
- `cm_ejb-jar.xml.wls.jms_2.include`
- `cm_weblogic-ejb-jar.xml.jms.include`.

Note: After making these changes the `initialSetup` script needs to be run and Oracle Utilities Smart Grid Gateway application needs to be redeployed. However the `initialSetup` script will overwrite the JMS configuration changes made in the steps above. So it is recommended to keep a backup of the `$$SPLEBASE/splapp/config.xml` file before running this script.

Changes to `cm_ejb-jar.xml.wls.jms_1.include`

The following is an example of the `cm_ejb-jar.xml.wls.jms_1.include` file:

```
<message-driven>
  <description>MDB for DestinationQueue-CM</description>
  <display-name>DestinationQueueWatcher-CM</display-name>

  <ejb-name>DestinationQueueWatch-CM</ejb-name>

  <ejb-class>com.splwg.ejb.mdb.MessageProcessor</ejb-class>
  <messaging-type>javax.jms.MessageListener</messaging-type>
  <transaction-type>Bean</transaction-type>
  <message-destination-type>javax.jms.Queue</message-destination-type>
</message-driven>
```

The values specified in the above file include the following:

- **ejb-name:** This is the name of the MDB.

Changes to cm_ejb-jar.xml.wls.jms_2.include

The following is an example of the cm_ejb-jar.xml.wls.jms_2.include file:

```
<assembly-descriptor>
<security-role>
<role-name>cisusers</role-name>
</security-role>
<container-transaction>
<method>

    <ejb-name>DestinationQueueWatch-CM</ejb-name>

<method-name>onMessage</method-name>
</method>
<trans-attribute>NotSupported</trans-attribute>
</container-transaction>
</assembly-descriptor>
```

The values specified in the above file include the following:

- **ejb-name:** This is the name of the MDB

Changes to cm_ejb-jar.xml.wls.jms_2.include

The following is an example of the cm_weblogic-ejb-jar.xml.jms.include file:

```
<weblogic-enterprise-bean>
<ejb-name>DestinationQueueWatch-CM</ejb-name>

<message-driven-descriptor>
<pool>
<max-beans-in-free-pool>5</max-beans-in-free-pool>
<initial-beans-in-free-pool>1</initial-beans-in-free-pool>
</pool>

<destination-jndi-name>ForeignDestinationQueue-CM</destination-jndi-name>
<connection-factory-jndi-name>ForeignConnectionFactory-CM</connection- factory-jndi-name>

</message-driven-descriptor>
</weblogic-enterprise-bean>
```

The values specified in the above file include the following:

- **ejb-name:** This should be the name of the MDB as specified in.ejb-jar.xml
- **destination-jndi-name:** This should be the JNDI name of the foreign destination as provided in JMS module ' Foreign server ' Foreign destination ' Local JNDI name.
- **connection-factory-jndi-name:** This should be the JNDI name of the connection factory as provided in JMS module ' Foreign server ' Remote Connection Factory ' Local JNDI name.

Notification Queue Configuration

Payload statistics and payload summary records must be submitted sequentially in order for them to be processed correctly. To prevent them from being processed at the same time, you should set the number of notification queue polling threads to 1. Follow these steps to configure the number of notification queue threads:

1. Log in to the WebLogic Server Administration Console.
2. Under Helpful Tools, click **Configure Applications**.

3. Click on **Webservices**.
4. Click on the NotificationQueue link. for the EJB that you want to configure.
5. Go to the Configuration tab.
6. In the Change Center, click **Lock & Edit**.
7. Specify the new value of polling threads in **Max Beans in Free Pool**.
8. Click **Save**.
9. Click **Release Configuration**.
10. Restart the OUAF WebLogic instance.

Creating Application Links in External Applications

When integrating Oracle Utilities applications with other external applications, you can create links from external applications to specific portals and pages within the Oracle Utilities applications (also known as "deep linking"). These links typically leverage Business Process Assistant (BPA) scripts that direct the user to the appropriate target portal or page for a specific entity such as an account or service point. Refer to [Creating Application Links in External Applications](#) in the *Application Framework Administrative User Guide* for more information about creating links.

Note: When creating application links, the use of the following parameters will help speed up launching the target page

- **initNav=false**: skips launching the default home page for the user
- **minDashboard=true** minimizes the dashboard for the user

Go to Portal Script

The Framework provides a generic script (F1-GoToPrtl) that can be used to navigate to the maintenance portal for a specified maintenance object and entity. Refer to [Navigating to a Given Record's Maintenance Portal](#) in the *Application Framework Administrative User Guide* for more information about using this script.

Go To CCB Script

Oracle Utilities Customer Care and Billing includes the Go To CCB script (C1-GoToCCB) that can be used to navigate directly to a specific page on Control Central. This script uses the following syntax:

```
script=C1-GoToCCB&FLAG=<FLAG_VALUE>&PKVALUE1=<ID>
```

Where:

- **<FLAG_VALUE>**: A value from the C1_TARGET_PORTAL_FLG lookup that specifies which Control Central page to open.
- **<ID>**: The primary key value for the entity (such as a Account, Person, or Premise) you wish to view.

Examples:

Script	Flag Value	ID	Example
C1-GoToCCB	FLAG=C1CC (Control Central Account)	Account ID	script=C1-GoToCCB&FLAG=C1CC&PKVALUE1={your Account ID}
C1-GoToCCB	FLAG=C1CP (Control Central Person)	Person ID	script=C1-GoToCCB&FLAG=C1CP&PKVALUE1={your Person ID}

Script	Flag Value	ID	Example
C1-GoToCCB	FLAG=C1CR (Control Central Premise)	Premise ID	script=C1-GoToCCB&FLAG=C1CR&PKVALUE1={your Premise ID}

Full URL Example:

```
https://<ENV_BASE_URL>/ouaf/cis.jsp/?minDashboard=true&initNav=false&script=C1-GoToCCB&FLAG=C1CC&PKVALUE1={your Account ID}
```

Go To MDM Script

Oracle Utilities Meter Data Management includes the Go To MDM script (D1-GoToMDM) that can be used to navigate directly to a specific 360 Degree View tab. This script uses the following syntax:

```
script=D1-GoToMDM&FLAG=<FLAG_VALUE>&PKVALUE1=<ID>
```

where:

- **<FLAG_VALUE>**: A value from the DRILL_ENTITY_FLG lookup that specifies which 360 Degree View page to open.
- **<ID>**: The primary key value for the entity (such as a Device, Measuring Component, or Service Point) you wish to view.

Examples:

Script	Flag Value	ID	Example
D1-GotoMDM	FLAG=D1DV (360 View for Device)	Device ID	script=D1-GotoMDM&FLAG=D1DV&PKVALUE1={your Device ID}
D1-GotoMDM	FLAG=D1MC (360 View for Measuring Component)	Measuring Component ID	script=D1-GotoMDM&FLAG=D1MC&PKVALUE1={your Measuring Component ID}
D1-GotoMDM	FLAG=D1SP (360 View for Service Point)	Service Point ID	script=D1-GotoMDM&FLAG=D1SP&PKVALUE1={your Service Point ID}

Full URL Example:

```
https://<ENV_BASE_URL>/ouaf/cis.jsp/?minDashboard=true&initNav=false&script=D1-GotoMDM&FLAG=D1DV&PKVALUE1={your Device ID}
```

Defining Communications Options

Device Event Types

Understanding Device Event Types

Device Events

Device event types define properties common to specific types of events.

Device event types represent different types of events that can take place relative to a device. Examples of device events include power outages, power restoration, tampering alerts, and other events.

Device event types can be defined by the following attributes:

- **Standard Event Name:** the "standard" name of the event type. Device vendors may have their own specific names for device events. Only a single active device event type may be mapped to a given standard name at any time.
- **Device Event Category:** a category (defined as an Extendable Lookup) used to group device event types.
- **Reporting Category:** a category used to group device event types for reporting purposes.
- **Activity Type:** the activity type for activities created for device events of this type.

Device Event Mapping

The first step to device event type configuration is defining the list of standard event names that will be processed by the system. This is done by populating the Standard Event Name extendable lookup (D1-StdEventNameLookup). More information about this extendable lookup can be found in [About Device Events](#).

With the fully defined list of Standard Event Names each head-end specific event name (which is also called an external event name) that the system will receive from a given head-end should be mapped to a standard event name. This mapping is configured using a device event mapping extendable lookup. Each head-end system should have its own extendable lookup to define event name mapping in order to prevent possible conflicts between mappings. Each of these business objects should be defined as a child of the parent business object Device Event Mapping (D1-DeviceEventMappingLookup).

For example, head-end systems A and B might both use the same event name, such as the code "1", but this event might need to be mapped to "outage" for head-end system A but "tamper" for head-end system B.

The device event mapping extendable lookup business object is configurable. Each Oracle Utilities Smart Grid Gateway adapter includes a device event mapping lookup business object for the supported head-end system.

Lastly, each device event type is associated to a standard name. This means that as each device event that is received will go through the following mapping steps:

1. The head end specific event name is mapped to a standard event name using the head end specific device event mapping extendable lookup
2. The standard event name is mapped to a device event type
3. The device event type is used to select the appropriate device event business object

Device Event - Additional Processing

Certain device event business objects can be used to update master data as a result of device events received into the system. For example, when a utility's field worker arms a meter, the resulting device event can trigger an update to the device's arming status in the Oracle Utilities application. This processing is initiated by the Execute - Additional Processing system event

algorithm during the Additional Processing status of the business object's lifecycle.

The following base package business objects are configured to execute additional processing:

If a standard device event requires additional processing, the algorithms that execute the processing should be specified in the Additional Processing Algorithms list on the Standard Event Name extendable lookup for the event. The base package includes the additional processing algorithm Arm Meter (D1-ARM-METER).

Only a subset of base package device event business objects are configured to execute additional processing

Description	Business Object Name
Device Event Communication Response	D1-DeviceEventComResp

If additional processing is required for any business objects not listed above it can easily be added by configuring the algorithm Executer - Additional Processing System Event (D1-EXTADDPRC) in the Additional Processing status.

Reader Remarks

Reader remark types define properties common to specific types of reader remarks.

Reader remarks are a type of device event used to capture and/or record specific events or circumstances encountered when a meter reader is manually reading scalar meters. Reader remark types represent the different types of remarks that meter readers can record. Examples of reader remark types include evidence of tampering, broken seals, damaged meter, dog on premises, and other notices.

When creating a new device type there are the following options:

Name	Details	Business Object
Reader Remark Type	Provides the configuration for a reader remark type	D1-ReaderRemarkType

Field Activity Remarks

Field activity remark types define properties common to specific types of field activity remarks.

Field activity remarks are a type of device event used to capture and/or record specific events or circumstances encountered when a field worker is performing field work at a service point. Field activity remarks represent can represent situations that are found as well as actions that were taken in the field.

When creating a new device type there are the following options:

Name	Details	Business Object
Device Field Remark Type	Provides the configuration for a field activity remark type	D1-DeviceFieldRemarkType

Configuring Device Event Types

This portal is used to display and maintain a Device Event Type.

Refer to [Understanding Device Event Types](#) for more information.

You can access the portal by selecting **Admin**, then **Communication**, then **Device Event Type**.

The following zones may appear as part of the portal's **Main** tab page:

- **Device Event Type List:** This zone lists all Device Event Type records. Broadcast a record to display the details of the selected record.
- **Device Event Type:** This zone provides information about the selected Device Event Type.

Activity Types

Understanding Activity Types

Activities are records of a communication or event related to a device, measuring component, service point or other entity in the system. Examples of activities include smart meter command request, field activities, meter read downloads (for manually read meters) or the combined event of a "last gasp" and "power up" message sent by devices when they detects they experience an outage.

Each type of activity is assigned to an activity type category, please refer to [About Activities](#) for more information about the activity type categories supported by base product.

Activities Orchestrate Communication

Certain types of activities such as request orchestrators, field activities, and command requests coordinate a large number of child transactions that represent the communication to and from an external application. The below diagram depicts a two way communication with an external system:

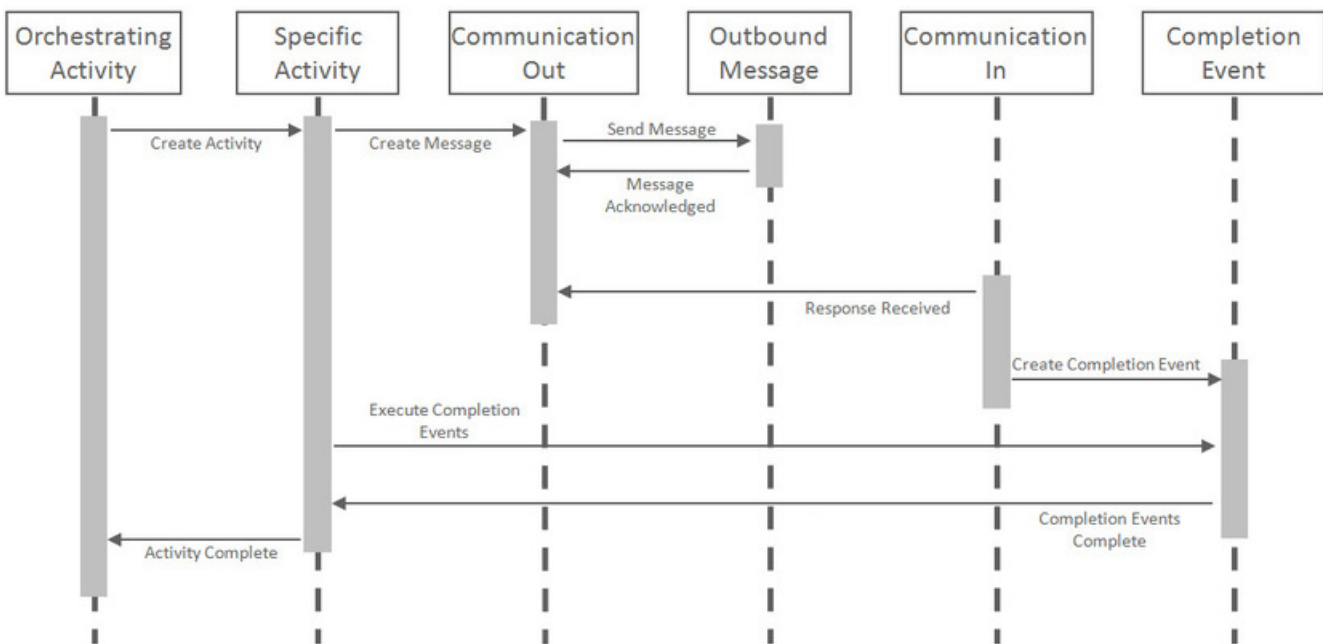

Each object in the sequence diagram has a distinct set of duties within the context of the communication:

- **Orchestrating Activity:** controls the overall intent of the communication. For example it may "Start Service" which would include initiating one-to-many specific activities to install the meter and begin the flow of the metered commodity to the service point.
- **Specific Activity:** can be initiated from an orchestrating activity or directly. These activities represent a single task to be carried out such as installing a meter or a remote disconnect smart meter command.
- **Communication Out:** orchestrates the communication to the external application and provides robust handling for any errors that might occur during that communication.
- **Outbound Message:** represents the message payload sent to the external system and the synchronous response.
- **Communication In:** orchestrates the handling of an asynchronous or unsolicited response from an external system.
- **Completion Event:** carries out the results of the communication. For example, in the case of a remote connect it would create the appropriate on off history entry for the device's installation event.

The below diagram involves many of the same objects but instead represents a one-way communication with an external system. All objects maintain the same duties described above with the addition of the communication out handling the synchronous response which contains the result of the message.

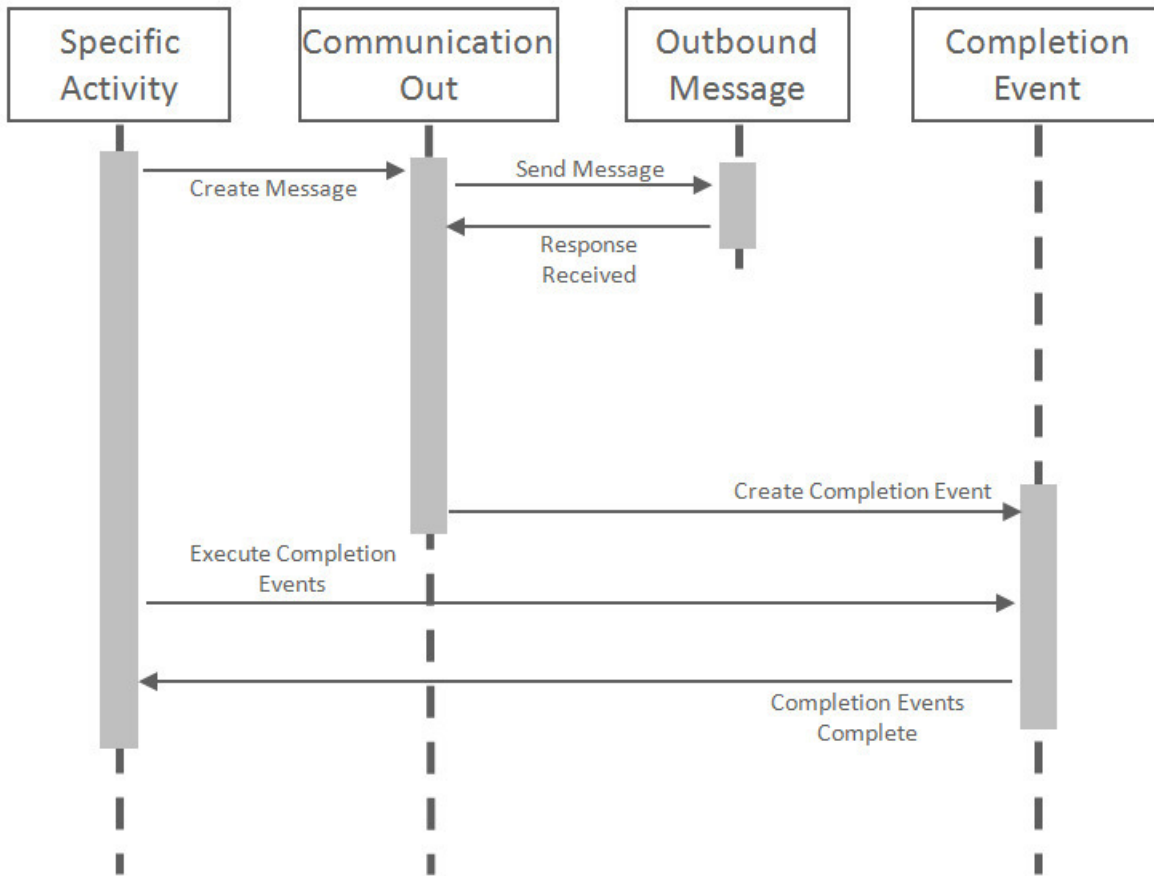

Important Activity Type System Events

The activity type supports several business object algorithm system events that relate to calculating the consumption for measuring components of that type:

- **Customer-Device Compatibility:** receives information about the activity being analyzed and returns an indication of whether the customer and device are compatible. This system event is primarily used in service order management. See algorithm type Ensure Device-Usage Calculation Group Compatibility (D2-ENSDVCCMP) as an example.
- **Override Device / Task:** receives information about the activity such as whether the device is installed at a service point, whether the service point is connected, where it is disconnected (if applicable), and the installation event status override. Based on those inputs it should determine the output device configuration type as well as the field activity business object and field task type. This system event is primarily used in service order management. See algorithm type Evaluate Smart Meter Opt-Out for Device Installation (D2-EVSMOPDV) as an example.

Service Order Activity and Service Order Field Activity Types and Divisions

Service order activity types and service order field activity types can specify a Division, to represent the specific operating company associated with activities of that type. If the **Restrict Division** setting in the **Control by Division** section in the MDM Master Configuration is set to "Yes", users can only access service order activities or service order field activities with a Division (or Divisions) associated with the user on the **User Miscellaneous Information** zone on the **Miscellaneous** tab of the **User** portal.

NOTE: In Oracle Utilities Customer to Meter, the **Control By CIS Division** setting on the **Main** tab on the **Installation Options** portal is used to restrict data access based on divisions.

See [Understanding Divisions](#) for more information about divisions.

Activity Type Maintenance Category

Activity types can be assigned an Activity Type Maintenance Category to specify that they should be maintained using the [SOM Activity Type](#) portal rather than the standard [Activity Type](#) portal. This option is used with the following categories of activity types:

- Field Activity Types
- Non-Dispatchable Activity Types
- Orchestration Maintenance Types
- Request Orchestration Types

Assigning activity types to the "Service Order Management Activity Type" Activity Type Maintenance Category is done via the Activity Type Maintenance Category business object option on the appropriate activity type business objects.

Configuring Activity Types

You use the **Activity Type** portal to view and maintain activity types.

Refer to [Understanding Activity Types](#) for more information.

You can access the portal by selecting **Admin, Communication, Activity Type**.

NOTE: If the **Restrict Division** setting in the **Control by Division** section in the MDM Master Configuration is set to "Yes", this zone displays only unsecured activity types as well activity types with a Division (or Divisions) associated with the user on the **User Miscellaneous Information** zone on the **Miscellaneous** tab of the **User** portal.

The following zones may appear as part of the portal's **Main** tab page:

- **Activity Type List:** This zone works differently than the typical zone that list types in that it displays both those activity types that have been configured as well as those activity types that have yet to be configured. Broadcast a record to display the details of the selected record.
- **Activity Type:** This zone provides information about the selected Activity Type
- **Field Task By Device Condition:** This zone is used to configure field tasks such as Turn On Device or Turn Off Device, based on the device condition. The configurations defined in this zone are used by the **SP State and Activity BO to Create** parameter for algorithms based on the [Update Device \(D1-UPDDVC\)](#) algorithm type. This allows the **SP State and Activity BO to Create** parameter to be defined more than the 20 times allowed on the algorithm. Note that configurations defined in this zone can also include **Service Point Type**.

NOTE: If the **Restrict Division** setting in the **Control by Division** section in the MDM Master Configuration is set to "Yes" , only service point types available to the user (based on division), and only field task types considered valid for the service point type can be defined in this zone.

- **Field Task By Service Point Condition:** This zone is used to configure field tasks such as "Install Device" or "Connect SP", based the service point condition. The configurations defined in this zone are used by the **SP State and Activity BO to Create** parameter for algorithms based on the [Create Specific Activity \(D1-CRSPACT\)](#) algorithm type. This allows the **SP State and Activity BO to Create** parameter to be defined more than the 20 times allowed on the algorithm. Note that configurations defined in this zone can also include **Service Point Type**.

NOTE: If the **Restrict Division** setting in the **Control by Division** section in the MDM Master Configuration is set to "Yes", only service point types available to the user (based on division), and only field task types considered valid for the service point type can be defined in this zone.

Configuring Service Order Management Activity Types

You use the **SOM Activity Type** portal to view and maintain activity types whose business object has the Activity Type Maintenance Category business object option set to DISO (Service Order Management Activity Type).

Refer to [Understanding Activity Types](#) for more information.

You can access the portal by selecting **Admin, Communication, SOM Activity Type**.

NOTE: If the **Restrict Division** setting in the **Control by Division** section in the MDM Master Configuration is set to "Yes", this zone displays only unsecured service order management activity types as well activity types with a Division (or Divisions) associated with the user on the **User Miscellaneous Information** zone on the **Miscellaneous** tab of the **User** portal.

The following zones may appear as part of the portal's **Main** tab page:

- **Activity Type List:** This zone works differently than the typical zone that list types in that it displays both those activity types that have been configured as well as those activity types that have yet to be configured. Broadcast a record to display the details of the selected record.
- **Activity Type:** This zone provides information about the selected Activity Type
- **Field Task By Device Condition:** This zone is used to configure field tasks such as Turn On Device or Turn Off Device, based on the device condition. The configurations defined in this zone are used by the **SP State and Activity BO to Create** parameter for algorithms based on the [Update Device \(D1-UPDDVC\)](#) algorithm type. This allows the **SP State and Activity BO to Create** parameter to be defined more than the 20 times allowed on the algorithm. Note that configurations defined in this zone can also include **Service Point Type**.

NOTE: If the **Restrict Division** setting in the **Control by Division** section in the MDM Master Configuration is set to "Yes", only service point types available to the user (based on division), and only field task types considered valid for the service point type can be defined in this zone.

- **Field Task By Service Point Condition:** This zone is used to configure field tasks such as "Install Device" or "Connect SP", based the service point condition. The configurations defined in this zone are used by the **SP State and Activity BO to Create** parameter for algorithms based on the [Create Specific Activity \(D1-CRSPACT\)](#) algorithm type. This allows the **SP State and Activity BO to Create** parameter to be defined more than the 20 times allowed on the algorithm. Note that configurations defined in this zone can also include **Service Point Type**.

NOTE: If the **Restrict Division** setting in the **Control by Division** section in the MDM Master Configuration is set to "Yes", only service point types available to the user (based on division), and only field task types considered valid for the service point type can be defined in this zone.

Communication Types

Understanding Communication Types

Communication types define properties common to a specific type of communication. This single admin object covers both communication in and communication out types.

Communication types include types of communications between an application and an external system such as a head-end system or the work management system. These are outbound communications such as smart meter command requests or field activities as well as inbound communications such as a message response that indicates the results of a request.

Communication types typically provide configuration around exception handling:

- **To Do Type and Role:** identifies the To Do to be created when an error is encountered
- **Retry Frequency:** defines how often the communication should be retried. As many errors can be due to connectivity the ability to retry provides automatic resolution.
- **Maximum Retries:** provides an upper limit to the number of times a communication can be re-attempted
- Each communication type can have its own unique set of fields, please refer to the embedded help for that communication type for more details on those fields.

Configuring Communication Types

This portal is used to display and maintain a Communication Type.

Refer to [Understanding Communication Types](#) for more information.

You can access the portal by selecting **Admin**, then **Communication**, then **Communication Type**.

The following zones may appear as part of the portal's **Main** tab page:

- **Communication Type List:** This zone works differently than the typical zone that list types in that it displays both those communication types that have been configured as well as those communication types that have yet to be configured. Broadcast a record to display the details of the selected record.
- **Communication Type:** This zone provides information about the selected Communication Type

Service Task Types

Understanding Service Task Types

Service tasks types define properties common to specific types of service tasks.

Service task types represent types of tasks that can be performed by users of other Oracle Utilities applications, such Oracle Utilities Customer Self Service or Oracle Utilities Network Management System. Examples of service tasks include self service meter reads, in which users enter their own meter reads via the Customer Self Service application, and service issue monitor types used when determining if service investigation is needed for a service point.

When creating a new record, the following options are available:

Name	Details	Business Object
Service Issue Monitor Type	The service issue monitor type defines the parameters for when a service investigative order should be created. It can also optionally define the completion parameters for that indicate the investigative order was successful in its purpose.	D1-ServiceIssueMonitorType

Self-Service Rate Compare Scenario Request Type	A simple description of a rate compare scenario request type.	D2-RateCompareScenarioRqstType
Self-Service Meter Read Task Type	Provides the default settings for meter reads created through self service.	D2-SSMeterReadTaskType

Configuring Service Task Types

This portal is used to display and maintain a Service Task Type.

Refer to [Understanding Service Task Types](#) for more information.

You can access the portal by selecting **Admin**, then **Customer**, then **Service Task Type**

The following zones may appear as part of the portal's **Main** tab page:

- **Service Task Type List:** This zone lists all Service Task Type records. Broadcast a record to display the details of the selected record.
- **Service Task Type:** This zone provides information about the selected Service Task Type.

Data Extracts

This section describes functionality that support extract and export of data for use in external applications and systems.

Configurable Consumption Extracts

Configurable Consumption Extracts are measurement data extracts for a set of usage subscriptions optionally related to a specific market participant.

Configuration options for these extracts include:

- Type of Market Participant, based on Service Point Market Participant or Usage Subscription Market Participant tables and market relationship
- Usage Subscriptions Types associated with the market participant (typically a customer information system receiving bill determinants)
- Unique combinations of unit of measure (UOM), time of use (TOU), and service quantity identifier (SQI) associated with the usage subscriptions
- Specific identifiers used to identify the usage subscriptions, service points, and devices associated with extracted measurement data
- Date and time parameters and frequency of extract
- Extract file naming and compression options

Consumption extracts are exported to a file in a specified file location, either on an application server (in an on-premises implementation) or an Oracle Cloud Infrastructure Object Storage location.

Consumption extracts are created via Consumption Extract Requests. See [Consumption Extract Requests](#) in the *Business User Guide*.

This section describes the configuration needed for these types of consumption extracts.

Consumption Extract Types

Configuration for consumption extracts are defined via a Consumption Extract Type. See [Consumption Extract Type](#) in the *Administrative User Guide* for more information about creating these records.

Configurable consumption extract types should be created using the Extract US Consumption to File (D1-ExtractUSConsumptionToFile) business object. Refer to the embedded help on this business object for more details about the parameters defined for consumption extract types.

Extract US Consumption to File consumption extract types define the following parameters:

- The market participants for which measurement data will be extracted. You define market participants based on their type (Service Point Market Participant or Usage Subscription Market Participant) and market relationship type (retailer, distributor, supplier, and so on), and a specific market participant. Note: If Market Participant Specific is set to "No", the market participant used is based on the Usage Recipient on the Usage Subscription or its Usage Subscription Type.
- The consumption type (interval or scalar)
- One or more Usage Subscription Types and a related unique UOM/TOU/SQI combination
- The specific ID types to include in the extract file for the Usage Subscription, Service Point, child Service Point (if applicable), and Device
- Execution parameters, including:
 - The date and time through which data has been extracted for this consumption extract type
 - A Request Type. Request types used with consumption requests should be created using the Consumption Extract Request Type (D2-IntervalDataExtRepoType) business object, and should reference the Consumption Extract (D2-IntervalDataExtRepository) business object in the **Request Business Object** field. (see [The Big Picture of Requests](#) in the *Application Framework Administrative User Guide*)
 - The frequency of extracts for this type (ad hoc or daily)
 - Batch controls used for the extract process (see **Batch Controls** below)
- File parameters, including:
 - The file location where extract files will be saved (see [External File Storage](#) in the *Application Framework Administrative User Guide*)
 - An optional child folder in the file location
 - File naming options (including an optional prefix and date/time stamp)
 - Whether or not to compress the extract file (file compression is performed using gzip)

Batch Controls

The data extract process and creation of export files is performed by the following batch controls:

- **Extract Current US Intervals to File (D1-ECUSI)**: Used for daily extracts of interval consumption. This process requires that Interval Snapshot Mapping data be generated for any of the interval sizes being extracted. This aids in the efficiency of transposing the interval data into daily interval columns. (see [Interval Snapshot Mapping](#) for more information).
- **Extract Replacement US Intervals to File (D1-ERUSI)**: Used for extracts of replacement historical interval consumption. This process runs against Change Data Capture records in the General Process table (see **Initial Measurement Subsequent Correction Change Data Capture** below).
- **Extract Current US Scalar Reads to File (D1-ECUSS)**: Used for daily extracts of scalar consumption.
- **Extract Replacement US Scalar Reads to File (D1-ERUSI)**: Used for extracts of replacement scalar interval consumption. This process runs against Change Data Capture records in the General Process table (see **Initial Measurement Subsequent Correction Change Data Capture** below).

These batch controls are run for a specific Consumption Extract Type and date range. Batch processing is threaded by on Usage Subscription ID.

Refer to [Consumption Extract Requests - Batch Controls](#) in the **Defining DataConnect Options** section of the **Integrations** chapter for general information about consumption extract batch processing,

Initial Measurement Subsequent Correction Change Data Capture

The follow algorithms maintain measuring component date/times based on the latest measurement date time for the measuring component. These algorithms also check for a Consumption Extract Type that applies to the current initial measurement's measuring component and identifies whether the initial measurement is for a date/time that has already been extracted.

Algorithm	Description	Consumption Type
D1-UPD-DTMC	Update Latest Measurement Date/Time on MC with Consumption Sync	Interval
D1-UDTSCMCRE	Update Latest Measurement Date/Time on Scalar MC with Consumption Sync	Scalar
D1-UPD-DTMCF	Update Latest Date/Time on MC from a Future Measurement	Interval
D1-UPDDTSCMC	Update Latest Date/Time on Scalar Measuring Component	Scalar

If an initial measurement is for a date/time that has already been extracted, these algorithms create Change Data Capture records in the General Process table that capture the batch code, batch run number, and the initial measurement's ID. The "Replacement" batch processes run off of these records.

Note that the following parameter must be set to "true" on the above algorithms to enable historical change data capture:

- Capture CET Historical Measurement Changes: true

File Format - Interval

The interval extract process produces JavaScript Object Notation (JSON) files with the extract data described in the following table.

Note that interval extract files can store up to a maximum of 300 intervals. This means that export files can store approximately:

- 12.5 days worth of hourly data
- 3 days worth of 15 minute data
- 1 day worth of 5 minute data

Field	Sample Value	Comments
usId	995647003500	Usage Subscription ID defined by the Consumption Extract Type
usType	E-RES	Usage Subscription type
pSpld	458081	Parent Service Point ID, Null when there is no parent service point.
spld	458081_001	Child Service Point ID This is the Service Point ID defined by the Consumption Extract Type
dvclD	SN823287793219	Device ID defined by the Consumption Extract Type
uomTouSql	KWH//	UOM / TOU / SQL, separated by forward slashes ("/")
tz	US/Eastern	Time zone of the service point.

Field	Sample Value	Comments
		This is the time zone name from the CI_TIME_ZONE table not the time zone code.
intPerDay	288	Number of Intervals for the day, will be 1 hour less or 1 hour more of intervals for DST transitions
intSize	300	Length of each interval in seconds
mktPart	DIRECT_ENERGY	Market Participant ID of the market participant (if applicable)
stDtm	2020-01-01T00:00:00-05:00	Start of the day, similar to initial measurement, this represents the start of the first interval.
q1	1.325	Measurement Value for the first interval, the measurement date/time for this interval would be the stDtm plus the intSize
c1	301000	Measurement Condition for the first interval. Null when "Regular" (501000)
q2	1.230	
c2	301000	
...	q/c 3 through 299 here	
q300	.9134	
c300	30100	

Example:

```
{ "usId": "995647003500", "usType": "E-RES", "pSpId": "458081", "spId": "458081_001", "dvcId": "SN823287793219", "uomTouSqi": "KWH//", "tz": "US/Eastern", "intPerDay": "288", "intSize": "300", "mktPart": "DIRECT_ENERGY", "stDtm": "2020-01-01T00:00:00-05:00", "q1": "1.325", "c1": "301000", "q2": "1.325", "c2": "301000", "q3": "1.325", "c3": "301000", <intervening intervals>, "q300": "1.325", "c300": "301000" }
```

File Format - Scalar

The scalar extract process produces JavaScript Object Notation (JSON) files with the extract data described in the following table.

Name	Sample Value	Comments
c	301000	Measurement Condition for the scalar reading Null when "Regular" (501000)
dvclId	SN823287793219	Device ID defined by the Consumption Extract Type
enDtm	2020-01-02T00:00:00-05:00	End date/time of the reading
mktPart	DIRECT_ENERGY	Market Participant ID of the market participant (if applicable)
pSpId	458081	
q	1.325	Measurement Value for scalar reading
r	678645	Dial reading of the meter

Name	Sample Value	Comments
spld	458081_001	Service Point ID defined by the Consumption Extract Type
stDttm	2020-01-01T00:00:00-05:00	Start date/time of the reading (the End Date/ Time of the previous reading)
tz	US/Eastern	Time zone of the service point. This is the time zone name from the CI_TIME_ZONE table not the time zone code.
uomTouSqi	KWH//	UOM / TOU / SQL, separated by forward slashes ("/")
usld	995647003500	Usage Subscription ID defined by the Consumption Extract Type
usType	E-RES	Usage subscription type

Example (3 records):

```
{ "usId": "995647003500", "usType": "E-RES", "pSpId": "458081", "spId": "458081_001", "dvcId": "SN823287793219", "uomTouSqi": "KWH//", "tz": "US/Eastern", "mktPart": "DIRECT_ENERGY", "stDttm": "2020-01-01T00:00:00-05:00", "enDttm": "2020-01-02T00:00:00-05:00", "q": "1.325", "c": "301000", "r": "678645" }
{ "usId": "995647003500", "usType": "E-RES", "pSpId": "458081", "spId": "458081_001", "dvcId": "SN823287793219", "uomTouSqi": "KWH//", "tz": "US/Eastern", "mktPart": "DIRECT_ENERGY", "stDttm": "2020-01-01T00:00:00-05:00", "enDttm": "2020-01-02T00:00:00-05:00", "q": "1.325", "c": "301000", "r": "678645" }
{ "usId": "995647003500", "usType": "E-RES", "pSpId": "458081", "spId": "458081_001", "dvcId": "SN823287793219", "uomTouSqi": "KWH//", "tz": "US/Eastern", "mktPart": "DIRECT_ENERGY", "stDttm": "2020-01-01T00:00:00-05:00", "enDttm": "2020-01-02T00:00:00-05:00", "q": "1.325", "c": "301000", "r": "678645" }
```

Extending Extract Processing

Some implementations may wish to extend and/or customize the extract process based on specific requirements.

Extending List of IDs To Use

Consumption Extract Types define specific types of IDs to use for Usage Subscriptions, Service Points, child Service Points (if applicable), and Devices. If an implementation wishes to extend the types of IDs available, they need to add appropriate values to the lookup flags used by each of ID type. The table below lists the lookup codes used by the "IDs to Use" fields.

ID Type	Lookup Flag
Usage Subscription ID	Usage Subscription Identifier Type (US_ID_TYPE_FLG)
Service Point ID (used for both parent and child service points)	Service Point Identifier Type (SP_ID_TYPE_FLG)
Device ID	Device Identifier Type (DVC_ID_TYPE_FLG)

Processing Records and Creating Output Files

The extract process leverages the generic [Plug-in Driven Background Processes](#) functionality but works in a slightly different manner. Instead of using the Select Records algorithm to retrieve the IDs of the individual records to be processed, that algorithm returns a range of Usage Subscription IDs to be extracted and the Process Records algorithm performs the detailed query to extract the range of Usage Subscription IDs.

This provides two benefits:

1. There is no limitation on the length of the query in the Process Records algorithm.
2. Retrieving data for many Usage Subscriptions at a single time is significantly more efficient.

This means that any required customization can be achieved by creating a new custom (CM) batch control and duplicating the Process Records Groovy script. Changes can be made within the custom Groovy script to the extraction SQL to retrieve additional information or provide additional selection criteria. If any changes are needed to the file format that can be done within the record processing logic that populates the file.

NOTE: The Process Records scripts include a number of steps each containing specific processing logic and SQL based on the configuration of the Market Participants on the Consumption Extract Type as well as whether or not the specified UOMs measure peak quantities or not. Be sure to edit each of these steps as appropriate when creating customized versions of these scripts.

Maintenance Object Data Export

This section describes the process by which data can be exported from maintenance objects used with Oracle Utilities Customer Cloud Service and Oracle Utilities Meter Solution Cloud Service for use in external applications and systems.

This section provides details regarding how the data export process is used with specific maintenance objects. See [Data Export](#) in the *Application Framework Administrative User Guide* for a general description of the data export process.

Enabling Maintenance Objects for Generalized Data Export

Export of data from most maintenance objects is supported via "Generalized" export. See [Generalized Data Export](#) in the *Application Framework Administrative User Guide* for more information about generalized data export.

Data Export Control Records

Data export from a maintenance object requires a Data Export Control record configured for that maintenance object. See **Enabling Data Export** in [Generalized Data Export](#) in the *Application Framework Administrative User Guide* for more information.

Change Data Capture for Measuring Components and Usage Subscriptions

For most maintenance objects, changes are tracked via the Capture Change for Ongoing Export audit algorithm (F1-MO-REGCHN).

Measuring Components and Usage Subscriptions use a "Most Recent" date field to track related transactions (Initial Measurements and Measurements in the case of Measuring Components and Usage Transactions in the case of Usage Subscriptions). These "Most Recent" fields are updated with each new initial measurement or usage transaction created by the system.

In order to prevent the Change Data Capture process from capturing changes based on these frequent transactions (daily for measurements and monthly for usage transactions), the Capture Change for Ongoing Export audit algorithm has been disabled on the Measuring Component and Usage Subscription maintenance objects.

Enabling change data capture and generalized data export for these maintenance objects requires adding the "Generalized Data Export BO Change Data Capture" (D1-BO-REGCHN) Audit algorithm to the appropriate Measuring Component and Usage Subscription business objects. This algorithm creates records in the Data Export Update table used by the generalized export process.

Measurement Data Export

Export of data from the Measurement maintenance object is supported via "Specialized" export. See [Specialized Data Export](#) in the *Application Framework Administrative User Guide* for more information about specialized data export.

The Measurement maintenance object is configured to support data export via the following options:

Option Type	Option Value
Data Export Class	F1SE (Specialized)
Export Batch Control	D1-SMDEC (Specialized Measurement Data Extract Current)

Initial vs. Current vs. Historical Extract

There are three types of extracts used with the Measurement maintenance object:

- **Initial Extracts** gather an initial extract of measurement data, controlled by providing a start and end date time of the measurements that should be extracted. This process should be used to perform the initial extract of the measurement data prior to using the daily current and daily historical extracts.
- **Daily Current Extracts** gather measurement data for measurements within the last 30 days that have been either added or changed. This extract is based on the **Measurement Date/Time** and **Last Update Timestamp** fields on the Measurement table, as well as the **Export Through Date/Time** field on the Data Export Control record (see below) to include only changes since the last extract.
- **Daily Historical Extracts** gather measurement data for measurements older than the last 30 days that have either been added or changed. To avoid having to scan the entire Measurement table, this extract is based on Change Data Capture. During initial measurement data processing if an initial measurement has measurements that are older than 30 days, then a Change Data Capture record is created in the General Process table.

Enabling historical change data capture requires configuration of the following algorithm parameters:

- Capture Historical Measurement Changes: true
- Historical Measurement Data Extract Batch Control: D1-SMDEH (Specialized Measurement Data Extract Historical)

These parameters should be configured as described on the following algorithms:

- Update Latest Measurement Date/Time on MC with Consumption Sync (D1-UPD-DTMC)
- Update Latest Measurement Date/Time on Scalar MC with Consumption Sync (D1-UDTSCMCRE)
- Update Latest Date/Time on MC from a Future Measurement (D1-UPD-DTMCF)
- Update Latest Date/Time on Scalar Measuring Component (D1-UPDDTSCMC)
- Re-derive other values (D1-REDEROVAL)

NOTE: This use of Change Data Capture is an exception to the general rule described in the [Specialized Data Export](#) section of the *Application Framework Administrative User Guide*.

Data Export Control Records

Data export from the Measurement maintenance object requires a Data Export Control record. This record designates that the Measurement maintenance object should be exported, and tracks the date and time through which data has been exported so far, allowing subsequent export processes to only export incremental changes.

See [Defining Data Export Control](#) in the *Application Framework Administrative User Guide* for more information about creating Data Export Control records.

Batch Controls

Export of data and creation of export files is performed by the following batch controls:

- **Specialized Measurement Initial Extract (D1-SMDIE)**: Used for initial extract of measurement data. Unlike the current extract this batch is controlled directly by providing a start and end date time of the measurements that should be extracted. This process should be used to perform the initial extract of the measurement data prior to using the current extract (D1-SMDEC) and the historical extract (D1-SMDEH). For best performance it is recommended to break up the initial extract period into multiple smaller periods and to use multiple threads for each period. The extract will retrieve all measurements with a measurement date/time that is greater than the input start date/time and less than or equal to the input end date/time.
- **Specialized Measurement Data Extract Current (D1-SMDEC)**: Used for daily extracts of current (new) measurement data. This process extracts data that has changed since the last extract process has run (based on the **Export Through Date/Time** field on the Data Export Control record. This process updates the **Export Through Date/Time** field at the start of batch processing to eliminate the possibility of not setting an initial measurement as historical by Change Data Capture during the processing window.
- **Specialized Measurement Data Extract Historical (D1-SMDEH)**: Used for daily extracts of historical measurement data. This process runs against Change Data Capture records in the General Process table.

Batch processing is threaded by on Measuring Component ID, and creates one or more files based on the number of threads processed and batch control parameters.

File Creation and Naming

The extract process uses two controls to determine the number of files to be created:

1. Each thread will create at least 1 file (more threads result in smaller files).
2. The **File Size Limit** parameter can be used to specify set the number of measurement rows to include in any given file. This can result in a single thread producing multiple files.

The data in each file is not ordered, each thread will retrieve measurement data for a set of Measuring Component IDs, but beyond that there will be no control for how the data is loaded into the file.

File Naming

Since each thread can produce multiple files and the number of files per thread cannot be predicted the file names will also include an indicator for the first file in a thread and the last file in a thread.

- MSRMT_EXPORT_<file prefix batch parameter>_<batch number>_<batch thread number>_<total thread count>_<thread file indicator>_<process date time>.csv.gz

where:

- <file prefix batch parameter> is an optional file prefix defined using the **File Name Prefix** batch control parameter
- <batch number> is the batch number for the process
- <batch thread number> is the thread number that created the file
- <total thread count> is the total number of threads
- <thread file indicator>: is an identified for the first and last files created by a thread, S for first file E for last file
- <process date time> is the date and time at which the file was created, in YYYYMMDDhhmmss format (YYYY = year, MM = month, DD = day, hh = hour, mm = minute, ss = second)

Examples: For batch number 135, comprising 10 threads:

- First file of 3rd out of 10 threads: MSRMT_EXPORT_PREFIX_135_3_10_S_20191104173233.csv.gz
- All files before the last file of 3rd out of 10 threads: MSRMT_EXPORT_PREFIX_135_3_10_20191104173233.csv.gz

- Last file of 3rd out of 10 threads: MSRMT_EXPORT_PREFIX_135_3_10_E_20191104173233.csv.gz

File Format

The extract process produces comma separated values (CSV) files with the data described in the following table. The field names in the **Field** column are included in the output file as a header row if the **Include Header** parameter on the batch controls is set to "Y".

NOTE: All date/times will be converted from OUAUF format to the appropriate ISO format in UTC with the time zone provided (as "Z").

Field	Data Type	Sample Content	Description	Applicability		
				Interval	Scalar	Subtractive Interval
MEASR_COMP_ID	CHAR(12)	000004769213	Primary Key of Channel from Meter (aka Device)	X	X	X
MSRMT_DTTM	DATE	2019-01-01T00:00:00Z	End of the time period the measurement covers. For example, if this were an hourly interval it would cover 2018-12-31T23:00:00Z to 2019-01-01T00:00:00Z.	X	X	X
PREV_MSRMT_DTTM	DATE	2018-12-31T00:00:00Z	For scalar measurements this identifies the start of the period being measured. Note: there should be another measurement for the same MC with this date as the MSRMT_DTTM.		X	
MSRMT_COND_FLG	CHAR(6)	501000	Defines the quality of the measurement (e.g. estimated, regular, super). Valid values defined on F1_EXTENDABLE_LOOKUP_VAL for the BUS_	X	X	X

Field	Data Type	Sample Content	Description	Applicability		
				Interval	Scalar	Subtractive Interval
			OBJ_CD D1-MeasurementConditionLookup.			
MSRMT_USE_FLG	CHAR(4)	D101	Indicates whether the measurement is usable. Valid values defined on CI_LOOKUP.		X	
USER_EDITED_FLG	CHAR(4)	D1UE	Indicates whether the user has edited the measurement. Valid values defined on CI_LOOKUP.	X	X	X
READING_VAL	NUMBER(16,6)	750000000	This is the Dial Reading which is used to calculate the consumed amount.		X	X
READING_COND_FLG	CHAR(6)	501000	Defines the quality of the Daily Reading (e.g. estimated, regular, super). Valid values defined on F1_EXTENDABLE_LOOKUP_VAL for the BUS_OBJ_CD D1-MeasurementConditionLookup.			X
COMBINED_MULTIPLIER	NUMBER(18,6)	1	Contains the product of the Measuring Component Multiplier and the Installation Constant. The MSRMT_VAL will have been multiplied by this number.	X	X	X
MSRMT_VAL	NUMBER(16,6)	1.23	This is the consumption reported from the meter after going	X	X	X

Batch Controls

Export of data and creation of export files is performed by the following batch controls:

- **Specialized IMD Header Initial Extract (D1-SIMDI)**: Used for initial extract of initial measurement data. Unlike the current extract this batch is controlled directly by providing a start and end date time of the IMD headers that should be extracted. This process should be used to perform the initial extract of the IMD header data prior to using the current extract (D1-SIMDC) and the historical extract (D1-SIMDH). For best performance it is recommended to break up the initial extract period into multiple smaller periods and to use multiple threads for each period. The extract will retrieve all IMD headers with a IMD to date/time that is greater than the input start date/time and less than or equal to the input end date/time.
- **Specialized IMD Header Data Extract - Current (D1-SIMDC)**: Used for daily extracts of current (new) initial measurement data. This process extracts data that has changed since the last extract process has run (based on the **Export Through Date/Time** field on the Data Export Control record). This process updates the **Export Through Date/Time** field at the start of batch processing to eliminate the possibility of not setting an initial measurement as historical by Change Data Capture during the processing window.
- **Specialized IMD Header Extract - Historical (D1-SMDEH)**: Used for daily extracts of historical initial measurement data. This process runs against Change Data Capture records in the General Process table.

Batch processing is threaded by on Initial Measurement Data ID, and creates one or more files based on the number of threads processed and batch control parameters.

File Creation and Naming

The extract process uses two controls to determine the number of files to be created:

1. Each thread will create at least 1 file (more threads result in smaller files)
2. The **File Size Limit** parameter can be used to specify set the number of initial measurement data rows to include in any given file. This can result in a single thread producing multiple files.

The data in each file is not ordered, each thread will retrieve initial measurement data for a set of Initial Measurement Data IDs, but beyond that there will be no control for how the data is loaded into the file.

File Naming

Since each thread can produce multiple files and the number of files per thread cannot be predicted the file names will also include an indicator for the first file in a thread and the last file in a thread.

- `IMD_EXPORT_<file prefix batch parameter>_<batch number>_<batch thread number>_<total thread count>_<file number>_<last file indicator>_<process date>.csv.gz`

where:

- `<file prefix batch parameter>` is an optional file prefix defined using the **File Name Prefix** batch control parameter
- `<batch number>` is the batch number for the process
- `<batch thread number>` is the thread number that created the file
- `<total thread count>` is the total number of threads
- `<file number>` is the number of the file
- `<last file indicator>`: identifies the last files created by a thread (E)
- `<process date time>` is the date and time at which the file was created, in YYYYMMDDhhmmss format (YYYY = year, MM = month, DD = day, hh = hour, mm = minute, ss = second)

Examples: For batch number 135, comprising 10 threads:

- First file of 3rd out of 10 threads: `IMD_EXPORT_SOME_PREFIX_135_3_10_1_20191104173233.csv.gz`

- All files before the last file of 3rd out of 10 threads: IMD_EXPORT_SOME_PREFIX_135_3_10_2_20191104173233.csv.gz
- Last file of 3rd out of 10 threads: IMD_EXPORT_SOME_PREFIX_135_3_10_E_20191104173233.csv.gz

File Format

The extract process produces comma separated values (CSV) files with the data described in the following table. The field names in the **Field** column are included in the output file as a header row if the **Include Header** parameter on the batch controls is set to “Y”.

NOTE: All date/times will be converted from OUAUF format to the appropriate ISO format in UTC with the time zone provided (as "Z").

Field	Data Type	Sample Content	Description	Applicability		
				Interval	Scalar	Subtractive Interval
INIT_MSRMT_DATA_ID	CHAR(12)	52482245116604	Primary Key of the initial measurement	X	X	X
MEASR_COMP_ID	CHAR(12)	000004769213	Primary Key of the measuring component for the initial measurement	X	X	X
IMD_EXT_ID	CHAR(12)	external_file	External ID for the initial measurement. Usually the name of the file that the initial measurement data was received in.	X	X	X
BUS_OBJ_CD	CHAR(12)	D1-ManualIMDInterval	The business object that governs the initial measurement	X	X	X
BO_STATUS_CD	VARCHAR(30)	COMPLETED	The status of the initial measurement	X	X	X
BO_STATUS_REASON_CD	VARCHAR(30)	FORCE COMPLETE	A reason code for the status. Generally populated when there was a VEE exception that was overridden and the initial measurement was completed	X	X	X

Field	Data Type	Sample Content	Description	Applicability		
				Interval	Scalar	Subtractive Interval
			without fixing the error.			
D1_FROM_DTTM	DATE/TIME	2019-01-01T00:00:00Z	<p>Start of the time period the initial measurement covers.</p> <p>For subtractive scalar data this represents the prior measurement that will be used as the start reading when calculating consumption.</p> <p>For interval data this represents the start of the first interval for the initial measurement.</p> <p>Note: no measurements will be created for this date/time as MDM represents intervals as the end of the interval. So the first interval of the initial measurement will be this date/time plus the interval size (e.g. if the interval size is 15 minutes then the first interval would be 15 minutes after this date/time).</p>	X	X	X
D1_TO_DTTM	DATE/TIME	2019-01-02T00:00:00Z	<p>End of the time period the initial measurement covers.</p> <p>For scalar data this date/time</p>	X	X	X

Field	Data Type	Sample Content	Description	Applicability		
				Interval	Scalar	Subtractive Interval
			will match the measurement. For interval data this will match the date/time of the last interval measurement.			
CRE_DTTM	DATE/TIME	2019-01-03T00:00:00Z	Date and time when the initial measurement was initially created	X	X	X
STATUS_UPD_DTTM	DATE/TIME	2019-01-03T00:00:00Z	Date and time when the initial measurement's status was last updated	X	X	X
LAST_UPDATE_DTTM	DATE/TIME	2019-01-03T00:00:00Z	Date and time when the initial measurement was last updated. Note: updates can happen outside of a status change so this can be more recent than the STATUS_UPD_DTTM.	X	X	X

Sample File

The following is a sample export file containing initial measurement header records. Note that this does not include labels or column headers, but the data is in the same order as the column descriptions above in the **File Format** section above.

```
55394295586154,553275345711,external file1,D1-
ManualIMDScalar,ERROR,,2020-01-02T08:00:00Z,2022-01-01T08:00:00Z,2020-08-17T18:47:41Z,2020-08-17T18:47:41Z,20
55392270285377,553886220134,external file2,D1-
ManualIMDInterval,ERROR,,2022-01-01T08:00:00Z,2022-01-02T08:00:00Z,2020-08-15T04:18:43Z,2020-08-15T04:25:57Z,
55383485376359,553886220134,external file3,D1-
ManualIMDInterval,ERROR,,2022-01-01T08:00:00Z,2022-01-02T08:00:00Z,2020-08-15T04:47:36Z,2020-08-15T04:55:03Z,
```

Consumption Extract Type

Understanding Consumption Extract Type

The Consumption Extract Type controls which service point's measurements are extracted for Oracle Utilities DataConnect, what type of measurement is extracted, and how the measurements are grouped into TOU periods (if preferred).

The Consumption Extract Type also controls the request type used for creating Consumption Extract Requests of this type, how frequent automated requests are created for incremental extract, the batch jobs that are triggered for extracting data and the algorithms that extract, format, and write the data that is extracted.

Refer to the [Oracle Utilities DataConnect](#) integration section for more details on how this object is specifically put into use.

Configuring Consumption Extract Type

This portal is used to display and maintain a Consumption Extract Type.

Refer to [Understanding Consumption Extract Types](#) for more information.

You can access the portal by selecting **Admin**, then **Integration**, then **Consumption Extract Type**.

The following zones may appear as part of the portal's **Main** tab page:

- **Consumption Extract Type List:** displays all of the Consumption Extract Types so you can choose the one you want to display in more detail
- **Consumption Extract Type:** shows the specific configuration for the selected Consumption Extract Type

Analytics Configuration

This portal provides a bird's eye view of the configuration information for Oracle Utilities Analytics. It provides links and guidelines for the areas that need configuration to successfully run the extract transfer and load processes from Oracle Utilities Analytics.

Refer to the *Oracle Utilities Analytics Administration Guide* for more information.

You can access the portal from the **Admin > Analytics Configuration > Customer Analytics Configuration**

The following zones may appear as part of the portal's **Main** tab page

- **Bucket Configuration List.** This zone lists bucket configurations to set up.
- **BI-Related Business Objects Information.** This zone lists additional control entities to set up.

The following zones may appear as part of the portal's **OWB-Based ETL** tab page

- **Outbound Sync BOs and Algorithm List.** This zone lists business objects and algorithms involved in the extract process.
- **BI-Oriented Extendable Lookup.** This zone lists extendable lookups to set.
- **External Data Source Indicators List.** This zone lists the external identifiers of the various sources for your analytics data.

Note: Service Point business objects can make use of the following System Events:

- **Service Point Snapshot:** This system event defines the algorithm used to create a snapshot of the Service Point for use with Oracle Utilities Analytics. The Algorithm Entity for available algorithms is "SP (BO) - Snapshot."
- **Usage Snapshot:** This system event defines the algorithm used to create a usage snapshot of the Service Point for use with Oracle Utilities Analytics. The Algorithm Entity for available algorithms is "SP (BO) - Usage Snapshot."

- **Unreported Usage Analysis Snapshot:** This system event defines the algorithm used to create a snapshot of the Service Point's consumption since the last usage transaction for use with Oracle Utilities Analytics. The Algorithm Entity for available algorithms is "SP (BO) - Unreported Usage Analysis Snapshot."
- **SP VEE Exception Snapshot:** This system event defines the algorithm used to create a snapshot of VEE exceptions for the Service Point for use with Oracle Utilities Analytics. The Algorithm Entity for available algorithms is "SP (BO) - VEE Exception Snapshot."

Aggregation

Standard Aggregation

Configuring an Out-of-the-box Aggregation

Aggregation calculations should be run on an as needed basis. This can include running the following batch processes:

- Scanning for new aggregation dimension (D1-ADS): This process is applicable if the system is configured to use aggregation dimension scanners to detect new aggregation dimensions (such as a service point referencing a new transformer for which an aggregator measuring component doesn't currently exist)
- Performing aggregation calculations (D2-AGG): this batch handles the summarization of measurement values in order to create aggregated measurements.

Note that aggregation calculations should precede usage transaction processing if aggregated values serves as input to the calculation of bill determinants.

Refer to the [About Aggregations](#) section of the *Oracle Utilities Meter Solution Business User Guide* for more information on this functionality. Refer to [Understanding Measuring Component Types](#) for information on Measuring Component Types provided for aggregation.

Understanding an Example Out-of-the-box Aggregation

The Oracle Utilities Meter Data Management base package includes an aggregation that aggregates measurement quantities for constituent measuring components based on postal code and service type dimensions. The table below outlines the types of objects used in this aggregation, based on the steps outlined above), and the specific objects for each type.

Dependency Order	Object Type	Base Package Example
1	Aggregator Measuring Component Business Object	D2-Aggregator (Aggregator - Postal and Service Type)
2	Aggregator Measuring Component UI Maps	Display: D2-AggMCDisp (Service Type and Postal Aggregator-Display) Maintenance: D2-AggMCMaint (Service Type and Postal Aggregator-Maintenance)
3	Aggregator Business Object Info Algorithm	D2-AMC-INFO (Service Type and Postal Aggregator - Information)
4	Find Constituent Measuring Components Algorithm	D2-DET-CMC (Find Constituent Measuring Components Based on Service Type and Postal)
5	Measuring Component Type	D2-AggregatorType (Aggregator Type)
6	Query Zone for Consumption Statistics Portal	D2-AGGMCQRY (Aggregator Search)
7	Dimension Scanner Activity Business Object	D2-ActivityAggDimScanner (Aggregator Creator - Postal / Service Type)

8	Dimension Scanner Activity UI Maps	Display: D2-AggDimScannerActDisp (Aggregator DS Activity-Display) Maintenance: D2- AggDimScannerActMaint (Aggregator DS Activity-Maintenance)
9	Dimension Scanner Activity Business Object Info Algorithm	D2-ADS-INFO (Aggregator Dimension Scanner Information)
10	Enter Algorithm for Scan State	D2-CRE-AGGMC (Aggregator MC Creation for Post Code and Service Type)
11	Activity Type	D2-ActivityTypeAggDimScanner (Aggregator Dimension Scanner Activity Type)

Refer to the [About Aggregations](#) section of the *Oracle Utilities Meter Solution Business User Guide* for more functional information.

Creating a New Custom Aggregation

This section describes the overall process for creating a new custom Aggregation.

Refer to the [About Aggregations](#) section of the *Oracle Utilities Meter Solution Business User Guide* for more functional information.

Execute the following steps:

1. Create a business object for the aggregator measuring component. This will flatten the dimensional value(s) into searchable characteristics. Whether this business object is a parent or a child of another aggregator business object depends on when periodic aggregation should occur:
 - a. If you want the periodic aggregation to occur when another aggregation occurs, it can be a child business object (meaning that it inherits the lifecycle (and therefore the deferred monitor) of the parent)
 - b. If you want to schedule its periodic aggregation independently from other aggregation business objects, this must NOT be a child business object as it will require its own deferred monitor (and deferred monitors can only be defined on parent business objects)
2. Create UI maps for the aggregator business object as follows:
 - a. One to display the aggregator measuring component (Display)
 - b. One to allow user to change / add a new one (Maintenance)

NOTE: A newer alternative to creating UI Maps would be to use UI Hints directly within the Business Object.

3. Create an info plug-in for the aggregator business object that concatenates together its dimension types and values.
4. Create a "Find Constituent Measuring Components" algorithm and plug it on the aggregator business object. This will be passed the aggregator measuring component and the from and to date/times. It will insert the constituent measuring component IDs and the respective from / to date-time of each onto a temporary table.
5. Create a measuring component type instance and reference the new aggregator measuring component business object (as well as the types of constituent measuring component types that should be aggregated).
6. Create a query zone for Consumption Statistics search to allow users to find the aggregator measuring component.

Optional steps:

1. Create a business object for the dimension scanner activity. This should be a child business object of the base package dimension scanner business object.
2. Create UI maps for the activity business object, as follows:

- a. One to display the dimension scanner activity (Display).
- b. One to allow users to change/add a new one (Maintenance).

NOTE: A newer alternative to creating UI Maps would be to use UI Hints directly within the Business Object.

3. Create an info plug-in that will describe what it scans.
4. Create an Enter algorithm on the Scan state that finds distinct combinations of the dimensional values and creates new aggregator measuring components when new ones are detected.

NOTE: You can reuse the base package deferred monitor **Aggregation Dimension Scanner Monitor** (D1-ADS) batch control .

Dynamic Aggregation

Dynamic Aggregation Configuration Overview

Standard aggregation processing uses specific algorithms configured to work with a specified set of dimensions. For example, the base package Service Type and Postal aggregation uses specific algorithms for dimension scanning and finding constituent measuring components.

In contrast, dynamic aggregation uses dynamic queries for the dimension scanning, find constituents, and aggregation processes. These dynamic queries are based on configuration of administrative data, including:

- **Data Sources** define the source of data to be aggregated, such as measurement data from usage subscriptions linked to a service point, badged or unbadged items, or other sources of data.
- **Aggregation Measuring Component Types** define the most important properties of aggregation measuring components used to store aggregated data.
- **Aggregation Groups** define the ordering of a series of related aggregations and the schedule of aggregation.
- **Measuring Component Sets** define the dimensions and criteria by which aggregation will be performed.

Aggregation Master Configuration

The Aggregation Master Configuration defines common parameters used with aggregation processing, including:

- Batch Controls used by the dimension scan and aggregation process, for both scheduled and adhoc execution.
- Details for how the system compares interval and billing data for the same set of customers in order to use only one source or other.

Data Sources

Understanding Data Sources

Data Sources define the source of data to be aggregated, such as measurement data from usage subscriptions linked to a service point, badged or unbadged items, or measuring component sets. Data sources also define configurations used when generating dynamic queries used by aggregation processing.

Data Source Classes

Data sources are defined by classes, each of which is based on a specific business object, and determines the type of configuration used by aggregation processing. More specifically, the data types configured on the data source are used when generating dynamic queries used by aggregation processing.

The table below lists the data source classes and the business object and configuration options for each. Consult the embedded help for more information about the specific configuration options used by each data source class.

Data Source Class	Usage	Business Object	Configuration Options
Measurements from US Service Points	Used when aggregating data from measuring components linked to service points via a usage subscription.	D1-DataSourceMeasurements	Measuring Component Types
Badged Items	Used when aggregating data from badged items.	D1-BadgedItemsDataSource	Item Types
Billed Service Quantities	Used when aggregating data based on billed services quantities.	D1-DataSourceBilledSerQuantity	Usage Subscription Types
Measuring Component Sets	Used when aggregating data from measuring component sets. Data sources of this class are used with composite aggregation.	D1-DataSourceMCSet	Usage Subscription Types
Unbadged Items	Used when aggregating data from unbadged items.	D1-DataSourceUnbadgedItems	Item Types
Measurements from US Direct Links	Used when aggregating data from measuring components directly linked to a usage subscription.	D1-DataSourceMeasurementDirect	Measuring Component Types
Service Point Quantities	Used when aggregating data based on service point quantities.	D1-DataSourceSPQuantities	Service Point Quantity Types
Attribute and Measurement Data Snapshot	Used when aggregating data based on data snapshots	D1-MasterAndMsrmtDataSnapshot	Measurement Data Snapshot Types

Data Source Template SQL

Data sources also provide template structured query language (SQL) used when generating dynamic queries used by aggregation processing. This template SQL is used as the basis for dynamic queries, and is extended by additional SQL generated from the data source configuration as well as configuration defined for measuring component sets, measuring components, and measuring component types that reference the data source. Template SQL is provided via the Data Source SQL (D1-DataSourceSQLLookup) extendable lookup. Values for this extendable lookup are used as the **Option Value** for the following business object options on the data source business object.

- **Dimension Scanner SQL:** The template SQL used when dimension scanning. This SQL is extended by the criteria, dimensions, and individually managed items configured on the measuring component sets being processed.
- **Find Constituents SQL:** The template SQL used when finding constituents. This SQL is extended by attributes defined on the aggregator measuring components being processed.
- **Aggregation SQL:** The template SQL used when performing aggregation. This SQL is extended by the value identifiers defined on the measuring component type of the aggregator measuring components being processed.

Configuring Data Sources

This portal is used to display and maintain data sources.

Refer to [Understanding Data Sources](#) for more information.

You can access the portal by selecting **Admin**, then **Aggregation**, then **Data Source**.

The following zones may appear as part of the portal's **Main** tab page:

- **Data Source List:** This zone lists all data source records. Broadcast a record to display the details of the selected record.
- **Aggregation Data Source:** This zone provides information about the selected data source.

Configuring Data Source Template SQL

Template SQL used when generating dynamic queries used in aggregation processing is defined in the Data Source SQL (D1-DataSourceSQLLookup) extendable lookup. The base package data source business objects reference appropriate base package values from this extendable lookup.

For example, the **Aggregation SQL** option on the Measurements from US Service Points data source business object (D1-DataSourceMeasurements) references the “D1_MSRMT_FROM_US_SP_MCTYPE_SQL” value from the Data Source SQL extendable lookup.

If an implementation requires template SQL that differs from the base package, custom extendable lookup values can be created and referenced on the data source business object.

When creating custom template SQL, start from an existing extendable lookup value. Select the value that most closely matches your requirements and use the **Duplicate** function to create a copy, and edit the SQL as needed.

Use the following procedure to add a custom extendable lookup value to a data source business object.

1. Add a business object option of the appropriate type to the data source business object. For instance, if creating custom SQL for aggregation, add an **Aggregation SQL** option.
2. Enter a **Sequence** higher than the base package option.
3. Specify the custom extendable lookup value in the **Option Value** field.

Dynamic Aggregation Measuring Component Types

Understanding Dynamic Aggregation Measuring Component Types

Like other measuring component types, dynamic aggregation measuring component types define the most important properties of a measuring component. In this case, they define the properties of aggregator measuring components.

Measuring component types used by dynamic aggregation use many of the same attributes as other types of measuring components, but some attributes are used differently. Some attributes used specifically by dynamic aggregation include:

Measuring Component Business Object: This should be an aggregator measuring component business object, such as one of the following:

- Aggregator Interval (D1-AggregatorInterval)
- Aggregator Scalar (D1-AggregatorScalar)
- Aggregator Customer Quantities (D1-AggregatorCustomerQuantity)
- Aggregator Items Measuring Component (D1-AggregatorItems)

Measurement Business Object: Aggregated measurements can be based on either the Measurement (D1-Measurement) business object or the Aggregation Measurement (D1-AggregationMeasurement) business object (based on the Aggregation Measurement maintenance object).

Data Source: The source of the data that will be aggregated and the specific type of data that should be aggregated. Note that the **Service Type** of the data source, as determined by its associated objects (e.g. Measuring Component Type, Device Type, Service Point Type), must match the **Service Type** for this measuring component type.

Value Identifiers: These store the values of UOM, TOU, and SQI that identify the measurements to be aggregated. For each value identifier either the **Value Calculation Method** or **Value Derivation Algorithm** must be defined (not both). These define how measurement values are calculated or derived during aggregation processing.

Refer to [Understanding Measuring Component Types](#) for more information about measuring component types.

Configuring Dynamic Aggregation Measuring Component Types

The **Measuring Component Type** portal is used to display and maintain dynamic aggregation measuring components.

Refer to [Understanding Dynamic Aggregation Measuring Component Types](#) for more information about dynamic aggregation measuring components.

Refer to [Configuring Measuring Component Types](#) for more information about working with measuring component types.

Aggregation Groups

Understanding Aggregation Groups

Aggregation Groups define the ordering of a series of related aggregations based on a set of configured Measuring Component Sets. Aggregation groups define the following attributes for aggregations performed for its Measuring Component Sets:

- The **Time Zone** for aggregated data
- **Aggregation Scheduling** can be based on either a Defined Lag, or a Processing Timetable.
 - **Defined Lag** scheduling uses the following parameters:
 - **Aggregation Cut Off Time:** The end time for aggregation calculations performed for Aggregation Measuring Components for Measuring Component Sets associated with the Aggregation Group. This is used to ensure a consistent end time for aggregation periods. This is especially useful when aggregating other aggregations.
 - **Aggregation Lag:** The number of days between the date on which aggregation calculations are performed and the end date of the aggregation period. This defines the time period between the aggregation calculation date and the aggregation horizon that serves to allow all measurements to arrive. This together with the Aggregation Horizon is used to determine the start and end dates of an aggregation period. For example, with an Aggregation Horizon of 5 and an Aggregation Lag of 2, aggregation calculations performed on January 9 would be for an aggregation period of January 3 through January 7. The next day (January 10), the aggregation period would shift to January 4 through January 8.
 - **Aggregation Horizon:** The number of days in the aggregation period for Aggregation Measuring Components for Measuring Component Sets associated with the Aggregation Group. This reflects the time period during which there's a potential change in measurement data for one or more of the measuring components associated with Aggregation Measuring Components. This together with the Aggregation Lag is used to determine the start and end dates of an aggregation period.
 - **Processing Timetable** scheduling uses a Processing Timetable Type to drive aggregation schedule.

Aggregation groups can be used to perform aggregations for Analytical or Settlement purposes (defined by the Aggregation Category).

Aggregation Group Runs

Aggregation group runs represent individual aggregation executions for an individual aggregation group. Aggregation group runs are used to capture the relevant details for an aggregation and track the status of the execution of the aggregation for each of the Measuring Component Sets for the aggregation group.

Aggregation group runs for a specific aggregation group are listed in the **Aggregation Group Run** zone on the **Aggregation Group** portal. This zone displays the following for each aggregation group run:

- Run Number
- Run Type (Scheduled vs. Ad Hoc)
- Status (Pending, In Progress, Completed, or Error)
- Aggregation Horizon Start
- Aggregation Horizon End
- Details

Details for a specific aggregation group run can be viewed by broadcasting the run in the **Aggregation Group Run** zone. The following is displayed for the selected run in the **Aggregation Group Run Details** zone:

- Sequence
- Measuring Component Set
- Initiation Method
- Batch Run

Configuring Aggregation Groups

This portal is used to display and maintain aggregation groups.

Refer to [Understanding Aggregation Groups](#) for more information.

You can access the portal by selecting **Admin**, then **Aggregation, Aggregation Group**.

The following zones may appear as part of the portal's **Main** tab page:

- **Aggregation Group List:** This zone lists all aggregation group records. Broadcast a record to display the details of the selected record.
- **Aggregation Group:** This zone provides information about a selected aggregation group.
- **Aggregation Measuring Component Sets:** This zone lists measuring component sets associated with the selected aggregation group. Click **Resequence** to change the order of the measuring component sets in the aggregation group. Click **Add** to add a new measuring component set to the aggregation group.
- **Aggregation Group Run:** This zone lists individual aggregation runs performed for the selected aggregation group. Broadcast a record to display the details of the selected record. This zone displays up to 10 records. If there are more than 10 records, use the **Previous** and **Next** buttons to navigate between pages of records. Click **Add** to execute an ad hoc aggregation group run.
- **Aggregation Group Run Details:** This zone displays details for a selected aggregation group run.

Measuring Component Sets

Understanding Measuring Component Sets

Measuring component sets are used to define the dimensions and criteria by which aggregation will be performed.

A measuring component set's **Measuring Component Type** defines the Measuring Component and Measurement Type to be used in capturing aggregation results, as well as the aggregation functions that will be used on the source transnational data and the Data Source that will identify where that transnational data will be retrieved from.

Measuring component sets are associated with an **Aggregation Group**, which controls when and how aggregation is processed. This includes the sequence in which the aggregation group's measuring component sets are processed, as well as the method by which aggregation processing is initiated for each (this information can be found in the **General Processing** section).

A measuring component set's **Measuring Component Set Class** defines the way in which the measuring component set is used in the aggregation process. Measuring component set classes are based on the measuring component set's business object, and can include:

- **Aggregation Foundation** measuring component sets are used to aggregate transactional data, such as measurements from service points linked via usage subscriptions or billed service quantities.
- **Aggregation Composite** measuring component sets are used to aggregate data from a set of other aggregations (which can be based on either foundation or other composite measuring component sets).
- **Adhoc** measuring component sets are used to aggregate data based on an adhoc, user-defined set of measuring components.

See **Foundation and Composite Aggregation** in [Dynamic Aggregation Processing](#) for more information.

Dimensions, Criteria, and Individually Managed Items

The **Dimensions** and **Criteria** defined for the measuring component set are used by the dimension scanning process to identify individual aggregation measuring components that should be created. Measuring components are also created for each **Individually Managed Item** for which data matches the item's configuration.

- **Dimensions** identify the attributes by which data should be aggregated. Dimensions can include characteristics, identifiers, market participants, and values from specific tables and columns. For example, aggregating data by loss profile code, service point type and service provider would require defining dimensions for a Loss Profile Code characteristic, the Service Point Type column from the Service Point table, and the Service Provider column from the Device table.

NOTE: When configuring measuring component sets for aggregation of data from measurement data snapshots, the **Source Type** and **Source Entity** should be "Attribute Data Snapshot".

- **Criteria** define the ways in which the dimensions are evaluated through a series of inclusions, exclusions, or both. For example, to aggregate data for the "AGG-E-COM" and "AGG-E-RES" service point types, but NOT for devices from the "ELEC" service provider, criteria could be defined to include both of service point type values and exclude the "ELEC" service provider.

NOTE: When configuring measuring component sets for aggregation of data from measurement data snapshots, the **Source Type** and **Source Entity** should be "Attribute Data Snapshot".

- The criteria provided for **Individually Managed Items** is used to identify specific customers that should be aggregated in isolation from all other data that matches the **Dimensions** and **Criteria** defined for the measuring component set.

More specifically, the dimension scanning template SQL (derived from the data source) is extended by the **Dimensions**, **Criteria**, and **Individually Managed Items** configured on the measuring component set being processed.

Consult the embedded help for more information about the specific configuration options used by **Dimensions**, **Criteria**, and **Individually Managed Items**. The Source Type and Source Entity values are defined in the Aggregation Criteria

Source Type (D1-CriteriaSourceTypeLookup) extendable lookup. Refer to [Configuring Aggregation Criteria Source Types](#) for more information about this extendable lookup.

The manner in which the criteria provided will be evaluated is defined in formulas configured in the **Criteria Processing** section. Consult the embedded help for more information about defining criteria processing formulas.

Configuring Measuring Component Sets

This portal is used to display and maintain measuring component sets.

Refer to [Understanding Measuring Component Sets](#) for more information.

You can access the portal by selecting **Admin**, then **Aggregation, Measuring Component Set**.

The following zones may appear as part of the portal's **Main** tab page:

- **Measuring Component Set:** This zone displays details of a selected measuring component set.
- **Dimensions:** This zone lists the dimensions used to identify the attributes by which the aggregation should be analyzed. Note: Data in this zone is edited by clicking the **Edit** button in the **Measuring Component Zone**.
- **Criteria:** This zone lists the criteria that limits the data to be aggregated through a series of inclusions, exclusions, or both. Note: Data in this zone is edited by clicking the **Edit** button in the **Measuring Component Zone**.
- **Individually Managed Items:** This zone lists the criteria used to identify specific customers that should be aggregated in isolation from all other data that matches the dimensions and criteria defined for the measuring component set. Note: Data in this zone is edited by clicking the **Edit** button in the **Measuring Component Zone**.
- **Measuring Component Set Participants:** This zone displays the measuring components that are in the Measuring Component Set Participant table for the measuring component set. For each measuring component, this zone displays the most recent and last measurement date/times.

Configuring Aggregation Criteria Source Types

The options in the **Source Type** and **Source Entity** drop-down lists used when configuring Dimensions, Criteria, and Individually Managed Items are defined in the Aggregation Criteria Source Type (D1-CriteriaSourceTypeLookup) extendable lookup. The measuring component set business objects reference this extendable lookup.

Each of the base package Source Type values (Characteristic, Identifier, Market Participant, and Table) are records in this extendable lookup. The Source Entity values for each of these are defined in the corresponding record.

For example, the “Table” Source Type defines the base package “Table” Source Entity values (Device, Device Event, Measuring Component, Service Point, Usage Subscription, and Usage), along with criteria path details for each (based on data source class).

If an implementation requires Source Type or Source Entity values that differ from the base package, custom extendable lookup values can be created.

When for creating custom values for this extendable lookup, start from an existing extendable lookup value. Select the value that most closely matches your requirements and use the **Duplicate** function to create a copy, and edit as needed.

Configuration Step-by-Step

This section outlines the steps involved when configuring dynamic aggregation.

Create Device and Service Point Administrative Data

Many of the objects used in dynamic aggregation reference other device- and service point-related administration data, such as measuring component types, service point types, usage subscription types, etc. Make sure this data is in place before configuring entities used with dynamic aggregation.

Create Data Sources

Create data sources for each source of data from which data will be aggregated. Note that implementations can have multiple data sources of each class with different data type configuration (Measuring Component Types, Item Types, Usage Subscription Types, etc.). For example, an implementation with 15 measuring component types might want to aggregate data differently based on subsets of measuring component types. In this case, each subset of measuring component types could be defined on a different data source.

If applicable, create custom Template SQL extendable lookup values and add them to Data Source business objects as appropriate.

Create Aggregation Measuring Component Types

Create the aggregation measuring component types that will be used to define the attributes of the measuring components that will be created during aggregation processing.

Aggregation measuring component types reference an appropriate Data Source. Continuing the example above, each subset of measuring component types (each defined on a separate data source) would require a separate aggregation measuring component type.

Create Aggregation Groups

Create the aggregation groups that will be used to control aggregation processing, including aggregation groups for both foundation and composite aggregation processing.

Note: When initially creating aggregation groups, define only the basic data for each (name, category, and optional time zone). Add measuring component sets to aggregation groups when creating the latter in the next step.

Create Measuring Component Sets

Create the measuring component sets that will define the “buckets” by which the aggregated data will be grouped.

Measuring component sets reference aggregation measuring component types and aggregation groups.

Create custom Source Type records (if applicable).

Revise Aggregation Groups (if needed)

After creating measuring component sets, adjust the sequence of each within its aggregation group as appropriate. For example, this would be necessary if measuring component sets are created and added to aggregation groups in an order that differs from their intended sequence.

Extending Dynamic Aggregation

The dynamic aggregation functionality provides extensive flexibility through configuration of data sources, measuring component types, and measuring component sets to handle complex aggregation requirements. However, some implementations may require functionality and configuration options beyond that provided in the base package. For instance, an implementation may need to aggregate data of a source and type not covered by the base package data sources or use different dimensions and criteria or queries for aggregation processing.

In circumstances like these, the dynamic aggregation functionality can be extended through use of the Oracle Utilities Application Framework’s Configuration Tools (see [Configuration Tools](#)) and other options. This section outlines some of the possible approaches to extending this functionality.

Data Source Business Objects: If an implementation requires aggregation of a data type of source beyond those provided with the base package data source business objects, custom business objects can be created to support this requirement. Key considerations when creating custom data source business objects include:

- Configuration options such as “Sourced Measuring Component Types” or “Sourced Usage Subscription Types”
- Values for the “Aggregation SQL”, “Dimension Scanner SQL”, and “Find Constituents SQL” business object options from the Data Source SQL extendable lookup.
- Algorithms for the “Generate SQL For Data Source” system event that leverage the configuration options defined for the data source

Data Source SQL Extendable Lookup Values: If an implementation requires template SQL that differs from the base package, custom values for the Data Source SQL extendable lookup can be created and referenced on the data source business object. When creating custom template SQL, start from an existing extendable lookup value. Select the value that most closely matches the requirements and use the **Duplicate** function to create a copy, and edit the SQL as needed.

Aggregation Measuring Component Type Business Objects: If an implementation requires capturing data for measuring component types not provided in the base package, the base package aggregation measuring component type business objects can be extended as appropriate. Key considerations when creating custom measuring component type business objects include:

- Algorithms for the “Generate SQL For MC Type” system event that leverages the Value Identifiers and other information defined for the measuring component type

Aggregation Measuring Component Business Objects: If an implementation requires capturing data for measuring components not provided in the base package, the base package aggregation measuring component business objects can be extended as appropriate. Key considerations when creating custom measuring component business objects include:

- Algorithms for the “Generate SQL For Aggregator MC” system event that leverages the Value Identifiers and other information defined for the measuring component type
- Algorithms for the “Find Constituents” system event that uses the “Generate SQL for Aggregator MC” algorithm, data source configuration, and other configuration to find constituent data for aggregation
- Algorithms for the business object’s “Active” state, including data aggregation and value derivation

Measuring Component Set Business Objects: If an implementation requires capturing data for measuring component sets not provided in the base package, the base package aggregation measuring component set business objects can be extended as appropriate. Key considerations when creating custom measuring component set business objects include:

- Algorithms for the “Generate SQL For MC Set” system event
- Algorithms for the business object’s lifecycle states, as appropriate

Aggregation Criteria Source Type Extendable Lookup Values: If an implementation requires Source Type or Source Entity values for measuring component sets that differ from the base package, custom extendable lookup values can be created. When creating custom values for this extendable lookup, start from an existing extendable lookup value. Select the value that most closely matches the requirements and use the **Duplicate** function to create a copy, and edit as needed.

Consumption Synchronization

Configuring Consumption Synchronization

NOTE: Refer to [Introduction to Consumption Sync](#) for additional functional information about how consumption synchronization works.

Keeping consumption synchronized between two measuring components that meter the same quantity but at different frequencies is a complicated task. As such the configuration for this process is diffuse and requires settings across several key areas of the system to be aligned. This section will help guide you through the process of configuring consumption synchronization.

The consumption synchronization process is really a collection of processes within Oracle Utilities Meter Data Management that all work together to ensure that quantities between related channels remain consistent:

- **Estimation VEE Rules:** several rules align consumption between related channels. These rules allow estimations to be refined based on higher quality measurements from a related channel. These rules are core to the consumption synchronization process. In simple scenarios where a few intervals are missing for an interval measuring component these rules are all that are necessary for synchronization with the related channel (note: it requires that the related channels data for that same time period has already been processed through to final measurements). For more information on these rules please visit the following sections:
 - Interval Adjustment from Scalar
 - Scalar Calculation from Interval
 - Scalar Proration
 - Sum Check
 - Final Measurement Validation

NOTE: Refer to [About IMD Estimations](#) for more information about these rules

- **Periodic Estimation:** both the interval and scalar variations of periodic estimation play an important role in consumption synchronization by ensuring that both channels of data are without gaps. In simple scenarios where one channel is missing data and the other is not periodic estimation is all that is require to produce synchronized consumption. It is important to note that this process itself does not perform estimations but rather it is responsible for creating estimation initial measurements to trigger the estimation VEE rules.
- **Consumption Synchronization Activities:** these activities work to fix alignment issues that occur when data for the related channels are processed out of order or when there are complex outage scenarios. These activities are created when higher quality data is received for one channel and the related channel has measurements that are eligible to be recalculated and adjusted to align the total consumption for the period across the two channels. It is important to note that this process itself does not perform estimations but rather it is responsible for creating estimation initial measurements to trigger the estimation VEE rules.

Device Configuration Type

As a default the system will not generate consumption synch activities for related measuring components. Turning on consumption synchronization activities is done through a few key fields on the device configuration type:

- **Keep Consumption Reference MC in Sync:** defines if the related measuring components should be kept in sync. It can be configured to provide a one way synchronization from primary to secondary or a two way synchronization between primary and secondary.
- **Minimum Condition to Sync Primary MC:** when the secondary measuring component can initiate synchronization of the primary this provides an ability to limit those situations to when the incoming data is of a minimum quality.
- **Sum Check VEE Exception Type:** provides further ability to limit initiation of synchronization. When configured the synchronization activities will only be created when the initial measurement being processed encounters a VEE exception of the type configured. More specifically, a sum check VEE exception which will indicate that the two channels are out of synch by a minimum tolerance amount. This can be used to avoid synchronization either when there is no difference between the channels or when there is only a small difference between the channels.
- **Enable Extended Reconciliation:** defines if synchronization calculations should extend to cover the total contiguous period of consumption synchronization eligible final measurements across both channels in the relationship. When set to “Yes” consumption synchronization algorithms on initial measurements will execute a measuring component relationship level gap analysis and create a consumption synchronization for an entire gap that will impact both measuring components in the relationship.

NOTE: Additional detail about these fields can be found in the embedded help for the device configuration type.

Register Auto-Read Measuring Component Type

The configuration available for the register auto-read measuring component type has an indirect impact on the consumption synchronization process. This configuration is primarily intended to allow for a register to re-evaluate previously created estimations when new more accurate readings are received even when no related measuring components exist. Where this has impact to the consumption synchronization process is that when a new scalar reading is received after a period of estimation it will result in the time period for that new initial measurement being expanded into the past. This is because any estimates prior to this new higher quality initial measurement will be logically removed and the start reading for the initial measurement will in turn be the last non-estimated measurement prior to the initial measurement. This creates an initial measurement that spans the entire period for which estimations exist and as a result when a consumption synchronization activity is generated it will result in that same period of time being re-evaluated on the related measuring component.

This functionality is controlled by a few key fields on the register auto-read measuring component type:

- **Ignore Estimates as IMD Start Reading:** controls whether estimates directly previous to newly received incoming initial measurement should be logically removed when that newly received initial measurement data is non-estimated.
- **Flag Future Estimates as Do Not Use:** controls whether estimates that come directly after newly received incoming initial measurements should be logically removed when that newly received initial measurement data is non-estimated
- **Actuals or Corrections Initial Re-Estimation:** works in tandem with the above two fields. When either scenario results in measurements being logically removed this field, when turned on, will reset the last contiguous measurement date/time for the measuring component making it eligible once more for periodic estimation. With the end result being that those estimated measurements that were removed would recreated as new estimates.

Measuring Components

In order for consumption synchronization to work it must know that two measuring components are related in a way that indicates they are measuring the same consumption. This is achieved by configuring the "Consumption Reference Measuring Component" field on the measuring component.

Not only does this establish the relationship but it also establishes which measuring component is considered to be primary and which is considered to be secondary.

A measuring component is considered to be secondary when it holds the relationship to the Consumption Check Measuring Component (the primary measuring component).

For example, consider the following related measuring components.

- Scalar Measuring Component: ER-SM-007 / 1 / Electric kWh Daily
- Interval Measuring Component: ER-SM-007 / 2 / Electric kWh 60min

If the scalar measuring component is the primary measuring component, it does NOT specify a "Consumption Reference Measuring Component", and the interval measuring component specifies the scalar measuring component as the "Consumption Reference Measuring Component".

If the interval measuring component is the primary measuring component, it does NOT specify a "Consumption Reference Measuring Component", and the scalar measuring component specifies the interval measuring component as the "Consumption Reference Measuring Component".

It is important to note that pending initial measurements for the secondary measuring component are processed by the D1-IMD batch process after the initial measurements for the primary measuring component. This ensures that the primary measuring component's final measurements will be available to the secondary measuring component's initial measurements VEE process to provide better quality estimations and validations.

Initial Load and Manual Initial Measurement Algorithms

Key to the consumption synchronization process are the algorithms that reside on initial load and manual initial measurements for both scalar and interval measuring components. These algorithms contain logic to identify final measurements on a related channel that are consumption synchronization eligible (typically estimated).

These algorithms allow definition of:

- The consumption synchronization activity created
- The condition range that defines consumption synchronization eligible final measurements

Please refer to the algorithm type descriptions for more information:

Algorithm Type	Description	Where used
D1-UPD-DTMC	Update Latest Measurement Date/Time on MC with Consumption Sync	D1-InitialLoadIMDInterval D1-ManualIMDInterval
D1-UDTSCMCRE	Update Latest Measurement Date/Time on Scalar MC with Consumption Sync	D1-InitialLoadIMDScalar D1-ManualIMDScalar

Consumption Synchronization Activities

The consumption synchronization activities are initiated by initial measurements and are responsible for generating the appropriate estimation initial measurements to re-evaluate any consumption synchronization eligible final measurements for the related measuring component being processed.

These activities can be associated to one or more initiating initial measurements and are able to handle a broad combination of time periods which are not required to be contiguous.

If any generated estimation initial measurement does not finalize processing will be halted and details about the failed estimation initial measurement will be provided.

The following table identifies the catalogue of consumption synchronization activities:

Activity Type	Description	Activity Business Object
Related MC Consumption Sync - Scalar	This activity is generated to re-evaluate consumption sync eligible final measurements on scalar measuring components. One estimation initial measurement will be created per measurement needing to be re-evaluated.	D1-RelMCREScalar
Related MC Consumption Sync - Interval	This activity is generated to re-evaluate consumption sync eligible final measurements on interval measuring components. One estimation initial measurement will be created per contiguous set of interval measurements needing to be re-evaluated. Note the generated initial measurements will include non-consumption sync eligible final measurements which will help to feed into the estimation process to provide more accurate results.	D1-RelMCREInterval
Gap Period Consumption Sync	This activity will re-evaluate both measuring components in the relationship for a wider time period than the initiating initial	D1-GapPeriodConsumpnSync

measurement. Specifically the time period will be the total contiguous period of consumption sync eligible final measurements across both channels in the relationship.

Each consumption synchronization activity has an algorithm that performs the core logic of the consumption synchronization process.

These algorithms allow definition of:

- The condition range that defines consumption synchronization eligible final measurements

Please refer to the algorithm type descriptions for more information:

Algorithm Type	Description	Where used
D1-RE-SCMC	Scalar MC Consumption Sync	D1-RelMCREScalar
D1-RE-INTVMC	Interval MC Consumption Sync	D1-RelMCREInterval
D1-GAPCSYNC	Gap Period Consumption Sync	D1-GapPeriodConsumpnSync

Periodic Estimation

The algorithm that initiates periodic estimation which is plugged in to the Smart Meter device business object has a key configuration setting related to consumption synchronization:

- **MC Type to Process First:** determines whether interval or scalar measuring components should be estimated first. This should be set to process whichever measuring component type is considered to be primary first.

Please refer to the algorithm type description for more information:

Algorithm Type	Description	Where used
D1-PERESTM	Periodic Estimation	D1-SmartMeter

Related Batch Controls

There are a few batches involved with Consumption Synchronization:

- **Related MC Consumption Sync (D1-RMCRE):** this processes any pending consumption synchronization activities.
- **Related MC Consumption Sync - Retry Act (D1-RMCRR):** this retries any consumption synchronization activities that fail to the Issue Detected state.

Defining Dashboard Options

Configuring the Customer Operational Dashboard

This section describes the process for configuring the Customer Operational Dashboard.

Refer to the [Using the Customer Operational Dashboard](#) section of the *Oracle Utilities Customer To Meter Business User Guide* for more information on this functionality.

Configuration for the Customer Operational Dashboard is performed by adding or changing a Master Configuration. You can access the portal from the **Admin > General > Master Configuration**.

Once the Master Configuration search screen returns, configure the **Customer Operational Dashboard Configuration** record. Use the Add button beside the record to configure for the first time. If a record has already been added, then click the Edit button instead. Use the embedded help to guide you through the meaning of each configuration field.

This dashboard also leverages a method of pre-staging data known as Statistics Snapshots. Refer to [About Statistics](#) in the *Oracle Utilities Application Framework Administrative User Guide* for more information.

A method for tracking Performance Targets (also known as Service Level Agreements) is also available in the Customer Operational Dashboard. To understand how to set up Performance Targets, refer to [About Performance Targets](#) in the *Oracle Utilities Application Framework Administrative User Guide*. The Performance Targets you configure will then be leveraged on the **Batch Performance** page of the Customer Operational Dashboard.

Configuring the Meter Operational Dashboard

This section describes the process for configuring the Meter Operational Dashboard.

Refer to the [Using the Meter Operational Dashboard](#) section of the *Oracle Utilities Meter Solution Business User Guide* for more information on this functionality.

This dashboard leverages a method of pre-staging data known as Statistics Snapshots. See [Understanding Statistics](#) for more information on Statistics Snapshots.

A method for tracking Performance Targets (also known as Service Level Agreements) is available within the Meter Operational Dashboard as well. To understand how to set up Performance Targets, refer to [Understanding Performance Targets](#). The Performance Targets you configure will then be leveraged on the **Batch Performance** and/or **Database** tabs of the Meter Operational Dashboard.

Configuring the **Meter Operational Dashboard** includes the following:

Master Configuration

You can access the Master Configuration portal by selecting **Admin**, then **General**, then **Master Configuration**.

Select the MDM Operational Dashboard Configuration.

Use the **Add** button beside the record to configure for the first time. If a record has already been added, then click the **Edit** button instead. Use the embedded help to guide you through the meaning of each configuration field.

General Admin Data

Create the following administrative data.

Service Type:

- **Service Type:** MISC
- **Description:** Miscellaneous

Unit of Measure:

- **Unit of Measure:** CT
- **Description:** Count
- **Service Type:** Miscellaneous
- **Decimal Positions:** 0
- **Allowed on Measuring Component:** Yes
- **Measures Peak Quantity:** No
- **Magnitude:** 1

- **Base Unit of Measure:** BLANK

Activity Types for Payload Statistics

Configure the following payload statistics activity types:

- Payload Statistics
- Payload Error Notification
- Payload Summary

See [Configuring Activity Types](#) for more information.

See [Processing Statistics](#) in the *Business User Guide* for more information about payload statistics processing.

Measuring Component Types for Payload Statistics

Configure the following measuring component types:

Initial Measurements

Field / Section	Value																		
Measuring Component Type	STATS-IMD																		
Description	IMD Upload Statistics Aggregator																		
Measuring Component Type Business Object	Activity Upload Statistic Aggregator Type																		
Measuring Component Business Object	Payload Statistics Aggregator - IMD																		
Measurement Business Object	Measurement																		
Service Type	Miscellaneous																		
Statistic Type	Initial Measurements																		
Display Parcel Size	24:00:00																		
Aggregation	Aggregation Horizon: 5 Aggregation Lag: 2																		
Valid Activity Types to Aggregate	Activity Type: Payload Statistics																		
Value Identifiers	<table border="1"> <thead> <tr> <th>Value Identifier Type</th> <th>Short Hand Description</th> <th>Unit of Measure</th> </tr> </thead> <tbody> <tr> <td>Measurement</td> <td>Total Number of IMDs</td> <td>Count</td> </tr> <tr> <td>Value 01</td> <td>Count of Outstanding IMDs</td> <td>Count</td> </tr> <tr> <td>Value 02</td> <td>Count of IMDs in Error</td> <td>Count</td> </tr> <tr> <td>Value 03</td> <td>Count of Pending IMDs</td> <td>Count</td> </tr> <tr> <td>Value 04</td> <td>Count of Completed IMDs</td> <td>Count</td> </tr> </tbody> </table>	Value Identifier Type	Short Hand Description	Unit of Measure	Measurement	Total Number of IMDs	Count	Value 01	Count of Outstanding IMDs	Count	Value 02	Count of IMDs in Error	Count	Value 03	Count of Pending IMDs	Count	Value 04	Count of Completed IMDs	Count
Value Identifier Type	Short Hand Description	Unit of Measure																	
Measurement	Total Number of IMDs	Count																	
Value 01	Count of Outstanding IMDs	Count																	
Value 02	Count of IMDs in Error	Count																	
Value 03	Count of Pending IMDs	Count																	
Value 04	Count of Completed IMDs	Count																	

Field / Section	Value
Display Configuration	Hours of Chart Data to Display: 24

Device Events

Field / Section	Value
Measuring Component Type	STATS-EVENT
Description	Event Upload Statistics Aggregator
Measuring Component Type Business Object	Activity Upload Statistic Aggregator Type
Measuring Component Business Object	Payload Statistics Aggregator - Event
Measurement Business Object	Measurement
Service Type	Miscellaneous
Statistic Type	Events
Display Parcel Size	24:00:00
Aggregation	Aggregation Horizon: 5 Aggregation Lag: 2
Valid Activity Types to Aggregate	Activity Type: Payload Statistics

Value Identifiers	Value Identifier	Short Hand Description	Unit of Measure
	Type		
	Measurement	Total Number of Events	Count
	Value 01	Count of Outstanding Events	Count
	Value 02	Count of Events in Error	Count
	Value 03	Count of Pending Events	Count
	Value 04	Count of Completed Events	Count

Display Configuration	Hours of Chart Data to Display: 24
-----------------------	------------------------------------

Statistic Controls and Statistics Snapshots

Statistic Controls are the source for recording the transactions which have gone into exception/discarded state or have a pending to-do associated with them. These records are then fetched by MDM Operational Dashboard's respective zones for Statistic and Trend display.

Statistic Snapshots capture the transactions which have gone into exception/discarded state or have a pending to-do associated with them at a specific time.

Statistic Controls are configuration records that record the daily transactions of Incomplete IMD by Status, VEE Exceptions by Type, Usage Transaction by Status, and Usage Transaction by To-Do.

Statistic Snapshots are captured daily via the Statistics Control Monitor (F1-STATS) batch process.

Configure the following Statistics Control records:

Statistics Control	Description	Category	Status	Snapshot Frequency	Retention Mode	Snapshot Business Object
INCOMPLETE-IMD-STATUS	Incomplete IMDs by Status	Operational	Active	1.00	Retain All Snapshots	Same as Description
INCOMPLETE-UT-STATUS	Incomplete Usage Transaction by Status	Operational	Active	1.00	Retain All Snapshots	Same as Description
INCOMPLETE-UT-TD-EXCP	Incomplete Usage To Dos by Exception	Operational	Active	1.00	Retain All Snapshots	Same as Description
INCOMPLETE-VEE-TD-EXCP	Incomplete VEE To Dos by Exception	Operational	Active	1.00	Retain All Snapshots	Same as Description

Payload Statistics Aggregator Measuring Components

Create a measuring component for each head end system for each measuring component type. For example, assume the following head end systems are being used:

- MV90: Usage
- Landis+Gyr: Usage and Device Events

In this example, you would create the following measuring components:

- MV90 (STATS-IMD Measuring Component Type)
- L+G (STATS-IMD Measuring Component Type)
- L+G (STATS-EVENT Measuring Component Type)

Field	MV90 Usage	L+G Usage	L+G Device Events
Measuring Component Type	IMD Upload Statistics Aggregator	IMD Upload Statistics Aggregator	Event Upload Statistics Aggregator
Status	Active	Active	Active
How To Use	Additive	Additive	Additive
Head End System	MV90	L+G	L+G

Batch Processing

The Meter Operational Dashboard is configured to be refreshed daily. To refresh the data used in the dashboard, the following batch processes should be processed in sequence after daily payload processing from the head end systems is complete.

- **D1-PSACC** (Payload Statistics Accumulation - Monitor): Used to initiate aggregation and accumulation of payload statistics in payload statistics activities. This executes the Perform Activity Aggregation (D1-PRFACTAGG)

algorithm in the activity's "Active" state and transitions the activity to the "Accumulate Statistics" state which executes the Accumulate Statistics Algorithm (D1-ACCSTATS) algorithm.

Use the following parameters when running this batch process:

- Measuring Component Maintenance Object (maintenanceObject): D1-ACTIVITY
- Restrict by Batch Code (isRestrictedByBatchCode): true
- **D1-MC** (MC MO Periodic Monitor Process): Used to initiate aggregation of statistics for statistics aggregator measuring components. This transitions measuring components from the "Active" state to the "Aggregate" state, which executes the Aggregate IMD Statistics (D1-AGIMDSTAT) or Aggregation Event Statistics (D1-AGEVTSTAT) algorithms that aggregate measurement and/or device event statistics.

Use the following parameters when running this batch process:

- Maintenance Object (maintenanceObject): D1-MEASRCOMP
- **F1-STATS** (Statistics Control Monitor): Used to generate Statistic Snapshots based on Statistic Controls.

Use the following parameters when running this batch process:

- Maintenance Object (maintenanceObject): F1-STATS
- Restrict by Business Object (restrictToBusinessObject): F1-Statistics
- Restrict by Status Code (restrictToBOStatus): ACTIVE

The flowchart below illustrates the order which payload processing and these batch processes should be executed.

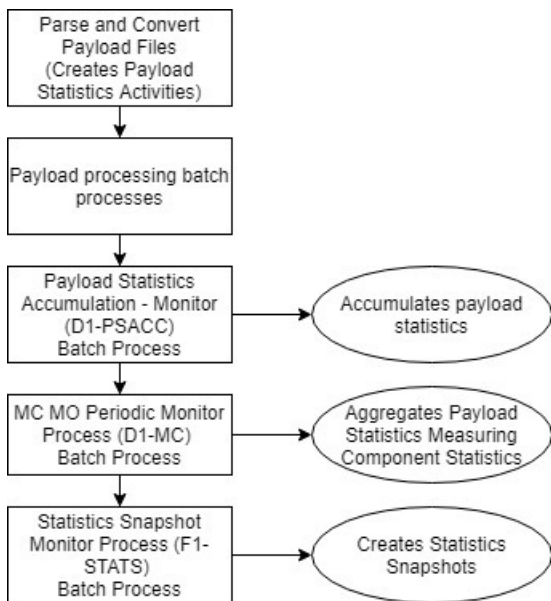

Populating the Dashboard Zones

The table below outlines the source of data for the various zones in the Meter Operational Dashboard.

Dashboard Zone	Source of Data
IMD Loading Trend	Usage Payload Statistics Aggregator Measuring Components (which aggregate data from payload statistics activities) (MV90 Usage and L+G Usage measuring components from the example above)
Device Event Loading Trend	Device Event Payload Statistics Aggregator Measuring Components (which aggregate data from payload statistics activities)

Dashboard Zone	Source of Data
	(L+D Device Events measuring component from the example above)
Incomplete IMDs by Status	Incomplete IMDs by Status Statistics Control and Statistics Snapshots
Incomplete IMDs Trend	
VEE To Dos by Exception Type	Incomplete VEE To Dos by Exception Statistics Control and Statistics Snapshots
VEE To Dos Trend	
Usage Transaction by Status	Incomplete Usage Transactions by Status Statistics Control and Statistics Snapshots
Usage Transactions Trend	
Incomplete Usage To Dos by Exception	Incomplete Usage To Dos by Exception Statistics Control and Statistics Snapshots
Usage Transactions To Dos Trend	

Configuring the Meter Health Check Dashboard

This section describes the process for configuring the **Meter Health Check** tab of the **Meter Operational Dashboard**.

Refer to **Using the Meter Health Check Tab** in the *Business User Guide* for more information on this functionality.

This dashboard leverages a method of pre-staging data known as Statistics Snapshots. See [Understanding Statistics](#) for more information on statistics snapshots.

Configuring the **Meter Health Check** tab includes the following:

Master Configuration

To access the **Master Configuration** portal select **Admin**, select **General**, and select **Master Configuration**.

Select the **Meter Health Check Configuration** master configuration.

You can also access this master configuration by clicking **Configure** on the **Meter Health Check** tab on the **Meter Operational Dashboard**.

Click the **Add** icon beside the record to configure for the first time. If a record has already been added, then click the **Edit** icon instead. Use the embedded help to guide you through the meaning of each configuration field.

This master configuration includes the following options:

- **IMD Trend Days:** specifies the horizon of collected data for IMD Processing and IMD Quality statistics snapshots. The number of days captured in each snapshot. Default 30 days.
- Chart Options:
 - **Processing:** Allows configuration of the colors used for IMD Records, Average Measurements, and Maximum Measurements data on the **IMD Processing Trend** graph.
 - **Quality:** Allows configuration of the colors used for VEE Exceptions, Average Measurements, and Maximum Measurements data on the **IMD Quality Trend** graph.

Configure Statistic Control and Statistic Snapshots

Statistic controls are the source for capturing the numbers of initial measurement records, VEE exceptions, and average and maximum measurements displayed on the **Meter Health Check** tab.

Statistic snapshots capture the numbers for each metric. Statistic controls are configuration records that define the specific types of metrics to capture.

Statistic snapshots are captured periodically via the FI-STATS (Statistics Control Monitor) batch program.

Configure the following Statistics Control records:

Table listing details for types of health check statistics controls.

Statistics Control	Description	Category	Status	Snapshot Frequency	Retention Mode	Snapshot Business Object
Processing	IMD Processing Statistics - Hourly	Operational	Active	24:00	Retain All Snapshots	IMD Processing Snapshot - Hourly (D1-IMDProcessingHourly)
Quality	IMD Quality Statistics - Hourly	Operational	Active	24:00	Retain All Snapshots	IMD Quality Snapshot - Hourly (D1-IMDQualityHourly)

See [Capturing Statistics](#) for more information about statistics.

Configure Statistics Control Business Object

The Statistics Control (F1-Statistics) business object should be configured to specify the "Statistics Control Monitor" batch control in the **Monitor Process** drop-down list on the "Active" state.

To configure this business object, do the following:

1. Open the Statistics Control (F1-Statistics) business object in the **Business Object** portal.
2. Navigate to the **Lifecycle** tab, and expand the "Active" state.
3. Select "Statistics Control Monitor" from the **Monitor Process** drop-down list.
4. Click **Save**.

Batch Processing

The **Meter Health Check** tab is configured to be refreshed regularly (as frequently as daily). To refresh the data used in the dashboard, the F1-STATS batch process should be processed in sequence after other regularly schedule batch processing is complete to generate statistic snapshots based on statistic controls.

Use the following parameters when running this batch process:

- Maintenance Object (maintenanceObject): F1-STATS
- Restrict by Business Object (restrictToBusinessObject): F1-Statistics
- Restrict by Status Code (restrictToBOStatus): ACTIVE

Configuring the Service Order Management Dashboards

This section describes the process for configuring the **Service Order Operational Dashboard** and the **Service Order Trends Dashboard**.

Refer to the [Using the Service Order Operational Dashboard](#) and [Using the Service Order Trends Dashboard](#) sections of the *Business User Guide* for more information on this functionality.

Configuring the **Service Order Operational Dashboard** and **Service Order Trends Dashboard** includes the following:

Configure Activity Type

Configure the following payload statistics activity type:

- Activity Statistics Aggregator Creator

Use the following procedure to create this activity type:

1. Select **Admin**, then **Communication**, then **Activity Type**. The **Activity Type** portal and **Activity Type List** zone open.
2. Click the **Add/Edit** icon for the "Activity Statistics Aggregator Creator" activity type in the **Activity Type List** zone.
3. Specify the following:
 - **Create Aggregators for Field Activity Statistics:** Yes
 - **Create Aggregators for Command Activity Statistics:** Yes
 - **Activity-Requesting Service Providers:** The external system(s) that sends service requests
 - **Exception Handling:** **To Do Type**, **To Do Role**, and other values as appropriate for your implementation.
4. Click **Save**.

See [Configuring Activity Types](#) for more information.

Configure Measuring Component Types

Configure the following measuring component types for each service type in your implementation:

- Activity Processing Accumulation Aggregator
- Activity Aging Snapshot Aggregator
- Activity Processing Snapshot Aggregator
- Activity Processing Derived Snapshot Aggregator

The tables below provide details for these measuring component types based on the "Electric" service type from the demonstration database.

Sub-Aggregator Measuring Component Types:

Field	Activity Processing Snapshot Aggregator	Activity Processing Derived Snapshot Aggregator												
Measuring Component Type	ACT_PROC_SNAP_AGG	ACT_PROC_DER_SNAP_AGG												
Description	Activity Processing Snapshot Aggregator	Activity Processing Derived Snapshot Aggregator												
Measuring Component Type Business Object	Activity Statistics Sub-Aggregator Type	Activity Statistics Sub-Aggregator Type												
Measuring Component Business Object	Activity Processing Snapshot Aggregator	Activity Derived Snapshot Aggregator												
Measurement Business Object	Measurement	Measurement												
Service Type	Electric	Electric												
Interval Size	24:00:00	24:00:00												
Fallback Time Zone	US Eastern Time	US Eastern Time												
Consumptive/Subtractive	Consumptive	Consumptive												
Activity Aggregator Type	Activity Processing Snapshot	Activity Processing Derived Snapshot												
Aggregation	Aggregation Horizon: 7 Aggregation Lag: 2 Aggregation Cut-Off Time: 12:00:00	Aggregation Horizon: 7 Aggregation Lag: 1 Aggregation Cut-Off Time: 12:00:00												
Value Identifiers	<table border="1"> <thead> <tr> <th>Value Identifier Type</th> <th>Short Hand Description</th> <th>Unit of Measure</th> </tr> </thead> <tbody> <tr> <td>Measurement</td> <td>Created</td> <td>Count</td> </tr> </tbody> </table>	Value Identifier Type	Short Hand Description	Unit of Measure	Measurement	Created	Count	<table border="1"> <thead> <tr> <th>Value Identifier Type</th> <th>Short Hand Description</th> <th>Unit of Measure</th> </tr> </thead> <tbody> <tr> <td>Measurement</td> <td>Total</td> <td>Count</td> </tr> </tbody> </table>	Value Identifier Type	Short Hand Description	Unit of Measure	Measurement	Total	Count
Value Identifier Type	Short Hand Description	Unit of Measure												
Measurement	Created	Count												
Value Identifier Type	Short Hand Description	Unit of Measure												
Measurement	Total	Count												

Field	Activity Processing Snapshot Aggregator			Activity Processing Derived Snapshot Aggregator		
	Value Identifier Type	Short Hand Description	Unit of Measure	Value Identifier Type	Short Hand Description	Unit of Measure
	Value 01	Completed	Count	Value 10	Discarded	Count
	Value 02	Error	Count	Value 01	Completed	Count
	Value 03	Discarded	Count	Value 02	Error Total	Count
				Value 03	Error in Field	Count
				Value 04	Error in Command	Count
				Value 05	Error in Orchestrator	Count
				Value 06	In Progress Total	Count
				Value 07	In Progress in Field	Count
				Value 08	In Progress in Command	Count
				Value 09	In Progress in Orchestrator	Count
Sub-Aggregator Types	N/A			N/A		
Display Configuration	Hours of Chart Data to Display: 480 Default Measurement Condition: Regular			Hours of Chart Data to Display: 480 Default Measurement Condition: Regular		

Master Aggregator Measuring Component Types:

Field	Activity Processing Accumulation Aggregator	Activity Aging Snapshot Aggregator
Measuring Component Type	ACT_PROC_ACC_AGG	ACT_AGN_SNAP_AGG
Description	Activity Processing Accumulation Aggregator	Activity Aging Snapshot Aggregator
Measuring Component Type Business Object	Activity Statistics Master Aggregator Type	Activity Statistics Master Aggregator Type
Measuring Component Business Object	Activity Processing Accumulation Aggregator	Activity Aging Snapshot Aggregator
Measurement Business Object	Measurement	Measurement

Field	Activity Processing Accumulation Aggregator			Activity Aging Snapshot Aggregator		
Service Type	Electric			Electric		
Interval Size	24:00:00			24:00:00		
Fallback Time Zone	US Eastern Time			US Eastern Time		
Consumptive/Subtractive	Consumptive			Consumptive		
Activity Aggregator Type	Activity Processing			Activity Aging Snapshot		
Aggregation	Aggregation Horizon: 5			Aggregation Horizon: 5		
	Aggregation Lag: 2			Aggregation Lag: 2		
	Aggregation Cut-Off Time: 12:00:00			Aggregation Cut-Off Time: 12:00:00		
Value Identifiers	Value Identifier Type	Short Hand Description	Unit of Measure	Value Identifier Type	Short Hand Description	Unit of Measure
	Measurement	Activity Count	Count	Measurement	Average Completion Time	Count
	Value 10	Discarded Count	Count	Value 01	Completed Within Tolerance	Count
	Value 01	Completed Count	Count	Value 02	12-19 Hours Late	Count
	Value 02	Error Count	Count	Value 03	20-27 Hours Late	Count
	Value 03	Error in Field	Count	Value 04	28+ Hours Late	Count
	Value 04	Error in Command	Count			
	Value 05	Error in Orchestrator	Count			
	Value 06	In Progress Count	Count			
	Value 07	In Progress in Field	Count			
	Value 08	In Progress in Command	Count			
	Value 09	In Progress in Orchestrator	Count			

Field	Activity Processing Accumulation Aggregator	Activity Aging Snapshot Aggregator																				
Sub-Aggregator Types	<table border="1" style="width: 100%; border-collapse: collapse;"> <thead> <tr> <th style="text-align: left;">Activity Aggregator Type</th> <th style="text-align: left;">Measuring Component Type</th> </tr> </thead> <tbody> <tr><td>Activity</td><td>Activity</td></tr> <tr><td>Processing</td><td>Processing</td></tr> <tr><td>Derived</td><td>Derived</td></tr> <tr><td>Snapshot</td><td>Snapshot</td></tr> <tr><td></td><td>Aggregator</td></tr> <tr><td>Activity</td><td>Activity</td></tr> <tr><td>Processing</td><td>Processing</td></tr> <tr><td>Snapshot</td><td>Snapshot</td></tr> <tr><td></td><td>Aggregator</td></tr> </tbody> </table>	Activity Aggregator Type	Measuring Component Type	Activity	Activity	Processing	Processing	Derived	Derived	Snapshot	Snapshot		Aggregator	Activity	Activity	Processing	Processing	Snapshot	Snapshot		Aggregator	N/A
Activity Aggregator Type	Measuring Component Type																					
Activity	Activity																					
Processing	Processing																					
Derived	Derived																					
Snapshot	Snapshot																					
	Aggregator																					
Activity	Activity																					
Processing	Processing																					
Snapshot	Snapshot																					
	Aggregator																					
Display Configuration	Hours of Chart Data to Display: 720 Default Measurement Condition: Regular	Hours of Chart Data to Display: 480 Default Measurement Condition: Regular																				

Create Activity Aggregator Measuring Components

Create an activity aggregator measuring component for each activity type you wish to capture for each measuring component type you created above. For example, if you wanted to capture statistics for request orchestration activity types (such as Enable Service, Disable Service, and so on) for the above measuring component types, you would create a total of 24 measuring components, as follows:

Measuring Component Type	Aggregation Dimensions — Activity Type	Aggregation Dimensions — Service Type
Activity Processing Accumulation Aggregator	Back to Back Orchestrator	Electric
Activity Aging Snapshot Aggregator	Back to Back Orchestrator	Electric
Activity Processing Snapshot Aggregator	Back to Back Orchestrator	Electric
Activity Processing Derived Snapshot Aggregator	Back to Back Orchestrator	Electric
Activity Processing Accumulation Aggregator	Cut for Non Payment Orchestrator	Electric
Activity Aging Snapshot Aggregator	Cut for Non Payment Orchestrator	Electric
Activity Processing Snapshot Aggregator	Cut for Non Payment Orchestrator	Electric
Activity Processing Derived Snapshot Aggregator	Cut for Non Payment Orchestrator	Electric
Activity Processing Accumulation Aggregator	Disable Service	Electric
Activity Aging Snapshot Aggregator	Disable Service	Electric
Activity Processing Snapshot Aggregator	Disable Service	Electric
Activity Processing Derived Snapshot Aggregator	Disable Service	Electric
Activity Processing Accumulation Aggregator	Enable Service	Electric
Activity Aging Snapshot Aggregator	Enable Service	Electric
Activity Processing Snapshot Aggregator	Enable Service	Electric

Measuring Component Type	Aggregation Dimensions — Activity Type	Aggregation Dimensions — Service Type
Activity Processing Derived Snapshot Aggregator	Enable Service	Electric
Activity Processing Accumulation Aggregator	Exchange Meter	Electric
Activity Aging Snapshot Aggregator	Exchange Meter	Electric
Activity Processing Snapshot Aggregator	Exchange Meter	Electric
Activity Processing Derived Snapshot Aggregator	Exchange Meter	Electric
Activity Processing Accumulation Aggregator	Reconnect Service for Payment Orchestrator	Electric
Activity Aging Snapshot Aggregator	Reconnect Service for Payment Orchestrator	Electric
Activity Processing Snapshot Aggregator	Reconnect Service for Payment Orchestrator	Electric
Activity Processing Derived Snapshot Aggregator	Reconnect Service for Payment Orchestrator	Electric

If you wanted to also capture statistics for smart meter commands or field task types, you would need to create activity aggregator measuring components for each individual command or field task type for each measuring component type.

If you are creating service order activities from multiple initiating systems (such as a customer information system and a network management system), you would need to create separate sets of activity aggregator measuring components for each initiating system.

Configure the Service Order Management Master Configuration

You can access the Master Configuration portal by selecting **Admin**, then **General**, then **Master Configuration**.

Select the Service Order Management Master Configuration.

Use the **Add** button beside the record to configure for the first time. If a record has already been added, then click the **Edit** button instead. Use the embedded help to guide you through the meaning of each configuration field.

Create an Activity for each Measuring Component Type

Create an activity for each measuring component type created above. Based on the example above (from the demonstration database) you would create an activity for each of the following measuring component types for each service type:

- Activity Processing Accumulation Aggregator
- Activity Aging Snapshot Aggregator
- Activity Processing Snapshot Aggregator
- Activity Processing Derived Snapshot Aggregator

For example, if you configured measuring component types for both "Electric" and "Water" service types, you would create eight activities (two of each of the types listed above).

Use the following procedure to create these activities:

1. Select **Menu**, then **Communication**, then **Activity**, then **Add**. The **Select Type** page opens.
2. Select "Activity Statistics Aggregator Creator" from the **Activity Type** drop-down list and click **OK**. The **Activity Statistics Aggregator Creator** page opens.
3. Select the appropriate measuring component type from the **Aggregator Measuring Component Type** drop-down list.
4. Select the appropriate service type ("E", "Water", and so on) from the **Service Type** drop-down list.
5. Click **Save**.

See [Maintaining Activities](#) in the *Business User Guide* for more information about creating and maintaining activities.

Aggregation and Batch Processing

The Service Order Management dashboards are based on aggregated data, and are configured to be refreshed daily. To refresh the data used in the dashboard, the following aggregation and batch processes should be processed in sequence each day.

Dimension Scanning

- **D1-ADS** (Aggregation Dimension Scanner Monitor): Used to transition "Activity Statistics Aggregator Creator" activities (created above) to the "Scan" state which checks for aggregator measuring components based on each measuring component type for each combination of dimensions. If needed, this process creates additional aggregator measuring components.

Use the following parameters when running this batch process:

- Measuring Component Maintenance Object (maintenanceObject): D1-ACTIVITY
- Restrict by Batch Code (isRestrictedByBatchCode): true
- Restrict to Business Object (restrictToBusinessObject): D1-ActivityStatsAggtorCreator
- Restrict by Status Code (restrictToBOStatus): ACTIVE

Note: Dimension scanning can also be performed manually by clicking **Scan** on the individual activities in the **Activity** portal.

Aggregation

- **D1-ACTAG** (Activity Statistics Aggregation Monitor): Used to aggregate activity data (via aggregator measuring components) to be displayed in the Service Order Management dashboards.

Use the following parameters when running this batch process:

- Restrict by Batch Code (isRestrictedByBatchCode): true
- Restrict to Business Object (restrictToBusinessObject): Aggregator Measuring Component business object, based on the measuring component types configured earlier:
 - D1-ActivityAgingSnapAggtor (Activity Aging Snapshot Aggregator)
 - D1-ActivityProcsAggregator (Activity Processing Accumulation Aggregator)
 - D1-ActivityProcDerivedSnapAgg (Activity Derived Snapshot Aggregator)
 - D1-ActivityProcSnapAggtor (Activity Processing Snapshot Aggregator)
- Restrict by Status Code (restrictToBOStatus): ACTIVE
- Override Maximum Errors (maxErrors): 1000

Note: Aggregation can also be performed manually by clicking **Update Statistics** on the **Activity Statistics** dashboard zone.

Configuring the Product Use Metrics Dashboard

This section describes the process for configuring the **Product Use Metrics** dashboard used with Oracle Utilities Meter Data Management and Oracle Utilities Meter Solution Cloud Service.

The Product Use Metrics displays customer counts such as device counts, channels of an active meters, number of billable services, head end device counts, and other similar data. The data presented on each dashboard is tailored to provide summary information for management. Refer to [Product Use Metrics](#) for more information about this dashboard.

This dashboard leverages a method of pre-staging data known as Statistics Snapshots. See [Understanding Statistics](#) for more information on Statistics Snapshots.

Configuring the **Product Use Metrics** dashboard includes the following:

Configure Statistic Control and Statistic Snapshots

Statistic Controls are the source for capturing the numbers of active devices, channels on active meters, billable services, and device counts per head end system.

Statistic Snapshots capture the numbers for each metric. Statistic Controls are configuration records that define the specific types of metrics to capture.

Statistic Snapshots are captured periodically via the F1-STATS (Statistics Control Monitor) batch program.

Configure the following Statistics Control records:

Statistics Control	Description	Category	Status	Snapshot Frequency	Retention Mode	Snapshot Business Object
CHANNEL-COUNT	Channel Count	Product Use Metrics	Active	1.00	Only Retain Most Recent Snapshot	Channel Count Snapshot
DEVICE-COUNT	Device Count	Product Use Metrics	Active	1.00	Only Retain Most Recent Snapshot	Device Count Snapshot
HEAD-END-DEVICE-COUNT	Head End Device Count	Product Use Metrics	Active	1.00	Only Retain Most Recent Snapshot	Head End Device Count Snapshot
US-CUSTOMER-COUNT	Usage Subscription Customer Count	Product Use Metrics	Active	1.00	Only Retain Most Recent Snapshot	Usage Subscription Customer Count Snapshot
BILLABLE-SERVICES	Billable Services by Service Type, SA Type, and CIS Division	Product Use Metrics	Active	1.00	Only Retain Most Recent Snapshot	Billable Services Statistics Snapshot

See [Capturing Statistics](#) for more information about statistics.

Configure Device Count and Channel Count Snapshot Business Objects and Algorithms (Optional)

By default, the Device Count Snapshot and Channel Count Snapshot business objects check for active usage subscriptions when deriving the total count of active devices and measuring components. However, in some implementations this is not required or appropriate.

The usage subscription check can be disabled if needed by setting the "Exclude US Check (Y or N)" parameter on the "Create XXXXX Count Snapshot" Enter algorithms on the Complete state of the Snapshot business objects to "Y" (this parameter is set to "N" by default).

The table below lists the snapshot business objects and their respective algorithms.

Snapshot Business Object	Count Snapshot Algorithm
Channel Count Snapshot (D1-ChannelCountSnapshot)	Create Channel Count Snapshot (D1-CHLCNTSNP)
Device Count Snapshot (D1-DeviceCountSnapshot)	Create Device Count Snapshot (D1DVCCNTSNP)

Configure Statistics Control Business Object

The Statistics Control (F1-Statistics) business object should be configured to specify the "Statistics Control Monitor" batch control in the **Monitor Process** drop-down list on the "Active" state.

To configure this business object, do the following:

1. Open the Statistics Control (F1-Statistics) business object in the **Business Object** portal.
2. Navigate to the **Lifecycle** tab, and expand the "Active" state.
3. Select "Statistics Control Monitor" from the **Monitor Process** drop-down list.
4. Click **Save**.

Batch Processing

The **Product Use Metrics** dashboard is configured to be refreshed periodically. To refresh the data used in the dashboard, the following batch processes should be processed in sequence after other regularly schedule batch processing is complete.

- **F1-STATS** (Statistics Control Monitor): Used to generate Statistic Snapshots based on Statistic Controls.

Use the following parameters when running this batch process:

- Maintenance Object (maintenanceObject): F1-STATS
- Restrict by Business Object (restrictToBusinessObject): F1-Statistics
- Restrict by Status Code (restrictToBOStatus): ACTIVE

Measurement Reprocessing

Configuring Measurement Reprocessing

This section describes the process for configuring Measurement Reprocessing.

Refer to the [About Measurement Reprocessing](#) section of the *Oracle Utilities Meter Solution Business User Guide* for more functional information.

Activity Type Configuration

Configuration for Measurement Reprocessing is performed by adding or changing an Activity Type. You can access the portal from the **Admin > Communication > Activity Type**.

Once the Activity Type search screen returns, locate the following records:

- **Measurement Reprocess Activity - Interval:** this Activity Type handles measurement reprocessing for interval Measuring Components.
- **Measurement Reprocess Activity - Scalar:** this Activity Type handles measurement reprocessing for scalar Measuring Components.

Use the **Add** button beside the record to configure for the first time. If a record has already been added, then click the **Edit** button instead. Use the embedded help to guide you through the meaning of each configuration field. By adding these Activity Types you are activating the process within Oracle Utilities Meter Data Management that will monitor changes to either the Measuring Component multiplier (the **Register Multiplier** for register measuring components or **Channel Multiplier** for interval and auto-read register measuring components) or the Install Event's **Installation Constant** or **Installation Date/Time**. If any of these attributes change for a device, then a new Activity will be created that attempts to reprocess the measurements for the affected period.

Related Batch Controls

There are a few batches involved with Measurement Reprocessing:

- **Measurement Reprocessing Monitor (D1-MRAC)**: this processes any new Measurement Reprocessing activities that are created.
- **Measurement Reprocessing - Retry Monitor (D1-MRER)**: this process retries any Measurement Reprocessing activities that fail to the Issue Detected state.

Information Lifecycle Management (ILM)

Understanding Information Lifecycle Management (ILM)

Information Lifecycle Management (ILM) is a separately licensable component of Oracle Utilities Customer to Meter that works in tandem with Oracle database feature of the same name.

For further background on the overall ILM process see the [Information Lifecycle Management](#) chapter of the Oracle Utilities Application Framework *Administrative User Guide*.

This section provides an overview of the components used by the Information Lifecycle Management functionality, including:

- ILM-Enabled Maintenance Objects: Single Retention Period
- ILM-Enabled Maintenance Objects: Multiple Retention Periods
- Adjusting Eligibility of Non-Final Transactions
- Archive Eligibility Hierarchy
- Multiple Retention Period Eligibility Crawling Strategies

Refer to the [Information Lifecycle Management](#) chapter of the Oracle Utilities Application Framework *Administrative User Guide* for general information about how ILM works with OUAF applications.

ILM-Enabled Maintenance Objects: Single Retention Periods

The majority of Maintenance Objects support a single retention period. They can either inherit the system wide retention days that are configured on the ILM Configuration master configuration or they can have a retention period specified via the Maintenance Object option ILM Retention Period in Days.

For these objects either the Maintenance Object specific retention period or the system wide retention period will apply to all transactions.

ILM-Enabled Maintenance Objects: Multiple Retention Periods

For several Maintenance Objects the retention period may vary based on the type of transaction. For example, initial measurement data for non-billed units of measure such as voltage might be archived much more rapidly than measurements that feed into the production of billing determinants.

These maintenance objects are differentiated from the single retention period maintenance objects in a few ways:

- The primary table for the entity has an additional column Retention Period (RETENTION_PERIOD) that captures the retention period in days for each transaction. This value is populated based on the ILM Configuration - MDM master configuration.
- There is additional configuration available on the ILM Configuration -MDM master configuration to define multiple retention periods by maintenance object specific criteria

- Initial Measurement Data: retention periods can be specified by type of IMD (Interval vs Scalar), and primary UOM of the measuring component
- Device Events: retention periods can be specified by device event type category
- Activities: retention periods can be specified by activity type category
- There is a special ILM Crawler batch that supports crawling transactions by their specific retention periods
- A combination of each transactions ILM Date and Retention Period are considered when identifying records to evaluate for eligibility. Refer to batch controls ILM Crawler - Device Event (D1-DECRL), ILM Crawler - IMD (D1-IMDCL), or ILM Crawler - Activity (D1-ACTCR) for more details.
- There is an additional maintenance object option ILM Date Partition Months which feeds into the ILM Crawler batch to delay processing until all records on a partition would be eligible. This is explained later in this section under the header Multiple Retention Period Eligibility Crawling Strategies.

Adjusting Eligibility of Non-Final Transactions

As delivered Oracle Utilities Meter Data Management and Customer to Meter maintenance objects allow non-final transactions to be eligible for archive. This is a logical approach when transactional data has a very long retention period (e.g. 3 year old non-final Initial Measurement Data is unlikely to have relevance and in many circumstances shouldn't be finalized).

If non-final transactions should not be eligible for archive this can be controlled at either the Maintenance Object (MO) or Business Object (BO) level:

- **MO - ILM Restrict By Status (Y/N):** Setting this to "Y" opts into the ability to restrict archiving by status, this is required to be set for either of the MO or BO level restrictions to be considered. To enforce the status it requires that either the **ILM Restrict By BO Final Status (Y/N)** or **ILM Final Status Field Value** options be configured as well.
- **MO - ILM Restrict By BO Final Status (Y/N):** Setting this to "Y" indicates the transactions for the MO must be in a final status to be eligible for ILM. A status is considered to be final based on the BO lifecycle configuration. This can be overridden by the BO option **Final Status Required for Archive (Y/N)**. This is only applicable for an MO that is maintained by business objects.
- **BO - Final Status Required for Archive (Y/N):** Setting this to "Y" indicates the transactions for this particular BO must be in a final status. This setting overrides the MO level **ILM Restrict By BO Final Status (Y/N)**.

The following table helps to illustrate how these three settings impact whether a given transaction must be in a final status:

• MO: ILM Restrict By Status	• MO: ILM Restrict By BO Final Status	• BO: Final Status Required for Archive	• Final Status Required for Eligibility?
• N	• Y	• Y	• N
• N	• Y	• N	• N
• N	• N	• Y	• N
• Y	• N	• N	• N
• Y	• Y	• N	• N
• Y	• Y	• Y	• Y
• Y	• N	• Y	• Y
• Y	• Y	• Not Provided	• Y

MO: ILM Restrict By Status	MO: ILM Restrict By BO Final Status	BO: Final Status Required for Archive	Final Status Required for Eligibility?
Y	N	Not Provided	N

NOTE: There are a few MOs that do not support the BO level setting. To best understand how these fields are interpreted for an MO refer to the detailed description of the algorithm plugged into the ILM Eligibility system event for the MO. For example, the generic ILM Eligibility Based on Status (F1-ILMELIG) algorithm does not support the BO level override option.

CCB ILM Enabled MOs

The table below summarizes details of the eligibility algorithms for each maintenance object supported by ILM. The CCB MOs support only a single retention period and many CCB MOs do not support the BO level setting. Information on this table includes:

- **ILM Eligibility Algorithm Type:** The algorithm type description contains and specific consideration that are considered when determining if the record is eligible for ILM. Please review the algorithm type for the details including object cascading.
- **Restrict Status by:** If the framework ILM eligibility algorithm is used, the restricted status as delivered with the system are shown.

Maintenance Object	ILM Eligibility Algorithm Type	RestrictedStatus by
Adjustment	C1-ADJILMELG	N/A
Bill	C1-ILMELG-BL	N/A
Bill Segment	C1-ILMELG-BS	N/A
Billable Charge	F1-ILMELIG	Canceled
Usage	F1-ILMELIG	Not Restricted
Case	F1-ILMELIG	Closed
Order	F1-ILMELIG	Complete, Canceled
Field Activity	F1-ILMELIG	Complete, Canceled
Meter Read	C1-ILMELG-MR	N/A
Payment Event	C1-PEVILMELG	N/A
Customer Relationship Request	F1-ILMELIG	Not Restricted
Match Event	C1-MEVILMELG	N/A

Archive Eligibility Hierarchy

The table below summarizes details of the eligibility algorithms for each Oracle Utilities Meter Data Management maintenance object supported by ILM. Information on this table includes:

- **Cascaded By:** Indicates how archiving for transactions for the maintenance object is initiated. For example, device events can be archived by themselves or as part of a related activity.
- **ILM Date Computation:** Indicates the type(s) of transactions that impact the calculation of the ILM Date for transactions for the maintenance object. "Itself" indicates that the ILM date is not impacted by other transactions.
- **Specific Eligibility Considerations:** Indicates specific considerations used by the eligibility algorithm.

- Cascaded Transactions: Indicates other transactions that are archived when transactions for the maintenance object are archived. For example, VEE exceptions are archived with initial measurements.

Maintenance Object	Cascaded By	ILM Date Computation	Specific Eligibility Considerations	Cascaded Transactions
Initial Measurement		Create date	VEE Exceptions must be eligible Associated Related MC Synchronization activity must be complete	VEE Exceptions
VEE Exception	Initial Measurement	Earlier of related Initial Measurement or VEE Exception Create Date	Related Service Issue Monitor must be complete	
Usage Transaction		The latest create date for all related usage transactions	All related usage transactions must be eligible for archiving	Related Usage Transactions
Device Event	Activity	Create date Superseded by paired event create date if earlier (where applicable)	Related paired events must be eligible Related service issue monitor must be complete Related activity must be complete	
Activity	Parent activity	Create date Superseded Device event, child activity, or completion event create date supersede (where applicable)	Cascaded transactions must be eligible Command requests must not be associated to a non-final service issue monitor Command requests must not be associated to an install event on off history entry	Child activities Device events Outbound communications Inbound communications Completion events
Outbound Communication	Activity	Create Date Superseded by initiating activity's create date (where applicable)		Inbound communication
Inbound Communication	Outbound Communication	Create date Superseded by initiating outbound communication create date (where applicable)		Device events

Proactive Archive Eligibility for Transactional Data

Some types of transaction data, including Device Events, Initial Measurement Data, and Usage Transactions can be analyzed for archive eligibility as they are received rather than waiting until their retention period has expired. This means that these records are judged ready to be archived as they are created and do not need to be read, analyzed, and updated during the ILM crawling process. This greatly reduces the number of records to be crawled at the end of the retention period

and shortens the window of time required for ILM crawling. This section outlines how the ILM Archive switch (ILM_ARCH_SW) is set to “Y” (Yes) for records of these types as part of their initial processing.

- **Device Events:**

- The ILM Archive switch is set to “Y” for device events that meet the following criteria:
 - No service issue monitors were created for the device event
 - The device event is not a paired device event
- The ILM Archive switch is set to “Y” for device events via the following algorithms:
 - Create Service Issue Monitor from Device Event (D1-DVCEVTSIM)
 - Create Service Issue Monitor from Device Event for Paired Event (D1-PRDVEVSIM)

- **Initial Measurement Data:**

- The ILM Archive switch is set to “Y” by default for initial measurements (this is a different approach than the other record types).
- The ILM Archive switch is set to “N” for initial measurements that meet the following criteria:
 - A consumption synchronization activity has been created for the initial measurement
 - A service issue monitor initiated from a VEE exception related to the initial measurement
- The ILM Archive switch is set to “N” for initial measurements that meet the above criteria via the following algorithms:
 - Update Latest Measurement Date/Time on Scalar MC with Consumption Sync (D1-UDTSCMCRE)
 - Update Latest Measurement Date/Time on MC with Consumption Sync (D1-UPD-DTMC)
 - Create Service Issue Monitor from VEE Exception (D2-VEEEXCSIM)

- **Usage Transactions:**

- The ILM Archive switch is set to “Y” when a usage transaction enters the “Sent” or “Discarded” state (or the “Calculated” or “Discarded” states for a sub-usage transaction) via the following algorithms:
 - Send Usage (D2-SEND-USG)
 - Set ILM Switch to ‘Y’ (D1-SETILMSWY)

Multiple Retention Period Eligibility Crawling Strategies

When multiple retention periods are defined for a maintenance object each record will have its retention period written to the database at the time of record creation. This retention period is then used to identify when the record will be ready for eligibility evaluation (aka crawling).

NOTE: As specified in the Oracle Utilities Meter Data Management Database Administrator's Guide each unique retention period for the maintenance object will be a sub-partition within a given ILM date partition.

The system supports two methodologies for doing so:

- Evaluate Individual Records:
- This is our default approach
- This is the standard approach to evaluating ILM retention for all maintenance objects with a single retention period
- The ILM date for each record will be compared against the current date less the retention period for that type of record. Simply stated, any records older than the retention period will be evaluated for eligibility.
- In this option we will process a portion of a partition each day and only once we had processed the entire partition would the DBA be able to take an archiving action on the partition

- This results in many visits to the partition to determine eligibility
- The image below illustrates how the evaluate individual records method will crawl one day of records on a partition and sub-partition each day until the retention period for the last day of the partition had expired. All records would then be archived together when the last day of the partition was marked as eligible. This results in daily processing of small amounts of records but frequent visits to the partition.



- Evaluate the Entire Partition
- This option will be enabled by configuring the ILM Date Partition Months in the maintenance object options
- In this option all records on a ILM date partition retention period sub-partition will be evaluated at the same time.
- For example, for a monthly partitioning strategy in the month of January we would not evaluate any records in the January partition until January 31st had reached the end of its retention period.
- This means that we would evaluate the 1st through the 31st all at one time
- This option should typically result in a single visit to the partition to determine eligibility
-
- The image below illustrates how the evaluate entire partition method will only crawl records from a given partition and sub-partition when all records on that partition are eligible to be evaluated. Therefore, when the last day of the partition is ready to be evaluated the entire partition will be evaluated. This results in periodic processing with, and in many cases, a single visit to the partition for ILM purposes.

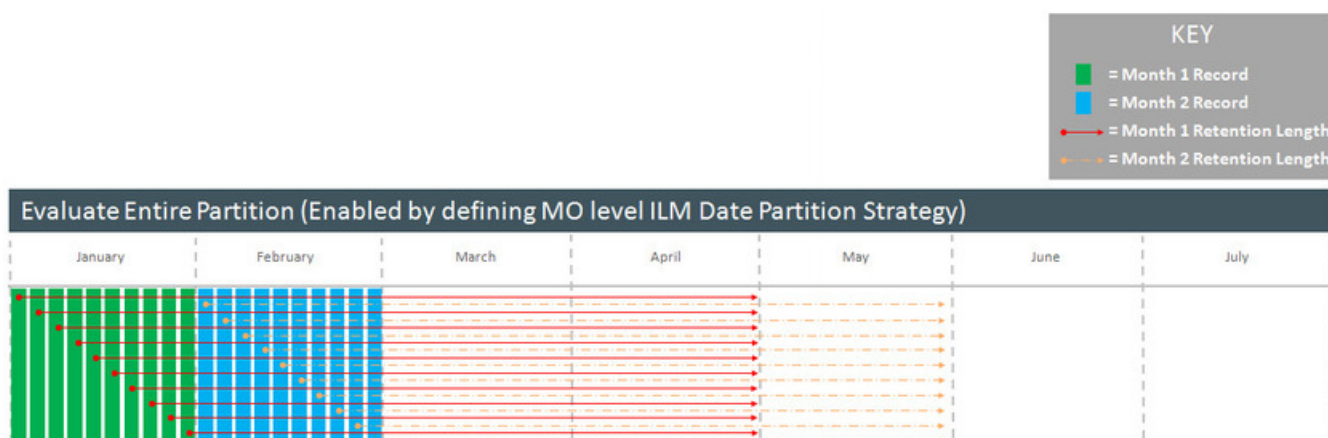

Configuring Information Lifecycle Management (ILM)

For additional information on configuring ILM, see [Enabling ILM for Supported Maintenance Objects](#) in the Oracle Utilities Application Framework *Administrative User Guide*.

The tasks described in the OUAF guide must be applied in conjunction with the task of configuring the Oracle Utilities Meter Data Management specific master configuration.

You can access the portal from the **Admin > General > Master Configuration**.

Once the Master Configuration screen returns, locate the following record:

- **ILM Configuration - MDM:** this enables multiple retention periods to be configured for Initial Measurements, Device Events, and Activities.

Related Eligibility Algorithms

There are a several Oracle Utilities Meter Data Management specific algorithms involved with ILM refer to the detailed description of the algorithm type of each algorithm for more information about the functionality each provides:

1. **ILM Eligibility - Activity (D1-ILMELGACT):** determines eligibility of Activities and cascades child Activities, Communication Out, Communication In, Device Events, and Completion Events.
2. **ILM Eligibility - Communication In (D1-ILMELGCI):** determines eligibility of Communication In.
3. **ILM Eligibility - Communication Out (D1-ILMELGCO):** determines eligibility of Communication Out and cascades Communication In.
4. **ILM Eligibility - IMD (D1-ILMELGIMD):** determines eligibility of Initial Measurement data and cascades VEE Exceptions.
5. **ILM Eligibility - Device Event (D1-ILMELGDE):** determines eligibility of Device Event data and cascades VEE Exceptions.
6. **ILM Eligibility - Usage Transaction (D1-ILMELIGUT):** determines eligibility of Usage Transactions.
7. **ILM Eligibility - Usage Transaction Exception (D1-ILMELGUEX):** determines eligibility of Usage Transaction Exceptions.
8. **ILM Eligibility - VEE Exception (D1-ILMELGVEX):** determines eligibility of VEE Exceptions.

The following provides additional information beyond that provided in the ILM Eligibility - Activity (D1-ILMELGACT) algorithms' detailed descriptions on how specific activity types are handled:

- **Request Orchestration Activities:** Request orchestrations also archive any child activities that were created, and those child activities archive any child activities or data (completion events, device events, etc.).
- **Field Activities / Command Activities:** Field activities and command request activities are archived either as part of a request orchestration or by themselves. When a field activity/command request is archived, it also archives any of the following child transactions:
 - Update/Cancel Orchestrators
 - Communication Out
 - Communication In
 - Completion Event
- **Non-Dispatchable Activities:** Non-Dispatchable activities archived either as part of a request orchestration or by themselves. When a non-dispatchable activity is archived it also archives child completion events.

- **Orchestration Maintenance Activities:** Orchestration Maintenance activities are only archived by themselves if they do not have a related activity. When an orchestration maintenance activity is archived it also archives any of the following child transactions:
 - Communication Out
 - Communication In
- **Device Event Activities:** Presently device event activities are limited to outages which have an initiating and an ending device event. These types of activities cannot be archived until their related device events are either archived or ready to archive. However the device events do not have to wait for the activity to archive so the device events are not updated with the activity's ILM date.
- **Bulk Activities:** Bulk Activities are comprised of the Bulk Header and the Bulk Request/Response, and depending on how the header was created there will be one header to many bulk requests/responses. The Bulk Header will only be eligible for archive if all related Bulk Request activities are also eligible for archiving. All related bulk activities are archived together. Bulk activities also generate one-to-many command request activities. Those individual command activities are archived separately.
- **Extract Request Activities:** These activities are used to request data from the head-end system on a periodic basis. Extract request activities should be in a final state prior to being archived.
- **Other Activities:** Other types of activities can be archived provided they do not require any special logic for handling for archiving purposes, such as checking for related data. These activity types can archive without checking related transactions:
 - Consumption Sync
 - Dimension Scanner
 - Error Activity
 - Measurement Quantity (deprecated)
 - Meter Read Download Activity
 - Suppression
 - Usage Transaction Correction Processor

In the event that your implementation uses custom activity types that require special handling, a custom algorithm should be created and added prior to the base package algorithm to preemptively handle the activity type category.

Related Batch Controls

There are a several Oracle Utilities Meter Data Management specific batch controls involved with ILM:

1. **ILM Crawler - Activity (D1-ACTCR):** identifies and executes eligibility evaluation for Activities. This batch control supports multiple retention periods.
2. **ILM Crawler - Communication In (D1-CICRL):** identifies and executes eligibility evaluation for Communication In.
3. **ILM Crawler - Communication Out (D1-COCRL):** identifies and executes eligibility evaluation for Communication Out.
4. **ILM Crawler - Device Event (D1-DECRL):** identifies and executes eligibility evaluation for Device Events.
5. **ILM Crawler - IMD (D1-IMDCL):** identifies and executes eligibility evaluation for Initial Measurement Data. This batch control supports multiple retention periods.
6. **ILM Crawler - Usage Transaction Exception (D1-UEXCL):** identifies and executes eligibility evaluation for Usage Transaction Exceptions.
7. **ILM Crawler - Usage Transaction (D1-UTCRL):** identifies and executes eligibility evaluation for Usage Transactions.
8. **ILM Crawler - VEE Exception (D1-VEXCL):** identifies and executes eligibility evaluation for VEE Exceptions.

For additional details see the [Batch Processes](#) section the Oracle Utilities Application Framework *Administrative User Guide*.

Outage Storm Mode

Configuring Outage Storm Mode

This section describes the process for configuring Outage Storm Mode.

NOTE: Refer to the [About Outage Storm Mode](#) section of the *Oracle Utilities Meter Solution Business User Guide* for more functional information.

Master Configuration settings

Configuration for Outage Storm Mode is performed by adding or changing a Master Configuration. You can access the portal from the **Admin > General > Master Configuratio**

Once the Master Configuration search screen returns, locate the **MDM Master Configuration**. Use the Add button beside the record to configure for the first time. If a record has already been added, then click the Edit button instead. The **Estimation Eligibility For Widespread Outages** section is the primary section that needs to be configured for Outage Storm Mode to be enabled. Use the embedded help to guide you through the meaning of each configuration field.

Setup Meter Communication Tracking Aggregation

As part of Outage Storm Mode, aggregations are performed to determine the percentage of meter communication that has occurred for an area. The following configuration supports this:

1. Access the portal for Measuring Component Type through **Admin > Device > Measuring Component Type**. Add a new Measuring Component Type using the **Meter Communication Tracking Aggregator Type** (D2-MtrCommTrckngAggregatorType) business object. Follow the embedded help provided for each section. Two areas listed below are crucial to preparing for this specific aggregation:
 - a. When selecting a Measuring Component Business Object for this record, choose the **Meter Communication Tracking Aggregator** Business Object.
 - b. For the Value Identifiers, there are a few metrics that are can be defined as listed on the D2-AGG-MCTM Algorithm Type:
 - a. Read Percentage
 - b. Count of Received Measuring Components
 - c. Count of Total Measuring Components
2. Access the portal for Activity Type through **Admin > Communication > Activity Type**. Add a new record for the Meter Communication Tracking Dimension Scanner Activity Type.
3. Access the portal for Activity through **Main > Communication > Activity**. Add a new record for the Activity Type you defined in the prior step.

Standard Event Name Configuration

If there is a desire to indicate that a widespread outage has ended for a device when it receives certain device events, the **Standard Event Name** Extendable Lookup can be used for this. You can access the portal from the **Admin > General > Extendable Lookup**

Any Device Event that should close out Estimation Suppression Activities must be configured with the "End Estimation Suppression" algorithm (D2-EN-ESTSUP) in the Additional Processing Algorithms section. This is often configured for "Power Up" events to indicate that normal power flow has resumed for the meter.

Related Batch Controls

There are a few batches directly involved with Outage Storm Mode:

- **Dimension Scanner (D1-ADS):** monitors the "Meter Communication Tracking Dimension Scanner" business object. New Aggregator Measuring Components will be created for every applicable Service Type, Postal Code, and Head End in the system.
- **Aggregation Monitor (D2-AGG):** runs to execute the logic for the "Meter Communication Tracking Aggregator" Measuring Component. This logic will aggregate all meters for the defined Service Type, Postal Code, and Head End. Once the read percentage is found for that day then a measurement will be created for the Aggregator Measuring Component.
- **Estimation Suppression Monitor (D1-ESTSU):** This batch monitors the Estimation Suppression activities for processing. This batch should be scheduled to run regularly so it can clean up Suppression Activities if they have ended.
- **Widespread Outage (D2-WSO):** This batch queries the Meter Communication Tracking Aggregators to determine if any have experienced a widespread outage. For any actively in outage mode, then the batch will find all related Service Points and execute the logic on the algorithm plugged into the BO system event of "Estimation Suppression". It's recommended that D2-WSO be scheduled shortly after aggregation D2-AGG.

Detailed Examples of Outage Storm Mode

Scenario 1: Meter is marked estimation ineligible then received metered data with outage events

The following configuration settings should be assumed for this example:

Master Config option	Value
Check Widespread Outages	Yes
Read Percentage Days to Examine	7
Percent Drop From Norm - Estimation Ineligible	30.0%
Minimum Device Count For Ineligibility	100
Days Before Becoming Ineligible	0
Fill Missing Data With Zero	No
Days Before Filling Zero	
Maximum Estimation Ineligibility Days	3
Percent Within Norm - Resume Estimation	5.0%

Diagram:

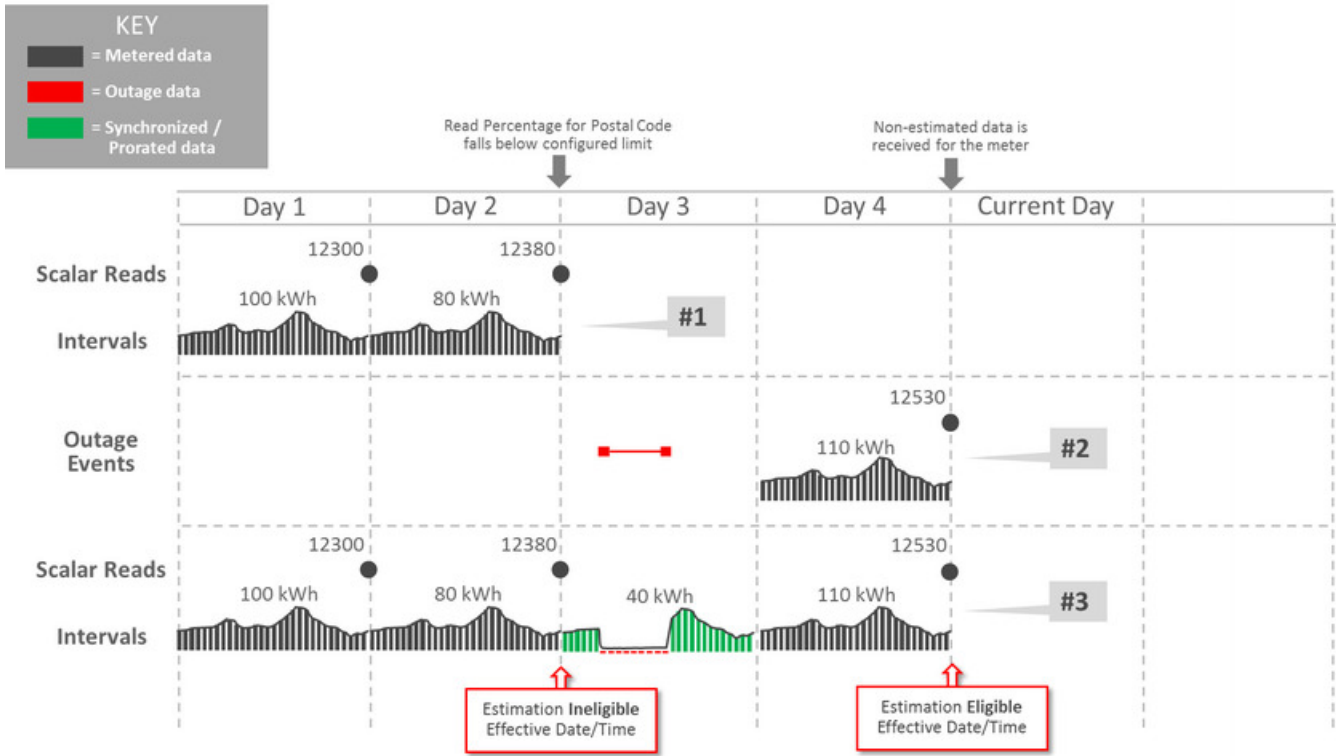

Explanation for diagram:

1. The meter was communicating consistently but then a widespread outage occurs in the same postal code so the meter has an estimation suppression created.
2. Two events are received...a Power Down event and a Power Up event. Also, Regular usage data is received from the meter. The reception of non-estimated data marks the meter as eligible for estimation again.
3. Oracle Utilities Meter Data Management estimates data and takes the two events into account. Intervals marked as outage and filled with zeros are created during the outage period by the D1-SMMTR batch.

Scenario 2: Meter is marked estimation ineligible, is filled with zeros, then receives actual data

The following configuration settings should be assumed for this example:

Master Config option	Value
Check Widespread Outages	Yes
Read Percentage Days to Examine	7
Percent Drop From Norm - Estimation Ineligible	30.0%
Minimum Device Count For Ineligibility	100
Days Before Becoming Ineligible	0
Fill Missing Data With Zero	Yes
Days Before Filling Zero	0
Maximum Estimation Ineligibility Days	3
Percent Within Norm - Resume Estimation	5.0%

Diagram:

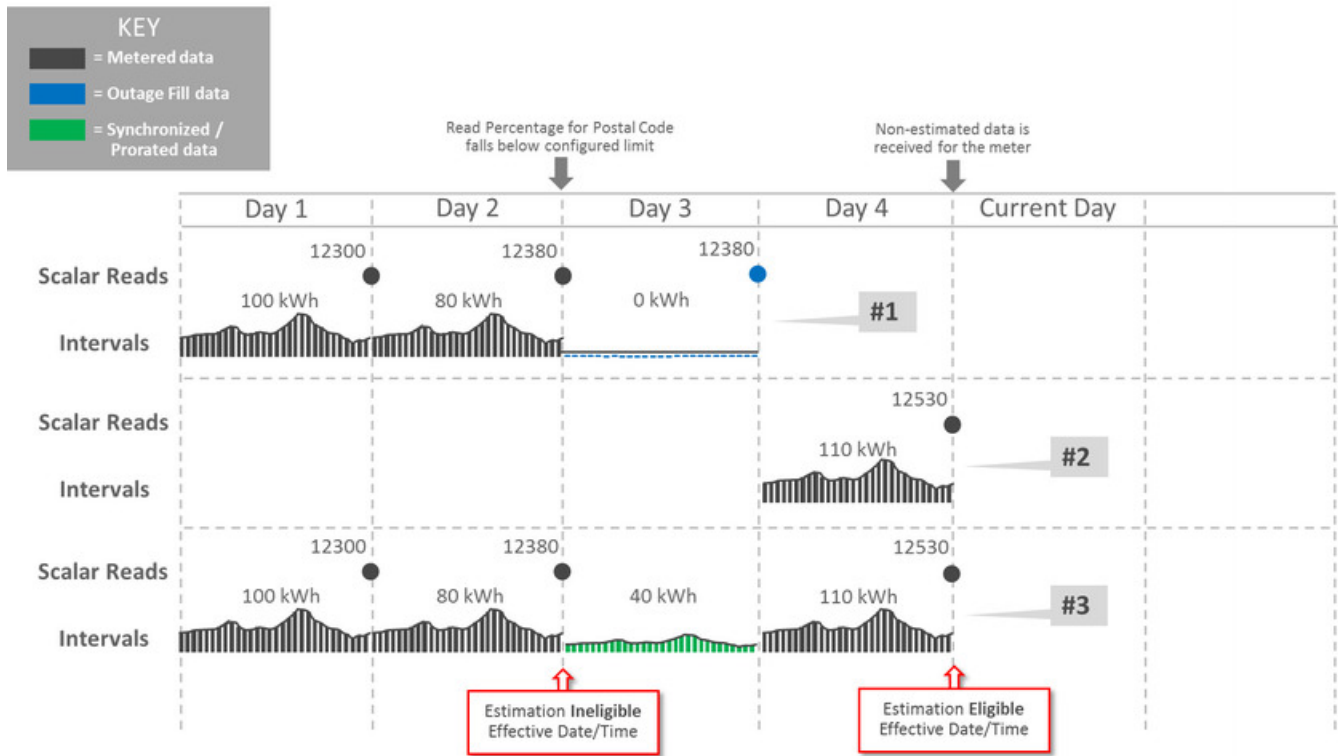

Explanation for diagram:

1. The meter loses communication and periodic estimation fills in outage intervals.
2. The meter reestablishes communication and sends in the latest readings and interval data.
3. Oracle Utilities Meter Data Management creates new data that's synchronized to fall in line with the new data from the meter by the Consumption Sync batch. This data replaces the outage measurements as it balances out to the scalar and interval data.

Running Initial Periodic Estimation

This section provides guidelines for running an initial periodic estimation process.

Overview

Prior to running the first execution of periodic estimation an assessment should be made regarding the current state of measurement data on your measuring components. Without proper preparation the first execution can take an extremely long time due to large gaps on measuring components. Since the D1-SMMTR job is threaded by device, all of the initial measurements for a device's interval and scalar channels will be created within a single work unit. This will lead to an abnormally large number of transactions being created within a single commit which can degrade performance.

There are several options available for establishing a consistent starting point for estimation across all measuring component types:

1. Configure the **Maximum Days to Estimate** on each periodic estimation eligible measuring component type. This limits the number of days periodic estimation will look backwards to create estimations. For example, if set to 60 the no estimations over 60 days old would be created and all measuring components would have their **Last Contiguous Measurement Date Time** set to 60 days ago or more recent.

2. Configure the **No of Hours in the Past to Retrieve Last Usable Measurement** option on the Measurement Data Options feature configuration. This configuration works in two specific ways:

- When the measuring component's **Last Contiguous Measurement Date/Time** has not been initialized then this setting is used to search for usable measurements starting from the **Process Date/Time** less the number of hours configured.
 - If a measurement is found, the most recent measurement within that window will be used.
 - If no measurements are found, estimates will be generated starting from the calculated start date/time.

NOTE: Note: if the calculated start date/time is very recent and not yet eligible for estimation then the measuring component's **Latest Contiguous Measurement Date/Time** will be updated with that value.

- When the **Last Contiguous Measurement Date/Time** has already been set for a measuring component this setting will be used similar to the **Maximum Days To Estimate** and will limit how far back estimation will occur.

3. Use the **Initialize Measuring Component Dates (D1-IMCDT)** batch control just prior to the first run of periodic estimation to explicitly set the **Latest Contiguous Measurement Date/Time** across all measuring components to the date you would like to estimate from.

It is important to take into consideration that the periodic estimation process is tuned with the expectation that it will create estimations for a small percentage of the meter population (generally around 2%) for one day. If on the initial run all devices have measuring components that require estimations to be created, it is increasing the typical work load exponentially: 100% of the meter populate for many days.

Lastly, it is very important, regardless of the method used, to test a small population of meters before running Periodic Estimation (D1-SMMTR) on your entire meter population. Isolated testing will alert you to potential performance issues without having to cancel a multi-day D1-SMMTR execution.

Avoiding Long Execution Time

In general the single most important thing to avoid long execution times on your first run of the Periodic Estimation batch process (D1-SMMTR) is to ensure that your measurement data is as current as it possibly can be. You should not run the Periodic Estimation process (D1-SMMTR) until you have completed conversion and you have loaded your initial set of initial measurements. If you run the Period Estimation process (D1-SMMTR) any time prior to that you risk generating estimates for data that you have but just haven't loaded yet.

If you must run the Periodic Estimation process (D1-SMMTR) prior to having all of your measurement data current, you should use the **Batch Business Date** on the batch control to limit the horizon of time you will estimating. The **Batch Business Date** won't impact the start of your horizon but it will limit the end.

The following sections provide input on several ways you can control the start of the horizon.

Overview of Options and Start of Estimation Horizon

The table below summaries various options and their impact on the Start of the Estimation horizon.

NOTE: Always ensure the **Most Recent Measurement Date/Time** is set to the measurement date/time furthest into the future. The **Initialize Measuring Component Dates (D1-IMCDT)** batch control has functionality for initializing the Most Recent Measurement Date/Time as well (if it was not set during conversion).

Measuring Component Type Maximum Days to Estimate	Feature Configuration	Measuring Component Dates	Measurement Data	Start of Estimation Horizon
Not Configured	Not Configured	Not Set	None	<p>Horizon will begin based on the installation date/time:</p> <ul style="list-style-type: none"> Interval uses the installation date/time Scalar uses the On event
Not Configured	Not Configured	Not Set	Yes, with some gaps	<p>Horizon will begin based on the installation date/time:</p> <ul style="list-style-type: none"> Interval uses the installation date/time Scalar uses the On event
Configured	Any	Not Set	Any	Horizon will begin based on the process date/time less the Maximum Days to Estimate
Configured	Any	Set	Yes - prior to Maximum Days to Estimate	Horizon will begin based on the process date/time less the Maximum Days to Estimate
Configured	Any	Set	Yes - after Maximum Days to Estimate	Horizon will begin based on the Latest Contiguous Measurement Date/Time
Not Configured	Configured	Not Set	None	<p>Horizon will begin based on the process date/time less the hours configured on the feature configuration.</p> <p>If it is not yet time to estimate based on the calculated start of the estimation horizon, then:</p> <ul style="list-style-type: none"> Interval: Last Contiguous Measurement Date/Time is initialized to the calculated horizon start Scalar: Last Contiguous Measurement Date/Time is initialized to the calculated horizon start and Adjusted Last Contiguous Measurement Date/Time is set to the appropriate value based on the periodic estimation configuration. <p>Note: this would happen when the Hours Before Estimation (for example 72) is a larger number of hours than the No of Hours in the Past to</p>

Measuring Component Type Maximum Days to Estimate	Feature Configuration	Measuring Component Dates	Measurement Data	Start of Estimation Horizon
				Retrieve Last Usable Measurement (for example 24)
Not Configured	Configured	Not Set	Yes - outside feature configuration window	<p>Horizon will begin based on the process date/ time less the hours configured on the feature configuration.</p> <p>If it is not yet time to estimate based on the calculated start of the estimation horizon, then:</p> <ul style="list-style-type: none"> Interval: Last Contiguous Measurement Date/ Time is initialized to the calculated horizon start Scalar: Last Contiguous Measurement Date/ Time is initialized to the calculated horizon start and Adjusted Last Contiguous Measurement Date/Time is set to the appropriate value based on the periodic estimation configuration. <p>Note: this would happen when the Hours Before Estimation (for example 72) is a larger number of hours than the No of Hours in the Past to Retrieve Last Usable Measurement (for example 24)</p>
Not Configured	Configured	Not Set	Yes - inside feature configuration window	Horizon will begin as of the most recent measurement date/time that was found for the measuring component.
Not Configured	Configured	Set	Any	<p>Horizon will begin based on the most recent of the following:</p> <ul style="list-style-type: none"> Process date/time less the hours configured on the feature configuration Last Contiguous Measurement Date/ Time

Testing Periodic Estimation on Small Data Sets

This topic provides guidelines for testing periodic estimation on small data sets.

How to Override the system Date

The system or process date is a key driver in the periodic estimation process. It will determine the end date/time of the estimation horizon (along with the periodic estimation configuration). When testing a single device this override can ensure that estimations never go further in time than you would like if you are working with an older set of test data.

There are two methods to override the system date (both use the format YYYY-MM-DD) that will work for the methods being described in this section.

- The **System Override Date** option on the **General System Configuration** feature configuration: this impacts all users and batches
- The **System Override Date** characteristic for a specific user: this impacts only processes executed by a particular user

Testing a Single Device

To test a single device you can emulate the D1-SMMTR batch by using the F1-AutoTransitionBO business service. This service executes the monitor algorithms on the current state of a business object much in the same way as the D1-SMMTR batch control. This business service can be called in one of two ways:

1. Create a BPA script to call the business service for a particular device ID (see sample below).
2. Create an Inbound Web Service and use SoapUI or an analogous product to call that Inbound Web Service (see sample below).
3. Be sure that the credentials used for the Inbound Web Service submission are the ones for which the date was overridden (if you are overriding the system date for a single user).

Sample BPA edit step:

```
move '724182144552' to "F1-AutoTransitionBO/primeKeyValues/pkValue1";
move 'D1-DEVICE' to "F1-AutoTransitionBO/mo";
move 'D1-SMMTR' to "F1-AutoTransitionBO/batchControl";
invokeBS 'F1-AutoTransitionBO' using "F1-AutoTransitionBO";
```

Sample SOAP Inbound Web Service Payload:

```
<soapenv:Envelope
xmlns:soapenv="http://schemas.xmlsoap.org/soap/envelope/"
xmlns:zz="http://ouaf.oracle.com/webservices/d1/ZZ-AutoTransitionBO">
  <soapenv:Header/>
  <<soapenv:Body>
    <zz:autoTran>
      <zz:mo>D1-DEVICE</zz:mo>
      <zz:primeKeyValues>
        <zz:pkValue1>344235660160</zz:pkValue1>
      </zz:primeKeyValues>
      <zz:batchControl>D1-SMMTR</zz:batchControl>
    </zz:autoTran>
  </soapenv:Body>
</soapenv:Envelope>
```

Testing a Subset of Devices

To test a subset of devices you can create a plug-in driven batch:

- Select algorithm: write the select statement that gathers the device IDs that you wish to test, this can be a hard coded list if need be (just select them from dual).
- Process Records algorithm: Use the F1-AutoTransitionBO business service, but call it for the device in the current work unit (this is essentially what D1-SMMTR does)

Testing Periodic Estimation on Large Data Sets

This topic provides guidelines for testing periodic estimation on large data sets.

Before running periodic estimation on a large data set it is important to have an idea of roughly how many devices and for how long you expect to estimate. This can be gauged fairly quickly by looking at the **Latest Measurement Date/Time** on the measuring component. Here is a sample query that will provide a count of measuring components by the number of months from a supplied process date the last contiguous measurement date/time is:

```
select count(*)
, round((to_date(:processDateTime, 'YYYY-MM-DD-HH24.MI.SS') - latest_msrmt_dttm)/31,0) MONTHS
from dl_measr_comp mc
group by round((to_date(:processDateTime, 'YYYY-MM-DD-HH24.MI.SS') - latest_msrmt_dttm)/31,0)
order by 2
;
```

Below is a more complex query that will show you by thread how many measuring components for a given **Latest Measurement Date/Time** you will process, it does a bit more work to look at only installed devices and measuring components that are configured for periodic estimation and the measuring component is actually ready to estimate based on that configuration.

The parameters for this are:

- threads: enter 1 to avoid splitting the results into threads
- processDateTime: leave blank to use the system date, otherwise provide a date/time in the format: YYYY-MM-DD-HH24.MI.SS

```
with threads as (
select rownum thread_nbr
, lpad(round((rownum - 1) * (rpad('9',12,'9')+1)/:threads,0),12,'0') low_id
, lpad(round(rownum * ((rpad('9',12,'9')+1)/:threads),0)-1,12,'0') high_id
from dual
connect by rownum <= :threads
)
select /*+ parallel */ threads.thread_nbr
, threads.low_id
, threads.high_id
, nvl(mc.adj_latest_msrmt_dttm,mc.latest_msrmt_dttm) LATEST_MSRMT_DTTM
, count(*) MC_COUNT
from threads
inner join dl_dvc dvc
on dvc.dl_device_id between threads.low_id and threads.high_id
inner join dl_dvc_cfg dc
on dc.dl_device_id = dvc.dl_device_id
inner join dl_install_evt ie
on ie.device_config_id = dc.device_config_id
and ie.dl_install_dttm < sysdate
and (ie.dl_removal_dttm is null or ie.dl_removal_dttm >= sysdate)
inner join dl_measr_comp mc
on mc.device_config_id = dc.device_config_id
inner join dl_measr_comp_type mct
on mct.measr_comp_type_cd = mc.measr_comp_type_cd
and hrs_wait_before_est > 0
where (to_date(nvl(:processDateTime,sysdate), 'YYYY-MM-DD-
HH24.MI.SS') - latest_msrmt_dttm) * 24 > mct.hrs_wait_before_est
group by threads.thread_nbr
, threads.low_id
, threads.high_id
, nvl(mc.adj_latest_msrmt_dttm,mc.latest_msrmt_dttm)
order by 1, 4
;
```

Defining Oracle Utilities Rate Cloud Service Options

Oracle Utilities Rate Cloud Service Admin Data

Oracle Utilities Rate Cloud Service includes access to pages, portals, and zones used to create and maintain various types of administrative configuration data, including:

- Characteristic Types
- Currencies
- Distribution Codes
- Revenue Classes
- Item Device Types
- Frequencies
- Service Types
- Service Quantity Identifiers
- Time of Use codes
- Units of Measure

Refer to the [Defining General Options](#) chapter in the *Administrative User Guide* for detailed information about setting up currencies and characteristic types.

Refer to the [Defining Financial Transaction Options](#) chapter in the *Administrative User Guide* for detailed information about setting up distribution codes and revenue classes.

Refer to the [Defining Device Options](#) chapter in the *Administrative User Guide* for detailed information about setting up device types.

Refer to the [Rates](#) chapter of the *Business User Guide* for detailed information about setting up frequency codes.

Refer to the [Defining Device Measurement Options](#) chapter in the *Administrative User Guide* for detailed information about setting up service types, units of measure, service quantity identifiers, and time of use codes.

Note: Some fields and options used by these types of configuration data are not applicable when using Oracle Utilities Rate Cloud Service when compared to using Oracle Utilities Customer Cloud Service.

Creating Oracle Utilities Rate Cloud Service Users

Oracle Utilities Rate Cloud Service includes a “Rating Services” user group that provides access to the specific pages, portals, and features included with the cloud service.

The “Rating Services” user group should be used as the basis for all new Oracle Utilities Rate Cloud Service users.

Refer to the [Defining Security and User Options](#) chapter in the *Administrative User Guide* for more information about creating new users.

Initiating Calculations from an External System

Oracle Utilities Rate Cloud Service includes an inbound web service that allows rate calculation to be initiated from an external system.

The `clrateCalculation` inbound web service is an inbound REST web service that can be used to request a rate calculation. Some specifics regarding this web service include:

- Master data (such as person, account, service agreement, service point, device, or usage) is not required.

- Service quantities and characteristic types/values must be included with the web service request.
- Calculation results are consistent with online rate calculation using the Rate Check feature.
- Calculation results are returned to the external system that submitted the request.
- Calculation results are not stored in Oracle Utilities Rate Cloud Service.

Refer to the [External Messages](#) chapter in the *Administrative User Guide* for more information about inbound web services. Use the **Inbound Web Service** portal to view details regarding the `clrateCalculation` inbound web service.

Defining Oracle Utilities Billing Cloud Service Options

Oracle Utilities Billing Cloud Service Admin Data

Oracle Utilities Billing Cloud Service includes access to pages, portals, and zones used to create and maintain various types of administrative configuration data. The menus provided with Oracle Utilities Billing Cloud Service display only those menu items that correspond to capabilities that are available with the cloud service.

NOTE: Not all fields and field values available in Oracle Utilities Customer to Meter associated with these menu items are used with Oracle Utilities Billing Cloud Service.

This page outlines the administrative areas available with Oracle Utilities Billing Cloud Service based on the **Admin** menu, including:

- Aggregation
- Billing
- Communication (Activity Type only)
- Conversion
- Customer
- Database
- Device
- Device Installation
- Financial
- General
- Geographic
- Implementation Tools
- Integration
- Market Transaction Management
- Open Market
- Rates
- Reporting
- Sales & Marketing (Terms and Conditions only)
- Security
- System
- Umbrella Agreement

- Usage
- VEE
- Batch Operations
- Conversion Support

Refer to specific chapter and sections in the *Administrative User Guide* for more information about working with these above listed functional areas.

Creating Oracle Utilities Billing Cloud Service Users

Oracle Utilities Billing Cloud Service includes the following user groups:

- **Billing Cloud Services:** A user group that provides access to the specific pages, portals, and features included with the cloud service
- **Billing Cloud Service Batch Services:** A user group that enables users to execute batch processes used by the cloud service

The “Billing Cloud Services” user group should be used as the basis for all new Oracle Utilities Billing Cloud Service users.

Users who will be responsible for running batch processing should be part of the “Billing Cloud Service Batch Services” user group.

Refer to the [Defining Security and User Options](#) chapter in the *Administrative User Guide* for more information about creating new users.

Smart Grid Gateway Adapters

Oracle Utilities Smart Grid Gateway (SGG) Adapters support communication with various third-party head end systems to provide the following functionality:

- **Payload Processing:** Receiving usage and device event payloads from the head end system (also referred to as Measurement Data and Device Event Loading and Processing)
- **Smart Meter Command Processing:** Sending/receiving messages to/from third-party applications to initiate smart meter commands from Smart Grid Gateway

Smart Grid Gateway Implementations

Oracle Utilities Smart Grid Gateway Adapters can be implemented in one of two manners:

- **Middleware Implementations** use Oracle Service Bus (OSB) for payload processing and Oracle Business Process Execution Language (BPEL) to communicate with head end systems when initiating smart meter commands. Middleware implementations can be used **only** with on-premises implementations of Oracle Utilities Smart Grid Gateway.
- **Native Implementations** use batch processing for payload processing, and specific communication business objects to communicate with head end systems when initiating smart meter commands. Native implementations can be used with **either** on-premises implementations of Oracle Utilities Smart Grid Gateway, or with Oracle Utilities cloud services such as Oracle Utilities Meter Solution Cloud Service or Oracle Utilities Customer Cloud Service.

The following sections provide details about each type of implementation.

Smart Grid Gateway Adapter Middleware Implementations

NOTE: Unless otherwise noted, the contents of this section apply to middleware (on-premises) implementations of Oracle Utilities Smart Grid Gateway only, and do NOT apply to native implementations or Oracle Utilities cloud services. See [Smart Grid Gateway Adapter Native Implementations](#) for more information about Smart Grid Gateway Adapter native implementations and implementing Smart Grid Gateway adapters with Oracle Utilities cloud services.

Oracle Utilities Smart Grid Gateway (SGG) Adapters support communication with various third-party head-end systems. Smart Grid Gateway uses Oracle Service Bus (OSB) and Oracle Business Process Execution Language (BPEL) to facilitate communication with the head-end systems. Most if not all of the functionality shown below is available in each SGG Adapter.

Measurement Data and Device Event Loading: Data parsing and transformation via Oracle Service Bus from head-end system format into the Oracle Utilities Service and Measurement Data Foundation unified format for measurement data and device events.

Measurement Data and Device Event Processing: Configurable mapping for head-end system status codes and device event names to Oracle Utilities Service and Measurement Data Foundation standard values.

Smart Meter Command Processing: Sending/receiving messages to/from third-party applications to initiate smart meter commands from SGG. Most head-end systems support the following types of commands and communications:

- **Device Status Check:** Business objects and BPEL processes to support issuing device status check commands.
- **Meter Commissioning:** Business objects and BPEL processes to support issuing meter commissioning commands (including registration and installation commands).
- **Meter Decommissioning:** Business objects and BPEL processes to support issuing meter decommissioning commands.
- **Meter Retirement:** Business objects and BPEL processes to support issuing meter retire (deregistration) commands.
- **On-Demand Read:** Business objects and BPEL processes to support issuing on-demand read commands.
- **Remote Connect:** Business objects and BPEL processes to support issuing remote connect commands.
- **Remote Disconnect:** Business objects and BPEL processes to support issuing remote disconnect commands.

This information in this guide describes how to configure, extend, and test the Smart Grid Gateway Adapters for individual head-end systems. The following head-end systems each have a specific SGG Adapter that can be configured: Itron OpenWay, Landis+Gyr, Networked Energy Services, MV90 for Itron, Sensus RNI, and Silver Spring Networks. Customers also can create their own customized adapter for using Smart Grid Gateway with a specific head-end system. See [Creating a Custom Adapter for Smart Grid Gateway](#) for more information.

Configuring Smart Grid Gateway Adapters

This section describes how to configure Oracle Utilities Smart Grid Gateway Adapters for each supported head-end system. Use the cross-references below to go to the adapter of interest.

[Itron OpenWay](#)

[Landis+Gyr](#)

[Networked Energy Services](#)

[MV90 for Itron](#)

[Sensus RNI](#)

[Silver Spring Networks](#)

NOTE: This section applies to middleware (on-premises) implementations of Oracle Utilities Smart Grid Gateway only. This section does NOT apply to native implementations or Oracle Utilities cloud services. See [Smart Grid Gateway Adapter Native Implementations](#) for more information about Smart Grid Gateway Adapter native implementations and implementing Smart Grid Gateway adapters with Oracle Utilities cloud services.

Itron OpenWay

The Oracle Utilities Smart Grid Gateway Adapter for Itron OpenWay supports communication with the Itron OpenWay application, including measurement data and device event loading, and command messaging in support of commissioning, connect, disconnect, decommissioning, status check, and on-demand read commands. The following table describes the attributes of the adapter:

Attribute	Details
Currently Supported Versions	7.0 Itron OpenWay Operations Center SR 5.3, 5.4
Protocol	Proprietary
Market(s)	Worldwide
Architecture	RF Mesh

Itron OpenWay Adapter Processing

This section provides details concerning the OSB processing, BPEL Processes, and Oracle Utilities Application Framework (OUAF) objects that are supplied as part of the base package. This information illustrates how the base package objects were designed, and can serve as the basis for any customizations you create as part of your implementation.

Initial Measurement Data and Device Event Loading

The initial measurement data load and device event processing use OSB to poll for, parse, and transform the head-payloads into the Oracle Utilities Smart Grid Gateway (SGG) service format. Payloads contain measurements and meter events in some head-end specific format. OSB then places each service call into a Java Message Service (JMS) queue within the Oracle Utilities applications. The JMS client consumes the entries and invokes the respective services in parallel. A service then creates initial measurements with data in a common format with head-end-specific processing as needed. A second service creates device events with data in a common format.

Measurement and device event data must be requested from the Itron OpenWay head-end system via Scheduled Read commands. See [Scheduled Read Commands](#) for more information.

Scheduled Read Commands

NOTE: This section applies to **both** middleware and native implementations of the Smart Grid Gateway Adapter for Itron OpenWay.

Measurement and device event data must be requested from the Itron OpenWay head-end system via Scheduled Read commands. Schedule read commands are used to request meter reads and/or device events for a group of devices for a specified date and time. Scheduled read commands can be created such that recurring requests based on the same command parameters are sent to the head-end system at regular intervals. For example, a command could be configured to request daily (24 hour) scalar meter readings once per day for a specified group of devices. Another command could be configured to request weekly (168 hours) device events once per week for a group of devices.

Scheduled read commands should be created for all devices from which meter readings and/or device events are to be uploaded via Oracle Utilities Smart Grid Gateway. Separate scheduled read commands can be created for specific groups and for specific types of data. For example, for a given group of scalar devices, you might create separate commands to request scalar usage data and to request device events from the same group (both of which can be based on different

recurrence patterns). The specifics concerning request specifics and recurrence patterns should be based on the requirements of the implementation.

Attributes used to define a schedule read command include the following:

- **Status:** the status of the activity
- **Schedule Read Type:** the type of scheduled read
- **Schedule Information:** information about the schedule for the read, including:
 - **One Time Read:** indicates if the request is a one-time request. One-time requests have a defined date/time range during which request and recurrences can take place.
 - **One Time Start Date Time:** specifies the start time for one-time requests (applicable only if **One Time Read** is set to “Yes”)
 - **One Time End Date Time:** specifies the end time for one-time requests (applicable only if **One Time Read** is set to “Yes”)
 - **First Daily Measurement Time:** Indicates starting time for measurements for each day. This field, along with the value from **IMD Length**, will be used to determine when interrogation requests should be made. For example, if the **First Daily Measurement Time** is set to 08:00AM and **IMD Length** is set to 12 hours (12:00:00) then there would be two requests made per day:
 - 8:00AM - 8:00PM
 - 8:00PM - 8:00AM
 - **Interrogation Buffer:** This parameter impacts when interrogation requests are sent. It is entered in the format of hours:minutes:seconds. For example, if set to 1 hour (01:00:00) for our above example, the first request of the day for 8:00AM - 8:00PM would be sent to Itron OpenWay at 7:00PM. The buffer time will decrease if the activity is monitored after 7:00PM, so if the monitor process is executed at 7:30PM the buffer time would only be 30 minutes and if the monitor process were not executed until after 8:00PM there would be no buffer time at all.
 - **IMD Length:** Defines the number of hours, minutes and seconds of data that should be retrieved for each request. It is entered in the format of hours:minutes:seconds. This number must be divisible into 24 since it will determine how many requests will be made per day (i.e. if set to 8 hours (08:00:00) there will be 3 requests per day).
 - **Disable Extended IMD Length Recovery:** By default the schedule read activity will attempt to "catch-up" when interrogation requests have been missed by requesting the entire period from the last interrogation request made. Setting this parameter to "Yes" will turn off this functionality and interrogation requests will only be made in for the exact amount of time defined in the **IMD Length**
 - **Range of Recurrence:** indicates how to define request recurrences. Valid values include “Maximum Recurrence”, “No End Date”, and “Recurrence End Date”
 - **Maximum Recurrence:** The activity will make a set number of requests, once the set number has been reached the activity will expire. When selected, **Maximum Recurrences** must also be provided.
 - **No End Date:** The activity will never expire and will continue to make requests until it is manually transitioned to inactive.
 - **Recurrence End Date:** The activity will continue to make requests until a specified date. When selected, **Recurrence End Date Time** must also be provided.

NOTE: When “No End Data” is selected, the recurrences of the request continue until a user manually changes the status of the command.

- **Maximum Recurrence:** defines the maximum number of recurrences before the command’s status is changed to “Inactive”.
- **Recurrence End Date Time:** The date after which no more recurrences are attempted. After this date and time, the command’s status is changed to “Inactive”.

- **Group:** the group of devices used by requests for the command
- **Group Type:** indicates the type of device group to use for the command. Valid options include Application Group or Configuration Group.
- **Application Group/Configuration Group Name:** defines the specific group (based on the group type).

NOTE: Groups referenced by Scheduled Read commands and the devices that belong to each are defined in Itron OpenWay head-end system. Each group to be used with these commands must also be defined in either the “Itron — Application Group Lookup” or “Asset Specification” extendable lookup. See the Oracle Utilities Smart Grid Gateway Adapter for Itron OpenWay Configuration Guide for more information about these extendable lookups.

- **Default Read Parameters:** specifies details concerning the data to be requested. The read parameters define the exact data that will be requested from the meters. Please consult the Itron OpenWay documentation for the specifics of each parameter.
- **Interrogation Window Hours:** the number of hours used to calculate when to submit requests. For example, to submit requests once per day, this should be set to 24. To submit requests once per week (7 days), this should be set to 168. The current date time (or the Latest Request End Date Time) plus this equals interrogation window end date time.
- **Override Read Parameters:** an alternative set of parameters that can be defined. To leverage this group each parameter must be provided, no parameter is allowed to be left blank. This set of parameters will be used when the request end time is equal to the **First Daily Measurement Time**. For example, a schedule read with a **First Daily Measurement Time** of 12:00AM and an **IMD Length** 12 hours (12:00:00) would make the following requests each day:
 - 12:00AM - 12:00PM
 - 12:00PM - 12:00AM

The **Override Read Parameters** would be used for the 2nd request where the request end time of 12:00AM matches the **First Daily Measurement Time** of 12:00AM. If an extended request is made to "catch up" (i.e. it makes a request that is larger in duration than the configured **IMD Length**), and the request start and request end date time includes the **First Daily Measurement Time** then the **Override Read Parameters** will be used.

- **Outbound Communication Exception Handling Overrides:** parameters used to control retry attempts and expiration for the outbound communication. These parameters take precedence over their outbound communication counterparts
- **Last Read Details:** details concerning the most recent read request sent for the command. This information is used to calculate the time for the next request (based on the **Interrogation Window Hours** parameter).
 - **Latest Request Start Date Time:** the start date and time of the last request
 - **Latest Request End Date Time:** the end date and time of the last request
 - **Recurrence Count:** the number of recurrences of the last request

About Ad Hoc Requests

While scheduled read commands are typically configured to create recurring requests for meter reads and device events, users can also submit ad hoc requests for a specific date and time range based on the parameters of a currently active scheduled read command. This is useful if meter read data or device events are needed before the next request for a command would be submitted based on the command’s recurrence settings.

Ad hoc requests are created as separate one-time request commands, with a start and end time based on parameters supplied by the user when initiating the ad hoc request. The group and read parameters for ad hoc requests are the same as those for the command used to send the ad hoc request.

Error Handling

If errors occur when processing scheduled read commands, errors are logged as follows:

- If there is a single error it will create a single log entry
- If there is more than one error, the log entry will perform a count of devices and create a single error message stating the number of devices that were in error.

Initial Measurements

The usage data received from the AMI head-end system as a file in Itron OpenWay XML format is loaded into Oracle Utilities as initial measurement data. The following OSB projects, delivered in the base product, help manage the usage processing:

1. **SGG-D8-ITRONXML-BASE** contains components responsible for “actual” processing of incoming data. It should not be modified during configuration. This project can be upgraded without affecting the customization and environment settings added to SGG-D8-ITRONXML-CM.
2. **SGG-D8-ITRONXML-CM** allows for customization and simplifies future upgrades.

The runtime configuration settings for the SGG-D8-ITRONXML-CM project are stored in the xquery file EnvironmentSettings.xq. You can use this file to adjust initial measurement data processing. For example, if you want to load raw data you would specify “true” for the content of the populateRawIMD element.

The following table describes the elements included in the EnvironmentSettings.xq file:

Element	Description	Valid Values
populateRaw	Determines if the initial measurement data is populated as raw data.	true false
callPreProcessing	Determines if the preprocessing proxy service is called.	true false
callPostProcessing	Determines if the postprocessing proxy service is called.	true false
destinationRootElementInterval	Holds the name of inbound web service for the interval IMD seeder.	
destinationRootElementScalar	Holds the name of inbound web service for the scalar IMD seeder. In most cases it is the same as destinationRootElementInterval.	
destinationRootElementEvent	Holds the name of inbound web service for the device event seeder.	
publishServices/service	Specifies the name of the business service within the OSB project used to publish data for external systems (such as Oracle DataRaker).	
filterEvents	Determines if events should be filtered.	true false
filterUsage	Determines if usage should be filtered.	true false
filterRegisterSource	Determines if source register data should be filtered.	true false

Publishing Initial Measurement Data

The SGG adapter can be configured to publish initial measurement data for use in Oracle DataRaker or other external systems. This functionality is supported through a combination of OSB components and BPEL composites.

Enabling Initial Measurement Data Publishing

Publishing data is enabled by referencing a publisher business service in the publishServices/service element in the EnvironmentSettings.xq file as follows:

```
<publishServices>
  <service>[publisherBusinessService]</service>
</publishServices>
```

The following components provided with the SGG-D8-ITRONXML-CM OSB project are used in publishing measurement data to Oracle DataRaker:

- The **DataRakerBusinessService** business service is used to send data to a pre-configured JMS queue (defined as an Endpoint URI), from which the data will be published. This is the business service that should be specified in the EnvironmentSettings.xq file.
- The **DataRakerServiceAccount** service account is used to define and maintain the user name and password needed to access the JMS queue defined in the **DataRakerBusinessService** business service.

Configuring Initial Measurement Publishing Output

The SGGDRIntegration BPEL composite handles publishing the data to Oracle DataRaker or other systems. Initial measurement data is published in the “native” initial measurement data format (the format of the initial measurement seeder business object). This format includes normalized unit of measure and condition codes. See the *Oracle Utilities Smart Grid Gateway Adapter Development Kit Administrative User Guide* for more details about this format.

NOTE: Initial measurement data published through this feature is published prior to validation, estimation, and editing (VEE) processing. In addition, filtering *cannot* be applied to data published through this feature.

The following parameters can be used to configure details of how the data is provided to Oracle DataRaker, including the directory where files are posted for Oracle DataRaker to consume, number of records per file, polling frequency, etc. These parameters are defined during installation. See the *Oracle Utilities Smart Grid Gateway Installation Guide* for more details about defining values for these parameters.

Parameter	Description	Default Value
SGG_DR_INT_QUEUE	JNDI name of queue to publish SGG payloads. This is the JMS queue defined in the DataRakerBusinessService business service. This should NOT be changed.	DataRakerQueue
SOA_DR_PUBLISH_SIZE	The number of records (SGG payloads) to accumulate in a published file.	100
SOA_DR_FILE_SIZE	The maximum file size for the accumulated (SGG payloads) file in kilobytes.	524288
SOA_DR_ELAPSED_TIME	The period of time in second which, when exceeded, causes a new outgoing file to be created.	600
SOA_DR_POLLING_FREQ	The polling frequency in seconds of the staging directory for new files.	60
SOA_DR_STAGING_DIR	Mount point/directory for the staging directory for accumulated SGG payload files. This is used internally and should NOT be changed.	/spl/sploutput/staging
SOA_DR_INTEGRATION_DIR	Mount point/directory from which Oracle DataRaker will consume the converted XML files.	/spl/sploutput/int

Filtering Initial Measurement Data

The SGG adapter can be configured to filter initial measurement data passed into SGG and the Oracle Utilities Meter Data Management application. Filtering data is enabled by setting the <filterUsage> element in the EnvironmentSettings.xq file to “true” as follows:

```
<filterUsage>true</filterUsage>
```

When filtering is enabled, only measurements whose <externalUOM> matches one of the values defined in the **Itron - UOM Code to Standard UOM Mapping** extendable lookup (D8-HeadendUOMLookup) are passed into the system for processing.

Processing Large Input Files

In some environments, the OSB project may begin processing a large input file before it has been completely copied to the input directory. To prevent this, configure the MinimumAge property in the “InboundProxyService” proxy service for the project. The MinimumAge property specifies the minimum age of files to be retrieved, based on the last modified time stamp. This enables large files to be completely copied to the input directory before they are retrieved for processing.

Prioritized Initial Measurement Processing

The SGG adapter prioritizes processing of initial measurements created from smart meter commands and/or completion events by setting the Execution Method flag in these types of initial measurements to “Real Time” (D1RT). In addition, initial measurements received with the Execution Method flag set to “Real Time” will be processed in real time rather than via batch processing. See **Initial Measurement Data Prioritization** in the *Oracle Utilities Meter Data Management / Smart Grid Gateway Business User Guide* for more information.

Device Events

Itron OpenWay can send real-time events such as meter outage alarms to Oracle Utilities Smart Grid Gateway. These events are referred to as exceptions in the Itron architecture, and are sent to the BPEL ExceptionSubscriberService service by Itron OpenWay without requiring an explicit request from Oracle Utilities Smart Grid Gateway. Exceptions are loaded as device events data and provided to the edge applications.

The required functionality is delivered in the base product as two OSB projects:

1. **SGG-D8-EXCEPTION-BASE** contains components responsible for “actual” processing of incoming data. It should not be modified during configuration. This project can be upgraded without affecting the customization and environment settings added to the SGG-D8-EXCEPTION-CM project.
2. **SGG-D8-EXCEPTION-CM** allows the customization and simplifies the future upgrades.

The following table describes the elements included in the EnvironmentSettings.xq file:

Element	Description	Valid Values
populateRaw	Determines if the device event data is populated as raw data.	true false
callPreProcessing	Determines if the preprocessing proxy service is called.	true false
callPostProcessing	Determines if the postprocessing proxy service is called.	true false
destinationRootElement	Holds the name of inbound web service for the device event seeder.	
publishServices/service	Specifies the name of the business service within the OSB project used to publish data for external systems (such as Oracle DataRaker).	
filterEvents	Determines if events should be filtered.	true false

Publishing Events

The Itron OpenWay adapter can be configured to publish device events for use in Oracle DataRaker or other external systems. This functionality is supported through a combination of OSB components and BPEL composites.

Enabling Device Event Publishing

Publishing data is enabled by referencing a publisher business service in the `publishServices/service` element in the `EnvironmentSettings.xq` file as follows:

```
<publishServices>
  <service>[publisherBusinessService]</service>
</publishServices>
```

The following components provided with the SGG-D8-EXCEPTION-CM OSB project are used in publishing device events data to Oracle DataRaker:

- The **DataRakerBusinessService** business service is used to send data to a pre-configured JMS queue (defined as an Endpoint URI), from which the data will be published. This is the business service that should be specified in the `EnvironmentSettings.xq` file.
- The **DataRakerServiceAccount** service account is used to define and maintain the user name and password needed to access the JMS queue defined in the **DataRakerBusinessService** business service.

Configuring Device Event Publishing Output

The SGGDRIntegration BPEL composite handles publishing the data to Oracle DataRaker or other systems. Device event data is published in the “native” device event data format (the format of the device event seeder business object). This format includes normalized device event codes. See the *Oracle Utilities Smart Grid Gateway Adapter Development Kit Administrative User Guide* for more details about this format.

NOTE: In addition, filtering can NOT be applied to device events published via this feature.

The following parameters can be used to configure details of how the data is provided to Oracle DataRaker, including the directory where files are posted for Oracle DataRaker to consume, number of records per file, polling frequency, etc. These parameters are defined during installation. See the *Oracle Utilities Smart Grid Gateway Installation Guide* for more details about defining values for these parameters.

Parameter	Description	Default Value
SGG_DR_INT_QUEUE	JNDI name of queue to publish SGG payloads. This is the JMS queue defined in the DataRakerBusinessService business service. This should NOT be changed.	DataRakerQueue
SOA_DR_PUBLISH_SIZE	The number of records (SGG payloads) to accumulate in a published file.	100
SOA_DR_FILE_SIZE	The maximum file size for the accumulated (SGG payloads) file in kilobytes.	524288
SOA_DR_ELAPSED_TIME	The period of time in second which, when exceeded, causes a new outgoing file to be created.	600
SOA_DR_POLLING_FREQ	The polling frequency in seconds of the staging directory for new files.	60
SOA_DR_STAGING_DIR	Mount point/directory for the staging directory for accumulated SGG payload files.	/spl/sploutput/staging

Parameter	Description	Default Value
	This is used internally and should NOT be changed.	
SOA_DR_INTEGRATION_DIR	Mount point/directory from which Oracle DataRaker will consume the converted XML files.	/spl/sploutput/int

Filtering Events

The SGG adapter can be configured to filter initial measurement data passed into SGG and the Oracle Utilities Meter Data Management application. Filtering data is enabled by setting the <filterUsage> element in the EnvironmentSettings.xq file to “true” as follows:

```
<filterEvents>true</filterEvents>
```

When filtering is enabled, only device events whose <externalEventName> matches one of the values defined in the **Itron - Device Event Mapping** extendable lookup (D8-DeviceEventMappingLookup) are passed into the system for processing.

Prioritized Device Event Processing

The SGG adapter prioritizes processing of device events created from smart meter commands and/or completion events by setting the Execution Method flag in these types of device events to “Real Time” (DIRT). In addition, device events received with the Execution Method flag set to “Real Time” will be processed in real time rather than via batch processing. See **Device Event Prioritization** in the *Oracle Utilities Meter Data Management / Smart Grid Gateway Business User Guide* for more information.

Configuring Payload Processing Notifications

By default, Payload Statistics, Payload Error Notification, and Payload Summary notification activities are sent to the Notification Queue within Oracle Service Bus. Smart Grid Gateway adapters can be configured to restrict sending these activities by defining optional JCA transport dynamic properties in the appropriate OSB project. The following optional JCA transport dynamic properties can be used to control if these notification activities are sent:

- **SGG_SEND_STATISTICS**: Controls sending Payload Statistic activities (true: send, false: do not send)
- **SGG_SEND_ERROR**: Controls sending Payload Error Notification activities (true: send, false: do not send)
- **SGG_SEND_SUMMARY**: Controls sending Payload Summary activities (true: send, false: do not send)

When these properties are set to false, the corresponding payload notification will not be sent to the JMS Queue. Note these properties are not populated by default, and default to true if omitted.

To create these properties:

1. Navigate to the SGG-D8-EXCEPTION-CM project in the Oracle Service Bus Console.
2. Expand the **Proxy Services** folder.
3. Select the **InboundProxyService** proxy service (not the Pipeline or WSDL).
4. Click **Create** to create a new session.
5. Select **Transport Details**.
6. Click the plus sign in the **Dyanmic EndPoint Properties** section. An empty row will appear.
7. Enter the property you wish to define in the **Property** column.
8. Enter "false" in the **value** column.
9. Repeat steps 6-8 for each property you wish to define.
10. Click **Activate** to save and activate your changes.

NOTE: These properties are only used if the SGG_EXT_ID_PATTERN is not present or the regular expression captures nothing. The SGG_EXT_ID_PATTERN will override these properties when the regular expression captures group data.

Base Package Business Objects

The Itron OpenWay adapter base package includes the following initial measurement and device event business objects:

Business Object Name	Description
D8-InterrogateByGroup	Itron - Interrogate By Group Performs a Schedule Read for a group of devices (either Application or Configuration) in the Itron OpenWay API.
D8-InterrogateByGroupResult	Itron - Interrogate by Group Result This BO is the inbound asynchronous response to an Interrogate By Group (Schedule Read) outbound communication.
D8-InitialLoadIMDInterval	Itron - Initial Load IMD - Interval Used when loading Itron OpenWay interval measurements into the system for the first time.
D8-InitialLoadIMDScalar	Itron - Initial Load IMD - Scalar Used when loading Itron OpenWay scalar measurements into the system for the first time.
D8-ScheduleRead	Itron - Schedule Read Requests IMD and Event data from the Itron OpenWay Network. This data will later be returned and placed in files to be uploaded.

Device Communication

The basic communication for all business processing is essentially the same. A communication request is sent from the Oracle Utilities application to the head-end system. This request would be for a connect/disconnect, commission/decommission, measurement data, an on-demand read, or another type of request that the head-end system supports. The designated BPEL process transforms the request from Oracle Utilities format to MultiSpeak format and invokes the related web service from the head-end system. The head-end system then returns a reply, and the BPEL process transforms the reply message back to the appropriate format so that Oracle Utilities can receive the response.

Communication Flows

The table below lists the communications created for each Itron OpenWay command:

Command	Outbound Communication	Inbound Communication	Completion Event
Remote Connect	Itron - Reconnect Meter	Itron - Reconnect Meter Result	Connect Device Completion Event
Remote Disconnect	Itron - Disconnect Meter	Itron - Disconnect Meter Result	Disconnect Device Completion Event
Device Commissioning	Itron - Add Meter Definition		Device Commissioning Completion Event
Device Decommissioning	Itron - Deregister Meter		Device Decommissioning Completion Event
On-Demand Read (Scalar)	Itron - Contingency Read (Scalar)	Itron - Contingency Read Result (Scalar)	Create IMD Completion Event
On-Demand Read (Interval)	Itron - Contingency Read (Interval)	Itron - Contingency Read Result (Interval)	Create IMD Completion Event
Scheduled Read (Scalar)	Itron - Interrogate by Group (Scalar)	Itron - Interrogate by Group Result (Scalar)	Create IMD Completion Event
Scheduled Read (Interval)	Itron - Interrogate by Group (Interval)	Itron - Interrogate by Group Result (Interval)	Create IMD Completion Event

Command	Outbound Communication	Inbound Communication	Completion Event
Device Status Check	Itron - Ping by Endpoints (Status Check)	Itron - Get Ping by Endpoints Result	

Device Communication Base Package Business Objects

The Itron OpenWay Adapter base package includes the following communication business objects:

Business Object Name	Description
D8-AddMeterDefinitions	Itron - Add Meter Definition (Commission)
D8-DeregisterMeter	Itron - Deregister Meter (Decommission)
D8-DetectLoadSideVoltageByMtr	Itron - Detect Load Side Voltage
D8-DetLoadSideVoltageMtrRslt	Itron - Detect Load Side Voltage Result
D8-DisconnectMeter	Itron - Disconnect Meter (Remote Disconnect)
D8-DisconnectMeterResult	Itron - Disconnect Meter Result
D8-PingByEndpoints	Itron - Ping By Endpoints (Device Status Check)
D8-PingByEndpointsMDResponse	Itron - Multi-Device Ping Response
D8-PingByEndpointsMultiDevice	Itron - Ping By Endpoints Multi-Device
D8-PingByEndpointsResponse	Itron - Ping By Endpoints Response
D8-ReadDisconStateByMtr	Itron - Read Disconnect State
D8-ReadDisconStateMtrRslt	Itron - Read Disconnect State Result
D8-ReadInterval	Itron - Contingency Read (Interval)
D8-ReadResult	Itron - Contingency Read Result
D8-ReadScalar	Itron - Contingency Read (Scalar)
D8-ReconnectMeter	Itron - Reconnect Meter (Remote Connect)
D8-ReconnectMeterResult	Itron - Reconnect Meter Result

Itron OpenWay Event Data Mapping

The Itron OpenWay event file format maps as follows into the business object, D1-DeviceEventMappingLookup:

Itron OpenWay Flat File Field	Device Event Seeder BO Element	Comments
Transaction ID (from Header record)	External Source Identifier	This is the file name.
Device Identifier	External Device Identifier	
Event Name	External Event Name	
Event Creation Date/Time	Event Date/Time	
Device Type	External Device Type	This element has no real bearing on the device type within MDM/SGG. Its valid values include (although the element itself is free-form): Meter Collector Router
Service Location ID	External Service Location ID	
Communication Module Serial Number	External Communication Module Identifier	
Event Category ID	External Event Category	
Event Severity	External Event Severity	Valid values include (although the element itself is free-form):

Itron OpenWay Flat File Field	Device Event Seeder BO Element	Comments
		Alert Information
Status Value	External Status Value	This represents additional information that relates to the event itself.
Status Date/Time	External Status Date/Time	The date & time at which the additional information referenced above had occurred.

External System

You must create an External System for each external system to which Oracle Utilities Smart Grid Gateway will send messages. Each external system defines a set of outbound message types that will be sent to that system. Each external system outbound message type also specifies the following:

- The processing method used to send the message (Batch or Real-time)
- The corresponding message senders
- Batch Control (if Processing Method is set to Batch)
- Message XSL, W3C Schema, and Response XSL (as applicable)

Outbound Message Types

Acknowledgment and response messages are sent and received validating that commands have been transmitted.

Outbound Message Type	Description
D8ITRECO	D8 Itron Remote Connect

Inbound / Outbound Service Configuration

The inbound/outbound message utility allows you to configure your system to receive information from and to send information to external applications using XML. The Oracle Utilities Smart Grid Gateway uses one inbound web service to map device events. This is the same inbound web service used by the D1 application.

Inbound Web Services

Inbound web services define the details of how messages are received from an external system, including the inbound communication business object (or business service or service script) to be invoked when the response message is received. As in the case of inbound communication business objects, the set of inbound web services you need to create is based on the types of messages the system is designed to send.

The Oracle Utilities Smart Grid Gateway adapter for Itron OpenWay includes the following inbound web services:

Inbound Web Service	Description
D1-BulkRequestHeader	Bulk Request Header
D1-BulkRequestUpdate	Bulk Request Update
D1-BulkResponse	Bulk Response
D1-DeviceEventSeeder	Used for upload of device events. The Device Event Seeder business object serves as a means of adding device events both from outside the application and from online. Its pre-processing algorithms determine the device event type - which in turn defines the device event BO that should be used to create the device event. If a device event type can't be determined, the device event is created using this BO. Such a device event can then be re-processed - and if successful, a new device event is created.

Inbound Web Service	Description
D1-DeviceStatusCheck	Device Status Check This service is invoked by the integration layer to instantiate a Device Status Check command.
D1-InitialLoadIMD	Used by OSB to instantiate an IMD The IMDSeeder business object is used to determine the type of initial measurement business object to instantiate when receiving usage readings from a head-end system.
D1-RemoteConnect	Remote Connect This service is invoked by the integration layer to instantiate a Remote Connect command.
D1-RemoteDisconnect	Remote Disconnect This service is invoked by the integration layer to instantiate a Remote Disconnect command.
D8-DetLoadSideVoltageMtrRslt	Itron - Detect Load Side Voltage by Meter Result
D8-DisconnectMeterResult	Itron - Disconnect Meter Result Service
D8-InterrogateByGroupResult	Itron - Interrogate By Group Result XIA
D8-PingByEndpointsMDResponse	Itron - Ping By Endpoints Multi-Device Response XAI Inbound
D8-PingByEndpointsResponse	Itron - Ping By End Response inbound web service
D8-ReadDisconStateMtrRslt	Itron - Read Disconnect State by Meter Result Service
D8-ReadResult	Itron - Contingency Read Result
D8-ReconnectMeterResult	Itron - Reconnect Meter Result Service

Message Senders

Message senders define the details of how messages are sent to an external system. As in the case of outbound communication business objects and outbound message types, the set of message senders you need to create is based on the types of messages the system is designed to accept.

The Oracle Utilities Smart Grid Gateway adapter for Itron OpenWay includes the following message senders:

Message Sender	Description
D8-RemoteCon	D8 Remote Connect

BPEL Processes

These processes are responsible for performing the conversion from Oracle Utilities format to Itron OpenWay format, invoking process callouts and invoking the remote endpoint to trigger the device events. BPEL modules are divided into “Composites,” or collections of business logic.

OnDemandRead Composite Process — The OnDemandRead composite invokes a sequence of web methods that call the head-end system to retrieve meter reading data and send it back to the OUAF layer. In the case of Itron OpenWay, this is accomplished using the ContingencyReadByEndpoints/GetContingencyReadByEndpointsResult services defined in the Data service WSDL.

ConnectDisconnect Composite Process — This composite is responsible for triggering the Connect and Disconnect events on the head-end system. A second, asynchronous reply sends the results back into the OUAF layer when the head-end system signals a change in the status of the device. The Itron OpenWay Adapter uses the ReconnectMeter/

GetReconnectMeterResult web service pair to connect, and the DisconnectMeter/GetDisconnectMeterResult web service pair to disconnect. Each of these services is defined in the Control service WSDL.

CommissionDecommission Composite Process — Commissioning and Decommissioning of devices, sometimes referred to as “Provisioning,” is handled by the CommissionDecommission composite. Commissioning invokes the AddMeterDefinitions web service and Decommissioning uses the DeregisterMeters web service. Both are defined in the Provisioning service.

DeviceStatusCheck Composite — This composite uses the PingByEndpoints and GetPingByEndpointsResult web services to check the health of a device. These Itron OpenWay services are defined in the Control.Diagnostic service.

Common Composite — The Common composite contains three main classes of operations: Proxies, ProcessCallouts, and utility functions. Proxies are usually simple mediators that forward a web service call to a preset endpoint. In this Adapter they have two additional roles. First, they interrogate a composite property and determine whether the supported version of head-end software is 3.70 or 3.90. Some of the proxies will also append the callback URL for the StatusChanged service. Proxies are convenient because they allow head-end URLs and security to be set in a single composite. In this case, they also offer a common location to make these checks. ProcessCallouts are points of customization which allow users to modify data and/or initiate some external business process. Utility functions serve as a central location for business logic needed by multiple composites.

Web Services

The following web services are all defined in the Itron OpenWay head-end system:

- **CommissionDecommissionService**
 - **BPEL Process:** CommissionDecommission
 - **Operation:** AddMeterDefinitions
 - **Endpoint URL:** http://<EM_SERVER>:<EM_SERVER_PORT>/soa-infra/services/<EM_PARTITION>/CommissionDecommission/CommissionDecommissionService
- **CommissionDecommissionService**
 - **BPEL Process:** CommissionDecommission
 - **Operation:** DeregisterMeters
 - **Endpoint URL:** http://<EM_SERVER>:<EM_SERVER_PORT>/soa-infra/services/<EM_PARTITION>/CommissionDecommission/CommissionDecommissionService
- **ConnectDisconnectService**
 - **BPEL Process:** ConnectDisconnect
 - **Operation:** ReconnectMeter
 - **Endpoint URL:** http://<EM_SERVER>:<EM_SERVER_PORT>/soa-infra/services/<EM_PARTITION>/ConnectDisconnect/ConnectDisconnectService
- **ConnectDisconnectService**
 - **BPEL Process:** ConnectDisconnect
 - **Operation:** DisconnectMeter
 - **Endpoint URL:** http://<EM_SERVER>:<EM_SERVER_PORT>/soa-infra/services/<EM_PARTITION>/ConnectDisconnect/ConnectDisconnectService
- **DeviceStatusCheckService**
 - **BPEL Process:** DeviceStatusCheck
 - **Operation:** DeviceStatusCheck

- **Endpoint URL:** http://<EM_SERVER>:<EM_SERVER_PORT>/soa-infra/services/<EM_PARTITION>/DeviceStatusCheck/DeviceStatusCheckService
- **OnDemandReadService**
 - **BPEL Process:** OnDemandRead
 - **Operation:** ContingencyReadByEndpoints
 - **Endpoint URL:** http://<EM_SERVER>:<EM_SERVER_PORT>/soa-infra/services/<EM_PARTITION>/OnDemandRead/OnDemandReadService

Itron OpenWay Web Services

The following table describes Itron OpenWay web services and operations used for the Oracle Utilities Smart Grid Gateway command messaging:

Smart Grid Gateway Command	AMI Adapter Business Objects	Itron OpenWay Web Services	Itron OpenWay Operations
Device Commissioning	D8-AddMeterDefinitions	ProvisioningService	AddMeterDefinitions
Device Decommissioning	D8-DeregisterMeter	ProvisioningService	DeregisterMeters
Remote Connect	D8-ReconnectMeter	ControlService	ReconnectMeter
	D8-DetectLoadSideVoltageByMtr	DiagnosticService	DetectLoadSideVoltageByMeter
	D8-ReadDisconStateByMtr		ReadDisconnectStateByMeters
Remote Disconnect	D8-DisconnectMeter	ControlService	DisconnectMeter
Device Status Check	D8-PingByEndpoints	ControlService	PingByEndpoints
			GetPingByEndpointsResult
On-Demand Read	D8-ReadInterval	DataService	ContingencyReadByEndpoints
	D8-ReadScalar		GetContingencyReadByEndpointsResult
	D1-InitialLoadIMD		InterrogateByGroup
	D1-DeviceEventSeeder	GetInterrogateByGroupResult	
		DataSubscriberService (Async Response)	DataArrived
Event Loading	D1-DeviceEventSeeder	ExceptionSubscriberService	ExceptionsArrived

Configuring an Itron OpenWay Head-End System

This section outlines the configuration required for the Oracle Utilities Smart Grid Gateway Adapter for Itron OpenWay to communicate with the Itron OpenWay application.

Master Configurations

Master Configurations are sources of global parameter records used by a system implementation. This section describes the master configuration that is specific to Oracle Utilities Smart Grid Gateway Adapter for Itron OpenWay. Refer to the Oracle Utilities Meter Data Management / Smart Grid Gateway documentation for more information about other master configurations used by Oracle Utilities Smart Grid Gateway.

Itron Version Master Configuration

This master configuration specifies the version of the Itron head-end system with which the system is communicating. The configuration options are Itron OpenWay 3.70, Itron OpenWay 3.90, and Itron OpenWay 6.10. Only one version can be specified at a time.

Inbound Web Services

Inbound web services define the details of how messages are received from an external system. This includes incoming usage and device events, as well as messages sent from the Itron OpenWay application in response to a command request.

The following inbound web services must be configured in your system. If these are not present in your configuration, add them. Refer to the Oracle Utilities Application Framework documentation for more information about creating inbound web services.

Inbound Web Service Name	Description
D1-BulkRequestHeader	Bulk Request Header
D1-BulkRequestUpdate	Bulk Request Update
D1-BulkResponse	Bulk Response
D1-DeviceEventSeeder	Device Event Seeder
D1-DeviceStatusCheck	Device Status Check
D1-InitialLoadIMD	Used by OSB to instantiate an IMD
D1-PayloadErrorNotif	Payload Error Notification
D1-PayloadStatistics	Payload Statistics
D1-PayloadSummary	Payload Summary
D8-DetLoadSideVoltageMtrRslt	Itron - Detect Load Side Voltage by Meter Result
D8-DisconnectMeterResult	Disconnect Meter Result Service
D8-InterrogateByGroupResult	Itron - Interrogate By Group Result XIA
D8-PingByEndpointsMDResponse	Itron - Ping By Endpoints Multi-Device Response XAI Inbound
D8-PingByEndpointsResponse	Itron - Ping By Endpoints Response inbound web service
D8-ReadDisconStateMtrRslt	Itron - Read Disconnect State by Meter Result Service
D8-ReadResult	Itron - Contingency Read Result
D8-ReconnectMeterResult	Itron - Reconnect Meter Result Service

Note: The following apply to all of the above inbound web services:

Message Options

- **Trace:** No
- **Debug:** No
- **Active:** Yes

Operations

- **Operation Name:** Same as web service name
- **Schema Type:** Business Object
- **Schema Name:** Applicable business object code
- **Transaction Type:** Add

Message Senders

Message senders define the details of how messages are sent to an external system, such as messages containing device command requests. A message sender should be configured for each command.

The following message senders must be configured in your system. If these are not present in your configuration, add them. Refer to the Oracle Utilities Application Framework documentation for more information about creating message senders.

Message Sender	Description
D8-ITRON_IBG	Itron Interrogate By Group
D8-COMM	Itron Commission
D8-DCOMM	Itron Decommission
D8-DLSV	Itron Detect Load Side Voltage
D8-IPBE	Itron Ping By Endpoints
D8-RCONN	Itron Remote Connect
D8-RDCONN	Itron Remote Disconnect
D8-RDSS	Itron Read Disconnect State

Note: The following apply to all of the above message senders:

Main Tab:

- **Invocation Type:** Real-time
- **Message Class:** RTHTTPSNDR (Sender routes message via HTTP real-time)
- **MSG Encoding:** UTF-8 message encoding

Context Tab:

- **HTTP Header:** SOAPAction:http://xmlns.oracle.com/ouaf/Itron/<OPERATION>
- **HTTP Login User:** <USER_ID>
- **HTTP Login Password:** <PASSWORD>
- **HTTP Method:** POST
- **HTTP URL 1:** http://<EM_SERVER>:<EM_SERVER_PORT>/soa-infra/services/Itron/<SERVICE>
- where:
 - <OPERATION>: the operation performed by the message sender (see Operation column in the table above)
 - <USER_ID>: the user ID used to log into WebLogic Enterprise Manager
 - <PASSWORD>: the password used to log into WebLogic Enterprise Manager
 - <EM_SERVER>: the machine name or IP address of server where the WebLogic Enterprise Manager is installed
 - <EM_SERVER_PORT>: the port where the WebLogic Enterprise Manager is installed
 - <SERVICE>: the service invoked by the message sender (see Service column in the table above)

How to Use Enterprise Manager to Locate the URL for the Message Sender

Follow this procedure to find the correct URL for the command associated with a message sender:

1. Open Enterprise Manager and use the navigation pane to open the dashboard of the service used by the message sender:
2. The top bar of the dashboard contains several buttons and icons. One of these is a “world” icon with a puzzle piece over it. Click this icon to display a list of the WSDLs and endpoint URIs for the service:
3. Click the service’s WSDL URL link to see the WSDL in the browser, or right click and save it to your machine.

Outbound Message Types

Outbound message types define specific types of messages sent to an external system, such as messages containing device command requests.

The following outbound message types must be configured in your system. If these are not present in your configuration, add them. Refer to the Oracle Utilities Application Framework documentation for more information about creating outbound message types.

Outbound Message Type	Description
D8-CONREAD	Itron Contingency Read By Endpoints
D8-INTRGRP	Itron Interrogate By Group
D8-COMM	Itron Commission
D8-DCOMM	Itron Decommission
D8-DSC	Itron Device Status Check
D8-DSCMD	Itron Device Status Check Multi Device
D8-DLSV	Itron Detect Load Side Voltage
D8-RCONN	Itron Remote Connect
D8-RDCONN	Itron Remote Disconnect
D8-RDSS	Itron Read Disconnect State

Note: The following apply to all of the above outbound message types:

- **Business Object:** D1-OutboundMessage (Outbound Message)
- **Priority:** Priority 50

External System

External systems represent external applications with which the Smart Grid Gateway will exchange messages or data. In the case of the Smart Grid Gateway adapters, external systems represent the head-end systems with which the adapters communicate.

An external system that represents the Itron OpenWay head end must be present in your system. If this is not present in your configuration, add it, along with the following Outbound Message Types. Refer to the Oracle Utilities Application Framework documentation for more information about creating external systems.

External System - Itron OpenWay:

- **External System:** Itron OpenWay
- **Description:** Itron OpenWay
- **Outbound Message Types:**

Outbound Message Type	Message Sender
D8-INTRGRP	D8-ITRON_IBG
D8-COMM	D8-COMM
D8-DCOMM	D8-DCOMM
D8-DSC	Message sender associated with the Device Status Check Outbound Message Type
D8-DSCMD	Message sender associated with the Device Status Check Multi Device Outbound Message Type
D8-DLSV	D8-DLSV
D8-RCONN	D8-RCONN
D8-RDCONN	D8-RDCONN

Outbound Message Type	Message Sender
D8-RDSS	D8-RDSS

Note: The following apply to all of the above outbound message types:

- **Processing Method:** Real-time
- **Message XSL:** D8-Request xsl
- **Response XSL:** D8-Response.xsl

Service Provider

Service providers represent external entities that serve various roles relative to the application, including head-end systems, billing systems to which the application sends bill determinant data, market participants in a deregulated environment, outage management systems that receive meter event data from the application, or other parties that require or provide information to the system. The head-end systems that collect and send measurement data and meter events to the application are defined as service providers.

A service provider that represents the Itron OpenWay head end must be present in your system. If this are not present in your configuration, add it. Refer to the Oracle Utilities Service and Measurement Data Foundation documentation for more information about creating service providers.

Service Provider - Itron OpenWay:

- **Service Provider:** Itron OpenWay
- **Description:** Itron OpenWay
- **External Reference ID:** Itron OpenWay
- **External System:** Itron OpenWay
- **Our Name/ID in Their System:**
- **AMI Device ID Type:** Internal Meter Number
- **Pre-Commissioning Device ID Type:**
- **AMI Measuring Component ID Type:** Channel ID

Processing Methods

Processing methods define the format or means by which a service provider receives and/or sends data from and/or to the application, including as bill determinants, usage data, or device events. Processing methods are also used to define how to create information internal to the application such as initial measurement data and device events. Processing methods can also be used to define how command requests are sent to a given head-end system.

The following types of processing methods must be configured for the Itron OpenWay service provider. Refer to the Oracle Utilities Service and Measurement Data Foundation documentation for more information about configuring processing methods.

Initial Measurement Creation

Initial measurement creation processing methods define the business objects used to create initial measurements. The IMD Seeder inbound web service uses this processing method to determine which type of initial measurement business object to instantiate when receiving usage from a head-end system.

Device Event Mapping

Device event mapping processing methods define how head-end-specific device events are mapped to standard device event names. The Device Event Seeder inbound web service uses this processing method to determine which type of device event business object to instantiate when receiving device events from a head-end system.

UOM Translation

UOM mapping processing methods define how head-end-specific unit of measure (UOM) codes are mapped to standard UOM codes. This processing method is used to determine how to map head-end system UOM codes to standard UOM codes when receiving usage from the head-end system.

Commands

Command processing methods define how command requests are sent to a head-end system. More specifically, they define the type of outbound communication business object to create for each type of command, and the outbound message type to send to the head-end system.

The following types of command processing methods can be configured for the Itron OpenWay service provider, based on the requirements of each implementation using the “How to Create OB COMM/Send OB Message” processing method business object (D1–HowToCreateActivityOBComm).

Command	Processing Role	Default Business Object	Default Outbound Message Type
Device Commission	Device Registration	D8-AddMeterDefinitions	Commission
Device Decommission	Device Removal	D8-DeregisterMeter	Decommission
Device Status Check	Device Status Check	D8-PingByEndpoints	Device Status Check
Load Check*	Load Check	D8-DetectLoadSideVoltageByMtr	Detect Load Side Voltage by Meter
Multi-Devie Status Check	Multi-Devie Status Check	D8-PingByEndpointsMultiDevice	Read Disconnect State By Meters
On-Demand Read (Scalar)	On-Demand Read (Scalar)	D8-ReadScalar	On Demand Read — Scalar
Remote Connect	Remote Connect	D8-ReconnectMeter	Connect
Remote Disconnect	Remote Disconnect	D8-DisconnectMeter	Disconnect

* The Load Check processing method can be used to ensure that it is safe to connect a meter. The load check processing method is executed during the Connection Ready state of the Remote Connect activity and can be configured to detect the possibility of a load side voltage at the meter, or to check the disconnect meter switch on the meter.

If the Read Disconnect State business object is used as the processing method, you should configure the disconnect switch state values that indicate the state of the switch. These values are defined on the D8-DisconnectSwitchStateLookup extendable lookup, and are then added in the Disconnect Switch State Error Values section of the Itron - Read Disconnect State Result Inbound communication type. See [Itron OpenWay Disconnect Switch State Lookup](#) for more information.

Configuring Endpoint URIs

Part of the configuration process is configuring your BPEL composites to work with your head-end system by defining the appropriate Endpoint URIs for each of the commands. The default approach to defining Endpoints URIs is redeployment or reinstallation of the BPEL composites. For example, by default, changing an adapter from using the test harness to a production environment using the actual head-end system requires editing the appropriate installation menu options and redeploying the BPEL composites. The Endpoints URIs defined during installation and deployment for each adapter are listed in the **Smart Grid Gateway Installation and Configuration Worksheets** section of the *Oracle Utilities Smart Grid Gateway Installation Guide*.

You can also use an “Endpoint Override” Domain Value Map (DVM) to override Endpoint URIs defined during deployment and installation. This DVM allows defining specific keys that provide an alternate URL that will override the original installed value. Endpoint Override DVMs can be edited using the Oracle SOA Composer.

The Itron OpenWay endpoint override DVM (D8–EndpointOverrides.dvm) uses a specific set of keys, each used for one or more commands. The table below lists the DVM keys available for the Itron OpenWay adapter and the command used with each:

DVM Key	Commands
DataService390	Scheduled Read (Scalar) Scheduled Read (Interval) On-Demand Read (Scalar) On-Demand Read (Interval)
ProvisioningService370	Device Commissioning
ProvisioningService390	Device Decommissioning
ControlService370	Device Status Check (if using v3.70) Remote Connect (if using v3.70) Remote Disconnect (if using v3.70)
ControlService390	Remote Connect (if using v3.90) Remote Disconnect (if using v3.90)
DiagnosticService390	Device Status Check (if using v3.90)
ProcessCallout	User Exit Functions

NOTE:

The numbers in the keys above (370 and 390) designate the version of the Itron OpenWay head-end system.

Only a single version of each key should be defined, based on the version of the Itron OpenWay head-end system

To define an override Endpoint URI for the Itron OpenWay adapter, use the following procedure:

1. Open the SOA Composer for your BPEL configuration.

The URL for the SOA Composer is <http://server:port/soa/composer>.

2. Select the D8–EndpointOverrides.dvm in the left panel.

- In Fusion Middleware v12.2.1, this is located under **Shared** in the **Deployment View**, or under **Domain Value Maps** in the **Types View**.
- In Fusion Middleware v12.2.2, this is located under **Metadata** in the **Deployment View**.

The DVM will open in the right panel. The **Description** field lists the available keys for the DVM (only the first key is shown, but you can scroll through the contents to view the list. The panel also displays a list of previously defined keys.

3. Click the **Create Session** button (above the left panel) to begin an editing session.

4. Click the **Add Domain Values** icon (“+”) to add a new key.

The **Add Domain Values** dialog opens.

5. Enter the appropriate values in the **Add Domain Values** dialog as follows:

- **key:** The DVM key for the Endpoint URI you wish to define (see the table above).
- **EndpointURI:** The override Endpoint URI.

6. Click **OK**.

The new DVM value will appear in the list of keys.

7. Click the **Save** icon to save the DVM values.

8. Click the **Publish** button to activate all the changes in the editing session.

Enter an optional note for the session in the **Publish Session** dialog.

Changes take effect immediately upon publishing the session.

Click **Discard** to discard your changes.

Click **Exit** to exit your current session. Note that your session will still be open if you exit. Use **Discard** to end your session without making changes.

Configuring Itron OpenWay Extendable Lookups

NOTE: This section applies to **both** middleware and native implementations of the Smart Grid Gateway Adapter for Itron OpenWay.

This section outlines some of the extendable lookups that must be configured for use with the Itron OpenWay adapter. Refer to the Oracle Utilities Application Framework documentation for more information about working with extendable lookups.

Application Group Lookup

The Itron OpenWay head-end system allows users to define addressable groups of meters based on criteria such as a geographic identifier or zip code. These application groups can be represented in Oracle Utilities Smart Grid Gateway by using the Itron OpenWay Application Group Lookup. The groups defined for this lookup are used with Scheduled Read commands. Each value defined for the Itron OpenWay Application Group extendable lookup should include the following:

- **Application Group:** The application group name as defined in the Itron OpenWay head-end system.
- **Description:** A description of the application group.

Device Event Mapping

The Device Event Mapping extendable lookup is used to determine which type of device event business object to instantiate when receiving device events from the head-end system. Each value defined for the Device Event Mapping extendable lookup should include the following:

- **Head-End System Event Name:** The event name used by the head-end system
- **Description:** A description of the device event
- **Status:** The status of the lookup value (can be Active or Inactive)
- **Standard Event Name:** The standard event name for device events of this type, from the “Standard Event Name” extendable lookup.

Disconnect Switch State Lookup

Some utilities may require verification of the load on a meter to ensure that it is safe to connect the meter. One method of doing this is to check the disconnect switch on the meter to see if it is connected or armed. To use this method, the Itron OpenWay Disconnect Switch State extendable lookup should be configured to list the possible states of the meter disconnect switch. Each value defined for the Itron OpenWay Interval Disconnect Switch State extendable lookup should include the following:

- **Switch State:** The Itron OpenWay disconnect switch state code
- **Description:** A description of the disconnect switch state code.

UOM Code to Standard UOM Mapping

Usage received from a utility’s head-end system may use utility-specific unit of measures (UOMs). These custom UOMs must be mapped to standard UOM codes. The UOM Code to Standard UOM Mapping extendable lookup is used for this purpose. Each value defined for the UOM Code to Standard UOM Mapping extendable lookup should include the following:

- **Head-End Unit of Measure:** The unit of measure code used by the Itron OpenWay application

- **Description:** A description of the unit of measure code.
- **Status:** The status of the lookup value (can be Active or Inactive)
- **Unit of Measure:** The unit of measure defined in the system.
- **Time of Use:** An optional time of use period, defined in the system, used to further distinguish the unit of measure.
- **Service Quantity Identifier:** An optional service quantity identifier, defined in the system, used to further distinguish the unit of measure.
- **Unit of Measure Magnitude Conversion:**
 - **Magnitude Multiplier:** An optional; multiplier used to convert raw values received from the head-end system to values appropriate for use with the system. For example, if a reading or interval data is received in Wh, a multiplier of “.001” would convert Wh to kWh. If not provided or left blank, no conversion is performed.

Interval Status Code to Condition Mapping

Interval usage received from the Itron OpenWay application can include Itron OpenWay interval status codes that indicate the status or condition of the interval value. These interval status codes must be mapped to standard condition codes in the system. The Itron OpenWay Interval Status Code to Condition Mapping extendable lookup is used to determine how to map Itron OpenWay interval status codes to standard status codes when receiving usage from the Itron OpenWay application. Each value defined for the Itron OpenWay Interval Status Code to Condition Mapping extendable lookup should include the following:

- **Interval Status:** The Itron OpenWay interval status code
- **Description:** A description of the interval status code.
- **Status:** The status of the lookup value (can be Active or Inactive)
- **Condition:** The condition code to which the interval status code is to be mapped, from the Measurement Condition extendable lookup.

Other Extendable Lookups

Business Object Name	Description
D8-DvcStatusMappingLookup	Itron - Device Status Lookup
D8-FailureReasonLookup	Itron - Failure Reason Lookup
D8-ItronVersions	Itron - Versions Lookup
D8-JobStatusLookup	Itron - Job Status
D8-ResultLookup	Itron - Result Lookup
D8-RptSelfReadOptionLookup	Itron - Report Self Read Option Lookup

Using the Itron OpenWay Test Harness

Oracle Utilities Smart Grid Gateway Adapter for Itron OpenWay includes a test harness that can be configured to simulate a general head-end system for testing the two-way commands. The test harness includes a BPEL composite, web services for standard meter functions, and an XML file that can be used to contain information for one or more meters. See [Using Smart Grid Gateway Test Harnesses](#) for more information.

Landis+Gyr

The Oracle Utilities Smart Grid Gateway Adapter for Landis+Gyr supports communication with the Landis+Gyr Gridstream Command Center, including measurement data and device event loading, and command messaging in support of

commissioning, connect, disconnect, decommissioning, and on-demand read. The following table describes the attributes of the adapter:

Attribute	Details
Currently Supported Version	Gridstream Command Center 8.1
Smart Meter Command Format	MultiSpeak v3.1
Bulk Usage/Event Data Format	California Metering Exchange Protocol (CMEP)
Market(s)	North America, portions of Asia Pacific, Sweden, Australia, New Zealand, and Latin America.
Commodities Supported	Electricity, Gas, Water
Architecture	PLC and RF

Landis+Gyr Adapter Processing

This section provides details concerning the OSB processing, BPEL Processes, and Oracle Utilities Application Framework (OUAF) objects that are supplied as part of the base package. This information illustrates how the base package objects were designed, and can serve as the basis for any customizations you create as part of your implementation.

Initial Measurement Data and Device Event Loading

The initial measurement data load and device event processing use OSB to poll for, parse, and transform the head-payloads into the Oracle Utilities Smart Grid Gateway (SGG) service format. Payloads contain measurements and meter events in some head-end specific format. OSB then places each service call into a Java Message Service (JMS) queue within the Oracle Utilities applications. The JMS client consumes the entries and invokes the respective services in parallel. A service then creates initial measurements with data in a common format with head-end-specific processing as needed. A second service creates device events with data in a common format.

Initial Measurements

The usage data exported from the AMI head-end system as a file in Landis+Gyr format is loaded into Oracle Utilities as initial measurement data. The following OSB projects, delivered in the base product, help manage the usage processing:

1. **SGG-D3-USAGE-BASE** - contains components responsible for “actual” processing of incoming data. It should not be modified during configuration. This can be upgraded without affecting the customization and environment settings added to SGG-D3-USAGE-CM.
2. **SGG-D3-USAGE-CM** allows for customization and simplifies future upgrades.

When importing non-interval usage data, separate initial measurements can be created for difference measurement types. For instance, if the data includes Power Factor or Volt data, separate initial measurements are created for each of these. See [Non-Interval 'Plain' XML to IMD Mapping](#) for more information about specific units of measure that trigger the creation of separate initial measurements.

The runtime configuration settings for the SGG-D3-USAGE-CM project are stored in the EnvironmentSettings.xq XQuery file. You can use this file to adjust initial measurement data processing. For example, if you want to load raw data you would specify “true” for the content of the populateRawIMD element.

The following table describes the elements included in the EnvironmentSettings.xq file:

Element	Description	Valid Values
populateRawIMD	Determines if the initial measurement data is populated as raw data.	true false
callPreProcessing	Determines if the preprocessing proxy service is called.	true false
callPostProcessing	Determines if the postprocessing proxy service is called.	true false

Element	Description	Valid Values
destinationRootElementInterval	Holds the name of inbound web service for the interval IMD seeder.	
destinationRootElementScalar	Holds the name of inbound web service for the scalar IMD seeder. In most cases it is the same as destinationRootElementInterval.	
modifyResultXMLInput	Specifies the name of an XQuery document (without the "xq" extension) used to map additional fields from the "plain" XML format to the result XML format sent as initial measurement data. See Mapping Additional Fields for more information.	
dateTimeInUTC	Indicates whether the Landis+Gyr system is sending date/time information in UTC (true) or local time of the device (false). If not provided the default behavior will be local time of the device.	true false
publishServices/service	Specifies the name of the business service within the OSB project used to publish data for external systems (such as Oracle DataRaker).	
filterUsage	Determines if usage should be filtered.	true false

Publishing Initial Measurement Data

The SGG adapter can be configured to publish initial measurement data for use in Oracle DataRaker or other external systems. This functionality is supported through a combination of OSB components and BPEL composites.

Enabling Initial Measurement Data Publishing

Publishing data is enabled by referencing a publisher business service in the publishServices/service element in the EnvironmentSettings.xq file as follows:

```
<publishServices>
  <service>[publisherBusinessService]</service>
</publishServices>
```

The following components provided with the SGG-D3-USAGE-CM OSB project are used in publishing measurement data to Oracle DataRaker:

- The **DataRakerBusinessService** business service is used to send data to a pre-configured JMS queue (defined as an Endpoint URI), from which the data will be published. This is the business service that should be specified in the EnvironmentSettings.xq file.
- The **DataRakerServiceAccount** service account is used to define and maintain the user name and password needed to access the JMS queue defined in the **DataRakerBusinessService** business service.

Configuring Initial Measurement Publishing Output

The SGGDRIntegration BPEL composite handles publishing the data to Oracle DataRaker or other systems. Initial measurement data is published in the “native” initial measurement data format (the format of the initial measurement seeder business object). This format includes normalized unit of measure and condition codes. See the *Oracle Utilities Smart Grid Gateway Adapter Development Kit Administrative User Guide* for more details about this format.

NOTE: Initial measurement data published through this feature is published prior to validation, estimation, and editing (VEE) processing. In addition, filtering *cannot* be applied to data published through this feature.

The following parameters can be used to configure details of how the data is provided to Oracle DataRaker, including the directory where files are posted for Oracle DataRaker to consume, number of records per file, polling frequency, etc. These parameters are defined during installation. See the *Oracle Utilities Smart Grid Gateway Installation Guide* for more details about defining values for these parameters.

Parameter	Description	Default Value
SGG_DR_INT_QUEUE	JNDI name of queue to publish SGG payloads. This is the JMS queue defined in the DataRakerBusinessService business service. This should NOT be changed.	DataRakerQueue
SOA_DR_PUBLISH_SIZE	The number of records (SGG payloads) to accumulate in a published file.	100
SOA_DR_FILE_SIZE	The maximum file size for the accumulated (SGG payloads) file in kilobytes.	524288
SOA_DR_ELAPSED_TIME	The period of time in second which, when exceeded, causes a new outgoing file to be created.	600
SOA_DR_POLLING_FREQ	The polling frequency in seconds of the staging directory for new files.	60
SOA_DR_STAGING_DIR	Mount point/directory for the staging directory for accumulated SGG payload files. This is used internally and should NOT be changed.	/spl/sploutput/staging
SOA_DR_INTEGRATION_DIR	Mount point/directory from which Oracle DataRaker will consume the converted XML files.	/spl/sploutput/int

Filtering Initial Measurement Data

The SGG adapter can be configured to filter initial measurement data passed into SGG and the Oracle Utilities Meter Data Management application. Filtering data is enabled by setting the <filterUsage> element in the EnvironmentSettings.xq file to “true” as follows:

```
<filterUsage>true</filterUsage>
```

When filtering is enabled, only measurements whose <externalUOM> matches one of the values defined in the **Landis+Gyr UOM Code to Standard UOM Mapping** extendable lookup (D3-HeadendUOMLookup) are passed into the system for processing.

NOTE: Filtering of scalar initial measurement data is not supported in the Landis+Gyr adapter.

Processing Large Input Files

In some environments, the OSB project may begin processing a large input file before it has been completely copied to the input directory. To prevent this, configure the MinimumAge property in the “InboundProxyService” proxy service for the project. The MinimumAge property specifies the minimum age of files to be retrieved, based on the last modified time stamp. This enables large files to be completely copied to the input directory before they are retrieved for processing.

Prioritized Initial Measurement Processing

The SGG adapter prioritizes processing of initial measurements created from smart meter commands and/or completion events by setting the Execution Method flag in these types of initial measurements to “Real Time” (D1RT). In addition, initial measurements received with the Execution Method flag set to “Real Time” will be processed in real time rather than via batch processing. See **Initial Measurement Data Prioritization** in the *Oracle Utilities Meter Data Management / Smart Grid Gateway Business User Guide* for more information.

Device Events

The device event data exported from the head-end system as a file in Landis+Gyr format is loaded into Oracle Utilities as a Device Event. One of your configuration tasks is to customize the device events processing. The required functionality is delivered in the base product as two OSB projects:

1. **SGG-D3-EVENT-BASE** containing components responsible for "actual" processing of incoming data. It can be upgraded in future without affecting the customization and environment settings that done in SGG-D3-EVENT-CM project.
2. **SGG-D3-EVENT-CM** allows the customization and simplifies the future upgrades.

The runtime configuration settings for the SGG-D3-EVENT-CM project are stored in the EnvironmentSettings.xq XQuery file. You can use this file to adjust device event data processing. For example, if you want to load raw data you would specify "true" for the content of the populateRaw element. The following table describes the elements included in the EnvironmentSettings.xq file:

Element	Description	Valid Values
populateRaw	Determines if the device event data is populated as raw data.	true false
callPreProcessing	Determines if the preprocessing proxy service is called.	true false
callPostProcessing	Determines if the postprocessing proxy service is called.	true false
destinationRootElement	Holds the name of inbound web service for the device event seeder.	
modifyResultXMLInput	Specifies the name of an XQuery document (without the "xq" extension) used to map additional fields from the "plain" XML format to the result XML format sent as device event data. See Mapping Additional Fields for more information.	
dateTimeInUTC	Indicates whether the Landis+Gyr system is sending date/time information in UTC (true) or local time of the device (false). If not provided the default behavior will be local time of the device.	true false
publishServices/service	Specifies the name of the business service within the OSB project used to publish data for external systems (such as Oracle DataRaker).	
filterEvents	Determines if events should be filtered.	true false

Publishing Events

SGG can be configured to publish device events for use in Oracle DataRaker or other external systems. This functionality is supported through a combination of OSB components and BPEL composites.

Enabling Device Event Publishing

Publishing data is enabled by referencing a publisher business service in the publishServices/service element in the EnvironmentSettings.xq file as follows:

```
<publishServices>  
  <service>[publisherBusinessService]</service>  
</publishServices>
```

The following components provided with the SGG-D3-EVENT-CM OSB project are used in publishing device events data to Oracle DataRaker:

- The **DataRakerBusinessService** business service is used to send data to a pre-configured JMS queue (defined as an Endpoint URI), from which the data will be published. This is the business service that should be specified in the EnvironmentSettings.xq file.

- The **DataRakerServiceAccount** service account is used to define and maintain the user name and password needed to access the JMS queue defined in the **DataRakerBusinessService** business service.

Configuring Device Event Publishing Output

The SGGDRIntegration BPEL composite handles publishing the data to Oracle DataRaker or other systems. Device event data is published in the “native” device event data format (the format of the device event seeder business object). This format includes normalized device event codes. See the *Oracle Utilities Smart Grid Gateway Adapter Development Kit Administrative User Guide* for more details about this format.

NOTE: In addition, filtering can NOT be applied to device events published via this feature.

The following parameters can be used to configure details of how the data is provided to Oracle DataRaker, including the directory where files are posted for Oracle DataRaker to consume, number of records per file, polling frequency, etc. These parameters are defined during installation. See the *Oracle Utilities Smart Grid Gateway Installation Guide* for more details about defining values for these parameters.

Parameter	Description	Default Value
SGG_DR_INT_QUEUE	JNDI name of queue to publish SGG payloads. This is the JMS queue defined in the DataRakerBusinessService business service. This should NOT be changed.	DataRakerQueue
SOA_DR_PUBLISH_SIZE	The number of records (SGG payloads) to accumulate in a published file.	100
SOA_DR_FILE_SIZE	The maximum file size for the accumulated (SGG payloads) file in kilobytes.	524288
SOA_DR_ELAPSED_TIME	The period of time in second which, when exceeded, causes a new outgoing file to be created.	600
SOA_DR_POLLING_FREQ	The polling frequency in seconds of the staging directory for new files.	60
SOA_DR_STAGING_DIR	Mount point/directory for the staging directory for accumulated SGG payload files. This is used internally and should NOT be changed.	/spl/sploutput/staging
SOA_DR_INTEGRATION_DIR	Mount point/directory from which Oracle DataRaker will consume the converted XML files.	/spl/sploutput/int

Filtering Events

The SGG adapter can be configured to filter initial measurement data passed into SGG and the Oracle Utilities Meter Data Management application. Filtering data is enabled by setting the <filterUsage> element in the EnvironmentSettings.xq file to “true” as follows:

```
<filterEvents>true</filterEvents>
```

When filtering is enabled, only device events whose <externalEventName> matches one of the values defined in the **Landis+Gyr Device Event Mapping** extendable lookup (D3-DeviceEventMappingLookup) are passed into the system for processing.

Subscribing to Real-Time Device Events

The Landis+Gyr Command Center provides the ability to "subscribe" to device events from within their online interface. This is done by creating a subscriber in Command Center with an associated callback URL as well as a list of events types that subscriber is interested to receive. When an event that is subscribed to occurs it is sent to the callback URL in real time.

Within L+G Events are configured with one of three "alarm" settings. These settings determine how often the events will be sent to subscribers:

1. Alarm: immediately delivered from the meter
2. Advisory: sent based upon a delivery schedule
3. Log Only: sent only upon request (not applicable for our implementation real time event processing)

Command Center will communicate the events using a CIM format that describes the message as a noun/verb combination. The details of the event itself will be contained within a "payload" element of the standard structure. The payload will be formatted using the EndDeviceEvent message structure. This message identifies device events using a CIM 4-part category number. These numbers are four period separated numbers that will describe the type of device and the event. For example: 3.33.1.257 is for "Tamper attempt suspected".

- Segment 1: End Device event domain code (e.g. 3. meter/10. collector/11. router/12. HAN device)
- Segment 2: End Device Event Domain Part Codes (e.g. 1. Access/2. Battery)
- Segment 3: End Device Event Type Codes (e.g. 1. Alarm/2. Alarm Mgt)
- Segment 4: End Device Event Index (e.g. 1. Abort/2. Access Attempt)

Refer to the Landis+Gyr documentation for details about the CIM Category Numbers. CIM Category Numbers must be mapped to standard device event names using the Landis+Gyr Device Event Mapping extendable lookup.

SGG receives these messages through a BPEL composite that saves the incoming request as a file to be picked up by OSB.

The **AMIEventSubscriber** composite is responsible for receiving the event messages based on subscriptions defined in the L+G Command Center. The callback URL configured for the subscription in the Command Center should point to this BPEL composite.

The following OSB projects parse individual device events from the message and perform the validation and mapping of the information to the Device Event Seeder Format.

1. **SGG-D3-CIM-EVENT-BASE** contains components responsible for "actual" processing of incoming data. It can be upgraded in future without affecting the customization and environment settings that done in **SGG-D3-CIM-EVENT-CM** project.
2. **SGG-D3-CIM-EVENT-CM** allows the customization and simplifies the future upgrades.

The runtime configuration settings for the **SGG-D3-CIM-EVENT-CM** project are stored in the EnvironmentSettings.xq XQuery file. You can use this file to adjust device event data processing. For example, if you want to load raw data you would specify "true" for the content of the populateRaw element.

The following table describes the elements included in the EnvironmentSettings.xq file:

Element	Description	Valid Values
populateRaw	Determines if the device event data is populated as raw data.	true
		false
callPreProcessing	Determines if the preprocessing proxy service is called.	true
		false
callPostProcessing	Determines if the postprocessing proxy service is called.	true
		false

Element	Description	Valid Values
destinationRootElement	Holds the name of inbound web service for the device event seeder.	
publishServices/service	Specifies the name of the business service within the OSB project used to publish data for external systems (such as Oracle DataRaker).	
filterEvents	Determines if events should be filtered.	true false

Processing statistics are gathered for any real time events that are received (even if there is just one event in the message) in the same manner as device events received via the flat-file interface.

Prioritized Device Event Processing

The SGG adapter prioritizes processing of device events created from smart meter commands and/or completion events by setting the Execution Method flag in these types of device events to “Real Time” (DIRT). In addition, device events received with the Execution Method flag set to “Real Time” will be processed in real time rather than via batch processing. See **Device Event Prioritization** in the *Oracle Utilities Meter Data Management / Smart Grid Gateway Business User Guide* for more information.

Configuring Payload Processing Notifications

By default, Payload Statistics, Payload Error Notification, and Payload Summary notification activities are sent to the Notification Queue within Oracle Service Bus. Smart Grid Gateway adapters can be configured to restrict sending these activities by defining optional JCA transport dynamic properties in the appropriate OSB project. The following optional JCA transport dynamic properties can be used to control if these notification activities are sent:

- **SGG_SEND_STATISTICS**: Controls sending Payload Statistic activities (true: send, false: do not send)
- **SGG_SEND_ERROR**: Controls sending Payload Error Notification activities (true: send, false: do not send)
- **SGG_SEND_SUMMARY**: Controls sending Payload Summary activities (true: send, false: do not send)

When these properties are set to false, the corresponding payload notification will not be sent to the JMS Queue. Note these properties are not populated by default, and default to true if omitted.

To create these properties:

1. Navigate to the SGG-D3-CIM-EVENT-CM project in the Oracle Service Bus Console.
2. Expand the **Proxy Services** folder.
3. Select the **InboundProxyService** proxy service (not the Pipeline or WSDL).
4. Click **Create** to create a new session.
5. Select **Transport Details**.
6. Click the plus sign in the **Dyanmic EndPoint Properties** section. An empty row will appear.
7. Enter the property you wish to define in the **Property** column.
8. Enter "false" in the **value** column.
9. Repeat steps 6-8 for each property you wish to define.
10. Click **Activate** to save and activate your changes.

NOTE: These properties are only used if the SGG_EXT_ID_PATTERN is not present or the regular expression captures nothing. The SGG_EXT_ID_PATTERN will override these properties when the regular expression captures group data.

Base Package Business Objects

The Landis+Gyr adapter base package includes the following initial measurement business objects:

Business Object Name	Description
D3-InitialLoadIMDInterval	Landis+Gyr Initial Load IMD - Interval Used when loading Landis+Gyr interval measurements into the system for the first time.
D3-InitialLoadIMDScalar	Landis+Gyr Initial Load IMD - Scalar

Device Communication

The basic communication for all business processing is essentially the same. A communication request is sent from the Oracle Utilities application to the head-end system. This request would be for a connect/disconnect, commission/decommission, measurement data, an on-demand read, or another type of request that the head-end system supports. The designated BPEL process transforms the request from Oracle Utilities format to MultiSpeak format and invokes the related web service from the head-end system. The head-end system then returns a reply, and the BPEL process transforms the reply message back to the appropriate format so that Oracle Utilities can receive the response.

Communication Flows

The table below lists the communications created for each Landis+Gyr command:

Command	Outbound Communication	Inbound Communication	Completion Event
Remote Connect (This command has sub-commands)	Initiate MR by Mtr Num	Reading Changed Notification	Connect Device
	Initiate Connect Disconnect	Connect Disconnect State Changed Notification	Create IMD Completion Event
Remote Disconnect (This command has sub-commands)	Initiate Connect Disconnect	Connect Disconnect State Changed Notification	Disconnect Device
	Initiate MR by Mtr Num	Reading Changed Notification	Create IMD Completion Event
Device Commissioning (Registration)	L+G Add Meter to Inventory		Device Commissioning
Device Commissioning (Installation)	L+G Meter Exchange Notification		Device Commissioning
Device Decommissioning	Meter Remove Notification		Device Decommissioning
Device Deregistration	L+G Meter Retire Notification		Device Deregistration
On-Demand Read (Scalar)	Initiate MR by Mtr Num	Reading Changed Notification	Create IMD Completion Event
On-Demand Read (Scalar) - CIM	CIM Meter On Demand Read (Scalar)	CIM Meter On Demand Read Response	Create IMD Completion Event
On-Demand Read (Interval)	Initiate MR by Mtr Num	Reading Changed Notification	Create IMD Completion Event
On-Demand Read (Interval) - CIM	CIM Meter On Demand Read (Interval)	CIM Meter On Demand Read Response	Create IMD Completion Event
Device Status Check	CIM Ping	CIM Ping Response	
Demand Reset	Schedule Demand Reset (Multispeak)	Schedule Demand Reset Response (Multispeak)	Create IMD Completion Event

Device Registration Commission Commands

Landis+Gyr device commission commands can be used to “register” the device and notify the L+G head-end system that meters have been added to inventory. Device commission commands of this type have the “Registration-Only Mode” flag

set to “Yes”. An Enter algorithm on the “Commission Ready” state evaluates the Registration-Only Mode of the command and if set to “Yes”, the command skips the default “Waiting for Measurement” state and is transitioned to the “Execute Completion Event” state, and an activity log entry is created.

Only the device registration request is sent to the head-end system for device commission commands of this type.

Device registration commands are typically created when new devices are added to inventory in an asset management system such as Oracle Utilities Operational Device Management.

Device Installation Commission Commands

Landis+Gyr device commission commands can be used to notify the L+G head-end system that meters have been installed or exchanged. An Enter algorithm on the “Commission Ready” state evaluates the “Is Installation Check Unnecessary” flag of the command and if set to “False”, the algorithm creates an “L+G Meter Exchange Notification” outbound communication and sends an installation notification to the head-end system.

Device Deregistration Commands

The Landis+Gyr adapter supports the Device Deregistration command (based on the D1-DeviceDeregistration business object). This command sends a communication that deregisters the device in the head-end system, and is most often used when retiring a device. The specific message sent is defined for the Device Deregistration processing role for the L+G head-end system service provider.

Device deegistration commands are typically created when devices are retired in an asset management system such as Oracle Utilities Operational Device Management.

Unit of Measure Filtering for On-Demand Reads

Readings returned via On-Demand Read commands are filtered on the combination of Unit of Measure/Time of Use/Service Quantity Identifiers (UOM/TOU/SQI) configured for the device and measuring component. When filtering is enabled, only readings that match a configured UOM/TOU/SQI combination are processed. All others are filtered out.

Filtering is enabled by default via the “Opt Out Of Filtering” parameter (set to "false" by default) on the D3-CCOMPEV (Create IMD Completion Event) algorithm on the Create Completion Events status of the D3-ReadingChgNotification (Reading Changed Notification - SOA based) business object.

The D3-VALDVCFIL (Check if Device has any Filtering errors) algorithm on the Validate status of the D3-ReadingChgNotification (Reading Changed Notification - SOA based) business object is used to check for errors related to filtering. The value of the “Opt Out Of Filtering” parameter on this algorithm must match the value of the parameter on the D3-CCOMPEV algorithm. The parameters should both be set to either "false" (the default) or "true" (if filtering is to be disabled).

Demand Reset Commands

For on-demand read commands associated with Demand Reset commands, filtering is enabled by default via the “Opt Out Of Filtering” parameter (set to "false" by default) on the D3-SDRCCE (Create Schedule Demand Reset Completion Event) algorithm on the Create Completion Events status of the D3-ScheduleDemandResetResponse (Schedule Demand Response(Multispeak)) business object.

The D3-VALSDRCCE (Check if Device has any Filtering errors - Schedule Demand Reset) algorithm on the Validate status of the D3-ScheduleDemandResetResponse (Schedule Demand Response(Multispeak)) business object is used to check for errors related to filtering. The value of the “Opt Out Of Filtering” parameter on this algorithm must match the value of the parameter on the D3-SDRCCE algorithm. The parameters should both be set to either "false" (the default) or "true" (if filtering is to be disabled).

CIM Commands

For CIM-based on-demand read commands, filtering is enabled by default via the “Opt Out Of Filtering” parameter (set to "false" by default) on the D3-CCMPEVCIM (Create CIM Completion Event) algorithm on the Create Completion Events status of the D3-CIMMeterReadingsResponse (CIM Meter On Demand Read Response SOA Based) business object.

The D3-VALCEVCIM (Check if Device has any Filtering errors CIM Completion Event) algorithm on the Validate status of the D3-CIMMeterReadingsResponse (CIM Meter On Demand Read Response SOA Based) business object is used to check for errors related to filtering. The value of the “Opt Out Of Filtering” parameter on this algorithm must match the value of the parameter on the D3-CCMPEVCIM algorithm. The parameters should both be set to either "false" (the default) or "true" (if filtering is to be disabled).

Device Communication Base Package Business Objects

The Landis+Gyr Adapter base package includes the following communication business objects:

Business Object Name	Description	Protocol
D3-AddMeterToInventoryMultiSp	L+G Add Meter to Inventory (MultiSpeak)	MultiSpeak
D3-CIMGetLPData	CIM Meter On Demand Read (Interval)	CIM
D3-CIMMeterOnDemandRead	CIM Meter On Demand Read (Scalar)	CIM
D3-CIMMeterReadingResponse	CIM Meter On Demand Read Response	CIM
D3-CIMPing	CIM Ping	CIM
D3-CIMPingResponse	CIM Ping Response	CIM
D3-ConnectDisconStateChgNtf	Connect Disconnect State Changed Notification	MultiSpeak
D3-InitiateConnectDisconnect	Initiate Connect Disconnect	MultiSpeak
D3-InitiateMRByMtrNbr	Initiate Meter Read By Meter (MultiSpeak)	MultiSpeak
D3-MeterAddNotificationMultiSp	Meter Add Notification (MultiSpeak)	MultiSpeak
D3-MeterExNotificationMultiSp	L+G Meter Exchange Notification	MultiSpeak
D3-MeterRetireNotification	L+G Meter Retire Notification	MultiSpeak
D3-MtrRmvNotifMultiSpeak	Meter Remove Notification (MultiSpeak)	MultiSpeak
D3-ReadingChgNotification	Reading Changed Notification	MultiSpeak
D3-ScheduleDemandReset	Schedule Demand Reset (Multispeak)	MultiSpeak
D3-ScheduleDemandResetResponse	Schedule Demand Reset Response (Multispeak)	MultiSpeak

Landis+Gyr Event Data Mapping

The Landis+Gyr event file format maps as follows into the business object, D1-DeviceEventMappingLookup:

Landis+Gyr Flat File Field	Device Event Seeder BO Element	Comments
Transaction ID (from Header record)	External Source Identifier	This is the file name.
Device Identifier	External Device Identifier	
Event Name	External Event Name	
Event Creation Date/Time	Event Date/Time	
Device Type	External Device Type	This element has no real bearing on the device type within MDM/SGG. Its valid values include (although the element itself is free-form): Meter Collector Router
Service Location ID	External Service Location ID	
Communication Module Serial Number	External Communication Module Identifier	
Event Category ID	External Event Category	
Event Severity	External Event Severity	Valid values include (although the element itself is free-form):

Landis+Gyr Flat File Field	Device Event Seeder BO Element	Comments
		Alert Information
Status Value	External Status Value	This represents additional information that relates to the event itself.
Status Date/Time	External Status Date/Time	The date & time at which the additional information referenced above had occurred.

External System

You must create an External System for each external system to which Oracle Utilities Smart Grid Gateway will send messages. Each external system defines a set of outbound message types that will be sent to that system. Each external system outbound message type also specifies the following:

- The processing method used to send the message (Batch or Real-time)
- The corresponding message senders
- Batch Control (if Processing Method is set to Batch)
- Message XSL, W3C Schema, and Response XSL (as applicable)

Outbound Message Types

Acknowledgment and response messages are sent and received validating that commands have been transmitted. These notifications are based on the following outbound message types.

Outbound Message Type	Description
D3-ADDMTRINV	Add Meter to Inventory
D3-COMMS	Commission Device
D3-CONNECT	Connect Device
D3-DECOMMS	Decommission
D3-DEMRESET	Demand Reset
D3-DERDEV	Deregister Device
D3-DISCONN	Disconnect Device
D3-DVCSTSCHK	Device Status Check
D3-INITMRN	Initiate Meter Read by Meter Number
D3-INITMTR	Initiate Meter Read by Meter Number
D3-MTRADDNOT	Meter Add Notification Outbound Message Type
D3-MTRESX	Meter Exchange Notification OB MSG
D3-MTRRMV	Meter Remove Notification

Inbound / Outbound Service Configuration

The inbound/outbound message utility allows you to configure your system to receive information from and to send information to external applications using XML. The Oracle Utilities Smart Grid Gateway uses one inbound web service to map device events. This is the same inbound web service used by the D1 application.

Inbound Web Services

Inbound web services define the details of how messages are received from an external system, including the inbound communication business object (or business service or service script) to be invoked when the response message is received. As in the case of inbound communication business objects, the set of inbound web services you need to create is based on the types of messages the system is designed to send.

The Oracle Utilities Smart Grid Gateway adapter for Landis+Gyr includes the following inbound web services:

Inbound Web Service	Description
D1-BulkRequestHeader	Bulk Request Header
D1-BulkRequestUpdate	Bulk Request Update
D1-BulkResponse	Bulk Response
D1-DeviceEventSeeder	Used for upload of device events. The Device Event Seeder business object serves as a means of adding device events both from outside the application and from online. Its pre-processing algorithms determine the device event type - which in turn defines the device event BO that should be used to create the device event. If a device event type can't be determined, the device event is created using this BO. Such a device event can then be re-processed - and if successful, a new device event is created.
D1-InitialLoadIMD	Used for initial measurement upload. The IMDSeeder business object is used to determine the type of initial measurement business object to instantiate when receiving usage readings from a head-end system.
D3-CIMMeterReadingsResponse	CIM Meter On Demand Read Response Retrieve response from CIM On Demand Read command
D3-CIMPingResponse	CIM Ping Response Retrieve response from CIM Device Status Check command
D3-ConDisconStChgNotification	Initiate Connect Disconnect response. Retrieve response from the Initiate Connect Disconnect command.
D3-ReadingChangedNotification	Reading Changed Notification Notification that a Landis+Gyr device reading has changed.
D3-ScheduleDemandResetResponse	Scheduled Demand Reset Response Retrieve response from Demand Reset command

Message Senders

Message senders define the details of how messages are sent to an external system. As in the case of outbound communication business objects and outbound message types, the set of message senders you need to create is based on the types of messages the system is designed to accept.

The Oracle Utilities Smart Grid Gateway adapter for Landis+Gyr includes the following message senders:

Message Sender	Description
D3-Comms	Commission Device
D3-Connect	Connect Device
D3-Decomm	Decommission Device
D3-Decomms	Decommissioning Sender
D3-DemReset	Demand Reset
D3-DerDevice	Deregister Device
D3-Disconnec	Disconnect Device
D3-InitMTR	Initiate Meter Read by Meter Number Outbound Message

Message Sender	Description
D3-MTREXMS	Meter Exchange Notification Message Sender
D3-RTSender	Real Time Sender
D3-RTSnd	Real-time Sender (Landis+Gyr)
D3-SDemReset	SG Demand Reset

BPEL Processes

These processes are responsible for performing the conversion from Oracle Utilities format to MultiSpeak 3.0 format, invoking process callouts and invoking the remote endpoint to trigger the device events.

OnDemandRead Composite Process: Invokes the remote endpoint to trigger the on-demand read event. An asynchronous reply responds to the OUAF layer when the reading arrives.

ConnectDisconnect Composite Process: Invokes the remote endpoint to trigger the connect/disconnect event. An asynchronous reply responds to the OUAF layer when confirmation of the requested event arrives.

CommissionDecommission Composite Process: Invokes the remote endpoint to trigger the commission or decommission event. After the synchronous call completes, one of the following second business callout services is invoked to determine if the related “received” or “completed” callout should be executed:

- isExecutingCommissionReceivedCallout
- isExecutingCommissionCompletedCallout
- isExecutingDecommissionReceivedCallout
- isExecutingDecommissionCompletedCallout
- isExecutingAddMeterToInventoryReceivedCallout
- isExecutingAddMeterToInventoryCompletedCallout
- isExecutingMeterExchangeNotificationReceivedCallout
- isExecutingMeterExchangeNotificationCompletedCallout

CIMOnDemandRead Composite Process: Invokes the remote endpoint to trigger the CIM on-demand read event. An asynchronous reply responds to the OUAF layer when the reading arrives.

CIMDeviceStatusCheck Composite Process: This process is similar to CIM OndemandRead BPEL process. SGG uses the result of On Demand Read command to identify the status of the meter. If reads are successfully returned, then meter is running healthy otherwise it is considered as meter inactive/dead.

DemandReset Composite Process: Invokes the remote endpoint to trigger the demand reset event. An asynchronous reply responds to the OUAF layer when the reading arrives.

LGProcessCallout Composite: This business callout provides a point at which customers and implementers can incorporate custom business logic and transformations. This composite includes the WSDLs and processing logic for all of the MultiSpeak processes. The default implementation of each method is a direct return of the input.

Web Services

These web services are all defined in the Landis+Gyr head end system. The WSDLs were added to a Meta Data Storage (MDS) layer in OUAF and all references to the WSDL point to this MDS location.

Web Service	Related BPEL Process	Description
MR_CB	OnDemandRead	This web service is defined by the Landis+Gyr head end system’s implementation of MR_Server.
	CommissionDecommission	
	DemandReset	The WSDL defines the interface for requesting a meter reading from the head end system.

Web Service	Related BPEL Process	Description
		<p>The actual definition can be obtained from L&G or downloaded from multispeak.org. Build 3.0aa is appropriate if obtained from MultiSpeak.</p> <p>Default endpoint must be changed in configuration: http://demo.turtletech.com/Multispeak/webapi/MR_CB.asmx</p>
CD_CB	ConnectDisconnect	<p>This web service is defined by the Landis+Gyr implementation of CB_CD.</p> <p>The WSDL defines the interface for requesting a meter's connection or disconnection on the head end system.</p> <p>This web service defines the interface for reporting a connection or disconnection by the head end system.</p> <p>This web service is only invoked by the head end system; not OUAF.</p> <p>Only the CDStateChangedNotification web method is implemented in the composite.</p> <p>Default endpoint must be changed in configuration: http://demo.turtletech.com/Multispeak/webapi/CD_CB.asmx</p>
CIMService	CIMOnDemandRead CIMDeviceStatusCheck	<p>This web service is defined by the L+G head end's implementation of AMIRequest Server.</p> <p>The WSDL defines the interface for requesting a meter reading from the head end system.</p> <p>The actual definition should be obtained from L&G or downloaded from L&G SDK for CIM 2.0.</p>
LGProcessCallout	OnDemandRead ConnectDisconnect CommissionDecommission	<p>Imported from LGProcessCallout Composite</p> <p>Default endpoint must be changed in configuration: http://127.0.0.1:8000/soa-infra/services/default/LGProcessCallout/LGProcessCallout</p>

Landis+Gyr Command Center Web Services

The following table describes the Land+Gyr Command Center web services and operations used for the Oracle Utilities Smart Grid Gateway command messaging:

Smart Grid Gateway Command	AMI Adapter Business Objects	Landis+Gyr Web Services	Landis+Gyr Operations
Device Commissioning	D3-MeterAddNotificationMultiSp	MR	MeterAddNotification
Device Decommissioning	D3-MtrRmvNotifMultiSpeak	MR	MeterRemoveNotification
Remote Connect/ Remote Disconnect	D3-InitiateConnectDisconnect	CD	InitiateConnectDisconnect
On-Demand Read	D3-InitiateMRByMtrNbr	MR	InitiateMeterReadByMeterNumber
On-Demand Read (CIM)	D3-CIMGetLPData D3-CIMMeterOnDemandRead	CIMService	ScheduleDemandRead
Demand Reset	D3-ScheduleDemandReset	MR	CIM

Configuring a Landis+Gyr Head-End System

This section outlines the configuration required for the Oracle Utilities Smart Grid Gateway Adapter for Landis+Gyr to communicate with the Landis+Gyr Command Center software.

Inbound Web Services

Inbound web services define the details of how messages are received from an external system. This includes incoming usage and device events, as well as messages sent from the L+G Command Center in response to a command request.

The following inbound web services must be configured in your system. If these are not present in your configuration, add them. Refer to the Oracle Utilities Application Framework documentation for more information about creating inbound web services.

Inbound Web Service Name	Description
D1-BulkRequestHeader	Bulk Request Header
D1-BulkRequestUpdate	Bulk Request Update
D1-BulkResponse	Bulk Response
D1-DeviceEventSeeder	Device Event Seeder
D1-InitialLoadIMD	IMD Seeder
D1-PayloadErrorNotif	Payload Error Notification
D1-PayloadStatistics	Payload Statistics
D1-PayloadSummary	Payload Summary
D3-ConDisconStChgNotification	Initiate Connect Disconnect Response
D3-CIMMeterReadingsResponse*	CIM Meter On Demand Read Response
D3-CIMPingResponse	CIM Ping Response
D3-ReadingChangedNotification*	Reading Changed Notification
D3-ScheduleDemandResetResponse	Scheduled Demand Reset Response

*The Landis+Gyr adapter supports both MultiSpeak and CIM On Demand Read commands. You only need to configure the inbound service for the protocol you wish to use.

Note: The following apply to all of the above inbound web services:

Message Options

- **Trace:** No
- **Debug:** No
- **Active:** Yes

Operations

- **Operation Name:** Same as web service name
- **Schema Type:** Business Object
- **Schema Name:** Applicable business object code
- **Transaction Type:** Add

Message Senders

Message senders define the details of how messages are sent to an external system, such as messages containing device command requests.

The following message senders must be configured in your system. If these are not present in your configuration, add them. Refer to the Oracle Utilities Application Framework documentation for more information about creating message senders.

Message Sender	Description
D3-Comms	Commission Device
D3-Connect	Connect Device
D3-Decomm	Decommission Device
D3-InitMTR	Initiate Meter Read by Meter Number Outbound Message
D3-RTSender	Real Time Sender
D3-RTSnd	Real-time Sender (Landis+Gyr)
D3_CIMODR	L+G CIM On Demand Read
D3_CIMPING	L+G CIM Ping
D3_SCHDEMRES	L+G Schedule Demand Reset

Note: The following apply to all of the above message senders:

Main Tab:

- **Invocation Type:** Real-time
- **Message Class:** RTHTTPSND (Sender routes message via HTTP real-time)
- **MSG Encoding:** UTF-8 message encoding

Context Tabsysuser00:

- **HTTP Header:** SOAPAction: http://xmlns.oracle.com/ouaf/multispeak_3.0/<OPERATION>
- **HTTP Login User:** <USER_ID>
- **HTTP Login Password:** <PASSWORD>
- **HTTP Method:** POST
- **HTTP URL 1:** http://<EM_SERVER>:<EM_SERVER_PORT>/soa-infra/services/D3/<SERVICE>/<SERVICE>

where:

- <OPERATION>: the operation performed by the message sender (see Operation column in the table above)
- <USER_ID>: the user ID used to log into WebLogic Enterprise Manager
- <PASSWORD>: the password used to log into WebLogic Enterprise Manager
- <EM_SERVER_IP>: the machine name or IP address of server where the WebLogic Enterprise Manager is installed
- <EM_SERVER_PORT>: the port where the WebLogic Enterprise Manager is installed
- <SERVICE>: the service invoked by the message sender (see Service column in the table above)

Outbound Message Types

Outbound message types define specific types of messages sent to an external system, such as messages containing device command requests.

The following outbound message types must be configured in your system. If these are not present in your configuration, add them. Refer to the Oracle Utilities Application Framework documentation for more information about creating outbound message types.

Outbound Message Type	Description
D3-ADDMTRINV	Add Meter to Inventory
D3-COMMS	Commission Device
D3-CONNECT	Connect Device

Outbound Message Type	Description
D3-DECOMMS	Decommission
D3-DEMRESET	Demand Reset
D3-DERDEV	Deregister Device
D3-DISCONN	Disconnect Device
D3-DVCSTSCHK	Device Status Check
D3-INITMRN	Initiate Meter Read by Meter Number
D3-INITMTR	Initiate Meter Read by Meter Number
D3-MTRADDNOT	Meter Add Notification Outbound Message Type
D3-MTREX	Meter Exchange Notification OB MSG
D3-MTRRMV	Meter Remove Notification

Note: The following apply to all of the above outbound message types:

- **Business Object:** D1-OutboundMessage (Outbound Message)
- **Priority:** Priority 50

External System

External systems represent external applications with which the Smart Grid Gateway will exchange messages or data. In the case of the Smart Grid Gateway adapters, external systems represent the head-end systems with which the adapters communicate.

An external system that represents the L+G Command Center must be present in your system. If this is not present in your configuration, add it, along with the following Outbound Message Types. Refer to the Oracle Utilities Application Framework documentation for more information about creating external systems.

External System - Landis+Gyr:

- **External System:** LG
- **Description:** Landis+Gyr
- **Outbound Message Types:**

Outbound Message Type	Description	Message Sender
D3-ADDMTRINV	Add Meter to Inventory	Message sender associated with the Add Meter to Inventory Outbound Message Type
D3-COMMS	Commission Device	Message sender associated with the Commission Device Outbound Message Type
D3-CONNECT	Connect Device	Message sender associated with the Connect Device Outbound Message Type
D3-DECOMMS	Decommission	Message sender associated with the Decommission Device Outbound Message
D3-DEMRESET	Demand Reset	Message sender associated with the Demand Reset Outbound Message Type
D3-DERDEV	Deregister Device	Message sender associated with the Deregister Device Outbound Message Type
D3-DISCONN	Disconnect Device	Message sender associated with the Disconnect Device Outbound Message Type
D3-DVCSTSCHK	Device Status Check	Message sender associated with the Device Status Check Outbound Message Type
D3-INITMRN	Initiate Meter Read by Meter Number	Message sender associated with the Initiate Meter Read By Meter Number Outbound Message Type

Outbound Message Type	Description	Message Sender
D3-INITMTR	Initiate Meter Read by Meter Number	Message sender associated with the Initiate Meter Read By Meter Number Outbound Message Type
D3-MTRADDNOT	Meter Add Notification Outbound Message Type	Message sender associated with the Meter Add Notification Outbound Message Type
D3-MTREX	Meter Exchange Notification OB MSG	Message sender associated with the Meter Exchange Notification Outbound Message Type
D3-MTRRMV	Meter Remove Notification	Message sender associated with the Meter Remove Notification Outbound Message Type

Note: The following apply to the above outbound message types*:

- **Processing Method:** Real-time
- **Message XSL:** D3-Request.xsl (*use D3-DRRequest.xsl for the Demand Reset command)
- **Response XSL:** D3-Response.xsl (*use D3-DRResponse.xsl for the Demand Reset command)

Service Provider

Service providers represent external entities that serve various roles relative to the application, including head-end systems, billing systems to which the application sends bill determinant data, market participants in a deregulated environment, outage management systems that receive meter event data from the application, or other parties that require or provide information to the system. The head-end systems that collect and send measurement data and meter events to the application are defined as service providers.

A service provider that represents the L+G Command Center must be present in your system. If this is not present in your configuration, add it. Refer to the Oracle Utilities Service and Measurement Data Foundation documentation for more information about creating service providers.

Service Provider - Landis+Gyr:

- **Service Provider:** LG
- **Description:** Landis+Gyr
- **External Reference ID:** L+G
- **External System:** Landis+Gyr
- **Out Name/ID in Their System:**
- **AMI Device ID Type:** Internal Meter Number
- **AMI Measuring Component ID Type:** Channel ID

Processing Methods

Processing methods define the format or means by which a service provider receives and/or sends data from and/or to the application, including as bill determinants, usage data, or device events. Processing methods are also used to define how to create information internal to the application such as initial measurement data and device events. Processing methods can also be used to define how command requests are sent to a given head-end system.

The following types of processing methods must be configured for the L+G service provider. Refer to the Oracle Utilities Service and Measurement Data Foundation documentation for more information about configuring processing methods.

Initial Measurement Creation

Initial measurement creation processing methods define the business objects used to create initial measurements. The IMD Seeder inbound web service uses this processing method to determine which type of initial measurement business object to instantiate when receiving usage from a head-end system.

Device Event Mapping

Device event mapping processing methods define how head-end-specific device events are mapped to standard device event names. The Device Event Seeder inbound web service uses this processing method to determine which type of device event business object to instantiate when receiving device events from a head-end system.

UOM Translation

UOM mapping processing methods define how head-end-specific unit of measure (UOM) codes are mapped to standard UOM codes. This processing method is used to determine how to map head-end system UOM codes to standard UOM codes when receiving usage from the head-end system.

Commands

Command processing methods define how command requests are sent to a head-end system. More specifically, they define the type of outbound communication business object to create for each type of command, and the outbound message type to send to the head-end system.

The following types of command processing methods can be configured for the L+G service provider, based on the requirements of each implementation using the “How to Create OB COMM/Send OB Message” processing method business object (D1–HowToCreateActivityOBComm).

Command	Processing Role	Default Business Object	Default Outbound Message Type
Device Commission	Device Registration	D3-AddMeterToInventoryMultiSp	Add Meter to Inventory
Device Commission	Device Installation	D3-MeterExNotificationMultiSp	Meter Exchange Notification
Device Decommission	Device Removal	D3-MtrRmvNotifMultiSpeak	Decommission Meter Remove Notification
Device Deregistration	Device Deregistration	D3-MeterRetireNotification	Deregister Device
On-Demand Read (Scalar), Multispeak and CIM	On-Demand Read (Scalar)	MS: D3-InitiateMRByMtrNbr CIM: D3- CIMMeterOnDemandRead	MS: Initiate Meter Read by Meter Number CIM: CIM On Demand Read
On-Demand Read (Interval)	On-Demand Read (Interval)	D3-CIMGetLPData	CIM On Demand Read
Demand Reset	Demand Reset	D3-ScheduleDemandReset	Demand Reset
Device Status Check	Device Status Check	D3-CIMPing	Device Status Check
Remote Connect	Remote Connect	D3-InitiateConnectDisconnect	Connect Device
Remote Disconnect	Remote Disconnect	D3-InitiateConnectDisconnect	Disconnect Device

Configuring Endpoint URIs

Part of the configuration process is configuring your BPEL composites to work with your head-end system by defining the appropriate Endpoint URIs for each of the commands. The default approach to defining Endpoints URIs is redeployment or reinstallation of the BPEL composites. For example, by default, changing an adapter from using the test harness to a

production environment using the actual head-end system requires editing the appropriate installation menu options and redeploying the BPEL composites. The Endpoints URIs defined during installation and deployment for each adapter are listed in the **Smart Grid Gateway Installation and Configuration Worksheets** section of the *Oracle Utilities Smart Grid Gateway Installation Guide*.

You can also use an “Endpoint Override” Domain Value Map (DVM) to override Endpoint URIs defined during deployment and installation. This DVM allows defining specific keys that provide an alternate URL that will override the original installed value. Endpoint Override DVMs can be edited using the Oracle SOA Composer.

The Landis+Gyr endpoint override DVM (D3–EndpointOverrides.dvm) uses a specific set of keys, each used for one or more commands. The table below lists the DVM keys available for the Landis+Gyr adapter and the command used with each:

DVM Key	Commands
CIMService	On-Demand Read (Scalar) - CIM On-Demand Read (Interval) - CIM Device Status Check
CD_CB	Remote Connect Remote Disconnect
Metering	Device Commissioning (Registration)
MR_CB	Device Commissioning Device Decommissioning Device Commissioning (Installation) Device Deregistration On-Demand Read (Scalar) On-Demand Read (Interval)
LGProcessCallout	User Exit Functions

To define an override Endpoint URI for the Landis+Gyr adapter, use the following procedure:

1. Open the SOA Composer for your BPEL configuration.

The URL for the SOA Composer is <http://server:port/soa/composer>.

2. Select the D3–EndpointOverrides.dvm in the left panel.

- In Fusion Middleware v12.2.1, this is located under **Shared** in the **Deployment View**, or under **Domain Value Maps** in the **Types View**.
- In Fusion Middleware v12.2.2, this is located under **Metadata** in the **Deployment View**.

The DVM will open in the right panel. The **Description** field lists the available keys for the DVM (only the first key is shown, but you can scroll through the contents to view the list). The panel also displays a list of previously defined keys.

3. Click the **Create Session** button (above the left panel) to begin an editing session.
4. Click the **Add Domain Values** icon (“+”) to add a new key.

The **Add Domain Values** dialog opens.

5. Enter the appropriate values in the **Add Domain Values** dialog as follows:

- **key:** The DVM key for the Endpoint URI you wish to define (see the table above).
- **EndpointURI:** The override Endpoint URI.

6. Click **OK**.

The new DVM value will appear in the list of keys.

7. Click the **Save** icon to save the DVM values.

8. Click the **Publish** button to activate all the changes in the editing session.

Enter an optional note for the session in the **Publish Session** dialog.

Changes take effect immediately upon publishing the session.

Click **Discard** to discard your changes.

Click **Exit** to exit your current session. Note that your session will still be open if you exit. Use **Discard** to end your session without making changes.

Configuring Landis+Gyr Extendable Lookups

NOTE: This section applies to **both** middleware and native implementations of the Smart Grid Gateway Adapter for Landis+Gyr.

This section outlines some of the extendable lookups that must be configured for use with the Landis+Gyr adapter. Refer to the Oracle Utilities Application Framework documentation for more information about working with extendable lookups.

CIM Response Status Extendable Lookup

The CIM Response Status extendable lookup is used to map descriptions to response status codes received from the L+G Command Center. Each value defined for the CIM Response Status extendable lookup should include the following:

- **Response Status:** The CIM status code for the response status
- **Description:** A description of the response status
- **Status:** The status of the lookup value (can be Active or Inactive)

CIM Data Source Extendable Lookup

The CIM Data Source extendable lookup is used to map descriptions to data sources defined in the L+G Command Center. Each value defined for the CIM Data Source extendable lookup should include the following:

- **Data Source:** The CIM code for the data source
- **Description:** A description of the data source
- **Status :** The status of the lookup value (can be Active or Inactive)

Device Event Mapping

The Device Event Mapping extendable lookup is used to determine which type of device event business object to instantiate when receiving device events from the head-end system. Each value defined for the Device Event Mapping extendable lookup should include the following:

- **Head-End System Event Name:** The event name used by the head-end system
- **Description:** A description of the device event
- **Status:** The status of the lookup value (can be Active or Inactive)
- **Standard Event Name:** The standard event name for device events of this type, from the “Standard Event Name” extendable lookup.

UOM Code to Standard UOM Mapping

Usage received from a utility’s head-end system may use utility-specific unit of measures (UOMs). These custom UOMs must be mapped to standard UOM codes. The UOM Code to Standard UOM Mapping extendable lookup is used for this purpose. Each value defined for the UOM Code to Standard UOM Mapping extendable lookup should include the following:

- **Head-end UOM:** The unit of measure code used by the head-end system.
- **Unit of Measure:** The unit of measure defined in the system.
- **Description:** A description of the unit of measure code.

Interval Status Code to Condition Mapping

Interval usage received from the Landis+Gyr Command Center can include interval status codes that indicate the status or condition of the interval value. These interval status codes must be mapped to standard condition codes in the system. The Landis+Gyr Interval Status Code to Condition Mapping extendable lookup is used for this purpose. Each value defined for the Landis+Gyr Interval Status Code to Condition Mapping extendable lookup should include the following:

- **Interval Status:** The interval status code
- **Condition:** The condition code to which the interval status code is to be mapped, from the Measurement Condition extendable lookup.
- **Description:** A description of the interval status code.

Using the Landis+Gyr Test Harness

Oracle Utilities Smart Grid Gateway Adapter for Landis+Gyr (LG) includes a test harness that can be configured to simulate the Landis+Gyr Gridstream Command Center head-end system for testing the two-way commands. The test harness is Multispeak 3.0 standard compliant and includes a BPEL composite, web services for standard meter functions, and an XML file that can be used to contain information for one or more meters. See [Using Smart Grid Gateway Middleware Test Harnesses](#) for more information.

Landis+Gyr Interval Data Mapping

This section describes how data in Landis+Gyr import files is mapped to the XML document format created by OSB and sent to Oracle Utilities Smart Grid Gateway.

When Landis+Gyr data is processed, it is initially received in a tilda-separated file format, which is converted into a "plan" XML format before being converted into the "result" XML format which is sent to the IMD Seeder and/or Device Event Seeder inbound services.

Non-Interval Usage with Additional Fields

The following is a sample file of non-interval usage that contains additional fields.

```
ID~PremiseID~ESIID~Provisioned~Meter~kWh~DateTime~Peak~PeakDateTime~Dmd~TouA~TouB~TouC~TouD~TouE~Volts~PF~P
EMED01~SL002~~~96968280~34315.000~08042010120000AM~2.66~03122009063000AM~~34315.000~0.000~0.000~0.000~0.000~
EMED01~SL001~~~96968285~33693.000~08042010120000AM~2.62~03122009061500AM~~33693.000~0.000~0.000~0.000~0.000~
```

This data is mapped to the "plain" XML format.

XML 'Plain' XML Format

The "Plain" XML contain elements to hold the extra fields (highlighted in bold).

```
<?xml version="1.0" encoding="utf-8"?>
<xs:schema attributeFormDefault="unqualified" elementFormDefault="qualified"
  targetNamespace=" http://xmlns.oracle.com/LandisGyrUsage"
  xmlns:xs="http://www.w3.org/2001/XMLSchema">
  <xs:element name="MeterReads">
    <xs:complexType>
```

```

<xs:sequence>
  <xs:element name="MeterRead">
    <xs:complexType>
      <xs:sequence>
        <xs:element name="Origin"/>
        <xs:element name="ServProvExtRefId"/>
        <xs:element name="RecordType">
          <xs:simpleType>
            <xs:restriction base="xs:string">
              <xs:enumeration value="MEPMD01" />
              <xs:enumeration value="EMED01" />
            </xs:restriction>
          </xs:simpleType>
        </xs:element>
        <xs:element name="RecordVersion" minOccurs="0">
          <xs:simpleType>
            <xs:restriction base="xs:string">
              <xs:enumeration value="20080519" />
            </xs:restriction>
          </xs:simpleType>
        </xs:element>
        <xs:element name="TimeStamp" />
        <xs:element name="Premise" minOccurs="0" />
        <xs:element name="ESIID" minOccurs="0" />
        <xs:element name="Provisioned" minOccurs="0" />
        <xs:element name="MeterID" />
        <xs:element name="Purpose" minOccurs="0" />
        <xs:element name="Comodity" minOccurs="0" />
        <xs:element name="Units" minOccurs="0" />
        <xs:element name="CalcConst" minOccurs="0"/>
        <xs:element name="Interval" minOccurs="0"/>
        <xs:element name="Count" minOccurs="0"/>
        <xs:element name="FirstIntervalDateTime" />
        <xs:element name="Data">
          <xs:complexType>
            <xs:sequence>
              <xs:element name="Row" maxOccurs="unbounded" minOccurs="0">
                <xs:complexType>
                  <xs:attribute name="v" />
                  <xs:attribute name="s" />
                </xs:complexType>
              </xs:element>
            </xs:sequence>
          </xs:complexType>
        </xs:element>
        <xs:element name="kWh" minOccurs="0" />
        <xs:element name="Peak" minOccurs="0" />
        <xs:element name="PeakDateTime" minOccurs="0" />
        <xs:element name="Dmd" minOccurs="0" />
        <xs:element name="TouA" minOccurs="0" />
        <xs:element name="TouB" minOccurs="0" />
        <xs:element name="TouD" minOccurs="0" />
        <xs:element name="TouC" minOccurs="0" />
        <xs:element name="TouE" minOccurs="0" />
        <xs:element name="Volts" minOccurs="0" />
        <xs:element name="PF" minOccurs="0" />
        <xs:element name="ExtraFields" minOccurs="0">
          <xs:complexType>
            <xs:sequence>
              <xs:element name="ExtraField" maxOccurs="255" minOccurs="0">
                <xs:complexType>
                  <xs:sequence>
                    <xs:element name="FieldName" minOccurs="0"/>
                    <xs:element name="FieldValue" minOccurs="0"/>
                  </xs:sequence>
                </xs:complexType>
              </xs:element>
            </xs:sequence>
          </xs:complexType>
        </xs:element>
        <xs:element name="RawData" />
      </xs:sequence>
    </xs:complexType>
  </xs:element>
</xs:sequence>

```



```

    </xs:complexType>
  </xs:element>
</xs:sequence>
</xs:complexType>
</xs:element>
</xs:schema>

```

Non-Interval Usage to 'Plain' XML Mapping

The following table shows the mapping between fields in incoming non-interval data and child elements of MeterReads/MeterRead element in the "Plain" XML format:

L+G Interval Structure Field	"Plain" XML element
ID	RecordType
Premise ID	Premise
ESIID	ESIID
Provisioned	Provisioned
Meter	MeterID
kWh	kWh
Date/Time of initial Read	FirstIntervalDateTime
Peak	Peak
Peak Date/Time	PeakDateTime
Dmd	Dmd
TouA	TouA
TouB	TouB
TouC	TouC
TouD	TouD
TouE	TouE
Volts	Volts
PF	PF
<extraFieldName1>	ExtraFields/ExtraField/FieldName with value of <extraFieldName1> ExtraFields/ExtraField/FieldValue with value in <extraFieldName1>
<extraFieldName2>	ExtraFields/ExtraField/FieldName with value of <extraFieldName2> ExtraFields/ExtraField/FieldValue with value in <extraFieldName2>
<extraFieldName3>	ExtraFields/ExtraField/FieldName with value of <extraFieldName3> ExtraFields/ExtraField/FieldValue with value in <extraFieldName3>
<extraFieldNameN>	ExtraFields/ExtraField/FieldName with value of <extraFieldNameN> ExtraFields/ExtraField/FieldValue with value in <extraFieldNameN>
RawData	A record content from incoming file.

'Plain' XML to IMD Mapping

The following table outlines how data from the "plain" XML format is mapped to the InitialLoadIMD format when the Landis+Gyr record type is set to "MEPMD01" (interval usage).

"Plain" XML element	InitialLoadIMD element	Note
Record Type	N/A	
RecordVersion	N/A	
Premise ID	N/A	
ESIID	N/A	
Provisioned	N/A	

"Plain" XML element	InitialLoadIMD element	Note
Meter ID	dvclIdN	as is
Purpose	N/A	
Commodity	N/A	
Units	externalUOM	as is
CalcConst	mcm	as is
Interval	spi	Transform from DDHHMM to SPI
Count	N/A	
FirstIntervalDateTime	stDt	Convert to OUAF date/time format
Data	msrs	Value -> msrs/mL/q
Status -> msrs/mL/sts/stsL/st		
N/A	imdType	'D1IL
Origin	externalId	the origin attribute in "Plain" XML (incoming file name)
N/A	serviceProviderExternalId	L+G
RawData	rawData	Vendor-specific "raw" data

Non-Interval 'Plain' XML to IMD Mapping

The following table outlines how non-interval data in the "plain" XML format is mapped to the InitialLoadIMD format when the Landis+Gyr record type is set to "EMED01" (non-interval usage).

"Plain" XML Element	InitialLoadIMD element	Notes
RecordType	N/A	
Premise	N/A	
ESIID	N/A	
Provisioned	N/A	
MeterID	dvclIdN	as is
kWh	enQty	as is
	uom	KWH
TimeStamp	enDt	Convert to OUAF date/time format This should be mapped to enDt. Relevant only to non-interval data.
Peak	enQty	as is A separate IMD Seeder will be created with <uom> in IMD Seeder populated with KW
PeakDateTime	enDt	Convert to OUAF date/time format
Dmd	enQty	as is A separate IMD Seeder will be created with <uom> in IMD Seeder populated with KW and 'Dmd' in " <mcIdN>
TouA	enQty	as is A separate IMD Seeder will be created with <uom> in IMD Seeder populated with KWH and 'kWh Rate A' in " <mcIdN>
TouB	enQty	as is A separate IMD Seeder will be created with <uom> in IMD Seeder populated with KWH' and 'kWh Rate B' in " <mcIdN>
TouC	enQty	as is A separate IMD Seeder will be created with <uom> in IMD Seeder populated with KWH and 'kWh Rate C' in " <mcIdN>
TouD	enQty	as is

"Plain" XML Element	InitialLoadIMD element	Notes
		A separate IMD Seeder will be created with <uom> in IMD Seeder populated with KWH and 'kWh Rate D' in " <mcIdN>
TouE	enQty	as is A separate IMD Seeder will be created with <uom> in IMD Seeder populated with KWH and 'kWh Rate E' in " <mcIdN>
Volts	enQty	as is A separate IMD Seeder will be created with <uom> in IMD Seeder populated with Volts
PF	enQty	as is A separate IMD Seeder will be created with <uom> in IMD Seeder populated with PF
N/A	imdType	D1IL
Origin	externalId	the origin element in "Plain" XML (incoming file name)
N/A	serviceProviderExternalId	L+G This is a constant. There is no such field in incoming structure.
RawData	rawData	Vendor-specific "raw" data When the "populateRawIMD" parameters in the EnvironmentSettings.xq file is set to true.

Mapping Additional Fields

Measurement and device event files received from the Landis+Gyr head-end system can include additional fields containing data to be imported into Oracle Utilities Smart Grid Gateway. These additional fields must be mapped to elements within the XML document processed by OSB and sent to Smart Grid Gateway.

This mapping can be performed through use of a custom XQuery document, specified in the EnvironmentSettings.xq file via the "modifyResultXMLInput" parameter.

The following sample XQuery documents illustrate how additional fields can be mapped into the XML format sent to Smart Grid Gateway.

Sample XQuery — Initial Measurements

The following XQuery is an example that shows a transformation that passes in a root element with 3 children (the "result" XML, the "plain" XML, the environment settings) that returns a modified "result" XML. For testing purposes, it changes the original value in the <enQty> "result" element and replaces it with a value from the "plain" XML depending on an environment setting variable. The <serviceProviderExternalId> value was also replaced by a hard-coded value.

```

declare namespace lan = "http://xmlns.oracle.com/LandisGyrUsage";
declare namespace xf = "http://tempuri.org/D3/lgimd";
declare namespace soap = "http://schemas.xmlsoap.org/soap/envelope/";
declare function xf:modifyResultXML($modifyResultXMLInput as element(*)) as element(*){
<InitialLoadIMDList>
{
  for $InitLoadIMD in $ modifyResultXMLInput/InitialLoadIMDList/InitialLoadIMD
  return
    <InitialLoadIMD>
      <preVEE>
        <dvcIdN>{ data($InitLoadIMD/preVEE/dvcIdN) }</dvcIdN>
        <externalId>{ data($InitLoadIMD/preVEE/externalId) }</externalId>
        <uom>{ data($InitLoadIMD/preVEE/uom) }</uom>
        <mcIdN>{ data($InitLoadIMD/preVEE/mcIdN) }</mcIdN>
        <enDt>{ data($InitLoadIMD/preVEE/enDt) }</enDt>
        {
          if ($modifyResultXMLInput/EnvironmentSettings/test1="true")
          then <enQty>{ data($modifyResultXMLInput/lan:MeterReads/lan:MeterRead/lan:ExtraFields/
lan:ExtraField[lan:FieldName
= 'EF4']/lan:FieldValue) }</enQty>

```

```

    else <enQty>{ data($modifyResultXMLInput/lan:MeterReads/lan:MeterRead/lan:ExtraFields/
lan:ExtraField[lan:FieldName= 'EF2']/lan:FieldValue) }</enQty>
    }
    <imdType>{ data($InitLoadIMD/preVEE/imdType) }</imdType>
  </preVEE>
  <serviceProviderExternalId>NewSPID</serviceProviderExternalId>
</InitialLoadIMD>}</InitialLoadIMDList>
};
declare variable $modifyResultXMLInput as element(*)external;
xf:modifyResultXML($modifyResultXMLInput)

```

Sample XQuery — Device Events

The following XQuery is an example that shows a transformation that passes in a root element with 3 children (the "result" XML, the "plain" XML, and the environment settings) and returns a modified "result" XML. For testing purposes, it changes the original value in the <externalCommunicationModuleIdentifier> "result" element and replaces it with a value from the "plain" XML depending on an environment setting variable. The <externalServiceLocationId> value is also replaced by a hard-coded value.

```

declare namespace lan = "http://xmlns.oracle.com/LandisGyrEvent";
declare namespace xf = "http://tempuri.org/D3/event";
declare namespace soap = "http://schemas.xmlsoap.org/soap/envelope/";
declare function xf:modifyResultXML($modifyResultXMLInput as element(*)) as element(*){
  <DeviceEventSeeder>
    <externalSenderId>{data($modifyResultXMLInput/DeviceEventSeeder/externalSenderId) }</
externalSenderId>
    <deviceIdentifierNumber>{ data($modifyResultXMLInput/DeviceEventSeeder/
deviceIdentifierNumber) }</deviceIdentifierNumber>
    <externalEventName>{ data($modifyResultXMLInput/DeviceEventSeeder/externalEventName) }</
externalEventName>
    <eventDateTime>{ data($modifyResultXMLInput/DeviceEventSeeder/eventDateTime) }</
eventDateTime>
    <externalSourceIdentifier>{ data($modifyResultXMLInput/DeviceEventSeeder/
externalSourceIdentifier)
}</externalSourceIdentifier>
    <eventInformation>
      <externalEventCategory>{data($modifyResultXMLInput/DeviceEventSeeder/eventInformation/
externalEventCategory)
}</externalEventCategory>
      <externalEventSeverity>{data($modifyResultXMLInput/DeviceEventSeeder/eventInformation/
externalEventSeverity)
}</externalEventSeverity>
      <externalDeviceType>{data($modifyResultXMLInput/DeviceEventSeeder/eventInformation/
externalDeviceType)
}</externalDeviceType>
      <externalServiceLocationId>{1234 }</externalServiceLocationId>
      {
        if ($modifyResultXMLInput/EnvironmentSettings/testA="true")
        then <externalCommunicationModuleIdentifier>{ data($modifyResultXMLInput/lan:DeviceEvents/
lan:DeviceEvent/lan:DeviceType) }</externalCommunicationModuleIdentifier>
        else <externalCommunicationModuleIdentifier>{data($modifyResultXMLInput/lan:DeviceEvents/
lan:DeviceEvent/lan:CategoryId) }</externalCommunicationModuleIdentifier>
      }
    <externalStatusValue>{data($modifyResultXMLInput/DeviceEventSeeder/eventInformation/
externalStatusValue)
}</externalStatusValue>
    <externalStatusDateTime>{data($modifyResultXMLInput/DeviceEventSeeder/eventInformation/
externalStatusDateTime) }</externalStatusDateTime>
  </eventInformation>
</DeviceEventSeeder>
};
declare variable $modifyResultXMLInput as element(*) external;
xf:modifyResultXML($modifyResultXMLInput)

```

MV90 for Itron

The Oracle Utilities Smart Grid Gateway MV-90 Adapter for Itron uses Oracle Service Bus (OSB) to facilitate communication between Oracle Utilities Smart Grid Gateway and MV-90. The following functionality is included:

Measurement Data Loading - Data parsing and transformation from MV-90 binary format into the Oracle Utilities Service and Measurement Data Foundation unified format.

Measurement Data Processing - Configurable mapping for MV-90 status codes to Oracle Utilities Service and Measurement Data Foundation standard values, along with configurable device event creation based on MV-90 status codes.

The following table describes the attributes of the adapter:

Attribute	Details
Currently Supported Version	SGG supports the .mv9 binary, mainframe data format.
Protocol	Binary file format.
Market(s)	Worldwide, but largely USA.
Architecture	AMR

MV90 Adapter Processing

This section provides details concerning the OSB processing and OUAF objects supplied as part of the base package. This information illustrates how the base package objects were designed, and can serve as the basis for any customizations you create as part of your implementation.

Initial Measurement Data Loading

The initial measurement data load and subsequent device event processing use OSB to poll for, parse, and transform the head-payloads into the Oracle Utilities Smart Grid Gateway service format. Payloads contain measurements in a head-end specific format OSB then places each service call into a JMS queue within the Oracle Utilities applications. The JMS client consumes the entries and invokes the respective services in parallel then a service creates initial measurements with data in a common format with head-end-specific processing as needed.

Initial Measurements

The usage data exported from the AMI head-end system as a file in MV-90 format is loaded into Oracle Utilities as Initial measurement data. The following OSB projects, delivered in the base product, help manage the usage processing:

1. **SGG-D5-USAGE-BASE** contains components responsible for the actual processing of incoming data. It should not be modified during configuration. This project can be upgraded without affecting the customization and environment settings added to the SGG-D5-USAGE-CM project.
2. **SGG-D5-USAGE-CM** allows for customization and simplifies future upgrades.

The runtime configuration settings for the SGG-D5-USAGE-CM project are stored in the xquery file EnvironmentSettings.xq. You can use this file to adjust initial measurement data processing. For example, if you want to load raw data you would specify “true” for the content of the populateRawIMD element.

The following table describes the elements included in the EnvironmentSettings.xq file:

Element	Description	Valid Values
populateRawIMD	Determines if the initial measurement data is populated as raw data.	true false
callPreProcessing	Determines if the preprocessing proxy service is called.	true false

Element	Description	Valid Values
callPostProcessing	Determines if the postprocessing proxy service is called.	true false
destinationRootElementInterval	Holds the name of inbound web service for the interval IMD seeder.	
publishServices/service	Specifies the name of the business service within the OSB project used to publish data for external systems (such as Oracle DataRaker).	
filterUsage	Determines if usage should be filtered.	true false
usePhysicalChannel	Optional value. Determines whether the physical channel ID is passed to the IMD seeder to create the measuring component identifier number. If this is set to false, the MV90 LOGCHAN field is used.	true false (default)
fieldForDvclidN	Optional value. Specifies which field is used as the value for the device ID.	DC_RECID DC_CUSTID DC_METERID (default)
MV90ScalarChannelSuffix	Optional value. Holds a suffix value to be added to the measuring component identifier number when a scalar IMD is created for register reads. Default value is "_S"	
processMV90ScalarData	Optional value. Determines if register reads are processed.	true false (default)

Publishing Initial Measurement Data

The SGG adapter can be configured to publish initial measurement data for use in Oracle DataRaker or other external systems. This functionality is supported through a combination of OSB components and BPEL composites.

Enabling Initial Measurement Data Publishing

Publishing data is enabled by referencing a publisher business service in the publishServices/service element in the EnvironmentSettings.xq file as follows:

```
<publishServices>
  <service>[publisherBusinessService]</service>
</publishServices>
```

The following components provided with the SGG-D5-USAGE-CM OSB project are used in publishing measurement data to Oracle DataRaker:

- The **DataRakerBusinessService** business service is used to send data to a pre-configured JMS queue (defined as an Endpoint URI), from which the data will be published. This is the business service that should be specified in the EnvironmentSettings.xq file.
- The **DataRakerServiceAccount** service account is used to define and maintain the user name and password needed to access the JMS queue defined in the **DataRakerBusinessService** business service.

Configuring Initial Measurement Publishing Output

The SGGDRIntegration BPEL composite handles publishing the data to Oracle DataRaker or other systems. Initial measurement data is published in the “native” initial measurement data format (the format of the initial measurement seeder business object). This format includes normalized unit of measure and condition codes. See the *Oracle Utilities Smart Grid Gateway Adapter Development Kit Administrative User Guide* for more details about this format.

NOTE: Initial measurement data published through this feature is published prior to validation, estimation, and editing (VEE) processing. In addition, filtering *cannot* be applied to data published through this feature.

The following parameters can be used to configure details of how the data is provided to Oracle DataRaker, including the directory where files are posted for Oracle DataRaker to consume, number of records per file, polling frequency, etc. These

parameters are defined during installation. See the *Oracle Utilities Smart Grid Gateway Installation Guide* for more details about defining values for these parameters.

Parameter	Description	Default Value
SGG_DR_INT_QUEUE	JNDI name of queue to publish SGG payloads. This is the JMS queue defined in the DataRakerBusinessService business service. This should NOT be changed.	DataRakerQueue
SOA_DR_PUBLISH_SIZE	The number of records (SGG payloads) to accumulate in a published file.	100
SOA_DR_FILE_SIZE	The maximum file size for the accumulated (SGG payloads) file in kilobytes.	524288
SOA_DR_ELAPSED_TIME	The period of time in second which, when exceeded, causes a new outgoing file to be created.	600
SOA_DR_POLLING_FREQ	The polling frequency in seconds of the staging directory for new files.	60
SOA_DR_STAGING_DIR	Mount point/directory for the staging directory for accumulated SGG payload files. This is used internally and should NOT be changed.	/spl/sploutput/staging
SOA_DR_INTEGRATION_DIR	Mount point/directory from which Oracle DataRaker will consume the converted XML files.	/spl/sploutput/int

Filtering Usage

The SGG adapter can be configured to filter initial measurement data passed into SGG and the Oracle Utilities Meter Data Management application. Filtering data is enabled by setting the <filterUsage> element in the EnvironmentSettings.xq file to “true” as follows:

```
<filterUsage>true</filterUsage>
```

When filtering is enabled, only measurements whose <externalUOM> matches one of the values defined in the **MV90 UOM Code to Standard UOM Mapping** extendable lookup (D5-UOMtoStdUOMCodeMapLookup) are passed into the system for processing.

Processing Large Input Files

In some environments, the OSB project may begin processing a large input file before it has been completely copied to the input directory. To prevent this, configure the MinimumAge property in the “InboundProxyService” proxy service for the project. The MinimumAge property specifies the minimum age of files to be retrieved, based on the last modified time stamp. This enables large files to be completely copied to the input directory before they are retrieved for processing.

Prioritized Initial Measurement Processing

The SGG adapter prioritizes processing of initial measurements created from smart meter commands and/or completion events by setting the Execution Method flag in these types of initial measurements to “Real Time” (D1RT). In addition, initial measurements received with the Execution Method flag set to “Real Time” will be processed in real time rather than via batch processing. See **Initial Measurement Data Prioritization** in the *Oracle Utilities Meter Data Management / Smart Grid Gateway Business User Guide* for more information.

Initial Measurement Data Load with Register Reads

In the MV90 format, measurement data can include interval data as well as register reads that can be used to create scalar measurements. For information on configuring the adapter for loading scalar data based on register reads, see [Override Processing Methods for Scalar Initial Measurement Data](#).

Base Package Business Objects

The MV-90 Adapter for Itron base package includes the following initial measurement business objects:

Business Object Name	Description
D5-InitialLoadIMDInterval	MV-90 Initial Load IMD
D5-InitialLoadIMDScalar	MV90 - Initial Load IMD - Scalar

Configuring an MV90 Head-End System

This section outlines the configuration required for the Oracle Utilities Smart Grid Gateway MV-90 Adapter for Itron to receive usage from an MV-90 system.

Inbound Web Services

Inbound web services define the details of how messages are received from an external system, including incoming usage.

The following inbound web services must be configured in your system. If these are not present in your configuration, add them. Refer to the Oracle Utilities Application Framework documentation for more information about creating inbound web services.

Inbound Web Service Name	Description
D1-InitialLoadIMD	IMD Seeder
D1-PayloadErrorNotif	Payload Error Notification
D1-PayloadStatistics	Payload Statistics
D1-PayloadSummary	Payload Summary

Note: The following apply to all of the above inbound web services:

Message Options

- **Trace:** No
- **Debug:** No
- **Active:** Yes

Operations

- **Operation Name:** Same as web service name
- **Schema Type:** Business Object
- **Schema Name:** Applicable business object code
- **Transaction Type:** Add

External System

External systems represent external applications with which the Smart Grid Gateway will exchange messages or data. In the case of the Smart Grid Gateway adapters, external systems represent the head-end systems with which the adapters communicate.

An external system that represents the MV-90 system must be present in your system. If this is not present in your configuration, add it. Refer to the Oracle Utilities Application Framework documentation for more information about creating external systems.

External System - MV-90:

External System: MV90

Description: MV90 - Mainframe File Format

Service Provider

Service providers represent external entities that serve various roles relative to the application, including head-end systems, billing systems to which the application sends bill determinant data, market participants in a deregulated environment, outage management systems that receive meter event data from the application, or other parties that require or provide information to the system. The head-end systems that collect and send measurement data and meter events to the application are defined as service providers.

A service provider that represents the MV-90 system must be present in your system. If this is not present in your configuration, add it. Refer to the Oracle Utilities Meter Data Management / Smart Grid Gateway documentation for more information about creating service providers.

Service Provider - MV-90:

- **Service Provider:** MV90
- **Description:** Head-End System for MV90
- **External Reference ID:** MV90
- **External System:** MV90 - Mainframe File Format
- **Out Name/ID in Their System:** MV90
- **AMI Device ID Type:** Serial Number
- **AMI Measuring Component ID Type:**

Processing Methods

Processing methods define the format or means by which a service provider receives and/or sends data from and/or to the application, including as bill determinants, usage data, or device events. Processing methods are also used to define how to create information internal to the application such as initial measurement data and device events. Processing methods can also be used to define how command requests are sent to a given head-end system.

The following types of processing methods must be configured for the MV90 service provider. Refer to the Oracle Utilities Meter Data Management / Smart Grid Gateway documentation for more information about configuring processing methods.

Initial Measurement Creation

Initial measurement creation processing methods define the business objects used to create initial measurements. The IMD Seeder inbound web service uses this processing method to determine which type of initial measurement business object to instantiate when receiving usage from a head-end system.

Override Processing Methods for Scalar Initial Measurement Data

In the MV-90 format, meter read start and stop values can represent either a calculated read based on the interval data that is included in the MV90 data, or a register read that has been logged using a separate channel. When the values represent a register read the application can create a second file for the scalar initial measurements. The creation of a scalar initial measurement file is triggered by the Register Type flag, DC_REGTYPE, in the MV-90 data and the processMV90ScalarData variable in the EnvironmentSettings.xq file. The following register read values are valid for the DC_REGTYPE field:

Value	Description
V	Visual energy readings
D	Visual demand and energy readings
E	Encoder register readings (energy only).
B	Both encoder and visual energy readings.
C	Calculate stop meter readings from the encoder base reading

In order to configure your adapter to create scalar initial measurements based on register reads, first define new measuring component types and register measuring components. Then use the new measuring component types to specify override processing methods on the Initial Measurement Creation processing method for your service provider.

Measuring Component Types for Scalar Reads: To create initial measurement data for register reads, first create new measuring component types to represent the registers. These will be used to create measuring components for scalar reads.

Example Measuring Component Type

- **Measuring Component Type:** MV90_SCALAR_REG
- **Description:** MV90 Scalar Register
- **Measuring Component Business Object:** Register
- **Measurement Business Object:** Measurement
- **Service Type:** Electric Service
- **Allow Negative Consumption:** Allowed
- **Consumptive/Subtractive:** Subtractive
- **Read Method:** Automatic Read

Other attributes such as Value Identifiers, VEE Groups, and so on, should be defined based on requirements

Register Measuring Components for Scalar Reads: Use the new measuring component types to create measuring components for the scalar measurements created by the register read process. You must create a corresponding register measuring component for each interval channel for which you will receive scalar reads. The channel number for the registers must be based on the channel numbers of the corresponding interval channels, plus the suffix defined in the “MV90ScalarChannelSuffix” environment setting. The default value for this setting is “_S”. These registers must also be added to the device configuration used by the interval channels (in other words, both measuring components - interval and scalar - must be on the same device). The following table shows examples of these values for the measuring components:

Device Type/Serial Number	MV-90 Interval Channel Number	MV-90 Scalar Register Channel Number
MV90 Electric/00001	1	1_S
MV90 Electric/00002	1	1_S
MV90 Electric/00003	1	1_S

Override Processing Methods for MV-90 Service Provider: Add an override processing method to the Initial Measurement Creation processing method for the MV90 service provider for each register measuring component type. The business object for each override processing method should be “D5-InitialLoadIMDScalar”. The following tables shows examples of the override processing methods:

Measuring Component Type	Business Object
MV90 Scalar Register	D5-InitialLoadIMDScalar
Measuring Component Type 2	D5-InitialLoadIMDScalar

Device Event Mapping

Device event mapping processing methods define how head-end-specific device events are mapped to standard device event names. The Device Event Seeder inbound web service uses this processing method to determine which type of device event business object to instantiate when receiving device events from a head-end system.

UOM Translation

UOM translation processing methods define how head-end-specific unit of measure (UOM) codes are mapped to standard UOM codes. This processing method is used to determine how to map MV90 UOM codes to standard UOM codes when receiving usage from the MV-90 system.

Configuring MV90 Extendable Lookups

NOTE: This section applies to **both** middleware and native implementations of the Smart Grid Gateway MV90 Adapter for Itron.

This section outlines some of the extendable lookups that must be configured for use with the MV-90 Adapter for Itron. Refer to the Oracle Utilities Application Framework documentation for more information about working with extendable lookups.

Interval Status Code to Event Mapping

The MV-90 Adapter for Itron does not accept device events from an MV-90 system, but can create device events based on specific interval status codes in an incoming usage reading. The MV-90 Interval Status Code to Event Mapping extendable lookup is used to determine which type of device event business object to instantiate when creating device events based on interval status codes received with usage from the MV-90 system.

Each value defined for the Interval Status Code to Event Mapping extendable lookup should include the following:

- **MV90 Interval Status:** The interval status code used by the MV-90 system
- **Description:** A description of the MV-90 interval status code
- **Event Duration Mode:** The duration type for the event. Can be either “Individual” or “Continuous” (used for events with a duration, such as an outage).
- **Device Event Type:** The Device Event Type for the device event created for this interval status code. For status codes with an Event Duration Mode or “Continuous” this is the start event, or the first of the paired events created for this status code.
- **End Event Type:** The Device Event Type for the “end” device event created for this interval status code. For status codes with an Event Duration Mode or “Continuous” this is the start event, or the last of the paired events created for this status code.

Example: The MV-90 “Low Voltage” status code could be configured to create a “Low Voltage” device event as follows:

- **MV90 Interval Status:** <MV-90 interval status code for low voltage>
- **Description:** Low Voltage detected for meter
- **Event Duration Mode:** Individual
- **Device Event Type:** Low Voltage
- **End Event Type:** N/A

Example: The MV-90 “Power Outage” status code could be configured to create a “Last Gasp” device event, and a “Power Restoration” event as follows:

- **MV90 Interval Status:** <MV-90 interval status code for outage>
- **Description:** Outage
- **Event Duration Mode:** Continuous
- **Device Event Type:** Last Gasp
- **End Event Type:** Power Restoration

UOM Code to Standard UOM Code Mapping

Usage received from a utility’s head-end system may use utility-specific unit of measures (UOMs). These custom UOMs must be mapped to standard UOM codes. The UOM Code to Standard UOM Mapping extendable lookup is used for this purpose. Each value defined for the UOM Code to Standard UOM Mapping extendable lookup should include the following:

- **Head-end UOM:** The unit of measure code used by the head-end system.
- **Unit of Measure:** The unit of measure defined in the system.
- **Description:** A description of the unit of measure code.

Other Extendable Lookups

Business Object Name	Description
D5 - ChanelStatusCodeLookup	MV-90 Channel Status Code Lookup
D5-IntStsCdToCndMapPrLookup	Condition Mapping with Priority

Networked Energy Services

The Oracle Utilities Smart Grid Gateway Adapter for Networked Energy Services (NES) supports two-way communication with the NES server. Communications include measurement data and device event loading, and command messaging in support of commissioning, connect, disconnect, decommissioning, and on-demand read. The adapter uses Oracle Service Bus (OSB) and Oracle Business Process Execution Language Process Manager (BPEL PM) to facilitate communication between Oracle Utilities Smart Grid Gateway and NES. The following table describes the attributes of the adapter:

Attribute	Details
Currently Supported Version	Networked Energy Services 5.3
Protocol	Proprietary (NES specific)
Market(s)	Worldwide
Architecture	ANSI and IEC, PLC

Networked Energy Services Adapter Processing

This section provides details concerning the OSB processing, BPEL Processes, and Oracle Utilities Application Framework (OUAF) objects that are supplied as part of the base package. This information illustrates how the base package objects were designed, and can serve as the basis for any customizations you create as part of your implementation.

Initial Measurement Data and Device Event Loading

The initial measurement data load and device event processing use OSB to poll for, parse, and transform the head-payloads into the Oracle Utilities Smart Grid Gateway (SGG) service format. Payloads contain measurements and meter events in some head-end specific format. OSB then places each service call into a Java Message Service (JMS) queue within the Oracle Utilities applications. The JMS client consumes the entries and invokes the respective services in parallel. A service then creates initial measurements with data in a common format with head-end-specific processing as needed. A second service creates device events with data in a common format.

Initial Measurements

Usage data is exported from the head-end system as a file in NES format and is loaded into Oracle Utilities as initial measurement data. The following OSB projects, delivered in the base product, help manage the usage processing:

1. **SGG-D4-USAGE-BASE** contains components responsible for the actual processing of incoming data. This should not be modified during configuration.
2. **SGG-D4-USAGE-CM** allows you to segment your customizations so that future upgrades of base functionality implemented in SGG-D4-USAGE-BASE do not affecting the customization and environment settings.

The runtime configuration settings for the SGG-D4-USAGE-CM project are stored in the xquery file EnvironmentSettings.xq. You can use this file to adjust initial measurement data processing. For example, if you want to load raw data you would specify “true” for the content of the populateRawIMD element.

The following table describes the elements included in the EnvironmentSettings.xq file:

Element	Description	Valid Values
populateRaw	Determines if the initial measurement data is populated as raw data.	true false
callPreProcessing	Determines if the preprocessing proxy service is called.	true false
callPostProcessing	Determines if the postprocessing proxy service is called.	true false
destinationRootElementInterval	Holds the name of inbound web service for the interval IMD seeder.	
destinationRootElementScalar	Holds the name of inbound web service for the scalar IMD seeder. In most cases it is the same as destinationRootElementInterval.	
publishServices/service	Specifies the name of the business service within the OSB project used to publish data for external systems (such as Oracle DataRaker).	
filterUsage	Determines if usage should be filtered.	true false

Publishing Initial Measurement Data

The SGG adapter can be configured to publish initial measurement data for use in Oracle DataRaker or other external systems. This functionality is supported through a combination of OSB components and BPEL composites.

Enabling Initial Measurement Data Publishing

Publishing data is enabled by referencing a publisher business service in the publishServices/service element in the EnvironmentSettings.xq file as follows:

```
<publishServices>  
  <service>[publisherBusinessService]</service>  
</publishServices>
```

The following components provided with the SGG-D4-USAGE-CM OSB project are used in publishing measurement data to Oracle DataRaker:

- The **DataRakerBusinessService** business service is used to send data to a pre-configured JMS queue (defined as an Endpoint URI), from which the data will be published. This is the business service that should be specified in the EnvironmentSettings.xq file.
- The **DataRakerServiceAccount** service account is used to define and maintain the user name and password needed to access the JMS queue defined in the **DataRakerBusinessService** business service.

Configuring Initial Measurement Publishing Output

The SGGDRIntegration BPEL composite handles publishing the data to Oracle DataRaker or other systems. Initial measurement data is published in the “native” initial measurement data format (the format of the initial measurement seeder business object). This format includes normalized unit of measure and condition codes. See the *Oracle Utilities Smart Grid Gateway Adapter Development Kit Administrative User Guide* for more details about this format.

NOTE: Initial measurement data published through this feature is published prior to validation, estimation, and editing (VEE) processing. In addition, filtering *cannot* be applied to data published through this feature.

The following parameters can be used to configure details of how the data is provided to Oracle DataRaker, including the directory where files are posted for Oracle DataRaker to consume, number of records per file, polling frequency, etc. These parameters are defined during installation. See the *Oracle Utilities Smart Grid Gateway Installation Guide* for more details about defining values for these parameters.

Parameter	Description	Default Value
SGG_DR_INT_QUEUE	JNDI name of queue to publish SGG payloads. This is the JMS queue defined in the DataRakerBusinessService business service. This should NOT be changed.	DataRakerQueue
SOA_DR_PUBLISH_SIZE	The number of records (SGG payloads) to accumulate in a published file.	100
SOA_DR_FILE_SIZE	The maximum file size for the accumulated (SGG payloads) file in kilobytes.	524288
SOA_DR_ELAPSED_TIME	The period of time in second which, when exceeded, causes a new outgoing file to be created.	600
SOA_DR_POLLING_FREQ	The polling frequency in seconds of the staging directory for new files.	60
SOA_DR_STAGING_DIR	Mount point/directory for the staging directory for accumulated SGG payload files. This is used internally and should NOT be changed.	/spl/sploutput/staging
SOA_DR_INTEGRATION_DIR	Mount point/directory from which Oracle DataRaker will consume the converted XML files.	/spl/sploutput/int

Filtering Initial Measurement Data

The SGG adapter can be configured to filter initial measurement data passed into SGG and the Oracle Utilities Meter Data Management application. Filtering data is enabled by setting the <filterUsage> element in the EnvironmentSettings.xq file to “true” as follows:

```
<filterUsage>true</filterUsage>
```

When filtering is enabled, only measurements whose <externalUOM> matches one of the values defined in the **NES UOMCode Mapping Extendable Lookup** (D4-HeadendUOMLookup) are passed into the system for processing.

Processing Large Input Files

In some environments, the OSB project may begin processing a large input file before it has been completely copied to the input directory. To prevent this, configure the MinimumAge property in the “InboundProxyService” proxy service for the project. The MinimumAge property specifies the minimum age of files to be retrieved, based on the last modified time stamp. This enables large files to be completely copied to the input directory before they are retrieved for processing.

Prioritized Initial Measurement Processing

The SGG adapter prioritizes processing of initial measurements created from smart meter commands and/or completion events by setting the Execution Method flag in these types of initial measurements to “Real Time” (D1RT). In addition, initial measurements received with the Execution Method flag set to “Real Time” will be processed in real time rather than via batch processing. See **Initial Measurement Data Prioritization** in the *Oracle Utilities Meter Data Management / Smart Grid Gateway Business User Guide* for more information.

Device Events

The device event data exported from the head-end system as a file in NES format is loaded into Oracle Utilities as a Device Event. One of your configuration tasks is to customize the device events processing.

The required functionality is delivered in the base product as two OSB projects:

1. **SGG-D4-EVENT-BASE** contains components responsible for the actual processing of incoming data. This should not be modified during configuration.
2. **SGG-D4-EVENT-CM** allows you to segment your customizations so that future upgrades of base functionality implemented in SGG-D4-EVENT-BASE do not affecting the customization and environment settings.

The runtime configuration settings for the SGG-D4-EVENT-CM project are stored in the EnvironmentSettings.xq XQuery file. You can use this file to adjust device event data processing. For example, if you want to load raw data you would specify “true” for the content of the populateRaw element.

The following table describes the elements included in the EnvironmentSettings.xq file:

Element	Description	Valid Values
populateRaw	Determines if the device event data is populated as raw data.	true false
callPreProcessing	Determines if the preprocessing proxy service is called.	true false
callPostProcessing	Determines if the postprocessing proxy service is called.	true false
destinationRootElement	Holds the name of inbound web service for the device event seeder.	
serviceProviderExternalId	The External ID of the NES service provider.	
publishServices/service	Specifies the name of the business service within the OSB project used to publish data for external systems (such as Oracle DataRaker).	
filterEvents	Determines if events should be filtered.	true

Element	Description	Valid Values
		false

Publishing Events

The NES adapter can be configured to publish device events for use in Oracle DataRaker or other external systems. This functionality is supported through a combination of OSB components and BPEL composites.

Enabling Device Event Publishing

Publishing data is enabled by referencing a publisher business service in the publishServices/service element in the EnvironmentSettings.xq file as follows:

```
<publishServices>
  <service>[publisherBusinessService]</service>
</publishServices>
```

The following components provided with the SGG-D4-EVENT-CM OSB project are used in publishing device events data to Oracle DataRaker:

- The **DataRakerBusinessService** business service is used to send data to a pre-configured JMS queue (defined as an Endpoint URI), from which the data will be published. This is the business service that should be specified in the EnvironmentSettings.xq file.
- The **DataRakerServiceAccount** service account is used to define and maintain the user name and password needed to access the JMS queue defined in the **DataRakerBusinessService** business service.

Configuring Device Event Publishing Output

The SGGDRIntegration BPEL composite handles publishing the data to Oracle DataRaker or other systems. Device event data is published in the “native” device event data format (the format of the device event seeder business object). This format includes normalized device event codes. See the *Oracle Utilities Smart Grid Gateway Adapter Development Kit Administrative User Guide* for more details about this format.

NOTE: In addition, filtering can NOT be applied to device events published via this feature.

The following parameters can be used to configure details of how the data is provided to Oracle DataRaker, including the directory where files are posted for Oracle DataRaker to consume, number of records per file, polling frequency, etc. These parameters are defined during installation. See the *Oracle Utilities Smart Grid Gateway Installation Guide* for more details about defining values for these parameters.

Parameter	Description	Default Value
SGG_DR_INT_QUEUE	JNDI name of queue to publish SGG payloads. This is the JMS queue defined in the DataRakerBusinessService business service. This should NOT be changed.	DataRakerQueue
SOA_DR_PUBLISH_SIZE	The number of records (SGG payloads) to accumulate in a published file.	100
SOA_DR_FILE_SIZE	The maximum file size for the accumulated (SGG payloads) file in kilobytes.	524288
SOA_DR_ELAPSED_TIME	The period of time in second which, when exceeded, causes a new outgoing file to be created.	600
SOA_DR_POLLING_FREQ	The polling frequency in seconds of the staging directory for new files.	60

Parameter	Description	Default Value
SOA_DR_STAGING_DIR	Mount point/directory for the staging directory for accumulated SGG payload files. This is used internally and should NOT be changed.	/spl/sploutput/staging
SOA_DR_INTEGRATION_DIR	Mount point/directory from which Oracle DataRaker will consume the converted XML files.	/spl/sploutput/int

Filtering Events

The SGG adapter can be configured to filter initial measurement data passed into SGG and the Oracle Utilities Meter Data Management application. Filtering data is enabled by setting the <filterUsage> element in the EnvironmentSettings.xq file to “true” as follows:

```
<filterEvents>true</filterEvents>
```

When filtering is enabled, only device events whose <externalEventName> matches one of the values defined in the **NES Device Event Mapping** extendable lookup (D4-DeviceEventMappingLookup) are passed into the system for processing.

Prioritized Device Event Processing

The SGG adapter prioritizes processing of device events created from smart meter commands and/or completion events by setting the Execution Method flag in these types of device events to “Real Time” (DIRT). In addition, device events received with the Execution Method flag set to “Real Time” will be processed in real time rather than via batch processing. See **Device Event Prioritization** in the *Oracle Utilities Meter Data Management / Smart Grid Gateway Business User Guide* for more information.

Configuring Payload Processing Notifications

By default, Payload Statistics, Payload Error Notification, and Payload Summary notification activities are sent to the Notification Queue within Oracle Service Bus. Smart Grid Gateway adapters can be configured to restrict sending these activities by defining optional JCA transport dynamic properties in the appropriate OSB project. The following optional JCA transport dynamic properties can be used to control if these notification activities are sent:

- **SGG_SEND_STATISTICS**: Controls sending Payload Statistic activities (true: send, false: do not send)
- **SGG_SEND_ERROR**: Controls sending Payload Error Notification activities (true: send, false: do not send)
- **SGG_SEND_SUMMARY**: Controls sending Payload Summary activities (true: send, false: do not send)

When these properties are set to false, the corresponding payload notification will not be sent to the JMS Queue. Note these properties are not populated by default, and default to true if omitted.

To create these properties:

1. Navigate to the SGG-D4-EVENT-CM project in the Oracle Service Bus Console.
2. Expand the **Proxy Services** folder.
3. Select the **InboundProxyService** proxy service (not the Pipeline or WSDL).
4. Click **Create** to create a new session.
5. Select **Transport Details**.
6. Click the plus sign in the **Dyanmic EndPoint Properties** section. An empty row will appear.
7. Enter the property you wish to define in the **Property** column.
8. Enter "false" in the **value** column.

9. Repeat steps 6-8 for each property you wish to define.

10. Click **Activate** to save and activate your changes.

NOTE: These properties are only used if the SGG_EXT_ID_PATTERN is not present or the regular expression captures nothing. The SGG_EXT_ID_PATTERN will override these properties when the regular expression captures group data.

Base Package Business Objects

The NES adapter base package includes the following device, initial measurement, and device event business objects:

Business Object Name	Description
D4-InitialLoadIMDInterval	NES Initial Load IMD Interval
D4-InitialLoadIMDScalar	NES Initial Load MD Scalar
D4-SmartMeter	Smart Meter - NES
D4-EventExtractScheduler	NES Event Extract Scheduler
D4-PayloadExtractScheduler	Payload Extract Scheduler
D4-UsageExtractScheduler	NES Usage Extract Scheduler

Device Communication

The basic communication for all business processing is essentially the same. A communication request is sent from the Oracle Utilities application to the head-end system. This request would be for a connect/disconnect, commission/decommission, measurement data, an on-demand read, or another type of request that the head-end system supports. The designated BPEL process transforms the request from Oracle Utilities format to MultiSpeak format and invokes the related web service from the head-end system. The head-end system then returns a reply, and the BPEL process transforms the reply message back to the appropriate format so that Oracle Utilities can receive the response.

Communication Flows

The table below lists the communications created for each NES command:

Command	Outbound Communication	Inbound Communication	Completion Event
Remote Connect	Retrieve Meter Information	Read Load Status Notification	Create IMD
	Read Load Status	Read Billing Data On-Demand Notification	Connect Device
	Read Billing Data On-Demand	Connect Load Notification	
	Connect Load		
Remote Disconnect	Disconnect Load	Disconnect Load Notification	Create IMD
	Read Billing Data On-Demand	Read Billing Data On-Demand Notification	Disconnect Device
Device Commissioning	Add Meter Request	Set ATM Configuration Notification	Device Commissioning
	Set ATM Configuration		
Device Decommissioning	Decommission Meter Request	Decommission Meter Notification	Device Decommissioning
On-Demand Read (Scalar)	Read Billing Data On-Demand	Read Billing Data On-Demand Notification	Create IMD
On-Demand Read (Interval)	Read Load Profile On Demand	Read Load Profile On-Demand Notification	Create IMD

Commissioning and Decommissioning Communications

Commissioning a previously decommissioned NES device requires a different process than commissioning a new device.

When you commission a device for the first time, a commissioning command is sent to BPEL to create the meter in NES using the DeviceManager.CreateMeter command. If Automatic Topology Management is selected then the DeviceManager.SetATMConfiguration command is also sent.

When you decommission a device, BPEL sends the DeviceManager.Move command to NES for the device. In NES you need to confirm that the device has been moved to a non-DC tree. You then need to manually delete the device from the non-DC tree. To permanently decommission the device you must delete it by using the DeviceManager.Delete command from the NES interface.

To recommission a device that has been previously decommissioned, you need to log into NES and manually move the meter from the non-DC tree to the DC tree that it belonged to previously. This will not be possible if the device has been deleted from within NES.

Device Communication Base Package Business Objects

The NES base package includes the following communication business objects:

Meter Commissioning

Business Object	Description
D4-AddMeterRequest	Add Meter Request
D4-GenericAMIDeviceIdentifier	Generic AMI Device Identifier
D4-RetrieveMeterIdentifier	Retrieve Meter Identifier
D4-RetrieveMeterInfo	Retrieve Meter Information
D4-SetATMConfigNotification	Set ATM Configuration Notification
D4-SetATMConfiguration	Set ATM Configuration

Meter Decommissioning

Business Object	Description
D4-DecommMeterNotification	Decommission Meter Notification
D4-DecommMeterRequest	Decommission Meter Request

On-Demand Read

Business Object	Description
D4-ReadBillingData	Read Billing Data On-Demand
D4-ReadBillingDataNtf	Read Billing Data On-Demand Notification
D4-ReadLoadProfile	Read Load Profile On Demand
D4-ReadLoadProfileNtf	Read Load Profile On-Demand Notification
D4-ReadLoadStatus	Read Load Status
D4-ReadLoadStatusNtf	Read Load Status Notification

Remote Connect

Business Object	Description
D4-ConnectLoad	Connect Load

Remove Disconnect

Business Object	Description
D4-DisconnectLoad	Disconnect Load
D4-DisconnectLoadNtf	Disconnect Load Notification

External System

You must create an External System for each external system to which Oracle Utilities Smart Grid Gateway will send messages. Each external system defines a set of outbound message types that will be sent to that system. Each external system outbound message type also specifies the following:

- The processing method used to send the message (Batch or Real-time)
- The corresponding message senders
- Batch Control (if Processing Method is set to Batch)
- Message XSL, W3C Schema, and Response XSL (as applicable)

Outbound Message Types

Acknowledgment and response messages are sent and received validating that commands have been transmitted.

Outbound Message Type	Description
D4-ADDMETREQ	Add Meter Request
D4-CONLOAD	Connect Load
D4-DECMETREQ	Decommission Meter Request
D4-DISCONLD	Disconnect Load
D4-HNLBATEVT	NES - Handle Batch Event
D4-HNLBATUSG	NES - Handle Batch Usage
D4-RDLOADST	Read Load Status
D4-READLP	Read Load Profile
D4-READOUT	Read Billing Data
D4-RETMETID	Retrieve Meter Identifier
D4-RETRIEVE	Retrieve Meter Information
D4-SETATMCFG	Set ATM Configuration

Inbound / Outbound Service Configuration

The inbound/outbound message utility allows you to configure your system to receive information from and to send information to external applications using XML. The Oracle Utilities Smart Grid Gateway uses one inbound web service to map device events. This is the same inbound web service used by the D1 application.

Inbound Web Services

Inbound web services define the details of how messages are received from an external system, including the inbound communication business object (or business service or service script) to be invoked when the response message is received. As in the case of inbound communication business objects, the set of inbound web services you need to create is based on the types of messages the system is designed to send.

The Oracle Utilities Smart Grid Gateway Adapter for NES uses the following inbound web services to import usage and device events:

Inbound Web Service	Description
D1-DeviceEventSeeder	<p>Used for upload of device events.</p> <p>The Device Event Seeder business object serves as a means of adding device events both from outside the application and from online. Its pre-processing algorithms determine the device event type - which in turn defines the device event BO that should be used to create the device event.</p> <p>If a device event type can't be determined, the device event is created using this BO. Such a device event can then be re-processed - and if successful, a new device event is created.</p>
D1-InitialLoadIMD	<p>Used for initial measurement upload.</p> <p>The IMDSeeder business object is used to determine the type of initial measurement business object to instantiate when receiving usage readings from a head-end system.</p>

The Oracle Utilities Smart Grid Gateway Adapter for NES includes the following inbound web services for receiving communications from the NES:

Inbound Web Service Name	Description
D4-ConnectLoadNotification	Connect Load Notification
D4-DecommMeterNotificationXAI	Meter Decommission Notification
D4-DisconnectLoadNotification	Disconnect Load Notification
D4-ReadBDNotificationXAI	Read Billing Data On-Demand Notification
D4-ReadingATMConfigNotification	Get Response Initiate Read By Meter Number
D4-ReadLoadStatusNotification	Read Load Status Notification
D4-ReadLPNotificationXAI	Read Load Profile On-Demand Notification

Message Senders

Message senders define the details of how messages are sent to an external system. As in the case of outbound communication business objects and outbound message types, the set of message senders you need to create is based on the types of messages the system is designed to accept.

The Oracle Utilities Smart Grid Gateway Adapter for NES includes the following message senders:

Message Sender	Description
D4-ADDMETREQ	Add Meter Request
D4-CONLOAD	Connect Load
D4-DECOMMIS	Device Decommissioning
D4-DISCONLD	Disconnect Load
D4-HNLBATEVT	NES Handle Batch Event
D4-HNLBATUSG	NES Handle Batch Usage
D4-RDLOADST	Read Load status
D4-READBILLD	NES On-Demand Read (Scalar)(2)
D4-READLP	Read Load Profile

Message Sender	Description
D4-RETMETID	Retrieve Meter Identifier
D4-RETRIEVE	Retrieve Meter Information
D4-ReadBill	Read Billing Data
D4-SETATMCFG	Set ATM Configuration

BPEL Processes and Web Services

These processes are responsible for performing the conversion from Oracle Utilities format to NES format, invoking process callouts and invoking the remote endpoint to trigger the device events.

All web services receive XML from an incoming service then transform the call to a format which is recognized by the NES system.

CreateMeter: Receives the incoming XML from the message sender service, transforms it to the NES API parameters node, passes it to the DeviceManager.Create NES API web service method then collects XML from CreateMeter to be returned to Oracle Utilities Smart Grid Gateway.

Messages

CreateMeter RequestMessage: Contains the parameters which are formatted from Oracle Utilities Smart Grid Gateway to match the incoming XML for the NES API DeviceManager.Create method.

CreateMeter ResponseMessage: Contains the Device ID that is used when the DeviceManager.Create method validates the security key and the XML parameters successfully.

Related Processes

Meter Commissioning

ConnectLoadRemoteConnect

Receives the incoming XML from the D4-CONLOAD (Connect Load) message sender in Oracle Utilities Smart Grid Gateway and transforms to NES format.

GrabBatchEvents

Retrieves the un-processed events from the event repository; transforms each batch to replace GUID identifiers with a readable form, and finally prepares a new file for OSB before deleting the batch of events. The scheduled call to this service can contain the preferred dates to query for or can accept the default which is the previous day usage.

Messages

GrabBatchEventsSoapIn

GrabBatchEventsSoapOut

GrabBatchUsage

Retrieves the un-processed usage from the usage repository; transforms each batch to replace GUID identifiers with a readable form, and finally prepares a new file for OSB before deleting the batch of usage. The scheduled call to this service can contain the preferred dates to query for or can accept the default which is the previous day usage.

Messages

GrabBatchUsageSoapIn

GrabBatchUsageSoapOut

Related Processes

Connection

Event Management

Usage Processing

MeterDecommissioning

Receives the incoming XML from the message senderOutbound service and transforms to NES API parameters node to be passed to the DeviceManager.Move NES API web service method. The process then collects the return XML to be returned to Oracle Utilities Smart Grid Gateway.

Messages

MeterDecommissioningRequestMessage: This message is the input for the Move method. The method contains the parameters conveniently formatted from Oracle Utilities Smart Grid Gateway to match the incoming XML for the NES API DeviceManager.Move method.

MeterDecommissioningResponseMessage: This message contains status stating that the DeviceManager.Create method validated the security key and the XML parameters are accepted successfully. If the status is SUCCEEDED, it also contains Tracking ID for the call, Device ID and StatusType ID.

Related Processes

Meter Decommissioning

PerformCommand

This web service facilitates most of the communication between Oracle Utilities Smart Grid Gateway and the NES system. If your implementation requires functionality that was not delivered as part of the base package this web service will play an integral part in managing those customizations.

PerformCommand executes a command which generates the events that advance the Oracle Utilities Smart Grid Gateway lifecycle then returns the output string to the caller. The output might be a tracking ID or information about a device.

Messages

PerformCommandSoapIn: The sXmlParameters input is prepared from within Oracle Utilities Smart Grid Gateway to execute primarily a group of five commands, these are Read Load Status, On-Demand Read, Connect Load, Disconnect Load and Set ATM Configuration.

PerformCommandSoapOut:

The return from PerformCommand is the xml from the DeviceManager.PerformCommand for Read Load Status, On-Demand Read, Connect Load, Disconnect Load and Set ATM Configuration.

ReceivePanoramixEvents

This web service is actually never called by the implementation, but rather it is called by NES and is needed when configuring the NES server.

ReceivePanoramixEvents obtains the APIKey from the NES authentication service, then, with the event definition ID from the parameter list for this service, switches to the branch for the event definition to begin any specific processing. For example, an on-demand read completion event means that the BPEL PM process needs to retrieve the usage using the RESULTID found in the event xml. All events and usage to be passed on to Oracle Utilities Smart Grid Gateway must first be transformed to replace the GUID with a readable form items. This involves using the BPEL PM DVM lookup functionality.

Messages

ReceivePanoramixEventsSoapIn

ReceivePanoramixEventsSoapOut

Related Processes

Event Management

PrePerformCommandCallout / PostPerformCommandCallout

These web services are hooks designed to allow customization of messages just prior and just after sending them to the NES server. Your implementation may wish to modify the data for special purposes. This is the one of the only places where modification of BPEL PM code is allowed.

ReceivedPanoramixEventsCallout

This web service is a hook designed to allow customization of messages just prior and just after sending them to the NES server. Your implementation may wish to modify the data for special purposes. This is one of the only places where modification of BPEL PM code is allowed.

ReadBillingDataOnDemand

This web service method, initiate a call to NES system with formatted inbound xml parameter. First it transforms the Parameters received from the calling system in to NES system recognizable format. Then it invokes a call to the NES system's Device Manager Service. When the call is invoked the system receives the return XML from DeviceManager stating the status of the command execution and, if succeeded, the tracking ID of this call.

Messages

ReadBillingDataOnDemandRequestMessage: Contains the input parameter for DeviceManager Perform Command to read billing data OnDemand. It formats parameters from the calling system to match incoming XML for the NES DeviceManager.PerformCommand method.

ReadBillingDataOnDemandResponseMessage: Transforms the response xml from NES system format to Oracle Utilities Smart Grid Gateway format.

Related Processes

On Demand Reads

ReadLoadProfileOnDemand

This web service method, initiate a call to NES system's Device Manager Service with formatted inbound xml parameter. First it transforms the Parameters received from the calling system in to NES system recognizable format. Then it invokes a call to the NES system thru Device Manager Service. After invoking the call, the system receives the response message from DeviceManager stating the status of the command execution and, if succeeded, the tracking ID of this call.

Messages

ReadLoadProfileOnDemandRequestMessage: This message is for interval on demand read request to the NES system. Transforms the incoming XML from Oracle Utilities Smart Grid Gateway to NES recognizable format.

ReadLoadProfileOnDemandResponseMessage: Transforms the response xml for ReadLoadProfileOnDemandRequest from NES system format to Oracle Utilities Smart Grid Gateway format.

Related Processes

On Demand Reads

ReadLoadStatusRemoteConnect

Receives the incoming XML from the D4-RDLOADST (Read Load Status) message sender in Oracle Utilities Smart Grid Gateway and transforms to NES format.

RemoteDisconnect

Receives the incoming XML from the D4-DISCONLD (Disconnect Load) message sender in Oracle Utilities Smart Grid Gateway and transforms to NES format.

RetrieveMeterInfo

Initiates a call to the Request Management Service with formatted inbound xml parameters. First it transforms the Parameters received from the calling system in to NES system recognizable format. Then it invokes a call to the NES system thru Request Management Service and retrieves a response with Meter Information.

Messages

RetrieveMeterInformationRequestMessage: Contains the input parameter for DeviceManager Perform Command to retrieve meter information. It also formats parameters from the calling system to match incoming XML for the NES DeviceManager.PerformCommand method.

RetrieveMeterInformationResponseMessage: Transforms the response xml from NES system format to Oracle Utilities Smart Grid Gateway format.

Related Processes

Remote Disconnect

Remote Connect

RetrieveMeterIdentifier

Receives a call from Oracle Utilities Smart Grid Gateway for RetrieveMeterIdentifier process and invokes the RetrieveByParameter method in the NES system's DeviceManager service.

Converts incoming Oracle Utilities Smart Grid Gateway formatted input to sXmlParameters in NES format then invokes RetrieveMeterIdentifier.

Messages

RetrieveMeterIdentifierRequestMessage: Transforms the xml received from the calling system to match incoming XML for the NES API DeviceManager.RetrieveByParameter method. This method requires the Type of ID and the associated ID as input.

RetrieveMeterIdentifierResponseMessage: When the XML is synchronously returned from the head-end system for the RetrieveByParameter call, the DEVICEID node is only included in the APIPAYLOAD if the status of the call is Succeeded.

Related Processes

Meter Commissioning

SetATMConfiguration

This web service method is specific to set Automated Topology Management (ATM) configuration command which assigns the Meter to the Data Concentrator.

Converts incoming Oracle Utilities Smart Grid Gateway formatted input to sXmlParameters in NES format then invokes the DeviceManager PerformCommand. A connection should establish to begin the NES command processing.

Messages

SetATMConfigurationRequestMessage: This message is the input for the SetATMConfiguration method. The method contains the parameters conveniently formatted from Oracle Utilities Smart Grid Gateway to match the incoming XML for the NES API DeviceManager.PerformCommand method where the COMMANDID is Constants.DeviceCommands.SET_ATM_CONFIGURATION

SetATMConfigurationResponseMessage: when the XML is synchronously returned from the head-end system for the PerformCommand call, the COMMAND node is only included in the APIPAYLOAD if the status of the call is Succeeded.

Related Processes

Meter Commissioning

NES Web Services

The following table describes NES web services and operations used for the Oracle Utilities Smart Grid Gateway command messaging:

Smart Grid Gateway Commands	AMI Adapter Business Objects	NES Web Services	NES Operations
Device Commissioning	D4-AddMeterRequest	DeviceManager	Create
	D4-RetrieveMeterIdentifier		RetrieveByParameter
	D4-SetATMConfiguration		PerformCommand: SET_ATM_CONFIGURATION
Device Decommissioning	D4-DecommMeterRequest	DeviceManager	PerformCommand: MOVE_DEVICE_ADD
Remote Connect	D4-ConnectLoad	DeviceManager	Retrieve
	D4-ReadLoadStatus		PerformCommand:
	D4-RetrieveMeterInfo		CONNECT_LOAD READ_LOAD_STATUS

Smart Grid Gateway Commands	AMI Adapter Business Objects	NES Web Services	NES Operations
Remote Disconnect	D4-DisconnectLoad	DeviceManager	PerformCommand: DISCONNECT_LOAD
On-Demand Read	D4-ReadBillingData	DeviceManager	PerformCommand Command ID: READ_BILLING_DATA_ON_ DEMAND (Scalar) READ_LOAD_PROFILE_ON_ DEMAND (Interval)

Configuring a Networked Energy Services Head-End System

This section outlines the configuration required for the Oracle Utilities Smart Grid Gateway NES Adapter to communicate with the NES software.

Inbound Web Services

Inbound web services define the details of how messages are received from an external system. This includes incoming usage and device events, as well as messages sent from the NES in response to a command request.

The following inbound web services must be configured in your system. If these are not present in your configuration, add them. Refer to the Oracle Utilities Application Framework documentation for more information about creating inbound web services.

Inbound Web Service Name	Description
D1-BulkRequestHeader	Bulk Request Header
D1-BulkRequestUpdate	Bulk Request Update
D1-BulkResponse	Bulk Response
D1-DeviceEventSeeder	Device Event Seeder
D1-InitialLoadIMD	IMD Seeder
D1-PayloadErrorNotif	Payload Error Notification
D1-PayloadStatistics	Payload Statistics
D1-PayloadSummary	Payload Summary
D4-ConnectLoadNotification	Connect Load Notification
D4-DecommMeterNotificationXAI	Meter Decommission Notification
D4-DisconnectLoadNotification	Disconnect Load Notification
D4-ReadBDNotificationXAI	Read Billing Data On-Demand Notification
D4-ReadingATMConfigNotification	Get Response Initiate Meter Read By Meter Number
D4-ReadLoadStatusNotification	Read Load Status Notification
D4-ReadLPNotificationXAI	Read Load Profile On-Demand Notification

Note: The following apply to all of the above inbound web services:

Message Options

- **Trace:** No
- **Debug:** No
- **Active:** Yes

Operations

- **Operation Name:** Same as web service name
- **Schema Type:** Business Object
- **Schema Name:** Applicable business object code
- **Transaction Type:** Add

Message Senders

Message senders define the details of how messages are sent to an external system, such as messages containing device command requests.

The following message senders must be configured in your system. If these are not present in your configuration, add them. Refer to the Oracle Utilities Application Framework documentation for more information about creating message senders.

Message Sender	Description
D4-ADDMETREQ	Add Meter Request
D4-CONLOAD	Connect Load
D4-DECOMMIS	Device Decommissioning
D4-DISCONLD	Disconnect Load
D4-HNLBATEVT	NES Handle Batch Event
D4-HNLBATUSG	NES Handle Batch Usage
D4-RDLOADST	Read Load status
D4-READBILLD	NES On-Demand Read (Scalar)(2)
D4-READLP	Read Load Profile
D4-RETMETID	Retrieve Meter Identifier
D4-RETRIEVE	Retrieve Meter Information
D4-ReadBill	Read Billing Data
D4-SETATMCFG	Set ATM Configuration

Note: The following apply to all of the above message senders:

Main Tab:

- **Invocation Type:** Real-time
- **Message Class:** RTHTTPSNDR (Sender routes message via HTTP real-time)
- **MSG Encoding:** UTF-8 message encoding

Context Tab:

- **HTTP Header:** SOAPAction: http://xmlns.oracle.com/ouaf/echelon/<OPERATION>
- **HTTP Login User:** <USER_ID>
- **HTTP Login Password:** <PASSWORD>
- **HTTP Method:** POST
- **HTTP URL 1:** http://<EM_SERVER>:<EM_SERVER_PORT>/soa-infra/services/D4/<SERVICE>/<SERVICE>

where:

- <OPERATION>: the operation performed by the message sender (see Operation column in the table above)
- <USER_ID>: the user ID used to log into WebLogic Enterprise Manager
- <PASSWORD>: the password used to log into WebLogic Enterprise Manager
- <EM_SERVER>: the machine name or IP address of server where the WebLogic Enterprise Manager is installed
- <EM_SERVER_PORT>: the port where the WebLogic Enterprise Manager is installed

- **<SERVICE>**: the service invoked by the message sender (see Service column in the table above)

Outbound Message Types

Outbound message types define specific types of messages sent to an external system, such as messages containing device command requests.

The following outbound message types must be configured in your system. If these are not present in your configuration, add them. Refer to the Oracle Utilities Application Framework documentation for more information about creating outbound message types.

Outbound Message Type	Description
D4-ADDMETREQ	Add Meter Request
D4-CONLOAD	Connect Load
D4-DECMETREQ	Decommission Meter Request
D4-DISCONLD	Disconnect Load
D4-HNLBATEVT	NES - Handle Batch Event
D4-HNLBATUSG	NES - Handle Batch Usage
D4-RDLOADST	Read Load Status
D4-READLP	Read Load Profile
D4-READOUT	Read Billing Data
D4-RETMETID	Retrieve Meter Identifier
D4-RETRIEVE	Retrieve Meter Information
D4-SETATMCFG	Set ATM Configuration

Note: The following apply to all of the above outbound message types:

- **Business Object:** D1-OutboundMessage (Outbound Message)
- **Priority:** Priority 50

External System

External systems represent external applications with which the Smart Grid Gateway will exchange messages or data. In the case of the Smart Grid Gateway adapters, external systems represent the head-end systems with which the adapters communicate.

An external system that represents the NES must be present in your system. If this is not present in your configuration, add it, along with the following Outbound Message Types. Refer to the Oracle Utilities Application Framework documentation for more information about creating external systems.

External System - NES:

- **External System:** NES
- **Description:** NES
- **Outbound Message Types::**

Outbound Message Type	Message Sender
D4-ADDMETREQ	D4-ADDMETREQ
D4-CONLOAD	D4-CONLOAD
D4-DECMETREQ	D4-DECOMMIS
D4-DISCONLD	D4-DISCONLD
D4-HNLBATEVT	D4-HNLBATEVT
D4-HNLBATUSG	D4-HNLBATUSG

Outbound Message Type	Message Sender
D4-RDLOADST	D4-RDLOADST
D4-READLP	D4-READBILLD
D4-READOUT	D4-READLP
D4-RETMETID	D4-RETMETID
D4-RETRIEVE	D4-RETRIEVE
D4-SETATMCFG	D4-SETATMCFG

Note: The following apply to all of the above outbound message types:

- **Processing Method:** Real-time
- **Message XSL:** D4-Request.xml
- **Response XSL:** D4-Response.xml

Service Provider

Service providers represent external entities that serve various roles relative to the application, including head-end systems, billing systems to which the application sends bill determinant data, market participants in a deregulated environment, outage management systems that receive meter event data from the application, or other parties that require or provide information to the system. The head-end systems that collect and send measurement data and meter events to the application are defined as service providers.

A service provider that represents the NES must be present in your system. If this is not present in your configuration, add it. Refer to the Oracle Utilities Service and Measurement Data Foundation documentation for more information about creating service providers.

Service Provider - NES

- **Service Provider:** NES
- **Description:** NES
- **External Reference ID:** NES
- **External System:** D4-NES
- **Out Name/ID in Their System:**
- **AMI Device ID Type:** Internal Meter Number
- **AMI Measuring Component ID Type:** Channel ID

Processing Methods

Processing methods define the format or means by which a service provider receives and/or sends data from and/or to the application, including as bill determinants, usage data, or device events. Processing methods are also used to define how to create information internal to the application such as initial measurement data and device events. Processing methods can also be used to define how command requests are sent to a given head-end system.

The following types of processing methods must be configured for the NES service provider. Refer to the Oracle Utilities Service and Measurement Data Foundation documentation for more information about configuring processing methods.

Initial Measurement Creation

Initial measurement creation processing methods define the business objects used to create initial measurements. The IMD Seeder inbound web service uses this processing method to determine which type of initial measurement business object to instantiate when receiving usage from a head-end system.

Device Event Mapping

Device event mapping processing methods define how head-end-specific device events are mapped to standard device event names. The Device Event Seeder inbound web service uses this processing method to determine which type of device event business object to instantiate when receiving device events from a head-end system.

UOM Translation

UOM mapping processing methods define how head-end-specific unit of measure (UOM) codes are mapped to standard UOM codes. This processing method is used to determine how to map head-end system UOM codes to standard UOM codes when receiving usage from the head-end system.

Commands

Command processing methods define how command requests are sent to a head-end system. More specifically, they define the type of outbound communication business object to create for each type of command, and the outbound message type to send to the head-end system.

The following types of command processing methods can be configured for the NES service provider, based on the requirements of each implementation using the “How to Create OB COMM/Send OB Message” processing method business object (D1–HowToCreateActivityOBComm).

Command	Processing Role	Default Business Object	Default Outbound Message Type
Device Commission	Device Registration	D4-SetATMConfiguration	Set ATM Configuration
Device Decommission	Device Removal	D4-DecommMeterRequest	Decommission Meter Request
On-Demand Read (Scalar)	On-Demand Read (Scalar)	D4-ReadBillingData	Read Billing Data
On-Demand Read (Interval)	On-Demand Read (Interval)	D4-ReadLoadProfile	Read Load Profile
Device Status Check	Device Status Check	D4-ReadLoadStatus	Read Load Status
Remote Connect	Remote Connect	D4-ConnectLoad	Connect Load
Remote Disconnect	Remote Disconnect	D4-DisconnectLoad	Disconnect Load

Other Processing Methods

This section outlines details for other processing methods used by the NES adapter.

Processing Role	Default Business Object	Default Outbound Message Type
NES Add Meter Request	D4-AddMeterRequest	Commission
NES Retrieve Meter Identifier	D4-RetrieveMeterIdentifier	Commission Retrieve Meter Identifier
NES Retrieve Meter Information	D4-RetrieveMeterInfo	Retrieve Meter Info

Configuring Endpoint URIs

Part of the configuration process is configuring your BPEL composites to work with your head-end system by defining the appropriate Endpoint URIs for each of the commands. The default approach to defining Endpoints URIs is redeployment or reinstallation of the BPEL composites. For example, by default, changing an adapter from using the test harness to a production environment using the actual head-end system requires editing the appropriate installation menu options and redeploying the BPEL composites. The Endpoints URIs defined during installation and deployment for each adapter are

listed in the **Smart Grid Gateway Installation and Configuration Worksheets** section of the *Oracle Utilities Smart Grid Gateway Installation Guide*.

You can also use an “Endpoint Override” Domain Value Map (DVM) to override Endpoint URIs defined during deployment and installation. This DVM allows defining specific keys that provide an alternate URL that will override the original installed value. Endpoint Override DVMs can be edited using the Oracle SOA Composer.

The NES endpoint override DVM (D4–EndpointOverrides.dvm) uses a specific set of keys, each used for one or more commands. The table below lists the DVM keys available for the NES adapter and the command used with each:

DVM Key	Commands
DeviceManager	Remote Connect Remote Disconnect Device Commissioning Device Decommissioning On-Demand Read (Scalar) On-Demand Read (Interval)
EventManager	On-Demand Read (Scalar) On-Demand Read (Interval)
GatewayManager	Remote Connect Remote Disconnect Device Commissioning Device Decommissioning On-Demand Read (Scalar) On-Demand Read (Interval)
SettingManager	Remote Connect Remote Disconnect Device Commissioning Device Decommissioning On-Demand Read (Scalar) On-Demand Read (Interval)
UserManager	Remote Connect Remote Disconnect Device Commissioning Device Decommissioning On-Demand Read (Scalar) On-Demand Read (Interval)
ProcessCallout	User Exit Functions

To define an override Endpoint URI for the NES adapter, use the following procedure:

1. Open the SOA Composer for your BPEL configuration.

The URL for the SOA Composer is <http://server:port/soa/composer>.

2. Select the D4–EndpointOverrides.dvm in the left panel.

- In Fusion Middleware v12.2.1, this is located under **Shared** in the **Deployment View**, or under **Domain Value Maps** in the **Types View**.
- In Fusion Middleware v12.2.2, this is located under **Metadata** in the **Deployment View**.

The DVM will open in the right panel. The **Description** field lists the available keys for the DVM (only the first key is shown, but you can scroll through the contents to view the list. The panel also displays a list of previously defined keys.

3. Click the **Create Session** button (above the left panel) to begin an editing session.
4. Click the **Add Domain Values** icon (“+”) to add a new key.

The **Add Domain Values** dialog opens.

5. Enter the appropriate values in the **Add Domain Values** dialog as follows:
 - **key**: The DVM key for the Endpoint URI you wish to define (see the table above).
 - **EndpointURI**: The override Endpoint URI.
6. Click **OK**.

The new DVM value will appear in the list of keys.

7. Click the **Save** icon to save the DVM values.
8. Click the **Publish** button to activate all the changes in the editing session.

Enter an optional note for the session in the **Publish Session** dialog.

Changes take effect immediately upon publishing the session.

Click **Discard** to discard your changes.

Click **Exit** to exit your current session. Note that your session will still be open if you exit. Use **Discard** to end your session without making changes.

Configuring Networked Energy Services Extendable Lookups

NOTE: This section applies to **both** middleware and native implementations of the Smart Grid Gateway Adapter for Networked Energy Services.

This section outlines some of the extendable lookups that must be configured for use with the NES adapter. Refer to the Oracle Utilities Application Framework documentation for more information about working with extendable lookups.

Device Event Mapping

The Device Event Mapping extendable lookup is used to determine which type of device event business object to instantiate when receiving device events from the head-end system. Each value defined for the Device Event Mapping extendable lookup should include the following:

- **Head-End System Event Name**: The event name used by the head-end system
- **Description**: A description of the device event
- **Status**: The status of the lookup value (can be Active or Inactive)
- **Standard Event Name**: The standard event name for device events of this type, from the “Standard Event Name” extendable lookup.

UOM Code to Standard UOM Mapping

Usage received from a utility’s head-end system may use utility-specific unit of measures (UOMs). These custom UOMs must be mapped to standard UOM codes. The UOM Code to Standard UOM Mapping extendable lookup is used for this purpose. Each value defined for the UOM Code to Standard UOM Mapping extendable lookup should include the following:

- **Head-end UOM**: The unit of measure code used by the head-end system.
- **Unit of Measure**: The unit of measure defined in the system.
- **Description**: A description of the unit of measure code.

Interval Status Code to Condition Mapping

Interval usage received from the NES can include NES interval status codes that indicate the status or condition of the interval value. These interval status codes must be mapped to standard condition codes in the system. The NES Interval Status Code to Condition Mapping extendable lookup is used to determine how to map NES interval status codes to standard status codes when receiving usage from the NES.

Each value defined for the NES Interval Status Code to Condition Mapping extendable lookup should include the following:

- **Interval Status:** The NES interval status code
- **Condition:** The condition code to which the interval status code is to be mapped, from the Measurement Condition extendable lookup.
- **Description:** A description of the interval status code.
- **Priority:** The priority of the interval status code, represented as a numeric value where larger numbers correlate to higher priorities.

Other Extendable Lookups

Business Object	Description
D4-EntityTypeLookup	Entity Type
D4-ExtServiceReturnCodeLookup	External Service Return Code
D4-GatewayTypeLookup	Gateway Type
D4-IDTypeLookup	ID Type
D4-InformationReturnCodeLookup	Information Return Type
D4-LoadVoltageStatusTypeLookup	Load Voltage Status Type
D4-TaskPriorityLookup	Task Priority
D4-TimeZoneManagerLookup	Time Zone Manager

Configuring NES Usage and Event Extract Processing

Usage and events received from the NES server must be requested from Oracle Utilities Smart Grid Gateway. Extract requests for usage and events are triggered by a batch process, and sent to the NES via middleware. The NES compiles a batch of usage or events and sends it to BPEL services to create a file to be processed by Oracle Service Bus (OSB) services, it is then loaded as SGG events and/or usage.

This section describes the processing performed by the extract request process, and the configuration steps involved.

Extract Request Processing

This section provides a detailed description of the extract request process.

- The “Usage / Event Extract Scheduler Monitor” batch process (D1-EXTSC) checks for “NES Usage Extract Scheduler” or “NES Event Extract Scheduler” activities that are in the “Active” state, and transitions these to the “Send Request” state. It also updates the “Latest Request Start Date/Time” and “Latest Request End Date/Time” fields on the activity based on the date and time of the request.
- When the activity enters the “Send Request” state, an Enter algorithm (either “Usage Extract Scheduler Send Request” (D4-USGSNDREQ) or “Event Extract Scheduler Send Request” (D4-EVTSNDREQ)) sends a request via an message sender to the middleware (via the GrabBatchUsage or GrabBatchEvent BPEL services), which in turn send the request to the NES server.

- After the request is sent, the “NES Usage Extract Scheduler” or “NES Event Extract Scheduler” activity to set back to the “Active” state.
- The NES server calls the BPEL services “GrabBatchEvents” and “GrabBatchUsage.” BPEL then routes the incoming events or usage to a file system, which is used by OSB components to process the usage or events.

Extract Request Configuration Steps

This section outlines the objects that must be configured to support batch extracts of usage and events from an NES head-end system. To configure the NES Adapter to support sending extract requests for usage and events, you must do the following:

- Create message senders (one for usage, one for events) to send extract requests.
- Create Outbound Message Types (one for usage, one for events) for extract requests.
- Associate the message senders and Outbound Message Types to the External System used with the head-end system service provider
- Create “NES Usage Extract Scheduler Type” and “NES Event Extract Scheduler Type” activity types.
- Create “NES Usage Extract Scheduler” and “NES Event Extract Scheduler” activities.

The following sections provide details for configuring these object. Refer to the Oracle Utilities Application Framework documentation for more information about creating message senders, Outbound Message Types, and External Systems.

Note: Configuration of the OSB and BPEL services used by this process is done when installing and configuring the OSB and BPEL components of the NES Adapter.

Message Sender - NES Handle Batch Event

Create an message sender for event extracts as follows:

Main Tab:

- **Message Sender:** Enter a code for the batch event message sender (D4-HNLBATEVT)
- **Description:** NES Handle Batch Event
- **Invocation Type:** Real-time
- **Message Class:** RTHTTPSNDNR (Sender routes messages via HTTP real-time)
- **Active:** True (checked)
- **MSG Encoding:** UTF-8 message encoding

Context Tab:

- **HTTP Header:** SOAPAction:http://xmlns.oracle.com/ouaf/NES/GrabBatchEvents
- **HTTP Login User:** <USER_ID>
- **HTTP Login Password:** <PASSWORD>
- **HTTP Method:** POST
- **HTTP URL 1:** http://<EM_SERVER>:<EM_SERVER_PORT>/soa-infra/services/NES/HandleBatchEvent/ BatchEventHandler

where:

- <USER_ID>: the user ID used to log into WebLogic Enterprise Manager
- <PASSWORD>: the password used to log into WebLogic Enterprise Manager
- <EM_SERVER>: the machine name or IP address of server where the WebLogic Enterprise Manager is installed
- <EM_SERVER_PORT>: the port where the WebLogic Enterprise Manager is installed

Message Sender - NES Handle Batch Usage

Create a message sender for usage extracts as follows:

Main Tab:

- **Message Sender:** Enter a code for the batch usage message sender (D4-HNLBATUSG)
- **Description:** NES Handle Batch Usage
- **Invocation Type:** Real-time
- **Message Class:** RTHTTPSNDR (Sender routes messages via HTTP real-time)
- **Active:** True (checked)
- **MSG Encoding:** UTF-8 message encoding

Context Tab:

- **HTTP Header:** SOAPAction:http://xmlns.oracle.com/ouaf/NES/GrabBatchUsage
- **HTTP Login User:** <USER_ID>
- **HTTP Login Password:** <PASSWORD>
- **HTTP Method:** POST
- **HTTP URL 1:** http://<EM_SERVER>:<EM_SERVER_PORT>/soa-infra/services/NES/HandleBatchUsage/BatchUsageHandler

where:

- <USER_ID>: the user ID used to log into WebLogic Enterprise Manager
- <PASSWORD>: the password used to log into WebLogic Enterprise Manager
- <EM_SERVER>: the machine name or IP address of server where the WebLogic Enterprise Manager is installed
- <EM_SERVER_PORT>: the port where the WebLogic Enterprise Manager is installed

Outbound Message Type - NES Handle Batch Event

Create an Outbound Message Type for event extract requests as follows:

- **Outbound Message Type:** Enter a code for the batch event Outbound Message Type (D4-HNLBATEVT)
- **Description:** NES Handle Batch Event
- **Business Object:** D1-OutboundMessage
- **Priority:** - Priority 20 (or lower)

Outbound Message Type - NES Handle Batch Usage

Create an Outbound Message Type for usage extract requests as follows:

- **Outbound Message Type:** Select a code for batch usage Outbound Message Type (D4-HNLBATUSG)
- **Description:** NES Handle Batch Usage
- **Business Object:** D1-OutboundMessage
- **Priority:** Priority 20 (or lower)

External Systems

Add the event and usage extract Outbound Message Types and message senders to the external system used for the NES head-end system as follows:

- **External System:** NES
- **Description:** NES
- **Outbound Message Types:**

Outbound Message Type	Message Sender
D4-HNLBATEVT	D4-HNLBATEVT
D4-HNLBATUSG	D4-HNLBATUSG

Note: The following apply to the above outbound message types:

- **Processing Method:** Real-time
- **Message XSL:** D4-Request xsl
- **Response XSL:** D4-Response.xsl

Activity Type - NES Event Extract Scheduler

Create an Activity Type for event extract requests as follows:

- **Activity Type:** Enter a code for the activity type (NES-EVENT-EXTRACT)
- **Description:** Enter a description for the activity type (NES Event Extract Scheduler Type)
- **Related Transaction BO:** NES Event Extract Scheduler
- **Activity Type Status:** Active
- **Outbound Message Type:** NES Handle Batch Event
- **External System:** The external system used for the NES head-end system
- **Exception Handling:**
 - **To Do Type:** Activity To Do Type
 - **To Do Role:** System Default Role
 - **Retry Frequency:** Select retry frequency in case if Activity reaches an error state (00:03:00)
 - **Maximum Retries:** Select max number of times the activity will be retried - since it reached the error state (1)
 - **Discard Reason:** Select from the dropdown if available.

Activity Type - NES Usage Extract Scheduler

Create an Activity Type for usage extract requests as follows:

- **Activity Type:** Enter a code for the activity type (NES-USAGE-EXTRACT)
- **Description:** Enter a description for the activity type (NES Usage Extract Scheduler Type)
- **Related Transaction BO:** NES Usage Extract Scheduler
- **Activity Type Status:** Active
- **Outbound Message Type:** NES Handle Batch Usage
- **External System:** The external system used for the NES head-end system
- **Exception Handling:**
 - **To Do Type:** Activity To Do Type
 - **To Do Role:** System Default Role
 - **Retry Frequency:** Select retry frequency in case if Activity reaches an error state (00:03:00)

- **Maximum Retries:** Select max number of times the activity will be retried - since it reached the error state (1)
- **Discard Reason:** Select from the dropdown if available.

Activity - NES Event Extract Scheduler

Initiate an Activity for event extract requests as follows:

1. Select **Main->Communication->Activity+**
2. Select "NES Event Extract Scheduler Type" from the **Activity Type** drop-down list.
3. Enter the number of hours for each extract request in the **Number of Hours of Data Request** field. The default is 24.
4. *Optional:* Enter start and end dates and times for the first extract request in the **Current Request Start Date/Time** and **Current Request End Date/Time** fields.

Note that these are optional fields. If not populated, the values are populated as follows:

- **Current Request Start Date/Time:** taken from the last request stop date/time (which is populated by the "Event Extract Scheduler Send Request" algorithm (D4-EVTSNDREQ))
- **Current Request End Date/Time:** the Current Request Start Date/Time plus the number of hours in the **Number of Hours of Data Request** field.

Activity - NES Usage Extract Scheduler

Initiate an Activity for usage extract requests as follows:

1. Select **Main->Communication->Activity+**
2. Select "NES Usage Extract Scheduler Type" from the **Activity Type** drop-down list.
3. Enter the number of hours for each extract request in the **Number of Hours of Data Request** field. The default is 24.
4. *Optional:* Enter start and end dates and times for the first extract request in the **Current Request Start Date/Time** and **Current Request End Date/Time** fields.

Note that these are optional fields. If not populated, the values are populated as follows:

- **Current Request Start Date/Time:** taken from the last request stop date/time (which is populated by the "Usage Extract Scheduler Send Request" algorithm (D4-USGSNDREQ))
- **Current Request End Date/Time:** the Current Request Start Date/Time plus the number of hours in the **Number of Hours of Data Request** field.

Executing Extract Requests

To schedule and execute usage and device event extract requests, set up the "Usage / Event Extract Scheduler Monitor" batch process (D1-EXTSC) to run at a frequency appropriate to when you wish to retrieve usage and device events from the NES. For example, to retrieve usage and device events on a daily basis, schedule the "Usage / Event Extract Scheduler Monitor" batch process (D1-EXTSC) to run once every 24 hours.

Sensus

The Oracle Utilities Smart Grid Gateway Adapter for Sensus RNI supports communication with the Sensus Regional Network Interface (RNI), including measurement data and device event loading, and command messaging in support of commissioning, connect, disconnect, decommissioning, status check, and on-demand read. The following table describes the attributes of the adapter:

Attribute	Details
Currently Supported Version	Sensus RNI 4.10
Protocol	MultiSpeak 3.0 & 4.1. RNI 3.1 and the SGG Sensus RNI adapter support MultiSpeak 4.1
Market(s)	Worldwide
Architecture	Long range radio WAN (mesh)

Sensus Adapter Processing

This section provides details concerning the OSB processing, BPEL Processes, and Oracle Utilities Application Framework (OUAF) objects that are supplied as part of the base package. This information illustrates how the base package objects were designed, and can serve as the basis for any customizations you create as part of your implementation.

Initial Measurement Data and Device Event Loading

The initial measurement data load and device event processing use OSB to poll for, parse, and transform the head-payloads into the Oracle Utilities Smart Grid Gateway (SGG) service format. Payloads contain measurements and meter events in some head-end specific format. OSB then places each service call into a Java Message Service (JMS) queue within the Oracle Utilities applications. The JMS client consumes the entries and invokes the respective services in parallel. A service then creates initial measurements with data in a common format with head-end-specific processing as needed. A second service creates device events with data in a common format.

Initial Measurements

The usage data exported from the AMI head-end system as a file in Sensus RNI format is loaded into Oracle Utilities as Initial measurement data. The following OSB projects, delivered in the base product, help manage the usage processing:

1. **SGG-D6-USAGE-BASE** contains components responsible for “actual” processing of incoming data. It should not be modified during configuration. This can be upgraded without affecting the customization and environment settings added to SGG-D6-USAGE-CM.
2. **SGG-D6-USAGE-CM** allows for customization and simplifies future upgrades.

The runtime configuration settings for the SGG-D6-USAGE-CM project are stored in the xquery file EnvironmentSettings.xq. You can use this file to adjust initial measurement data processing. For example, if you want to load raw data you would specify “true” for the content of the populateRawIMD element.

The following table describes the elements included in the EnvironmentSettings.xq file:

Element	Description	Valid Values
populateRawIMD	Determines if the initial measurement data is populated as raw data.	true false
callPreProcessing	Determines if the preprocessing proxy service is called.	true false
callPostProcessing	Determines if the postprocessing proxy service is called.	true false
destinationRootElementInterval	Holds the name of inbound web service for the interval IMD seeder.	
destinationRootElementScalar	Holds the name of inbound web service for the scalar IMD seeder. In most cases it is the same as destinationRootElementInterval.	
dateTimelnUTC	Indicates whether the Sensus RNI system is sending date/time information in UTC (true) or local time of the device (false). If not provided the default behavior will be local time of the device.	true false

Element	Description	Valid Values
publishServices/service	Specifies the name of the business service within the OSB project used to publish data for external systems (such as Oracle DataRaker).	
filterUsage	Determines if usage should be filtered.	true false
useExternalTOU	Indicates whether or not an externally reference TOU period should be used when processing measurement data.	true false
scalarExpanding	Defines the number of register reads to process in scalar payloads. When defined, Sensus payload processing uses this setting to ensure that all the scalar reads included in a payload will be processed. Default value is 2.	

Publishing Initial Measurement Data

The SGG adapter can be configured to publish initial measurement data for use in Oracle DataRaker or other external systems. This functionality is supported through a combination of OSB components and BPEL composites.

Enabling Initial Measurement Data Publishing

Publishing data is enabled by referencing a publisher business service in the publishServices/service element in the EnvironmentSettings.xq file as follows:

```
<publishServices>
  <service>[publisherBusinessService]</service>
</publishServices>
```

The following components provided with the SGG-D6-USAGE-CM OSB project are used in publishing measurement data to Oracle DataRaker:

- The **DataRakerBusinessService** business service is used to send data to a pre-configured JMS queue (defined as an Endpoint URI), from which the data will be published. This is the business service that should be specified in the EnvironmentSettings.xq file.
- The **DataRakerServiceAccount** service account is used to define and maintain the user name and password needed to access the JMS queue defined in the **DataRakerBusinessService** business service.

Configuring Initial Measurement Publishing Output

The SGGDRIntegration BPEL composite handles publishing the data to Oracle DataRaker or other systems. Initial measurement data is published in the “native” initial measurement data format (the format of the initial measurement seeder business object). This format includes normalized unit of measure and condition codes. See the *Oracle Utilities Smart Grid Gateway Adapter Development Kit Administrative User Guide* for more details about this format.

NOTE: Initial measurement data published through this feature is published prior to validation, estimation, and editing (VEE) processing. In addition, filtering *cannot* be applied to data published through this feature.

The following parameters can be used to configure details of how the data is provided to Oracle DataRaker, including the directory where files are posted for Oracle DataRaker to consume, number of records per file, polling frequency, etc. These parameters are defined during installation. See the *Oracle Utilities Smart Grid Gateway Installation Guide* for more details about defining values for these parameters.

Parameter	Description	Default Value
SGG_DR_INT_QUEUE	JNDI name of queue to publish SGG payloads.	DataRakerQueue

Parameter	Description	Default Value
	This is the JMS queue defined in the DataRakerBusinessService business service. This should NOT be changed.	
SOA_DR_PUBLISH_SIZE	The number of records (SGG payloads) to accumulate in a published file.	100
SOA_DR_FILE_SIZE	The maximum file size for the accumulated (SGG payloads) file in kilobytes.	524288
SOA_DR_ELAPSED_TIME	The period of time in second which, when exceeded, causes a new outgoing file to be created.	600
SOA_DR_POLLING_FREQ	The polling frequency in seconds of the staging directory for new files.	60
SOA_DR_STAGING_DIR	Mount point/directory for the staging directory for accumulated SGG payload files. This is used internally and should NOT be changed.	/spl/sploutput/staging
SOA_DR_INTEGRATION_DIR	Mount point/directory from which Oracle DataRaker will consume the converted XML files.	/spl/sploutput/int

Filtering Initial Measurement Data

The SGG adapter can be configured to filter initial measurement data passed into SGG and the Oracle Utilities Meter Data Management application. Filtering data is enabled by setting the <filterUsage> element in the EnvironmentSettings.xq file to “true” as follows:

```
<filterUsage>true</filterUsage>
```

When filtering is enabled, only measurements whose <externalUOM> matches one of the values defined in the **Sensus UOM Code to Standard UOM Mapping** extendable lookup (D6-HeadendUOMLookup) are passed into the system for processing.

Processing Large Input Files

In some environments, the OSB project may begin processing a large input file before it has been completely copied to the input directory. To prevent this, configure the MinimumAge property in the “InboundProxyService” proxy service for the project. The MinimumAge property specifies the minimum age of files to be retrieved, based on the last modified time stamp. This enables large files to be completely copied to the input directory before they are retrieved for processing.

Prioritized Initial Measurement Processing

The SGG adapter prioritizes processing of initial measurements created from smart meter commands and/or completion events by setting the Execution Method flag in these types of initial measurements to “Real Time” (D1RT). In addition, initial measurements received with the Execution Method flag set to “Real Time” will be processed in real time rather than via batch processing. See **Initial Measurement Data Prioritization** in the *Oracle Utilities Meter Data Management / Smart Grid Gateway Business User Guide* for more information.

Device Events

The device event data exported from the head-end system as a file in Sensus RNI format is loaded into Oracle Utilities as a Device Event. One of your configuration tasks is to customize the device events processing.

The required functionality is delivered in the base product as two OSB projects:

1. **SGG-D6-EVENT-BASE** contains components responsible for “actual” processing of incoming data. It can be upgraded in future without affecting the customization and environment settings that done in SGG-D6-EVENT-CM project.
2. **SGG-D6-EVENT-CM** allows the customization and simplifies the future upgrades.

The runtime configuration settings for the SGG-D6-EVENT-CM project are stored in the xquery file EnvironmentSettings.xq. You can use this file to adjust initial measurement data processing. For example, if you want to load raw data you would specify “true” for the content of the populateRaw element.

The following table describes the elements included in the EnvironmentSettings.xq file:

Element	Description	Valid Values
populateRaw	Determines if the event data is populated as raw data.	true false
callPreProcessing	Determines if the preprocessing proxy service is called.	true false
callPostProcessing	Determines if the postprocessing proxy service is called.	true false
destinationRootElement	Holds the name of inbound web service for the device event seeder.	
dateTimelnUTC	Indicates whether the Sensus RNI system is sending date/ time information in UTC (true) or local time of the device (false). If not provided the default behavior will be local time of the device.	true false
publishServices/service	Specifies the name of the business service within the OSB project used to publish data for external systems (such as Oracle DataRaker).	
filterEvents	Determines if events should be filtered.	true false

Publishing Events

The Sensus adapter can be configured to publish device events for use in Oracle DataRaker or other external systems. This functionality is supported through a combination of OSB components and BPEL composites.

Enabling Device Event Publishing

Publishing data is enabled by referencing a publisher business service in the publishServices/service element in the EnvironmentSettings.xq file as follows:

```
<publishServices>
  <service>[publisherBusinessService]</service>
</publishServices>
```

The following components provided with the SGG-D6-EVENT-CM OSB project are used in publishing device events data to Oracle DataRaker:

- The **DataRakerBusinessService** business service is used to send data to a pre-configured JMS queue (defined as an Endpoint URI), from which the data will be published. This is the business service that should be specified in the EnvironmentSettings.xq file.
- The **DataRakerServiceAccount** service account is used to define and maintain the user name and password needed to access the JMS queue defined in the **DataRakerBusinessService** business service.

Configuring Device Event Publishing Output

The SGGDRIntegration BPEL composite handles publishing the data to Oracle DataRaker or other systems. Device event data is published in the “native” device event data format (the format of the device event seeder business object). This

format includes normalized device event codes. See the *Oracle Utilities Smart Grid Gateway Adapter Development Kit Administrative User Guide* for more details about this format.

NOTE: In addition, filtering can NOT be applied to device events published via this feature.

The following parameters can be used to configure details of how the data is provided to Oracle DataRaker, including the directory where files are posted for Oracle DataRaker to consume, number of records per file, polling frequency, etc. These parameters are defined during installation. See the *Oracle Utilities Smart Grid Gateway Installation Guide* for more details about defining values for these parameters.

Parameter	Description	Default Value
SGG_DR_INT_QUEUE	JNDI name of queue to publish SGG payloads. This is the JMS queue defined in the DataRakerBusinessService business service. This should NOT be changed.	DataRakerQueue
SOA_DR_PUBLISH_SIZE	The number of records (SGG payloads) to accumulate in a published file.	100
SOA_DR_FILE_SIZE	The maximum file size for the accumulated (SGG payloads) file in kilobytes.	524288
SOA_DR_ELAPSED_TIME	The period of time in second which, when exceeded, causes a new outgoing file to be created.	600
SOA_DR_POLLING_FREQ	The polling frequency in seconds of the staging directory for new files.	60
SOA_DR_STAGING_DIR	Mount point/directory for the staging directory for accumulated SGG payload files. This is used internally and should NOT be changed.	/spl/sploutput/staging
SOA_DR_INTEGRATION_DIR	Mount point/directory from which Oracle DataRaker will consume the converted XML files.	/spl/sploutput/int

Filtering Events

The SGG adapter can be configured to filter initial measurement data passed into SGG and the Oracle Utilities Meter Data Management application. Filtering data is enabled by setting the <filterUsage> element in the EnvironmentSettings.xq file to “true” as follows:

```
<filterEvents>true</filterEvents>
```

When filtering is enabled, only device events whose <externalEventName> matches one of the values defined in the **Sensus Device Event Mapping** extendable lookup (D6-DeviceEventMappingLookup) are passed into the system for processing.

Prioritized Device Event Processing

The SGG adapter prioritizes processing of device events created from smart meter commands and/or completion events by setting the Execution Method flag in these types of device events to “Real Time” (DIRT). In addition, device events received with the Execution Method flag set to “Real Time” will be processed in real time rather than via batch processing. See **Device Event Prioritization** in the *Oracle Utilities Meter Data Management / Smart Grid Gateway Business User Guide* for more information.

Configuring Payload Processing Notifications

By default, Payload Statistics, Payload Error Notification, and Payload Summary notification activities are sent to the Notification Queue within Oracle Service Bus. Smart Grid Gateway adapters can be configured to restrict sending these activities by defining optional JCA transport dynamic properties in the appropriate OSB project. The following optional JCA transport dynamic properties can be used to control if these notification activities are sent:

- **SGG_SEND_STATISTICS**: Controls sending Payload Statistic activities (true: send, false: do not send)
- **SGG_SEND_ERROR**: Controls sending Payload Error Notification activities (true: send, false: do not send)
- **SGG_SEND_SUMMARY**: Controls sending Payload Summary activities (true: send, false: do not send)

When these properties are set to false, the corresponding payload notification will not be sent to the JMS Queue. Note these properties are not populated by default, and default to true if omitted.

To create these properties:

1. Navigate to the SGG-D6-EVENT-CM project in the Oracle Service Bus Console.
2. Expand the **Proxy Services** folder.
3. Select the **InboundProxyService** proxy service (not the Pipeline or WSDL).
4. Click **Create** to create a new session.
5. Select **Transport Details**.
6. Click the plus sign in the **Dyanmic EndPoint Properties** section. An empty row will appear.
7. Enter the property you wish to define in the **Property** column.
8. Enter "false" in the **value** column.
9. Repeat steps 6-8 for each property you wish to define.
10. Click **Activate** to save and activate your changes.

NOTE: These properties are only used if the SGG_EXT_ID_PATTERN is not present or the regular expression captures nothing. The SGG_EXT_ID_PATTERN will override these properties when the regular expression captures group data.

Base Package Business Objects

The Sensus RNI adapter base package includes the following device and initial measurement business objects:

Business Object Name	Description
D6-InitialLoadIMDInterval	Sensus Initial Load IMD - Interval Used when loading Sensus interval measurements into the system for the first time.
D6-InitialLoadIMDScalar	Sensus Initial Load IMD - Scalar
D6-SmartMeter	Sensus Smart Meter

Device Communication

The basic communication for all business processing is essentially the same. A communication request is sent from the Oracle Utilities application to the head-end system. This request would be for a connect/disconnect, commission/decommission, measurement data, an on-demand read, or another type of request that the head-end system supports. The designated BPEL process transforms the request from Oracle Utilities format to MultiSpeak format and invokes the related web service from the head-end system. The head-end system then returns a reply, and the BPEL process transforms the reply message back to the appropriate format so that Oracle Utilities can receive the response.

Communication Flows

The table below lists the communications created for each Sensus RNI command:

Command	Outbound Communication	Inbound Communication	Completion Event
Remote Connect	Sensus – Initiate Connect Disconnect	Sensus – Connect / Disconnect State Change	Connect Device Completion Event
Remote Disconnect	Sensus – Initiate Connect Disconnect	Sensus – Connect / Disconnect State Change	Disconnect Device Completion Event
Device Commissioning	Sensus – Meter Add Notification		Device Commissioning Completion Event
Device Decommissioning	Sensus – Meter Remote Notification		Device Decommissioning Completion Event
On-Demand Read (Scalar)	Sensus – Initiate Meter Read By Meter ID	Sensus – Reading Changed Notification	Create IMD Completion Event
On-Demand Read (Interval)	Interval data not supported		
Device Status Check	Sensus – Initiate Outage Detection	Sensus – Outage Detection Event Notification	

Unit of Measure Filtering for On-Demand Reads

Readings returned via On-Demand Read commands are filtered on the combination of Unit of Measure/Time of Use/Service Quantity Identifiers (UOM/TOU/SQI) configured for the device and measuring component. When filtering is enabled, only readings that match a configured UOM/TOU/SQI combination are processed. All others are filtered out.

Filtering is enabled by default via the “Opt Out Of Filtering” parameter (set to "false" by default) on the D6-CCOMPEV (Create IMD Completion Event) algorithm on the Create Completion Events status of the D6-ReadingChgNotification (Sensus - Reading Changed Notif SOA based) business object.

The D6-VALDVCFIL (Check if Device has any Filtering errors) algorithm on the Validate status of the D6-ReadingChgNotification (Sensus - Reading Changed Notif SOA based) business object is used to check for errors related to filtering. The value of the “Opt Out Of Filtering” parameter on this algorithm must match the value of the parameter on the D6-CCOMPEV algorithm. The parameters should both be set to either "false" (the default) or "true" (if filtering is to be disabled).

Device Communication Base Package Business Objects

The Sensus RNI Adapter base package includes the following communication business objects:

Business Object Name	Description
D6-ConnectDisconStateChgNtf	Sensus - Connect/Disconnect State Change
D6-InitiateConnectDisconnect	Sensus - Initiate Connect Disconnect
D6-InitiateMeterByMeterId	Sensus - Initiate Meter Read By Meter ID
D6-InitiateOutageDetection	Sensus - Initiate Outage Detection
D6-MeterAddNotification	Sensus - Meter Add Notification
D6-MeterRemoveNotification	Sensus - Meter Remove Notification
D6-OutageDetectEvtNotification	Sensus - Outage Detection Event Notification
D6-ReadingChgNotification	Sensus - Reading Changed Notification
D6-UnsolicitedEvtNotification	Sensus - Unsolicited Event Notification

Sensus Event Data Mapping

The Sensus event file format maps as follows into the business object, D1-DeviceEventMappingLookup:

Sensus Flat File Field	Device Event Seeder BO Element	Comments
Transaction ID (from Header record)	External Source Identifier	This is the file name.

Sensus Flat File Field	Device Event Seeder BO Element	Comments
Device Identifier	External Device Identifier	
Event Name	External Event Name	
Event Creation Date/Time	Event Date/Time	
Device Type	External Device Type	This element has no real bearing on the device type within MDM/SGG. Its valid values include (although the element itself is free-form): Meter Collector Router
Service Location ID	External Service Location ID	
Communication Module Serial Number	External Communication Module Identifier	
Event Category ID	External Event Category	
Event Severity	External Event Severity	Valid values include (although the element itself is free-form): Alert Information
Status Value	External Status Value	This represents additional information that relates to the event itself.
Status Date/Time	External Status Date/Time	The date & time at which the additional information referenced above had occurred.

External System

You must create an External System for each external system to which Oracle Utilities Smart Grid Gateway will send messages. Each external system defines a set of outbound message types that will be sent to that system. Each external system outbound message type also specifies the following:

- The processing method used to send the message (Batch or Real-time)
- The corresponding message senders
- Batch Control (if Processing Method is set to Batch)
- Message XSL, W3C Schema, and Response XSL (as applicable)

Outbound Message Types

Acknowledgement and response messages are sent and received validating that commands have been transmitted.

Outbound Message Type	Description
D6-CONDISCON	Sensus Initiate Connect Disconnect
D6-INITMTR	Initiate Meter Read By Meter ID
D6-INTOUTDET	Initiate Outage Detection Request

Inbound / Outbound Service Configuration

The inbound/outbound message utility allows you to configure your system to receive information from and to send information to external applications using XML. The Oracle Utilities Smart Grid Gateway uses one inbound web service to map device events. This is the same inbound web service used by the D1 application.

Inbound Web Services

Inbound web services define the details of how messages are received from an external system, including the inbound communication business object (or business service or service script) to be invoked when the response message is received. As in the case of inbound communication business objects, the set of inbound web services you need to create is based on the types of messages the system is designed to send.

The Oracle Utilities Smart Grid Gateway adapter for Sensus RNI includes the following inbound web services:

Inbound Web Service	Description
D1-BulkRequestHeader	Bulk Request Header
D1-BulkRequestUpdate	Bulk Request Update
D1-BulkResponse	Bulk Response
D1-DeviceEventSeeder	Used for upload of device events. The Device Event Seeder business object serves as a means of adding device events both from outside the application and from online. Its pre-processing algorithms determine the device event type - which in turn defines the device event BO that should be used to create the device event. If a device event type can't be determined, the device event is created using this BO. Such a device event can then be re-processed - and if successful, a new device event is created.
D1-InitialLoadIMD	Used for initial measurement upload. The IMDSeeder business object is used to determine the type of initial measurement business object to instantiate when receiving usage readings from a head-end system.
D1-DeviceStatusCheck	Device Status Check This service is invoked by the integration layer to instantiate a Device Status Check command.
D1-InitialLoadIMD	Used by OSB to instantiate an IMD This inbound web service is used by OSB to instantiate an Initial Measurement Data for incoming interval usage in the Sensus format.
D1-RemoteConnect	Remote Connect This service is invoked by the integration layer to instantiate a Remote Connect command.
D1-RemoteDisconnect	Remote Disconnect This service is invoked by the integration layer to instantiate a Remote Disconnect command.
D6-ConDisconStChgNotification	Initiate Connect Disconnect response. Retrieve response from the Initiate Connect Disconnect command.
D6-OutageDetectionEventNotification	Initiate Outage Detection Response Retrieve response from the Initiate Outage Detection Event Notification command.
D6-ReadingChangedNotification	Reading Changed Notification Notification that a Sensus device reading has changed.
D6-UnsolicitedEventNotification	Unsolicited Event Response Retrieve unsolicited notifications when an event triggers an alarm on the meter.

Message Senders

Message senders define the details of how messages are sent to an external system. As in the case of outbound communication business objects and outbound message types, the set of message senders you need to create is based on the types of messages the system is designed to accept.

The Oracle Utilities Smart Grid Gateway adapter for Sensus RNI includes the following message senders:

Message Sender	Description
D6-CONDISCON	Sensus Initiate Connect/Disconnect
D6-INTOUTDET	Initiate Outage Detection Request
D6-InitMID	Initiate Meter Read By Meter ID Outbound Message

BPEL Processes

These processes are responsible for performing the conversion from Oracle Utilities format to MultiSpeak 4.1 format, invoking process callouts and invoking the remote endpoint to trigger the device events.

OnDemandRead Composite Process — Invokes the remote endpoint to trigger the on-demand read event. An asynchronous reply responds to the OUAF layer when the reading arrives.

ConnectDisconnect Composite Process — Invokes the remote endpoint to trigger the connect/disconnect event. An asynchronous reply responds to the OUAF layer when confirmation of the requested event arrives.

CommissionDecommission Composite Process — Invokes the remote endpoint to trigger the commission or decommission event. After the synchronous call completes, a one of the following second business callout services is invoked to determined if the related “received” or “completed” callout should be executed:

- isExecutingCommissionReceivedCallout
- isExecutingCommissionCompletedCallout
- isExecutingDecommissionReceivedCallout
- isExecutingDecommissionCompletedCallout

DeviceStatusCheck Composite — Invokes the remote endpoint to trigger the initiate outage detection event. An asynchronous reply responds to the OUAF layer when confirmation of the requested event arrives.

ProcessCallout Composite — This business callout provides a point at which customers and implementers can incorporate custom business logic and transformations. This composite includes the WSDLs and processing logic for all of the MultiSpeak processes. The default implementation of each method is a direct return of the input.

Web Services

These web services are all defined in the Sensus RNI head end system. The WSDLs were added to a Meta Data Storage (MDS) layer in OUAF and all references to the WSDL point to this MDS location. These web services have HTTP security by default. You may need to modify the security as a part of your implementation.

Web Service	Related BPEL Process	Description
CB_ServerService	ConnectDisconnect	<p>This web service defines the return interface, the means by which the status is returned to the calling system.</p> <p>This web service is only be invoked by the head end system, not OUAF. Only the CDStateChangeNotification web method is implemented in the composite.</p> <p>The endpointURI format is: http://<EM_SERVER>:<EM_SERVER_PORT>/soa-infra/services/Sensus/ConnectDisconnect/CB_ServerService</p>

Web Service	Related BPEL Process	Description
CB_Server	OnDemandRead	<p>This web service defines the return interface, the means by which the reading is returned to the calling system.</p> <p>This web service is only be invoked by the head end system, not OUAF. Only the ReadingChangedNotification web method is implemented in the composite.</p> <p>The endpointURI format is: http://<EM_SERVER>:<EM_SERVER_PORT>/soa-infra/services/Sensus/OnDemandRead/CB_Server</p>
OA_ServerService	DeviceStatusCheck	<p>This web service defines the asynchronous return for InitiateOutageDetectionEventRequest for solicited responses. It is also used for unsolicited alarms.</p> <p>This web service is only be invoked by the head end system, not OUAF. Only the ODEventNotification, PingURL, and GetMethods web methods are implemented in the composite.</p> <p>The endpointURI format is: http://<EM_SERVER>:<EM_SERVER_PORT>/soa-infra/services/Sensus/DeviceStatusCheck/OA_ServerService</p>

Sensus RNI Web Services

The following table describes the Sensus RNI web services and operations used for the Oracle Utilities Smart Grid Gateway command messaging:

Smart Grid Gateway Command	AMI Adapter Business Objects	Sensus Web Services	Sensus Operations
Device Commissioning	D6-MeterAddNotification	MR	MeterAddNotification
Device Decommissioning	D6-MeterRemoveNotification	MR	MeterRemoveNotification
Remote Connect/ Remote Disconnect	D6-InitiateConnectDisconnect	CD	InitiateConnectDisconnect
	D6-ConnectDisconStateChgNtf	CB	CDStatesChangedNotification (async reply)
Device Status Check	D6-InitiateOutageDetection	OD	InitiateOutageDetectionEventRequest
	D6-OutageDetectEvtNotification	OA	ODEventNotification (async reply)
On-Demand Read	D6-InitiateMeterByMeterId	MR	InitiateMeterReadingsByMeterID
	D6-ReadingChangedNotification	CB	ReadingChangedNotification (async reply)

Configuring a Sensus Head-End System

This section outlines the configuration required for the Oracle Utilities Smart Grid Gateway Adapter for Sensus RNI to communicate with the Sensus RNI.

Inbound Web Services

Inbound web services define the details of how messages are received from an external system. This includes incoming usage and device events, as well as messages sent from the Sensus Regional Network Interface (RNI) in response to a command request.

The following inbound web services must be configured in your system. If these are not present in your configuration, add them. Refer to the Oracle Utilities Application Framework documentation for more information about creating inbound web services.

Inbound Web Service Name	Description
D1-DeviceEventSeeder	Device Event Seeder
D1-DeviceStatusCheck	Device Status Check
D1-InitialLoadIMD	IMD Seeder
D1-PayloadErrorNotif	Payload Error Notification
D1-PayloadStatistics	Payload Statistics
D1-PayloadSummary	Payload Summary
D6-ConDisconStChgNotification	Initiate Connect Disconnect Response
D6-OutageDetectionEventNotification	Initiate Outage Detection Response
D6-ReadingChangedNotification	Reading Changed Notification
D6-UnsolicitedEventNotification	Unsolicited Event Response

Note: The following apply to all of the above inbound web services:

Message Options

- **Trace:** No
- **Debug:** No
- **Active:** Yes

Operations

- **Operation Name:** Same as web service name
- **Schema Type:** Business Object
- **Schema Name:** Applicable business object code
- **Transaction Type:** Add

Message Senders

Message senders define the details of how messages are sent to an external system, such as messages containing device command requests.

The following message senders must be configured in your system. If these are not present in your configuration, add them. Refer to the Oracle Utilities Application Framework documentation for more information about creating message senders.

Message Sender	Description
D6-CONDISCON	Sensus Initiate Connect/Disconnect
D6-INTOUTDET	Initiate Outage Detection Request
D6-InitMID	Initiate Meter Read By Meter ID Outbound Message

Note: The following apply to all of the above message senders:

Main Tab:

- **Invocation Type:** Real-time

- **Message Class:** RTHTTPSND (Sender routes message via HTTP real-time)
- **MSG Encoding:** UTF-8 message encoding

Context Tab:

- **HTTP Header:** SOAPAction:<OPERATION>
- **HTTP Login User:** <USER_ID>
- **HTTP Login Password:** <PASSWORD>
- **HTTP Method:** POST
- **HTTP URL 1:** http://<EM_SERVER>:<EM_SERVER_PORT>/soa-infra/services/Sensus/<SERVICE>
- where:
 - <OPERATION>: the operation performed by the message sender (see Operation column in the table above)
 - <USER_ID>: the user ID used to log into WebLogic Enterprise Manager
 - <PASSWORD>: the password used to log into WebLogic Enterprise Manager
 - <EM_SERVER_IP>: the machine name or IP address of server where the WebLogic Enterprise Manager is installed
 - <EM_SERVER_PORT>: the port where the WebLogic Enterprise Manager is installed
 - <SERVICE>: the service invoked by the message sender (see Service column in the table above)

Outbound Message Types

Outbound message types define specific types of messages sent to an external system, such as messages containing device command requests.

The following outbound message types must be configured in your system. If these are not present in your configuration, add them. Refer to the Oracle Utilities Application Framework documentation for more information about creating outbound message types.

Outbound Message Type	Description
D6-CONDISCON	Sensus Initiate Connect Disconnect
D6-INITMTR	Initiate Meter Read By Meter ID
D6-INTOUTDET	Initiate Outage Detection Request

Note: The following apply to all of the above outbound message types:

- **Business Object:** D1-OutboundMessage (Outbound Message)
- **Priority:** Priority 50

External System

External systems represent external applications with which the Smart Grid Gateway will exchange messages or data. In the case of the Smart Grid Gateway adapters, external systems represent the head-end systems with which the adapters communicate.

An external system that represents the Sensus RNI must be present in your system. If this is not present in your configuration, add it, along with the following Outbound Message Types. Refer to the Oracle Utilities Application Framework documentation for more information about creating external systems.

External System - Sensus:

- **External System:** Sensus
- **Description:** Sensus

- **Outbound Message Types:**

Outbound Message Type	Description	Message Sender
D6-CONDISCON	Sensus Initiate Connect Disconnect	D6-CONDISCON
D6-INITMTR	Initiate Meter Read By Meter ID	D6-InitMID
D6-INTOUTDET	Initiate Outage Detection Request	D6- INTOUTDET

Note: The following apply to all of the above outbound message types:

- **Processing Method:** Real-time
- **Message XSL:** D6-Request xsl
- **Response XSL:** D6-Response.xsl

Service Provider

Service providers represent external entities that serve various roles relative to the application, including head-end systems, billing systems to which the application sends bill determinant data, market participants in a deregulated environment, outage management systems that receive meter event data from the application, or other parties that require or provide information to the system. The head-end systems that collect and send measurement data and meter events to the application are defined as service providers.

A service provider that represents the Sensus RNI must be present in your system. If this is not present in your configuration, add it. Refer to the Oracle Utilities Meter Data Management / Smart Grid Gateway documentation for more information about creating service providers.

Service Provider - Sensus:

- **Service Provider:** Sensus
- **Description:** Sensus
- **External Reference ID:** Sensus
- **External System:** Sensus
- **Our Name/ID in Their System:**
- **AMI Device ID Type:** Internal Meter Number
- **AMI Measuring Component ID Type:** Channel ID

Processing Methods

Processing methods define the format or means by which a service provider receives and/or sends data from and/or to the application, including as bill determinants, usage data, or device events. Processing methods are also used to define how to create information internal to the application such as initial measurement data and device events. Processing methods can also be used to define how command requests are sent to a given head-end system.

The following types of processing methods must be configured for the Sensus service provider. Refer to the Oracle Utilities Meter Data Management / Smart Grid Gateway documentation for more information about configuring processing methods.

Initial Measurement Creation

Initial measurement creation processing methods define the business objects used to create initial measurements. The IMD Seeder inbound web service uses this processing method to determine which type of initial measurement business object to instantiate when receiving usage from a head-end system.

Device Event Mapping

Device event mapping processing methods define how head-end-specific device events are mapped to standard device event names. The Device Event Seeder inbound web service uses this processing method to determine which type of device event business object to instantiate when receiving device events from a head-end system.

UOM Translation

UOM mapping processing methods define how head-end-specific unit of measure (UOM) codes are mapped to standard UOM codes. This processing method is used to determine how to map head-end system UOM codes to standard UOM codes when receiving usage from the head-end system.

Commands

Command processing methods define how command requests are sent to a head-end system. More specifically, they define the type of outbound communication business object to create for each type of command, and the outbound message type to send to the head-end system.

The following types of command processing methods can be configured for the Sensus service provider, based on the requirements of each implementation using the “How to Create OB COMM/Send OB Message” processing method business object (D1–HowToCreateActivityOBComm).

Command	Processing Role	Default Business Object	Default Outbound Message Type
Device Commission	Device Registration	D6-MeterAddNotification	Commission
Device Decommission	Device Removal	D6-MeterRemoveNotification	Decommission
Device Status Check	Device Status Check	D6-InitiateOutageDetection	Initiate Outage Detection Request
On-Demand Read (Scalar)	On-Demand Read (Scalar)	D6-InitiateMeterByMeterId	Initiate Meter Read by Meter ID
Remote Connect	Remote Connect	D6-InitiateConnectDisconnect	Connect Device
Remote Disconnect	Remote Disconnect	D6-InitiateConnectDisconnect	Disconnect Device

Configuring Endpoint URIs

Part of the configuration process is configuring your BPEL composites to work with your head-end system by defining the appropriate Endpoint URIs for each of the commands. The default approach to defining Endpoints URIs is redeployment or reinstallation of the BPEL composites. For example, by default, changing an adapter from using the test harness to a production environment using the actual head-end system requires editing the appropriate installation menu options and redeploying the BPEL composites. The Endpoints URIs defined during installation and deployment for each adapter are listed in the **Smart Grid Gateway Installation and Configuration Worksheets** section of the *Oracle Utilities Smart Grid Gateway Installation Guide*.

You can also use an “Endpoint Override” Domain Value Map (DVM) to override Endpoint URIs defined during deployment and installation. This DVM allows defining specific keys that provide an alternate URL that will override the original installed value. Endpoint Override DVMs can be edited using the Oracle SOA Composer.

The Sensus endpoint override DVM (D6–EndpointOverrides.dvm) uses a specific set of keys, each used for one or more commands. The table below lists the DVM keys available for the Sensus adapter and the command used with each:

DVM Key	Commands
MR_Server	Device Commissioning Device Decommissioning On-Demand Read (Scalar)

DVM Key	Commands
CD_Server	Remote Connect Remote Disconnect
OD_Server	Device Status Check
ProcessCallout	User Exit Functions

To define an override Endpoint URI for the Sensus adapter, use the following procedure:

1. Open the SOA Composer for your BPEL configuration.

The URL for the SOA Composer is `http://server:port/soa/composer`.

2. Select the D6-EndpointOverrides.dvm in the left panel.

- In Fusion Middleware v12.2.1, this is located under **Shared** in the **Deployment View**, or under **Domain Value Maps** in the **Types View**.

- In Fusion Middleware v12.2.2, this is located under **Metadata** in the **Deployment View**.

The DVM will open in the right panel. The **Description** field lists the available keys for the DVM (only the first key is shown, but you can scroll through the contents to view the list. The panel also displays a list of previously defined keys.

3. Click the **Create Session** button (above the left panel) to begin an editing session.

4. Click the **Add Domain Values** icon (“+”) to add a new key.

The **Add Domain Values** dialog opens.

5. Enter the appropriate values in the **Add Domain Values** dialog as follows:

- **key**: The DVM key for the Endpoint URI you wish to define (see the table above).
- **EndpointURI**: The override Endpoint URI.

6. Click **OK**.

The new DVM value will appear in the list of keys.

7. Click the **Save** icon to save the DVM values.

8. Click the **Publish** button to activate all the changes in the editing session.

Enter an optional note for the session in the **Publish Session** dialog.

Changes take effect immediately upon publishing the session.

Click **Discard** to discard your changes.

Click **Exit** to exit your current session. Note that your session will still be open if you exit. Use **Discard** to end your session without making changes.

Configuring Sensus Extendable Lookups

NOTE: This section applies to **both** middleware and native implementations of the Smart Grid Gateway Adapter for Sensus.

This section outlines some of the extendable lookups that must be configured for use with the Sensus adapter. Refer to the Oracle Utilities Application Framework documentation for more information about working with extendable lookups.

Device Event Mapping

The Device Event Mapping extendable lookup is used to determine which type of device event business object to instantiate when receiving device events from the head-end system. Each value defined for the Device Event Mapping extendable lookup should include the following:

- **Head-End System Event Name:** The event name used by the head-end system
- **Description:** A description of the device event
- **Status:** The status of the lookup value (can be Active or Inactive)
- **Standard Event Name:** The standard event name for device events of this type, from the “Standard Event Name” extendable lookup.

UOM Code to Standard UOM Mapping

Usage received from a utility’s head-end system may use utility-specific unit of measures (UOMs). These custom UOMs must be mapped to standard UOM codes. The UOM Code to Standard UOM Mapping extendable lookup is used for this purpose. Each value defined for the UOM Code to Standard UOM Mapping extendable lookup should include the following:

- **Head-end UOM:** The unit of measure code used by the head-end system.
- **Unit of Measure:** The unit of measure defined in the system.
- **Description:** A description of the unit of measure code.
- **Status:** The status of the lookup value (can be Active or Inactive)

Interval Status Code to Condition Mapping

Interval usage received from the Sensus RNI can include Sensus interval status codes that indicate the status or condition of the interval value. These interval status codes must be mapped to standard condition codes in the system. The Sensus Interval Status Code to Condition Mapping extendable lookup is used to determine how to map Sensus interval status codes to standard status codes when receiving usage from the Sensus RNI.

Each value defined for the Sensus Interval Status Code to Condition Mapping extendable lookup should include the following:

- **Interval Status:** The Sensus interval status code
- **Description:** A description of the interval status code.
- **Status:** The status of the lookup value (can be Active or Inactive)
- **Condition:** The condition code to which the interval status code is to be mapped, from the Measurement Condition extendable lookup.

Other Extendable Lookups

Business Object Name	Description
D6-CDReasonCodeLookup	Sensus Connect/Disconnect Reason Code
D6-LoadActionCodeLookup	Sensus Load Action Code
D6-OutageEventTypeLookup	Sensus Outage Event Type
D6-SensusTimeUnits	Sensus Time Units
D6-ServiceTypeMappingLookup	Sensus Service Type Mapping

Using the Sensus Test Harness

Oracle Utilities Smart Grid Gateway Adapter for Sensus RNI includes a test harness that can be configured to simulate a general head-end system for testing the two-way commands. The test harness includes a BPEL composite, web services for standard meter functions, and an XML file that can be used to contain information for one or more meters. See [Using Smart Grid Gateway Test Harnesses](#) for more information.

Silver Spring Networks

The Oracle Utilities Smart Grid Gateway Adapter for Silver Spring Networks supports communication with the Silver Spring Networks UtilityIQ application, including measurement data and device event loading, and command messaging in support of commissioning, connect, disconnect, decommissioning, status check, and on-demand read. The following table describes the attributes of the adapter:

Attribute	Details
Currently Supported Versions	UtilityIQ Version 4.10, 4.12, 4.14, 5.0, 5.1
Protocol	Proprietary
Market(s)	Worldwide
Architecture	RF WAN (mesh) based on Access Points

Silver Spring Networks Adapter Processing

This section provides details concerning the OSB processing, BPEL Processes, and Oracle Utilities Application Framework (OUAF) objects that are supplied as part of the base package. This information illustrates how the base package objects were designed, and can serve as the basis for any customizations you create as part of your implementation.

Initial Measurement Data and Device Event Loading

The initial measurement data load and device event processing use OSB to poll for, parse, and transform the head-payloads into the Oracle Utilities Smart Grid Gateway (SGG) service format. Payloads contain measurements and meter events in some head-end specific format. OSB then places each service call into a Java Message Service (JMS) queue within the Oracle Utilities applications. The JMS client consumes the entries and invokes the respective services in parallel. A service then creates initial measurements with data in a common format with head-end-specific processing as needed. A second service creates device events with data in a common format.

Initial Measurements

The usage data exported from the AMI head-end system as a file in Silver Spring Networks XML format is loaded into Oracle Utilities as initial measurement data. The following OSB projects, delivered in the base product, help manage the usage processing:

1. SGG-D7-SSNXML-BASE contains components responsible for “actual” processing of incoming data. It should not be modified during configuration. This project can be upgraded without affecting the customization and environment settings added to SGG-D7-SSNXML-CM.
2. SGG-D7-SSNXML-CM allows for customization and simplifies future upgrades.

The runtime configuration settings for the SGG-D7-SSNXML-CM project are stored in the xquery file EnvironmentSettings.xq. You can use this file to adjust initial measurement data processing. For example, if you want to load raw data you would specify “true” for the content of the populateRawIMD element.

The following table describes the elements included in the EnvironmentSettings.xq file:

Element	Description	Valid Values
populateRaw	Determines if the initial measurement data is populated as raw data. Valid values are:	true false
callPreProcessing	Determines if the preprocessing proxy service is called. Valid values are:	true false
callPostProcessing	Determines if the postprocessing proxy service is called. Valid values are:	true false

Element	Description	Valid Values
destinationRootElementInterval	Holds the name of inbound web service for the interval IMD seeder.	
destinationRootElementScalar	Holds the name of inbound web service for the scalar IMD seeder. In most cases it is the same as destinationRootElementInterval.	
destinationRootElementEvent	Holds the name of inbound web service for the device event seeder.	
publishServices/service	Specifies the name of the business service within the OSB project used to publish data for external systems (such as Oracle DataRaker).	
filterEvents	Determines if events should be filtered.	true false
filterUsage	Determines if usage should be filtered.	true false

Publishing Initial Measurement Data

The SGG adapter can be configured to publish initial measurement data for use in Oracle DataRaker or other external systems. This functionality is supported through a combination of OSB components and BPEL composites.

Enabling Initial Measurement Data Publishing

Publishing data is enabled by referencing a publisher business service in the publishServices/service element in the EnvironmentSettings.xq file as follows:

```
<publishServices>
  <service>[publisherBusinessService]</service>
</publishServices>
```

The following components provided with the SGG-D7-SSNXML-CM OSB project are used in publishing measurement data to Oracle DataRaker:

- The **DataRakerBusinessService** business service is used to send data to a pre-configured JMS queue (defined as an Endpoint URI), from which the data will be published. This is the business service that should be specified in the EnvironmentSettings.xq file.
- The **DataRakerServiceAccount** service account is used to define and maintain the user name and password needed to access the JMS queue defined in the **DataRakerBusinessService** business service.

Configuring Initial Measurement Publishing Output

The SGGDRIntegration BPEL composite handles publishing the data to Oracle DataRaker or other systems. Initial measurement data is published in the “native” initial measurement data format (the format of the initial measurement seeder business object). This format includes normalized unit of measure and condition codes. See the *Oracle Utilities Smart Grid Gateway Adapter Development Kit Administrative User Guide* for more details about this format.

NOTE: Initial measurement data published through this feature is published prior to validation, estimation, and editing (VEE) processing. In addition, filtering *cannot* be applied to data published through this feature.

The following parameters can be used to configure details of how the data is provided to Oracle DataRaker, including the directory where files are posted for Oracle DataRaker to consume, number of records per file, polling frequency, etc. These parameters are defined during installation. See the *Oracle Utilities Smart Grid Gateway Installation Guide* for more details about defining values for these parameters.

Parameter	Description	Default Value
SGG_DR_INT_QUEUE	JNDI name of queue to publish SGG payloads.	DataRakerQueue

Parameter	Description	Default Value
	This is the JMS queue defined in the DataRakerBusinessService business service. This should NOT be changed.	
SOA_DR_PUBLISH_SIZE	The number of records (SGG payloads) to accumulate in a published file.	100
SOA_DR_FILE_SIZE	The maximum file size for the accumulated (SGG payloads) file in kilobytes.	524288
SOA_DR_ELAPSED_TIME	The period of time in second which, when exceeded, causes a new outgoing file to be created.	600
SOA_DR_POLLING_FREQ	The polling frequency in seconds of the staging directory for new files.	60
SOA_DR_STAGING_DIR	Mount point/directory for the staging directory for accumulated SGG payload files. This is used internally and should NOT be changed.	/spl/sploutput/staging
SOA_DR_INTEGRATION_DIR	Mount point/directory from which Oracle DataRaker will consume the converted XML files.	/spl/sploutput/int

Filtering Initial Measurement Data

The SGG adapter can be configured to filter initial measurement data passed into SGG and the Oracle Utilities Meter Data Management application. Filtering data is enabled by setting the <filterUsage> element in the EnvironmentSettings.xq file to “true” as follows:

```
<filterUsage>true</filterUsage>
```

When filtering is enabled, only measurements whose <externalUOM> matches one of the values defined in the **SSN - UOM Code to Standard UOM Mapping** extendable lookup (D7-HeadendUOMLookup) are passed into the system for processing.

Processing Large Input Files

In some environments, the OSB project may begin processing a large input file before it has been completely copied to the input directory. To prevent this, configure the MinimumAge property in the “InboundProxyService” proxy service for the project. The MinimumAge property specifies the minimum age of files to be retrieved, based on the last modified time stamp. This enables large files to be completely copied to the input directory before they are retrieved for processing.

Prioritized Initial Measurement Processing

The SGG adapter prioritizes processing of initial measurements created from smart meter commands and/or completion events by setting the Execution Method flag in these types of initial measurements to “Real Time” (D1RT). In addition, initial measurements received with the Execution Method flag set to “Real Time” will be processed in real time rather than via batch processing. See **Initial Measurement Data Prioritization** in the *Oracle Utilities Meter Data Management / Smart Grid Gateway Business User Guide* for more information.

Device Events

The device event data exported from the head-end system as a file in Silver Spring Networks CSV format is loaded into Oracle Utilities as a device event. One of your configuration tasks is to customize the device events processing.

The required functionality is delivered in the base product as two OSB projects:

1. SGG-D7-CSV-BASE contains components responsible for “actual” processing of incoming data. It can be upgraded in future without affecting the customization and environment settings that done in SGG-D7-CSV-CM project.
2. SGG-D7-CSV-CM allows the customization and simplifies the future upgrades.

The runtime configuration settings for the SGG-D7-CSV-CM project are stored in the EnvironmentSettings.xq XQuery file. You can use this file to adjust device event data processing. For example, if you want to load raw data you would specify “true” for the content of the populateRaw element.

The following table describes the elements included in the EnvironmentSettings.xq file:

Element	Description	Valie Values
populateRaw	Determines if the device event data is populated as raw data. Valid values are:	true false
callPreProcessing	Determines if the preprocessing proxy service is called. Valid values are:	true false
callPostProcessing	Determines if the postprocessing proxy service is called. Valid values are:	true false
destinationRootElement	Holds the name of inbound web service for the device event seeder.	
publishServices/service	Specifies the name of the business service within the OSB project used to publish data for external systems (such as Oracle DataRaker).	
filterEvents	Determines if events should be filtered. Valid values are:	true false

Publishing Events

The Silver Spring Networks adapter can be configured to publish device events for use in Oracle DataRaker or other external systems. This functionality is supported through a combination of OSB components and BPEL composites.

Enabling Device Event Publishing

Publishing data is enabled by referencing a publisher business service in the publishServices/service element in the EnvironmentSettings.xq file as follows:

```
<publishServices>
  <service>[publisherBusinessService]</service>
</publishServices>
```

The following components provided with the SGG-D7-CSV-CM OSB project are used in publishing device events data to Oracle DataRaker:

- The **DataRakerBusinessService** business service is used to send data to a pre-configured JMS queue (defined as an Endpoint URI), from which the data will be published. This is the business service that should be specified in the EnvironmentSettings.xq file.
- The **DataRakerServiceAccount** service account is used to define and maintain the user name and password needed to access the JMS queue defined in the **DataRakerBusinessService** business service.

Configuring Device Event Publishing Output

The SGGDRIntegration BPEL composite handles publishing the data to Oracle DataRaker or other systems. Device event data is published in the “native” device event data format (the format of the device event seeder business object). This format includes normalized device event codes. See the *Oracle Utilities Smart Grid Gateway Adapter Development Kit Administrative User Guide* for more details about this format.

NOTE: In addition, filtering can NOT be applied to device events published via this feature.

The following parameters can be used to configure details of how the data is provided to Oracle DataRaker, including the directory where files are posted for Oracle DataRaker to consume, number of records per file, polling frequency, etc. These parameters are defined during installation. See the *Oracle Utilities Smart Grid Gateway Installation Guide* for more details about defining values for these parameters.

Parameter	Description	Default Value
SGG_DR_INT_QUEUE	JNDI name of queue to publish SGG payloads. This is the JMS queue defined in the DataRakerBusinessService business service. This should NOT be changed.	DataRakerQueue
SOA_DR_PUBLISH_SIZE	The number of records (SGG payloads) to accumulate in a published file.	100
SOA_DR_FILE_SIZE	The maximum file size for the accumulated (SGG payloads) file in kilobytes.	524288
SOA_DR_ELAPSED_TIME	The period of time in second which, when exceeded, causes a new outgoing file to be created.	600
SOA_DR_POLLING_FREQ	The polling frequency in seconds of the staging directory for new files.	60
SOA_DR_STAGING_DIR	Mount point/directory for the staging directory for accumulated SGG payload files. This is used internally and should NOT be changed.	/spl/sploutput/staging
SOA_DR_INTEGRATION_DIR	Mount point/directory from which Oracle DataRaker will consume the converted XML files.	/spl/sploutput/int

Filtering Events

The SGG adapter can be configured to filter initial measurement data passed into SGG and the Oracle Utilities Meter Data Management application. Filtering data is enabled by setting the <filterUsage> element in the EnvironmentSettings.xq file to “true” as follows:

```
<filterEvents>true</filterEvents>
```

When filtering is enabled, only device events whose <externalEventName> matches one of the values defined in the **SSN - Device Event Mapping** extendable lookup (D7-DeviceEventMappingLookup) are passed into the system for processing.

Prioritized Device Event Processing

The SGG adapter prioritizes processing of device events created from smart meter commands and/or completion events by setting the Execution Method flag in these types of device events to “Real Time” (DIRT). In addition, device events received with the Execution Method flag set to “Real Time” will be processed in real time rather than via batch processing. See **Device Event Prioritization** in the *Oracle Utilities Meter Data Management / Smart Grid Gateway Business User Guide* for more information.

Configuring Payload Processing Notifications

By default, Payload Statistics, Payload Error Notification, and Payload Summary notification activities are sent to the Notification Queue within Oracle Service Bus. Smart Grid Gateway adapters can be configured to restrict sending these

activities by defining optional JCA transport dynamic properties in the appropriate OSB project. The following optional JCA transport dynamic properties can be used to control if these notification activities are sent:

- **SGG_SEND_STATISTICS**: Controls sending Payload Statistic activities (true: send, false: do not send)
- **SGG_SEND_ERROR**: Controls sending Payload Error Notification activities (true: send, false: do not send)
- **SGG_SEND_SUMMARY**: Controls sending Payload Summary activities (true: send, false: do not send)

When these properties are set to false, the corresponding payload notification will not be sent to the JMS Queue. Note these properties are not populated by default, and default to true if omitted.

To create these properties:

1. Navigate to the SGG-D7-CSV-CM project in the Oracle Service Bus Console.
2. Expand the **Proxy Services** folder.
3. Select the **InboundProxyService** proxy service (not the Pipeline or WSDL).
4. Click **Create** to create a new session.
5. Select **Transport Details**.
6. Click the plus sign in the **Dynamic EndPoint Properties** section. An empty row will appear.
7. Enter the property you wish to define in the **Property** column.
8. Enter "false" in the **value** column.
9. Repeat steps 6-8 for each property you wish to define.
10. Click **Activate** to save and activate your changes.

NOTE: These properties are only used if the SGG_EXT_ID_PATTERN is not present or the regular expression captures nothing. The SGG_EXT_ID_PATTERN will override these properties when the regular expression captures group data.

Base Package Business Objects

The Silver Spring Networks adapter base package includes the following device and initial measurement business objects:

Business Object Name	Description
D7-InitialLoadIMDInterval	SSN - Initial Load IMD - Interval Used when loading Silver Spring Network (SSN) interval measurements into the system for the first time.
D7-InitialLoadIMDScalar	SSN - Initial Load IMD - Scalar Used when loading Silver Spring Network (SSN) scalar measurements into the system for the first time.
D7-SmartMeter	SSN — Smart Meter

Device Communication

The basic communication for all business processing is essentially the same. A communication request is sent from the Oracle Utilities application to the head-end system. This request would be for a connect/disconnect, commission/decommission, measurement data, an on-demand read, or another type of request that the head-end system supports. The designated BPEL process transforms the request from Oracle Utilities format to MultiSpeak format and invokes the related web service from the head-end system. The head-end system then returns a reply, and the BPEL process transforms the reply message back to the appropriate format so that Oracle Utilities can receive the response.

Communication Flows

The table below lists the communications created for each Silver Spring Networks command:

Command	Outbound Communication	Inbound Communication	Completion Event
Remote Connect	SSN-Connect or Disconnect	SSN – Connect or Disconnect Response Remote Provisioning Job (Get Status)	Connect Device Completion Event
Remote Disconnect	SSN-Connect or Disconnect	SSN – Connect or Disconnect Response	Disconnect Device Completion Event
Device Commissioning (see Note below)	SSN- Replace Location		Device Commissioning Completion Event
Device Decommissioning	SSN- Replace Device At Location (Decomm)		Device Decommissioning Completion Event
On-Demand Read (Scalar)	SSN – Add Meter Read Job (Scalar)	SSN – Meter Read Response (Scalar)	Create IMD Completion Event
On-Demand Read (Interval)	SSN – Add Meter Read Job (Interval)	SSN – Meter Read Response (Interval)	Create IMD Completion Event
Device Status Check	SSN – Add Ping job	SSN – Ping Job Response	

NOTE: Service points must be provisioned in the Silver Spring Networks (Itron AMM) system before the Device Commissioning command can be used.

Unit of Measure Filtering for On-Demand Reads

Readings returned via On-Demand Read commands are filtered on the combination of Unit of Measure/Time of Use/Service Quantity Identifiers (UOM/TOU/SQI) configured for the device and measuring component. When filtering is enabled, only readings that match a configured UOM/TOU/SQI combination are processed. All others are filtered out.

Filtering is enabled by default via the “Opt Out Of Filtering” parameter (set to "false" by default) on the D7-CCOMPEV (Create Completion Event Scalar) algorithm on the Create Completion Events status of the D7-MeterReadResponseScalar (SSN - Meter Read Response (Scalar)) business object (for scalar on-demand read commands), and/or on the D7-CCOMPEVIN (Create Completion Event Interval) algorithm on the Create Completion Events status of the D7-MeterReadResponseInterval (SSN - Meter Read Response (Interval)) business object (for interval on-demand read commands).

When filtering is enabled, the “Filter if invalid external MC identifier” parameter on the D7-CCOMPEV and D7-CCOMPEVIN algorithms controls what should happen if a measuring component cannot be found using the MC Identifier Number sent from the head end system. When set to 'Yes' and no measuring component is found, the initial measurement will be filtered. When set to 'No' and no measuring component is found, the system will attempt to find the measuring component using the UOM and TOU. The value of the “Filter if invalid external MC identifier” on these algorithms must match the value of the “Error if invalid external MC identifier” parameter on the D1-DER-SPRMC algorithm on the IMD Seeder (D1-IMDSeeder) business object. The parameters should both be set to either "yes" or "no".

The D7-VALDVCFLS (SSN - Check if Device has any Filtering errors (Scalar)) algorithm on the Validate status of the D7-MeterReadResponseScalar (SSN - Meter Read Response (Scalar)) business object is used to check for errors related to filtering for scalar on demand read commands. The value of the “Opt Out Of Filtering” parameter on this algorithm must match the value of the parameter on the D7-CCOMPEV algorithm. The parameters should both be set to either "false" (the default) or "true" (if filtering is to be disabled). The value of the “Filter if invalid external MC identifier” on this algorithm must match the value of the “Error if invalid external MC identifier” parameter on the D1-DER-SPRMC algorithm on the IMD Seeder (D1-IMDSeeder) business object. The parameters should both be set to either "yes" or "no".

The D7-VALDVCFLI (SSN - Check if Device has any Filtering errors (Interval)) algorithm on the Validate status of the D7-MeterReadResponseInterval (SSN - Meter Read Response (Interval)) business object is used to check for errors related to filtering for interval on demand read commands. The value of the “Opt Out Of Filtering” parameter on this algorithm must match the value of the parameter on the D7-CCOMPEVIN algorithm. The parameters should both be set to either "false" (the default) or "true" (if filtering is to be disabled). The value of the “Filter if invalid external MC identifier” on this algorithm must match the value of the “Error if invalid external MC identifier” parameter on the D1-DER-SPRMC algorithm on the IMD Seeder (D1-IMDSeeder) business object. The parameters should both be set to either "yes" or "no".

Device Communication Base Package Business Objects

The Silver Spring Networks Adapter base package includes the following communication business objects:

Business Object Name	Description
D7-AddMeterReadJobInterval	SSN - Add Meter Read Job (Interval)
D7-AddMeterReadJobScalar	SSN - Add Meter Read Job (Scalar)
D7-AddPingJob	SSN - Add Ping Job
D7-ConnectDisconnect	SSN - Connect or Disconnect
D7-ConnectDisconnectResp	SSN - Connect or Disconnect Response
D7-GetStatus	SSN - Get Status
D7-GetStatusResponse	SSN - Get Status Response
D7-MeterReadResponseInterval	SSN - Meter Read Response (Interval)
D7-MeterReadResponseScalar	SSN - Meter Read Response (Scalar)
D7-PingJobResponse	SSN - Ping Job Response
D7-ReplaceDeviceAtLocForDecomm	SSN - Replace Device At Location (Decomm)
D7-ReplaceLocation	SSN - Replace Location

Silver Spring Networks Event Data Mapping

The Silver Spring event file format maps as follows into the business object, D1-DeviceEventMappingLookup:

Silver Spring Flat File Field	Device Event Seeder BO Element	Comments
Transaction ID (from Header record)	External Source Identifier	This is the file name.
Device Identifier	External Device Identifier	
Event Name	External Event Name	
Event Creation Date/Time	Event Date/Time	
Device Type	External Device Type	This element has no real bearing on the device type within MDM/SGG. Its valid values include (although the element itself is free-form): Meter Collector Router
Service Location ID	External Service Location ID	
Communication Module Serial Number	External Communication Module Identifier	
Event Category ID	External Event Category	
Event Severity	External Event Severity	Valid values include (although the element itself is free-form): Alert Information
Status Value	External Status Value	This represents additional information that relates to the event itself.
Status Date/Time	External Status Date/Time	The date & time at which the additional information referenced above had occurred.

External System

You must create an External System for each external system to which Oracle Utilities Smart Grid Gateway will send messages. Each external system defines a set of outbound message types that will be sent to that system. Each external system outbound message type also specifies the following:

- The processing method used to send the message (Batch or Real-time)
- The corresponding message senders
- Batch Control (if Processing Method is set to Batch)
- Message XSL, W3C Schema, and Response XSL (as applicable)

Outbound Message Types

Acknowledgment and response messages are sent and received validating that commands have been transmitted.

Outbound Message Type	Description
D7-COMMS	Replace Device At Location
D7-OB MSG TY	Outbound Message Type SSN

Inbound/Outbound Service Configuration

The inbound/outbound message utility allows you to configure your system to receive information from and to send information to external applications using XML. The Oracle Utilities Smart Grid Gateway uses one inbound web service to map device events. This is the same inbound web service used by the D1 application.

Inbound web services

Inbound web services define the details of how messages are received from an external system, including the inbound communication business object (or business service or service script) to be invoked when the response message is received. As in the case of inbound communication business objects, the set of inbound web services you need to create is based on the types of messages the system is designed to send.

The Oracle Utilities Smart Grid Gateway adapter for Silver Spring Networks includes the following inbound web services:

Inbound Web Service	Description
D1-BulkRequestHeader	Bulk Request Header
D1-BulkRequestUpdate	Bulk Request Update
D1-BulkResponse	Bulk Response
D1-DeviceEventSeeder	Used for upload of device events. The Device Event Seeder business object serves as a means of adding device events both from outside the application and from online. Its pre-processing algorithms determine the device event type - which in turn defines the device event BO that should be used to create the device event. If a device event type can't be determined, the device event is created using this BO. Such a device event can then be re-processed - and if successful, a new device event is created.
D1-DeviceStatusCheck	Device Status Check This service is invoked by the integration layer to instantiate a Device Status Check command.
D1-InitialLoadIMD	Used by OSB to instantiate an IMD The IMDSeeder business object is used to determine the type of initial measurement business object to instantiate when receiving usage readings from a head-end system.
D1-RemoteConnect	Remote Connect

Inbound Web Service	Description
	This service is invoked by the integration layer to instantiate a Remote Connect command.
D1-RemoteDisconnect	Remote Disconnect This service is invoked by the integration layer to instantiate a Remote Disconnect command.
D7-ConnectDisconnectResponse	Connect Disconnect Response Retrieves response for Remote provisioning Job Connect or Disconnect commands.
D7-GetStatusResponse	D7-GetStatusResponse Retrieve response from the Get Status command.
D7-MeterReadResponseInterval	SSN - Meter Read Response (Interval)
D7-MeterReadResponseScalar	SSN - Meter Read Response (Scalar)
D7-PingJobResponse	SSN - Ping Response Retrieves response from the Ping Job Response command.

Message Senders

Message senders define the details of how messages are sent to an external system. As in the case of outbound communication business objects and outbound message types, the set of message senders you need to create is based on the types of messages the system is designed to accept.

BPEL Processes

These processes are responsible for performing the conversion from Oracle Utilities format to Silver Spring Networks format, invoking process callouts and invoking the remote endpoint to trigger the device events.

OnDemandRead Composite Process — Provides access points to edge application and handles data between edge application and head end system. It invokes sequence of web methods to head end system and retrieves meter read and send it back to Edge application.

ConnectDisconnect Composite Process — Performs the conversion from Oracle Utilities format to SSN format, invokes process callouts, and invokes the remote endpoint to trigger the connect event. A second, asynchronous reply will call back into the OUAF layer when the status change is completed at the head-end system. Another asynchronous reply will call back into the OUAF layer to send Meter Read Results.

CommissionDecommission Composite Process — Performs the conversion from Oracle Utilities format to SSN UIQ format, invokes process callouts, and invokes the remote endpoint to trigger the commission or decommission of meter.

DeviceStatusCheck Composite — Performs the conversion from Oracle Utilities format to SSN format, invokes process callouts, and makes a call via a proxy to the head-end system starting the Meter Ping operation. In an ideal scenario, the job status is returned as completed and the results are acquired and sent back to OUAF. If the job takes longer, OUAF will initiate a second request that will poll the head end system for the job status. When the job is completed, the results are returned to OUAF.

Common Composite — Contains two main classes of operations: Proxies and ProcessCallouts. Proxies are simple mediators that forward a web service call to a preset endpoint. No transformations are performed. They are convenient because they allow head end URLs and security to be set in a single composite. ProcessCallouts are points of customization which allow users to modify data and/or initiate some external business process.

BulkRequest Composite — Provides access points to requesting application. It decouples the bulk request into single commands for each meter/device in the request and sends it to edge application for processing.

Web Services

The following web services are all defined in the Silver Spring Networks head-end system:

- **CommissionDecommissionService**
 - **BPEL Process:** CommissionDecommission
 - **Operation:** ReplaceDeviceAtLocation
 - **Endpoint URL:** http://<EM_SERVER>:<EM_SERVER_PORT>/soa-infra/services/SSN/CommissionDecommission/CommissionDecommissionService
- **CommissionDecommissionService**
 - **BPEL Process:** CommissionDecommission
 - **Operation:** ReplaceLocation
 - **Endpoint URL:** http://<EM_SERVER>:<EM_SERVER_PORT>/soa-infra/services/SSN/CommissionDecommission/CommissionDecommissionService
- **ConnectDisconnectService**
 - **BPEL Process:** ConnectDisconnect
 - **Operation:** AddRemoteProvisioningJob
 - **Endpoint URL:** http://<EM_SERVER>:<EM_SERVER_PORT>/soa-infra/services/SSN/ConnectDisconnect/ConnectDisconnectService
- **DeviceStatusCheckService**
 - **BPEL Process:** DeviceStatusCheck
 - **Operation:** AddPingJob
 - **Endpoint URL:** http://<EM_SERVER>:<EM_SERVER_PORT>/soa-infra/services/SSN/DeviceStatusCheck/DeviceStatusCheckService
- **AddMeterReadJobService**
 - **BPEL Process:** AddMeterRead
 - **Operation:** AddMeterReadJob
 - **Endpoint URL:** http://<EM_SERVER>:<EM_SERVER_PORT>/soa-infra/services/SSN/OnDemandRead/AddMeterReadJobService
- **OnDemandReadService**
 - **BPEL Process:** OnDemandRead
 - **Operation:** GetJobStatus
 - **Endpoint URL:** http://<EM_SERVER>:<EM_SERVER_PORT>/soa-infra/services/SSN/OnDemandRead/OnDemandReadService

Silver Spring Networks Utility IQ Web Services

The following table describes the Silver Spring Networks Utility IQ web services and operations used for the Oracle Utilities Smart Grid Gateway command messaging:

Smart Grid Gateway Command	AMI Adapter Business Objects	Silver Spring Networks Web Services	Silver Spring Networks Operations
Device Commissioning	D7-ReplaceLocation	Device Manager	findDevice ReplaceLocation

Smart Grid Gateway Command	AMI Adapter Business Objects	Silver Spring Networks Web Services	Silver Spring Networks Operations
Device Decommissioning	D7-ReplaceDeviceAtLocForDecomm	Device Manager	findDevice
			ReplaceDeviceAtLocation
Remote Connect/ Remote Disconnect	D7-ConnectDisconnect D7-GetStatus	Device Manager Job Manager DeviceResults	findDevice
			addRemoteProvisioningJob
			getJobStatusForDevice
			getRemoteProvisioningResultsByJobID
			findJob
Device Status Check	D7-AddPingJob	Device Manager Job Manager DeviceResults	findDevice
			addPingJob, getJobStatus
			getPingResultsByJobID
On-Demand Read	D7-AddMeterReadJobInterval D7-AddMeterReadJobScalar	Device Manager Job Manager DeviceResults	findDevice
			addMeterReadJob
			getJobStatus
			getMeterReadResultsByJobID

Configuring a Silver Spring Networks Head-End System

This section outlines the configuration required for the Oracle Utilities Smart Grid Gateway Adapter for Silver Spring Networks to communicate with the Silver Spring Networks UtilityIQ.

Inbound Web Services

Inbound web services define the details of how messages are received from an external system. This includes incoming usage and device events, as well as messages sent from the Silver Spring Networks UtilityIQ application in response to a command request.

The following inbound web services must be configured in your system. If these are not present in your configuration, add them. Refer to the Oracle Utilities Application Framework documentation for more information about creating inbound web services.

Inbound Web Service Name	Description
D1-BulkRequestHeader	Bulk Request Header
D1-BulkRequestUpdate	Bulk Request Update
D1-BulkResponse	Bulk Response
D1-DeviceEventSeeder	Device Event Seeder
D1-DeviceStatusCheck	Device Status Check
D1-InitialLoadIMD	Used by OSB to instantiate an IMD
D1-PayloadErrorNotif	Payload Error Notification
D1-PayloadStatistics	Payload Statistics
D1-PayloadSummary	Payload Summary
D7-ConnectDisconnectResponse	Connect Disconnect Response
D7-GetStatusResponse	Get Status Response

Inbound Web Service Name	Description
D7-MeterReadResponseInterval	SSN - Meter Read Response (Interval)
D7-MeterReadResponseScalar	SSN - Meter Read Response (Scalar)
D7-PingJobResponse	SSN - Ping Response

Note: The following apply to all of the above inbound web services:

Message Options

- **Trace:** No
- **Debug:** No
- **Active:** Yes

Operations

- **Operation Name:** Same as web service name
- **Schema Type:** Business Object
- **Schema Name:** Applicable business object code
- **Transaction Type:** Add

Message Senders

Message senders define the details of how messages are sent to an external system, such as messages containing device command requests. An message sender should be configured for each command.

The following message senders must be configured in your system. If these are not present in your configuration, add them. Refer to the Oracle Utilities Application Framework documentation for more information about creating message senders.

Message Sender	Description
D7-DECOMM	SSN Replace Device at Location for Decommission
D7-COMM	SSN Replace Location - Commission
D7-ADDJOB	SSN Add Meter Read Job
D7-ADDPING	SSN Add Ping Job
D7-CONNECT	SSN Connect Device
D7-GTSTATUS	SSN Get Status

Note: The following apply to all of the above message senders:

Main Tab:

- **Invocation Type:** Real-time
- **Message Class:** RTHTTPSND (Sender routes message via HTTP real-time)
- **MSG Encoding:** UTF-8 message encoding

Context Tab:

- **HTTP Header:** SOAPAction:http://xmlns.oracle.com/ouaf/ssn/<OPERATION>
- **HTTP Login User:** <USER_ID>
- **HTTP Login Password:** <PASSWORD>
- **HTTP Method:** POST
- **HTTP URL 1:** http://<EM_SERVER>:<EM_SERVER_PORT>/soa-infra/services/SSN/<SERVICE>
- where:
- **<OPERATION>**: the operation performed by the message sender (see Operation column in the table above)

- **<USER_ID>**: the user ID used to log into WebLogic Enterprise Manager
- **<PASSWORD>**: the password used to log into WebLogic Enterprise Manager
- **<EM_SERVER_IP>**: the machine name or IP address of server where the WebLogic Enterprise Manager is installed
- **<EM_SERVER_PORT>**: the port where the WebLogic Enterprise Manager is installed
- **<SERVICE>**: the service invoked by the message sender (see Service column in the table above)

Outbound Message Types

Outbound message types define specific types of messages sent to an external system, such as messages containing device command requests.

The following outbound message types must be configured in your system. If these are not present in your configuration, add them. Refer to the Oracle Utilities Application Framework documentation for more information about creating outbound message types.

Outbound Message Type	Description
D7-COMMS	Replace Device At Location
D7-OB MSG TY	Outbound Message Type SSN

Note: The following apply to all of the above outbound message types:

- **Business Object:** D1-OutboundMessage (Outbound Message)
- **Priority:** Priority 50

External System

External systems represent external applications with which the Smart Grid Gateway will exchange messages or data. In the case of the Smart Grid Gateway adapters, external systems represent the head-end systems with which the adapters communicate.

An external system that represents the Silver Spring Networks UtilityIQ must be present in your system. If this is not present in your configuration, add it, along with the following Outbound Message Types. Refer to the Oracle Utilities Application Framework documentation for more information about creating external systems.

External System - Silver Spring Networks:

- **External System:** Silver Spring Networks
- **Description:** Silver Spring Networks
- **Outbound Message Types:**

Outbound Message Type	Description
D7-OB MSG TY	Outbound Message Type SSN

Note: The following apply to all of the above outbound message types:

- **Processing Method:** Real-time
- **Message XSL:** D7-Request.xsl
- **Response XSL:** D7-Response.xsl

Service Provider

Service providers represent external entities that serve various roles relative to the application, including head-end systems, billing systems to which the application sends bill determinant data, market participants in a deregulated environment, outage management systems that receive meter event data from the application, or other parties that require or provide

information to the system. The head-end systems that collect and send measurement data and meter events to the application are defined as service providers.

A service provider that represents the Silver Spring Networks UtilityIQ must be present in your system. If this is not present in your configuration, add it. Refer to the Oracle Utilities Service and Measurement Data Foundation documentation for more information about creating service providers.

Service Provider - Silver Spring Networks:

- **Service Provider:** Silver Spring Networks
- **Description:** Silver Spring Networks
- **External Reference ID:** Silver Spring Networks
- **External System:** Silver Spring Networks
- **Our Name/ID in Their System:**
- **AMI Device ID Type:** Internal Meter Number
- **Pre-Commissioning Device ID Type:**
- **AMI Measuring Component ID Type:** Channel ID

Processing Methods

Processing methods define the format or means by which a service provider receives and/or sends data from and/or to the application, including as bill determinants, usage data, or device events. Processing methods are also used to define how to create information internal to the application such as initial measurement data and device events. Processing methods can also be used to define how command requests are sent to a given head-end system.

The following types of processing methods must be configured for the Silver Spring Networks service provider. Refer to the Oracle Utilities Service and Measurement Data Foundation documentation for more information about configuring processing methods.

Initial Measurement Creation

Initial measurement creation processing methods define the business objects used to create initial measurements. The IMD Seeder inbound web service uses this processing method to determine which type of initial measurement business object to instantiate when receiving usage from a head-end system.

Device Event Mapping

Device event mapping processing methods define how head-end-specific device events are mapped to standard device event names. The Device Event Seeder inbound web service uses this processing method to determine which type of device event business object to instantiate when receiving device events from a head-end system.

Commands

Command processing methods define how command requests are sent to a head-end system. More specifically, they define the type of outbound communication business object to create for each type of command, and the outbound message type to send to the head-end system.

The following types of command processing methods can be configured for the Silver Spring Networks service provider, based on the requirements of each implementation using the “How to Create OB COMM/Send OB Message” processing method business object (D1–HowToCreateActivityOBComm).

Command	Processing Role	Default Business Object	Default Outbound Message Type
Device Commission	Device Registration	D7-ReplaceLocation	Commission

Command	Processing Role	Default Business Object	Default Outbound Message Type
Device Decommission	Device Removal	D7- ReplaceDeviceAtLocForDecomm	Decommission
Device Status Check	Device Status Check	D7-AddPingJob	Get Status
On-Demand Read (Scalar)	On-Demand Read (Scalar)	D7-AddMeterReadJobScalar	Read Meter Data
On-Demand Read (Interval)	On-Demand Read (Interval)	D7-AddMeterReadJobInterval	Read Meter Data
Remote Connect	Remote Connect	D7-ConnectDisconnect	Connect Device
Remote Disconnect	Remote Disconnect	D7-ConnectDisconnect	Disconnect Device

Configuring Endpoint URIs

Part of the configuration process is configuring your BPEL composites to work with your head-end system by defining the appropriate Endpoint URIs for each of the commands. The default approach to defining Endpoints URIs is redeployment or reinstallation of the BPEL composites. For example, by default, changing an adapter from using the test harness to a production environment using the actual head-end system requires editing the appropriate installation menu options and redeploying the BPEL composites. The Endpoints URIs defined during installation and deployment for each adapter are listed in the **Smart Grid Gateway Installation and Configuration Worksheets** section of the *Oracle Utilities Smart Grid Gateway Installation Guide*.

You can also use an “Endpoint Override” Domain Value Map (DVM) to override Endpoint URIs defined during deployment and installation. This DVM allows defining specific keys that provide an alternate URL that will override the original installed value. Endpoint Override DVMs can be edited using the Oracle SOA Composer.

The Silver Springs Network endpoint override DVM (D7-EndpointOverrides.dvm) uses a specific set of keys, each used for one or more commands. The table below lists the DVM keys available for the Silver Springs Network adapter and the command used with each:

DVM Key	Commands
DeviceResults4.4	Remote Connect
DeviceResults4.7	Remote Disconnect
DeviceResults4.10	On-Demand Read (Scalar) On-Demand Read (Interval) Device Status Check
DataAggregation4.4	Not used in this version.
DataAggregation4.7	
DataAggregation4.10	
DeviceManager4.4	Device Commissioning
DeviceManager4.7	Device Decommissioning
DeviceManager4.10	Remote Connect Remote Disconnect On-Demand Read (Scalar) On-Demand Read (Interval) Device Status Check
JobManager4.4	Remote Connect
JobManager4.7	Remote Disconnect
JobManager4.10	On-Demand Read (Scalar) On-Demand Read (Interval) Device Status Check

NOTE:

The numbers in the keys above (4.4, 4.7, and 4.10) designate the version of the Silver Springs Network IQ head-end system.

Only a single version of each key should be defined, based on the version of the Silver Springs Network IQ head-end system

To define an override Endpoint URI for the Silver Springs Network adapter, use the following procedure:

1. Open the SOA Composer for your BPEL configuration.

The URL for the SOA Composer is `http://server:port/soa/composer`.

2. Select the `D7-EndpointOverrides.dvm` in the left panel.

- In Fusion Middleware v12.2.1, this is located under **Shared** in the **Deployment View**, or under **Domain Value Maps** in the **Types View**.
- In Fusion Middleware v12.2.2, this is located under **Metadata** in the **Deployment View**.

The DVM will open in the right panel. The **Description** field lists the available keys for the DVM (only the first key is shown, but you can scroll through the contents to view the list. The panel also displays a list of previously defined keys.

3. Click the **Create Session** button (above the left panel) to begin an editing session.

4. Click the **Add Domain Values** icon (“+”) to add a new key.

The **Add Domain Values** dialog opens.

5. Enter the appropriate values in the **Add Domain Values** dialog as follows:

- **key**: The DVM key for the Endpoint URI you wish to define (see the table above).
- **EndpointURI**: The override Endpoint URI.

6. Click **OK**.

The new DVM value will appear in the list of keys.

7. Click the **Save** icon to save the DVM values.

8. Click the **Publish** button to activate all the changes in the editing session.

Enter an optional note for the session in the **Publish Session** dialog.

Changes take effect immediately upon publishing the session.

Click **Discard** to discard your changes.

Click **Exit** to exit your current session. Note that your session will still be open if you exit. Use **Discard** to end your session without making changes.

Configuring Silver Spring Networks Extendable Lookups

NOTE: This section applies to **both** middleware and native implementations of the Smart Grid Gateway Adapter for Silver Spring Networks.

This section outlines some of the extendable lookups that must be configured for use with the Silver Spring Networks adapter. Refer to the Oracle Utilities Application Framework documentation for more information about working with extendable lookups.

Device Event Mapping

The Device Event Mapping extendable lookup is used to determine which type of device event business object to instantiate when receiving device events from the head-end system. Each value defined for the Device Event Mapping extendable lookup should include the following:

- **Head-End System Event Name:** The event name used by the head-end system.
- **Description:** A description of the device event.
- **Status:** The status of the lookup value (can be Active or Inactive).
- **Standard Event Name:** The standard event name for device events of this type, from the “Standard Event Name” extendable lookup.

UOM Code to Standard UOM Mapping

Usage received from a utility’s head-end system may use utility-specific unit of measures (UOMs). These custom UOMs must be mapped to standard UOM codes. The UOM Code to Standard UOM Mapping extendable lookup is used for this purpose. Each value defined for the UOM Code to Standard UOM Mapping extendable lookup should include the following:

- **Head-End Unit of Measure:** The unit of measure code used by the head-end system.
- **Description:** A description of the unit of measure code.
- **Status:** The status of the lookup value (can be Active or Inactive).
- **Unit of Measure:** The unit of measure defined in the system.

Interval Status Code to Condition Mapping

Interval usage received from the Silver Spring Networks UtilityIQ can include Silver Spring Networks interval status codes that indicate the status or condition of the interval value. These interval status codes must be mapped to standard condition codes in the system. The Silver Spring Networks Interval Status Code to Condition Mapping extendable lookup is used to determine how to map Silver Spring Networks interval status codes to standard status codes when receiving usage from the Silver Spring Networks UtilityIQ.

Each value defined for the Silver Spring Networks Interval Status Code to Condition Mapping extendable lookup should include the following:

- **Interval Status:** The Silver Spring Networks interval status code
- **Description:** A description of the interval status code.
- **Status:** The status of the lookup value (can be Active or Inactive)
- **Condition:** The condition code to which the interval status code is to be mapped, from the Measurement Condition extendable lookup.

Other Extendable Lookups

Business Object Name	Description
D7-ActivationStatusLookup	SSN - Activation Status
D7-ChannelStatusLookup	SSN - Channel Status
D7-DataTimeZoneLookup	SSN - Data Time Zone
D7-DeviceStatusLookup	SSN - Device Status
D7-ExecutionStatusLookup	SSN - Execution Status
D7-HeadendSQLLookup	SSN - Head-End SQL to Standard SQL

Business Object Name	Description
D7-HeadendTOULookup	SSN - Head-End TOU to Standard TOU
D7-IntervalStatusLookup	SSN - Interval Status
D7-MeterConnectionStatusLookup	SSN - Meter Connection Status
D7-MeterReadTypeLookup	SSN - Meter Read Type
D7-OldAdminStateNameLookup	SSN - Old Admin State Name
D7-PriorityLookup	SSN - Priority Status
D7-ProvisioningActionLookup	SSN - Provisioning Action
D7-ProvisioningCommandStatus	SSN - Provisioning Command Status
D7-ProvisioningDataType	SSN - Provisioning Data Type
D7-ReadModeLookup	SSN - Read Mode
D7-RegisterReadSourceLookup	SSN - Register Read Source
D7-RegisterStatusLookup	SSN - Register Status
D7-SSNVersionLookup	SSN - Version
D7-StatusFlagNameLookup	SSN - Status Flag Name

Using the Silver Spring Networks Test Harness

Oracle Utilities Smart Grid Gateway Adapter for Silver Spring Networks (SSN) includes a test harness that can be configured to simulate the Silver Spring Networks UtilityIQ head-end system for testing the two-way commands. The test harness includes a BPEL composite, web services for standard meter functions, and an XML file that can be used to contain information for one or more meters. See [Using Smart Grid Gateway Test Harnesses](#) for more information.

Using Smart Grid Gateway Middleware Test Harnesses

The Oracle Utilities Smart Grid Gateway Adapter includes middleware test harnesses for each supported head end system. The test harnesses can be configured to simulate a head-end system for initial testing of one-way or two-way commands. The test harnesses are Multispeak 3.0 standard compliant and include a BPEL composite, web services for standard meter functions, and an XML file that can be used to contain information for one or more meters. This section describes the general components of the test harnesses.

NOTE: This section applies to middleware implementations of Oracle Utilities Smart Grid Gateway **only**. This section does NOT apply to native implementations or Oracle Utilities cloud services. See [Smart Grid Gateway Adapter Native Implementations](#) for more information about Smart Grid Gateway Adapter native implementations and implementing Smart Grid Gateway adapters with Oracle Utilities cloud services.

Test Harness Design

Each test harness is divided into two main layers: a front end and back end layer. The front end set of services implements the head-end system interfaces, which receive requests corresponding to the specifications shown in the list below. Each of these services calls into the "back end" layer of the test harness, which defines meters and sets their attributes. These meters are stored in a file within the test harness called meterdb.xml.

NOTE: The meterdb.xml file can be modified pre-deployment, but not post-deployment. However, the test harness retains an in-memory "database" of the meters in the file. The in-memory representation can be modified using the

utility web services. Note that any changes to the in- memory structure will be lost when the server is restarted or the test harness composite is redeployed.

Itron OpenWay

- [www.itron.com.ami.2008.10.control](#)
 - ReconnectMeter
 - GetReconnectMeterResult
 - DisconnectMeter
 - GetDisconnectMeterResult
- [www.itron.com.ami.2008.10.data](#)
 - ContingencyReadByEndpoint
 - GetContingencyReadByEndpointResult
 - InterrogateByGroup
 - GetInterrogateByGroupResult
- [www.itron.com.ami.2008.10.control](#)
 - PingByEndpoints
 - ReconnectMeter
 - GetReconnectMeterResult
 - DisconnectMeter
 - GetDisconnectMeterResult
- [www.itron.com.ami.2012.03.control.diagnostic](#)
 - PingByEndpoints
 - GetPingByEndpointsResult
- [www.itron.com.ami.2009.08.provisioning](#)
 - AddMeterDefinitions
 - DeregisterMeters

Landis+Gyr

- http://www.multispeak.org/Version_3.0 MR_CB (Meter Reading_Customer Billing)
 - MeterAddNotification
 - MeterRemoveNotification
 - InitiateMeterReadByMeterNumber
- http://www.multispeak.org/Version_3.0 CD_CB (Connect/Disconnect_Customer Billing)
- InitiateConnectDisconnect

The LG Harness will send below responses to corresponding BPEL composites:

- http://www.multispeak.org/Version_3.0 CB_MR (Customer Billing_Meter Reading)
- ReadingChangedNotification
- http://www.multispeak.org/Version_3.0 CB_CD (Customer Billing_Connect/Disconnect)
- CDStateChangedNotification

Sensus RNI

- [http://www.multispeak.org/Version_4.1_Release MR_Server](http://www.multispeak.org/Version_4.1_Release_MR_Server)
 - MeterAddNotification
 - MeterRemoveNotification
 - InitiateMeterReadingsByMeterID
- [http://www.multispeak.org/Version_4.1_Release CD_Server](http://www.multispeak.org/Version_4.1_Release_CD_Server)
 - InitiateConnectDisconnect
- [http://www.multispeak.org/Version_4.1_Release CB_Server](http://www.multispeak.org/Version_4.1_Release_CB_Server)
 - CDStatesChangedNotification (async reply)
 - ReadingChangedNotification (async reply)
- [http://www.multispeak.org/Version_4.1_Release OD_Server](http://www.multispeak.org/Version_4.1_Release_OD_Server)
 - InitiateOutageDetectionEventRequest

Silver Spring Networks

- urn:com:ssn:schema:service:v1.4:DataAggregation and urn:com:ssn:schema:service:v1.6:DataAggregation
 - getMeterFieldStatus
- urn:com:ssn:schema:service:v1.4:DeviceManager and urn:com:ssn:schema:service:v1.6:DeviceManager
 - FindDevice
 - ReplaceDeviceAtLocation
 - ReplaceLocation
- urn:com:ssn:schema:service:v1.4:DeviceResults and urn:com:ssn:schema:service:v1.6:DeviceResults
 - getRemoteProvisioningResultsByJobID
 - getMeterReadResultsByJobID
 - getPingResultsByJobID
- urn:com:ssn:schema:service:v1.4:JobManager and urn:com:ssn:schema:service:v1.6:JobManager
 - addRemoteProvisioningJob
 - getJobStatus
 - addMeterReadJob
 - addPingJobfindJob
 - getJobStatusForDevice

Locating the WSDL for the Test Harness

Follow these procedures to locate the test harness web service definition language (WSDL):

How to Use Enterprise Manager to Locate the WSDL

1. Open Enterprise Manager and use the navigation pane to open the dashboard of the test harness composite:
2. The top bar of the dashboard contains several buttons and icons. One of these is a “world” icon with a puzzle piece over it. Click this icon to display a list of the WSDLs and endpoint URIs for the composite:
3. Click the UtilService WSDL URL link to see the WSDL in the browser, or right click and save it to your machine

Depending on your requirements, it may be necessary to download the associated schema found in the wsdl:types section. The URL can be pasted into a browser tab and downloaded in the same manner as the WSDL. The main schema has imported schemas that may also be required.

How to Use a Direct URL to locate the WSDL

The WSDL can be accessed without Enterprise Manager by understanding the paths used on the SOA server. In general, they have the following form:

```
http://{server name}:{port number}/soa-infra/services/{partition}/{Composite}/{Web Service}?WSDL
```

For example, the test harness WSDL can be found at the following locations for each SGG adapter.

Itron OpenWay:

```
http://{server name}:{port number}/soa-infra/services/Itron_Test/ItronTestHarness/  
UtilService? WSDL
```

Landis+Gyr:

```
http://{server name}:{port number}/soa-infra/services/LG_Test/LGTestHarness/UtilService?WSDL
```

Sensus RNI:

```
http://{server name}:{port number}/soa-infra/services/Sensus_Test/Sensus/UtilService?WSDL
```

Silver Spring Networks:

```
http://{server name}:{port number}/soa-infra/services/SSN_Test/SSNTestHarness/UtilService?WSDL
```

Web Services

This section describes the web services included in the test harness BPEL composite for each supported head-end system.

General Services

This section describes the general services of the test harness composite.

LoadMeterIndex

This web service loads the data store from the internal file. By default, if the store is already in memory, it will NOT reload. This behavior can be overridden with the forceReload parameter.

Input — LoadMeterIndexInput

Part: payload

Element: LoadMeterIndexRequest

Parameter	Description
forceReload	A switch telling the system whether to reload the meter index from the configuration file. Default is false.

Output — LoadMeterIndexOutput

Part: payload

Element: LoadMeterIndexResult

Parameter	Description
loaded	A boolean value for whether or not the index was reloaded from the configuration file

Fault — [UtilityFault](#) (see [UtilityFault](#) for more details).

ViewAuditTrail

This web service returns the audit log for the entire session.

Input — [ViewAuditTrailInput](#)

Part: payload

Element: [ViewAuditTrailRequest](#)

Output — [ViewAuditTrailOutput](#)

Part: payload

Element: [ViewAuditTrailResult](#)

An Entry consisting of a timestamp and an Operation. Each entry may have an associated meter object showing the latest update.

Fault — See [UtilityFault](#), above.

UtilityFault

Fault with similar mapping to SGG/OUAF faults:

Typically, the `faultCode`, `faultString`, `faultActor`, and `detail/text` elements will be populated.

Locate Meter Services

This section describes the locate meter web services of the test harness composite.

FindMeters

This web service queries the data store for one or more meters. The difference between `GetMeter` and `FindMeters` is `GetMeter` can return at most one meter and it must match the provided ID exactly. `GetMeter` will throw an error if the ID is not found. `FindMeters` can return more than one meter (when using the regex) and will not throw an error when the ID does not match any of the meters in the index.

Input — [FindMetersInput](#)

Part: payload

Element: [FindMetersRequest](#)

Parameter	Description
<code>id</code>	The meter ID for which to search
<code>isRegex</code>	The provided id can be a regex value when this parameter is true. Hint: to search for all meters in the system, use <code>".*"</code> for the ID.

Output — [FindMetersOutput](#)

Part: payload

Element: [FindMetersResult](#)

Zero or more meter objects can be returned from the search

Fault — See [UtilityFault](#). Unlike other methods, `FindMeters` does not throw an exception if the meter is not found. As such, it can be used to test for the existence of a Meter prior to querying for it.

IsMeterDefined

This web service queries whether a particular meter is defined in the data store.

Input — IsMeterDefinedInput

Part: payload

Element: IsMeterDefinedRequest

Parameter	Description
id	The meter ID for which to search

Output — IsMeterDefinedOutput

Part: payload

Element: IsMeterDefinedResult

Whether or not the provided ID is part of the index.

Fault — See [UtilityFault](#). Thrown when meter id is not found.

GetMeter

This web service returns all the attributes of a single meter from the in-memory data store. The difference between GetMeter and FindMeters is GetMeter can return at most one meter and it must match the provided ID exactly. GetMeter will throw an error if the ID is not found. FindMeters can return more than one meter (when using the regex) and will not throw an error when the ID does not match any of the meters in the index.

Input — GetMeterInput

Part: payload

Element: GetMeterRequest

Parameter	Description
id	The meter ID for which to search

Output — GetMeterOutput

Part: payload

Element: GetMeterResult

The meter object requested by the ID.

Fault — See [UtilityFault](#). Thrown when meter id is not found.

Meter Administration Services

This section describes the meter administration services of the test harness composite.

AddMeters

This web service adds a set of meters to the in-memory data store. This will not permanently add it to the control file.

Input — AddMetersInput

Part: payload

Element: AddMetersRequest

Parameter	Description
id	The identification code for the meter.
macID	A MAC address that must be unique within the system.
utility	An informational string.
serviceType	One of the valid ServiceType values (see schema). "Electric" is the only option at this time.
isCommissioned	Whether or not the meter is in a commissioned state.
loadActionCode	One of the possible LoadActionCode values used in Connect and Disconnect (see schema).
outageEventType	One of the possible OutageEventType values used in Device Status Check (see schema).
executionStatus	One of the possible ExecutionStates (see schema). These values control how the meter will respond to commands.
groupName	The name linking multiple meters together into a set.
jobExecutionStatus	One of the possible Job Execution Status values (see schema). This attribute determines how requested jobs perform.
updateIfExisting	Whether or not to update the meter with the provided values if it already exists in the index.
Comment	An informational string describing the purpose of the meter.
Channels	A listing of unit of measures supported by this meter.
uomCode	A code describing the unit of measure for the channel.
uomName	A short string containing the name of the unit of measure.
decimals	The number of digits to the right of the decimal that should be generated when reading the meter.
description	A longer description of the unit of measure.

Output — AddMetersOutput

Part: payload

Element: AddMetersResult

Whether or not each meter was added to the index.

Fault — See [UtilityFault](#)

RemoveMeter

This web service removes a meter from the in-memory data store. This will not permanently remove it from the control file.

Input — RemoveMeterInput

Part: payload

Element: RemoveMeterRequest

Parameter	Description
id	The ID for the meter to be removed

Output — RemoveMeterOutput

Part: payload

Element: RemoveMeterResult

Whether or not the meter was removed from the index.

Fault — See [UtilityFault](#). Thrown when meter id is not found.

AddMeterChannel

This web service adds a new channel to a single meter.

Input — AddMeterChannelInput

Part: payload

Element: AddMeterChannelRequest

Parameter	Description
id	The identification code for the meter.
uomCode	A code describing the unit of measure for the channel.
uomName	A short string containing the name of the unit of measure.
decimals	The number of digits to the right of the decimal that should be generated when reading the meter.
description	A longer description of the unit of measure.

Output — AddMeterChannelOutput

Part: payload

Element: AddMeterChannelResult

Whether or not the channel was added to the index.

Fault — See [UtilityFault](#). Thrown when meter id is not found.

RemoveMeterChannel

This web service removes a Channel from a meter.

Input — RemoveMeterChannelInput

Part: payload

Element: RemoveMeterChannelRequest

Parameter	Description
id	The ID for the meter to be removed.
uomCode	A code describing the unit of measure for the channel.
uomName	A short string containing the name of the unit of measure.

These three parameters are combined to locate a unique channel

Output — RemoveMeterChannelOutput

Part: payload

Element: RemoveMeterChannelResult

Whether or not the channel was removed from the meter.

Fault — See [UtilityFault](#). Thrown when meter id is not found.

ReadScalarMeter

This web service generates a scalar reading for each channel of a given meter.

Input — ReadScalarMeterInput

Part: payload

Element: ReadScalarMeterRequest

Parameter	Description
id	The ID for the meter to be read

Output — ReadScalarMeterOutput

Part: payload

Element: ReadScalarMeterResult

Zero or more scalar readings for the given meter.

Parameter	Description
uomCode	A code describing the unit of measure for the channel.
uomName	A short string containing the name of the unit of measure.
decimals	The number of digits to the right of the decimal that should be generated when reading the meter.
description	A longer description of the unit of measure.
value	A random number representing the scalar reading.

Meter Attribute Administration Services

This section describes the meter administration services of the test harness composite.

GetLoadActionCode

This web service queries whether the given meter is connected or disconnected. This method is used by the Connect/Disconnect service. The values for load action code are:

- Connect
- Disconnect

Input — GetLoadActionCodeInput

Part: payload

Element: GetLoadActionCodeRequest

Parameter	Description
id	The ID for the meter for which the load action code status should be retrieved

Output — GetLoadActionCodeOutput

Part: payload

Element: GetLoadActionCodeResult

The connection status of the requested meter.

Fault — See [UtilityFault](#). Thrown when meter id is not found.

SetLoadActionCode

This web service updates the load action code for a given meter. This method is used by the Connect/Disconnect service. The values for load action code are:

- Connect
- Disconnect

Input — SetLoadActionCodeInput

Part: payload

Element: SetLoadActionCodeRequest

Parameter	Description
id	The ID for the meter for which the load action code status should be set.
value	The new value of LoadActionCode to set on the meter.

Output — SetLoadActionCodeOutput

Part: payload

Element: SetLoadActionCodeResult

The boolean response indicates the success or failure of the update (not the current field status).

Fault — See [UtilityFault](#). Thrown when meter id is not found.

IsCommissioned

This web service queries the commissioning status for a given meter. This service is used by the Commission/Decommission process. The commissioning attribute can be true or false.

Input — IsCommissionedInput

Part: payload

Element: IsCommissionedRequest

Parameter	Description
id	The ID for the meter for which the Commissioned status should be retrieved

Output — IsCommissionedOutput

Part: payload

Element: IsCommissionedResult

The value of the Commissioned status attribute for the requested meter.

Fault — See [UtilityFault](#). Thrown when meter id is not found.

SetCommission

This web service updates the commissioning status for a given meter. This service is used by the Commission/Decommission process. The commissioning attribute can be true or false.

Input — SetCommissionedInput

Part: payload

Element: SetCommissionedRequest

Parameter	Description
id	The ID for the meter for which the Commissioned status should be set
value	The new value of Commissioned status to set on the meter

Output — SetCommissionedOutput

Part: payload

Element: SetCommissionedResult

The boolean response indicates the success or failure of the update (not the current field status).

Fault — See [UtilityFault](#). Thrown when meter id is not found.

GetExecutionStatus

This web service queries the status of the property controlling the overall execution of the command. The possible values of execution status are:

- Success - The command should complete successfully
- ResponseTimeout - The asynchronous response will never arrive
- SyncOperationFail - A simulated fault will occur in the during the initial request
- AsyncOperationFailure - A simulated fault will occur in the asynchronous response

Input — GetExecutionStatusInput

Part: payload

Element: GetExecutionStatusRequest

Parameter	Description
id	The ID for the meter for which the ExecutionStatus should be retrieved

Output — GetExecutionStatusOutput

Part: payload

Element: GetExecutionStatusResult

The value of the ExecutionStatus attribute for the requested meter.

Fault — See [UtilityFault](#). Thrown when meter id is not found.

SetExecutionStatus

This web service updates the property controlling the overall completion of the command. The possible values of execution status are:

- Success - The command should complete successfully
- ResponseTimeout - The asynchronous response will never arrive
- SyncOperationFail - A simulated fault will occur in the during the initial request
- AsyncOperationFailure - A simulated fault will occur in the asynchronous response

Input — SetExecutionStatusInput

Part: payload

Element: SetExecutionStatusRequest

Parameter	Description
id	The ID for the meter for which the ExecutionStatus should be set
value	The new value of ExecutionStatus to set on the meter

Output — SetExecutionStatusOutput

Part: payload

Element: SetExecutionStatusResult

The boolean response indicates the success or failure of the update (not the current field status).

Fault — See [UtilityFault](#). Thrown when meter id is not found.

Creating a Custom Adapter for Smart Grid Gateway

Customers can create their own customized adapter for using Smart Grid Gateway with a specific head-end system. This can be done using the Oracle Utilities Smart Grid Gateway Adapter Development Kit. This section describes the Adapter Development Kit and its components.

NOTE: Unless otherwise noted, the contents of this section apply to middleware implementations of Oracle Utilities Smart Grid Gateway **only**, and do NOT apply to native implementations or Oracle Utilities cloud services. See [Smart Grid Gateway Adapter Native Implementations](#) for more information about Smart Grid Gateway Adapter native implementations and implementing Smart Grid Gateway adapters with Oracle Utilities cloud services.

Adapter Development Kit Overview

The Oracle Utilities Smart Grid Gateway (SGG) Adapter Development Kit provides a starting point for customers to create their own customized adapter for using SGG with a specific head-end system. SGG uses Oracle Service Bus (OSB) and Oracle Business Process Execution Language (BPEL) to facilitate communication with other head-end systems. The following functionality can be configured:

Measurement Data and Device Event Loading: Data parsing and transformation via Oracle Service Bus from the smart meter format into the Oracle Utilities Service and Measurement Data Foundation unified format for measurement data and device events.

Measurement Data and Device Event Processing: Configurable mapping for meter status codes and device event names to Oracle Utilities Service and Measurement Data Foundation standard values.

Commissioning Communication: Business objects and BPEL processes to support the Meter Add Notification message.

Connect Communication: Business objects and BPEL processes to support Initiate Connect/Disconnect and Connect/Disconnect State Change Notification messages.

Disconnect Communication: Business objects and BPEL processes to support Initiate Connect/Disconnect and Connect/Disconnect State Change Notification messages.

Decommissioning Communication: Business objects and BPEL processes to support Meter Removal Notification message.

On-Demand Read: Business objects and BPEL processes to support Initiate Meter Read by Meter Number and Reading Changed Notification messages.

Device Status Check: Business objects and Oracle BPEL processes to support the outbound Initiate Outage Detection communication, the inbound Outage Detection Event Notification communication, and the processing of Event Notifications.

What Does the Adapter Development Kit Provide?

The Oracle Utilities Smart Grid Gateway Adapter Development Kit includes the following:

Sample Oracle Service Bus Processes: A file parsing and transformation process framework, delivered as an Oracle Service Bus (OSB) configuration, that can be used as a reference for creating the functionality to import usage readings and device events from a specific head-end system.

Sample Oracle Business Process Execution Language Processes: A set of sample communication processes that support Remote Connect, Remote Disconnect, Commission, Decommission, Device Status Check, and On-Demand Read commands delivered as an Oracle Business Process Execution Language (BPEL) project.

Oracle Utilities Smart Grid Gateway Business Objects: Business objects to support measurement data and device event loading and two-way commands such Commission, Decommission, Remote Connect, Remote Disconnect, and Device Status Check.

Sample Two-Way Communication Test Harness: A head-end system emulator delivered as a BPEL composite.

Demonstration Data: A set of sample data provided in the demonstration database that can be used with the adapter processes as delivered (prior to any customization you might perform as part of your implementation).

Adapter Development Kit Processing

This section provides details concerning the OSB processing, BPEL Processes, and OUAF objects supplied as part of the base package. This information illustrates how the base package objects were designed, and can serve as the basis for any customizations you create as part of your implementation.

Initial Measurement Data and Device Event Loading

The initial measurement data load and subsequent device event processing use OSB to poll for, parse, and transform the head-payloads into the Oracle Utilities Smart Grid Gateway service format. Payloads contain measurements and meter events in some head-end specific format OSB then places each service call into a JMS queue within the Oracle Utilities applications. The JMS client consumes the entries and invokes the respective services in parallel then a service creates initial measurements with data in a common format with head-end-specific processing as needed. A second service creates device events with data in a common format.

Initial Measurements and Device Events

The usage and event data exported from the AMI head-end system is loaded into Oracle Utilities as initial measurement and device event data. You can customize processing of this by configuring the following base product OSB projects:

1. **SGG-DG-CSV-BASE** contains components that are not to be changed on customer site. They implement functions specific to the CSV format processing such as validation and transformation.
2. **SGG-DG-CSV-CM** allows for customization and simplifies future upgrades.
3. **SGG-DG-XML-BASE** contains components that are not to be changed on customer site. They implement functions specific to the IMD and event upload format processing such as validation and transformation.
4. **SGG-DG-XML-CM** allows for customization and simplifies future upgrades.

The runtime configuration settings for the SGG-DG-CSV-CM project are stored in the EnvironmentSettings.xq xquery file. You can use this file to adjust initial measurement and device event data processing. For example, if you want to load raw data you would specify “true” for the content of the populateRaw element.

The following table describes the elements included in the SGG-DG-CSV-CM EnvironmentSettings.xq file:

Element	Description	Valid Values
populateRaw	Determines if the initial measurement data is populated as raw data.	true false
callPreProcessing	Determines if the preprocessing proxy service is called.	true false
callPostProcessing	Determines if the postprocessing proxy service is called.	true false
destinationRootElementEvent	Holds the name of inbound web service for the device event seeder.	
destinationRootElementIMD	Holds the name of inbound web service for the IMD seeder.	

The runtime configuration settings for the SGG-DG-XML-CM project are stored in the EnvironmentSettings.xq xquery file. You can use this file to adjust initial measurement and device event data processing. For example, if you want to load raw data you would specify “true” for the content of the populateRaw element.

The following table describes the elements included in the SGG-DG-XML-CM EnvironmentSettings.xq file:

Element	Description	Valid Values
populateRawIMD	Determines if the initial measurement data is populated as raw data.	true false
callPreProcessing	Determines if the preprocessing proxy service is called.	true false
callPostProcessing	Determines if the postprocessing proxy service is called.	true false
destinationRootElement	Holds the name of inbound web service for the IMD seeder.	

For additional information about the sample OSB implementation included in the Oracle Utilities Smart Grid Gateway Adapter Development Kit, see [Oracle Service Bus Processing](#).

Processing Large Input Files

In some environments, the OSB project may begin processing a large input file before it has been completely copied to the input directory. To prevent this, configure the MinimumAge property in the “InboundProxyService” proxy service for the SGG-DG-CSV-CM and SGG-DG-XML-CM projects. The MinimumAge property specifies the minimum age of files to be retrieved, based on the last modified time stamp. This enables large files to be completely copied to the input directory before they are retrieved for processing.

Processing Data in the Adapter Development Kit Native Format

Usage and event data exported from the AMI head-end system can be loaded into Oracle Utilities in the “native” initial measurement and device event data formats (the format of the initial measurement and device event seeder business objects). You can customize processing of this by configuring the following base product OSB projects:

1. **SGG-DG-SEEDER-BASE** contains components that are not to be changed on customer site. They implement functions specific to the IMD and event upload format processing such as validation and transformation.
2. **SGG-DG-SEEDER-CM** allows for customization and simplifies future upgrades.

The runtime configuration settings for the SGG-DG-SEEDER-CM project are stored in the EnvironmentSettings.xq xquery file. You can use this file to adjust initial measurement and device event data processing. For example, if you want to load raw data you would specify “true” for the content of the populateRaw element.

The following table describes the elements included in the SGG-DG-SEEDER-CM EnvironmentSettings.xq file:

Element	Description	Valid Values
callPreProcessing	Determines if the preprocessing proxy service is called.	true false
callPostProcessing	Determines if the postprocessing proxy service is called.	true false
destinationRootElementInterval	Holds the name of inbound web service for the interval IMD seeder.	
destinationRootElementScalar	Holds the name of inbound web service for the scalar IMD seeder. In most cases it is the same as destinationRootElementInterval.	
destinationRootElementEvent	Holds the name of inbound web service for the device event seeder.	
publishServices/service	Specifies the name of the business service within the OSB project used to publish data for external systems (such as Oracle DataRaker).	
filterEvents	Determines if events should be filtered.	true false
filterUsage	Determines if usage should be filtered.	true false

See [The Adapter Development Kit Native Format](#) for more information about the ADK “native” format.

Publishing Initial Measurement Data and Device Events

The Adapter Development Kit can be configured to publish initial measurement data and device events for use in Oracle DataRaker or other external systems. This functionality is supported through a combination of OSB components and BPEL composites.

Enabling Data Publishing

Publishing data is enabled by referencing a publisher business service in the publishServices/service element in the EnvironmentSettings.xq file as follows:

```
<publishServices>
  <service>[publisherBusinessService]</service>
</publishServices>
```

The following components provided with the SGG-DG-SEEDER-CM OSB project are used in publishing measurement data and device events to Oracle DataRaker:

- The **DataRakerBusinessService** business service is used to send data to a pre-configured JMS queue (defined as an Endpoint URI), from which the data will be published. This is the business service that should be specified in the EnvironmentSettings.xq file.
- The **DataRakerServiceAccount** service account is used to define and maintain the user name and password needed to access the JMS queue defined in the **DataRakerBusinessService** business service.

Configuring Publishing Output

The SGGDRIntegration BPEL composite handles publishing the data to Oracle DataRaker or other systems.

Initial measurement and device event data is published in the “native” initial measurement data format (the format of the initial measurement and device event seeder business objects). This format includes normalized unit of measure, condition, and device event codes. See the *Oracle Utilities Smart Grid Gateway Adapter Development Kit Administrative User Guide* for more details about this format.

NOTE: Initial measurement data published via this feature is published prior to VEE processing. In addition, filtering can NOT be applied to initial measurement or device event data published via this feature.

The following parameters can be used to configure details of how the data is provided to Oracle DataRaker, including the directory where files are posted for Oracle DataRaker to consume, number of records per file, polling frequency, etc. These parameters are defined during installation. See the *Oracle Utilities Smart Grid Gateway Installation Guide* for more details about defining values for these parameters.

Parameter	Description	Default Value
SGG_DR_INT_QUEUE	JNDI name of queue to publish SGG payloads. This is the JMS queue defined in the DataRakerBusinessService business service. This should NOT be changed.	DataRakerQueue
SOA_DR_PUBLISH_SIZE	The number of records (SGG payloads) to accumulate in a published file.	100
SOA_DR_FILE_SIZE	The maximum file size for the accumulated (SGG payloads) file in kilobytes.	524288
SOA_DR_ELAPSED_TIME	The period of time in second which, when exceeded, causes a new outgoing file to be created.	600
SOA_DR_POLLING_FREQ	The polling frequency in seconds of the staging directory for new files.	60
SOA_DR_STAGING_DIR	Mount point/directory for the staging directory for accumulated SGG payload files. This is used internally and should NOT be changed.	/spl/sploutput/staging
SOA_DR_INTEGRATION_DIR	Mount point/directory from which Oracle DataRaker will consume the converted XML files.	/spl/sploutput/int

Filtering Initial Measurement Data

The Adapter Development Kit can be configured to filter initial measurement data passed into Oracle Utilities Smart Grid Gateway and Meter Data Management. Filtering data is enabled by setting the <filterUsage> element in the EnvironmentSettings.xq file to “true” as follows:

```
<filterUsage>true</filterUsage>
```

When filtering is enabled, only measurements whose <externalUOM> matches one of the values defined in the **ADK - UOM Code to Standard UOM Mapping** extendable lookup (DG-HeadendUOMLookup) are passed into the system for processing.

Filtering Events

The Adapter Development Kit can be configured to filter device events passed into Oracle Utilities Smart Grid Gateway and Meter Data Management. Filtering data is enabled by setting the <filterEvents> element in the EnvironmentSettings.xq file to “true” as follows:

```
<filterEvents>true</filterEvents>
```

When filtering is enabled, only device events whose <externalEventName> matches one of the values defined in the **ADK - Device Event Mapping** extendable lookup (DG-DeviceEventMappingLookup) are passed into the system for processing.

Prioritized Device Event Processing

The SGG adapter prioritizes processing of device events created from smart meter commands and/or completion events by setting the Execution Method flag in these types of device events to “Real Time” (D1RT). In addition, device events received with the Execution Method flag set to “Real Time” will be processed in real time rather than via batch processing. See **Device Event Prioritization** in the *Oracle Utilities Meter Data Management / Smart Grid Gateway Business User Guide* for more information.

Configuring Payload Processing Notifications

By default, Payload Statistics, Payload Error Notification, and Payload Summary notification activities are sent to the Notification Queue within Oracle Service Bus. Smart Grid Gateway adapters can be configured to restrict sending these activities by defining optional JCA transport dynamic properties in the appropriate OSB project. The following optional JCA transport dynamic properties can be used to control if these notification activities are sent:

- **SGG_SEND_STATISTICS**: Controls sending Payload Statistic activities (true: send, false: do not send)
- **SGG_SEND_ERROR**: Controls sending Payload Error Notification activities (true: send, false: do not send)
- **SGG_SEND_SUMMARY**: Controls sending Payload Summary activities (true: send, false: do not send)

When these properties are set to false, the corresponding payload notification will not be sent to the JMS Queue. Note these properties are not populated by default, and default to true if omitted.

To create these properties:

1. Navigate to the SGG-D3-CIM-EVENT-CM project in the Oracle Service Bus Console.
2. Expand the **Proxy Services** folder.
3. Select the **InboundProxyService** proxy service (not the Pipeline or WSDL).
4. Click **Create** to create a new session.
5. Select **Transport Details**.
6. Click the plus sign in the **Dyanmic EndPoint Properties** section. An empty row will appear.
7. Enter the property you wish to define in the **Property** column.
8. Enter "false" in the **value** column.
9. Repeat steps 6-8 for each property you wish to define.
10. Click **Activate** to save and activate your changes.

NOTE: These properties are only used if the SGG_EXT_ID_PATTERN is not present or the regular expression captures nothing. The SGG_EXT_ID_PATTERN will override these properties when the regular expression captures group data.

Base Package Business Objects

The adapter development kit base package includes the following device and initial measurement business objects:

Business Object Name	Description
DG-InitialLoadIMDInterval	Generic Initial Load IMD - Interval Used when loading customized adapter interval measurements into the system for the first time.
DG-InitialLoadIMDScalar	Generic Initial Load IMD - Scalar
DG-SmartMeter	ADK — Smart Meter

Device Communication

The basic communication for all business processing is essentially the same. A communication request is sent from the Oracle Utilities application to the head-end system. This request would be for a connect/disconnect, commission/decommission, measurement data, device status check, or an on-demand read. The designated BPEL process transforms the request from Oracle Utilities format to MultiSpeak format and invokes the related head-end system web service. The head-end system then returns a reply, and the BPEL process transforms the reply message back to the appropriate format so that Oracle Utilities can receive the response.

Communication Flows

The table below lists the communications created for each Adapter Development Kit command:

Command	Outbound Communication	Inbound Communication	Completion Event
Remote Connect	ADK - Initiate Connect or Disconnect	ADK - Connect/ Disconnect State Change	Connect Device Create IMD
Remote Disconnect	ADK - Initiate Connect Disconnect	ADK - Connect/ Disconnect State Change	Disconnect Device Create IMD
Device Commissioning	ADK - Meter Add Notification		Device Commissioning
Device Decommissioning	ADK - Meter Remove Notification		Device Decommissioning
On-Demand Read (Scalar)	ADK - Initiate Meter Read by Meter ID	ADK - Reading Changed Notification	Create IMD
On-Demand Read (Interval)	ADK - Initiate Meter Read by Meter ID	ADK - Reading Changed Notification	Create IMD
Device Status Check	ADK - Initiate Outage Detection	ADK - Outage Detection Event Notif	

Unit of Measure Filtering for On-Demand Reads

Readings returned via On-Demand Read commands are filtered on the combination of Unit of Measure/Time of Use/Service Quantity Identifiers (UOM/TOU/SQI) configured for the device and measuring component. When filtering is enabled, only readings that match a configured UOM/TOU/SQI combination are processed. All others are filtered out.

Filtering is enabled by default via the "Opt Out Of Filtering" parameter (set to "false" by default) on the DG-CCOMPEV (Create IMD Completion Event) algorithm on the Create Completion Events status of the DG-ReadingChgNotification (ADK - Reading Changed Notification) business object.

The DG-VALDVCFIL (Check if Device has any Filtering errors) algorithm on the Validate status of the DG-ReadingChgNotification (ADK - Reading Changed Notification) business object is used to check for errors related to filtering. The value of the "Opt Out Of Filtering" parameter on this algorithm must match the value of the parameter on the DG-CCOMPEV algorithm. The parameters should both be set to either "false" (the default) or "true" (if filtering is to be disabled).

Device Communication Base Package Business Objects

The adapter development kit base package includes the following communication business objects:

Business Object Name	Description
DG-ConnectDisconStateChgNtf	Generic - Connect/Disconnect State Change
DG-InitiateConnectDisconnect	Generic - Initiate Connect Disconnect
DG-InitiateMeterByMeterId	Generic - Initiate Meter Read By Meter ID
DG-InitiateOutageDetection	Generic - Initiate Outage Detection

Business Object Name	Description
DG-MeterAddNotification	Generic - Meter Add Notification
DG-MeterRemoveNotification	Generic - Meter Remove Notification
DG-OutageDetectEvtNotification	Generic - Outage Detection Event Notification
DG-ReadingChgNotification	Generic - Reading Changed Notification

Event Data Mapping

The head-end system event file format can map as follows into the business object, D1-DeviceEventMappingLookup:

Head-End System Flat File Field	Device Event Seeder BO Element	Comments
Transaction ID (from Header record)	External Source Identifier	This is the file name.
Device Identifier	External Device Identifier	
Event Name	External Event Name	
Event Creation Date/Time	Event Date/Time	
Device Type	External Device Type	This element has no real bearing on the device type within MDM/SGG. Its valid values include (although the element itself is free-form): Meter Collector Router
Service Location ID	External Service Location ID	
Communication Module Serial Number	External Communication Module Identifier	
Event Category ID	External Event Category	
Event Severity	External Event Severity	Valid values include (although the element itself is free-form): Alert Information
Status Value	External Status Value	This represents additional information that relates to the event itself.
Status Date/Time	External Status Date/Time	The date & time at which the additional information referenced above had occurred.

External System

You must create an External System for each external system to which Oracle Utilities Smart Grid Gateway will send messages. Each external system defines a set of outbound message types that will be sent to that system. Each external system outbound message type also specifies the following:

- The processing method used to send the message (Batch or Real-time)
- The corresponding message senders
- Batch Control (if Processing Method is set to Batch)
- Message XSL, W3C Schema, and Response XSL (as applicable)

Inbound / Outbound Service Configuration

The inbound/outbound message utility allows you to configure your system to receive information from and to send information to external applications using XML. The adapter for Smart Grid Gateway uses one inbound web service to map device events. This is the same inbound web service used by the D1 application.

Inbound Web Services

Inbound web services define the details of how messages are received from an external system, including the inbound communication business object (or business service or service script) to be invoked when the response message is received. As in the case of inbound communication business objects, the set of inbound web services you need to create is based on the types of messages the system is designed to send.

The Oracle Utilities Smart Grid Gateway Adapter Development Kit includes the following inbound web services:

Inbound Web Service	Description
D1-BulkRequestHeader	Bulk Request Header
D1-BulkRequestUpdate	Bulk Request Update
D1-BulkResponse	Bulk Response
D1-DeviceEventSeeder	Used for upload of device events. The Device Event Seeder business object serves as a means of adding device events both from outside the application and from online. Its pre-processing algorithms determine the device event type - which in turn defines the device event BO that should be used to create the device event. If a device event type can't be determined, the device event is created using this BO. Such a device event can then be re-processed - and if successful, a new device event is created.
D1-InitialLoadIMD	Used for initial measurement upload. The IMDSeeder business object is used to determine the type of initial measurement business object to instantiate when receiving usage readings from a head-end system.
D1-DeviceStatusCheck	Device Status Check This service is invoked by the integration layer to instantiate a Device Status Check command.
D1-InitialLoadIMD	Used by OSB to instantiate an IMD This inbound web service is used by OSB to instantiate an Initial Measurement Data for incoming interval usage in the Generic format.
D1-RemoteConnect	Remote Connect This service is invoked by the integration layer to instantiate a Remote Connect command.
D1-RemoteDisconnect	Remote Disconnect This service is invoked by the integration layer to instantiate a Remote Disconnect command.
DG-ConDisconStChgNotification	Initiate Connect Disconnect response. Retrieves asynchronous response from Initiate Connect Disconnect command.

Inbound Web Service	Description
DG-OutageDetectionEventNotification	Initiate Outage Detection Response Retrieve response from the Initiate Outage Detection Event Notification command.
DG-ReadingChangedNotification	Reading Changed Notification Notification that a device reading has changed.

Message Senders

Message senders define the details of how messages are sent to an external system. As in the case of outbound communication business objects and outbound message types, the set of message senders you need to create is based on the types of messages the system is designed to accept.

The Oracle Utilities Smart Grid Gateway Adapter Development Kit includes the following message senders:

Message Sender	Description
DG-COMM	Generic Adapter Commission
DG-DCOMM	Generic Adapter Decommission
DG-INTOUDET	Generic Adapter — Initiate Outage Detection Request
DG-XAISender	Commission / Decommission Sender

BPEL Processes

These processes are responsible for performing the conversion from Oracle Utilities format to MultiSpeak 4.1 format, invoking process callouts and invoking the remote endpoint to trigger the device events.

OnDemandRead Composite Process: Invokes the remote endpoint to trigger the on-demand read event. An asynchronous reply responds to the OUAF layer when the reading arrives.

ConnectDisconnect Composite Process: Invokes the remote endpoint to trigger the connect/disconnect event. An asynchronous reply responds to the OUAF layer when confirmation of the requested event arrives.

CommissionDecommission Composite Process: Invokes the remote endpoint to trigger the commission or decommission event. After the synchronous call completes, a one of the following second business callout services is invoked to determine if the related “received” or “completed” callout should be executed:

- isExecutingCommissionReceived-Callout
- isExecutingCommissionCompleted-Callout
- isExecutingDecommissionReceived-Callout
- isExecutingDecommissionCompleted-Callout

DeviceStatusCheck Composite: Invokes the remote endpoint to trigger the initiate outage detection event. An asynchronous reply responds to the OUAF layer when confirmation of the requested event arrives.

ProcessCallout Composite: This business callout provides a point at which customers and implementers can incorporate custom business logic and transformations. This composite includes the WSDLs and processing logic for all of the MultiSpeak processes. The default implementation of each method is a direct return of the input.

For additional information about the BPEL processes included in the Oracle Utilities Smart Grid Gateway Adapter Development Kit, see [Business Processing Execution Language Processing](#).

Web Services

These web services are all defined in the head-end system. The WSDLs were added to a Meta Data Storage (MDS) layer in OUAF and all references to the WSDL point to this MDS location. These web services have HTTP security by default. You may need to modify the security as a part of your implementation.

Web Service	Related BPEL Process	Description
CB_ServerService	ConnectDisconnect	<p>This web service defines the return interface, the means by which the status is returned to the calling system.</p> <p>This web service is only be invoked by the head end system, not OUAF. Only the CDStateChangeNotification web method is implemented in the composite.</p> <p>The endpointURI format is: http://<EM_SERVER>:<EM_SERVER_PORT>/soa-infra/services/Generic Adapter/ConnectDisconnect/CB_ServerService</p>
CB_Server	OnDemandRead	<p>This web service defines the return interface, the means by which the reading is returned to the calling system.</p> <p>This web service is only be invoked by the head end system, not OUAF. Only the ReadingChangedNotification web method is implemented in the composite.</p> <p>The endpointURI format is: http://<EM_SERVER>:<EM_SERVER_PORT>/soa-infra/services/Generic Adapter/OnDemandRead/CB_Server</p>
OA_ServerService	DeviceStatusCheck	<p>This web service defines the asynchronous return for InitiateOutageDetectionEventRequest for solicited responses.</p> <p>This web service is only be invoked by the head end system, not OUAF. Only the ODEventNotification, PingURL, and GetMethods web methods are implemented in the composite.</p> <p>The endpointURI format is: http://<EM_SERVER>:<EM_SERVER_PORT>/soa-infra/services/Generic Adapter/DeviceStatusCheck/OA_ServerService</p>

For additional information about the web services included in the Oracle Utilities Smart Grid Gateway Adapter Development Kit, see [Business Processing Execution Language Processing](#).

Oracle Service Bus Processing

This chapter describes how to use Oracle Service Bus (OSB) and the components of the Oracle Utilities Smart Grid Gateway Adapter Development Kit to develop an adapter for importing usage reading and device events.

OSB Overview

The examples in this chapter provide an implementer with the information required to create a customized adapter using the Oracle Utilities Smart Grid Gateway Adapter Development Kit. Customized adapters are required in situations where a productized Smart Grid Gateway adapter is not available for a particular head-end system. The examples below explain how to receive and process inbound meter usage and events. The examples contain two parts: the incoming file parsing functionality implemented in Java, and an easy, configurable and customizable Oracle Service Bus (OSB) configuration, including an implementation of post-parsing functionality.

OSB Prerequisites

Development of an Oracle Utilities Smart Grid Gateway adapter requires a number of technical skills as well as a development environment.

Required Technical Skills

The following technical skills are required for developing an adapter using the development kit:

- Experience in Java programming
- Experience in development using XQuery and XPath
- Experience in XML programming
- Experience in OSB development and administration
- Understanding of Oracle Utilities Service and Measurement Data Foundation (SMDF) architecture

Environment Requirements

Development of the Oracle Utilities Smart Grid Gateway adapter requires an environment configured as follows:

- The Oracle WebLogic server must be installed.
- The OSB must be installed.
- An OSB domain must be created.
- Java Messaging Service (JMS) queues for Initial Measurement Data (IMD) and Notification messages must be created.
- The `spl-d1-osb-2.0.1.jar` containing the `com.splwg.d1.sgg.osb.common` Java package must be available. This is a single jar for all vendor-specific adapters.
- The archive `sgg-osb-generic-adapter.zip` must be available. This file is downloaded as a part of adapter development kit deployment. It contains the `FileParser` folder with sample source code and the `com.splwg.dg.sgg.osb.configuration.jar` file with sample OSB projects.

OSB Related Documentation

For more information about using the adapter development kit and Oracle Service Bus, see the following Oracle documents:

- *Oracle Fusion Middleware User's Guide for Technology Adapters*
- *Oracle Fusion Middleware Administrator's Guide for Oracle Service Bus*
- *Oracle Fusion Middleware Developing Applications for Oracle WebLogic Server*
- *Oracle Fusion Middleware User's Guide for Oracle JDeveloper*
- *Oracle Utilities Meter Data Management / Smart Grid Gateway Business User Guide*
- *Oracle Utilities Meter Data Management / Smart Grid Gateway Administrative User Guide*

OSB Processing Terms and Acronyms

This section lists several terms and acronyms used throughout this chapter.

Term	Definition
AMI	Advanced Metering Infrastructure
CSV	Comma-Separated Values
FA	File Adapter. Oracle JCA File Adapter.
FP	File Parser, Java code that parses input file and generates Plain XML
GA	Smart Grid Gateway generic adapter
GFP	Generic File Processor, Java code that is invoked by FA. It communicates with FP
IMD	Initial Measurement Data
IMD XML	The final XML containing the IMD.
JAR	Java Archive
JAXB	Java Architecture for XML Binding
JCA	Java Connector Architecture
JDeveloper	Freeware Oracle integrated development environment for development of Java-based SOA and Java EE applications
JMS	Java Message Service
MDB	Message Driven Bean
SMDF	Service and Measurement Data Foundation
OSB	Oracle Service Bus
OUAF	Oracle Utilities Application Framework
Plain XML	An intermediate XML containing all of the values from the inbound file. It is necessary because OSB Message Flow can handle only XML.
PPS	Processing Proxy Service, OSB proxy service where the validation and transformation of Plain XML is implemented. It is necessary to catch errors that occurred before Plain XML is transformed to IMD or Device Event seeder structures.
RFD	Rejected File Descriptor, File containing information about a portion of input file that was a cause of error.
RPPS	Result Processing Proxy Service, OSB proxy service where processing of transformation result is implemented. It is necessary to catch errors that occurred after Plain XML is transformed to IMD or Device Event seeder structures.
SGG	Smart Grid Gateway
Weblogic	Oracle J2EE Application Server
WSD	Web Session Directory
XML	eXtensible Markup Language
XPath	Programming language for selecting nodes from an XML document
XQuery	Programming language to query XML.

Oracle Utilities Smart Grid Gateway Adapters

This section contains detailed information on the different components that make up an Oracle Utilities Smart Grid Gateway adapter and the application logic that is needed to implement one.

Adapter Components

The following table lists the adapter components:

Component	Description
JCA File Adapter (FA)	Technology adapter for reading and writing files on the local file system. It is responsible for polling files from incoming folder and passing it to the Generic File Processor.
Generic File Processor (GFP)	Framework component that is implemented in Java. It is responsible for instantiation of the File Parser, getting Plain XML from it, and passing it to OSB message Flow. It also performs payload statistics related functionality such as gathering data and generating notification messages.
File Parser (FP)	<p>Component implemented in Java. It is specific to every different incoming format. It is responsible for parsing the incoming file, breaking the payload into logical parts (debatching), generating Plain XML for every logical part, and returning XML back to invoking GFP.</p> <p>Plain XML could be any logical subset of data that can be mapped to IMD. It is an intermediate format/schema between the raw data and IMD XML. The Plain XML schema must be defined by the file parser developer.</p> <p>Raw data is read in portions from the input file and converted to Plain XML before passing to OSB message flow. The reason for data being read in portions is as follows:</p> <p>Assume that an input file contains readings for 100 Measuring Components. You would want to read the input file in portions for two particular reasons.</p> <ol style="list-style-type: none"> 1. Reading data of exactly one measuring component ensures that it is mapped appropriately to one IMD at a time. 2. Reading data in portions ensures that the entire file is not loaded into memory, which could cause resource issues.
Inbound Proxy Service	OSB proxy service that contains FA-related configuration settings. It statically routes all messages to Processing proxy Service.
Processing Proxy Service (PPS)	OSB proxy service that validates and transforms Plain XML. This service is necessary for catching errors that occur before Plain XML is transformed to IMD or Device Event seeder structures.
Result Processing Proxy Service (RPPS)	OSB proxy service that processes transformed data. This service is necessary for catching errors that occur after Plain XML is transformed to IMD or Device Event seeder structures.

Processing Life Cycle

This section outlines the life cycle from the initial input file to the initial measurement output. Refer to [OSB Processing Terms and Acronyms](#) for descriptions of the abbreviations and acronyms used in this chapter.

See the [Logic Sequence Diagram](#) for general description of how the components interact.

OSB Processes

1. The JCA File Adapter starts reading the file.
2. FA instantiates and initializes the GFP.
3. FA invokes GFP passing an open stream to the incoming file.
4. GFP sends **D1-PayloadStatistics** notification message to FA.
5. GFP instantiates and initializes (if it is not done yet) the FP that is defined in the Inbound Proxy properties for parsing the file.
6. GFP invokes the FP (See [File Parser Processes](#) below).
7. In case of error in FP it invokes GFP. GFP sends **D1-PayloadErrorNotif** notification message to FA.
8. GFP gets the Plain XML as a return from FP.
9. GFP returns the Plain XML to the FA.

10. The Plain XML is passed via InboundProxyService to Processing Proxy service (PPS). In PPS's message flow, the Plain XML is validated and transformed to IMD XML.
11. PPS passes the IMD to Result Processing Proxy service (RPPS). RPPS publishes the IMD XML to a JMS queue, which is then picked up by Message Driven Bean (MDB).
12. OSB processes 3 through 9 are repeated until FP returns NULL on process 9.
13. GFP sends **D1-PayloadSummary** notification message to FA.

File Parser Processes

1. FP starts reading the input stream
2. FP instantiates a JAXB object of the type of Plain XML. The JAXB related interfaces and implementation classes are generated by using JDeveloper (See *Oracle Fusion Middleware User's Guide for Oracle JDeveloper* or [Generating Java Classes from XML Schemas](#)).
3. FP reads the input stream in segments until it hits a logical end of data with which it could create a Plain XML.
4. FP populates the data that is read into the Plain XML JAXB object.
5. FP marshals the JAXB object into Plain XML and passes back GFP. If the end of file (EOF) is reached FP passes back NULL.
6. File parser processes 2 through 5 are performed for every invocation by GFP.

Java Project

The source code in the example files contains an implementation of functionality to parse an incoming payload in Comma Separated Values (CSV) and XML formats. This implementation can be used as a reference for creating a project that is specific to your head-end system. The descriptions below are mostly related to CSV parsing functionality as it is a more complex and interesting example. The XML related parsing example is provided only to illustrate how XML-based input formats may also be processed.

Logic Sequence Diagram

The sequence diagram below is helpful for understanding the File Parser functionality. The custom class must implement the FileParser and FileParser2 Java interfaces described in the SGG D1 jar to be qualify as a file parser. For more information, see [FileParser Interface](#) and [FileParser2 Interface](#).

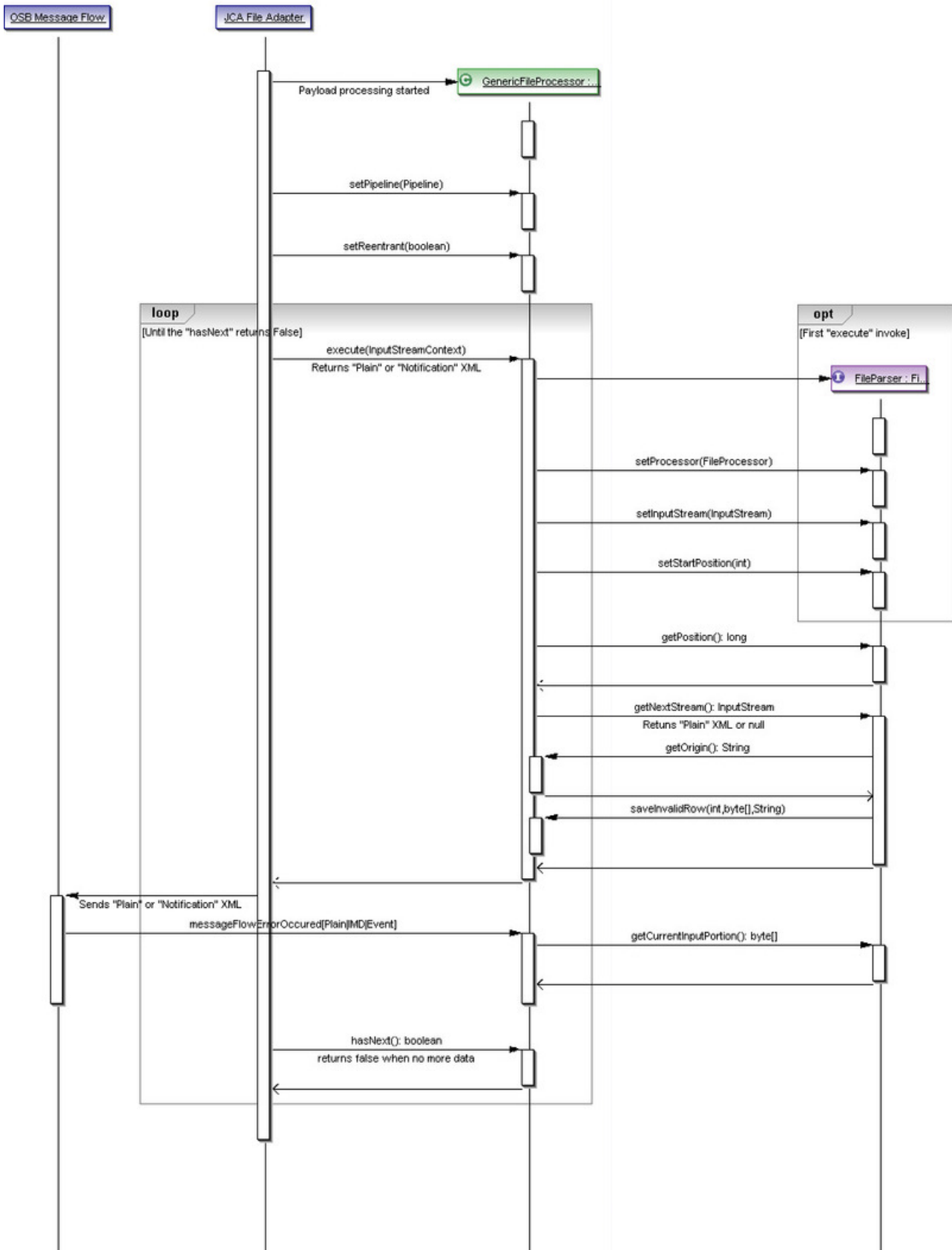

When FA finds a file in the input directory, it instantiates and calls GFP which in turn starts an interaction with the FP. The interaction can be categorized into the following three phases:

1. Instantiation and Initialization

- setProcessor()
- setInputStream()
- setStartPosition()

2. Transaction

- getPosition()
- getNextStream()

3. Exception Handling

- getCurrentInputPortion()

Instantiation and Initialization Phase

The GFP is instantiated and receives an Input Stream when a file gets into the input directory. At that point an instance of the FP is instantiated. Certain methods, as specified above, are invoked on the FP to initialize.

Transaction Phase

Once the FP is initialized, GFP uses the FP instance to generate the Plain XML structure. This happens with the invocation of getNextStream() method on the FP.

On every invocation, the FP returns exactly one Plain XML. The FP invocations continues until NULL is returned from the FP. NULL indicates the end of file and an indication that parsing is complete for a specific file. GFP stops invoking getNextStream() for a particular input file when it receives a NULL from the FP.

FP uses the file input stream to read the file in portions. It could read byte-by-byte or line-by-line, but at the end of each getNextStream() method call it would have read only so much that is sufficient to create one Plain XML structure. For example, in an input file, if there is sufficient data for only one Plain XML then the first call to getNextStream() would return a Plain XML and the next one would return NULL. But if there is more than one, getNextStream() calls would continue to return Plain XML structures for every incoming portion until end of file is reached.

Exception Handling Phase

Exception handling inside the FP can be categorized into two phases: **Reactive** and **Recovery**:

Reactive Phase

This phase involves catching an exception and reporting it to the GFP. It is achieved by invoking saveInvalidRow() method on the GFP (this.fileProcessor).

Note that when an exception occurs, no further parsing is done and NULL is passed back from getNextStream().

If one fails to return NULL, errors such as “Simultaneous good and bad result returned by the File Parser” can be found in the Weblogic server log.

When an exception is reported to the GFP, it does three things:

1. Creates an XML payload D1-PayloadErrorNotif and passes it to the OSB message flow. The message is published to the Notification Queue from inside PPS of the BASE OSB project.
2. It increments the “transaction error occurred” variable by invoking the utility method inside the D1 jar. All the errors occurring during the lifetime of a file parsing are captured and are reported through the message D1-PayloadSummary - which is again published to Notification Queue.

3. Finally, it creates a data file in the error directory with the portion of raw data that is read when the error occurred. It also creates a Rejected File Descriptor (RFD) file. The raw input portion is available by utilizing `getCurrentInputPortion()` method, which is discussed below.

As noted in the above image, the `saveInvalidRow()` method takes three input parameters:

1. The position at which the parsing started. It will be written to an RFD file. This is helpful in identifying the location of an error in the input file.
2. The raw data that will be written into error data file. It should be in the same to the incoming file format and it should contain data that is read since current invocation of `getNextStream()` method is started. It will allow correcting troubled data and place “fixed” file into an incoming folder for further re-processing.
3. The error message that is reported in D1-PayloadErrorNotif message. Note, the content of the error message has to be defined by the file parser developer.

Recovery Phase

This phase must not be confused with recovering from a handled exception discussed above. This case is when file parsing gets completely interrupted by power failure or network interruption.

Preparation for recovery: GFP maintains an internal index to the current read position of the file. This is achieved by GFP by invoking `getPosition()` method on the FP before every `getNextStream()` method call.

```
public long getPosition() {  
    long retVal = this.fileProcessor.getCurrentInputPosition();  
    return retVal;  
}
```

Recovery: In case of an interruption and subsequent restore, GFP sets the start position on the File Parser. For instance, if the failure had occurred at byte 415, the start position would be set to 415 so that FP starts to read from that point and not from 0. The value 415 can be referred to as the recovery point.

```
public void setStartPosition(long position) {  
    this.startPosition = position;  
}
```

When the file parser starts parsing again, two things must occur to ensure that it starts parsing from the recovery point:

1. Store the recovery point to the `startPosition` field.
2. Incorporate skip logic to start the pointer from the recovery point.

Java Implementation

The Java component of the project includes the following classes and packages:

1. **com.splwg.dg.osb.common.FileParserGenGeneric** class is a super class with members that are common for CSV and XML related functionality. It implements the `com.splwg.d1.sgg.osb.common.FileParser` interface (see [FileParser Interface](#)). The implementation of `com.splwg.d1.sgg.osb.common.FileParser2` (see [FileParser2 Interface](#)) has been added to define the IMD & Event Upload Statistics related functionality.
2. **com.splwg.dg.osb.csv.FileParserCSV** class contains the implementation of the parsing functionality for CSV formats. It performs the following logic:
 - Parses the incoming payload.
 - Transforms incoming data to Usage or Event related structures based on incoming data type.
 - Extends those structures with file information and external service provider identifier.
 - Returns one by one that structures as a stream to caller.
3. **com.splwg.dg.osb.plain** package contains JAXB related interfaces and implementation classes corresponding to the Plain XML Schema

4. **com.splwg.dg.osb.xml.FileParserXML** class contains the implementation of parsing functionality for the “IMD and Event Online Upload” XML format (See the *Oracle Utilities Service and Measurement Data Foundation User’s Guide*). It performs the following logic:

- Parses the incoming payload.
- Extracts information about current device.
- Breaks the incoming data to separate initial measurement data structures.
- Extends those structures with device information, file information and external service provider identifier.
- Returns one by one the structures as a stream to caller.

Implementation Details

This section provides an overview of the implementation details. See the comments in the source code for more detailed information.

OSB Configuration

This section outlines the OSB projects provided with the Adapter Development Kit.

OSB Project Summary

The OSB Configuration consists of four projects. These projects can be categorized by either functionality or content:

Functionality by Incoming File Format

CSV format processing:

- SGG-DG-CSV-BASE
- SGG-DG-CSV-CM

XML format processing:

- SGG-DG-SEEDER-BASE
- SGG-DG-SEEDER-CM
- SGG-DG-XML-BASE
- SGG-DG-XML-CM

Content (by purpose of content)

Content containing business logic implementation:

- SGG-DG-CSV-BASE
- SGG-DG-SEEDER-BASE
- SGG-DG-XML-BASE

Content containing configuration settings related to the objects and variables required during the processing of payloads:

- SGG-DG-CSV-CM
- SGG-DG-SEEDER-CM
- SGG-DG-XML-CM

Project Contents

The following table describes the contents of each of these projects:

Project	Description
SGG-DG-CSV-BASE	<p>Contains the components responsible for “actual” processing of data coming in CSV format. It can be upgraded in future releases without affecting the customization and environment settings that are stored in the SGG-DG-CSV-CM project. This project performs the following functions:</p> <ul style="list-style-type: none"> • Processes notification messages that are sent from the GFP. • Calls the customizable local service proxies for pre- and post- processing of passed data • Validates passed data against the XSD schema for Plain XML format • Transforms passed Plain XML into D1-InitialLoadIMD or D1-DeviceEventSeeder formats according to type of incoming data. • Sends result structures to destination JMS queue. • Updates statistic information via calling the messageFlowIncResultIMD or messageFlowIncResultEvent method accordingly. • Handles errors that occur to provide information to the File Processing component. Error handling contains separate handlers for two stages: before and after the Plain XML is transformed to the final XML structure. The separation is necessary to make Java calls to appropriate methods (messageFlowErrorOccurredPlain, messageFlowErrorOccurredIMD or messageFlowErrorOccurredEvent) according to the current processing stage and data type.
SGG-DG-CSV-CM	<p>Contains environment related configuration settings. It allows the customization and simplifies the future upgrades as well (See Configuring the OSB Project for example values).</p>
SGG-DG-XML-BASE	<p>Contains the components responsible for “actual” processing of data coming in XML format. It can be upgraded in future releases without affecting the customization and environment settings that are in SGG-DG-XML-CM project. This project performs the following functions:</p> <ul style="list-style-type: none"> • Processes notification messages that are sent from GFP. • Calls the customizable local service proxies for pre- and post- processing of passed data. • Validates passed data. • Transform passed data. In current tutorial a simple XQuery code is used just to show the functionality available for transformation. • Sends result structures to destination JMS queue in form of acceptable by the D1-DeviceEventSeeder and/or D1-InitialLoadIMD inbound web services. • Updates statistic information via calling messageFlowIncResultIMD method. • Handles errors to provides information to GFP. Error handling contains separate handlers for two stages: before and after the Plain XML is transformed to the final XML structure. The separation is necessary to make a Java calls to appropriate methods (messageFlowErrorOccurred or messageFlowErrorOccurredIMD) according to the current processing stage.
SGG-DG-XML-CM	<p>Contains environment related configuration settings. It allows the customization and simplifies future upgrades as well.</p>
SGG-DG-SEEDER-BASE	<p>Contains the components responsible for processing of data coming in “native” XML format. It can be upgraded in future releases without affecting the customization</p>

Project	Description
	<p>and environment settings that are in SGG-DG-SEEDER-CM project. This project performs the following functions:</p> <ul style="list-style-type: none"> • Processes notification messages that are sent from GFP. • Calls the customizable local service proxies for pre- and post- processing of passed data. • Validates passed data. • Splits payload into individual initial measurements and/or device events. • Sends result structures to destination JMS queue in form of acceptable by the D1-InitialLoadIMD and/or D1-DeviceEventSeeder inbound web services. • Updates statistic information via calling messageFlowIncResultIMD method. • Handles errors to provides information to GFP. Error handling contains separate handlers for two stages: before and after the Plain XML is transformed to the final XML structure. The separation is necessary to make a Java calls to appropriate methods (messageFlowErrorOccurred or messageFlowErrorOccurredIMD) according to the current processing stage.
SGG-DG-SEEDER-CM	Contains environment related configuration settings. It allows the customization and simplifies future upgrades as well.

OSB Project Implementation Details

This section provides an overview of the implementation details. For more detailed information see the comments contained in the source code.

The following diagram shows the major processes and the data flow implemented in the OSB Configuration projects. The implementation description that follows is related to CSV parsing.

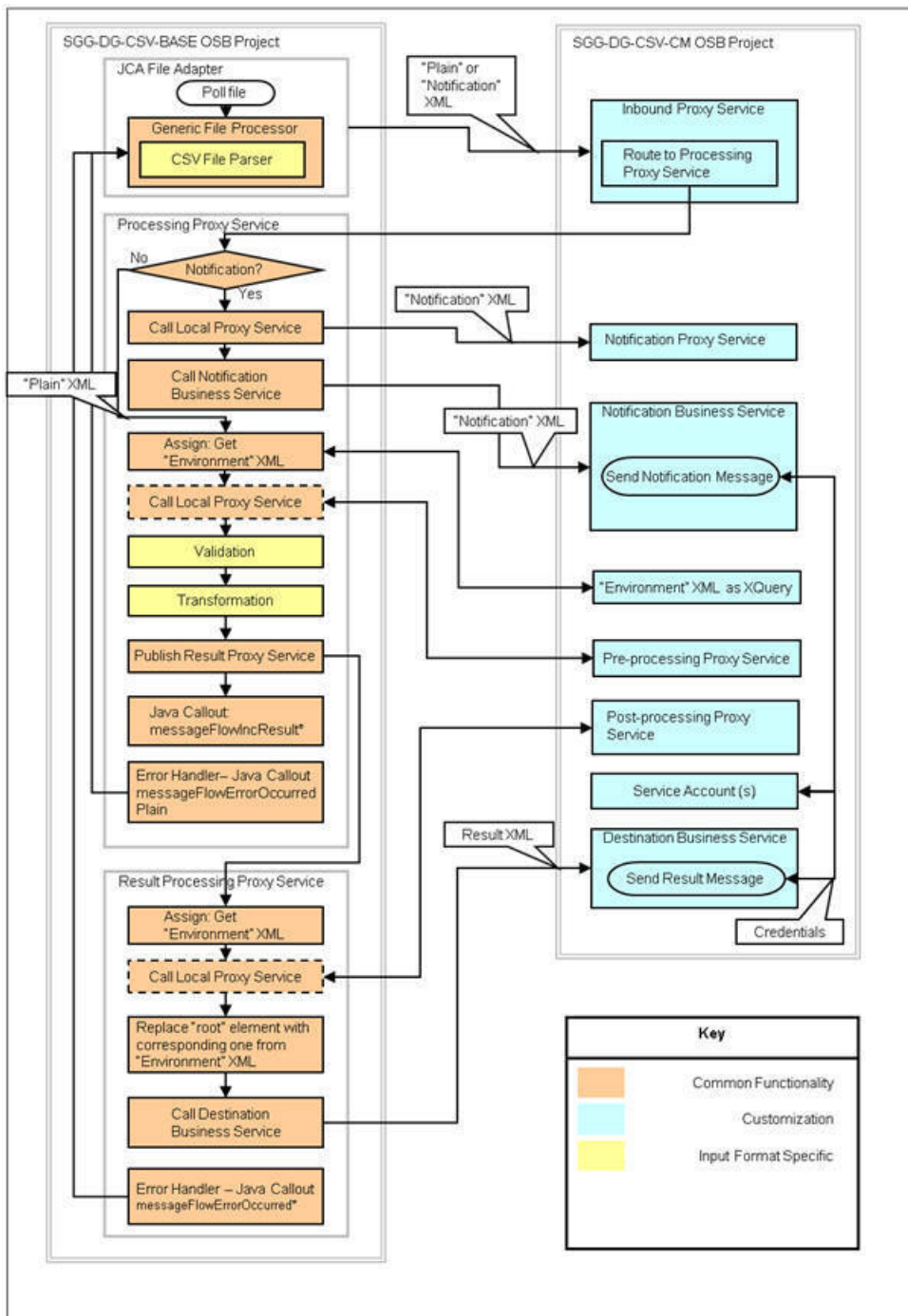

Setting Up the Adapter Environment

This section contains detailed information about the setting up of an environment with an example adapter.

Setting Up the Java Project

1. Open the sgg-osb-generic-adapter.zip file and extract the FileParser folder into a temporary location on your hard disk.
2. Create a Java project in JDeveloper and import source code into it from the folder extracted previously.
3. Add the spl-d1-osb-2.0.1.jar file to the project's Libraries and Classpath properties.

4. Deploy the project as a jar file to the destination OSB domain's lib folder.

Note: The WebLogic server should be restarted after jar file is copied to lib folder. For more details, see *Oracle Fusion Middleware Developing Applications for Oracle WebLogic Server*.

Configuring the OSB Project

1. Open the sgg-osb-generic-adapter.zip file and extract the com.splwg.dg.sgg.osb.configuration.jar file into a temporary location on your hard disk.
2. Ensure that OSB is running in the domain that is created for the adapter.
3. Import resources by using the OSB Administration Console via the **System Administration > Import/Export > Import Resources** menu item from the extracted com.splwg.dg.sgg.osb.configuration.jar file. Note that conflicts may occur during import. They will be fixed in the following steps.
4. Check and change the JCA Transport Configuration properties of the SGG-DG-CSV-CM/Proxy Services/InboundProxyService proxy service according to the deployment environment:

Where:

- **Endpoint Properties/SGG_INPUT_PARSER** is a name of class that implements file parsing functionality. See a Java project mentioned early.
 - **Endpoint Properties/SGG_ERROR_FOLDER** is a folder where a rejected transaction from incoming file will be placed in case when the parsing or validation is failed.
 - **Endpoint Properties/SGG_SP_EXT_REF_ID** is a value corresponding to the target Service Provider's external reference id on OUAF side. It is used in the XML structures related to the IMD & Event Upload Stats functionality. Also, this value will be placed into D1-InitialLoadIMD/serviceProviderExternalId and D1-DeviceEventSeeder/externalSenderId elements.
 - **Activation Spec Properties/IncludeFiles** is the naming convention that the Oracle File Adapter uses to poll for inbound files.
 - **Activation Spec Properties/PhysicalArchiveDirectory** is a folder where to archive successfully processed files.
 - **Activation Spec Properties/PhysicalDirectory** is an input folder to be polled.
5. Change the Endpoint URI in the Transport Configuration section of the SGG-DG-CSV-CM/Business Services/DestinationBusinessService business service according to the deployment environment with value containing URI for JMS server and queue where IMD or Device Event structures will be sent (see *Oracle Fusion Middleware Administrator's Guide for Oracle Service Bus* for more detail.):
 6. Change the Endpoint URI in the Transport Configuration section of the SGG-DG-CSV-CM/Business Services/NotificationBusinessService business service according to the deployment environment:
 7. Update the credentials stored in the SGG-DG-CSV-CM/Service Accounts/DestinationServiceAccount service account according to the deployment environment with user ID and password required to access JMS server:
 8. Repeat steps 4-7 for the SGG-DG-XML-CM project

Additional Information

This section contains additional information about the Adapter Development Kit.

Processing Large Input Files

In some environments, the OSB project may begin processing a large input file before it has been completely copied to the input directory. To prevent this, configure the MinimumAge property in the "InboundProxyService" proxy service. The MinimumAge property specifies the minimum age of files to be retrieved, based on the last modified time stamp. This enables large files to be completely copied to the input directory before they are retrieved for processing.

FileParser Interface

This section provides the source code of the FileParser interface used by the Java class delivered with the Java package described earlier in this section.

```
package com.splwg.dl.sgg.osb.common;
import java.io.IOException;
import java.io.InputStream;
/** <p>
 * FileParser component is responsible for processing the input
 * stream and returning a Plain XML containing all data from
 * incoming transaction in a shape expected by the following
 * Oracle Service Bus message flow.
 * </p>
 */
public interface FileParser {
    /**
     * Returns the next message in Plain XML format
     * or null if there are no more messages
     * @return next message as InputStream
     */
    InputStream getNextStream() throws IOException;
    /**
     * Returns the current position in the currently
     * parsed source input stream
     * @return the position in source input stream after
     * last incoming row was read and parsed
     */
    long getPosition();
    /**
     * Sets source stream
     * @param input the Input Stream that should be parsed
     */
    void setInputStream(InputStream input);
    /**
     * Sets "owner" FileProcessor
     * @param owner the Instance of FileProcessor that will
     * be notified about current processing via call to
     * utility methods (saveInvalidRow and setParseFinishNote)
     */
    void setProcessor(FileProcessor owner);
    /**
     * Sets the position from which the parsing of source
     * stream should be started.
     * It is necessary if last time the processing of
     * current file has been interrupted
     * @param position the starting position
     */
    void setStartPosition(long position);
    /**
     * Returns the byte array that contains a portion of an incoming
     * file that most recently has been read and converted to Plain XML.
     * It should be in the same format as incoming file. The header and
     * tail records, if there are, should be included and updated according
     * to the content
     */
    byte[] getCurrentInputPortion();
    /**
     * Returns type of currently generated transaction - USAGE or EVENT
     */
    FileProcessor.TransactionType getCurrentTransactionType();
    /**
     * Returns the number of successfully generated transactions of given type
     */
    int getTransactionCount(FileProcessor.TransactionType type);
    /**
     * Returns the number of expected transactions in input stream
     * Returns -1 if information not available
     */
    int getTotalExpected();
}
```

FileParser2 Interface

This section provides the source code of the FileParser2 interface used by the Java class delivered with the Java package described earlier in this section. This interface has been added to include a way for the File Processor to retrieve the file creation date which can be stored inside the incoming file.

```
package com.splwg.dl.sgg.osb.common;
import java.util.Date;
public interface FileParser2 extends FileParser {
    /**
     * FileProcessor usage method
     * Returns the File creation date and time stamp stored
     * in the file
     * Returns null if information not available
     */
    Date getCreationDateTime();
}
```

FileProcessor Interface

This section contains a portion of the FileProcessor interface related to the file parsing functionality.

```
package com.splwg.dl.sgg.osb.common;
public interface FileProcessor {
    public enum TransactionType {
        USAGE, EVENT
    }
    /**
     * FileParser usage method
     *
     * @return a string containing the name of currently processed inbound file
     */
    String getOrigin();
    /**
     * FileParser usage method Creates a file in the Error Folder and saves
     * passed row parameter to it
     *
     * @param position
     *         the number representing the position in file where invalid
     *         raw data is started
     * @param row
     *         the byte array containing an invalid raw data in vendor
     *         specific format the same with format of incoming file
     * @param failCause
     *         the string showing the cause of fail It will be used while
     *         logging the fail message.
     */
    void saveInvalidRow(long position, byte[] row, String failCause);
    /**
     * FileParser usage method
     * Returns the current offset in input file
     */
    long getCurrentInputPosition();
}
```

Generating Java Classes from XML Schemas

In JDeveloper you can use JAXB (Java Architecture for XML Binding) to generate Java classes from XML schemas. JAXB is an easy way to incorporate XML data and processing functions in Java applications without having to know XML. You can generate a JAXB 1.0 or 2.0 content model, including the necessary annotations, from an XML schema.

When the JAXB binding compiler is run against an XML schema, JAXB packages, classes, and interfaces are generated. You can then use the generated JAXB packages and the JAXB utility packages in a binding framework to unmarshal, marshal, and validate XML content.

To generate Java classes from XML schemas with JAXB:

1. From the main menu choose **File > New > Business Tier > TopLink/JPA** and select either JAXB 1.0 or 2.0 Content Model from XML Schema to open the compilation dialog.
2. Select the schema file and optionally the JAXB customization file to use and the package to which the generated classes will be added.

The JAXB package and generated classes are added to the Application Resources folder.

Business Processing Execution Language Processing

This section describes the Business Process Execution Language (BPEL) processes included in the Oracle Utilities Smart Grid Gateway Adapter Development Kit that support two-way communication between the adapter and the head-end system. The ideas and general practices described in this section can be applied to any other adapter.

WSDLs, Endpoints, and Messages

WSDLs are Web Service Definition Language files that describe a web service. New services must utilize the WSDLs to determine the structure of requests and responses. For remote services, they contain the locations to access the services. For both remote and local (hosted) services, the files will contain the definitions for each web service including names, arguments, exceptions, and the structure of the input and output messages.

In Oracle Service Oriented Architecture (SOA), WSDLs can be classified as a “service” or as a “reference.” Services are hosted on the SOA server; that is, the implementation of the web service is on the local application server. Referenced services are implemented on a different server. This distinction is also relevant to the composite level. Services are implemented in the current composite. References are located elsewhere, possibly on the same app server, but in a different composite.

An “endpoint” is simply the URL for a web service. Since web services communicate via HTTP, each will have a unique URL. Once a service’s endpoint is known, a message service can be targeted to it.

How to locate WSDLs and Endpoints

There are two ways to locate WSDLs in an installed Adapter: through Enterprise Manager and by using a direct URL. Only “hosted” WSDLs can be located in this way. Referenced (remote) WSDLs must be either located in source code or obtained from the hosted location.

How to Use Enterprise Manager to Locate WSDLs and Endpoints:

1. Open Enterprise Manager and use the navigation pane to open the Dashboard of the desired composite.
2. The top bar of the Dashboard contains several buttons and icons. One of these is an “earth” icon with a puzzle piece over it. Click this icon to display the WSDL and endpoint URIs for the composite.
3. Click the URL link to see the WSDL in the browser, or right click and save it to your machine for use in developing new services.

Depending on the requirements, It may be necessary to download the associated schema or WSDL file(s). Schemas are available within the WSDL’s “types” element. Find associated WSDL URLs within the import element. That URL can be pasted into a browser tab.

The endpoint for the service is also visible in this window. It is this URL that should be added to message sender configuration. For example:

The value HTTP Header/SOA Action is taken from the service’s WSDL. Locate the `wSDL:definitions/wSDL:binding/wSDL:operation/soap:operation` element for the web method being invoked. An attribute called `soapAction` will contain the value for this field. A shortcut to this field is using Enterprise Manager’s Testing framework (locate the Test tab from the dashboard view for the composite). Once the WSDL is parsed, the SOAP Action will appear in a field on the request tab:

The values **HTTP Login User** and **HTTP Login Password** should be set to a valid WebLogic user that has access to the module. The **HTTP Method** should always be set to POST and the HTTP URL 1 should be set to the value of the endpoint above.

How to Use a Direct URL to Locate WSDLs and Endpoints

The WSDLs can be accessed without Enterprise Manager by understanding the paths used on the SOA server. In general, they have the form:

```
http://{server name}:{port number}/soa-infra/services/{partition}/{Composite}/{Web Service}
```

Composite Components

This section outlines several important logical features of the BPEL composites.

Composite Properties

Most composites contain properties within the main file, composite.xml. They are essentially global constants that can be preconfigured with default values and changed at deployment time. They can be accessed post-deployment in Enterprise Manager.

Typically, these properties represent timeouts and boolean properties for activating or deactivating functionality. Other uses might include setting default values of constants such as URLs. They are accessed with the `ora:getPreference()` BPEL function.

They can be changed during development, at deployment time, or after deployment using different techniques for each.

Development Changes

At development time, properties can be created at will within the “component” sections of the composite.xml file. The image below shows an example of the properties found in DeviceStatusCheck:

```
<component name="DeviceStatusCheck">
  <implementation.bpel src="DeviceStatusCheck.bpel"/>
  <property name="bpel.preference.isExecutingInitODRequestReceivedCallout">true</property>
  <property name="bpel.preference.isExecutingInitODEventRequestCompleted">true</property>
  <property name="bpel.preference.isExecutingODEventNotificationArrived">true</property>
  <property name="bpel.preference.timeout.callback.years">0</property>
  <property name="bpel.preference.timeout.callback.months">0</property>
  <property name="bpel.preference.timeout.callback.days">0</property>
  <property name="bpel.preference.timeout.callback.hours">0</property>
  <property name="bpel.preference.timeout.callback.minutes">0</property>
  <property name="bpel.preference.timeout.callback.seconds">45</property>
  <property name="bpel.preference.OD_ServerCallbackEndpoint">http://127.0.0.1:8001/soa-infra/serve
  <property name="bpel.preference.externalSenderID">DSC Sensus</property>
  <property name="partnerLink.OD_ServerProxy.idempotent" type="xs:string"
    many="false">>false</property>
</component>
```

Properties must be prefixed with “bpel.preference.” The BPEL process associated with them (see the `implementation.bpel` element) can use the `ora:getPreference()` method to extract the value. When accessing the values, the “bpel.preference” prefix is dropped.

Pre-Deployment Changes

While the values of properties cannot be changed at runtime, they can be altered using the configuration plan each composite uses for deployment. Most configuration plans will contain multiple property elements within the “component” section. Modifying the value in the replace element and redeploying the composite will change the behavior of the property:

```

<component name="DeviceStatusCheck">
  <property name="bpel.preference.isExecutingInitODRequestReceivedCallout">
    <replace>true</replace>
  </property>
  <property name="bpel.preference.isExecutingInitODEventRequestCompleted">
    <replace>true</replace>
  </property>
  <property name="bpel.preference.isExecutingODEventNotificationArrived">
    <replace>true</replace>
  </property>
  <property name="bpel.preference.timeout.callback.years">
    <replace>0</replace>
  </property>
  <property name="bpel.preference.timeout.callback.months">
    <replace>0</replace>
  </property>
  <property name="bpel.preference.timeout.callback.days">
    <replace>0</replace>
  </property>

```

When the composite is deployed, the properties will contain the values in the “replace” elements.

Post-Deployment Changes

After deployment, changes can still be made to the values of the properties through Enterprise Manager.

1. In the Enterprise Manager navigation window, open WebLogic Domain/{domain name}. Right click on the domain and select **System MBean Browser**.
2. A new navigation pane opens in the window on the right. Select **Application Defined MBeans/oracle.soa.config/Server: {domain name}/SCAComposite/{Composite} [1.0]/SCAComposite.SCAComponent/{Component}** to access the controls for a particular component. A “component” is a single BPEL or Mediator within a larger SOA composite
A list of options will open in the right pane.
3. Select **Properties**.
The Property sheet shows a list of all the properties. Opening one allows editing of the property value.
4. Click **Apply** to save any changes.

Proxies

Proxy web services make no changes to the data going through the system and are just used to centralize endpoint configuration. The message structures are identical to those of the head-end system. Data is passed through without modification. Mediator objects within the Common composite are used to move data from Oracle Utilities Smart Grid Gateway to the head-end system.

Process Callouts

Some services are designated as “Process Callouts.” These services allow integrators direct access to the XML coming to and from the head-end system. They are useful in the event the integrator needs to provide custom enrichment or transformation of the inbound or outbound data. Because process callouts are generally located before and after calls to the head-end system or when data arrives, they can also serve as an “event” trigger if the integrator requires additional processing logic. The services define identical inputs and outputs and are based on head-end schema definitions. To use a callout, the integrator should create a web service implementing one or more of the WSDLs defined in the Common composite. Other composites should then be configured to target the new Callout-type service.

A typical example is for re-rendering the meter identifier being sent to the head-end system. If the standard meter ID should be modified, a process callout service is a candidate for making this change. Note that because the schema is based off the head-end system's definition, deviations from the schema are not allowed.

Configuring and Customizing Adapter BPEL Processes

This section outlines how to configure and customize the Oracle Business Process Execution Language (BPEL) processes provided with the Adapter Development Kit to work with your implementation.

Editing Configuration Files

This section outlines the changes that need to be made in various configuration and build files to enable the application servers used in your implementation to communicate with each other, and to support the specifics of your head-end system. These files are also used in packaging and deploying the processes.

Server Definitions

In order for your adapter to work properly, you must set up the application servers that run the components used by the adapter communicate with each other as follows:

- The Oracle Utilities Smart Grid Gateway application server must be able to send and receive messages to and from the SOA Suite application server.
- The SOA Suite application server must be able to send and receive messages to and from the head-end system application server, and the Oracle Utilities Smart Grid Gateway application server
- The head-end system application server must be able to receive and send messages from and to the SOA Suite application server.

The types of servers and the tokens that need to be replaced for each are listed below. Further below are the specific configuration files that must be modified, as well as the locations in each file that must be modified. Note that a port is listed, but may not be necessary depending on the type of installation. Also note that the SOA Server will have to have the partition name defined that is used.

- **SOA Server:** This is the application server running the SOA Suite components, including Oracle Service Bus (OSB) and Oracle Business Process Execution Language (BPEL). The SOA server is referenced using the following tokens:
 - {SOA_HOST}: the server where the SOA server has been installed
 - {SOA_PORT_NUMBER}: the port used by the SOA server
 - {SOA_PARTITION_DG}: the partition used by the SOA server. There are different partitions for the different adapters used by Oracle Utilities Smart Grid Gateway.
- **XAI (OUAF) Server:** This is the application server running the Oracle Utilities Smart Grid Gateway (including the Oracle Utilities Application Framework, or OUAF) software, including the inbound/outbound message components. This server is referenced using the following tokens:
 - {WEB_WLHOST}: the server where Oracle Utilities Smart Grid Gateway and the message components have been installed
 - {WEB_WLPORT}: the port used by the Oracle Utilities Smart Grid Gateway application
 - {WEB_CONTEXT_ROOT}: the root directory at which the Oracle Utilities Smart Grid Gateway inbound web service
- **AMI Head-end Server:** This is the application server running the head-end system software. The AMI head-end server is referenced using the following tokens:
 - {Headend_MR_Server_DG}: the URL for either the actual head-end system's MR_Server MultiSpeak implementation, or the URL to an emulator test harness being used (if applicable). For example, the Adapter Development Kit includes a soapUI configuration that can be used to emulate a head-end system for testing purposes.

- {Headend_CD_Server_DG}: the URL for either the actual head-end system's CD_Server MultiSpeak implementation, or the URL to an emulator test harness being used (if applicable). For example, the generic adapter includes a soapUI configuration that can be used to emulate a head-end system for testing purposes.
- Headend_OD_Server_DG}: the URL for either the actual head-end system's MR_Server MultiSpeak implementation, or the URL to an emulator test harness being used (if applicable). For example, the generic adapter includes a soapUI configuration that can be used to emulate a head-end system for testing purposes.

In addition, credentials for the WebLogic server must be specified in the build.properties file in the deploy folder:

- {WebLogic_UserID}: the user ID used to connect to the WebLogic server
- {WebLogic_Password}: the password for the {WebLogic_UserID} used to connect to the WebLogic server

Customizing BPEL Processes

This section provides an overview of how the sample BPEL processes provided with the Oracle Utilities Smart Grid Gateway Adapter Development Kit can be customized to meet specific business requirements, such as using custom XSL transformations and adding/editing the steps involved in the process.

Using Custom XSL Files

This process references XSL files to transform the messages from the Oracle Utilities Smart Grid Gateway standard format into the format used by the “generic” head-end system (based on the Multispeak protocol) when sending messages to the head-end system, and from the head-end system format into the Oracle Utilities Smart Grid Gateway standard format when sending messages back to Oracle Utilities Smart Grid Gateway. These XSL file references can be changed to custom XSL files that transform the messages into and from the format used by your head-end system. Refer to Oracle BPEL and Oracle JDeveloper documentation for more information about referencing XSL files within a BPEL process.

Making Changes to the Process

In addition to referencing custom XSL files for transformation, you can also add additional steps to the process to meet the specific business requirements of your implementation, or make other changes to the existing steps. Refer to Oracle BPEL and Oracle JDeveloper documentation for more information about adding and/or changing steps within BPEL process.

Note: Any changes made to this process for a particular AMI vendor and head-end system needs to be modeled based on the head-end system/AMI vendor’s business processes, including configuring the required request/response transactions required for a specific command (such a remote connect).

Commands

This section describes the general structure and flow of each SOA composite in the adapter development kit for the two-way commands. Most follow this basic model:

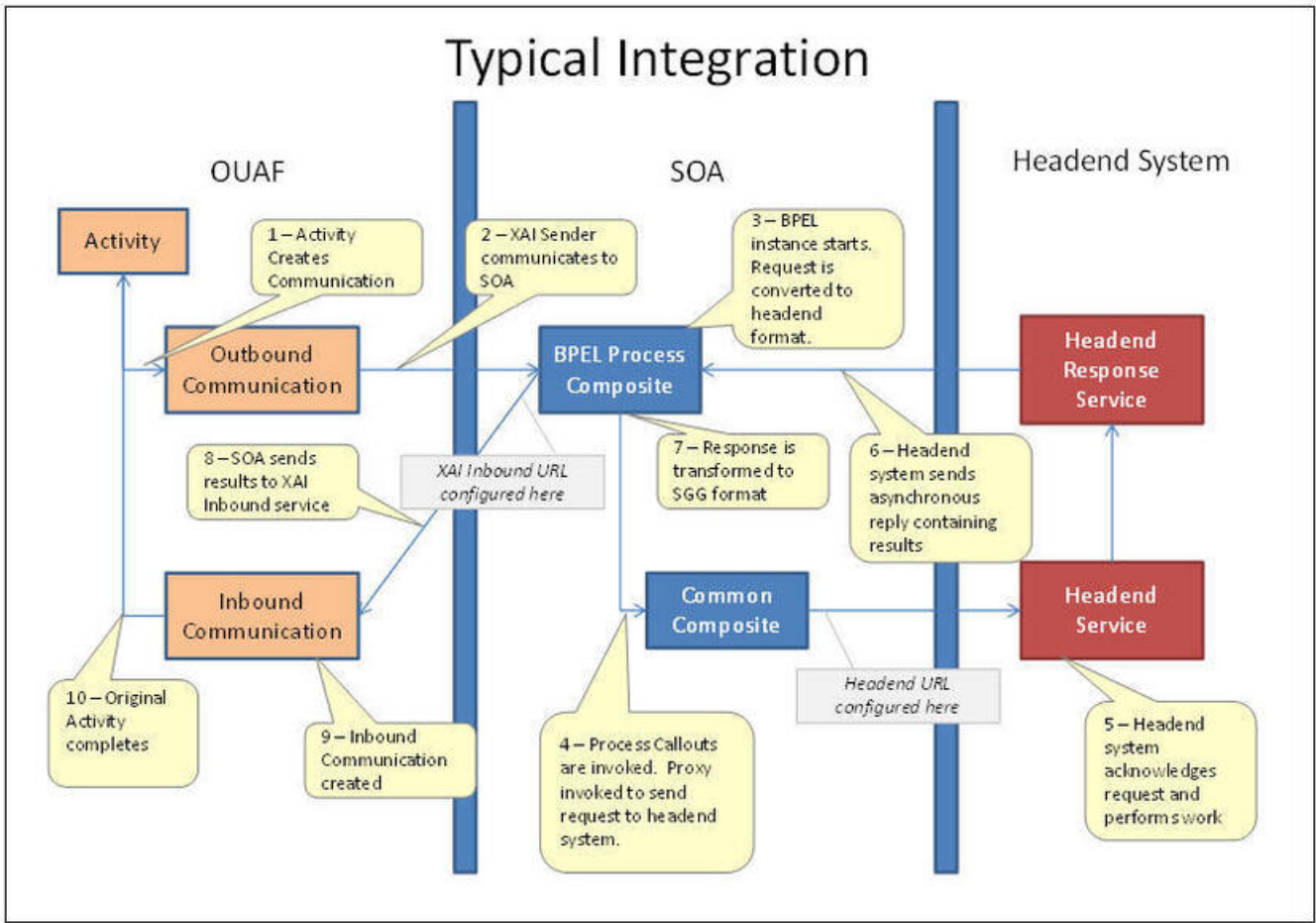

Common

The Common composite is a repository for files and logic that is used by other composites. For instance, the Proxies and default implementations of Process Callouts are defined in the Common composite.

Composite Properties

None.

Composite WSDLs

Callout Services

Process Callouts are customization points for integrators with identical inputs and outputs based on head-end formats. The Common composite contains default implementations in which incoming data is reflected back in an identical state. Each of the following is a Mediator component and uses an “echo”-type definition.

Process Callouts are usually associated with boolean composite properties which control whether they will be executed. They are activated by default so users can easily inject their customizations, but setting the properties to false can be a performance optimization. When set to false, the associated Process Callout will not be made and execution will continue normally.

Service	Description
OA_CalloutService	Used when the asynchronous reply in DeviceStatusCheck arrives.

Service	Description
MR_CalloutService	Used during Commission/Decommission and OnDemandRead operations.
CB_CalloutService	Used by the asynchronous callback processes of OnDemandRead and Connect/Disconnect.
CD_CalloutService	Used by Connect/Disconnect.
OD_CalloutService	Used in DeviceStatusCheck.

Proxies

Placing all the proxy web services in the Common composite creates a place to conveniently set endpoints. Each is a Mediator component which passes the data to the head-end system without modification

Proxy Web Service	Description
OD_ServerProxy	Used to transmit a DeviceStatusCheck request to the head-end system.
CD_ServerProxy	Used to transmit a Connect/Disconnect request to the head-end system.
MR_ServerProxy	Used to transmit an OnDemandRead request to the head-end system.

Other

AuxiliaryRoutinesService: A container defining helpful, commonly used functions:

- **FindExpTime:** Many MultiSpeak functions contain an expTime element, which is used to deliver the length of time to wait for the command to complete before failing. (The included test harness does not support timeouts.) If the input to the command composite does not contain this timeout, the process will read from its properties the years, months, days, hours, minutes, and seconds to wait for a result. This web service utilizes a Java method to combine these inputs into the proper XML field used in the MultiSpeak API. The properties are also used to control the timeout wait period of asynchronous callbacks within a command's BPEL process.
- **FindTimeout:** When the expTime element and units are supplied as input, it is usually still necessary to compute the timeout used in asynchronous callbacks. This method accepts the MultiSpeak fields and replies in the "P0Y0M0DT0H0M0S" format understood by BPEL.

Commission / Decommission

The CommissionDecommission composite takes care of registering and de-registering a device with the head-end system.

Composite Properties

Property Name	Default Value	Description
isExecutingCommissionReceived-Callout	true	Controls whether the Request Arrived callout executes.
isExecutingCommissionCompleted-Callout	true	Controls whether the Request Completed callout executes.
isExecutingDecommissionReceived-Callout	true	Controls whether the Request Arrived callout executes.
isExecutingDecommissionCompleted-Callout	true	Controls whether the Request Completed callout executes.

Composite WSDLs

Composite	Description
CommissionDecommission Service	Entry point for the CommissionDecommission command. The operations are synchronous, so no additional WSDLs are needed.
MR_ServerCallout	Reference describing the process callout.
MR_ServerProxy	Reference describing the proxy used to invoke the head-end system.

Process Flow

1. SGG/OUAF invokes MeterAddNotification/MeterRemoveNotification operation using CommissionDecommissionService.
2. Test whether MeterAddNotification or MeterRemoveNotification is invoked. In both cases, the following steps are common for both the operations.
3. Composite properties are loaded and local variables are initialized.
4. Both the Header and Body inputs are transformed to MultiSpeak format.
5. If required, execute a process callout in MR_ServerCallout. Assign updated data to head-end request.
6. Invoke MeterAddNotification/MeterRemoveNotification via the MR_ServerProxy to the head-end system.
7. If required, execute a process callout in MR_ServerCallout. Assign updated data to head-end response.
8. Transform Header and Body head-end responses to SGG/OUAF format.
9. Reply to SGG/OUAF with synchronous results.

Connect / Disconnect

The ConnectDisconnect composite is responsible for starting and stopping the recording of usage data for a meter.

Composite Properties

Property Name	Default Value	Description
CB_CDcallbackEndpoint	http://[SERVER_NAME]/soa-infra/services/DG/ConnectDisconnect/CB_ServerService	The default endpoint to which MultiSpeak should send the asynchronous CB_Server callback.
isExecutingCDReceivedCallout	true	Controls whether the Request Received callout executes.
isExecutingCDCompletedCallout	true	Controls whether the Request Received Completed callout executes.
isExecutingCDStatesChangedArrivedCallout	true	Controls whether the CD States Changed Notification arrival callout executes.
CallbackTimeoutYears	0	The number of years to await a response from the MultiSpeak server. This property only takes effect when the expTime element is

Property Name	Default Value	Description
		not supplied in the input to the service.
CallbackTimeoutMonths	0	The number of months to await a response from the MultiSpeak server. This property only takes effect when the expTime element is not supplied in the input to the service.
CallbackTimeoutDays	0	The number of days to await a response from the MultiSpeak server. This property only takes effect when the expTime element is not supplied in the input to the service.
CallbackTimeoutHours	0	The number of hours to await a response from the MultiSpeak server. This property only takes effect when the expTime element is not supplied in the input to the service.
CallbackTimeoutMinutes	0	The number of minutes to await a response from the MultiSpeak server. This property only takes effect when the expTime element is not supplied in the input to the service.
CallbackTimeoutSeconds	45	The number of seconds to await a response from the MultiSpeak server. This property only takes effect when the expTime element is not supplied in the input to the service.

Composite WSDLs

Composite	Description
ConnectDisconnectService	Entry point for the ConnectDisconnect operation. After a synchronous reply, further updates will be sent to the specified location asynchronously using DG-ConnectDisconnectStateChgNotification.
CB_ServerService	MultiSpeak WSDL hosted to receive asynchronous CDStatesChangedNotification callbacks from the head end system.
CB_ServerCallout	Reference describing the process callout used when the asynchronous callback from the head end system arrives.
CD_ServerCallout	Reference describing the process callout.

Composite	Description
CD_ServerProxy	Reference describing the proxy used to invoke the head end system.
AuxiliaryRoutines	Reference to common helper routines in the Common composite.
DG-ConnectDisconnectStateChgNotification	A reference to an inbound web service capable of processing asynchronous results from a Connect/Disconnect request.

Process Flow

1. SGG/OUAF invokes InitiateConnectDisconnect operation using ConnectDisconnectService.
2. Composite properties are loaded and local variables are initialized.
3. Test whether the input includes a expiration time
 - If Yes: Use AuxiliaryRoutines to compute timeout.
 - If No: Use composite properties and AuxiliaryRoutines to compute expiration time.
4. Both the Header and Body inputs are transformed to MultiSpeak format.
5. If required, execute a process callout in CD_ServerCallout. Assign updated data to head end request.
6. Add a callback URL to the head end request. This is the endpoint the head end will use to send the results.
7. Invoke InitiateConnectDisconnect via the CD_ServerProxy to the head end system.
8. If required, execute a process callout in CD_ServerCallout. Assign updated data to head end response.
9. Transform Header and Body head end responses to SGG/OUAF format.
10. Reply to SGG/OUAF with synchronous results.
11. Check for ErrorObject in the head end response.
12. If error object not found:

Await asynchronous response from head-end system for the period of expiration time calculated during start of this flow:

 - Receive CDStatesChangeNotification from CB_ServiceService.
 - Generate reply with no errors for CDStatesChangeNotification
 - Synchronously reply to the head end.
 - If required, execute a process callout in CB_ServerCallout. Assign updated data to the incoming request.
 - Transform Header and Body of incoming request to OUAF inbound web service format described in DG-ConnectDisconnectStateChgNotification.
 - If request contains responseURL
 - Invoke the inbound web service on given responseURL with the transformed incoming request.
 - Else
 - Invoke the inbound web service on definedURL with the transformed incoming request.

Device Status Check

DeviceStatusCheck is used to determine the health of a meter and to test that the meter can be reached on the network.

Composite Properties

Property Name	Default Value	Description
OD_ServerCallbackEndpoint	http://127.0.0.1:8001/soa-infra/services/DG/DeviceStatusCheck/OA_ServerService	The default endpoint to which MultiSpeak should send the asynchronous OA_Server callback.
isExecutingInitODRequest-ReceivedCallout	true	Controls whether the Request Arrived callout executes.
isExecutingInitODEventRequest-Completed	true	Controls whether the Request Completed callout executes.
isExecutingODEventNotification-Arrived	true	Controls whether the ODEventNotification arrival callout executes.
timeout.callback.years	0	The number of years to await a response from the MultiSpeak server. This property only takes effect when the expTime element is not supplied in the input to the service.
timeout.callback.months	0	The number of months to await a response from the MultiSpeak server. This property only takes effect when the expTime element is not supplied in the input to the service.
timeout.callback.days	0	The number of days to await a response from the MultiSpeak server. This property only takes effect when the expTime element is not supplied in the input to the service.
timeout.callback.hours	0	The number of hours to await a response from the MultiSpeak server. This property only takes effect when the expTime element is not supplied in the input to the service.
timeout.callback.minutes	0	The number of minutes to await a response from the MultiSpeak server. This property only takes effect when the expTime element is not supplied in the input to the service.
timeout.callback.seconds	45	The number of seconds to await a response from the MultiSpeak server. This property only takes effect when the expTime element is not supplied in the input to the service.

Composite WSDLs

Composite	Description
OD_ServerService	Entry point for DeviceStatusCheck. After a synchronous reply, further updates will be sent to the specified location asynchronously using DG-OutageDetectionEventNotification.
OA_ServerService	MultiSpeak WSDL hosted to received asynchronous ODEventNotification callbacks from the head end system.
OD_ServerProxy	Reference describing the proxy used to invoke the head end system to initiate a Device Status Check.
OA_ServerCallout	Reference describing the process callout used when the asynchronous callback from the head end system arrives.
OD_ServerCallout	Reference describing the process callout used when initiating a Device Status Check.
AuxiliaryRoutines	Reference to common helper routines in the Common composite.
DG-OutageDetectionEventNotificationXAI	A reference to an inbound web service capable of processing asynchronous results from a Device Status Check request.

Process Flow

1. SGG/OUAF Initiates the Outage Detection service using OD_ServerService
2. Composite properties are loaded. Local variables are initialized. These mostly include boolean settings describing the state (such as whether or not the synchronous reply from the head-end system returned)
3. Test whether the input includes a expiration time (expTime element).
 - If Yes: Use AuxiliaryRoutines to compute timeout
 - If No: Use composite properties and AuxiliaryRoutines to compute expiration time
4. Both the Header and Body inputs are transformed to MultiSpeak format. This can be done either through direct mapping or through XSLT. In this instance, XSLT is used to transform the header and the body separately.
5. If the composite property indicates the process callout should occur, execute the “request arrived” process callout in OD_CalloutService. Assign updated data to head end request.
6. Add a callback URL to the head end request. This is the endpoint the head end will use to send the outage detection results. Some head end systems use other approaches, such as pre-configuring the URL for callbacks or allowing polling to find the results. In this case, the URL is configured in a composite property and corresponds to an implementation of the OA_Server WSDL. When the head end system has results, it will deliver them to this URL using the ODEventNotification method.
7. Invoke InitiateOutageDetectionEventRequest via the OD_ServerProxy to the head end system.
8. Split processing to handle simultaneous activities. The Flow activity does this in BPEL and it makes sense here because one process will handle a synchronous response and return it to the caller. The other process will sleep, or “dehydrate,” until the asynchronous ODEventNotification arrives or until the timeout value is reached.
 - Handle synchronous response to SGG/OUAF
 - If the composite property indicates the process callout should occur, execute the “request completed” process callout in OD_CalloutService. Assign updated data to head end response.
 - Transform Header and Body head end responses to SGG/OUAF format.

- Reply to SGG/OUAF with synchronous results.
 - Set boolean variable indicating that the synchronous reply has been returned.
 - Await asynchronous response from head-end system.
 - Receive ODEventNotification from OA_ServerService. If the timeout period elapses, raise an error and stop waiting.
 - Synchronously reply to the head end with no errors
 - If the composite property indicates the process callout should occur, execute the “data arrived” process callout in OA_CalloutService. Assign updated data to the incoming request.
 - Transform Header and Body to inbound web service format described in DG-OutageDetectionEventNotification.
 - Invoke the inbound web service with the new data.
9. Fault Handlers look for any remote Fault returned from the head-end system. The MultiSpeak API does not define named faults, but they are still possible to encounter. For example, a security error or network error could be raised.
- If the synchronous reply has been sent back to the caller, Terminate the flow. This indicates an error has occurred and more research in Enterprise Manager is warranted.
 - If the synchronous reply has not been sent, stop further processing and compose a reply which contains the fault information.

On Demand Read

OnDemandRead interrogates a meter for the usage at the current point in time.

Composite Properties

Property Name	Default Value	Description
CB_ServerCallbackEndpoint	http://[SERVER_NAME]/soa-infra/services/DG/OnDemandRead/CB_Server	The default endpoint to which MultiSpeak should send the asynchronous CB_Server callback
IsExecutingOnDemandReadRequestReceived	true	Controls whether the Request Received callout executes
IsExecutingOnDemandReadRequestReceivedResponse	true	Controls whether the Request Received Completed callout executes
IsExecutingReadingChangedNotification	true	Controls whether the Reading Changed Notification arrival callout executes
CallbackTimeoutYears	0	The number of years to await a response from the MultiSpeak server. This property only takes effect when the expTime element is not supplied in the input to the service.
CallbackTimeoutMonths	0	The number of months to await a response from the MultiSpeak server. This property only takes effect when the expTime element is not supplied in the input to the service.
CallbackTimeoutDays	0	The number of days to await a response from the MultiSpeak server. This property only takes effect when the

Property Name	Default Value	Description
		expTime element is not supplied in the input to the service.
CallbackTimeoutHours	0	The number of hours to await a response from the MultiSpeak server. This property only takes effect when the expTime element is not supplied in the input to the service.
CallbackTimeoutMinutes	0	The number of minutes to await a response from the MultiSpeak server. This property only takes effect when the expTime element is not supplied in the input to the service.
CallbackTimeoutSeconds	45	The number of seconds to await a response from the MultiSpeak server. This property only takes effect when the expTime element is not supplied in the input to the service.

Composite WSDLs

Composite	Description
OnDemandReadService	Entry point for the OnDemandRead operation. After a synchronous reply, further updates will be sent to the specified location asynchronously using DG-ReadingChangedNotification.
CB_ServerService	MultiSpeak WSDL hosted to receive asynchronous ReadingChangedNotification callbacks from the head end system.
MR_ServerProxy	Reference describing the proxy used to invoke the head end system to initiate a On Demand Read.
MR_ServerCallout	Reference describing the process callout used when initiating a On Demand Read.
CB_ServerCallout	Reference describing the process callout used when the asynchronous callback from the head end system arrives.
AuxiliaryRoutines	Reference to common helper routines in the Common composite.
DG-ReadingChangedNotificationXAI	A reference to an inbound web service capable of processing asynchronous results from a On Demand Read request.

Process Flow

1. SGG/OUAF invokes InitiateMeterReadingsByMeterID operation using OnDemandReadService.
2. Composite properties are loaded. Local variables are initialized.
3. Test whether the input includes a expiration time
 - If Yes: Use AuxiliaryRoutines to compute timeout
 - If No: Use composite properties and AuxiliaryRoutines to compute expiration time
4. Both the Header and Body inputs are transformed to MultiSpeak format.
5. If required, execute a process callout in MR_ServerCallout. Assign updated data to head end request.
6. Add a callback URL to the head end request. This is the endpoint the head end will use to send the results.

7. Invoke `InitiateMeterReadingsByMeterID` via the `MR_ServerProxy` to the head end system.
8. If required, execute a process callout in `MR_ServerCallout`. Assign updated data to head end response.
9. Transform Header and Body head end responses to SGG/OUAF format
10. Reply to SGG/OUAF with synchronous results
11. Check for `ErrorObject` in the head end response.
12. If error object not found
 - Await asynchronous response from head end for the period of expiration time calculated during start of this flow
 - Receive `ReadingChangedNotification` from `CB_ServiceService`.
 - Generate reply with no errors for `ReadingChangedNotification`.
 - Synchronously reply to the head end.
 - If required, execute a process callout in `CB_ServerCallout`. Assign updated data to the incoming request.
 - Transform Header and Body of incoming request to OUAF inbound web service format described in `DG-ReadingChangedNotificationXAI`.
 - If request contains `responseURL`
 - Invoke the inbound web service on given `responseURL` with the transformed incoming request.
 - Else
 - Invoke the inbound web service on `definedURL` with the transformed incoming request.

Working with Enterprise Manager

Oracle Enterprise Manager (OEM) is useful for troubleshooting and diagnosing issues communicating with the head end system. In particular, security and other communications issues can be discerned.

To locate the instance of a service that is showing a problem, open the **Dashboard** view of the service. Each run instance is time-indexed. The **State** column in the first table contains the most important information for each instance. Completed messages show up with a green check icon. Terminated instances are indicated with a grey stop icon. Instances that are still running are marked as such. Runtime exceptions are in the bottom window.

When you click on the instance ID, a new window opens showing the entire process flow. This view is particularly useful in debugging.

Note the **State** column showing the status of each instance within the flow. SOA processes are made up of several calls to SOA components and web services. The **Instance** column shows a rough ordering of the operations. A typical approach to troubleshooting would find the “lowest” instance of an error or termination. This would be the error that is deepest within the process and is usually the source of the problem. In the above case, the deepest error is in the very first composite for the process. More information can be found by clicking into the link within the **Instance** column.

The level of detail is dependent on the auditing level set on the server. In this case, the error is in the response from the head end system.

OEM also contains a centralized location to control security. On a **Dashboard** screen for a composite, the **Policies** tab shows the OWSM policies attached to the composite. Typically, a log policy is placed on any inbound or outbound communication. Also, all services or references are delivered with attached basic http security policies.

MultiSpeak Implementation

This section lists the subset of MultiSpeak schemas and WSDLs utilized by the Adapter Development Kit.

MultiSpeak Head End System Service Definitions

- CB_Messages.wsdl
- CB_Server.wsdl
- CD_Messages.wsdl
- CD_PortTypes.wsdl
- CD_Server.wsdl
- MR_Messages.wsdl
- MR_PortTypes.wsdl
- MR_Server.wsdl
- OA_Messages.wsdl
- OA_Server.wsdl
- OA_ServerCollisions.wsdl
- OD_Messages.wsdl
- OD_PortTypes.wsdl
- OD_Server.wsdl

MultiSpeak Head End XML Schemas

- cpsm.xsd
- gml.xsd
- xlink.xsd
- mspcommon.xsd
- CB_Server.xsd
- CD_Server.xsd
- MR_Server.xsd
- OA_Server.xsd
- OD_Server.xsd

Configuring an Adapter Development Kit Head-End System

This section outlines the configuration required for the Oracle Utilities Smart Grid Gateway to communicate with the smart meters.

Inbound Web Services

Inbound web services define the details of how messages are received from an external system. This includes incoming usage and device events, as well as messages sent from the head-end system in response to a command request.

The following inbound web services must be configured in your system. If these are not present in your configuration, add them. Refer to the Oracle Utilities Application Framework documentation for more information about creating inbound web services.

Inbound Web Service Name	Description
D1-BulkRequestHeader	Bulk Request Header

Inbound Web Service Name	Description
D1-BulkRequestUpdate	Bulk Request Update
D1-BulkResponse	Bulk Response
D1-DeviceEventSeeder	Device Event Seeder
D1-DeviceStatusCheck	Device Status Check
D1-InitialLoadIMD	IMD Seeder
D1-PayloadErrorNotif	Payload Error Notification
D1-PayloadStatistics	Payload Statistics
D1-PayloadSummary	Payload Summary
DG-ConDisconStChgNotification	Initiate Connect Disconnect Response
DG-OutageDetectionEventNotification	Initiate Outage Detection Response
DG-ReadingChangedNotification	Reading Changed Notification

Note: The following apply to all of the above inbound web services:

Message Options

- **Trace:** No
- **Debug:** No
- **Active:** Yes

Operations

- **Operation Name:** Same as web service name
- **Schema Type:** Business Object
- **Schema Name:** Applicable business object code
- **Transaction Type:** Add

Message Senders

Message senders define the details of how messages are sent to an external system, such as messages containing device command requests.

The following message senders must be configured in your system. If these are not present in your configuration, add them. Refer to the Oracle Utilities Application Framework documentation for more information about creating message senders.

Message Sender	Description
DG-COMM	Generic Adapter Commission
DG-DCOMM	Generic Adapter Decommission
DG-INTOUTDET	Initiate Outage Detection Request
DGXAISSender	Used for Meter Decommission

Note: The following apply to all of the above message senders:

Main Tab:

- **Invocation Type:** Real-time
- **Message Class:** RTHTTPSNDR (Sender routes message via HTTP real-time)
- **MSG Encoding:** UTF-8 message encoding

Context Tab:

- **HTTP Header:** SOAPAction: <OPERATION>
- **HTTP Login User:** <USER_ID>

- **HTTP Login Password:** <PASSWORD>
- **HTTP Method:** POST
- **HTTP URL 1:** http://<EM_SERVER>:<EM_SERVER_PORT>/soa-infra/services/Generic/<SERVICE>

where:

- <OPERATION>: the operation performed by the message sender (see Operation column in the table above)
- <USER_ID>: the user ID used to log into WebLogic Enterprise Manager
- <PASSWORD>: the password used to log into WebLogic Enterprise Manager
- <EM_SERVER_IP>: the machine name or IP address of server where the WebLogic Enterprise Manager is installed
- <EM_SERVER_PORT>: the port where the WebLogic Enterprise Manager is installed
- <SERVICE>: the service invoked by the message sender (see Service column in the table above)

Outbound Message Types

Outbound message types define specific types of messages sent to an external system, such as messages containing device command requests.

The following outbound message types must be configured in your system. If these are not present in your configuration, add them. Refer to the Oracle Utilities Application Framework documentation for more information about creating outbound message types.

Outbound Message Type	Description
DG-COMM	Generic Adapter Commission
DG-DCOMM	Generic Adapter Decommission

Note: The following apply to all of the above outbound message types:

- **Business Object:** D1-OutboundMessage (Outbound Message)
- **Priority:** Priority 50

External System

External systems represent external applications with which the Smart Grid Gateway will exchange messages or data. In the case of the Smart Grid Gateway adapters, external systems represent the head-end systems with which the adapters communicate.

An external system that represents the head-end system must be present in your system. If this is not present in your configuration, add it, along with the following Outbound Message Types. Refer to the Oracle Utilities Application Framework documentation for more information about creating external systems.

External System — Generic:

- **External System:** Generic
- **Description:** Generic
- **Outbound Message Types:**

Outbound Message Type	Description	Message Sender
DG-COMM	Generic Adapter Commission	DG-COMM
DG-DCOMM	Generic Adapter Decommission	DG-DCOMM

Note: The following apply to all of the above outbound message types:

- **Processing Method:** Real-time

- **Message XSL:** DG-Request.xml
- **Response XSL:** DG-Response.xml

Service Provider

Service providers represent external entities that serve various roles relative to the application, including head-end systems, billing systems to which the application sends bill determinant data, market participants in a deregulated environment, outage management systems that receive meter event data from the application, or other parties that require or provide information to the system. The head-end systems that collect and send measurement data and meter events to the application are defined as service providers.

A service provider that represents the head-end system must be present in your system. If this is not present in your configuration, add it. Refer to the Oracle Utilities Service and Measurement Data Foundation documentation for more information about creating service providers.

Service Provider - Generic:

- **Service Provider:** Generic
- **Description:** Generic
- **External Reference ID:** Generic
- **External System:** Generic
- **Our Name/ID in Their System:**
- **AMI Device ID Type:** Internal Meter Number
- **AMI Measuring Component ID Type:** Channel ID

Processing Methods

Processing methods define the format or means by which a service provider receives and/or sends data from and/or to the application, including bill determinants, usage data, or device events. Processing methods are also used to define how to create information internal to the application such as initial measurement data and device events. Processing methods can also be used to define how command requests are sent to the head-end system.

The following types of processing methods must be configured for the head-end system service provider. Refer to the Oracle Utilities Service and Measurement Data Foundation documentation for more information about configuring processing methods.

Initial Measurement Creation

Initial measurement creation processing methods define the business objects used to create initial measurements. The IMD Seeder inbound web service uses this processing method to determine which type of initial measurement business object to instantiate when receiving usage from the head-end system.

Device Event Mapping

Device event mapping processing methods define how head-end-specific device events are mapped to standard device event names. The Device Event Seeder inbound web service uses this processing method to determine which type of device event business object to instantiate when receiving device events from the head-end system.

UOM Translation

UOM translation processing methods define how head-end-specific unit of measure (UOM) codes are mapped to standard UOM codes. This processing method is used to determine how to map head-end system UOM codes to standard UOM codes when receiving usage from the head-end system.

Commands

Command processing methods define how command requests are sent to a head-end system. More specifically, they define the type of outbound communication business object to create for each type of command, and the outbound message type to send to the head-end system.

The following types of command processing methods can be configured for the head-end system service provider, based on the requirements of each implementation using the “How to Create OB COMM/Send OB Message” processing method business object (D1–HowToCreateActivityOBComm).

Command	Processing Role	Default Business Object	Default Outbound Message Type
Device Commission	Device Registration	DG-MeterAddNotification	Commission
Device Decommission	Device Removal	DG-MeterRemoveNotification	Decommission
Device Status Check	Device Status Check	DG-InitiateOutageDetection	Get Status
On-Demand Read (Scalar)	On-Demand Read (Scalar)	DG-InitiateMeterByMeterId	Initiate Meter Read by Meter ID
Remote Connect	Remote Connect	DG-InitiateConnectDisconnect	Connect Device
Remote Disconnect	Remote Disconnect	DG-InitiateConnectDisconnect	Disconnect Device

Configuring Endpoint URIs

Part of configuring your adapter is configuring your BPEL composites to work with your head-end system by defining the appropriate Endpoint URIs for each of the commands.

The default approach to defining Endpoints URIs is redeployment or reinstallation of the BPEL composites. For example, by default, changing an adapter from using the test harness to a production environment using the actual head end system requires editing the appropriate installation menu options and redeploying the BPEL composites. The Endpoints URIs defined during installation and deployment for each adapter are listed in the **Smart Grid Gateway Installation and Configuration Worksheets** section of the *Oracle Utilities Smart Grid Gateway Installation Guide*.

You can also use an “Endpoint Override” Domain Value Map (DVM) to override Endpoints URIs defined during deployment and installation. This DVM allows defining specific keys that provide an alternate URL that will override the original installed value. Endpoint Override DVMs can be edited using the Oracle SOA Composer.

The Adapter Development Kit endpoint override DVM (DG–EndpointOverrides.dvm) uses a specific set of keys, each used for one or more commands. The table below lists the DVM keys available for the Landis+Gyr adapter and the command used with each:

DVM Key	Commands
MR_Server	Device Commissioning Device Decommissioning On-Demand Read (Scalar) On-Demand Read (Interval)
CD_Server	Remote Connect Remote Disconnect
OD_Server	Device Status Check

To define an override Endpoint URI for an adapter built from the Adapter Development Kit, use the following procedure:

1. Open the SOA Composer for your BPEL configuration.
The URL for the SOA Composer is <http://server:port/soa/composer>.
2. Select the DG–EndpointOverrides.dvm in the left panel.

- In Fusion Middleware v12.2.1, this is located under **Shared** in the **Deployment View**, or under **Domain Value Maps** in the **Types View**.
- In Fusion Middleware v12.2.2, this is located under **Metadata** in the **Deployment View**.

The DVM will open in the right panel. The **Description** field lists the available keys for the DVM (only the first key is shown, but you can scroll through the contents to view the list. The panel also displays a list of previously defined keys.

3. Click the **Create Session** button (above the left panel) to begin an editing session.

4. Click the **Add Domain Values** icon (“+”) to add a new key.

The **Add Domain Values** dialog opens.

5. Enter the appropriate values in the **Add Domain Values** dialog as follows:

- **key**: The DVM key for the Endpoint URI you wish to define (see the table above).
- **EndpointURI**: The override Endpoint URI.

6. Click **OK**.

The new DVM value will appear in the list of keys.

7. Click the **Save** icon to save the DVM values.

8. Click the **Publish** button to activate all the changes in the editing session.

Enter an optional note for the session in the **Publish Session** dialog.

Changes take effect immediately upon publishing the session.

Click **Discard** to discard your changes.

Click **Exit** to exit your current session. Note that your session will still be open if you exit. Use **Discard** to end your session without making changes.

Configuring Adapter Development Kit Extendable Lookups

NOTE: This section applies to to **both** middleware and native implementations of the Smart Grid Gateway Adapter Development Kit,

This section outlines some of the extendable lookups that must be configured for use with a customized adapter. Refer to the Oracle Utilities Application Framework documentation for more information about working with extendable lookups.

Device Event Mapping

The Device Event Mapping extendable lookup is used to determine which type of device event business object to instantiate when receiving device events from the head-end system.

Each value defined for the Device Event Mapping extendable lookup should include the following:

- **Head-End System Event Name**: The event name used by the head-end system.
- **Description**: A description of the device event
- **Status**: The status of the lookup value (can be Active or Inactive)
- **Standard Event Name**: The standard event name for device events of this type, from the “Standard Event Name” extendable lookup.

Head-End UOM Code to Standard UOM Mapping

Usage received from the head-end system may use utility-specific unit of measures (UOMs). These custom UOMs must be mapped to standard UOM codes. The head-end system UOM Code to Standard UOM Mapping extendable lookup is used

to determine how to map head-end system UOM codes to standard UOM codes when receiving usage from the head-end system.

Each value defined for the head-end system UOM Code to Standard UOM Mapping extendable lookup should include the following:

- **Head-End Unit of Measure:** The unit of measure code used by the head-end system
- **Unit of Measure:** The unit of measure defined in the system.
- **Description:** A description of the unit of measure code.
- **Status:** The status of the lookup value (can be Active or Inactive)

Interval Status Code to Condition Mapping

Interval usage received from the head-end system can include interval status codes that indicate the status or condition of the interval value. These interval status codes must be mapped to standard condition codes in the system. The Generic Interval Status Code to Condition Mapping extendable lookup is used to determine how to map head-end system interval status codes to standard status codes when receiving usage from the head-end system.

Each value defined for the Generic Interval Status Code to Condition Mapping extendable lookup should include the following:

- **Interval Status:** The head-end system interval status code
- **Description:** A description of the interval status code.
- **Status:** The status of the lookup value (can be Active or Inactive)
- **Condition:** The condition code to which the interval status code is to be mapped, from the Measurement Condition extendable lookup.

Other Extendable Lookups

Business Object Name	Description
DG-CDReasonCodeLookup	ADK - Connect Disconnect Reason Code
DG-GenericTimeUnits	ADK - Time Units
DG-LoadActionCodeLookup	ADK - Load Action Code
DG-OutageEventTypeLookup	ADK - Outage Event Type
DG-ServiceTypeMappingLookup	ADK - Service Type Mapping

Using the Adapter Development Kit Test Harness

Oracle Utilities Smart Grid Gateway Adapter Development Kit includes a test harness that can be configured to simulate a general head-end system for testing the two-way commands. The test harness includes a BPEL composite, web services for standard meter functions, and an XML file that can be used to contain information for one or more meters. This section describes the test harness and its components.

Locating the WSDL for the Test Harness

Follow these procedures to locate the Adapter Development Kit test harness WSDL:

How to Use Enterprise Manager to Locate the WSDL

1. Open Enterprise Manager and use the navigation pane to open the dashboard of the test harness composite:

2. The top bar of the dashboard contains several buttons and icons. One of these is a “world” icon with a puzzle piece over it. Click this icon to display a list of the WSDLs and endpoint URIs for the composite:
3. Click the UtilService WSDL URL link to see the WSDL in the browser, or right click and save it to your machine

Depending on your requirements, it may be necessary to download the associated schema found in the wsdl:types section. The URL can be pasted into a browser tab and downloaded in the same manner as the WSDL. The main schema has imported schemas that may also be required.

How to Use a Direct URL to locate the WSDL

The WSDL can be accessed without Enterprise Manager by understanding the paths used on the SOA server. In general, they have the following form:

```
http://{server name}:{port number}/soa-infra/services/{partition}/{Composite}/{Web Service}?WSDL
```

So by default, the test harness WSDL can be found at

```
http://{server name}:{port number}/soa-infra/services/DG_Test/DGTestHarness/UtilService?WSDL
```

Web Services

This section describes the web services included in the Adapter Development Kit test harness BPEL composite.

General Services

This section describes the general services of the Adapter Development Kit test harness composite.

LoadMeterIndex

This web service loads the data store from the internal file. By default if the store is already in memory, it will *not* reload. This behavior can be overridden with the forceReload parameter.

Input: LoadMeterIndexInput

Part: payload

Element: LoadMeterIndexRequest

Parameter	Description
forceReload	A switch telling the system whether to reload the meter index from the configuration file. Default value is false.

Output: LoadMeterIndexOutput

Part: payload

Element: LoadMeterIndexResult

Parameter	Description
loaded	A boolean value for whether or not the index was reloaded from the configuration file

Fault: UtilityFault (see [UtilityFault](#) for more details).

ViewAuditTrail

This web service returns the audit log for the entire session.

Input: ViewAuditTrailInput

Part: payload

Element: ViewAuditTrailRequest

Parameters: This is an empty request. There are no parameters.

Output: ViewAuditTrailOutput

Part: payload

Element: ViewAuditTrailResult

This element is an entry consisting of a timestamp and an Operation. Each entry may have an associated meter object showing what changed.

Fault: UtilityFault (see [UtilityFault](#) for more details).

UtilityFault

Fault with similar mapping to SGG/OUAF faults:

Typically, the faultCode, faultString, faultActor, and detail/text elements will be populated.

Locate Meter Services

This section describes the locate meter web services of the Adapter Development Kit test harness composite.

FindMeters

This web service queries the data store for one or more meters. The difference between GetMeter and FindMeters is GetMeter can return at most one meter and it must match the provided ID exactly. GetMeter will throw an error if the ID is not found. FindMeters can return more than one meter (when using the regex) and will not throw an error when the ID does not match any of the meters in the index.

Input: FindMetersInput

Part: payload

Element: FindMetersRequest

Parameter	Description
id	The meter ID for which to search
isRegex	The provided id can be a regex value when this parameter is true. Hint: to search for all meters in the system, use ".*" for the ID.

Output: FindMetersOutput

Part: payload

Element: FindMetersResult

Zero or more meter objects can be returned from the search

Fault: See [UtilityFault](#). Unlike other methods, FindMeters does not throw an exception if the meter is not found.

IsMeterDefined

This web service queries whether a particular meter is defined in the data store.

Input: IsMeterDefinedInput

Part: payload

Element: IsMeterDefinedRequest

Parameter	Description
id	The meter ID for which to search

Output: IsMeterDefinedOutput

Part: payload

Element: IsMeterDefinedResult

Whether or not the provided ID is part of the index.

Fault: See [UtilityFault](#). Thrown when meter id is not found.

GetMeter

This web service returns all the attributes of a single meter from the in-memory data store. The difference between GetMeter and FindMeters is GetMeter can return at most one meter and it must match the provided ID exactly. GetMeter will throw an error if the ID is not found. FindMeters can return more than one meter (when using the regex) and will not throw an error when the ID does not match any of the meters in the index.

Input: GetMeterInput

Part: payload

Element: GetMeterRequest

Parameter	Description
id	The meter ID for which to search

Output: GetMeterOutput

Part: payload

Element: GetMeterResult

The meter object requested by the ID.

Fault: See [UtilityFault](#). Thrown when meter id is not found.

Meter Administration Services

This section describes the meter administration services of the Adapter Development Kit test harness composite.

AddMeters

This web service adds a set of meters to the in-memory data store. This will not permanently add it to the control file.

Input: AddMetersInput

Part: payload

Element: AddMetersRequest

Parameter	Description
id	The identification code for the meter.
utility	An informational string.
serviceType	One of the valid ServiceType values (see schema). "Electric" is the only option at this time.
isCommissioned	Whether or not the meter is in a commissioned state.

Parameter	Description
loadActionCode	One of the possible LoadActionCode values used in Connect and Disconnect (see schema).
outageEventType	One of the possible OutageEventType values used in Device Status Check (see schema).
executionStatus	One of the possible ExecutionStates (see schema). These values control how the meter will respond to commands.
updateIfExisting	Whether or not to update the meter with the provided values if it already exists in the index.
Comment	An informational string describing the purpose of the meter.
Channels	A listing of unit of measures supported by this meter.
uomCode	A code describing the unit of measure for the channel.
uomName	A short string containing the name of the unit of measure.
decimals	The number of digits to the right of the decimal that should be generated when reading the meter.
description	A longer description of the unit of measure.

Output: AddMetersOutput

Part: payload

Element: AddMetersResult

Whether or not each meter was added to the index.

Fault: See [UtilityFault](#).

RemoveMeter

This web service removes a meter from the in-memory data store. This will not permanently remove it from the control file.

Input: RemoveMeterInput

Part: payload

Element: RemoveMeterRequest

Parameter	Description
id	The ID for the meter to be removed.

Output: RemoveMeterOutput

Part: payload

Element: RemoveMeterResult

Whether or not the meter was removed from the index.

Fault: See [UtilityFault](#). Thrown when meter id is not found.

AddMeterChannel

This web service adds a new channel to a single meter.

Input: AddMeterChannelInput

Part: payload

Element: AddMeterChannelRequest

Parameter	Description
id	The identification code for the meter.
uomCode	A code describing the unit of measure for the channel.
uomName	A short string containing the name of the unit of measure.
decimals	The number of digits to the right of the decimal that should be generated when reading the meter.
description	A longer description of the unit of measure.

Output: AddMeterChannelOutput**Part:** payload**Element:** AddMeterChannelResult

Whether or not the channel was added to the index.

Fault: See [UtilityFault](#). Thrown when meter id is not found.**RemoveMeterChannel**

This web service removes a Channel from a meter.

Input: RemoveMeterChannelInput**Part:** payload**Element:** RemoveMeterChannelRequest

Parameter	Description
id	The ID for the meter to be removed.
uomCode	A code describing the unit of measure for the channel.
uomName	A short string containing the name of the unit of measure.

These three parameters are combined to locate a unique channel

Output: RemoveMeterChannelOutput**Part:** payload**Element:** RemoveMeterChannelResult

Whether or not the channel was removed from the meter.

Fault: See [UtilityFault](#). Thrown when meter id is not found.**ReadScalarMeter**

This web service generates a scalar reading for each channel of a given meter.

Input: ReadScalarMeterInput**Part:** payload**Element:** ReadScalarMeterRequest

Parameter	Description
id	The ID for the meter to be read.

Output: ReadScalarMeterOutput

Part: payload

Element: ReadScalarMeterResult

Zero or more scalar readings for the given meter.

Parameter	Description
uomCode	A code describing the unit of measure for the channel.
uomName	A short string containing the name of the unit of measure.
decimals	The number of digits to the right of the decimal that should be generated when reading the meter.
description	A longer description of the unit of measure.
value	A random number representing the scalar reading.

Fault: See [UtilityFault](#). Thrown when meter id is not found.

Meter Attribute Administration Services

This section describes the meter administration services of the Adapter Development Kit test harness composite.

GetOutageEventType

This web service queries the outage event type for a given meter. The OutageEventType is used by DeviceStatusCheck.

Input: GetOutageEventTypeInput

Part: payload

Element: GetOutageEventTypeRequest

Parameter	Description
id	The ID for the meter for which the OutageEventType should be retrieved.

Output: GetOutageEventTypeOutput

Part: payload

Element: GetOutageEventTypeResult

The value of the OutageEventType attribute for the requested meter.

Fault: See [UtilityFault](#). Thrown when meter id is not found.

SetOutageEventType

This web service updates the outage event type for a given meter.

Input: SetOutageEventTypeInput

Part: payload

Element: SetOutageEventTypeRequest

Parameter	Description
id	The ID for the meter for which the OutageEventType should be set.
value	The new value of OutageEventType to set on the meter.

Output: SetOutageEventTypeOutput

Part: payload

Element: SetOutageEventTypeResult

The boolean response indicates the success or failure of the update (not the current field status).

Fault: See [UtilityFault](#). Thrown when meter id is not found.

GetLoadActionCode

This web service queries the load action code for a given meter. This is the Connect/Disconnect behavior.

Input: GetLoadActionCodeInput

Part: payload

Element: GetLoadActionCodeRequest

Parameter	Description
id	The ID for the meter for which the LoadActionCode should be retrieved.

Output: GetLoadActionCodeOutput

Part: payload

Element: GetLoadActionCodeResult

The value of the LoadActionCode attribute for the requested meter.

Fault: See [UtilityFault](#). Thrown when meter id is not found.

SetLoadActionCode

This web service updates the load action code for a given meter.

Input: SetLoadActionCodeInput

Part: payload

Element: SetLoadActionCodeRequest

Parameter	Description
id	The ID for the meter for which the LoadActionCode should be set.
value	The new value of LoadActionCode to set on the meter.

Output: SetLoadActionCodeOutput

Part: payload

Element: SetLoadActionCodeResult

The boolean response indicates the success or failure of the update (not the current field status).

Fault: See [UtilityFault](#). Thrown when meter id is not found.

IsCommissioned

This web service queries the commissioning status for a given meter. This is the Commission/Decommission behavior.

Input: IsCommissionedInput

Part: payload

Element: IsCommissionedRequest

Parameter	Description
id	The ID for the meter for which the Commissioned status should be retrieved.

Output: IsCommissionedOutput

Part: payload

Element: IsCommissionedResult

The value of the Commissioned status attribute for the requested meter.

Fault: See [UtilityFault](#). Thrown when meter id is not found.

SetCommission

This web service updates the commissioning status for a given meter.

Input: SetCommissionedInput

Part: payload

Element: SetCommissionedRequest

Parameter	Description
id	The ID for the meter for which the Commissioned status should be set.
value	The new value of Commissioned status to set on the meter.

Output: SetCommissionedOutput

Part: payload

Element: SetCommissionedResult

The boolean response indicates the success or failure of the update (not the current field status).

Fault: See [UtilityFault](#). Thrown when meter id is not found.

GetExecutionStatus

This web service queries the status of the property controlling the overall execution of the command.

Input: GetExecutionStatusInput

Part: payload

Element: GetExecutionStatusRequest

Parameter	Description
id	The ID for the meter for which the ExecutionStatus should be retrieved.

Output: GetExecutionStatusOutput

Part: payload

Element: GetExecutionStatusResult

The value of the ExecutionStatus attribute for the requested meter.

Fault: See [UtilityFault](#). Thrown when meter id is not found.

SetExecutionStatus

This web service updates the property controlling the overall completion of the command.

Input: SetExecutionStatusInput

Part: payload

Element: SetExecutionStatusRequest

Parameter	Description
id	The ID for the meter for which the ExecutionStatus should be set.
value	The new value of ExecutionStatus to set on the meter.

Output: SetExecutionStatusOutput

Part: payload

Element: SetExecutionStatusResult

The boolean response indicates the success or failure of the update (not the current field status).

Fault: See [UtilityFault](#). Thrown when meter id is not found.

Sample Meters File

The Adapter Development Kit includes an XML file and schema that can be used for configuring one or more meters for use with the test harness. The file, metersdb.xml, is located in the Test/DGTestHarness directory and can be edited with an appropriate XML editor such as XML Spy. This section describes the attributes in the metersdb.xml file.

The meterdb.xml file contains one or more **Meter** elements that have the following attributes:

Meter Attribute	Definition
id	The meter identifier. This value should match the amiDeviceID setting in the Oracle Utilities Application Framework.
utility	This is informational only.
serviceType	This is informational only.
ServiceType	An enumeration that is described in the schema.
isCommissioned	A boolean value that describes whether or not the meter is commissioned or decommissioned. The associated MultiSpeak commands are MeterAddNotification and MeterRemoveNotification.
loadActionCode	This value is for the Connect and Disconnect commands and has enumeration values described in the schema. The value is returned in the CDStatesChangedNotification MultiSpeak command.
outageEventType	This value is used by DeviceStatusCheck and gives the status returned by the ODEventNotification call. Its enumeration values are described in the schema.
executionStatus	This value does not reflect a MultiSpeak command, but is instead intended to give a state of the operation. There are four valid values: Success: When a meter has this status the operation will complete without error. ResponseTimeout: When a meter has this status an asynchronous reply will never arrive (not relevant for Commission/Decommission commands). SyncOperationFailure: When a meter has this status the initial communication to the simulated head-end system will produce an error. AsyncOperationFailure: When a meter has this status, the asynchronous callback from the head-end system will arrive, but will indicate an error (not relevant for Commission/Decommission commands).

A meter can also contain the following elements:

- **Comment:** A field which is for informational use only and is meant to indicate the purpose of the meter.
- **Channels:** Used in reading the meter for On Demand Read commands. A channel contains the following attributes:

Channel Attribute	Definition
uomCode	The units of measure code that should be returned when the meter is read.
uomName	The units of measure name that should be returned when the meter is read.
description	A longer form. When the meter is read, a random number is generated for this value.
decimals	A value to indicate how many places to the right of the decimal that random number should have.

The Adapter Development Kit Native Format

NOTE: The Adapter Development Kit Native Format can be used with **both** middleware and native Smart Grid Gateway Adapter implementations.

The Adapter Development Kit supports loading usage and event data exported from the AMI head-end system in the “native” initial measurement and device event data formats (the format of the initial measurement and device event seeder business objects). Processing of the ADK native format is supported by the following OSB projects:

- **SGG-DG-SEEDER-BASE**
- **SGG-DG-SEEDER-CM**

Refer to [Initial Measurements and Device Events](#) and [OSB Project Summary](#) for more information about these OSB projects.

Format Details

The ADK native format is an XML format that contains zero or more initial measurements and/or device events, as follows:

- The collection of initial measurements and/or device events are encapsulated within in an <SGGIMDsEvents> element.
- Each initial measurement or device event is defined in the format of the initial measurement and device event seeder business objects, encapsulated by the following elements:
 - **Initial Measurements:** <D1-InitialLoadIMD>
 - **Device Events:** <D1-DeviceEventSeeder>
- The format can support any number of initial measurements and/or device events.
- Initial measurements can be either scalar or interval measurements.

See [Adapter Development Kit Native Format Example](#) for an example of this format. See [Adapter Development Kit Native Format Schema](#) for the native format XML schema.

Adapter Development Kit Native Format Example

The following is an example of the ADK native format. This example contains 2 initial measurements (1 scalar and 1 interval) and 2 device events (PowerOutage and PowerRestored).

```
<?xml version="1.0" encoding="UTF-8" ?>
<SGGIMDsEvents xmlns="http://oracle.com/SGGIMDsEvents">
  <D1-InitialLoadIMD dateTimeTagFormat="xsd" xmlns="">
    <preVEE>
      <imdType>D1IL</imdType>
      <mcIS>D1SC</mcIS>
      <externalId>da_164_Scalar_withMetadata.xml-2015-09-10-11-19-03-297</externalId>
      <dvcIdN>DL_06</dvcIdN>
      <externalUOM>KWH</externalUOM>
      <enDt>2005-01-01T00:00:00Z</enDt>
      <enQty>4544</enQty>
    </preVEE>
  </D1-InitialLoadIMD>
  <D1-DeviceEventSeeder>
    <preVEE>
      <deviceEventType>PowerOutage</deviceEventType>
      <mcIS>D1SC</mcIS>
      <externalId>da_164_DeviceEventSeeder.xml-2015-09-10-11-19-03-297</externalId>
      <dvcIdN>DL_06</dvcIdN>
      <externalUOM>KWH</externalUOM>
      <enDt>2005-01-01T00:00:00Z</enDt>
      <enQty>4544</enQty>
    </preVEE>
  </D1-DeviceEventSeeder>
</SGGIMDsEvents>
```

```

    <serviceProviderExternalId>Itron</serviceProviderExternalId>
  </D1-InitialLoadIMD>
  <D1-InitialLoadIMD dateTimeTagFormat="xsd" xmlns="">
    <preVEE>
      <imdType>D1IL</imdType>
      <mcIS>D1IN</mcIS>
      <externalId>da_164_Multile_withMetadata_A.xml-2015-09-10-11-19-03-297</externalId>
      <dvcIdN>ZZ-D-OSB-INT-ITRON-0002</dvcIdN>
      <spi>900</spi>
      <externalUOM>KWH</externalUOM>
      <mcm>725</mcm>
      <stDt>2003-01-01T23:45:00Z</stDt>
      <enDt>2003-01-02T00:00:00Z</enDt>
      <msrs>
        <mL>
          <s>1</s><q>4722</q>
          <sts>
            <stsL>
              <s>1</s>
              <st>CHardwareFailure</st>
            </stsL>
            <stsL>
              <s>2</s>
              <st>COverflow</st>
            </stsL>
          </sts>
        </mL>
      </msrs>
    </preVEE>
    <serviceProviderExternalId>Itron</serviceProviderExternalId>
  </D1-InitialLoadIMD>
  <D1-DeviceEventSeeder dateTimeTagFormat="xsd" xmlns="">
    <externalSenderId>Itron</externalSenderId>
    <deviceIdentifierNumber>ZZ-D-OSB-INT-ITRON-0002</deviceIdentifierNumber>
    <externalEventName>PowerOutage</externalEventName>
    <eventDateTime>2001-02-02T00:00:00Z</eventDateTime>
    <eventInformation>
      <externalEventIdentifier>2147483642</externalEventIdentifier>
      <externalStatusValue>string</externalStatusValue>
      <externalEventCategory>Communication</externalEventCategory>
    </eventInformation>
  </D1-DeviceEventSeeder>
  <D1-DeviceEventSeeder dateTimeTagFormat="xsd" xmlns="">
    <externalSenderId>Itron</externalSenderId>
    <externalSourceIdentifier>da_164_Multile_withMetadata_A.xml-2015-09-10-11-19-03-297</
externalSourceIdentifier>
    <deviceIdentifierNumber>ZZ-D-OSB-INT-ITRON-0002</deviceIdentifierNumber>
    <externalEventName>PowerRestored</externalEventName>
    <eventDateTime>2001-02-02T01:00:00Z</eventDateTime>
    <eventInformation>
      <externalEventIdentifier>2147483642</externalEventIdentifier>
      <externalStatusValue>string</externalStatusValue>
      <externalEventCategory>Communication</externalEventCategory>
    </eventInformation>
  </D1-DeviceEventSeeder>
</SGGIMDsEvents>

```

Adapter Development Kit Native Format Schema

The following is the XML schema of the ADK native format.

```

<xsd:schema xmlns:xsd="http://www.w3.org/2001/XMLSchema" elementFormDefault="qualified">
  <xsd:element name="SGGIMDsEvents">
<xsd:complexType>
  <xsd:all>
<xsd:element name="D1-DeviceEventSeeder" minOccurs="0">
  <xsd:complexType>
  <xsd:all>
  <xsd:element name="deviceEventId" minOccurs="0">
  <xsd:simpleType>

```

```

    <xsd:restriction base="xsd:string">
      <xsd:maxLength value="14" />
    </xsd:restriction>
  </xsd:simpleType>
</xsd:element>
<xsd:element name="bo" minOccurs="0">
  <xsd:simpleType>
    <xsd:restriction base="xsd:string">
      <xsd:maxLength value="30" />
    </xsd:restriction>
  </xsd:simpleType>
</xsd:element>
<xsd:element name="boStatus" minOccurs="0">
  <xsd:simpleType>
    <xsd:restriction base="xsd:string">
      <xsd:maxLength value="12" />
    </xsd:restriction>
  </xsd:simpleType>
</xsd:element>
<xsd:element name="sender" minOccurs="0">
  <xsd:simpleType>
    <xsd:restriction base="xsd:string">
      <xsd:maxLength value="30" />
    </xsd:restriction>
  </xsd:simpleType>
</xsd:element>
<xsd:element name="externalSenderId" minOccurs="0">
  <xsd:simpleType>
    <xsd:restriction base="xsd:string">
      <xsd:maxLength value="36" />
    </xsd:restriction>
  </xsd:simpleType>
</xsd:element>
<xsd:element name="deviceEventType" minOccurs="0">
  <xsd:simpleType>
    <xsd:restriction base="xsd:string">
      <xsd:maxLength value="30" />
    </xsd:restriction>
  </xsd:simpleType>
</xsd:element>
<xsd:element name="externalEventName" minOccurs="0">
  <xsd:simpleType>
    <xsd:restriction base="xsd:string">
      <xsd:maxLength value="254" />
    </xsd:restriction>
  </xsd:simpleType>
</xsd:element>
<xsd:element name="eventDateTime" nillable="true" type="xsd:dateTime" minOccurs="0"/>
<xsd:element name="eventEndDateTime" nillable="true" type="xsd:dateTime" minOccurs="0" />
<xsd:element name="externalTimeZone" minOccurs="0">
  <xsd:simpleType>
    <xsd:restriction base="xsd:string">
      <xsd:maxLength value="20" />
    </xsd:restriction>
  </xsd:simpleType>
</xsd:element>
<xsd:element name="deviceId" minOccurs="0">
  <xsd:simpleType>
    <xsd:restriction base="xsd:string">
      <xsd:maxLength value="12" />
    </xsd:restriction>
  </xsd:simpleType>
</xsd:element>
<xsd:element name="deprecatedDeviceId" minOccurs="0">
  <xsd:simpleType>
    <xsd:restriction base="xsd:string">
      <xsd:maxLength value="12" />
    </xsd:restriction>
  </xsd:simpleType>
</xsd:element>
<xsd:element name="creationDateTime" nillable="true" type="xsd:dateTime" minOccurs="0" />
<xsd:element name="statusUpdateDateTime" nillable="true" type="xsd:dateTime" minOccurs="0" />

```

```

<xsd:element name="statusReason" minOccurs="0">
  <xsd:simpleType>
    <xsd:restriction base="xsd:string">
      <xsd:maxLength value="30" />
    </xsd:restriction>
  </xsd:simpleType>
</xsd:element>
<xsd:element name="rawEventInformation" type="xsd:anyType" minOccurs="0" />
<xsd:element name="externalSourceIdentifier" minOccurs="0">
  <xsd:simpleType>
    <xsd:restriction base="xsd:string">
      <xsd:maxLength value="120" />
    </xsd:restriction>
  </xsd:simpleType>
</xsd:element>
<xsd:element name="eventInformation" minOccurs="0">
  <xsd:complexType>
    <xsd:all>
      <xsd:element name="externalEventIdentifier" minOccurs="0">
        <xsd:simpleType>
          <xsd:restriction base="xsd:string">
            <xsd:maxLength value="30" />
          </xsd:restriction>
        </xsd:simpleType>
      </xsd:element>
      <xsd:element name="externalEventCategory" minOccurs="0">
        <xsd:simpleType>
          <xsd:restriction base="xsd:string">
            <xsd:maxLength value="30" />
          </xsd:restriction>
        </xsd:simpleType>
      </xsd:element>
      <xsd:element name="externalEventSeverity" minOccurs="0">
        <xsd:simpleType>
          <xsd:restriction base="xsd:string">
            <xsd:maxLength value="30" />
          </xsd:restriction>
        </xsd:simpleType>
      </xsd:element>
      <xsd:element name="externalDeviceType" minOccurs="0">
        <xsd:simpleType>
          <xsd:restriction base="xsd:string">
            <xsd:maxLength value="30" />
          </xsd:restriction>
        </xsd:simpleType>
      </xsd:element>
      <xsd:element name="externalServiceLocationId" minOccurs="0">
        <xsd:simpleType>
          <xsd:restriction base="xsd:string">
            <xsd:maxLength value="30" />
          </xsd:restriction>
        </xsd:simpleType>
      </xsd:element>
      <xsd:element name="externalCommunicationModuleIdentifier" minOccurs="0">
        <xsd:simpleType>
          <xsd:restriction base="xsd:string">
            <xsd:maxLength value="30" />
          </xsd:restriction>
        </xsd:simpleType>
      </xsd:element>
      <xsd:element name="externalGatewayIdentifier" minOccurs="0">
        <xsd:simpleType>
          <xsd:restriction base="xsd:string">
            <xsd:maxLength value="30" />
          </xsd:restriction>
        </xsd:simpleType>
      </xsd:element>
      <xsd:element name="externalStatusValue" minOccurs="0">
        <xsd:simpleType>
          <xsd:restriction base="xsd:string">
            <xsd:maxLength value="30" />
          </xsd:restriction>
        </xsd:simpleType>
      </xsd:element>
    </xsd:all>
  </xsd:complexType>
</xsd:element>

```

```

</xsd:simpleType>
</xsd:element>
<xsd:element name="externalStatusDateTime" nillable="true" type="xsd:dateTime" minOccurs="0" /
>
<xsd:element name="externalCommandId" minOccurs="0">
  <xsd:simpleType>
    <xsd:restriction base="xsd:string">
      <xsd:maxLength value="30" />
    </xsd:restriction>
  </xsd:simpleType>
</xsd:element>
<xsd:element name="externalEventDescription" minOccurs="0">
  <xsd:simpleType>
    <xsd:restriction base="xsd:string">
      <xsd:maxLength value="60" />
    </xsd:restriction>
  </xsd:simpleType>
</xsd:element>
<xsd:element name="externalEventReason" minOccurs="0">
  <xsd:simpleType>
    <xsd:restriction base="xsd:string">
      <xsd:maxLength value="30" />
    </xsd:restriction>
  </xsd:simpleType>
</xsd:element>
<xsd:element name="externalStatusReason" minOccurs="0">
  <xsd:simpleType>
    <xsd:restriction base="xsd:string">
      <xsd:maxLength value="60" />
    </xsd:restriction>
  </xsd:simpleType>
</xsd:element>
<xsd:element name="sourceTimeZone" minOccurs="0">
  <xsd:simpleType>
    <xsd:restriction base="xsd:string">
      <xsd:maxLength value="10" />
    </xsd:restriction>
  </xsd:simpleType>
</xsd:element>
<xsd:element name="timeZone" minOccurs="0">
  <xsd:simpleType>
    <xsd:restriction base="xsd:string">
      <xsd:maxLength value="10" />
    </xsd:restriction>
  </xsd:simpleType>
</xsd:element>
<xsd:element name="dateTimesInStandard" minOccurs="0">
  <xsd:simpleType>
    <xsd:restriction base="xsd:string">
      <xsd:enumeration value="D1NO" />
      <xsd:enumeration value="D1YS" />
    </xsd:restriction>
  </xsd:simpleType>
</xsd:element>
</xsd:all>
</xsd:complexType>
</xsd:element>
<xsd:element name="version" minOccurs="0">
  <xsd:simpleType>
    <xsd:restriction base="xsd:decimal">
      <xsd:minExclusive value="-99999" />
      <xsd:maxExclusive value="99999" />
    </xsd:restriction>
  </xsd:simpleType>
</xsd:element>
<xsd:element name="deviceIdentifierNumber" minOccurs="0">
  <xsd:simpleType>
    <xsd:restriction base="xsd:string">
      <xsd:maxLength value="60" />
    </xsd:restriction>
  </xsd:simpleType>
</xsd:element>

```



```

<xsd:element name="newDeviceEvent" minOccurs="0">
  <xsd:simpleType>
    <xsd:restriction base="xsd:string">
      <xsd:maxLength value="14" />
    </xsd:restriction>
  </xsd:simpleType>
</xsd:element>
<xsd:element name="nextRetryDateTime" nillable="true" type="xsd:dateTime" minOccurs="0" />
<xsd:element name="retryUntilDateTime" nillable="true" type="xsd:dateTime" minOccurs="0" />
<xsd:element name="processData" minOccurs="0">
  <xsd:complexType>
    <xsd:all>
      <xsd:element name="errorEncountered" minOccurs="0">
        <xsd:simpleType>
          <xsd:restriction base="xsd:string">
            <xsd:enumeration value="D1NO" />
            <xsd:enumeration value="D1YS" />
          </xsd:restriction>
        </xsd:simpleType>
      </xsd:element>
      <xsd:element name="dateTimesInStandard" minOccurs="0">
        <xsd:simpleType>
          <xsd:restriction base="xsd:string">
            <xsd:enumeration value="D1NO" />
            <xsd:enumeration value="D1YS" />
          </xsd:restriction>
        </xsd:simpleType>
      </xsd:element>
      <xsd:element name="logs" minOccurs="0">
        <xsd:complexType>
          <xsd:all>
            <xsd:element name="logsList" minOccurs="0" >
              <xsd:complexType>
                <xsd:all>
                  <xsd:element name="logsEntry" minOccurs="0">
                    <xsd:complexType>
                      <xsd:all>
                        <xsd:element name="sequence" minOccurs="0">
                          <xsd:simpleType>
                            <xsd:restriction base="xsd:decimal">
                              <xsd:minExclusive value="-999" />
                              <xsd:maxExclusive value="999" />
                            </xsd:restriction>
                          </xsd:simpleType>
                        </xsd:element>
                        <xsd:element name="mo" minOccurs="0">
                          <xsd:simpleType>
                            <xsd:restriction base="xsd:string">
                              <xsd:maxLength value="12" />
                            </xsd:restriction>
                          </xsd:simpleType>
                        </xsd:element>
                        <xsd:element name="pkValue1" minOccurs="0">
                          <xsd:simpleType>
                            <xsd:restriction base="xsd:string">
                              <xsd:maxLength value="50" />
                            </xsd:restriction>
                          </xsd:simpleType>
                        </xsd:element>
                        <xsd:element name="pkValue2" minOccurs="0">
                          <xsd:simpleType>
                            <xsd:restriction base="xsd:string">
                              <xsd:maxLength value="50" />
                            </xsd:restriction>
                          </xsd:simpleType>
                        </xsd:element>
                        <xsd:element name="pkValue3" minOccurs="0">
                          <xsd:simpleType>
                            <xsd:restriction base="xsd:string">
                              <xsd:maxLength value="50" />
                            </xsd:restriction>
                          </xsd:simpleType>
                        </xsd:element>
                      </xsd:all>
                    </xsd:complexType>
                  </xsd:element>
                </xsd:all>
              </xsd:complexType>
            </xsd:element>
          </xsd:all>
        </xsd:complexType>
      </xsd:element>
    </xsd:all>
  </xsd:complexType>
</xsd:element>

```

```

</xsd:element>
<xsd:element name="pkValue4" minOccurs="0">
  <xsd:simpleType>
    <xsd:restriction base="xsd:string">
      <xsd:maxLength value="50" />
    </xsd:restriction>
  </xsd:simpleType>
</xsd:element>
<xsd:element name="pkValue5" minOccurs="0">
  <xsd:simpleType>
    <xsd:restriction base="xsd:string">
      <xsd:maxLength value="50" />
    </xsd:restriction>
  </xsd:simpleType>
</xsd:element>
<xsd:element name="logEntryType" minOccurs="0">
  <xsd:simpleType>
    <xsd:restriction base="xsd:string">
      <xsd:enumeration value="D1TD" />
      <xsd:enumeration value="F1CR" />
      <xsd:enumeration value="F1ER" />
      <xsd:enumeration value="F1EX" />
      <xsd:enumeration value="F1ST" />
      <xsd:enumeration value="F1SY" />
      <xsd:enumeration value="F1TD" />
      <xsd:enumeration value="F1US" />
    </xsd:restriction>
  </xsd:simpleType>
</xsd:element>
<xsd:element name="logDateTime" nillable="true" type="xsd:dateTime" minOccurs="0" /
>
<xsd:element name="boStatus" minOccurs="0">
  <xsd:simpleType>
    <xsd:restriction base="xsd:string">
      <xsd:maxLength value="12" />
    </xsd:restriction>
  </xsd:simpleType>
</xsd:element>
<xsd:element name="description" minOccurs="0">
  <xsd:simpleType>
    <xsd:restriction base="xsd:string">
      <xsd:maxLength value="60" />
    </xsd:restriction>
  </xsd:simpleType>
</xsd:element>
<xsd:element name="user" minOccurs="0">
  <xsd:simpleType>
    <xsd:restriction base="xsd:string">
      <xsd:maxLength value="8" />
    </xsd:restriction>
  </xsd:simpleType>
</xsd:element>
<xsd:element name="logMessage" minOccurs="0">
  <xsd:simpleType>
    <xsd:restriction base="xsd:string">
      <xsd:maxLength value="4000" />
    </xsd:restriction>
  </xsd:simpleType>
</xsd:element>
<xsd:element name="characteristicType" minOccurs="0">
  <xsd:simpleType>
    <xsd:restriction base="xsd:string">
      <xsd:maxLength value="20" />
    </xsd:restriction>
  </xsd:simpleType>
</xsd:element>
<xsd:element name="characteristicValue" minOccurs="0">
  <xsd:simpleType>
    <xsd:restriction base="xsd:string">
      <xsd:maxLength value="16" />
    </xsd:restriction>
  </xsd:simpleType>

```

```

</xsd:element>
<xsd:element name="adhocValue" minOccurs="0">
  <xsd:simpleType>
    <xsd:restriction base="xsd:string">
      <xsd:maxLength value="254" />
    </xsd:restriction>
  </xsd:simpleType>
</xsd:element>
<xsd:element name="fkValue1" minOccurs="0">
  <xsd:simpleType>
    <xsd:restriction base="xsd:string">
      <xsd:maxLength value="50" />
    </xsd:restriction>
  </xsd:simpleType>
</xsd:element>
<xsd:element name="fkValue2" minOccurs="0">
  <xsd:simpleType>
    <xsd:restriction base="xsd:string">
      <xsd:maxLength value="50" />
    </xsd:restriction>
  </xsd:simpleType>
</xsd:element>
<xsd:element name="fkValue3" minOccurs="0">
  <xsd:simpleType>
    <xsd:restriction base="xsd:string">
      <xsd:maxLength value="50" />
    </xsd:restriction>
  </xsd:simpleType>
</xsd:element>
<xsd:element name="fkValue4" minOccurs="0">
  <xsd:simpleType>
    <xsd:restriction base="xsd:string">
      <xsd:maxLength value="50" />
    </xsd:restriction>
  </xsd:simpleType>
</xsd:element>
<xsd:element name="fkValue5" minOccurs="0">
  <xsd:simpleType>
    <xsd:restriction base="xsd:string">
      <xsd:maxLength value="50" />
    </xsd:restriction>
  </xsd:simpleType>
</xsd:element>
<xsd:element name="messageCategory" minOccurs="0">
  <xsd:simpleType>
    <xsd:restriction base="xsd:decimal">
      <xsd:minExclusive value="-99999" />
      <xsd:maxExclusive value="99999" />
    </xsd:restriction>
  </xsd:simpleType>
</xsd:element>
<xsd:element name="messageNumber" minOccurs="0">
  <xsd:simpleType>
    <xsd:restriction base="xsd:decimal">
      <xsd:minExclusive value="-99999" />
      <xsd:maxExclusive value="99999" />
    </xsd:restriction>
  </xsd:simpleType>
</xsd:element>
<xsd:element name="messageParm1" minOccurs="0">
  <xsd:simpleType>
    <xsd:restriction base="xsd:string">
      <xsd:maxLength value="30" />
    </xsd:restriction>
  </xsd:simpleType>
</xsd:element>
<xsd:element name="messageParm2" minOccurs="0">
  <xsd:simpleType>
    <xsd:restriction base="xsd:string">
      <xsd:maxLength value="30" />
    </xsd:restriction>
  </xsd:simpleType>
</xsd:element>

```

```

</xsd:element>
<xsd:element name="messageParm3" minOccurs="0">
  <xsd:simpleType>
    <xsd:restriction base="xsd:string">
      <xsd:maxLength value="30" />
    </xsd:restriction>
  </xsd:simpleType>
</xsd:element>
<xsd:element name="messageParm4" minOccurs="0">
  <xsd:simpleType>
    <xsd:restriction base="xsd:string">
      <xsd:maxLength value="30" />
    </xsd:restriction>
  </xsd:simpleType>
</xsd:element>
<xsd:element name="messageParm5" minOccurs="0">
  <xsd:simpleType>
    <xsd:restriction base="xsd:string">
      <xsd:maxLength value="30" />
    </xsd:restriction>
  </xsd:simpleType>
</xsd:element>
<xsd:element name="messageParm6" minOccurs="0">
  <xsd:simpleType>
    <xsd:restriction base="xsd:string">
      <xsd:maxLength value="30" />
    </xsd:restriction>
  </xsd:simpleType>
</xsd:element>
<xsd:element name="messageParm7" minOccurs="0">
  <xsd:simpleType>
    <xsd:restriction base="xsd:string">
      <xsd:maxLength value="30" />
    </xsd:restriction>
  </xsd:simpleType>
</xsd:element>
<xsd:element name="messageParm8" minOccurs="0">
  <xsd:simpleType>
    <xsd:restriction base="xsd:string">
      <xsd:maxLength value="30" />
    </xsd:restriction>
  </xsd:simpleType>
</xsd:element>
<xsd:element name="messageParm9" minOccurs="0">
  <xsd:simpleType>
    <xsd:restriction base="xsd:string">
      <xsd:maxLength value="30" />
    </xsd:restriction>
  </xsd:simpleType>
</xsd:element>
</xsd:all>
</xsd:complexType>
</xsd:element>
</xsd:all>
  <xsd:attribute name="action" type="xsd:string" use="optional" />
</xsd:complexType>
</xsd:element>
</xsd:all>
</xsd:complexType>
</xsd:element>
</xsd:all>
</xsd:complexType>
</xsd:element>
</xsd:all>
</xsd:complexType>
</xsd:element>
<xsd:element name="D1-InitialLoadIMD" minOccurs="0">
  <xsd:complexType>
    <xsd:all>
      <xsd:element name="initialMeasurementDataId" minOccurs="0">
        <xsd:simpleType>
          <xsd:restriction base="xsd:string">

```

```

        <xsd:maxLength value="14"/>
    </xsd:restriction>
</xsd:simpleType>
</xsd:element>
<xsd:element name="bo" minOccurs="0">
    <xsd:simpleType>
        <xsd:restriction base="xsd:string">
            <xsd:maxLength value="30"/>
        </xsd:restriction>
    </xsd:simpleType>
</xsd:element>
<xsd:element name="fromDateTime" nillable="true" type="xsd:dateTime" minOccurs="0"/>
<xsd:element name="toDateTime" nillable="true" type="xsd:dateTime" minOccurs="0"/>
<xsd:element name="boStatus" minOccurs="0">
    <xsd:simpleType>
        <xsd:restriction base="xsd:string">
            <xsd:maxLength value="12"/>
        </xsd:restriction>
    </xsd:simpleType>
</xsd:element>
<xsd:element name="statusReason" minOccurs="0">
    <xsd:simpleType>
        <xsd:restriction base="xsd:string">
            <xsd:maxLength value="30"/>
        </xsd:restriction>
    </xsd:simpleType>
</xsd:element>
<xsd:element name="dataSource" minOccurs="0">
    <xsd:simpleType>
        <xsd:restriction base="xsd:string">
            <xsd:enumeration value="DIRE"/>
            <xsd:enumeration value="D1ST"/>
        </xsd:restriction>
    </xsd:simpleType>
</xsd:element>
<xsd:element name="timeZone" minOccurs="0">
    <xsd:simpleType>
        <xsd:restriction base="xsd:string">
            <xsd:maxLength value="10"/>
        </xsd:restriction>
    </xsd:simpleType>
</xsd:element>
<xsd:element name="creationDateTime" nillable="true" type="xsd:dateTime" minOccurs="0"/>
<xsd:element name="comments" minOccurs="0">
    <xsd:simpleType>
        <xsd:restriction base="xsd:string">
            <xsd:maxLength value="254"/>
        </xsd:restriction>
    </xsd:simpleType>
</xsd:element>
<xsd:element name="isTraceOn" minOccurs="0">
    <xsd:simpleType>
        <xsd:restriction base="xsd:string">
            <xsd:enumeration value="D1NO"/>
            <xsd:enumeration value="D1YS"/>
        </xsd:restriction>
    </xsd:simpleType>
</xsd:element>
<xsd:element name="isIntervalDateTimePopulated" minOccurs="0">
    <xsd:simpleType>
        <xsd:restriction base="xsd:string">
            <xsd:enumeration value="D1NO"/>
            <xsd:enumeration value="D1YS"/>
        </xsd:restriction>
    </xsd:simpleType>
</xsd:element>
<xsd:element name="serviceProvider" minOccurs="0">
    <xsd:simpleType>
        <xsd:restriction base="xsd:string">
            <xsd:maxLength value="30"/>
        </xsd:restriction>
    </xsd:simpleType>
</xsd:element>

```

```

</xsd:element>
<xsd:element name="isAutomatedRetry" minOccurs="0">
  <xsd:simpleType>
    <xsd:restriction base="xsd:string">
      <xsd:enumeration value="DINO"/>
      <xsd:enumeration value="DLYS"/>
    </xsd:restriction>
  </xsd:simpleType>
</xsd:element>
<xsd:element name="nextRetryDateTime" nillable="true" type="xsd:dateTime" minOccurs="0"/>
<xsd:element name="retryUntilDateTime" nillable="true" type="xsd:dateTime" minOccurs="0"/>
>
<xsd:element name="veeGroupRole" nillable="true" minOccurs="0">
<xsd:simpleType>
  <xsd:restriction base="xsd:string">
    <xsd:enumeration value="DLES"/>
    <xsd:enumeration value="DILIL"/>
    <xsd:enumeration value="DILIS"/>
    <xsd:enumeration value="DIMO"/>
    <xsd:enumeration value="DIPR"/>
  </xsd:restriction>
</xsd:simpleType>
</xsd:element>
<xsd:element name="startReadingDateTime" type="xsd:dateTime" minOccurs="0"/>
<xsd:element name="startReading" minOccurs="0">
  <xsd:simpleType>
    <xsd:restriction base="xsd:decimal">
      <xsd:minExclusive value="-9999999999.999999"/>
      <xsd:maxExclusive value="9999999999.999999"/>
    </xsd:restriction>
  </xsd:simpleType>
</xsd:element>
<xsd:element name="startReadingCondition" type="xsd:string" minOccurs="0"/>
<xsd:element name="preVEE" minOccurs="0">
  <xsd:complexType>
    <xsd:all>
      <xsd:element name="simdId" minOccurs="0">
        <xsd:simpleType>
          <xsd:restriction base="xsd:string">
            <xsd:maxLength value="14"/>
          </xsd:restriction>
        </xsd:simpleType>
      </xsd:element>
      <xsd:element name="dvcIdN" minOccurs="0">
        <xsd:simpleType>
          <xsd:restriction base="xsd:string">
            <xsd:maxLength value="120"/>
          </xsd:restriction>
        </xsd:simpleType>
      </xsd:element>
      <xsd:element name="mcId" minOccurs="0">
        <xsd:simpleType>
          <xsd:restriction base="xsd:string">
            <xsd:maxLength value="12"/>
          </xsd:restriction>
        </xsd:simpleType>
      </xsd:element>
      <xsd:element name="mcIdN" minOccurs="0">
        <xsd:simpleType>
          <xsd:restriction base="xsd:string">
            <xsd:maxLength value="120"/>
          </xsd:restriction>
        </xsd:simpleType>
      </xsd:element>
      <xsd:element name="externalId" minOccurs="0">
        <xsd:simpleType>
          <xsd:restriction base="xsd:string">
            <xsd:maxLength value="120"/>
          </xsd:restriction>
        </xsd:simpleType>
      </xsd:element>
      <xsd:element name="uom" minOccurs="0">

```

```

    <xsd:simpleType>
      <xsd:restriction base="xsd:string">
        <xsd:maxLength value="30"/>
      </xsd:restriction>
    </xsd:simpleType>
  </xsd:element>
  <xsd:element name="externalUOM" minOccurs="0">
    <xsd:simpleType>
      <xsd:restriction base="xsd:string">
        <xsd:maxLength value="30"/>
      </xsd:restriction>
    </xsd:simpleType>
  </xsd:element>
  <xsd:element name="tou" minOccurs="0">
    <xsd:simpleType>
      <xsd:restriction base="xsd:string">
        <xsd:maxLength value="30"/>
      </xsd:restriction>
    </xsd:simpleType>
  </xsd:element>
  <xsd:element name="externalTOU" minOccurs="0">
    <xsd:simpleType>
      <xsd:restriction base="xsd:string">
        <xsd:maxLength value="30"/>
      </xsd:restriction>
    </xsd:simpleType>
  </xsd:element>
  <xsd:element name="sqi" minOccurs="0">
    <xsd:simpleType>
      <xsd:restriction base="xsd:string">
        <xsd:maxLength value="30"/>
      </xsd:restriction>
    </xsd:simpleType>
  </xsd:element>
  <xsd:element name="externalSQI" minOccurs="0">
    <xsd:simpleType>
      <xsd:restriction base="xsd:string">
        <xsd:maxLength value="30"/>
      </xsd:restriction>
    </xsd:simpleType>
  </xsd:element>
  <xsd:element name="stDt" nillable="true" type="xsd:dateTime" minOccurs="0"/>
  <xsd:element name="stQty" minOccurs="0">
    <xsd:simpleType>
      <xsd:restriction base="xsd:decimal">
        <xsd:minExclusive value="-9999999999.999999"/>
        <xsd:maxExclusive value="9999999999.999999"/>
      </xsd:restriction>
    </xsd:simpleType>
  </xsd:element>
  <xsd:element name="enDt" nillable="true" type="xsd:dateTime" minOccurs="0"/>
  <xsd:element name="enQty" minOccurs="0">
    <xsd:simpleType>
      <xsd:restriction base="xsd:decimal">
        <xsd:minExclusive value="-9999999999.999999"/>
        <xsd:maxExclusive value="9999999999.999999"/>
      </xsd:restriction>
    </xsd:simpleType>
  </xsd:element>
  <xsd:element name="imdType" minOccurs="0">
    <xsd:simpleType>
      <xsd:restriction base="xsd:string">
        <xsd:enumeration value="DIES"/>
        <xsd:enumeration value="DIGA"/>
        <xsd:enumeration value="DILIL"/>
        <xsd:enumeration value="DIMO"/>
      </xsd:restriction>
    </xsd:simpleType>
  </xsd:element>
  <xsd:element name="mcIS" minOccurs="0">
    <xsd:simpleType>
      <xsd:restriction base="xsd:string">

```

```

        <xsd:enumeration value="D1IN"/>
        <xsd:enumeration value="D1SC"/>
    </xsd:restriction>
</xsd:simpleType>
</xsd:element>
<xsd:element name="inShift" minOccurs="0">
    <xsd:simpleType>
        <xsd:restriction base="xsd:string">
            <xsd:enumeration value="D1NS"/>
            <xsd:enumeration value="D1SH"/>
        </xsd:restriction>
    </xsd:simpleType>
</xsd:element>
<xsd:element name="mcm" minOccurs="0">
    <xsd:simpleType>
        <xsd:restriction base="xsd:decimal">
            <xsd:minExclusive value="-99999999999.999999"/>
            <xsd:maxExclusive value="99999999999.999999"/>
        </xsd:restriction>
    </xsd:simpleType>
</xsd:element>
<xsd:element name="nd" minOccurs="0">
    <xsd:simpleType>
        <xsd:restriction base="xsd:decimal">
            <xsd:minExclusive value="-999999999"/>
            <xsd:maxExclusive value="999999999"/>
        </xsd:restriction>
    </xsd:simpleType>
</xsd:element>
<xsd:element name="tz" minOccurs="0">
    <xsd:simpleType>
        <xsd:restriction base="xsd:string">
            <xsd:maxLength value="10"/>
        </xsd:restriction>
    </xsd:simpleType>
</xsd:element>
<xsd:element name="externalTimeZone" minOccurs="0">
    <xsd:simpleType>
        <xsd:restriction base="xsd:string">
            <xsd:maxLength value="20"/>
        </xsd:restriction>
    </xsd:simpleType>
</xsd:element>
<xsd:element name="spi" nillable="true" type="xsd:int" minOccurs="0"/>
<xsd:element name="ccond" type="xsd:string" minOccurs="0"/>
<xsd:element name="sts" minOccurs="0">
    <xsd:complexType>
        <xsd:sequence>
            <xsd:element name="stsL" minOccurs="0" maxOccurs="unbounded">
                <xsd:complexType>
                    <xsd:sequence>
                        <xsd:element name="s" minOccurs="0">
                            <xsd:simpleType>
                                <xsd:restriction base="xsd:decimal">
                                    <xsd:minExclusive value="-99999"/>
                                    <xsd:maxExclusive value="99999"/>
                                </xsd:restriction>
                            </xsd:simpleType>
                        </xsd:element>
                        <xsd:element name="st" minOccurs="0">
                            <xsd:simpleType>
                                <xsd:restriction base="xsd:string">
                                    <xsd:maxLength value="6"/>
                                </xsd:restriction>
                            </xsd:simpleType>
                        </xsd:element>
                    </xsd:sequence>
                </xsd:complexType>
            </xsd:element>
        </xsd:sequence>
    </xsd:complexType>
</xsd:element>

```



```

<xsd:element name="msrs" minOccurs="0">
  <xsd:complexType>
    <xsd:sequence>
      <xsd:element name="mL" minOccurs="0" maxOccurs="unbounded">
        <xsd:complexType>
          <xsd:sequence>
            <xsd:element name="s" minOccurs="0">
              <xsd:simpleType>
                <xsd:restriction base="xsd:decimal">
                  <xsd:minExclusive value="-99999"/>
                  <xsd:maxExclusive value="99999"/>
                </xsd:restriction>
              </xsd:simpleType>
            </xsd:element>
            <xsd:element name="dt" nillable="true" type="xsd:dateTime" minOccurs="0"/>
          </xsd:sequence>
        </xsd:complexType>
      </xsd:element>
      <xsd:element name="q" minOccurs="0">
        <xsd:simpleType>
          <xsd:restriction base="xsd:decimal">
            <xsd:minExclusive value="-9999999999.999999"/>
            <xsd:maxExclusive value="9999999999.999999"/>
          </xsd:restriction>
        </xsd:simpleType>
      </xsd:element>
      <xsd:element name="ue" minOccurs="0">
        <xsd:simpleType>
          <xsd:restriction base="xsd:string">
            <xsd:enumeration value="D1UE"/>
          </xsd:restriction>
        </xsd:simpleType>
      </xsd:element>
      <xsd:element name="fc" type="xsd:string" minOccurs="0"/>
      <xsd:element name="r" minOccurs="0">
        <xsd:simpleType>
          <xsd:restriction base="xsd:decimal">
            <xsd:minExclusive value="-9999999999.999999"/>
            <xsd:maxExclusive value="9999999999.999999"/>
          </xsd:restriction>
        </xsd:simpleType>
      </xsd:element>
      <xsd:element name="rc" type="xsd:string" minOccurs="0"/>
      <xsd:element name="sts" minOccurs="0">
        <xsd:complexType>
          <xsd:sequence>
            <xsd:element name="stsL" minOccurs="0" maxOccurs="unbounded">
              <xsd:complexType>
                <xsd:sequence>
                  <xsd:element name="s" minOccurs="0">
                    <xsd:simpleType>
                      <xsd:restriction base="xsd:decimal">
                        <xsd:minExclusive value="-99999"/>
                        <xsd:maxExclusive value="99999"/>
                      </xsd:restriction>
                    </xsd:simpleType>
                  </xsd:element>
                  <xsd:element name="st" minOccurs="0">
                    <xsd:simpleType>
                      <xsd:restriction base="xsd:string">
                        <xsd:maxLength value="6"/>
                      </xsd:restriction>
                    </xsd:simpleType>
                  </xsd:element>
                </xsd:sequence>
              </xsd:complexType>
            </xsd:element>
          </xsd:sequence>
        </xsd:complexType>
      </xsd:element>
    </xsd:sequence>
  </xsd:complexType>
</xsd:element>
</xsd:sequence>

```

```

    </xsd:complexType>
  </xsd:element>
</xsd:all>
</xsd:complexType>
</xsd:element>
<xsd:element name="rawData" type="xsd:anyType" minOccurs="0"/>
<xsd:element name="processData" minOccurs="0">
  <xsd:complexType>
    <xsd:all>
      <xsd:element name="isShiftedStartEnd" minOccurs="0">
        <xsd:simpleType>
          <xsd:restriction base="xsd:string">
            <xsd:enumeration value="DlNO"/>
            <xsd:enumeration value="DlYS"/>
          </xsd:restriction>
        </xsd:simpleType>
      </xsd:element>
      <xsd:element name="isShiftedIntervals" minOccurs="0">
        <xsd:simpleType>
          <xsd:restriction base="xsd:string">
            <xsd:enumeration value="DlNO"/>
            <xsd:enumeration value="DlYS"/>
          </xsd:restriction>
        </xsd:simpleType>
      </xsd:element>
      <xsd:element name="isTimeZoneConverted" minOccurs="0">
        <xsd:simpleType>
          <xsd:restriction base="xsd:string">
            <xsd:enumeration value="DlNO"/>
            <xsd:enumeration value="DlYS"/>
          </xsd:restriction>
        </xsd:simpleType>
      </xsd:element>
      <xsd:element name="isErrorEncountered" minOccurs="0">
        <xsd:simpleType>
          <xsd:restriction base="xsd:string">
            <xsd:enumeration value="DlNO"/>
            <xsd:enumeration value="DlYS"/>
          </xsd:restriction>
        </xsd:simpleType>
      </xsd:element>
      <xsd:element name="servicePointId" minOccurs="0">
        <xsd:simpleType>
          <xsd:restriction base="xsd:string">
            <xsd:maxLength value="12"/>
          </xsd:restriction>
        </xsd:simpleType>
      </xsd:element>
      <xsd:element name="installationConstant" minOccurs="0">
        <xsd:simpleType>
          <xsd:restriction base="xsd:decimal">
            <xsd:minExclusive value="-999999.999999"/>
            <xsd:maxExclusive value="999999.999999"/>
          </xsd:restriction>
        </xsd:simpleType>
      </xsd:element>
      <xsd:element name="deviceId" minOccurs="0">
        <xsd:simpleType>
          <xsd:restriction base="xsd:string">
            <xsd:maxLength value="12"/>
          </xsd:restriction>
        </xsd:simpleType>
      </xsd:element>
      <xsd:element name="allowNonZeroIntervalsForEstimate" minOccurs="0">
        <xsd:simpleType>
          <xsd:restriction base="xsd:string">
            <xsd:enumeration value="DlNO"/>
            <xsd:enumeration value="DlYS"/>
          </xsd:restriction>
        </xsd:simpleType>
      </xsd:element>
      <xsd:element name="disableReEstimate" minOccurs="0">

```

```

<xsd:simpleType>
  <xsd:restriction base="xsd:string">
    <xsd:enumeration value="D1NO"/>
    <xsd:enumeration value="D1YS"/>
  </xsd:restriction>
</xsd:simpleType>
</xsd:element>
<xsd:element name="reEstimationActivity" minOccurs="0">
  <xsd:simpleType>
    <xsd:restriction base="xsd:string">
      <xsd:maxLength value="14"/>
    </xsd:restriction>
  </xsd:simpleType>
</xsd:element>
<xsd:element name="logs" minOccurs="0">
  <xsd:complexType>
    <xsd:all>
      <xsd:element name="logsList" minOccurs="0">
        <xsd:complexType>
          <xsd:sequence>
            <xsd:element name="logsEntry" minOccurs="0">
              <xsd:complexType>
                <xsd:sequence>
                  <xsd:element name="sequence" minOccurs="0">
                    <xsd:simpleType>
                      <xsd:restriction base="xsd:decimal">
                        <xsd:minExclusive value="-999"/>
                        <xsd:maxExclusive value="999"/>
                      </xsd:restriction>
                    </xsd:simpleType>
                  </xsd:element>
                  <xsd:element name="mo" minOccurs="0">
                    <xsd:simpleType>
                      <xsd:restriction base="xsd:string">
                        <xsd:maxLength value="12"/>
                      </xsd:restriction>
                    </xsd:simpleType>
                  </xsd:element>
                  <xsd:element name="pkValue1" minOccurs="0">
                    <xsd:simpleType>
                      <xsd:restriction base="xsd:string">
                        <xsd:maxLength value="50"/>
                      </xsd:restriction>
                    </xsd:simpleType>
                  </xsd:element>
                  <xsd:element name="pkValue2" minOccurs="0">
                    <xsd:simpleType>
                      <xsd:restriction base="xsd:string">
                        <xsd:maxLength value="50"/>
                      </xsd:restriction>
                    </xsd:simpleType>
                  </xsd:element>
                  <xsd:element name="pkValue3" minOccurs="0">
                    <xsd:simpleType>
                      <xsd:restriction base="xsd:string">
                        <xsd:maxLength value="50"/>
                      </xsd:restriction>
                    </xsd:simpleType>
                  </xsd:element>
                  <xsd:element name="pkValue4" minOccurs="0">
                    <xsd:simpleType>
                      <xsd:restriction base="xsd:string">
                        <xsd:maxLength value="50"/>
                      </xsd:restriction>
                    </xsd:simpleType>
                  </xsd:element>
                  <xsd:element name="pkValue5" minOccurs="0">
                    <xsd:simpleType>
                      <xsd:restriction base="xsd:string">
                        <xsd:maxLength value="50"/>
                      </xsd:restriction>
                    </xsd:simpleType>
                  </xsd:element>
                </xsd:sequence>
              </xsd:complexType>
            </xsd:element>
          </xsd:sequence>
        </xsd:complexType>
      </xsd:element>
    </xsd:all>
  </xsd:complexType>
</xsd:element>

```

```

</xsd:element>
<xsd:element name="logEntryType" minOccurs="0">
  <xsd:simpleType>
    <xsd:restriction base="xsd:string">
      <xsd:enumeration value="D1TD"/>
      <xsd:enumeration value="F1CR"/>
      <xsd:enumeration value="F1ER"/>
      <xsd:enumeration value="F1EX"/>
      <xsd:enumeration value="F1ST"/>
      <xsd:enumeration value="F1SY"/>
      <xsd:enumeration value="F1TD"/>
      <xsd:enumeration value="F1US"/>
    </xsd:restriction>
  </xsd:simpleType>
</xsd:element>
<xsd:element name="logDateTime" nillable="true" type="xsd:dateTime" minOccurs="0">
  </xsd:element>
<xsd:element name="boStatus" minOccurs="0">
  <xsd:simpleType>
    <xsd:restriction base="xsd:string">
      <xsd:maxLength value="12"/>
    </xsd:restriction>
  </xsd:simpleType>
</xsd:element>
<xsd:element name="description" minOccurs="0">
  <xsd:simpleType>
    <xsd:restriction base="xsd:string">
      <xsd:maxLength value="60"/>
    </xsd:restriction>
  </xsd:simpleType>
</xsd:element>
<xsd:element name="user" minOccurs="0">
  <xsd:simpleType>
    <xsd:restriction base="xsd:string">
      <xsd:maxLength value="8"/>
    </xsd:restriction>
  </xsd:simpleType>
</xsd:element>
<xsd:element name="logMessage" minOccurs="0">
  <xsd:simpleType>
    <xsd:restriction base="xsd:string">
      <xsd:maxLength value="4000"/>
    </xsd:restriction>
  </xsd:simpleType>
</xsd:element>
<xsd:element name="characteristicType" minOccurs="0">
  <xsd:simpleType>
    <xsd:restriction base="xsd:string">
      <xsd:maxLength value="20"/>
    </xsd:restriction>
  </xsd:simpleType>
</xsd:element>
<xsd:element name="characteristicValue" minOccurs="0">
  <xsd:simpleType>
    <xsd:restriction base="xsd:string">
      <xsd:maxLength value="16"/>
    </xsd:restriction>
  </xsd:simpleType>
</xsd:element>
<xsd:element name="ad hocValue" minOccurs="0">
  <xsd:simpleType>
    <xsd:restriction base="xsd:string">
      <xsd:maxLength value="254"/>
    </xsd:restriction>
  </xsd:simpleType>
</xsd:element>
<xsd:element name="fkValue1" minOccurs="0">
  <xsd:simpleType>
    <xsd:restriction base="xsd:string">
      <xsd:maxLength value="50"/>
    </xsd:restriction>
  </xsd:simpleType>
</xsd:element>

```

```

</xsd:element>
<xsd:element name="fkValue2" minOccurs="0">
  <xsd:simpleType>
    <xsd:restriction base="xsd:string">
      <xsd:maxLength value="50"/>
    </xsd:restriction>
  </xsd:simpleType>
</xsd:element>
<xsd:element name="fkValue3" minOccurs="0">
  <xsd:simpleType>
    <xsd:restriction base="xsd:string">
      <xsd:maxLength value="50"/>
    </xsd:restriction>
  </xsd:simpleType>
</xsd:element>
<xsd:element name="fkValue4" minOccurs="0">
  <xsd:simpleType>
    <xsd:restriction base="xsd:string">
      <xsd:maxLength value="50"/>
    </xsd:restriction>
  </xsd:simpleType>
</xsd:element>
<xsd:element name="fkValue5" minOccurs="0">
  <xsd:simpleType>
    <xsd:restriction base="xsd:string">
      <xsd:maxLength value="50"/>
    </xsd:restriction>
  </xsd:simpleType>
</xsd:element>
<xsd:element name="messageCategory" minOccurs="0">
  <xsd:simpleType>
    <xsd:restriction base="xsd:decimal">
      <xsd:minExclusive value="-99999"/>
      <xsd:maxExclusive value="99999"/>
    </xsd:restriction>
  </xsd:simpleType>
</xsd:element>
<xsd:element name="messageNumber" minOccurs="0">
  <xsd:simpleType>
    <xsd:restriction base="xsd:decimal">
      <xsd:minExclusive value="-99999"/>
      <xsd:maxExclusive value="99999"/>
    </xsd:restriction>
  </xsd:simpleType>
</xsd:element>
<xsd:element name="messageParm1" minOccurs="0">
  <xsd:simpleType>
    <xsd:restriction base="xsd:string">
      <xsd:maxLength value="30"/>
    </xsd:restriction>
  </xsd:simpleType>
</xsd:element>
<xsd:element name="messageParm2" minOccurs="0">
  <xsd:simpleType>
    <xsd:restriction base="xsd:string">
      <xsd:maxLength value="30"/>
    </xsd:restriction>
  </xsd:simpleType>
</xsd:element>
<xsd:element name="messageParm3" minOccurs="0">
  <xsd:simpleType>
    <xsd:restriction base="xsd:string">
      <xsd:maxLength value="30"/>
    </xsd:restriction>
  </xsd:simpleType>
</xsd:element>
<xsd:element name="messageParm4" minOccurs="0">
  <xsd:simpleType>
    <xsd:restriction base="xsd:string">
      <xsd:maxLength value="30"/>
    </xsd:restriction>
  </xsd:simpleType>
</xsd:element>

```

```

</xsd:element>
<xsd:element name="messageParm5" minOccurs="0">
  <xsd:simpleType>
    <xsd:restriction base="xsd:string">
      <xsd:maxLength value="30"/>
    </xsd:restriction>
  </xsd:simpleType>
</xsd:element>
<xsd:element name="messageParm6" minOccurs="0">
  <xsd:simpleType>
    <xsd:restriction base="xsd:string">
      <xsd:maxLength value="30"/>
    </xsd:restriction>
  </xsd:simpleType>
</xsd:element>
<xsd:element name="messageParm7" minOccurs="0">
  <xsd:simpleType>
    <xsd:restriction base="xsd:string">
      <xsd:maxLength value="30"/>
    </xsd:restriction>
  </xsd:simpleType>
</xsd:element>
<xsd:element name="messageParm8" minOccurs="0">
  <xsd:simpleType>
    <xsd:restriction base="xsd:string">
      <xsd:maxLength value="30"/>
    </xsd:restriction>
  </xsd:simpleType>
</xsd:element>
<xsd:element name="messageParm9" minOccurs="0">
  <xsd:simpleType>
    <xsd:restriction base="xsd:string">
      <xsd:maxLength value="30"/>
    </xsd:restriction>
  </xsd:simpleType>
</xsd:element>
</xsd:sequence>
</xsd:complexType>
</xsd:element>
</xsd:sequence>
</xsd:complexType>
</xsd:element>
<xsd:element name="deviceEventTypes" minOccurs="0">
  <xsd:complexType>
    <xsd:sequence>
      <xsd:element name="deviceEventTypesList" minOccurs="0" maxOccurs="unbounded">
        <xsd:complexType>
          <xsd:sequence>
            <xsd:element name="deviceEventType" minOccurs="0">
              <xsd:simpleType>
                <xsd:restriction base="xsd:string">
                  <xsd:maxLength value="30"/>
                </xsd:restriction>
              </xsd:simpleType>
            </xsd:element>
          </xsd:sequence>
        </xsd:complexType>
      </xsd:element>
    </xsd:sequence>
  </xsd:complexType>
</xsd:element>
</xsd:all>
</xsd:complexType>
</xsd:element>
<xsd:element name="boStatusDateTime" nillable="true" type="xsd:dateTime" minOccurs="0"/>
<xsd:element name="isReprocessPerformed" minOccurs="0">
  <xsd:simpleType>
    <xsd:restriction base="xsd:string">
      <xsd:enumeration value="D1NO"/>
    </xsd:restriction>
  </xsd:simpleType>

```

```

        <xsd:enumeration value="DIYS"/>
    </xsd:restriction>
</xsd:simpleType>
</xsd:element>
<xsd:element name="serviceProviderExternalId" minOccurs="0">
    <xsd:simpleType>
        <xsd:restriction base="xsd:string">
            <xsd:maxLength value="60"/>
        </xsd:restriction>
    </xsd:simpleType>
</xsd:element>
<xsd:element name="syncIMDOtherInfo" minOccurs="0">
    <xsd:complexType>
        <xsd:sequence>
            <xsd:element name="meterReadSource" type="xsd:string" minOccurs="0"/>
            <xsd:element name="reviewHiLo" type="xsd:string" minOccurs="0"/>
        </xsd:sequence>
    </xsd:complexType>
</xsd:element>
<xsd:element name="version" minOccurs="0">
    <xsd:simpleType>
        <xsd:restriction base="xsd:decimal">
            <xsd:minExclusive value="-99999"/>
            <xsd:maxExclusive value="99999"/>
        </xsd:restriction>
    </xsd:simpleType>
</xsd:element>
</xsd:all>
</xsd:complexType>
</xsd:element>
</xsd:all>
</xsd:complexType>
</xsd:element>
</xsd:schema>

```

Smart Grid Gateway Adapter Native Implementations

This section describes Smart Grid Gateway native implementations. Native implementations can be used with **either** on-premises implementations of Oracle Utilities Smart Grid Gateway, or with Oracle Utilities cloud services such as Oracle Utilities Meter Solution Cloud Service or Oracle Utilities Customer Cloud Service.

Payload Processing

In native implementations, Oracle Smart Grid Gateway adapters process usage and device event payloads via batch processing. Files are sent from a head end system to a file system (for on-premises implementations) or an Oracle Cloud Object Storage location (for cloud services), where they are processed via batch processes.

NOTE: The total length of the file name for payload files, including the name, delimiter, and extension, should be no greater than 96 characters.

This process requires set up and configuration of the following:

- **Key Rings and Key Pairs:** Records used to link an Oracle Cloud Object Storage location to records in Oracle Utilities cloud services. Used with cloud services only.
- **Object Storage Locations:** One or more Oracle Object Storage buckets where payload files are sent from the head end system for processing. Used with cloud services only.
- **File Storage Configuration Extendable Lookup Values:** An extendable lookup value that defines the file location used for payload processing and allows it to be referenced by batch processes

- **Head End Systems:** A record that defines how specific types of payload processing are handled, such the business object to use to create initial measurements and device events
- **Adapter Extendable Lookups:** Lookup value that define details used by data mapping and processing
- **SGG Payload Processing Configuration Extendable Lookup Values:** An extendable lookup value that defines payload processing details for a specific head end system
- **Payload Processing Batch Controls:** A batch control used for payload process (based on a template batch control provided with the base package)

See the following sections below for more details about each of these.

NOTE: The Itron OpenWay Adapter uses an alternative method for processing usage and device event payloads. See [Itron OpenWay Payload Processing](#) for more information.

Creating Key Rings and Pairs

NOTE: Key Rings and Pairs are used with cloud services **only**.

When using Smart Grid Gateway adapters with cloud services, connection between the Oracle Utilities cloud service and Oracle Object Storage requires an API signature key. See **API Key Management** in the *Oracle Utilities Cloud Services Object Storage Setup Guide* for more information.

API key rings and key pairs are maintained in the **Key Ring** portal. This portal contains the following zones:

- **Key Ring:** Displays basic information about the key ring
- **Key Pairs:** Displays a list of key pairs for the current key ring

Key rings are defined by the following:

- **Key Ring:** A unique code for the key ring
- **Key Ring Class:** Signature (default)
- **Status:** The current status of the key ring. Note: Key pairs can only be generated for Active key rings. Once a key ring has been deactivated, you can no longer create key pairs for that ring.
- **Description:** A name for the key ring (this will be referenced in the File Location extendable lookup)

Once the key ring is created, you need to generate and activate the key pair. Click **Generate Key** to generate a key pair for the key ring.

Key Pairs are defined by the following:

- **Sequence:** The sequence of the key pair (the order in which the key pair was created)
- **Creation Date/Time:** The date/time when the key pair was created
- **Key Status:** The current status of the key pair. Key pairs are inactive when first created.
- **Public Key:** Click **View** to open a dialog box containing the public key.
- **Action:** Click **Activate** to activate an inactive key pair.

Once the key ring and key pair have been created, the key should be pasted into the **User API Key** in **Oracle Identification and Access Management (IAM)** See the **User API Keys** section in the **Security and Access Management** section of the **Managing Object Storage** chapter in the *Oracle Cloud Infrastructure Services* documentation. To copy the public key click **View** in the **Actions** column in the **Key Pairs** zone, and select and copy the text in the **View Public Key** dialog box.

The last step is to activate the key. Click **Activate** in the **Actions** column in the **Key Pairs** zone. A dialog box opens displaying the following message: “Warning(s): Activating a key assumes that you have already registered the public key

with the appropriate third parties. Press Cancel to abort.” Note: Be sure to copy the public key to **Oracle Identification and Access Management** before activating it. Click **OK** to activate the key. The **Key Status** column will change to “Active”.

Creating Object Storage Locations

NOTE: Object Storage Locations are used with cloud services **only**.

When using Smart Grid Gateway adapters with cloud services, you need to create one or more buckets in Oracle Object Storage where payload files will be sent for processing. Refer to the *Oracle Utilities Cloud Services Object Storage Setup Guide* and the *Oracle Cloud Infrastructure* documentation for more information about creating buckets in Oracle Object Storage.

After creating the buckets in Oracle Object Storage, make a note of the following, as this information is needed in later configuration steps:

- Namespace
- User Oracle Cloud ID (User OCID)
- Tenancy Oracle Cloud ID (Tenancy OCID)
- Compartment Oracle Cloud ID (Compartment OCID)

Suggested Buckets for Payload Processing

This section outlined suggested sets of Object Storage buckets for each of the Smart Grid Gateway adapters.

General Guidelines

As a general rule, each adapter should have separate buckets for each of the following:

- Usage payloads
- Usage archive
- Usage errors
- Device Event payloads
- Device Event archive
- Device Event errors

If an adapter uses payloads in more than one format (such as in CSV and XML formats), you should also consider creating separate buckets for each file format type.

NOTE: If possible, archive buckets should be created in an “Archive” storage tier.

Adapter Development Kit

The table below lists suggested Object Storage buckets for the Adapter Development Kit:

Bucket Name	Storage Tier	Smart Grid Gateway Description
adk-csv	Standard	SGG ADK Adapter - CSV input
adk-csv-arch	Archive	SGG ADK Adapter - CSV archive
adk-csv-error	Standard	SGG ADK Adapter - CSV errors
adk-seeder	Standard	SGG ADK Adapter - IMD Seeder input
adk-seeder-arch	Archive	SGG ADK Adapter - IMD Seeder archive
adk-seeder-error	Standard	SGG ADK Adapter - IMD Seeder errors

Bucket Name	Storage Tier	Smart Grid Gateway Description
adk-xml	Standard	SGG ADK Adapter - XML input
adk-xml-arch	Archive	SGG ADK Adapter - XML archive
adk-xml-error	Standard	SGG ADK Adapter - XML errors

Adapter for Itron OpenWay

The table below lists suggested Object Storage buckets for the Adapter for Itron OpenWay:

Bucket Name	Storage Tier	Smart Grid Gateway Description
itronexception	Standard	SGG Itron OW Adapter - event input
itronexception-arch	Archive	SGG Itron OW Adapter - event archive
itronexception-error	Standard	SGG Itron OW Adapter - event errors
itronxml	Standard	SGG Itron OW Adapter - XML input
itronxml-arch	Archive	SGG Itron OW Adapter - XML archive
itronxml-error	Standard	SGG Itron OW Adapter - XML errors

MV90 Adapter for Itron

The table below lists suggested Object Storage buckets for the MV90 Adapter for Itron

Bucket Name	Storage Tier	Smart Grid Gateway Description
mv90-usage	Standard	SGG MV90 Adapter - usage input
mv90-usage-arch	Archive	SGG MV90 Adapter - usage archive
mv90-usage-error	Standard	SGG MV90 Adapter - usage errors

Adapter for Landis+Gyr

The table below lists suggested Object Storage buckets for the Adapter for Landis+Gyr:

Bucket Name	Storage Tier	Smart Grid Gateway Description
lg-cim-event	Standard	SGG Landis+Gyr Adapter - CIM input
lg-cim-event-arch	Archive	SGG Landis+Gyr Adapter - CIM archive
lg-cim-event-error	Standard	SGG Landis+Gyr Adapter - CIM errors
lg-event	Standard	SGG Landis+Gyr Adapter - event input
lg-event-arch	Archive	SGG Landis+Gyr Adapter - events archive
lg-event-error	Standard	SGG Landis+Gyr Adapter - event errors
lg-usage	Standard	SGG Landis+Gyr Adapter - usage input
lg-usage-arch	Archive	SGG Landis+Gyr Adapter - usage archive
lg-usage-error	Standard	SGG Landis+Gyr Adapter - usage errors

Adapter for Sensus

The table below lists suggested Object Storage buckets for the Adapter for Sensus:

Bucket Name	Storage Tier	Smart Grid Gateway Description
sensus-event	Standard	SGG Sensus Adapter - event input
sensus-event-arch	Archive	SGG Sensus Adapter - events archive
sensus-event-error	Standard	SGG Sensus Adapter - event errors
sensus-usage	Standard	SGG Sensus Adapter - usage input
sensus-usage-arch	Archive	SGG Sensus Adapter - usage archive
sensus-usage-error	Standard	SGG Sensus Adapter - usage errors

Adapter for Silver Spring Networks

The table below lists suggested Object Storage buckets for the Adapter for Silver Spring Networks:

Bucket Name	Storage Tier	Smart Grid Gateway Description
ssn-csv	Standard	SGG SSN Adapter - CSV input
ssn-csv-arch	Archive	SGG SSN Adapter - CSV archive
ssn-csv-error	Standard	SGG SSN Adapter - CSV errors
ssn-ssnxml	Standard	SGG SSN Adapter - XML input
ssn-ssnxml-arch	Archive	SGG SSN Adapter - XML archive
ssn-ssnxml-error	Standard	SGG SSN Adapter - XML errors

Creating File Storage Extendable Lookup Values

Payload processing requires defining details of file storage locations. These are file system or Object Storage locations where payload files are posted for processing. File storage configuration information is captured as values for the File Storage Configuration (F1-FileStorage) extendable lookup. These records will be referenced by the batch controls that will process the payloads.

Values for this extendable lookup are defined by the following:

- **Value:** A unique code for the extendable lookup value. This value will be referenced as a batch control parameter value.
- **Description:** A description of the extendable lookup value
- **Status:** The current status of the value. Select “Active”.
- **File Storage Details:** This section defines details for the file storage location, including:
 - **File Adapter:** The type of file adapter for the location. Options include:
 - **Native File Storage:** Used for on-premises implementations. Additional details for this type of adapter include:
 - **File Path:** A valid file path to the file location on the file system where payload files will be found
 - **Oracle Cloud Object Storage:** Used with Oracle Utilities cloud services. Additional details for this type of adapter include:
 - **User:** The user Oracle Cloud ID (ODIC) for the object storage location
 - **Tenancy:** The tenancy Oracle Cloud ID (ODIC) for the object storage location
 - **Compartment:** The compartment Oracle Cloud ID (ODIC) for the object storage location
 - **Namespace:** The namespace for the object storage location

- **Key Ring:** The Key Ring you created earlier
- **Region:** The region of the object storage tenancy for the connection (Values for this field are defined in the F1_REGION_FLG lookup).
- **Bucket Name Prefix:** Prefix used by Object Storage Bucket configuration

Refer to **External File Storage** in the *Oracle Utilities Application Framework Administrative User Guide* and the *Oracle Utilities Cloud Services Object Storage Setup Guide* for more information about using Oracle Object Storage with cloud service implementations.

Creating Head End Systems

The next step is to create a record for the head end system. This record defines processing methods for the head end system.

Processing Methods for Payload Processing

The following processing methods should be configured to support payload processing:

- **Device Event Mapping:** defines how head end-specific device events are mapped to standard device event names. The Device Event Seeder business object uses this processing method to determine which type of device event business object to instantiate when receiving device events from a head-end system.
- **Initial Measurement Creation:** defines the business objects used to create initial measurements. The IMD Seeder business object uses this processing method to determine which type of initial measurement business object to instantiate when receiving usage from a head end system.
- **UOM Translation:** defines how head end-specific unit of measure (UOM) codes are mapped to standard UOM codes.

If usage payload include time of use periods or service quantity identifiers, you should also configure **SQI Translation** and **TOU Translation** processing methods.

See [Head End Systems](#) and [Understanding Processing Methods](#) in the *Administrative User Guide* for more information about creating and configuring a head end system and its processing methods.

Configuring Adapter Extendable Lookups

Smart Grid Gateway adapters use extendable lookups to define data mapping and processing rules specific to each adapter. These include:

- **Device Event Mapping:** used to map head end specific device event codes to standard event names
- **UOM Code to Standard UOM Mapping:** used to map head end specific units of measure (UOM) to standard UOM codes
- **Status Code Mapping:** used to map head end specific interval status codes to standard Condition codes.

Some adapters have additional extendable lookups used to define categories, statuses, and other data. See the following topics for information about adapter-specific extendable lookups:

- [Configuring Itron OpenWay Extendable Lookups](#)
- [Configuring Landis+Gyr Extendable Lookups](#)
- [Configuring MV90 Extendable Lookups](#)
- [Configuring Sensus Extendable Lookups](#)
- [Configuring Silver Spring Networks Extendable Lookups](#)

Creating SGG Payload Processing Extendable Lookup Values

You also have to create an extendable lookup value to define how usage and event payloads will be processed.

Payload processing configuration information is captured in the SGG Payload Processing Configuration (D1-SGGPayloadProcess) extendable lookup.

Values for this extendable lookup are defined by the following:

- **Value:** A unique code for the extendable lookup value. This value will be referenced as a batch control parameter value.
- **Description:** A description of the lookup value
- **Status:** The current status of the value. Set this to “Active”.
- **Processing Details:** This section defines details for payload processing, including
 - **Payload Handler Class Name:** The Java class name for the processing handler to be used. See [Payload Handler Classes and Parameters](#) below for more information.
 - **Head-End System:** The head end system for which the configuration will apply. Select from the drop-down list.
 - **Populate Raw:** A checkbox that indicates if the payload data is populated as raw data.
 - **Payload Processing Result Type:** The type of payload to which the configuration applies. Options include:
 - Device Events
 - Initial Measurements
 - Initial Measurements and Device Events
 - **IMD Seeder BO (Interval):** The seeder business object used to create interval initial measurements. The base package includes the “IMD Seeder” (D1-IMDSeeder) business object for this. Applicable only if the Payload Processing Result Type is “Initial Measurements” or “Initial Measurements and Device Events”.
 - **IMD Seeder BO (Scalar):** The seeder business object used to create scalar initial measurements. The base package includes the “IMD Seeder” (D1-IMDSeeder) business object for this. Applicable only if the Payload Processing Result Type is “Initial Measurements” or “Initial Measurements and Device Events”.
 - **Device Event Seeder BO:** The seeder business object used to create device events. The base package includes the “Device Event Seeder” (D1-DeviceEventSeeder) business object for this. Applicable only if the Payload Processing Result Type is “Device Events” or “Initial Measurements and Device Events”.
 - **Filter IMD:** A checkbox that indicates if initial measurements should be filtered. Applicable only if the Payload Processing Result Type is “Initial Measurements” or “Initial Measurements and Device Events”. See **Filtering Payloads** below for more information.
 - **Filter Device Events:** A checkbox that indicates if device events should be filtered. Applicable only if the Payload Processing Result Type is “Device Events” or “Initial Measurements and Device Events”. See **Filtering Payloads** below for more information.
- **Dynamic Parameters:** A list of parameter names and values that support additional processing rules, based on the specified Payload Handler Class. See [Payload Handler Classes and Parameters](#) below for specific parameters supported by each adapter.
- **User Exit Interceptors:** Defines custom Groovy Library Scripts to be executed via user exit calls when parsing and transforming incoming usage and device data in custom and non-standard formats. User exit interceptors are defined as follows:

Payload Processing User Exit Type	Groovy Library Script	Groovy Library Method
On Get Parser	Parsing script	getParser
On Get Transformer	Transforming script	getTransformer
On Result List	Handler script	getHandler

See [Adapter Development Kit Custom Payload Processing](#) for more information about the On Get Parser and On Get Transformer User Exit Interceptors. See [Mapping Additional Fields](#) for information about the On Result List User Exit Interceptor.

NOTE: On Get Parser and On Get Transformer User Exit Interceptors are applicable only when the **Payload Handler Class Name** is set to `com.splwg.d1.domain.sgg.dg.processing.PayloadHandlerViaUserExits`.

Payload Handler Classes and Parameters

This section provides valid Payload Handler Class Names and associated dynamic parameters for supported head end systems and payload types.

Adapter Development Kit

As delivered, the Adapter Development Kit supports payload processing of usage and event data exported from an AMI head end system in the “native” initial measurement and device event data formats (the format of the initial measurement and device event seeder business objects). See [The Adapter Development Kit Native Format](#) for more information.

Payload Type: ADK CSV

- **Payload Handler Class:** `com.splwg.d1.domain.sgg.dg.processing.CSVPayloadHandler`

Payload Type: ADK XML

- **Payload Handler Class:** `com.splwg.d1.domain.sgg.dg.processing.XMLPayloadHandler`

Payload Type: ADK Seeder

- **Payload Handler Class:** `com.splwg.d1.domain.sgg.dg.processing.SeederPayloadHandler`

Processing Custom and Non-Standard Formats

The Adapter Development Kit can be configured to support payload processing of data from AMI head end systems in custom and non-standard formats. Processing payloads of this type requires a specific **Payload Handler Class** (see below), and creation of Groovy Library Scripts to parse and transform data into the “native” format. See [Adapter Development Kit Custom Payload Processing](#) and [Payload Processing User Exit Interceptor Scripts](#) for more information.

- **Payload Handler Class:** `com.splwg.d1.domain.sgg.dg.processing.PayloadHandlerViaUserExits`

The Adapter Development Kit also supports payload processing of data in the Common Information Model (CIM) format. See [Adapter Development Kit Common Information Model \(CIM\) Payload Processing](#) for more information.

Adapter for Itron OpenWay

Payload Type: Itron OpenWay XML

- **Payload Handler Class:** `com.splwg.d1.domain.sgg.d8.processing.ItronXMLPayloadHandler`
- **Dynamic Parameters:**

Dynamic Parameter Name	Description and Valid Values
<code>intervalValueDecPlaces</code>	Optional value. Specifies the number of digits after the decimal place for the quantity value. If this parameter is missing, the processing logic defaults the number of digits after the decimal place to 6.
<code>filterRegisterSource</code>	Optional value. Determines if source register data should be filtered. Valid values are 'true' and 'false' (default)

Payload Type: Itron OpenWay Exception

- **Payload Handler Class:** com.splwg.d1.domain.sgg.d8.processing.ExceptionPayloadHandler

MV90 Adapter for Itron

Payload Type: MV90

- **Payload Handler Class:** com.splwg.d1.domain.sgg.d5.processing.MV90PayloadHandler
- **Dynamic Parameters:**

Dynamic Parameter Name	Description and Valid Values
usePhysicalChannel	Optional value. Determines whether the physical channel ID is passed to the IMD seeder to create the measuring component identifier number. If this is set to false, the MV90 LOGCHAN field is used.
fieldForDvclidN	Optional value. Specifies which field is used as the value for the device ID. Valid values include: <ul style="list-style-type: none"> • DC_RECID • DC_CUSTID • DC_METERID (default)
MV90ScalarChannelSuffix	Optional value. Holds a suffix value to be added to the measuring component identifier number when a scalarIMD is created for register reads. Default value is "_S"
processMV90ScalarData	Optional value. Determines if register reads are processed. Valid values are 'true' and 'false' (default).
sendStatusAsIs	Optional value. Determines if the status codes will be passed as they came from the head end. If this set to false or not provided, then the default existing behavior when a status code is parsed and status types passed to the IMD seeder in which bits are turned on. Valid values are 'true' and 'false' (default).
MV90DateFormat	Optional value. Holds the date format used to parse provided date-time fields. The code supports the limited list of values for the format. If this parameter is missing or if the value supplied to it does not match the values from this list then the format used will be MDDYYhhmm, the default value. Valid values include: <ul style="list-style-type: none"> • MMDDYYhhmm (default) • MMYDDhhmm • DDMMYYhhmm • DDYYMMhhmm • YYMMDDhhmm • YYDDMMhhmm
MV90IntervalValueDecPlaces	Optional value. Specifies the number of digits after the decimal place for the quantity value. If this parameter is missing, the processing logic defaults the number of digits after the decimal place to 6.
MV90StrtmtrAndStoPmtrToDecimal	Optional value. Determines if the MV90 STRTMTR (Start Reading Meter) and STOPMTR (Stop Reading Meter) will be converted to a decimal. The processing logic will treat these fields as decimal use the setting to determine how many decimal points are required.

Adapter for Landis+Gyr

Payload Type: L+G Usage

- **Payload Handler Class:** com.splwg.d1.domain.sgg.d3.processing.LGUsagePayloadHandler
- **Dynamic Parameters:**

Dynamic Parameter Name	Description and Valid Values
dateTimelnUTC	Indicates whether the Landis+Gyr system is sending date/time information in UTC (true) or local time of the device (false). If not provided the default behavior will be local time of the device. Valid values are 'true' and 'false' (default)

Payload Type: L+G Event

- **Payload Handler Class:** com.splwg.d1.domain.sgg.d3.processing.LGEventPayloadHandler
- **Dynamic Parameters:**

Dynamic Parameter Name	Description and Valid Values
dateTimelnUTC	Indicates whether the Landis+Gyr system is sending date/time information in UTC (true) or local time of the device (false). If not provided the default behavior will be local time of the device. Valid values are 'true' and 'false' (default)

Payload Type: L+G CIM Event

- **Payload Handler Class:** com.splwg.d1.domain.sgg.d3.processing.LGCIMEventPayloadHandler
- **Dynamic Parameters:** N/A

Adapter for Sensus

Payload Type: Sensus RNI Usage

- **Payload Handler Class:** com.splwg.d1.domain.sgg.d6.processing.SensusUsagePayloadHandler
- **Dynamic Parameters:**

Dynamic Parameter Name	Description and Valid Values
dateTimelnUTC	Indicates whether the Sensus RNI system is sending date/time information in UTC (true) or local time of the device (false). If not provided the default behavior will be local time of the device. Valid values are 'true' and 'false' (default).
useExternalTOU	Applies to Scalar usage only. Indicates whether or not an externally referenced TOU period should be used when processing measurement data. When set to true the TOU period Sensus provides will be passed to the IMD Seeder as an external TOU "preVEE/externalTOU". When not provided or set to false then the TOU period Sensus provides will be passed to the IMD Seeder as the external MC identifier number "preVEE/mcIdN". Valid values are 'true' and 'false' (default).
sendStatusAsIs	Determines if the status codes will be passed as they received from the head end. When set to true status codes will be sent as they are received from the head end. When not provided or set to false the

Dynamic Parameter Name	Description and Valid Values
	status codes from the head will be processed through a bit mask to produce multiple individual statuses. Valid values are 'true' and 'false' (default).
sendIntervalDateTimes	When set to true the "preVEE/msrms/mL/dt" element of the IMD seeder for interval records will be populated with the interval date/time and the element "preVEE/enDt" will be populated with the interval date/time of the last interval. When not provided or set to false the "preVEE/msrms/mL/dt" element of the IMD seeder for interval records will not be populated and the element "preVEE/enDt" will be populated with: start date + spi * number of intervals. Valid values are 'true' and 'false' (default).
scalarExpanding	Optional Value. Defines the number of register reads to process in scalar payloads. When defined, Sensus payload processing uses this setting to ensure that all the scalar reads included in a payload will be processed. Default value is 2.

Payload Type: Sensus RNI Event

- **Payload Handler Class:** com.splwg.d1.domain.sgg.d6.processing.SensusEventPayloadHandler
- **Dynamic Parameters:**

Dynamic Parameter Name	Description and Valid Values
dateTimeInUTC	Indicates whether the Sensus RNI system is sending date/time information in UTC (true) or local time of the device (false). If not provided the default behavior will be local time of the device. Valid values are 'true' and 'false' (default)

Adapter for Silver Spring Networks

Payload Type: Silver Spring Networks CSV

- **Payload Handler Class:** com.splwg.d1.domain.sgg.d7.processing.SSNCSVPayloadHandler

Payload Type: Silver Spring Networks XML

- **Payload Handler Class:** com.splwg.d1.domain.sgg.d7.processing.SSNXMLPayloadHandler

Common Parameters

The following parameters can be used by all of the supported head end system adapters.

Dynamic Parameter Name	Description and Valid Values
suppressPayloadStatistics	Optional parameter. Determines if the PayloadStatistics business object will not be created while processing payload. If this set to false or not provided, then the default existing behavior when a PayloadStatistics business object is created at the start of the payload processing. Valid values are 'true' and 'false' (default).
suppressPayloadErrorNotification	Optional parameter. Determines if the PayloadErrorNotification business object will not be created when an error occurs while processing payload. If this set to false or not provided, then the default existing behavior when a PayloadErrorNotification business object is created for every error occurred

Dynamic Parameter Name	Description and Valid Values
	during the payload processing. If this set to false, the error description will be written into the application log file. Valid values are 'true' and 'false' (default).
suppressPayloadSummary	Optional parameter. Determines if the PayloadSummary business object will not be created while processing payload. If this set to false or not provided, then the default existing behavior when a PayloadSummary business object is created at the end of the payload processing. Valid values are 'true' and 'false' (default).
commitSizeInKB	Optional Parameter. Specifies the total amount of memory (in KB) allocated for Device Event and IMD seeders before they are committed. Seeders are kept in memory until their size exceeds the value defined for this parameter or the end of payload is reached. Default value is 100. Note: This parameter (either the default value or a specified value) is ignored when the chunkSize parameter is set.
chunkSize	Optional parameter. Specifies the size in bytes of a portion (chunk) of the payload that will be processed in a single batch "thread". If parameter is set, the commitSizeInKB parameter is ignored. This parameter is supported by the following payload formats: <ul style="list-style-type: none"> • Landis+Gyr Usage • Landis+Gyr Events • MV90 Usage • Sensus RNI Usage • Sensus RNI Events • Silver Spring Networks Usage (CSV) • Adapter Development Kit Usage sample format (CSV) • Adapter Development Kit via User Exits (if an instance returned from the <code>getParser</code> method implements the <code>com.splwg.dl.domain.sgg.dg.processing.ChunkProcessor</code> interface).

Filtering Payloads

When **Filter IMD** is selected, only measurements whose `<externalUOM>` matches one of the values defined in the head end system's UOM Code to Standard UOM Mapping extendable lookup are passed into the system for processing.

When **Filter Device Events** is selected, only device events whose `<externalEventName>` matches one of the values defined in the head end system's Device Event Mapping extendable lookup are passed into the system for processing.

Upload Statistics Activities

Upload statistics activities are activities that contain statistics related to the processing of usage and device events sent from a head end system.

There are three types of upload statistics activities:

- **Payload Statistics:** Contains statistics related to a specific payload (file) containing one or more initial measurements or device events.

- **Payload Error Notification:** Contains details concerning processing errors encountered in an individual payload (file) containing one or more initial measurements or device events.
- **Payload Summary:** Contains processing summary statistics for an individual payload (file) containing one or more initial measurements or device events. Payload Summary used to update related payload statistics upon the completion of payload processing.

Upload statistics activities are created during processing of payload files as follows:

- When processing begins for a payload, a **Payload Statistics** activity is created to record the process.
- If an error occurs during processing, a **Payload Error Notification** activity is created.
- When payload processing is complete, a **Payload Summary** activity is created, which in turn, updates the Payload Statistics activity with details concerning the processing of the payload, including (the start and end time of the processing, the total processing time, the number of initial measurements or device events processed, and the number of initial measurement or device event errors (if any)).

Suppressing Upload Statistics Activities

Creation of upload statistics activities can be suppressed through the use of the following dynamic parameters in the SGG Payload Processing Configuration Extendable Lookup:

- `suppressPayloadStatistics`
- `suppressPayloadSummary`
- `suppressPayloadErrorNotification` (**Note:** If this set to false, the error description will be written into the application log file.)

See **Common Parameters** in [Payload Handler Classes and Parameters](#) for more information about these parameters.

Creating Payload Processing Batch Controls

The last step is to create payload processing monitor batch controls based on the Payload Processing Monitor Template (D1-PLPRM) template. You can create separate batch controls for each head end system or for specific payload types, or any combination of both. For example, you might create a separate batch control for Itron OpenWay usage payloads and device event payloads. Creating specific batch controls allows more control when setting up batch process scheduling for payload processing. For instance, you may want to run usage payload processing every hour, but device payload processing every two hours.

To create a payload processing monitor batch control, search for the “Payload Processing Monitor Template” (D1-PLPRM) batch control, click **Duplicate**, enter a unique code for the duplicate batch control and click **OK**.

This new batch control can be used to process payloads received from head end systems.

Payload Processing Batch Control Parameters

Payload processing batch processing is controlled by the following parameters:

Parameter Name	Description	Detailed Description	Required?
<code>includeFiles</code>	Include Files	The pattern for types of files to pick up during polling. The parameter supports the "glob" syntax for using wildcard characters.	True
<code>fileLocation</code>	File Location	The Object Storage bucket to poll files from. This should be the Value of the File Location Extendable Lookup value for the appropriate bucket (usage or event).	True

Parameter Name	Description	Detailed Description	Required?
processingConfiguration	Processing Configuration	The Value of the SGG Payload Processing Configuration Extendable Lookup value	True
errorLocation	Error Location	The Object Storage bucket where defected portions of payload and related rejection details are stored. This should be the Value of the File Location Extendable Lookup value for the appropriate "error" bucket.	True
postProcessingAction	Post Processing Action	Defines what happens to a file after it has been processed: delete (default), archive or rename. If "archive" is selected, an archive bucket should be provided.	False
archiveLocation	Archive Location	The Object Storage bucket where processed files are moved to. Required if the Post Processing Action is "archive". This should be the Value of the File Location Extendable Lookup value for the appropriate "archive" bucket.	False
processedFileExtension	Processed File Extension	The text to be appended to the file name after the file has been processed. Default is "PROCESSED".	False
maxRaiseSize	Maximum Raise Size	This parameter defines the maximum number of files that the batch program would submit for processing on each polling cycle. Default is No Maximum.	False
DIST-THD-POOL	Thread Pool	Thread pool name to use if the DEFAULT thread pool is not desired.	False

NOTE: Refer to [Creating Object Storage Locations](#) for lists of suggested Object Storage buckets for each adapter.

Mapping Additional Fields

Measurements and device event files received from head end systems can include additional fields containing data to be imported into Oracle Utilities Smart Grid Gateway. These additional fields must be mapped to elements within the measurements and device events processed by Smart Grid Gateway.

This mapping can be performed through use of a custom Groovy script, via the "On Result List" User Exit Interceptor specified in the SGG Payload Processing Configuration Extendable lookup.

Payload Processing Overview

This section provides an overview of the payload processing logic when mapping data in incoming measurements or device events.

Oracle Utilities Meter Data Framework Steps

1. The file upload process program starts reading the file.
2. The upload process creates an instance of the Payload Handler class specified on the SGG Payload Processing Configuration extendable lookup. This class handles the interaction with the User Exit Interceptor script.
3. The upload process invokes the "On Result List" User Exit Interceptor. This executes a "handler" Groovy Library Script that returns an instance of a class that implements the `com.splwg.dl.domain.sgg.dg.processing.PayloadProcessingCMHandler` interface. This "CM payload handler" is initialized with a stream opened for the incoming file and a business object instance of SGG Payload Processing Configuration extendable lookup.

4. The upload process parses data from the incoming document into the “Plain XML” format and transforms the Plain XML data into a set of Initial Measurements (IMDs) or/and Device Events in the “native” XML format and returns each as child nodes added to the Result List parent node.
5. The upload process invokes the CM payload handler, passing the Result List parent node.
6. The CM payload handler transforms data the Result List parent node based on the logic in the Handler script. See **CM Payload Handler Steps**, below.
7. The upload process creates business object instances for all child nodes of the Result List.
8. The process steps (4-9) are repeated until the process returns NULL on step 4 (when there are no further records to process).

CM Payload Handler Steps

1. The CM payload handler reads the given measurement or device event inside the Result List node.
2. The CM payload handler transforms specific data elements inside the measurement or device event (such as replacing a <externalUOM> element with the standard <UOM> element) based on the logic in the handler script, and updates the Result List accordingly.

CM Handler Payload Processing User Exit Interceptor Scripts

Mapping data is performed via a Groovy Library Script that is invoked via a user exit during payload processing. The script used in this process is referred to as a “handler” script.

Handler Script

The “handler” script is responsible for transforming and mapping data elements within measurements and device events.

This script should include the `gethandler` method that returns an instance of a class that implements the `com.splwg.d1.domain.sgg.processing.PayloadProcessingCMHandler` interface.

To view details of the `PayloadProcessingCMHandler` interface in the Application Viewer, select the Java Docs Viewer, select the `com.splwg.d1.domain.sgg.dg.processing` Java package, and select `PayloadProcessingCMHandler` from the list of interfaces.

The “handler” script should be defined for the “On Result List” Payload Processing User Exit Type in the User Exit Interceptors section on the SGG Payload Processing Configuration extendable lookup. See [Creating SGG Payload Processing Extendable Lookup Values](#) for more information.

Configuration Steps

Configuration of Smart Grid Gateway adapters to support mapping of non-standard data involves the following steps:

1. Create a “handler script” that transforms and maps specific data elements inside the measurement or device event (such as replacing a <externalUOM> element with the standard <UOM> element). See [CM Handler Payload Processing User Exit Interceptor Scripts](#) for more information.
2. Create an SGG Payload Processing Configuration extendable lookup value. The **Payload Handler Class Name** should reference one of the usage or event “PayloadHandler” classes listed in the [Payload Handler Classes and Parameters](#) section. See [Creating SGG Payload Processing Extendable Lookup Values](#) for more information about creating these extendable lookup values..
3. Specify the script for the “On Result List” **Payload Processing User Exit Type** in the **User Exit Interceptors** section on the SGG Payload Processing Configuration extendable lookup. See [Creating SGG Payload Processing Extendable Lookup Values](#) for more information.
4. Create other objects and data used with payload processing, including:
 - Key Rings and Pairs (See [Creating Key Rings and Pairs](#))

- Object Storage Locations (See [Creating Object Storage Locations](#))
- File Storage Extendable Lookup values (See [Creating File Storage Extendable Lookup Values](#))
- Head End System (See [Creating Head End Systems](#))
- Payload Processing Batch Controls (See [Creating Payload Processing Batch Controls](#))

Sample Implementation

The following sample illustrates how additional fields can be mapped into the XML format sent to Smart Grid Gateway. In this case, the unit of measure for incoming measurement data is defined by an <externalUOM>, which must be mapped to the standard <UOM> element.

Sample Script

The below Groovy Script will loop through a list of “D1-IMDSeeder” nodes and check the “externalUom” for a value (GD_KWH in this example), and if equal then the <UOM> element will be created with the <externalUOM> values and the <externalUOM> element will be removed.

Script Type: Groovy Library Script

Step 10: Groovy Imports

```
import org.w3c.dom.Document;
import org.w3c.dom.Element;
import org.w3c.dom.NodeList;
import org.w3c.dom.Node;
import com.splwg.dl.domain.sgg.processing.PayloadProcessingCMHandler;
import com.splwg.shared.logging.Logger;
import com.splwg.shared.logging.LoggerFactory;
import com.splwg.base.support.scripting.XMLUtils;
```

Step 20: Groovy Library Interface

```
PayloadProcessingCMHandler getHandler()
```

Step 30: Groovy Members

```
public PayloadProcessingCMHandler getHandler() {
    return new CMhandler();
}

public class CMhandler implements PayloadProcessingCMHandler{

    org.w3c.dom.Document onList(org.w3c.dom.Document resultList, org.w3c.dom.Document plainXML) {

        NodeList imdList=resultList.getDocumentElement().getElementsByTagName("D1-IMDSeeder");
        for(int i=0;i<imdList.getLength();i++){
            Element imdEl = (Element) imdList.item(i);

            //check if msrs element exists
            NodeList msrsList = imdEl.getElementsByTagName("msrs");
            if (msrsList.length > 0) {
                //get preVEE
                NodeList preVEENodeList = imdEl.getElementsByTagName("preVEE");
                Element preVEENode = (Element) preVEENodeList.item(0);
                //get externaluom
                NodeList uomList = preVEENode.getElementsByTagName("externalUOM");

                Element uomElm = uomList.length>0 ? uomList.item(0) : null;
                String uom = uomElm!=null ? uomElm.getTextContent() : "";
                //get mcIdN
                NodeList mcIdNList = preVEENode.getElementsByTagName("dvcIdN");
                if ( uom.compareTo("GD_KWH")==0 && mcIdNList.length>0 ) {
```

```

        Element externalUOMElm = resultList.createElement("uom");
        externalUOMElm.setTextContent(uom);
        //replace uom with externalUOM
        preVEENode.replaceChild(externalUOMElm, uomElm);
    }
}
}
return resultList;
}
}

```

Sample File

Below is a sample Landis+Gyr usage file. Note that this file has a "Units" value of "GD_KWH".

```
Record Type~Record Version~Time Stamp~Premise ID~ESIID~Provisioned~Meter ID~Purpose~Commodity~Units~Calculati
```

Plain XML Output

Below is the Plain XML output for the above Landis+Gyr usage file. Note that this file has a <Units> element with a value of "GD_KWH".

```

<MeterReads
xmlns="http://xmlns.oracle.com/LandisGyrUsage">
<MeterRead>
<Origin>IMD_INT_GD_LL_SN100_good1.lg-2020-04-13-07-42-36-092</Origin
>
<ServProvExtRefId>L+G</ServProvExtRefId>
<RecordType>MEPMD01</RecordType>
<RecordVersion>20080519</RecordVersion>
<TimeStamp>11092010012000AM</TimeStamp>
<MeterID>GD_LL_SN100</MeterID>
<Purpose>OK</Purpose>
<Comodity>E</Comodity>
<Units>GD_KWH</Units>
<Interval>000100</Interval>
<Count>24</Count>
<FirstIntervalDateTime>10062010010000AM</FirstIntervalDateTime>
<Data>
<Row v="0.2316" />
<Row v="0.1416" />
<Row v="0.2904" />
<Row v="0.2628" />
<Row v="0.240" />
<Row v="0.2796" />
<Row v="0.2232" />
<Row v="0.1692" />
<Row v="0.0552" />
<Row v="0.24096" />
<Row v="0.276" />
<Row v="0.1572" />
<Row v="0.0612" />
<Row v="0.3168" />
<Row v="0.132" />
<Row v="0.1092" />
<Row v="0.2532" />
<Row v="0.2844" />
<Row v="0.198" />
<Row v="0.0756" />
<Row v="0.3084" />
<Row v="0.15240" />
<Row v="0.1788" />
<Row v="0.1716" />
</Data>
<RawData>MEPMD01~20080519~11092010012000AM~~~GD_LL_SN100~OK~E~GD_KWH~~000100~24~10062010010000AM~~0.2316~~0.
RawData>
</MeterRead>

```

```
</MeterReads>
```

Result List Input

Below is the Result List input sent to the handler script. Note that this file has an `<externalUOM>` element with a value of "GD_KWH".

```
<?xml version="1.0" encoding="UTF-8"?>
<ResultList>
<D1-IMDSeeder>
<fromDateTime>2010-10-06-00.00.00</fromDateTime>
<preVEE>
<dvcIdN>GD_LL_SN100</dvcIdN>
<externalId>IMD_INT_GD_LL_SN100_good1.lg-2020-04-13-07-42-36-092</externalId>
<externalUOM>GD_KWH</externalUOM>
<stDt>2010-10-06-00.00.00</stDt>
<spi>3600</spi>
<imdType>D1IL</imdType>
<msrs>
<mL>
<s>1</s><q>0.2316</q>
</mL>
<mL>
<s>2</s><q>0.1416</q>
</mL>
<mL>
<s>3</s><q>0.2904</q>
</mL>
<mL>
<s>4</s><q>0.2628</q>
</mL>
<mL>
<s>5</s><q>0.240</q>
</mL>
<mL>
<s>6</s><q>0.2796</q>
</mL>
<mL>
<s>7</s><q>0.2232</q>
</mL>
<mL>
<s>8</s><q>0.1692</q>
</mL>
<mL>
<s>9</s><q>0.0552</q>
</mL>
<mL>
<s>10</s><q>0.24096</q>
</mL>
<mL>
<s>11</s><q>0.276</q>
</mL>
<mL>
<s>12</s><q>0.1572</q>
</mL>
<mL>
<s>13</s><q>0.0612</q>
</mL>
<mL>
<s>14</s><q>0.3168</q>
</mL>
<mL>
<s>15</s><q>0.132</q>
</mL>
<mL>
<s>16</s><q>0.1092</q>
</mL>
<mL>
<s>17</s><q>0.2532</q>
</mL>
<mL>
```



```

<s>18</s><q>0.2844</q>
</mL>
<mL>
<s>19</s><q>0.198</q>
</mL>
<mL>
<s>20</s><q>0.0756</q>
</mL>
<mL>
<s>21</s><q>0.3084</q>
</mL>
<mL>
<s>22</s><q>0.15240</q>
</mL>
<mL>
<s>23</s><q>0.1788</q>
</mL>
<mL>
<s>24</s><q>0.1716</q>
</mL>
</msrs>
</preVEE>
<serviceProviderExternalId>L+G</serviceProviderExternalId>
</D1-IMDSeeder>
</ResultList>

```

Result List Output

Below is the Result List output sent returned by the handler script. Note that <externalUOM> element had been replaced with a <UOM> element with a value of "GD_KWH".

```

<?xml version="1.0" encoding="UTF-8"?>
<ResultList>
<D1-IMDSeeder>
<fromDateTime>2010-10-06-00.00.00</fromDateTime>
<preVEE>
<dvcIdN>GD_LL_SN100</dvcIdN>
<externalId>IMD_INT_GD_LL_SN100_good1.lg-2020-04-13-07-42-36-092</externalId>
<uom>GD_KWH</uom>
<stDt>2010-10-06-00.00.00</stDt>
<spi>3600</spi>
<imdType>D1IL</imdType>
<msrs>
<mL>
<s>1</s><q>0.2316</q>
</mL>
<mL>
<s>2</s><q>0.1416</q>
</mL>
<mL>
<s>3</s><q>0.2904</q>
</mL>
<mL>
<s>4</s><q>0.2628</q>
</mL>
<mL>
<s>5</s><q>0.240</q>
</mL>
<mL>
<s>6</s><q>0.2796</q>
</mL>
<mL>
<s>7</s><q>0.2232</q>
</mL>
<mL>
<s>8</s><q>0.1692</q>
</mL>
<mL>
<s>9</s><q>0.0552</q>
</mL>
<mL>

```

```

<s>10</s><q>0.24096</q>
</mL>
<mL>
<s>11</s><q>0.276</q>
</mL>
<mL>
<s>12</s><q>0.1572</q>
</mL>
<mL>
<s>13</s><q>0.0612</q>
</mL>
<mL>
<s>14</s><q>0.3168</q>
</mL>
<mL>
<s>15</s><q>0.132</q>
</mL>
<mL>
<s>16</s><q>0.1092</q>
</mL>
<mL>
<s>17</s><q>0.2532</q>
</mL>
<mL>
<s>18</s><q>0.2844</q>
</mL>
<mL>
<s>19</s><q>0.198</q>
</mL>
<mL>
<s>20</s><q>0.0756</q>
</mL>
<mL>
<s>21</s><q>0.3084</q>
</mL>
<mL>
<s>22</s><q>0.15240</q>
</mL>
<mL>
<s>23</s><q>0.1788</q>
</mL>
<mL>
<s>24</s><q>0.1716</q>
</mL>
</msrs>
</preVEE>
<serviceProviderExternalId>L+G</serviceProviderExternalId>
</D1-IMDSeeder>
</ResultList>

```

Itron OpenWay Payload Processing

By default, payload processing for the Itron OpenWay adapter works differently than it does for other adapters, but it can be configured to work like other adapters in which payloads are saved to a staging area in Oracle Object Storage and then processed via batch processing. For large volumes, saving to the staging area provides better performance because it allows the web service to simply drop off the payload, and the collection of saved payloads can then be processed in multiple batch processing threads.

Configuration of Itron payload processing requires the same set up and configuration as other adapters. Some specifics regarding configuration for Itron processing include the following:

- **Object Storage Locations:** Itron OpenWay payload processing uses object storage locations (including Key Rings, Key Pairs and File Storage Configuration extendable lookup values) to capture usage and event payloads or exceptions received from the head end system.
- **Head End Systems and Extendable Lookups:** Itron payload processing uses head end system and extendable lookup configuration in the same manner as other adapters.

- **SGG Payload Processing Configuration Extendable Lookup Values:** These values define payload processing details for the Itron head end system (which is referenced on the payload processing batch control).
- **Payload Processing Batch Controls:** A batch control used for payload process (based on a template batch control provided with the base package)
- **Master Configuration:** Configuration settings for Itron OpenWay payload processing, including specifying the use of a payload staging area in Object Storage. See [Itron OpenWay Master Configuration](#) for more information about configuring the system to process Itron OpenWay payloads and exceptions.

Deferring Batch Processing

We recommend configuring a monitor process on the Pending status of the Initial Load initial measurement business objects so that the VEE and measurement creation processes can be deferred to batch processing.

Deferring processing has the following additional benefits:

1. It can ensure chronological processing for scalar reads which provides more efficient processing. Processing scalar reads out of order can result in additional work as reconciliation initial measurements will be created and processed to true up the consumption calculations.
2. It can ensure measuring components are processed in order based on their relationships. For example, if a scalar channel is configured as the check channel for an interval channel, the scalar channel will be processed first so that its data is available for sum checks and any interval gap filling required.

Configuration

Configuring deferred processing involves adding the “IMD Monitor – Physical Devices” Batch Control as the Monitor Process on the Pending status to the following business objects:

- D1-InitialLoadIMDInterval
- D1-InitialLoadIMDScalar

When initial measurement processing is deferred it will be necessary to schedule the “IMD Monitor – Physical Devices” Batch Control to run more frequently. It should be scheduled such that it runs with a higher thread count immediately after the Itron Scheduled Reads cycle has completed and with fewer threads throughout the rest of day to pick up any other initial measurements that might be received (such as those received via On Demand Read commands).

Default Processing — Not Recommended

By default, payload processing for the Itron OpenWay adapter works differently than it does for other adapters. Instead of using batch processing, Itron payloads are processed as they are received. Payloads and exceptions sent from the Itron OpenWay head end system are received via inbound web services that invoke business components that process the payloads and exceptions as they are received rather than posting them to object storage locations. See [Itron OpenWay Inbound Web Services](#) for more information about the inbound web services used to receive payloads and exceptions from the Itron OpenWay head end system. This approach is not recommended.

Adapter Development Kit Custom Payload Processing

This section describes how the Oracle Utilities Smart Grid Gateway Adapter Development Kit can be configured to process custom payload formats, including payloads from non-supported head end systems.

Introduction

As delivered, the Adapter Development Kit supports payload processing of usage and event data exported from an AMI head end system in the “native” initial measurement and device event data formats (the format of the initial measurement and device event seeder business objects).

The Adapter Development Kit can also be configured to support payload processing of data from AMI head end systems in custom and non-standard formats. This involves creation of Groovy Library Scripts to:

- Parse the payload into a “plain XML” format, and
- Transform the plain XML format into the “native” initial measurement and device event data formats

These scripts are executed as User Exit Interceptors configured on the SGG Payload Processing Configuration extendable lookup. See [Creating SGG Payload Processing Configuration Extendable Lookup Values](#).

Custom Payload Processing Overview

This section provides an overview of the payload processing logic when converting incoming data into the native format.

Oracle Utilities Meter Data Framework Steps

1. The file upload process program starts reading the file.
2. The upload process creates an instance of the Payload Handler class. This class handles the interaction with the User Exit Interceptor scripts.
3. The upload process invokes the “On Get Parser” User Exit Interceptor. This executes a “parser” Groovy Library Script that returns an instance of a class that implements the `com.splwg.dl.domain.sgg.dg.processing.PayloadParser` interface. This “payload parser” is initialized with a stream opened for the incoming file and a business object instance of SGG Payload Processing Configuration extendable lookup.
4. The upload process invokes the “On Get Transformer” User Exit Interceptor. This executes a “transformer” Groovy Library Script that returns an instance of a class that implements `com.splwg.dl.domain.sgg.dg.processing.PayloadTransformer` interface. This “payload transformer” is initialized with a string representing the origin of the payload and business object instance of SGG Payload Processing Configuration extendable lookup.
5. The upload process invokes the payload parser to parse data from the incoming document into the “Plain XML” format. See [Payload Parser Steps](#), below.
6. The upload process invokes the payload transformer, passing the Plain XML data and a Result List parent node.
7. The payload transformer transforms the Plain XML data into a set of Initial Measurements (IMDs) or/and Device Events in the “native” XML format and returns each as child nodes added to the Result List parent node. See [Payload Transformer Steps](#), below.
8. The upload process creates business object instances for all child nodes of the Result List.
9. The process steps (5-9) are repeated until the payload parser returns NULL on step 5 (when there are no further records to process).

Payload Parser Steps

1. The payload parser reads an input stream until it hits the logical end of portion of data (each usage or event record), which could be transformed into Plain XML.
2. The payload parser parses the data and converts into the Plain XML format.
3. The process is performed for each call from the upload process.

Payload Transformer Steps

1. The payload transformer reads the given Plain XML.
2. The payload transformer generates a set of XML nodes representing Initial Measurements (IMDs) or Device Events. Names for nodes are taken from the provided SGG Payload Processing Configuration.

3. The payload transformer adds the generated nodes to the given Result List node.

Payload Processing User Exit Interceptor Scripts

Conversion of data from custom and non-standard formats into the “native” format is performed via a pair of Groovy Library Scripts that are invoked via user exits during payload processing (see [Custom Payload Processing Overview](#)). The two scripts used in this process include a “parser” script, and a “transformer” script.

Parser Script

The “parser” script is responsible for parsing the incoming data and converting it into the Plain XML format. This script should include the `getParser` method that returns an instance of a class that implements the `com.splwg.dl.domain.sgg.dg.processing.PayloadParser` interface.

To view details of the *PayloadParser* interface in the Application Viewer, select the **Java Docs Viewer**, select the `com.splwg.dl.domain.sgg.dg.processing` Java package, and select *PayloadParser* from the list of interfaces.

The “parser” script should be defined for the “On Get Parser” Payload Processing User Exit Type in the **User Exit Interceptors** section on the SGG Payload Processing Configuration extendable lookup. See [Creating SGG Payload Processing Extendable Lookup Values](#) for more information.

The base package includes two sample parser scripts that can be used as examples when developing custom parser scripts. See [Sample Implementation](#).

Transformer Script

The “transformer” script is responsible for converting data the Plain XML format into the “native” format. This script should include the `getTransformer` method that returns an instance of a class that implements the `com.splwg.dl.domain.sgg.dg.processing.PayloadTransformer` interface.

To view details of the *PayloadTransformer* interface in the Application Viewer, select the **Java Docs Viewer**, select the `com.splwg.dl.domain.sgg.dg.processing` Java package, and select *PayloadTransformer* from the list of interfaces.

The “transformer” script should be defined for the “On Get Transformer” Payload Processing User Exit Type in the **User Exit Interceptors** section on the SGG Payload Processing Configuration extendable lookup. See [Creating SGG Payload Processing Extendable Lookup Values](#) for more information.

The base package includes two sample transformer scripts that can be used as examples when developing custom transformer scripts. See [Sample Implementation](#).

Configuration Steps

Configuration of the Adapter Development Kit to support conversion of non-standard formats into the “native” format involves the following steps:

1. Create a “parser script” that converts data from the incoming format into Plain XML format. See [Payload Processing User Exit Interceptor Scripts](#) for more information.
2. Create a “transformer script” that converts data from the Plain XML format to the “native” format. See [Payload Processing User Exit Interceptor Scripts](#) for more information.
3. Create an SGG Payload Processing Configuration extendable lookup value with a **Payload Handler Class Name** of “`com.splwg.dl.domain.sgg.dg.processing.PayloadHandlerViaUserExits`”. See [Creating SGG Payload Processing Extendable Lookup Values](#) for more information.
4. Specify the parser script for the “On Get Parser” Payload Processing User Exit Type in the **User Exit Interceptors** section on the SGG Payload Processing Configuration extendable lookup. See [Creating SGG Payload Processing Extendable Lookup Values](#) for more information.

5. Specify the transformer script for the “On Get Transformer” Payload Processing User Exit Type in the **User Exit Interceptors** section on the SGG Payload Processing Configuration extendable lookup. See [Creating SGG Payload Processing Extendable Lookup Values](#) for more information.
6. Create other objects and data used with payload processing, including:
 - Key Rings and Pairs (See [Creating Key Rings and Pairs](#))
 - Object Storage Locations (See [Creating Object Storage Locations](#))
 - File Storage Extendable Lookup values (See [Creating File Storage Extendable Lookup Values](#))
 - Head End System (See [Creating Head End Systems](#))
 - Payload Processing Batch Controls (See [Creating Payload Processing Batch Controls](#))

Sample Implementation

The Smart Grid Gateway Adapter Development Kit includes sample parser and transformer scripts that demonstrate how custom payload processing works. These sample scripts include samples for processing data in comma separated values (CSV) format and in XML format.

Comma Separated Values Format

This page describes the comma separated values format sample implementation.

Sample File Format

In this sample, data is stored as a comma separated values file.

Note: Values in this example cannot contain a literal comma character. This restriction is added for the simplicity of file parser implementation. The parsing logic can be re-implemented to avoid this restriction. It will not affect the rest of functionality.

The sample CSV file contains the following record types:

Interval Usage: Used for interval usage measurements

Device Events: Used for device events

Trail record: Used to provide the read date/time and number of interval usage and device event records in the file

Interval Usage Format

#	Field Name	Type	Definition
1	Record Type ID	Constant value “U”	Record type identifier
2	Start Date/Time	Time in the Unix Time format.	Meter read’s start date/time
3	End Date/Time	Time in the Unix Time format.	Meter read’s end date/time
4	Device Id	Arbitrary Text	Device identifier
5	Interval Duration	Numeric Integer	The time interval between readings in seconds (seconds per interval).
6	UOM	Arbitrary Text	Describes the units of the data values
7	Data Entry(s)	Numeric Floating-Point and optional Arbitrary Text separated by “:”	Each record can contain unlimited number of data entry fields. Each data entry is a set of two fields – a reading value

#	Field Name	Type	Definition
			and an optional reading status flag. Fields are separated by “.” character. The separator is not present when the reading status flag is not provided.

Device Event Format

#	Field Name	Type	Definition
1	Record Type ID	Constant value “E”	Record type identifier
2	Event Date/Time	Time in the Unix Time format.	The date and time at which the event occurred
3	Device Id	Arbitrary Text	Device identifier
4	Event Name	Arbitrary Text	The primary identification name of the event

Trail Record Format

#	Field Name	Type	Definition
1	Record Type ID	Constant value “T”	Record type identifier
2	Creation Date/Time	Time in the Unix Time format.	Meter read’s start date/time
3	Total Records	Numeric Integer	Displays number of records in file

Sample File

```
U,1,86400,DEVICE_DG_0,900,KWH,1:S,2.5,-3.99:R,4:B
E,86400,DEVICE_DG_1,Power Outage
U,2,86400,DEVICE_DG_2,900,KWH,1:S,2,3:R,4:B,5,6,7:A
E,86402,DEVICE_DG_3,Tamper attempt suspected
U,3,86400,DEVICE_DG_4,900,KWH,1:S
T,86401,5
```

Sample Scripts

The sample implementation includes the following sample scripts designed for use with the above CSV format:

DG_SmplPrCSV: This sample script includes one method in the Library Interface – `getParser()`. The method returns an instance of the class that implements the `com.splwg.dl.domain.sgg.dg.processing.PayloadParser` interface. The class contains the following logic:

1. Parses an incoming payload in the CSV Format.
2. Transforms incoming data to Usage or Event related structures based on incoming data type
3. Returns one by one that structures in the Plain XML format

DG_SmPrCSVCh: This script is provided as a sample to demonstrate how to parse the CSV format in chunks (created via the `chunkSize` parameter) by utilizing a helper. This sample script includes one method in the Library Interface – `getParser()`. The method returns an instance of the class that implements the `com.splwg.dl.domain.sgg.dg.processing.ChunkProcessor` and `com.splwg.dl.domain.sgg.dg.processing.GenericPayload` interfaces.

The `ChunkProcessor` interface distinguishes a chunking-aware processor from the rest of implementations. A custom parser implemented in groovy can implement this interface. The `GenericPayload` interface defines methods needed to get access to a payload via specific helpers. Via this interface, a custom parser gets access to an instance of `LineReaderChunked`.

If the `chunkSize` dynamic parameter is not set in an SGG Payload Processing configuration the entire payload will be processed. See [Common Parameters](#) for more information about the `chunkSize` parameter.

The class contains the following logic:

1. Reads a line from incoming payload by utilizing the `LineReaderChunked.readLineWithinChunk()` method
2. Parses a line in the incoming payload (in the CSV Format) that was read in the previous step.
3. Transforms incoming data to Usage or Event related structures based on incoming data type
4. Returns one by one that structures in the Plain XML format

DG_SmplTrCSV: This sample script includes one method in the Library Interface – `getTransformer()`. The method returns an instance of class that implements the `com.splwg.dl.domain.sgg.dg.processing.PayloadTransformer` interface. The class contains the following logic:

1. Transforms incoming message in the Plain XML format into the “native” format (the IMD Seeder or Device Event Seeder XML nodes).
2. Adds new XML nodes as child nodes to the given Result List.

Use the **Script** portal to view these scripts in more detail.

Parsing

The parser script performs the following data mapping.

Interval Usage to Plain XML Mapping

The following table shows the mapping between fields in incoming interval data and child elements of Payload/Usage element in the Plain XML format:

Interval Usage Field	Plain XML Element
Record Type ID	RecordType
Start Date/Time	StartDateTime
End Date/Time	EndDateTime
Device Id	DeviceId
Interval Duration	IntervalDuration
UOM	UOM
Data Entry(s)	Intervals/ Interval/ Value [Status]
Record content from incoming file.	RawData

Device Event to Plain XML Mapping

The following table shows the mapping between fields in incoming interval data and child elements of Payload/Event element in the Plain XML format:

Device Event Field	Plain XML Element
Record Type ID	RecordType
Event Date/Time	DateTime
Device Id	DeviceId
Event Name	Name
Record content from incoming file.	RawData

XML Schema of Plain XML Format

The Plain XML consists of the Interval Usage and Device Event related elements at the same time.

```
<xs:schema attributeFormDefault="unqualified"
elementFormDefault="qualified"
targetNamespace="http://xmlns.oracle.com/GenericAdapter"
xmlns:xs="http://www.w3.org/2001/XMLSchema"
xmlns:ga="http://xmlns.oracle.com/GenericAdapter">
  <xs:element name="Payload" type="ga:PayloadType"/>
  <xs:complexType name="PayloadType">
    <xs:sequence>
      <xs:choice>
        <xs:element name="Usage" type="ga:UsageType"/>
        <xs:element name="Event" type="ga:EventType"/>
      </xs:choice>
      <xs:element name="RawData" type="ga:NonEmptyString"/>
    </xs:sequence>
  </xs:complexType>
  <xs:complexType name="UsageType">
    <xs:sequence>
      <xs:element name="RecordType" type="ga:RecordTypeUsageType"/>
      <xs:element name="StartDateTime" type="xs:integer"/>
      <xs:element name="EndDateTime" type="xs:integer"/>
      <xs:element name="DeviceId" type="ga:NonEmptyString"/>
      <xs:element name="IntervalDuration" type="xs:integer"/>
      <xs:element name="UOM" type="ga:NonEmptyString"/>
      <xs:element name="Intervals" type="ga:IntervalList"/>
    </xs:sequence>
  </xs:complexType>
  <xs:simpleType name="RecordTypeUsageType">
    <xs:restriction base="xs:string">
      <xs:enumeration value="U"/>
    </xs:restriction>
  </xs:simpleType>
  <xs:complexType name="IntervalList">
    <xs:sequence maxOccurs="unbounded">
      <xs:element name="Interval" type="ga:IntervalType"/>
    </xs:sequence>
  </xs:complexType>
  <xs:complexType name="IntervalType">
    <xs:sequence>
      <xs:element name="Value" type="xs:float"/>
      <xs:element name="Status" type="ga:NonEmptyString" minOccurs="0"/>
    </xs:sequence>
  </xs:complexType>
  <xs:complexType name="EventType">
    <xs:sequence>
      <xs:element name="RecordType" type="ga:RecordTypeEventType"/>
      <xs:element name="DateTime" type="xs:integer"/>
      <xs:element name="DeviceId" type="ga:NonEmptyString"/>
      <xs:element name="Name" type="ga:NonEmptyString"/>
    </xs:sequence>
  </xs:complexType>
</xs:schema>
```

```

</xs:sequence>
</xs:complexType>
<xs:simpleType name="RecordTypeEventType">
  <xs:restriction base="xs:string">
    <xs:enumeration value="E"/>
  </xs:restriction>
</xs:simpleType>
<xs:simpleType name="NonEmptyString">
  <xs:restriction base="xs:string">
    <xs:minLength value="1"/>
  </xs:restriction>
</xs:simpleType>
</xs:schema>

```

NOTE: Note: A part of incoming file that been used to generate current Plain XML structure will be placed into the Payload/RawData element.

Transformation

The transformer script performs the following mapping.

Plain XML to Seeder XML Mapping

The payload transformer creates the IMD or/and Device Event Seeder XML elements as following:

Usage Mapping: If name of Payload/* node is equal to 'Usage' (interval usage), the script creates an XML element with a name defined in the SGG Payload Processing Configuration field “IMD Seeder BO (Interval)” and the structure according to the following mapping table:

Plain XML Element	IMD Seeder Element	Notes
RecordType	N/A	
DeviceId	dvclIdN	
UOM	externalUOM	
IntervalDuration	spi	
StartDateTime	stDt	Convert to OUAF "dateTime" type
EndDateTime	enDt	Convert to OUAF "dateTime" type
Intervals/		
Interval/		
Value [Status]	msrs	Value
msrs/mL/q		
Status ->		
msrs/mL/sts/stsL/st		
N/A	imdType	Const value 'D1IL'
	externalId	Value stored in setOrigin method.
	serviceProviderExternalId	Value stored in setConfiguration method.
RawData	rawData	If the SGG Payload Processing Configuration has the Populate RAW checkbox checked.

Device Event Mapping: If name of Payload/* node is equal to 'Event' (device event data) create an XML element with a name defined in the SGG Payload Processing Configuration field “Device Event Seeder BO” and the structure according to the following mapping table:

Plain XML Element	Device Event Seeder Element	Note
RecordType	N/A	
DateTime	eventDateTime	Convert to OUAF "dateTime" type
DeviceId	externalUOM	
Name	externalEventName	
	externalSourceIdentifier	Value stored in setOrigin method.
	externalSenderId	Value stored in setConfiguration method.
RawData	rawEventInformation	If the SGG Payload Processing Configuration has the Populate RAW checkbox checked.

XML Format

This page describes the XML format sample implementation.

Sample File Format

The file format is described in the Online IMD Upload hint on the **Online IMD and Event Upload** screen. (Select **Menu**, select **Communication**, select **Load IMDs/Events (XML)**).

Sample File

```

<deviceList>
  <device>
    <headEnd>L&G</headEnd>
    <headEndExternalId>L+G</headEndExternalId>
    <deviceId></deviceId>
    <deviceIdentifierNumber>DEV-OUSGG-OSB-DEMO-001</deviceIdentifierNumber>
    <initialMeasurementDataList>
      <initialMeasurementData>
        <preVEE>
          <mcIdN></mcIdN>
          <uom>KWH</uom>
          <stDt>2010-05-19-00.00.00</stDt>
          <enDt>2010-05-19-00.30.00</enDt>
          <spi>900</spi>
          <msrs>
            <mL>
              <s>1</s>
              <q>0.2316</q>
            </mL>
            <mL>
              <s>2</s>
              <q>0.1416</q>
            </mL>
          </msrs>
        </preVEE>
      </initialMeasurementData>
      <initialMeasurementData>
        <initialMeasurementDataId>testValue</initialMeasurementDataId>
        <preVEE>
          <mcIdN></mcIdN>
          <uom>KWH2</uom>
          <stDt>2010-05-19-00.30.00</stDt>
          <enDt>2010-05-19-01.00.00</enDt>
          <spi>900</spi>
          <msrs>
            <mL>
              <s>1</s>
              <q>1.2316</q>
            </mL>
          </msrs>
        </preVEE>
      </initialMeasurementData>
    </initialMeasurementDataList>
  </device>
</deviceList>

```

```

        <mL>
          <s>2</s>
          <q>2.1416</q>
        </mL>
      </msrs>
    </preVEE>
  </initialMeasurementData>
</initialMeasurementDataList>
</device>
</deviceList>

```

Sample Scripts

The sample implementation includes the following sample scripts designed for use with the above XML format:

DG_SmplPrXML: This sample script includes one method in the Library Interface – `getParser()`. The method returns an instance of the class that implements the `com.splwg.dl.domain.sgg.dg.processing.PayloadParser` interface. The class contains the following logic:

1. Parses an incoming payload in XML format
2. Fetches information about current device
3. Breaks an incoming data into separate initial measurement data structures
4. Extends these structures with device information
5. Returns one by one these structures in the Plain XML format

DG_SmplTrXML: This sample script includes one method in the Library Interface – `getTransformer()`. The method returns an instance of class that implements the `com.splwg.dl.domain.sgg.dg.processing.PayloadTransformer` interface. The class contains the following logic:

1. Transforms incoming message in the Plain XML format into the IMD Seeder XML nodes
2. Adds new XML nodes as child nodes to the given Result List

Use the **Script** portal to view these scripts in more detail.

Parsing

The XML parser script maps data from the above XML format into the Plain XML format.

XML Schema of Plain XML Format

```

<xs:schema attributeFormDefault="unqualified"
elementFormDefault="qualified"
targetNamespace="http://xmlns.oracle.com/GenericAdapter"
xmlns:xs="http://www.w3.org/2001/XMLSchema"
xmlns:ga="http://xmlns.oracle.com/GenericAdapter">
  <xs:element name="Payload" type="ga:PayloadType"/>
  <xs:complexType name="PayloadType">
    <xs:sequence>
      <xs:choice>
        <xs:element name="Usage" type="ga:UsageType"/>
        <xs:element name="Event" type="ga:EventType"/>
      </xs:choice>
      <xs:element name="RawData" type="ga:NonEmptyString"/>
    </xs:sequence>
  </xs:complexType>
  <xs:complexType name="UsageType">
    <xs:sequence>
      <xs:element name="RecordType" type="ga:RecordTypeUsageType"/>
      <xs:element name="StartDateTime" type="xs:integer"/>
      <xs:element name="EndDateTime" type="xs:integer"/>
      <xs:element name="DeviceId" type="ga:NonEmptyString"/>
      <xs:element name="IntervalDuration" type="xs:integer"/>
    </xs:sequence>
  </xs:complexType>

```

```

    <xs:element name="UOM" type="ga:NonEmptyString"/>
    <xs:element name="Intervals" type="ga:IntervalList"/>
  </xs:sequence>
</xs:complexType>
<xs:simpleType name="RecordTypeUsageType">
  <xs:restriction base="xs:string">
    <xs:enumeration value="U"/>
  </xs:restriction>
</xs:simpleType>
<xs:complexType name="IntervalList">
  <xs:sequence maxOccurs="unbounded">
    <xs:element name="Interval" type="ga:IntervalType"/>
  </xs:sequence>
</xs:complexType>
<xs:complexType name="IntervalType">
  <xs:sequence>
    <xs:element name="Value" type="xs:float"/>
    <xs:element name="Status" type="ga:NonEmptyString" minOccurs="0"/>
  </xs:sequence>
</xs:complexType>
<xs:complexType name="EventType">
  <xs:sequence>
    <xs:element name="RecordType" type="ga:RecordTypeEventType"/>
    <xs:element name="DateTime" type="xs:integer"/>
    <xs:element name="DeviceId" type="ga:NonEmptyString"/>
    <xs:element name="Name" type="ga:NonEmptyString"/>
  </xs:sequence>
</xs:complexType>
<xs:simpleType name="RecordTypeEventType">
  <xs:restriction base="xs:string">
    <xs:enumeration value="E"/>
  </xs:restriction>
</xs:simpleType>
<xs:simpleType name="NonEmptyString">
  <xs:restriction base="xs:string">
    <xs:minLength value="1"/>
  </xs:restriction>
</xs:simpleType>
</xs:schema>

```

Transformation

The transformer script performs the following mapping.

Plain XML to Seeder XML Mapping

The payload transformer script does the following:

1. Creates an XML element with a name defined in the SGG Payload Processing Configuration field “IMD Seeder BO (Interval)” and copies all elements from the Plain XML as child nodes of new element.
2. Inserts the “externalId” element populated with value stored in `setOrigin` method.
3. Inserts the “serviceProviderExternalId” element populated with value stored in `setConfiguration` method.
4. If the SGG Payload Processing Configuration has the **Populate RAW** checkbox checked, inserts the “rawData” element populated with the textual XML representation of Plain XML element.

Adapter Development Kit Common Information Model (CIM) Payload Processing

This section describes how the Oracle Utilities Smart Grid Gateway Adapter Development Kit can be configured to process payload formats in the Common Information Model (CIM) format.

CIM Payload Processing Introduction and Overview

The Adapter Development Kit supports payload processing of data in the Common Information Model (CIM) format. The CIM formats and standards supported by the Adapter Development Kit are based on the *International Standard* (IEC 61968-9, Edition 2.0), available [here](#). Reference to specific data elements from the CIM usage and event payload formats used in this section are based on this document. Refer to this document for detailed information about the CIM standard and payload formats.

Usage payloads are processed in the same manner as other formats and other adapters. Payload files are sent from a head end system to a file system (for on-premises implementations) or an Oracle Cloud Object Storage location (for cloud services), where they are processed via batch processes. See [Payload Processing](#) for more information about this process and the related configuration. Events can also be processed in this manner.

Event payload can also be processed through an Inbound Web Service, which sends the payload to a file location where it is processed via batch processing. See [Event Processing Inbound Web Service](#) for more information. This approach is most often used when receiving real-time events from a head end system.

This section outlines the specific configuration necessary to process CIM-based payloads.

Creating CIM Payload Processing Extendable Lookup Values

Payload processing of CIM usage and events requires configuration of values for the SGG Payload Processing Configuration extendable lookup. This section outlines the specific configuration for usage and event payload processing extendable lookups for CIM usage and events. See [Creating SGG Payload Processing Extendable Lookup Values](#) for more information about this extendable lookup including parameters not listed in this section.

Usage

Extendable lookup values for CIM usage payload processing should include the following parameters:

- **Payload Handler Class Name:** com.splwg.d1.domain.sgg.dg.processing.PayloadHandlerViaUserExits
- **Payload Processing Result Type:** Initial Measurements
- **IMD Seeder BO (Interval):** IMD Seeder (D1-IMDSeeder) (Applicable only If processing interval usage)
- **IMD Seeder BO (Scalar):** IMD Seeder (D1-IMDSeeder) (Applicable only If processing scalar usage)
- **Dynamic Parameters:** As appropriate for your implementation
- **User Exit Interceptors:**

Payload Processing User Exit Type	Groovy Library Script	Groovy Library Method
On Get Parser	DG_CimUPrXML (SGG ADK Generic CIM XML Parser)	getParser
On Get Transformer	DG_CimUTrXML (SGG ADK Generic CIM XML Transformer)	get Transformer

Device Events

Extendable lookup values for CIM event payload processing should include the following parameters:

- **Payload Handler Class Name:** com.splwg.d1.domain.sgg.dg.processing.PayloadHandlerViaUserExits
- **Payload Processing Result Type:** Device Events
- **Device Event Seeder BO:** Device Event Seeder (D1-DeviceEventSeeder)
- **Dynamic Parameters:** As appropriate for your implementation

- **User Exit Interceptors:**

Payload Processing User Exit Type	Groovy Library Script	Groovy Library Method
On Get Parser	DG_CimEvtPr (CIM Events Parser using XMLReader)	getParser
On Get Transformer	DG_CimEvtTr (CIM Events Transformer)	get Transformer

CIM Event Processing Inbound Web Service

Event processing can be handled via the EventMessage operation of the ADK CIM Events and Alarms (DG-CIMEvents) SOAP-based inbound web service. This approach is most often used when a head end system sends real-time events to Smart Grid Gateway.

When invoking this webservice, the event payload should be included in the web service call. Refer to the International Standard document for detailed information about the event data to be included in the web service call.

The ADK CIM Events and Alarms (DG-CIMEvents) service sends the payload to a file location where it is processed via batch processing.

The file location is defined in the **Arrived Data Save Locations** section of the ADK - Master Configuration, which includes the following parameters:

- **File Storage:** A File Storage Configuration (F1-FileStorage) extendable lookup value that defines the staging area to which the payloads will be saved. See **Creating File Storage Extendable Lookup Values** (LINK) for more information.
- **Output Bucket/Folder Name:** The bucket name (if saving to Oracle Object Storage), or a directory below the specified file storage location (if saving to a local file system).
- **Filename Generation Script:** The name of a service script used to compose the filename when saving the incoming payload. The Default Filename Generator (D1DEFFNGEN) script is used by default if not specified.
- **XSL Transformer Template:** The name of an XSL used to create the event payload from the incoming inbound message data. Select the "ADK - CIM EndDeviceEvents Output" (DG-CIMEndDvcEvtsOutput.xsl) XSL.
- **File Extension:** An extension used for the name of the outputted file. It can be specified with or without a leading dot (ex: ".txt" or "xml").

CIM Payload Processing Data Mapping and Extendable Lookups

Unit of Measure Mapping

Unit of measure mapping is based on the ReadingType string in the CIM payload and uses the ADK - UOM Code to Standard UOM Mapping (DG-HeadendUOMLookup) extendable lookup. Refer to the [International Standard document](#) for detailed information about the ReadingType data element.

For example, a payload with a ReadingType string of "0.0.2.4.1.1.12.0.0.0.0.0.0.0.0.3.72.0" could be mapped to the "Kilowatt Hour" unit of measure as follows:

- **Head-End Unit of Measure:** 0.0.2.4.1.1.12.0.0.0.0.0.0.0.0.3.72.0
- **Unit of Measure:** Kilowatt Hour

Interval Size Mapping

Interval size (expressed as seconds per interval or SPI) mapping is based on the measuringPeriod value extracted from the ReadingType string and uses the ADK CIM Measuring Period Lookup (DG-CIMMeasuringPeriodLookup) extendable

lookup. The measuringPeriod is the third element in the ReadingType string. Refer to the [International Standard document](#) for detailed information about the measuringPeriod and ReadingType elements.

For example, the measuringPeriod in a payload with a ReadingType string of "0.0.2.4.1.1.12.0.0.0.0.0.0.0.0.3.72.0" is "2" (the third value in the string). This could be mapped to an SPI of 900 (15 minutes) as follows:

- **Measuring Period:** 2
- **Interval Size:** 00:15:00

Condition Code Mapping

Condition code mapping is based on the ReadingQualityType string in the CIM payload (if present) and uses the the ADK - Interval Sts Code to Cond Map (DG-IntStsCodeToCondMapLookup) extendable lookup. Refer to the [International Standard document](#) for detailed information about the ReadingQualityType data element.

For example, a payload with a ReadingQualityType string of "3.8.8" could be mapped to the "System Estimate" condition code as follows:

- **Interval Status:** 3.8.8
- **Condition:** System Estimate

Event Type Mapping

Event type mapping is based on the EndDeviceEventType string in the CIM payload and uses the the ADK - Device Event Mapping (DG-DeviceEventMappingLookup) extendable lookup. Refer to the [International Standard document](#) for detailed information about the EndDeviceEventType data element.

For example, a payload with a EndDeviceEventType string of "3.12.0.257" could be mapped to the "Tamper Detected" standard event name as follows:

- **Head-End System Event Name:** 3.12.0.257
- **Standard Event Name:** Tamper Detected

CIM Payload Processing Sample Payloads

This section provides sample CIM usage and event payloads. Refer to the [International Standard document](#) for detailed information about the data elements in these examples.

Usage

The following example represents a meter reading containing four KWH interval values and four KW scalar readings.

```
<mr:MeterReadings
xmlns:mr="http://iec.ch/TC57/2011/MeterReadings#">
  <mr:MeterReading>
    <mr:Meter>
      <mr:Names>
        <mr:name>GDDGCIM_INT_CLOUD_TESTHARNESS_01</mr:name>
        <mr:NameType>
          <mr:description>This is an endpoint serial number</mr:description>
          <mr:name>meterID</mr:name>
          <mr:NameTypeAuthority>
            <mr:description>AssetManagementSystem</mr:description>
            <mr:name>com.company.assets</mr:name>
          </mr:NameTypeAuthority>
        </mr:NameType>
      </mr:Names>
    </mr:Meter>
    <mr:IntervalBlocks>
      <mr:IntervalReadings>
        <mr:reportedDateTime>2022-02-04T00:00:00Z</mr:reportedDateTime>
        <mr:timeStamp>2022-02-03T09:30:47Z</mr:timeStamp>
        <mr:value>25.44</mr:value>
```



```

        <mr:timePeriod>
            <mr:end>2022-02-03T00:15:00Z</mr:end>
            <mr:start>2022-02-03T00:00:00Z</mr:start>
        </mr:timePeriod>
    </mr:IntervalReadings>
    <mr:IntervalReadings>
        <mr:reportedDateTime>2022-02-04T00:00:00Z</mr:reportedDateTime>
        <mr:timeStamp>2022-02-03T10:00:47Z</mr:timeStamp>
        <mr:value>26.44</mr:value>
        <mr:timePeriod>
            <mr:end>2022-02-03T00:30:00Z</mr:end>
            <mr:start>2022-02-03T00:15:00Z</mr:start>
        </mr:timePeriod>
    </mr:IntervalReadings>
    <mr:IntervalReadings>
        <mr:reportedDateTime>2022-02-04T00:00:00Z</mr:reportedDateTime>
        <mr:timeStamp>2022-02-03T10:30:47Z</mr:timeStamp>
        <mr:value>27.44</mr:value>
        <mr:timePeriod>
            <mr:end>2022-02-03T00:45:00Z</mr:end>
            <mr:start>2022-02-03T00:30:00Z</mr:start>
        </mr:timePeriod>
    </mr:IntervalReadings>
    <mr:IntervalReadings>
        <mr:reportedDateTime>2022-02-04T00:00:00Z</mr:reportedDateTime>
        <mr:timeStamp>2022-02-03T10:30:47Z</mr:timeStamp>
        <mr:value>28.44</mr:value>
        <mr:timePeriod>
            <mr:end>2022-02-03T01:00:00Z</mr:end>
            <mr:start>2022-02-03T00:45:00Z</mr:start>
        </mr:timePeriod>
    </mr:IntervalReadings>
    <mr:ReadingType ref="0.0.2.4.1.1.12.0.0.0.0.0.0.0.0.3.72.0"/>
</mr:IntervalBlocks>
<mr:Readings>
    <mr:timeStamp>2022-02-03T00:15:00Z</mr:timeStamp>
    <mr:value>9.0</mr:value>
    <mr:ReadingType ref="0.0.0.12.1.1.37.0.0.0.0.0.0.0.0.3.38.0"/>
</mr:Readings>
<mr:Readings>
    <mr:timeStamp>2022-02-03T00:30:00Z</mr:timeStamp>
    <mr:value>10.0</mr:value>
    <mr:ReadingType ref="0.0.0.12.1.1.37.0.0.0.0.0.0.0.0.3.38.0"/>
</mr:Readings>
<mr:Readings>
    <mr:timeStamp>2022-02-03T00:45:00Z</mr:timeStamp>
    <mr:value>11.0</mr:value>
    <mr:ReadingType ref="0.0.0.12.1.1.37.0.0.0.0.0.0.0.0.3.38.0"/>
</mr:Readings>
<mr:Readings>
    <mr:timeStamp>2022-02-03T01:00:00Z</mr:timeStamp>
    <mr:value>12.0</mr:value>
    <mr:ReadingType ref="0.0.0.12.1.1.37.0.0.0.0.0.0.0.0.3.38.0"/>
</mr:Readings>
<mr:valuesInterval>
    <mr:end>2022-02-03T01:00:00Z</mr:end>
    <mr:start>2022-02-03T00:00:00Z</mr:start>
</mr:valuesInterval>
</mr:MeterReading>
</mr:MeterReadings>

```

Events

The following sample represents a single "tamper" device event. Note that this sample is the event data ONLY. This is NOT an example of the data sent to the ADK CIM Events and Alarms inbound web service.

```

<end:EndDeviceEvents
xmlns:end="http://iec.ch/TC57/2011/EndDeviceEvents#"
xmlns:xsi="http://www.w3.org/2001/XMLSchema-instance">
    <end:EndDeviceEvent>
        <end:createdDateTime>2022-02-10T21:54:53.404+01:00</end:createdDateTime>
        <end:issuerID>External System 1</end:issuerID>
    </end:EndDeviceEvent>
</end:EndDeviceEvents>

```

```

</end:issuerTrackingID>123</end:issuerTrackingID>
</end:severity>5</end:severity>
</end:Assets>
  <end:mRID>01f8b2e5-a677-4f2c-a6c0-1e79b409c55e</end:mRID>
  <end:Names>
    <end:name>METERID</end:name>
    <end:NameType>
      <end:name>meterID</end:name>
      <end:NameTypeAuthority>
        <end:name>Utility ABC</end:name>
      </end:NameTypeAuthority>
    </end:NameType>
  </end:Names>
</end:Assets>
<end:EndDeviceEventType ref="3.12.0.257" />
</end:EndDeviceEvent>
</end:EndDeviceEvents>

```

Smart Meter Commands

This section provides information about implementing smart meter commands with native implementations and Oracle Utilities cloud services, including Oracle Utilities Meter Solution Cloud Service.

Device Communication Overview

The basic communication for all business processing is essentially the same. A communication request is sent from the Oracle Utilities application to the head-end system. This request would be for a connect/disconnect, commission/decommission, measurement data, an on-demand read, or another type of request that the head-end system supports. The head-end system receives the message, acts on the request, and returns a reply.

See [Communications](#) in the *Business User Guide*, and [About Communications](#) in the *Administrative User Guide* for basic information about command activities and communications.

Native Implementation Command Processing

When using native implementation of Smart Grid Gateway adapters, including with Oracle Utilities cloud services, command processing works slightly differently than it does in middleware (on-premises) implementations.

The table below provides a brief description of the communication process, and lists example objects used by the Oracle Utilities Smart Grid Gateway Adapter for Itron OpenWay. Note that the process outlined below has been simplified for illustrative purposes, and does not reference every step performed in this process.

Step	Process	Example Data
1.	A user initiates a remote connect command for a device. A remote connect activity business object is instantiated for the command.	Activity Business Object: Remote Connect (D1-RemoteConnect)
2.	The remote connect command activity business object creates an outbound communication. The specific type of outbound communication business object created is determined by the head end system (based on the processing role defined in an Enter algorithm of the "Connection Ready" status of the command activity business object's lifecycle).	Outbound Communication Business Object: Itron - Reconnect Meter (Remote Connect) (D8-ReconnectMeterDR)
3.	The outbound communication creates an outbound message. The specific type of outbound message created is determined by the head end system (based on the processing role defined in an Enter algorithm of the "Awaiting	Outbound Message Type Business Object: Outbound Message for Itron connect command (D8-ItronRemoteConnectOutbndMsg)

Step	Process	Example Data
	Response" status of the outbound communication business object's lifecycle).	
4.	<p>The outbound message is sent to the head end system via an External System, Message Sender, and Outbound Message Type.</p> <p>The head end system sends a synchronous response to acknowledge receipt of the request.</p>	<p>External System: Itron OpenWayHead End System</p> <p>Message Sender: Itron – Remote Connect (D8-Reconnect)</p> <p>Outbound Message Type: Itron – Remote Connect (D8-RemoteConnect)</p>
5.	<p>As the status of the command request is updated, the head end system sends periodic messages.</p> <p>These messages are received by an Inbound Web Service which creates instances of an inbound communication business object.</p> <p>The specific type of inbound communication business object created is determined by the Inbound Web Service.</p>	Inbound Communication Business Object: Itron – StatusChanged (D8-StatusChanged)
6.	<p>When the command request has been completed, it sends a status changed inbound communication with a "Completed" status.</p> <p>This transitions the outbound communication business object to its "Completed" state.</p>	Inbound Communication Business Object: Itron – StatusChanged (D8-StatusChanged)
7.	<p>The remote connect command activity business object creates a "results" outbound communication.</p> <p>The specific type of outbound communication business object created is determined by the head end system (based on the processing role defined in an Enter algorithm of the "Connection Ready" status of the command activity business object's lifecycle).</p>	<p>Outbound Communication Business Object: Itron - Reconnect Meter Results</p> <p>(D8-ReconnectMeterResultDR)</p>
8.	<p>The outbound communication creates an outbound message.</p> <p>The specific type of outbound message created is determined by the head end system (based on the processing role defined in an Enter algorithm of the "Awaiting Response" status of the outbound communication business object's lifecycle).</p>	<p>Outbound Message Type Business Object: Outbound Message for Itron connect result command</p> <p>(D8-ItronRemoteCntRsltOutMsg)</p>
9.	An Enter Algorithm on the "Evaluate Response" status of the outbound message business object's lifecycle evaluates the response.	Enter Algorithm: Evaluate Get Reconnect Results Response (D8-EVGRCMRST)
10.	<p>The "result" outbound communication creates a completion event to update the status of the device to indicate it has been connected.</p> <p>The specific type of completion event business object created is specified in an Enter algorithm on the "Create Completion Event" Status of the outbound communication business object's lifecycle.</p>	<p>Algorithm: Create Connect Completion Event from Result (D8-CRCNCER)</p> <p>Completion Event Business Object: Connect Device (D1-ConnectDevice)</p>
11.	The outbound communication updates the "Connect/ Disconnect Completion Flag" and the original activity business object.	

Step	Process	Example Data
	This update is performed by an Enter algorithm on the "Completed" Status of the outbound communication business object's lifecycle.	

In the case of commands that also request usage readings, such as On Demand Read or Scheduled Read, usage readings are sent separately via DataArrived messages separately to the DataSubscriberService Inbound Web Service, where they can be routed to Object storage for payload processing.

Smart Meter Command Flows

This section provides information about the smart meter command flows used by supported Smart Grid Gateway adapters.

Itron OpenWay Command Flows

The table below lists the communication flows used with each Itron OpenWay command, including:

- **Command:** The specific smart meter command
- **Outbound Communication:** The outbound communication business object created by the command. This sends the command request to the head end system.
 - **Result Outbound Communication** The outbound communication business object used to request the result of a command request
- **Inbound Communication:** The inbound communication created by the response from the head end system
- **Completion Event:** The completion event(s) triggered by the command, if any. Completion events are used to update data in the system as a result of a smart meter command. For example, if a command changes the status of a device, the completion event is responsible for making that change.

Command	Outbound Communication	Inbound Communication	Completion Event
Device Commissioning	Itron - Add Meter Definition (Commission) (D8-AddMeterDefinitionsDR)		Device Commissioning Completion Event
Device Decommissioning	Itron - Deregister Meter (Decommission) (D8-DeregisterMeterDR)		Device Decommissioning Completion Event
Remote Connect	Itron - Reconnect Meter (Remote Connect) (D8-ReconnectMeterDR)	Itron - StatusChanged (D8-StatusChanged)	Connect Device Completion Event
	Result: Itron - Reconnect Meter Result (D8-ReconnectMeterResultDR)		
Remote Disconnect	Itron - Meter Remote Disconnect (D8-DisconnectMeterDR)	Itron - StatusChanged (D8-StatusChanged)	Disconnect Device Completion Event
	Result: Itron - Disconnect Meter Result (D8-DisconnectMeterResultDR)		
On-Demand Read (Scalar)	Itron - Contingency Read (Scalar) (D8-ReadScalarDR)	Itron - StatusChanged (D8-StatusChanged)	Create IMD Completion Event
	Result: Itron - On Demand Read Result (D8-ReadOnDemandReadResultDR)		
On-Demand Read (Interval)	Itron - Contingency Read (Interval) (D8-ReadIntervalDR)	Itron - StatusChanged (D8-StatusChanged)	Create IMD Completion Event
	Result: Itron - On Demand Read Result (D8-ReadOnDemandReadResultDR)		
Scheduled Read (Scalar)	Itron - Interrogate By Group	Itron - StatusChanged	Create IMD Completion Event

Command	Outbound Communication	Inbound Communication	Completion Event
	(D8-InterrogateByGroupDR)	(D8-StatusChanged)	
	Result: Itron - Interrogate by Group Results (D8- InterrogateByGroupResultDR)		
Scheduled Read (Interval)	Itron - Interrogate By Group (D8-InterrogateByGroupDR)	Itron - StatusChanged (D8-StatusChanged)	Create IMD Completion Event
	Result: Itron - Interrogate by Group Results (D8- InterrogateByGroupResultDR)		
Device Status Check	Itron - Ping By Endpoints (Status Check) (D8-PingByEndpointsDR)	Itron - StatusChanged (D8-StatusChanged)	
	Result: Itron - Ping By Endpoints Result (D8- PingByEndpointsResultDR)		
Multi-Device Status Check	Itron – Ping By Endpoints Multi-Device (D8-PingByEndpointsMultiDvcDR)	Itron – StatusChanged (D8-StatusChanged)	
	Result: Itron – Ping By Endpoints Multi Dvc Result (D8- PingByEndpointsMDRResultDR)		
Load Check	Itron – Detect Load Side Voltage (D8-DetectLoadSideVoltageByMtrDR)	Itron – StatusChanged (D8-StatusChanged)	
	Result: Itron – Detect Load Side Voltage Result (D8- DetLoadSideVoltageMtrRsltDR)		
Read Disconnect State	Itron - Read Disconnect State (D8-ReadDisconStateByMtrDR)	Itron – StatusChanged (D8-StatusChanged)	
	Result: Itron - ReadDisconnectStateByMeter Result (D8-ReadDisconStByMtrResultDR)		

Landis+Gyr Command Flows

The table below lists the communication flows used with each Landis+Gyr command, including:

- **Command:** The specific smart meter command
- **Outbound Communication:** The outbound communication business object created by the command. This sends the command request to the head end system.
- **Inbound Communication:** The inbound communication created by the response from the head end system
- **Completion Event:** The completion event(s) triggered by the command, if any. Completion events are used to update data in the system as a result of a smart meter command. For example, if a command changes the status of a device, the completion event is responsible for making that change.

Command	Outbound Communication	Inbound Communication	Completion Event
Device Commissioning	L+G Add Meter to Inventory(MultiSpeak) (D3-AddMeterToInventoryMultiSpDR)		Device Commissioning Completion Event
Device Decommissioning	L+G Meter Remove Notification (MultiSpeak) (D3-MtrRmvNotifMultiSpeakDR)		Device Decommissioning Completion Event
Meter Retire	L+G Meter Retire Notification (D3-MeterRetireNotificationDR)		
Meter Exchange	L+G Meter Exchange Notification (D3-MeterExNotificatnMultiSpDR)		
Remote Connect	L+G Initiate Connect Disconnect DR (D3-InitiateConnectDisconnectDR)	Con/Discon State Change Notif-Direct Route (D3-ConnectDisconStateChgNtfDR)	Connect Device Completion Event

Command	Outbound Communication	Inbound Communication	Completion Event
Remote Disconnect	L+G Initiate Connect Disconnect DR (D3-InitiateConnectDisconnectDR)	Con/Discon State Change Notif-Direct Route (D3-ConnectDisconStateChgNtfDR)	Disconnect Device Completion Event
Demand Reset	L+G Schedule Demand Reset (Multispeak) (D3-ScheduleDemandResetDR)	Reading Changed Notification Direct Route (D3-ReadingChgNotificationDR)	
On-Demand Read (MultiSpeak)	L+G MultiSpeak Initiate Meter Read By Meter Num Direct Route (D3-InitiateMRByMtrNbrDR)	Reading Changed Notification Direct Route (D3-ReadingChgNotificationDR)	Create IMD Completion Event
On-Demand Read (Interval) [CIM]	CIM Meter On Demand Read Direct Route (Interval) (D3-CIMGetLPDataDR)	CIM AsyncReply MeterReads Direct Route (D3-CIMAsyncReplyMeterReadingDR)	Create IMD Completion Event
On-Demand Read (Scalar) [CIM]	CIM Meter On Demand Read Direct Route (Scalar) (D3-CIMMeterOnDemandReadDR)	CIM AsyncReply MeterReads Direct Route (D3-CIMAsyncReplyMeterReadingDR)	Create IMD Completion Event
Device Status Check	CIM Ping Direct Route (D3-CIMPingDR)	CIM AsyncReply MeterReads Direct Route (D3-CIMAsyncReplyMeterReadingDR)	

Unit of Measure Filtering for On-Demand Reads

Readings returned via On-Demand Read commands are filtered on the combination of Unit of Measure/Time of Use/Service Quantity Identifiers (UOM/TOU/SQI) configured for the device and measuring component. When filtering is enabled, only readings that match a configured UOM/TOU/SQI combination are processed. All others are filtered out.

Filtering is enabled by default via the “Opt Out Of Filtering” parameter (set to "false" by default) on the D3-CRRCCEDR (Create IMD Completion Event -Direct Route) algorithm on the Create Completion Events status of the D3-ReadingChgNotificationDR (L+G Reading Changed Notification Direct Route) business object.

The D3-VALDVCFDR (Check if Device has any Filtering errors Direct Route) algorithm on the Validate status of the D3-ReadingChgNotificationDR business object is used to check for errors related to filtering. The value of the “Opt Out Of Filtering” parameter on this algorithm must match the value of the same parameter on the D3-CRRCCEDR algorithm. The “Opt Out Of Filtering” parameter should both be set to either "false" (the default) or "true" (if filtering is to be disabled).

CIM Commands

For CIM-based on-demand read commands, filtering is enabled by default via the “Opt Out Of Filtering” parameter (set to "false" by default) on the D3-CRCIMCE (Create CIM Completion Event Direct Route) algorithm on the Create Completion Events status of the D3-CIMAsyncReplyMeterReadingDR (CIM AsyncReply MeterReads Direct Route) business object.

The D3-VALCCIMCE (Check if Device has Filtering errors CIM Completion Event Direct Route) algorithm on the Validate status of the D3-CIMAsyncReplyMeterReadingDR (CIM AsyncReply MeterReads Direct Route) business object is used to check for errors related to filtering. The value of the “Opt Out Of Filtering” parameter on this algorithm must match the value of the parameter on the D3-CRCIMCE algorithm. The parameters should both be set to either "false" (the default) or "true" (if filtering is to be disabled).

Sensus Command Flows

The table below lists the communication flows used with each Sensus command, including:

- **Command:** The specific smart meter command
- **Outbound Communication:** The outbound communication business object created by the command. This sends the command request to the head end system.
- **Inbound Communication:** The inbound communication created by the response from the head end system
- **Completion Event:** The completion event(s) triggered by the command, if any. Completion events are used to update data in the system as a result of a smart meter command. For example, if a command changes the status of a device, the completion event is responsible for making that change.

Command	Outbound Communication	Inbound Communication	Completion Event
Device Commissioning	Sensus -Meter Add Notification Direct Route (D6-MeterAddNotificationDR)		Device Commissioning Completion Event
Device Decommissioning	Sensus -Meter Remove Notification Direct Route (D6-MeterRemoveNotificationDR)		Device Decommissioning Completion Event
Remote Connect	Sensus - Initiate Conn Discon - DR (D6-InitiateConnectDisconnectDR)	Sensus Conn/Discon State Chg Direct Route (D6-ConnectDisconStateChgNtfDR)	Connect Device Completion Event
Remote Disconnect	Sensus - Initiate Conn Discon - DR (D6-InitiateConnectDisconnectDR)	Sensus Conn/Discon State Chg Direct Route (D6-ConnectDisconStateChgNtfDR)	Disconnect Device Completion Event
On-Demand Read (MultiSpeak)	Sensus - Initiate Meter Read By Meter ID (D6-InitiateMeterByMeterIdDR)	Sensus - Reading Changed Notification (D6-ReadingChgNotificationDR)	Create IMD Completion Event
Device Status Check	Sensus Initiate Outage Detection DR (D6-InitiateOutageDetectionDR)	Sensus Outage Detect Event Notif Direct Route (D6-ODEventNotificationDR)	

Unit of Measure Filtering for On-Demand Reads

Readings returned via On-Demand Read commands are filtered on the combination of Unit of Measure/Time of Use/Service Quantity Identifiers (UOM/TOU/SQI) configured for the device and measuring component. When filtering is enabled, only readings that match a configured UOM/TOU/SQI combination are processed. All others are filtered out.

Filtering is enabled by default via the “Opt Out Of Filtering” parameter (set to "false" by default) on the D6-CCOMPEVDR (Create IMD Completion Event Direct Route) algorithm on the Create Completion Events status of the D6-ReadingChgNotificationDR (Sensus - Reading Changed Notification DR) business object.

The D6-VALDVCFDR (Check if Device has any Filtering errors Direct Route) algorithm on the Validate status of the D6-ReadingChgNotificationDR business object is used to check for errors related to filtering. The value of the “Opt Out Of Filtering” and "Xpath to External UOM" parameters on this algorithm must match the values of the same parameters on the D6-CCOMPEVDR algorithm. The “Opt Out Of Filtering” parameters should both be set to either "false" (the default) or "true" (if filtering is to be disabled).

Silver Spring Networks Command Flows

The table below lists the communication flows used with each Silver Spring Networks command, including:

- **Command:** The specific smart meter command
- **Outbound Communication:** The outbound communication business object created by the command. This sends the command request to the head end system.
 - **Get Status Outbound Communication:** The outbound communication business object used to request the status of a command request
 - **Result Outbound Communication:** The outbound communication business object used to request the result of a command request
- **Outbound Messages:** The outbound message business objects for one or more outbound messages created by the outbound communication. These should be configured on the Silver Spring Networks external system.
- **Completion Event:** The completion event(s) triggered by the command, if any. Completion events are used to update data in the system as a result of a smart meter command. For example, if a command changes the status of a device, the completion event is responsible for making that change.

Command	Outbound Communication	Outbound Messages	Completion Event
Device Commissioning (see Note below)	SSN - Replace Location (D7-ReplaceLocationDR)	Find Device:	Device Commissioning Completion Event

Command	Outbound Communication	Outbound Messages	Completion Event
		SSN - Find Device Outbound Message (D7-FindDeviceOutboundMsg) Replace Location: SSN - Replace Location (Comm) OB Message (D7-ReplaceLocationOBMsg)	
Device Decommissioning	SSN - Replace Device At Location (Decomm) (D7-RepDeviceAtLocForDecommDRP)	Find Device: SSN - Find Device Outbound Message (D7-FindDeviceOutboundMsg) Replace Device at Location: SSN - Replace Device At Loc O/B Message: (D7-ReplaceDeviceAtLocOBMsg)	Device Decommissioning Completion Event
Remote Connect	SSN - Add Remote Provisioning Job - Polling (D7-AddRemoteProvJobDRP)	Find Device: SSN - Find Device Outbound Message (D7-FindDeviceOutboundMsg) Connect Disconnect: SSN - Connect Disconnect OB Message (D7-ConnectDisconnectOBMsg)	Connect Device Completion Event
	Get Status: SSN - Get Job Status for Polling (D7-GetJobStatusDRP)	SSN - Get Job Status Outbound Message (D7-GetJobStatusOutboundMsg)	
	Result: SSN - Connect Disconnect Results (D7-ConnectDisconnectResultDR)	SSN - GetConnectDisconnectResult OB Message (D7-GetCntDiscntResultOBMsg)	
Remote Disconnect	SSN - Add Remote Provisioning Job - Polling (D7-AddRemoteProvJobDRP)	Find Device: SSN - Find Device Outbound Message (D7-FindDeviceOutboundMsg) Connect Disconnect: SSN - Connect Disconnect OB Message (D7-ConnectDisconnectOBMsg)	Disconnect Device Completion Event
	Get Status: SSN - Get Job Status for Polling (D7-GetJobStatusDRP)	SSN - Get Job Status Outbound Message (D7-GetJobStatusOutboundMsg)	
	Result: SSN - Connect Disconnect Results (D7-ConnectDisconnectResultDR)	SSN - GetConnectDisconnectResult OB Message (D7-GetCntDiscntResultOBMsg)	
On-Demand Read (Scalar)	SSN - Add Mtr Read Job (Scalar) - Polling (D7-AddMeterReadJobScalarDRP)	Find Device: SSN - Find Device Outbound Message (D7-FindDeviceOutboundMsg) Add Meter Read Job Scalar: SSN - Add Meter Read Job Scalar OB Msg Type (D7-AddMeterReadJobScalarOBMsg)	Create IMD Completion Event
	Get Status: SSN - Get Job Status for Polling (D7-GetJobStatusDRP)	SSN - Get Job Status Outbound Message (D7-GetJobStatusOutboundMsg)	
	Result: SSN - Meter Read Results (Scalar) (D7-MeterReadResultsScalar)	SSN - GetMeterReadResults(Scalar) By JobId (D7-GetSclrMtrRdRstByJobIdOBMsg)	
On-Demand Read (Interval)	SSN - Add Mtr Read Job (Interval) - Polling (D7-AddMeterReadJobIntervalDRP)	Find Device: SSN - Find Device Outbound Message (D7-FindDeviceOutboundMsg) Add Meter Read Job Interval: SSN - AddMeterReadJob Interval OB Msg Type (D7-AddMeterReadJobIntervalOBMsg)	Create IMD Completion Event
	Get Status: SSN - Get Job Status for Polling (D7-GetJobStatusDRP)	SSN - Get Job Status Outbound Message (D7-GetJobStatusOutboundMsg)	
	Result: SSN - Meter Read Results (Interval) (D7-MeterReadResultsInterval)	SSN - GetMeterReadResults(Interval) By JobId (D7-GetIntMtrRdRsltByJobIdOBMsg)	
Device Status Check	SSN - Add Ping Job - Polling (D7-AddPingJobDRP)	Find Device:	

Command	Outbound Communication	Outbound Messages	Completion Event
		SSN - Find Device Outbound Message (D7-FindDeviceOutboundMsg) Add Ping Job: SSN - Add Ping Job OB Message (D7-AddPingJobOBMsg)	
	Get Status: SSN - Get Job Status for Polling (D7-GetJobStatusDRP)	SSN - Get Job Status Outbound Message (D7-GetJobStatusOutboundMsg)	
	Result: SSN - Ping Results (D7-PingResultsDR)	SSN - Get Ping Results O/B Message (D7-GetPingResultsOBMsg)	

NOTE: Service points must be provisioned in the Silver Spring Networks (Itron AMM) system before the Device Commissioning command can be used.

Configuring Communication Types for Job Status Polling

The following outbound communication business objects (from the table above) all have corresponding communication types that must be configured before outbound communications based on those business objects can be created. The table below lists the communication type business objects used with each.

Outbound Communication Business Object	Communication Type Business Object
SSN - Add Remote Provisioning Job - Polling (D7-AddRemoteProvJobDRP)	SSN - Add Remote Prov Job Polling DR Type (D7-AddRemoteProvDRPType)
SSN - Add Mtr Read Job (Scalar) - Polling (D7-AddMeterReadJobScalarDRP)	SSN - Add Meter Read Job (Scalar) Polling DR Type (D7-AddMeterReadJobScalrDRPType)
SSN - Add Mtr Read Job (Interval) - Polling (D7-AddMeterReadJobIntervalDRP)	SSN - Add Meter Read Job (Interval) Polling DR Type (D7-AddMeterReadJobIntDRPType)
SSN - Add Ping Job - Polling (D7-AddPingJobDRP)	SSN - Add Ping Job Polling DR Type (D7-AddPingJobDRPType)
Get Job Status for Polling (D7-GetJobStatusDRP)	SSN - Get Job Status Polling DR Type (D7-GetJobStatusDRPType)

Refer to [Communication Types](#) for more information about communication types.

Get Job Status Polling Parameters and Polling Modes

The **Get Job Status Polling** parameters on these communication types are used to define how polling works with outbound communications of the corresponding type. These include **Retry Frequency** parameters (the minimum amount of time (expressed as hours:minutes:seconds) the system will wait between polling iterations for jobs created by communications of this type) and **Maximum Retries** parameters (the maximum number of times the system will try to poll for the status of jobs created by communications of this type), which must be configured in order to use these outbound communications.

There are two modes of polling:

- **Initial** polling occurs immediately and within the same transaction as any previous portion of the command. This setting is useful when the head end is expected to quickly complete the job (within a few seconds). To use Initial polling, define values for the **Initial Polling Retry Frequency** and **Initial Polling Maximum Retries** parameters.
- **Out of Process** polling occurs within its own transaction triggered either separately by a user or by a batch process. This mode is useful when the head end system is likely to take more than a few seconds to complete the job. The **Polling Retry Frequency** and **Polling Maximum Retries** parameters are used with Out of Process polling. If these parameters are not configured on the communication type, the values defined in the **SSN - Get Job Status Configuration** section of the Silver Spring Networks Version Master Configuration are used in their place.

Refer to the **Get Job Status Polling** embedded help on the above communication types for more information about polling modes and parameters.

Polling and Batch Processing

When a communication enters the "Polling Ready" state, it polls the head end system via a Get Status Outbound Communication. If the initial polling parameters have been exceeded (or the initial polling parameters were not defined), the communication transitions to the "Polling in Progress" state. Communications in this state can be transitioned using the Outbound Communication Polling - Monitor (D7-OCPL) batch process (or the **Poll Job Status** button in the **Outbound Communication** zone in the **Communication** portal.)

If using the Outbound Communication Polling - Monitor (D7-OCPL) batch process, the system should be configured to run the process frequently (every few minutes).

Polling and the creation of Get Job Status outbound communications requires the following "Get Job Status" processing method be defined for the Silver Spring Networks head end system:

- **Processing Role:** Get Job Status
- **Default Business Object:** SSN - Get Job Status for Polling (D7-GetJobStatusDRP)

See [Silver Spring Networks Processing Methods](#) for more information about processing methods used with Silver Spring Networks.

Unit of Measure Filtering for On-Demand Reads

Readings returned via On-Demand Read commands are filtered on the combination of Unit of Measure/Time of Use/Service Quantity Identifiers (UOM/TOU/SQI) configured for the device and measuring component. When filtering is enabled, only readings that match a configured UOM/TOU/SQI combination are processed. All others are filtered out.

Filtering is enabled by default via the "Opt Out Of Filtering" parameter (set to "false" by default) on the D7-CCOMPEVSR (SSN - Create Completion Event Scalar) algorithm on the Create Completion Events status of the D7-MeterReadResultsScalar (SSN - Meter Read Results (Scalar)) business object (for scalar on-demand read commands) and/or on the D7-CCEVTINDR (SSN - Create Completion Event Interval) algorithm on the Create Completion Events status of the D7-MeterReadResultsInterval (SSN - Meter Read Results (Interval)) business object (for interval on-demand read commands).

When filtering is enabled, the "Filter if invalid external MC identifier" parameter on the D7-CCOMPEVSR and D7-CCEVTINDR algorithms controls what should happen if a measuring component cannot be found using the MC Identifier Number sent from the head end system. When set to 'Yes' and no measuring component is found, the initial measurement will be filtered. When set to 'No' and no measuring component is found, the system will attempt to find the measuring component using the UOM and TOU. The value of the "Filter if invalid external MC identifier" on the D7-CCOMPEVSR and D7-CCEVTINDR algorithms must match the value of the "Error if invalid external MC identifier" parameter on the D1-DER-SPRMC algorithm on the IMD Seeder (D1-IMDSeeder) business object. The parameters should both be set to either 'yes' or 'no'.

Deprecated Outbound Communications

The outbound communication business objects listed in the table above replace the following outbound communication business objects, which will be deprecated in a future release.

Command	Deprecated Outbound Communication Business Object
Remote Connect/Remote Disconnect	SSN - Connect or Disconnect (D7-ConnectDisconnectDR)
On-Demand Read (Scalar)	SSN - Add Meter Read Job (Scalar) (D7-AddMeterReadJobScalarDR)
On-Demand Read (Interval)	SSN - Add Meter Read Job (Interval) (D7-AddMeterReadJobIntervalDR)
Device Status Check	SSN - Add Ping Job (D7-AddPingJobDR)

Filtering On-Demand Read Payloads

By default, the On-Demand Read command is initiated for a specific meter (device) and returns readings (measurement data) for each register or channel (measuring component) on the meter. However, in some circumstances, an implementation may not want measurements returned for every channel. For instance, they may only want or need billing-related data, or only a subset of the data recorded by the meter.

Measurement payloads received via On-Demand Read commands can be filtered based on unit of measure (UOM) by adding custom logic to the XLS files used to send and receive On-Demand Read command.

This filtering can be implemented by editing the appropriate XSL to include a variable containing a list of "approved UOMs" list and logic that filters the payload based on the "approved list" variable.

Examples

The lines noted by “<!-- List of approved UOMS -->” and “<!-- UOM Filtering here -->” in the following excerpts from Landis+Gyr XSL files illustrate how the files can be edited to apply UOM filtering.

L+G Reading Changed Notification Request (D3-ReadingChgNotifRequest.xsl)

```
<?xml version="1.0" encoding="UTF-8"?>
<xsl:stylesheet exclude-result-prefixes="soap11 soap12 ns1" xmlns:ns1="http://
www.multispeak.org/Version_3.0" xmlns:soap12="http://www.w3.org/2003/05/soap-
envelope" xmlns:soap11="http://schemas.xmlsoap.org/soap/envelope/" xmlns:xsl="http://
www.w3.org/1999/XSL/Transform" version="1.0">
  <xsl:import href="D3-MultiSpeakMsgHeader.xsl"/>
  <!-- List of approved UOMS -->
  <xsl:variable name="Approved_UOMs">|kWh|</xsl:variable>
  <xsl:template match="soap11:Envelope">
    <xsl:apply-templates select="//ns1:ReadingChangedNotification"/>
    ...
  <xsl:template match="ns1:readingValues">
    <xsl:for-each select="./ns1:readingValue">
      <readingValue>
        <extensions>
          <xsl:value-of select="./ns1:extensions"/>
        </extensions>
        <extensionsList>
          <xsl:apply-templates select="./ns1:extensionsList"/>
        </extensionsList>
        <units>
          <xsl:value-of select="./ns1:units"/>
        </units>
        <value>
          <xsl:value-of select="./ns1:value"/>
        </value>
        <!-- UOM Filtering here -->
        <xsl:if test="contains($Approved_UOMs, concat('|', ./ns1:name , '|'))">
          <name>
            <xsl:value-of select="./ns1:name"/>
          </name>
        </xsl:if>
        <dateTime>
          <xsl:value-of select="./ns1:dateTime"/>
        </dateTime>
      </readingValue>
    </xsl:for-each>
  </xsl:template>
  ...
```

SGG L+G CIM AsyncReply MeterReadings Request XSL (D3-CIMMeterReadingRequest.xsl)

```
<?xml version="1.0" encoding="UTF-8"?>
<xsl:stylesheet exclude-result-prefixes="xsl env sec msg mtr ede xsi" xmlns:xsi="http://
www.w3.org/2001/XMLSchema-instance" xmlns:ede="http://iec.ch/TC57/2009/
EndDeviceEvents#" xmlns:mtr="http://iec.ch/TC57/2009/MeterReadings#" xmlns:msg="http://
www.iec.ch/TC57/2008/schema/message" xmlns:sec="http://www.landisgyr.com/
```

```

iec61968/2010/03" xmlns:env="http://schemas.xmlsoap.org/soap/envelope/" xmlns:xsl="http://
www.w3.org/1999/XSL/Transform" version="1.0">
<xsl:output indent="yes" encoding="utf-8" method="xml"/>
  <!-- List of approved UOMS -->
  <xsl:variable name="Approved_UOMS">|kWh|</xsl:variable>
<xsl:template match="env:Envelope">
  <xsl:apply-templates select="./env:Body/msg:ResponseMessage"/>
</xsl:template>
...

<xsl:template match="mtr:Readings">
  <xsl:if test="string-length(./*) > 0">
    <Readings>
      <timeStamp>
        <xsl:value-of select="./mtr:timeStamp"/>
      </timeStamp>
      <xsl:apply-templates select="./mtr:value" mode="copyif"/>
      <xsl:for-each select="./ReadingQualities[string-length(./mtr:quality) > 0]">
        <ReadingQualities>
          <quality>
            <xsl:value-of select="./mtr:quality"/>
          </quality>
        </ReadingQualities>
      </xsl:for-each>
      <xsl:if test="string-length(./mtr:ReadingType/@ref) > 0">
        <!-- UOM Filtering here -->
        <xsl:if test="contains($Approved_UOMS, concat('|', ./mtr:ReadingType/@ref, '|'))">
          <ReadingTypeRef>
            <xsl:value-of select="./mtr:ReadingType/@ref"/>
          </ReadingTypeRef>
        </xsl:if>
      </xsl:if>
    </Readings>
  </xsl:if>
</xsl:template>
...

```

Head End System XSL Files

The table below lists the XSL files that can be used to filter payloads using this approach for each head end system.

XSL files can be edited using the **Managed Content** portal.

Head End System	XSL	Where Used
Landis+Gyr	D3-CIMMeterReadingRequest.xsl	Inbound Web Service (CIM Service Callback)
Landis+Gyr	D3-ReadingChgNotifRequest.xsl	Inbound Web Service (Reading Changed Notification (Callback))
Sensus	D6-ReadingChgNotifRequest.xsl	Inbound Web Service (Sensus MultiSpeak CB_Server Interface)
Silver Spring Networks	D7-GetMtrRdRsByJobIDResp.xsl	External System Message XSL (provided by implementation)

Sending Outbound Communications

Sending outbound communications to a head end system involves configuring the following entities:

- Outbound Message Types:** Define how outbound messages of a specific type are handled. Outbound message types are based on a specific outbound message business object that defines the data structure of the message. See [Defining Outbound Message Types](#) in the *Administrative User Guide* and [Creating Outbound Message Types](#) below for more information.

- **Message Senders:** Define details for sending messages to external systems. See [Message Senders](#) in the *Administrative User Guide* for more information.
- **External System:** Defines a set of outbound message types that can be sent to the head end system. See [External Systems](#) in the *Administrative User Guide* for more information.
- **Head End System:** Defines processing rules for the head end system, such as the specific activities and communications created for smart meter commands. See [Head End Systems](#) and [Processing Methods](#) in the *Administrative User Guide* and [Configuration Processing Methods](#) below for more information.

Creating Outbound Message Types

Outbound message types must be configured for each command you plan to use in your implementation. The base package includes a set of outbound message types that can be used. The tables below lists the outbound message types provided for each Smart Grid Gateway adapter.

Itron OpenWay Outbound Message Types

This table lists the outbound message types used with the Itron OpenWay adapter, along with the business objects used with each.

Command	Outbound Message Type / Business Object	“Result” Outbound Message Type / Business Object
Device Commissioning	Itron - Add Meter Definitions O/B Msg Type (D8-AMDOBM) Itron - Commissioning Outbound Message (D8-ItronCommissionOutboundMsg)	N/A
Device Decommissioning	Itron - Deregister Meter O/B Msg Type (D8-DREGOBM) Itron - Decommissioning Outbound Message (D8-ItronDecommissionOutbndMsg)	N/A
Remote Connect	Itron - Reconnect Meter O/B Msg Type (D8-RCNOBM) Itron - Remote Connect Outbound Message (D8-ItronRemoteConnectOutbndMsg)	Itron - Get Reconnect Meter Result O/B Msg Type (D8-GRCNOBM) Itron - Get Remote Connect Results Outbound Message (D8-ItronRemoteCntRsltOutMsg)
Remote Disconnect	Itron - Disconnect Meter O/B Msg Type (D8-DISCOMOBM) Itron - Disconnect Outbound Message (D8-ItronRemoteDisconnectOutMsg)	Itron - Get Disconnect Meter Result O/B Msg Type (D8-GDMROBM) Itron - Get Disconnect Result Outbound Message (D8-ItronRemoteDcntRsltOutMsg)
On-Demand Read (Scalar)	Itron - Contingency Read O/B Msg Type (D8-CRDOBM) Itron - Contingency Read Outbound Message (D8-ItronOnDemandReadOutbndMsg)	Itron - Get Contingency Read Results O/B Msg Type (D8-GCRDOBM) Itron - Get Contingency Read Result Outbound Message (D8-ItronOnDemandReadRsltOBMsg)
On-Demand Read (Interval)	Itron - Contingency Read O/B Msg Type (D8-CRDOBM) Itron - Contingency Read Outbound Message (D8-ItronOnDemandReadOutbndMsg)	Itron - Get Contingency Read Results O/B Msg Type (D8-GCRDOBM) Itron - Get Contingency Read Result Outbound Message (D8-ItronOnDemandReadRsltOBMsg)
Scheduled Read (Scalar)	Itron - Scheduled Read O/B Msg Type (D8-SROBM) Itron - Schedule Read Outbound Message (D8-ItronInterrogateByGrpOBMsg)	Itron - Get Scheduled Read Result O/B Msg Type (D8-GSRROBM) Itron - Get Schedule Read Result Outbound Message (D8-ItronInterrogateByGrpRsltOB)
Scheduled Read (Interval)	Itron - Scheduled Read O/B Msg Type (D8-SROBM) Itron - Schedule Read Outbound Message (D8-ItronInterrogateByGrpOBMsg)	Itron - Get Scheduled Read Result O/B Msg Type (D8-GSRROBM) Itron - Get Schedule Read Result Outbound Message (D8-ItronInterrogateByGrpRsltOB)
Device Status Check	Itron - Ping By Endpoints O/B Msg Type (D8-DSCOBM)	Itron - Get Ping By Endpoints Result O/B Msg Type (D8-GDSCROBM)

Command	Outbound Message Type / Business Object	“Result” Outbound Message Type / Business Object
	Itron - Device Status Check Outbound Message (D8-ItronDvcStatusChkOutbndMsg)	Itron - Get Device Status Check Result Outbound Message (D8-ItronDvcStatusChkRsltOBMsg)
Multi-Device Status Check	Itron - Multi Ping By Endpoints O/B Msg Type (D8-MDSCOBM)	Itron - Get Multi Ping By Endpoints Result O/B Msg Type (D8-GMDSOBM)
	Itron - Multi Device Status Check Outbound Message (D8-ItronDvcStChkMtDvcOutbndMsg)	Itron - Get Multi Device Status Check Result Outbound Message (D8-ItronDvcStChkMtDvcRsltOBMsg)
Load Check	Itron - Detect Load Side Voltage O/B Msg Type (D8-DLSVOBM)	Itron - Get Detect Load Side Voltage Results O/B Msg Type (D8-GDLSVOBM)
	Itron - Detect Load Side Voltage Outbound Message (D8-ItronDetectLoadSideVolOBMsg)	Itron - Get Detect Load Side Voltage Result Outbound Message (D8-ItronDetLSVltMtrRsltOutMsg)

Landis+Gyr Outbound Message Types

This table lists the outbound message types used with the Landis+Gyr adapter, along with the business objects used with each.

Command	Outbound Message Type / Business Object
Device Commissioning	Add Meter to Inventory (L+G) (D3-AMIOMTYP) LG - Add Meter To Inventory OB Message (D3-AddMeterToInventoryOBMsg)
Device Decommissioning	Notify Remove Meter (L+G) (D3-MRENOMTYP) LG - Meter Remove Notification OB Message (D3-MeterRemoveNotifOBMsg)
Meter Retire	Notify Retire Meter (L+G) (D3-MRNOMTYP) LG - Meter Retire Notification OB Message (D3-MeterRetireNotifOBMsg)
Meter Exchange	Notify Exchange Meter (L+G) (D3-MENOBMTYP) LG -Meter Exchange Notification OB Message (D3-MeterExchNotificatnOBMsg)
Remote Connect	Initiate Connect Disconnect by Meter Number (L+G) (D3-INCODIOBM) LG Initiate Connect Disconnect OB Message (D3-InitConnectDisconnectOBMsg)
Remote Disconnect	Initiate Connect Disconnect by Meter Number (L+G) (D3-INCODIOBM) LG Initiate Connect Disconnect OB Message (D3-InitConnectDisconnectOBMsg)
Demand Reset	Schedule Demand Reset (L+G) (D3-SDROMTYP) LG - Schedule Demand Reset OB Message (D3-ScheduleDemandResetOBMsg)
On-Demand Read (MultiSpeak)	Initiate Read by Meter Number (L+G) (D3-INMRMNOBM) L+G MultiSpeak InitiateMeterReadByMeterNumber OB Message (D3-InitMtrReadByMtrNumOBMsg)
On-Demand Read (Interval) [CIM]	Initiate On-Demand Read (CIM L+G) (D3-CIMODR) CIM AMIRequest GetMeterReads OB Message (D3-CIAMIRRequestGetMtrRdOBMsg)
On-Demand Read (Scalar) [CIM]	Initiate On-Demand Read (CIM L+G) (D3-CIMODR) CIM AMIRequest GetMeterReads OB Message (D3-CIAMIRRequestGetMtrRdOBMsg)
Device Status Check	Initiate Device Status Check (CIM L+G) (D3-CIMDSC)

Command	Outbound Message Type / Business Object
	CIM AMIRequest GetMeterReads OB Message (D3-CIMAMIRequestGetMtrRdOBMsg)

Sensus Outbound Message Types

This table lists the outbound message types used with the Sensus adapter, along with the business objects used with each.

Command	Outbound Message Type / Business Object
Device Commissioning	Notify Add Meter (Sensus) (D6-SMANOMTYP) Sensus - Meter Add Notification OB Message (D6-MeterAddNotificationOBMsg)
Device Decommissioning	Notify Remove Meter (Sensus) (D6-SMRNOMTY) Sensus -Meter Remove Notification OB Msg (D6-MeterRemoveNotificatnOBMsg)
Remote Connect	Initiate Connect Disconnect by Meter Number (Sensus) (D6-INCODIOBM) Sensus Initiate Connect Discon OB Message (D6-InitConnectDisconnectOBMsg)
Remote Disconnect	Initiate Connect Disconnect by Meter Number (Sensus) (D6-INCODIOBM) Sensus Initiate Connect Discon OB Message (D6-InitConnectDisconnectOBMsg)
On-Demand Read (MultiSpeak)	Initiate Read by Meter Id (Sensus) (D6-SIMROMTY) Sensus - Initiate Meter Read By MtrID OBMsg (D6-InitMtrRdMtrIdOBMsg)
Device Status Check	Initiate Outage Detection (Sensus) (D6-SIODTOMTY) Sensus InitiateOutageDetection OB Message (D6-InitOutageDetectionOBMsg)

Silver Spring Networks Outbound Message Types

This table lists the outbound message types used with the Silver Spring Networks adapter, along with the business objects used with each.

Command	Outbound Message Type / Business Object	“Result” Outbound Message Type / Business Object
Device Commissioning	Replace Location (Commission SSN) (D7-RLOCOBMTY) SSN - Replace Location (Comm) Outbound Message (D7-ReplaceLocationOBMsg)	N/A
Device Decommissioning	Replace Device (Decommission SSN) (D7-RDVCOBMTY) SSN - Replace Device At Loc O/B Message (D7-ReplaceDeviceAtLocOBMsg)	N/A
Remote Connect	Connect Disconnect Device (SSN) (D7-CDCOBMTYP) SSN - Connect Disconnect OB Message (D7-ConnectDisconnectOBMsg)	Get Connect Disconnect Result (SSN) (D7-GCDROBMTY) SSN - GetConnectDisconnectResult OB Message (D7-GetCntDiscntResultOBMsg)
Remote Disconnect	Connect Disconnect Device (SSN) (D7-CDCOBMTYP) SSN - Connect Disconnect OB Message (D7-ConnectDisconnectOBMsg)	Get Connect Disconnect Result (SSN) (D7-GCDROBMTY) SSN - GetConnectDisconnectResult OB Message (D7-GetCntDiscntResultOBMsg)
On-Demand Read (Scalar)	Add Scalar Read Job (SSN) (D7-AMRJSCOBMT) SSN - Add Meter Read Job Scalar OB Message (D7-AddMeterReadJobScalarOBMsg)	Get Scalar Read Results by Job Id (SSN) (D7-GMRRBJOMT) SSN - GetMeterReadResults(Scalar) OB Message (D7-GetScIrMtrRdRstByJobIdOBMsg)

Command	Outbound Message Type / Business Object	“Result” Outbound Message Type / Business Object
On-Demand Read (Interval)	Add Interval Read Job (SSN) (D7-AMRJINOBT)	Get Interval Read Results by Job Id (SSN) (D7-GIMRRJOMT)
	SSN - AddMeterReadJob Interval OB Message (D7-AddMtrReadJobIntervalOBMsg)	SSN - GetMeterReadResults(Interval) OB Message (D7-GetIntMtrRdRsltByJobIdOBMsg)
Device Status Check	Add Meter Ping Job (SSN) (D7-APJOBM)	Get Device Ping Job Results (SSN) (D7-GPJROM)
	SSN - Add Ping Job OB Message (D7-AddPingJobOBMsg)	SSN - Get Ping Results O/B Message (D7-GetPingResultsOBMsg)

Creating Message Senders

You must create message senders for each outbound communication that will be sent to the head end system as part of the command communication process.

NOTE:

When creating message senders as part of the command communication process used with native implementations, the **Message Class** MUST be set to **SOAPSNDR** (Sender for real-time HTTP / SOAP messages).

See [Message Senders](#) in the *Administrative User Guide* for more information about creating message senders.

Creating an External System

You must create an external system that represents the head end system and defines a set of outbound message types that can be sent to the head end system.

External System Outbound Message Types

You must configure an outbound message type on the external system for each type of message you will send to the head end system. An external system’s outbound message types are defined by the following:

- **Outbound Message Type:** The outbound message type created for the message (see [Creating Outbound Message Types](#))
- **Processing Method:** The method by which the message will be sent. This should be set to “Real-time” Smart Grid Gateway outbound communications.
- **Message Sender:** The message sender created for the message (see [Creating Message Senders](#))
- **Message XSL / Response XSL:** XSL files used to transform your message and the response to the message into the appropriate format used by the head end system (Message XSL) and Smart Grid Gateway (Response XSL). Each Smart Grid Gateway adapter includes XSL files for each type of outbound communication.

See [External Systems](#) in the *Administrative User Guide* for more information about creating external systems.

Itron OpenWay XSL Files

The table below lists the XSL provided for use with outbound message types based on the outbound message business objects provided with the Itron OpenWay adapter.

Outbound Message Business Object	Message XSL	Response XSL
Outbound Message for Itron Commission (D8-ItronCommissionOutboundMsg)	D8-CommissionRequest.xsl	D8-CommissionResponse.xsl
Outbound Message for Itron Decommission (D8-ItronDecommissionOutbndMsg)	D8-DecommissionRequest.xsl	D8-DecommissionResponse.xsl

Outbound Message Business Object	Message XSL	Response XSL
Outbound Message for Itron connect command (D8-ItronRemoteConnectOutbndMsg)	D8-ReconnectRequest.xml	D8-ReconnectResponse.xml
Outbound Message for Itron connect result command (D8-ItronRemoteCntRsltOutMsg)	D8-GetReconnectRsRequest.xml	D8-GetReconnectRsResponse.xml
Outbound Message for Itron disconnect command (D8-ItronRemoteDisconnectOutMsg)	D8-DisconnectRequest.xml	D8-DisconnectResponse.xml
Outbound Message for Itron disconnect result command (D8-ItronRemoteDcntRsltOutMsg)	D8-GetDisconnectRsRequest.xml	D8-GetDisconnectRsResponse.xml
Outbound Message for Itron Contingency Read command (D8-ItronOnDemandReadOutbndMsg)	D8-ContRdByEndptsRequest.xml	D8-ContRdByEndptsResponse.xml
O/B Msg for Itron Contingency Read Result (D8-ItronOnDemandReadRsltOBMsg)	D8-GetContRdByEndptsRsReq.xml	D8-GetContRdByEndptsRsResp.xml
Outbound Message for Itron Schedule Read command (D8-ItronInterrogateByGrpOBMsg)	D8-InterrogateByGroupReq.xml	D8-InterrogateByGroupResp.xml
Outbound Message for Itron Schedule Read Result command (D8-ItronInterrogateByGrpRsltOB)	D8-GetIntByGroupRsRequest.xml	D8-GetIntByGroupRsResponse.xml
Outbound Message for Itron Device status check (D8-ItronDvcStatusChkOutbndMsg)	D8-PingByEndpointsRequest.xml	D8-PingByEndpointsResponse.xml
O/B Msg for Itron DeviceStatusCheck Result (D8-ItronDvcStatusChkRsltOBMsg)	D8-GetPingByEndptsRsReq.xml	D8-GetPingByEndptsRsResp.xml
Outbound Message for Itron Multi device status check (D8-ItronDvcStChkMtDvcOutbndMsg)	D8-PingByEndpointsRequest.xml	D8-PingByEndpointsResponse.xml
O/B Message for Itron MultiDeviceStatusCheck Result (D8-ItronDvcStChkMtDvcRsltOBMsg)	D8-GetPingByEndptsRsReq.xml	D8-GetPingByEndptsRsResp.xml
Outbound Message for Itron Detect Load Side Voltage (D8-ItronDetectLoadSideVolOBMsg)	D8-DetLSVByMeterRequest.xml	D8-DetLSVByMeterResponse.xml
Outbound Message for LoadCheckResult Cmd (D8-ItronDetLSVltMtrRsltOutMsg)	D8-GetDetLSVByMeterRsReq.xml	D8-GetDetLSVByMeterRsResp.xml
Outbound Message for Itron Read Disconnect State D8-ItronReadDisconStateOutMsg	D8-RdDiscStByMtrsRequest.xml	D8-RdDiscStByMtrsResponse.xml
Outbound Message for ReadDisconStateMeter Cmd D8-ItronRdDiscStByMtrRsltOutMsg	D8-GetRdDiscStByMtrsRsReq.xml	D8-GetRdDiscStByMtrsRsResp.xml

Landis+Gyr XSL Files

The table below lists the XSL provided for use with outbound message types based on the outbound message business objects provided with the Landis+Gyr adapter.

Outbound Message Business Object	Message XSL	Response XSL
LG - Add Meter To Inventory OB Message D3-AddMeterToInventoryOBMsg	D3-AddMtrToInvRequest.xml	D3-AddMtrToInvResponse.xml
LG - Meter Remove Notification OB Message D3-MeterRemoveNotifOBMsg	D3-MtrRemoveNotifRequest.xml	D3-MtrRemoveNotifResponse.xml
LG - Meter Retire Notification OB Message D3-MeterRetireNotifOBMsg	D3-MtrRetireNotifRequest.xml	D3-MtrRetireNotifResponse.xml
LG -Meter Exchange Notification OB Message D3-MeterExchNotificatnOBMsg	D3-MtrExcNotifRequest.xml	D3-MtrExcNotifResponse.xml
L+G Initiate Connect Disconnect OB Message D3-InitConnectDisconnectOBMsg	D3-InitiateConnDisconReq.xml	D3-InitiateConnDisconResp.xml
LG - Schedule Demand Reset OB Message D3-ScheduleDemandResetOBMsg	D3-ScheduleDemandRstReq.xml	D3-ScheduleDemandRstResp.xml
L+G MultiSpeak InitiateMeterReadByMeterNumber OB Message D3-InitMtrReadByMtrNumOBMsg	D3-InitMtrRdMtrNumRequest.xml	D3-InitMtrRdMtrNumResponse.xml
CIM AMIRequest GetMeterReads OB Message D3-CIMAMIRequestGetMtrRdOBMsg	D3-CIMGetMtrReadsRequest.xml	D3-CIMGetMtrReadsResponse.xml

Sensus XSL Files

The table below lists the XSL provided for use with outbound message types based on the outbound message business objects provided with the Sensus adapter.

Outbound Message Business Object	Message XSL	Response XSL
Sensus - Meter Add Notification OB Message D6-MeterAddNotificationOBMsg	D6-MtrAddRemoveNotifReq.xml	D6-MeterAddNotifResponse.xml
Sensus -Meter Remove Notification OB Msg (D6-MeterRemoveNotificatnOBMsg)	D6-MtrAddRemoveNotifReq.xml	D6-MeterAddNotifResponse.xml
Sensus Initiate Connect Discon OB Message (D6-InitConnectDisconnectOBMsg)	D6-InitiateConnDisconReq.xml	D6-InitiateConnDisconResp.xml
Sensus Initiate Connect Discon OB Message (D6-InitConnectDisconnectOBMsg)	D6-InitiateConnDisconReq.xml	D6-InitiateConnDisconResp.xml
Sensus MultiSpeak InitiateMeterReadByMeterNumber OB Message (D6-InitMtrRdMtrIdOBMsg)	D6-InitMtrRdMtrIdRequest.xml	D6-InitMtrRdMtrIdResponse.xml
Sensus InitiateOutageDetection OB Message	D6-InitOutDetectRequest.xml	D6-InitOutDetectResponse.xml

Outbound Message Business Object**Message XSL****Response XSL**

(D6-InitOutageDetectionOBMsg)

Silver Spring Networks XSL Files

The table below lists the XSL provided for use with outbound message types based on the outbound message business objects provided with the Silver Spring Networks adapter.

Outbound Message Business Object	Message XSL	Response XSL
SSN - Find Device Outbound Message D7-FindDeviceOutboundMsg	D7-FindDeviceRequest.xml	D7-FindDeviceResponse.xml
SSN - Get Job Status Outbound Message D7-GetJobStatusOutboundMsgType	D7-GetJobStatusRequest.xml	D7-GetJobStatusResponse.xml
SSN - Replace Location (D7-ReplaceLocationDR)	D7-ReplaceLocationRequest.xml	D7-ReplaceLocationResponse.xml
SSN - Replace Device At Location (Decomm) (D7-RepIDeviceAtLocForDecommDR)	D7-RepDvcAtLocRequest.xml	D7-RepDvcAtLocResponse.xml
SSN - Connect or Disconnect (D7-ConnectDisconnectDR)	D7-AddRemProvJobRequest.xml	D7-AddRemProvJobResponse.xml
SSN - Connect Disconnect Results (D7-ConnectDisconnectResultDR)	D7-GetRemProvRsByJobIDReq.xml	D7-GetRemProvRsByJobIDResp.xml
SSN - Add Meter Read Job Scalar OB Msg D7-AddMeterReadJobScalarOBMsg	D7-AddMtrRdJobScRequest.xml	D7-AddMtrRdJobScResponse.xml
SSN - GetMeterReadResults(Scalar) By JobId D7-GetScItrMtrRdRstByJobIdOBMsg	D7-GetMtrRdRsByJobIDReq.xml	D7-GetMtrRdRsByJobIDResp.xml
SSN - AddMeterReadJob Interval OB Msg D7-GetIntMtrRdRstByJobIdOBMsg	D7-AddMtrRdJobIntRequest.xml	D7-AddMtrRdJobIntResponse.xml
SSN - GetMeterReadResults(Interval) By JobId D7-GetIMtrRdRstJobIdOBMsgTyp	D7-GetMtrRdRsByJobIDReq.xml	D7-GetMtrRdRsByJobIDResp.xml
SSN - Add Ping Job (D7-AddPingJobDR)	D7-AddPingJobRequest.xml	D7-AddPingJobResponse.xml
SSN - Ping Results (D7-PingResultsDR)	D7-GetMtrRdRsByJobIDReq.xml	D7-GetMtrRdRsByJobIDResp.xml

Configuring Processing Methods

In order to send smart meter commands to a head end system, appropriate processing methods must be configured on the head end system record. The tables below list the details appropriate to configuring processing methods for each command.

This table includes the following:

- **Command:** The command you wish to configure. When a command is initiated for a device, the system creates a command activity.
- **Processing Role:** The Processing Role appropriate for the command to be configured.

- **Business Object:** The outbound communication business object to be created by the command activity. Note that most commands have separate business objects for the initial command request and the result request.
- **Outbound Message Business Object** The business object that should be used when creating outbound message types for each command. Note that most commands use separate business objects for the initial outbound message type and the result outbound message type.

Itron OpenWay Processing Methods

This table lists the details appropriate to configuring processing methods for each command supported for the Itron OpenWay head end system.

Command	Processing Role	Business Object	Outbound Message Business Object
Device Commissioning	Device Registration	Itron - Add Meter Definition (D8-AddMeterDefinitionsDR)	Outbound Message for Itron Commission D8-ItronCommissionOutboundMsg
Device Decommissioning	Device Deregistration	Itron - Deregister Meter (D8-DeregisterMeterDR)	Outbound Message for Itron Decommission D8-ItronDecommissionOutbndMsg
Remote Connect	Remote Connect	Itron - Reconnect Meter (Remote Connect) D8-ReconnectMeterDR)	Outbound Message for Itron connect command D8-ItronRemoteConnectOutbndMsg
	Get Remote Connect Result	Itron - Reconnect Meter Result (D8-ReconnectMeterResult)	Outbound Message for Itron connect result command (D8-ItronRemoteCntRsltOutMsg)
Remote Disconnect	Remote Disconnect	Itron - Disconnect Meter (D8-DisconnectMeterDR)	Outbound Message for Itron disconnect command D8-ItronRemoteDisconnectOutMsg
	Get Remote Disconnect Result	Itron - Disconnect Meter Result (D8-DisconnectMeterResult)	Outbound Message for Itron disconnect result command (D8-ItronRemoteDcntRsltOutMsg)
On-Demand Read (Scalar)	On-Demand Read (Scalar)	Itron - Contingency Read (Scalar) (D8-ReadScalarDR)	Outbound Message for Itron Contingency Read command D8-ItronOnDemandReadOutbndMsg
	Get On-Demand Read Result	Itron - On Demand Read Result (D8-ReadOnDemandReadResultDR)	O/B Msg for Itron Contingency Read Result (D8-ItronOnDemandReadRsltOBMsg)
On-Demand Read (Interval)	On-Demand Read (Interval)	Itron - Contingency Read (Interval) (D8-ReadIntervalDR)	Outbound Message for Itron Contingency Read command (D8-ItronOnDemandReadOutbndMsg)
	Get On-Demand Read Result	Itron - On Demand Read Result (D8-ReadOnDemandReadResultDR)	O/B Msg for Itron Contingency Read Result (D8-ItronOnDemandReadRsltOBMsg)
Scheduled Read (Scalar)	Send Schedule Read Request	Itron - Interrogate by Group (Scalar) (D8-InterrogateByGroupDR)	Outbound Message for Itron Schedule Read command (D8-ItronInterrogateByGrpOBMsg)
	Get Schedule Read Result	Itron - Interrogate by Group Results (D8- InterrogateByGroupResultDR)	Outbound Message for Itron Schedule Read Result command (D8-ItronInterrogateByGrpRsltOB)
Scheduled Read (Interval)	Send Schedule Read Request	Itron - Interrogate by Group (Interval) (D8-InterrogateByGroupDR)	Outbound Message for Itron Schedule Read command (D8-ItronInterrogateByGrpOBMsg)
	Get Schedule Read Result	Itron - Interrogate by Group Results (D8- InterrogateByGroupResultDR)	Outbound Message for Itron Schedule Read Result command (D8-ItronInterrogateByGrpRsltOB)
Device Status Check	Device Status Check	Itron - Ping by Endpoints (Status Check) (D8-PingByEndpointsDR)	Outbound Message for Itron Device status check (D8-ItronDvcStatusChkOutbndMsg)

Command	Processing Role	Business Object	Outbound Message Business Object
	Get Device Status Check Result	Itron - Ping By Endpoints Result (D8- PingByEndpointsResultDR)	O/B Msg for Itron DeviceStatusCheck Result (D8-ItronDvcStatusChkRsltOBMsg)
Multi-Device Status Check	Multi-Device Status Check	Itron - Ping By Endpoints Multi-Device (D8-PingByEndpointsMultiDvcDR)	Outbound Message for Itron Multi device status check (D8-ItronDvcStChkMtDvcOutbndMsg)
	Get Multi-Device Status Check Result	Itron – Ping By Endpoints Multi Dvc Result (D8- PingByEndpointsMDRResultDR)	O/B Message for Itron MultiDeviceStatusCheck Result (D8-ItronDvcStChkMtDvcRsltOBMsg)
Load Check	Load Check	Itron - Detect Load Side Voltage (D8-DetectLoadSideVoltageByMtrDR)	Outbound Message for Itron Detect Load Side Voltage (D8-ItronDetectLoadSideVolOBMsg)
	Get Load Check Results	Itron – Detect Load Side Voltage Result (D8- DetLoadSideVoltageMtrRsltDR)	Outbound Message for LoadCheckResult Cmd (D8-ItronDetLSVoltMtrRsltOutMsg)

Landis+Gyr Processing Methods

This table lists the details appropriate to configuring processing methods for each command supported for the Landis+Gyr head end system.

Command	Processing Role	Business Object	Outbound Message Business Object
Device Commissioning	Device Registration	L+G Add Meter to Inventory(MultiSpeak) (D3-AddMeterToInventoryMultiSpDR)	LG - Add Meter To Inventory OB Message D3-AddMeterToInventoryOBMsg
Device Decommissioning	Device Removal	L+G Meter Remove Notification (MultiSpeak) (D3-MtrRmvNotifMultiSpeakDR)	LG - Meter Remove Notification OB Message (D3-MeterRemoveNotifOBMsg)
Meter Retire	Device Deregistration	L+G Meter Retire Notification (D3-MeterRetireNotificationDR)	LG - Meter Retire Notification OB Message (D3-MeterRetireNotifOBMsg)
Meter Exchange	Device Installation	L+G Meter Exchange Notification (D3-MeterExNotificatnMultiSpDR)	LG -Meter Exchange Notification OB Message (D3-MeterExchNotificatnOBMsg)
Remote Connect	Remote Connect	L+G Initiate Connect Disconnect DR (D3-InitiateConnectDisconnectDR)	L+G Initiate Connect Disconnect OB Message (D3-InitConnectDisconnectOBMsg)
Remote Disconnect	Remote Disconnect	L+G Initiate Connect Disconnect DR (D3-InitiateConnectDisconnectDR)	L+G Initiate Connect Disconnect OB Message (D3-InitConnectDisconnectOBMsg)
Demand Reset	Demand Reset	L+G Schedule Demand Reset (Multispeak) (D3-ScheduleDemandResetDR)	LG - Schedule Demand Reset OB Message (D3-ScheduleDemandResetOBMsg)
On-Demand Read (MultiSpeak)	On-Demand Read (Scalar)	L+G MultiSpeak Initiate Meter Read By Meter Num Direct Route (D3-InitiateMRByMtrNbrDR)	L+G MultiSpeak InitiateMeterReadByMeterNumber OB Message (D3-InitMtrReadByMtrNumOBMsg)
On-Demand Read (Interval) [CIM]	On-Demand Read (Interval)	CIM Meter On Demand Read Direct Route (Interval) (D3-CIMGetLPDataDR)	CIM AMIRequest GetMeterReads OB Message (D3-CIMAMIRequestGetMtrRdOBMsg)
On-Demand Read (Scalar) [CIM]	On-Demand Read (Scalar)	CIM Meter On Demand Read Direct Route (Scalar) (D3-CIMMeterOnDemandReadDR)	CIM AMIRequest GetMeterReads OB Message (D3-CIMAMIRequestGetMtrRdOBMsg)
Device Status Check	Device Status Check	CIM Ping Direct Route	CIM AMIRequest GetMeterReads OB Message

Command	Processing Role	Business Object	Outbound Message Business Object
		(D3-CIMPingDR)	(D3-CIMAMIRRequestGetMtrRdOBMsg)

Sensus Processing Methods

This table lists the details appropriate to configuring processing methods for each command supported for the Sensus head end system.

Command	Processing Role	Business Object	Outbound Message Business Object
Device Commissioning	Device Registration	Sensus -Meter Add Notification Direct Route (D6-MeterAddNotificationDR)	Sensus - Meter Add Notification OB Message D6-MeterAddNotificationOBMsg
Device Decommissioning	Device Removal	Sensus -Meter Remove Notification Direct Route (D6-MeterRemoveNotificationDR)	Sensus -Meter Remove Notification OB Msg (D6-MeterRemoveNotificatnOBMsg)
Remote Connect	Remote Connect	Sensus - Initiate Conn Discon - DR (D6-InitiateConnectDisconnectDR)	Sensus Initiate Connect Discon OB Message (D6-InitConnectDisconnectOBMsg)
Remote Disconnect	Remote Disconnect	Sensus - Initiate Conn Discon - DR (D6-InitiateConnectDisconnectDR)	Sensus Initiate Connect Discon OB Message (D6-InitConnectDisconnectOBMsg)
On-Demand Read (MultiSpeak)	On-Demand Read (Scalar)	Sensus - Initiate Meter Read By Meter ID (D6-InitiateMeterByMeterIdDR)	Sensus MultiSpeak InitiateMeterReadByMeterNumber OB Message (D6-InitMtrRdMtrIdOBMsg)
Device Status Check	Device Status Check	Sensus Initiate Outage Detection DR (D6-InitiateOutageDetectionDR)	Sensus InitiateOutageDetection OB Message (D6-InitOutageDetectionOBMsg)

Silver Spring Networks Processing Methods

This table lists the details appropriate to configuring processing methods for each command supported for the Silver Spring Networks head end system.

Command	Processing Role	Business Object	Outbound Message Business Object
Device Commissioning	Device Registration	SSN - Replace Location (D7-ReplaceLocationDR)	SSN - Replace Location (Comm) OB Message (D7-ReplaceLocationOBMsg)
Device Decommissioning	Device Removal	SSN - Replace Device At Location (Decomm) (D7-RepDeviceAtLocForDecommDR)	SSN - Replace Device At Loc O/B Message: (D7-ReplaceDeviceAtLocOBMsg)
Remote Connect	Remote Connect	SSN - Add Remote Provisioning Job - Polling (D7-AddRemoteProvJobDRP)	SSN - Connect Disconnect OB Message (D7-ConnectDisconnectOBMsg)
	Get Remote Connect Result	SSN - Connect Disconnect Results (D7-ConnectDisconnectResultDR)	SSN - GetConnectDisconnectResult OB Message (D7-GetCntDiscntResultOBMsg)
Remote Disconnect	Remote Disconnect	SSN - Add Remote Provisioning Job - Polling (D7-AddRemoteProvJobDRP)	SSN - Connect Disconnect OB Message (D7-ConnectDisconnectOBMsg)
	Get Remote Disconnect Result	SSN - Connect Disconnect Results (D7-ConnectDisconnectResultDR)	SSN - GetConnectDisconnectResult OB Message (D7-GetCntDiscntResultOBMsg)
On-Demand Read (Scalar)	On-Demand Read (Scalar)	SSN - Add Mtr Read Job (Scalar) - Polling (D7-AddMeterReadJobScalarDRP)	SSN - Add Meter Read Job Scalar OB Msg Type D7-AddMeterReadJobScalarOBMsg

Command	Processing Role	Business Object	Outbound Message Business Object
	Get On-Demand Read Result (Scalar)	SSN - Meter Read Results (Scalar) (D7-MeterReadResultsScalar)	SSN - GetMeterReadResults(Scalar) By JobId (D7-GetSMtrRdRsltJobIdOBMsgTyp)
On-Demand Read (Interval)	On-Demand Read (Interval)	SSN - Add Mtr Read Job (Interval) - Polling (D7-AddMeterReadJobIntervalDRP)	SSN - AddMeterReadJob Interval OB Msg Type (D7-AddMtrReadJobIntervalOBMsg)
	Get On-Demand Read Result (Interval)	SSN - Meter Read Results (Interval) (D7-MeterReadResultsInterval)	SSN - GetMeterReadResults(Interval) By JobId (D7-GetIMtrRdRsltJobIdOBMsgTyp)
Device Status Check	Device Status Check	SSN - Add Ping Job - Polling (D7-AddPingJobDRP)	SSN - Add Ping Job OB Message (D7-AddPingJobOBMsg)
	Get Device Status Check Result	SSN - Ping Results (D7-PingResultsDR)	SSN - Get Ping Results O/B Message (D7-GetPingResultsOBMsg)
Get Job Status	Get Job Status	SSN - Get Job Status for Polling (D7-GetJobStatusDRP)	SSN - Get Job Status Outbound Message (D7-GetJobStatusOutboundMsg)

Receiving Inbound Communications

Receiving inbound communications from a head end system involves configuring the following:

- **Inbound Web Services:** These services are used to receive inbound communications from external systems. See [Inbound Web Services](#) in the *Administrative User Guide* for more information.
- **Master Configurations:** Defines configuration settings for individual adapters.

Inbound Web Services

Inbound web services are used to receive inbound communications from external systems. The tables below list the inbound web services provided with each Smart Grid Gateway adapter.

Itron OpenWay Inbound Web Services

The table below lists the inbound web service provided with the Itron OpenWay adapter.

Name	Description
D8-RequestStatusChangedService	Itron RequestStatusChangedService: Use to receive "status changed" messages from the Itron OpenWay head end system. This service creates instances of the "Itron – StatusChanged" (D8-StatusChanged) inbound communication business object for each message.
D8-DataSubscriberService	Itron DataSubscriberService: Used to receive usage and device event payloads from the Itron OpenWay head end system. This service invokes the "Itron – DataArrived Request" (D8_DATAARR) service script, which invokes the ItronDataArrivedStreamProcessor business component to process the usage or device event payload based on the configuration of the Itron Master Configuration, the SGG Payload Processing Configuration extendable lookup, and the File Storage extendable lookup.
D8-EventSubscriberService	Itron EventSubscriberService: Used to receive device event payloads from the Itron OpenWay head end system.

Name	Description
	This service invokes the "Itron – EventsArrived Request" (D8_EVNTSARR) service script, which invokes the ItronEventsArrivedStreamProcessor business component to process the device event payload based on the configuration of the Itron Master Configuration, the SGG Payload Processing Configuration extendable lookup, and the File Storage extendable lookup.
D8-ExceptionSubscriberService	Itron ExceptionSubscriberService: Used to receive exceptions from the Itron OpenWay head end system. This service invokes the "Itron – ExceptionsArrived Request" (D8_EXCPARR) service script, which invokes the ItronExceptionsArrivedStreamProcessor business component to process the exception based on the configuration of the Itron Master Configuration, the SGG Payload Processing Configuration extendable lookup, and the File Storage extendable lookup.

Landis+Gyr Inbound Web Services

The table below lists the inbound web services provided with the Landis+Gyr adapter.

Name	Schema Name	Request / Response XSL
CD State Changed Notification (Callback) (D3-CB_CD)	D3-ConnectDisconStateChgNtfDR	D3-ConDiscnStateChgNtfReq.xml D3-ConDiscnStateChgNtfResp.xml
Reading Changed Notification (Callback) (D3-CB_MR)	D3-ReadingChgNotificationDR	D3-ReadingChgNotifRequest.xml D3-ReadingChgNotifResponse.xml
CIM Service Callback (D3-CIMCallback)	D3-CIMAsyncReplyMeterReadingDR	D3-CIMMeterReadingRequest.xml D3-CIMMeterReadingResponse.xml
Schedule Demand Response (Multispeak) (D3-ScheduleDemandResetResponse)	D3-ReadingChgNotificationDR	D3-ReadingChgNotifRequest.xml D3-ReadingChgNotifResponse.xml

Sensus Inbound Web Services

The table below lists the inbound web services provided with the Sensus adapter.

Name	Schema Name	Request / Response XSL
Reading Changed Notification (Callback) (D6-CB_MR)	D6-ReadingChgNotificationDR	D6-ReadingChgNotifRequest.xml D6-ReadingChgNotifResponse.xml
Sensus MultiSpeak CB_Server Interface (D6-CB_Server)	D6-ConnectDisconStateChgNtfDR	D6-ConDiscnStateChgNtfReq.xml D6-ConDiscnStateChgNtfResp.xml
	D6-ReadingChgNotificationDR	D6-ReadingChgNotifRequest.xml D6-ReadingChgNotifResponse.xml
Sensus MultiSpeak OA_Server Interface (D6-OA_Server)	D6-ODEventNotificationDR	D6-ODEventNotifRequest.xml D6-ODEventNotifResponse.xml
Unsolicited Event Response D6-UnsolicitedEventNotification	D6-UnsolicitedEvtNotification	

Adapter Development Kit - Creating Custom Commands

This section describes how the Oracle Utilities Smart Grid Gateway Adapter Development Kit can be configured to support custom smart meter commands, including those from non-supported head end systems.

This includes:

- An overview of the data and objects used by smart meter commands
- A description and example of synchronous commands
- A description and example of asynchronous commands

Overview

This section provides an overview of how smart meter commands work and the types of objects used in executing commands when implementing Smart Grid Gateway adapters using native implementations and with Oracle Utilities cloud services.

As noted in [Device Communication Overview](#), command processing works slightly differently than it does in middleware implementations. That section provides an introduction to command processing in Smart Grid Gateway adapters, and the **Native Implementation Command Processing** section provides a step-by-step description of the various data and objects created as part of command processing.

The remainder of this section provides additional details regarding the three primary types of data and objects used with smart meter command processing:

- Command Activities
- Outbound Communications
- Inbound Communications

Command Activities

Smart meter commands are managed by activities. Activities orchestrate one or more communications and execute any completion events associated with the command.

Key Algorithms

This section outlines some of the important algorithms executed as part of the command activity's lifecycle.

Some algorithms are directly shared by multiple business objects and multiple lifecycle states. In other cases, unique algorithms will perform the same role across business objects. The following section refers to the algorithms generically.

Lifecycle State	Algorithms
Validate	<p>The Validate state is an opportunity to check whether the command should execute.</p> <ul style="list-style-type: none">• Check Device Command Eligibility: Checks whether the command request is eligible for the device by calling the Determine Eligible Commands Business Service (D1-DetermineEligibleCommands). The command request is considered eligible if it exists in the eligible commands list returned by the business service.• Validate Head End's Capability to Perform Activity: This algorithm checks to ensure that the head end system has the capability to support the command requested. It accomplishes this by invoking the Determine Service Providers and Methods Business Service.

Lifecycle State

Algorithms

Validation Error

If the Activity fails validation, it transitions to the Validation Error state. From this state the activity can be retried and create To Do entries to notify users of the error.

- **Check for Existing Active Request:** This algorithm looks for non-Final Activities with the same Device and of the same type. This prevents duplicate requests from being sent to the head end system.
- **Retry BO In Error:** Reprocesses the BO by transitioning it to its original state.
- **Create To Do Entry for BO in Error:** This algorithm attempts to create a To Do entry using the To Do type and role specified by the algorithm parameters.
- **Generic To Do Completion for BOs:** This algorithm completes all To Do entries with Drill Keys = Current Business Object's prime keys except for To Do Types with Characteristic Type and Value as specified by algorithm parameters. This prevents the existence of multiple To Do entries for the same command and device.

Waiting For Effective Date

Prior to sending the request to the head end system, the activity enters this state.

- **Wait Time Out - Transition to Rejection:** This algorithm rejects the business object if the expiration date time has been reached.
- **Wait for Effective Date:** When the required date is reached, this algorithm transitions the business object to the next configured state.
- **Send Response to External Requester:** This algorithm sends an acknowledging received response outbound message to the requester if the business object is configured to do so.

Connection Ready

The Connection Ready state shows that the activity can be executed and creates the proper outbound communication business object. This state can be re-entered when there are multiple outbound communications that are required by the head end system's API.

- **Create Outbound Communication:** This algorithm creates an outbound communication instance if the value of the completion flag specified by an algorithm parameter is false.
- **Create Results Outbound based on Completion Flag:** This algorithm triggers a secondary communication to the head end system based on the value of an algorithm parameter. Typically, this indicates the successful completion of an initial outbound communication.

Communication In Progress

This lifecycle state indicates that an outbound communication is in-progress.

- **Wait Time Out - Transition to Exception:** If the business object has been in the In Progress state too long, this algorithm transitions the business object to an exception state.
- **Check Children Communications:** If all of the outbound communication business object instances related to this activity

Lifecycle State

Algorithms

Lifecycle State	Algorithms
	have completed, the algorithm transitions the business object to the next state.
Communication Error	<p>An error-handling lifecycle state to which the business object transitions when the communication encounters a problem. The algorithms are similar to those in the Validation Error state.</p> <ul style="list-style-type: none">• Wait Time Out - Transition to Rejection: If the business object has been in the In Progress state too long, this algorithm transitions the business object to a rejection state.• Retry BO In Error: This algorithm reprocesses the business object by transitioning it to its original state.• Create To Do Entry for BO in Error: This algorithm attempts to create a To Do entry using the To Do type and role specified by the algorithm parameters.• Generic To Do Completion for BOs: This algorithm completes all To Do entries with Drill Keys = Current Business Object's prime keys except for To Do Types with Characteristic Type and Value as specified by algorithm parameters. This prevents the existence of multiple To Do entries for the same command and device
Retry	The lifecycle state responsible for discarding existing outbound communications and transitioning the activity back to Connection Ready.
Execute Completion Events	<p>This lifecycle state collates the information acquired by the communications and creates some result. For example, in a DeviceStatusCheck, the overall results are set.</p> <ul style="list-style-type: none">• Execute Completion Events: Fires the completion events associated with the activity.
Completion Event Error	This is another error-handling state similar to the Validation Error and the Communication Error states. The algorithms are the same as in those states.
Completed	This is the final state representing a successful activity. Finishing tasks are performed and external requesters are notified.
Discarded	Similarly to the Completed state, the Discarded state finishes the activity and indicates an overall failure. External requesters are notified of the failure and other finishing tasks are performed.

Outbound Communications

Outbound Communications represent the business logic of sending a request and receiving a reply. Outbound communication business objects are based on the D1-COMMOUT maintenance object. The outbound communication is not the actual message, but creates the outbound message. Outbound communication business objects used with native implementations are suffixed with “-DR” for “direct route” to indicate the request go straight to the head end system.

Schema

This section provides details concerning outbound communication business object schemas.

Outbound communication schemas typically have a “sendDetail” element corresponding to the data being sent to the head end system, or more precisely, the XSL handler for the outbound message. The synchronous response is transformed by the XSL handler and placed into the “responseDetail” element.

Key Algorithms

This section outlines some of the important algorithms executed as part of the outbound communication’s lifecycle.

Some algorithms are directly shared by multiple business objects and multiple lifecycle states. In other cases, unique algorithms will perform the same role across business objects. The following section refers to the algorithms generically.

Lifecycle State	Algorithms
Validate	<p>Similar to the activity, the Validate state houses algorithms that will execute prior to sending the message.</p> <ul style="list-style-type: none"> Validate Communication Type: This algorithm ensures the communicationType field is populated on the message.
Validation Error	<p>If the Validate state encounters an error, the business object transitions to this state. The algorithms are similar to those in the activity business object.</p>
Awaiting Response	<p>The Awaiting Response state sends an outbound message and awaits the response.</p> <ul style="list-style-type: none"> Populate Send Detail: Each outbound communication has a specific algorithm to populate all the schema elements that are required to create the outbound message. Create Outbound Message: This algorithm creates a specific outbound message based on the Processing Role. The response is stored in the responseDetails element. Timeout: This algorithm detects whether a communication has been waiting for an asynchronous response too long.
Retry	<p>The lifecycle state responsible for transitioning the outbound communication back to Awaiting Response.</p>
Response Error	<p>The business object enters the Response Error state when an error has occurred in sending the request. It contains algorithms for creating To Do entries and for retrying similar to the activity’s Communication Error state.</p>
Completed	<p>This is the final state representing a successful outbound communication. Finishing tasks such as setting flags for use by subsequent communications and notifying the parent activity of completion are performed.</p>
Discarded	<p>Includes an algorithm that transfers the parent activity to Failed.</p>

Inbound Communications

Inbound communication business objects are based on the D1-COMMIN maintenance objects. Inbound Communication objects have a much less defined schema since they are driven by the needs of the head end system’s API and those of the business process. As with outbound communications, the schema does not represent the exact message, but is the post-processed XSL result.

Key Algorithms

This section outlines some of the important algorithms executed as part of the inbound communication's lifecycle.

Some algorithms are directly shared by multiple business objects and multiple lifecycle states. In other cases, unique algorithms will perform the same role across business objects. The following section refers to the algorithms generically.

Lifecycle State	Algorithms
Validate	<p>Similar to the activity, the Validate state houses algorithms that will execute as the message is created.</p> <ul style="list-style-type: none">• Validate Communication Type: This algorithm ensures the communicationType field is populated on the message.• Find Parent Outbound Communication for Async Inbound: This algorithm is responsible for linking the incoming message with the original outbound communication using, for example, a transaction ID. This algorithm is what causes an inbound communication to be linked with a larger process.
Validation Error	<p>If the Validate state encounters an error, the business object transitions to this state. The algorithms are similar to those in the activity business object.</p>
Evaluate Response	<p>The Evaluate Response state processes the inbound communication in the context of an "asynchronous response." The algorithms should perform any required update tasks such as setting flags on the parent outbound communication.</p>
Completed	<p>This successful end state for inbound communications should transition the parent outbound communication to the next state. This typically completes the outbound communication and may trigger the activity to create a subsequent outbound communication.</p>
Discarded	<p>The parent outbound communication should transition to a failure state. This will also place the activity into the Communication Error state where it will await corrections or a Retry attempt.</p>

Synchronous Commands

Synchronous commands, also known as "request-reply" commands, are single HTTP transactions with an initial request followed by a response. The request will contain whatever information is necessary to complete the command, such as meter identifiers or dates. The reply will contain any results generated by the command. It could be a simple acknowledgement or a complex data structure. In general, it will return quickly as HTTP transactions will fail if the response does not arrive quickly enough.

Example: Itron Commissioning Process

This section provides an example of a synchronous command, the commission device command supported by the Itron OpenWay adapter.

The Itron OpenWay 3.9 command for registering a meter (commissioning a device) in the system is AddMeterDefinitions in the `www.itron.com.ami.2008.10.provisioning.wsdl` definition. The Smart Grid Gateway Adapter for Itron OpenWay typically sends a meter serial number and some other configuration data. The response indicates whether or not an error was encountered.

The image below illustrates the process flow used by this command.

Itron AddMeterDefinitions

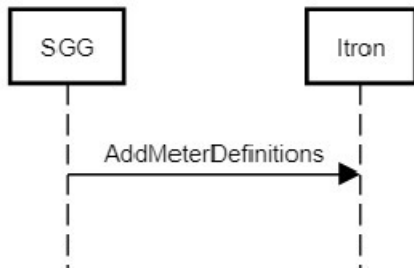

Below is a summary of the important features of the Smart Grid Gateway implementation of this command. Many of the concepts can be applied when creating a custom synchronous command.

Command Activity — Device Commissioning

Business Object: D1-DeviceCommissioning

Lifecycle and Algorithms

The table below outlines some of the important algorithms used by the Device Commissioning command activity.

Lifecycle State	Algorithms
Validate	<p>The important features here are not the specific algorithms, but rather the ability to perform validation logic at a process level.</p> <ul style="list-style-type: none"> • D1-VALDVCNAC – Validate Device Not Already Commissioned: This algorithm checks whether the device is already commissioned • D1-VHPCOMMS – Validate Head-End's Capability to Commission Device: This algorithm checks to ensure that the head-end system has the capability to support the command requested. Some commands may not be supported by every head end system. • D1-CACTCOMM – Check for Existing Active Commissioning Command Request: This algorithm prevents multiple, simultaneous commands from being issued by SGG. • D1-CHKFDCOMM – Check for Concurrent Decommissioning Command Request: This algorithm prevents a commissioning request from executing when there is a current decommissioning request.
Commission Ready	<p>Several algorithms in this state are designed to create outbound communications to the head end system based on various conditions.</p> <ul style="list-style-type: none"> • D1-AMIOBCOMM – AMI Device Identifier Outbound Communication Creation: This algorithm creates an outbound message, a communication to the head end system.
Communication In Progress	<ul style="list-style-type: none"> • D1-CHKCHILD – Check Children Communications: This algorithm checks all of the outbound communications related to the activity and, if complete, will transition the activity.
Execute Completion Events	<ul style="list-style-type: none"> • D1-EXCMPEVTS – Execute Completion Events: This algorithm provides a mechanism for running completion events upon successful completion of the commissioning operation.

Outbound Communication — Itron - Add Meter Definition (Commission)

Business Object: D8-AddMeterDefinitionsDR

Schema

The portions of the schema that contain the payload of the web service request and response communications are the `sendDetail` element (constructed using the D8-AddMeterDefinitionsDRDA data area) and the `responseDetail` element (constructed using the D8-AddMeterDefRespDRDA data area). The XSLs used to create or decipher XML conforming to the Itron structure use these elements as a basis.

Lifecycle and Algorithms

The table below outlines some of the important algorithms used by the Add Meter Definition outbound communication.

Lifecycle State	Algorithms
Validate	<ul style="list-style-type: none">D1-VALCOMTP – Validate Communication Type: This algorithm ensures the communication type is populated on the communication.
Awaiting Response	<ul style="list-style-type: none">D8-PAMDSDDR – Itron - Populate Add Meter Definitions Send Detail - Direct Route: This algorithm constructs the <code>sendDetails</code> element used in the outbound request.D8-COUTMCMDR – Create Outbound Message for Commissioning / Decommissioning Direct Route: This algorithm determines the correct outbound message to create based upon the input processing role. The reply from the head end system will be stored in the <code>responseDetails</code> element and log entries will be created for the creation of the outbound message and the result (whether it is a success or a failure).
Response Error	<p>The business object will transition to this state if the reply indicates a failure.</p> <ul style="list-style-type: none">D8-RAMBOE – Itron - Retry Add Meter BO in Error: This algorithm provides a means to retry the communication in the event of an error.D8-CTDEBOEO – Itron - Create To Do Entry for BO in Error for Outbound: This algorithm creates a To Do entry in order to inform a user to take corrective action.D1-ALLOWTPA – Set Allow Transition Parent Activity Flag To True For Synchronous Outbound Communication: This algorithm conditionally allows the parent activity to transition to complete.
Create Completion Event	<ul style="list-style-type: none">D8-CRCDOMPE – Itron - Create Commission Device Completion Event: This algorithm creates a completion event to show the device as commissioned.
Completed	<ul style="list-style-type: none">D8-UCCFTPA – Itron - Update Commission Completion Flag: This algorithm notifies the parent command activity that the communication has completed.

Message Sender XSLs

Outbound messages created by Add Meter Definition outbound communication use the following XSL files:

- **Request XSL:** D8-CommissionRequest.xml
- **Response XSL:** D8-CommissionResponse.xml

Refer to [Creating Message Senders](#) for more information about creating message senders.

Itron Commissioning XSL Transformations

The Oracle Utilities Smart Grid Gateway Adapter for Itron OpenWay supports multiple versions of the Itron OpenWay API. To achieve this support, several of the request XSLs check a version number embedded in the source schema. Similarly, the responses XSLs are designed to handle different source XML and map the values to the common SGG format.

The Itron commissioning process uses the following XSL transformations.

D8-CommissionRequest.xml

```
<xsl:stylesheet version="1.0"
  xmlns:xsl="http://www.w3.org/1999/XSL/Transform"
  xmlns:xsi="http://www.w3.org/2001/XMLSchema-instance"
  xmlns:serArr="http://schemas.microsoft.com/2003/10/Serialization/Arrays"
  xmlns:prov390="http://www.itron.com/ami/2009/08/provisioning"
  xmlns:prov370="http://www.itron.com/ami/2008/10/provisioning">

  <xsl:output method="xml" encoding="UTF-8" omit-xml-declaration="yes" indent="yes"/>

  <xsl:template match="/*">
    <xsl:apply-templates select="./requestEnvelope/AddMeterDefinitions"/>
  </xsl:template>

  <xsl:template match="AddMeterDefinitions[../itronVersion='3.70']">
    <xsl:apply-templates select="." mode="Itr370"/>
  </xsl:template>

  <xsl:template match="AddMeterDefinitions[../itronVersion='3.90']">
    <xsl:apply-templates select="." mode="Itr390"/>
  </xsl:template>

  <xsl:template match="*[local-name() != 'string']" mode="Itr370">
    <xsl:element name="{local-name()}" namespace="http://www.itron.com/ami/2008/10/
provisioning">
      <xsl:apply-templates select="*|text()" mode="Itr370"/>
    </xsl:element>
  </xsl:template>

  <xsl:template match="*[local-name() != 'string']" mode="Itr390">
    <xsl:element name="{local-name()}" namespace="http://www.itron.com/ami/2009/08/
provisioning">
      <xsl:apply-templates select="*|text()" mode="Itr390"/>
    </xsl:element>
  </xsl:template>

  <xsl:template match="string" mode="Itr390">
    <xsl:element name="string" namespace="http://schemas.microsoft.com/2003/10/Serialization/
Arrays">
      <xsl:value-of select="."/>
    </xsl:element>
  </xsl:template>

  <xsl:template match="string" mode="Itr370">
    <xsl:element name="string" namespace="http://schemas.microsoft.com/2003/10/Serialization/
Arrays">
      <xsl:value-of select="."/>
    </xsl:element>
  </xsl:template>
```



```
</xsl:stylesheet>
```

D8-CommissionResponse.xsl

```
<xsl:stylesheet version="1.0"
  xmlns:xsl="http://www.w3.org/1999/XSL/Transform"
  xmlns:xsi="http://www.w3.org/2001/XMLSchema-instance"
  xmlns:serArr="http://schemas.microsoft.com/2003/10/Serialization/Arrays"
  xmlns:prov390="http://www.itron.com/ami/2009/08/provisioning"
  xmlns:prov370="http://www.itron.com/ami/2008/10/provisioning">

  <xsl:output method="xml" encoding="UTF-8" omit-xml-declaration="yes" indent="yes"/>

  <xsl:template match="/*">
    <xsl:apply-templates select="./requestEnvelope/AddMeterDefinitions"/>
  </xsl:template>

  <xsl:template match="AddMeterDefinitions[../itronVersion='3.70']">
    <xsl:apply-templates select="." mode="Itr370"/>
  </xsl:template>

  <xsl:template match="AddMeterDefinitions[../itronVersion='3.90']">
    <xsl:apply-templates select="." mode="Itr390"/>
  </xsl:template>

  <xsl:template match="*[local-name() != 'string']" mode="Itr370">
    <xsl:element name="{local-name()}" namespace="http://www.itron.com/ami/2008/10/
provisioning">
      <xsl:apply-templates select="*"|text()" mode="Itr370"/>
    </xsl:element>
  </xsl:template>

  <xsl:template match="*[local-name() != 'string']" mode="Itr390">
    <xsl:element name="{local-name()}" namespace="http://www.itron.com/ami/2009/08/
provisioning">
      <xsl:apply-templates select="*"|text()" mode="Itr390"/>
    </xsl:element>
  </xsl:template>

  <xsl:template match="string" mode="Itr390">
    <xsl:element name="string" namespace="http://schemas.microsoft.com/2003/10/Serialization/
Arrays">
      <xsl:value-of select="."/>
    </xsl:element>
  </xsl:template>

  <xsl:template match="string" mode="Itr370">
    <xsl:element name="string" namespace="http://schemas.microsoft.com/2003/10/Serialization/
Arrays">
      <xsl:value-of select="."/>
    </xsl:element>
  </xsl:template>
</xsl:stylesheet>
```

Asynchronous Commands

An asynchronous command is actually a collection of two or more synchronous commands. This type of command is useful when more than a few seconds will elapse before results can be collected and returned. A typical use case will begin with a Smart Grid Gateway request to start a job on the head end system. The initial request will contain enough data to initiate the process, such as a meter identifier or a date range. The response usually contains an identifier for the process started on the head end system. At some later time, a request will be initiated by the head end system. The request will contain the same process identifier so it can be linked to the original request. Some head end systems use this secondary request to indicate the status of the process. Other head end systems send the results of the process in the secondary request. Typically, the response message for either type of secondary request is a functional acknowledgement.

Example: Itron On-Demand Read Process

This section provides an example of an asynchronous command, the On-Demand Read command supported by the Itron OpenWay adapter.

The Itron `www.itron.com.ami.2008.10.data.wsdl` definition contains a series of commands for an On-Demand Read process. The Smart Grid Gateway adapter for Itron OpenWay initiates the process by invoking the `ContingencyReadByEndpoints` method. The reply contains a “request token ID” that identifies the entire flow and will be shared by subsequent communications. On the Itron side, a job for collecting usage and events is configured. To inform the caller (SGG) that the job is starting, Itron sends a `StatusChanged` request (defined in `www.itron.com.ami.2008.10.common.wsdl`) containing “State = Initialized”. Itron sends another `StatusChanged` request to notify SGG that the process of gathering the usage is underway. As the usage is collected, Itron submits one or more `DataArrived` requests to SGG. When Itron has finished making internal requests for usage, it sends a final `StatusChanged` request to SGG. That completion notification informs SGG that it should submit `GetContingencyReadByEndpointsResult`, the reply to which contains information about errors encountered during the process.

The image below illustrates the process flow used by this command.

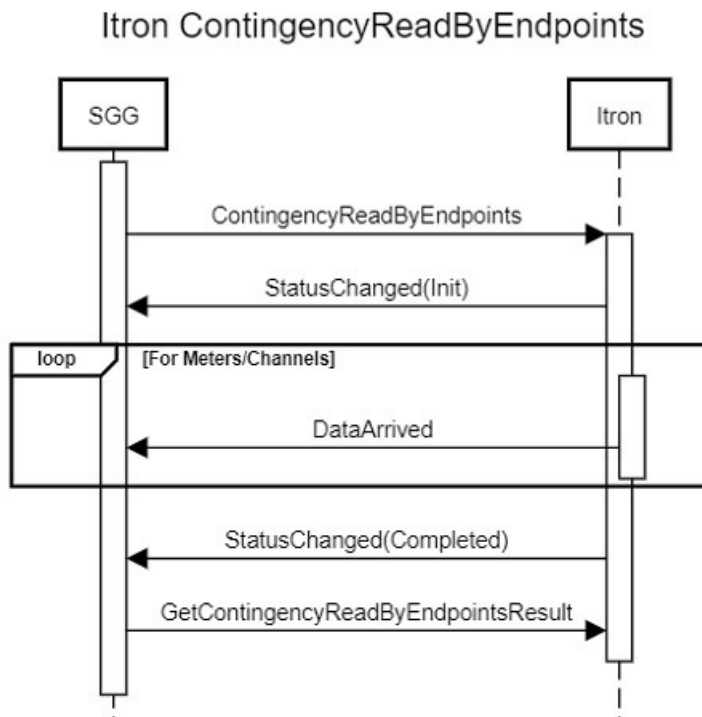

Below is a summary of the important features of the Smart Grid Gateway implementation of this command. Many of the concepts can be applied when creating a custom synchronous command.

Command Activity — On-Demand Read (Interval)

Business Object: D1-OnDemandReadInterval

Lifecycle and Algorithms

The table below outlines some of the important algorithms used by the On-Demand Read (Interval) command activity.

Lifecycle State**Algorithms**

Validate

The important features here are not the specific algorithms, but rather the ability to perform validation logic at a process level.

- D1-VALDEVMC – Validate that Device has appropriate Measuring Component: This algorithm ensures the device has at least one measuring component whose Measuring Component Type is registered as interval type
 - D1-VALIDCMD – Validate Headend's capability to perform On Demand Read (Interval): This algorithm checks whether the head end system has the capability to support an on-demand read request. If the command is supported, an outbound communication business object is returned.
 - D1-CHKMST – Check for existing Measurements: This algorithm checks whether complete measurements for the specified time period exist in the database already.
-

Connection Ready

- D1-CODRIOB – Create Outbound communication for OnDemandRead Interval: This algorithm creates an outbound communication business object based on the Processing Role and algorithm parameters. The algorithm will look up the outbound communication business object defined for the Processing Role parameter and create an instance of that business object. In the case of this business object, the parameter is D1IN and it should create an instance of the D8-ReadIntervalDR business object.

Once the Outbound Communication record is created, the Activity business object moves from the Connection Ready state to the Communication In Progress state. When the outbound communication is complete, it moves the Activity to next default state, which is Connection Ready (the activity moves from Communication In Progress *back* to Connection Ready). The outbound communication will also set the "isOnDemandReadComplete" flag value in the activity business object, in this case, indicating the outbound communication for a particular processing role was created. If the condition is true, the processing moves on to next algorithm.

- D1-CODRSRTOB – Create On Demand Read Results Outbound based on Completion Flag: This algorithm is the second algorithm in this state responsible for sending outbound communications. If the completion flag passed as a parameter is true, it will create the second outbound communication. In this example, it should create an instance of D8-ReadOnDemandReadResultDR to send a second request to Itron for the results of the Contingency Read operation.
-

Waiting for Measurement

- D1-RIINTM – Retrieve Interval Initial Measurements: This algorithm retrieves the most recent Initial Measurement Data for each interval measuring component for the period of the measurement requested.
-
-

Outbound Communication — Itron - Contingency Read (Interval)

Business Object: D8-ReadIntervalDR

Schema

The portions of the schema that contain the payload of the web service request and response communications are the `sendDetail` element (constructed using the D8-ContingencyReadRequestDR data area) and the `responseDetail` element (constructed using the D8-ContingencyReadResponDtIIDA data area). The XSLs used to create or decipher XML conforming to the Itron structure use these elements as a basis.

Lifecycle and Algorithms

The table below outlines some of the important algorithms used by the Contingency Read outbound communication.

Lifecycle State	Algorithms
Validate	<ul style="list-style-type: none">D1-VALCOMTP – Validate Communication Type: This algorithm ensures the communication type is populated on the communication.
Awaiting Response	<ul style="list-style-type: none">D8-PSDMRSCDR – Itron - Populate Send Detail for ContingencyReadByEndpoints Direct Route: This algorithm populates the <code>sendDetail</code> element with the needed items for the web service input.D8-COUTMINDR – Itron - Create Outbound Message Contingency Read (Interval): This algorithm determines the correct outbound message to create based upon the input processing role. The reply from the head end system will be stored in the <code>responseDetails</code> element and log entries will be created for the creation of the outbound message and the result (whether it is a success or a failure).
Response Error	<ul style="list-style-type: none">D8-RBORINTER – Itron - Retry Read Interval BO in Error: This algorithm provides a means to retry the communication in the event of an error.
Completed	<ul style="list-style-type: none">D1-UCFLAGTPA – Update On-Demand Read Completion Flag And Transition Parent Activity: If requirements are met, this algorithm sets the completion flag on the parent activity to “true” and transitions it to the next state.

Inbound Communication — Itron - StatusChanged

Business Object: D8-StatusChanged

This business object handles the inbound `StatusUpdate` requests. It contains the request token ID created by the initial request. When it receives schema values of “State = Completed” and Result of either Canceled or Success, it triggers the next command in the Activity. For `On-DemandRead`, the next command is `GetContingencyReadByEndpointsResult`.

Schema

Unlike other communications containing `sendDetail` or `responseDetail` elements, this business object contains an input element with child elements that map to the those within the `StatusChanged` XSD definition.

Lifecycle and Algorithms

The table below outlines some of the important algorithms used by the Status Changed Read inbound communication.

Lifecycle State	Algorithms
Validate	<ul style="list-style-type: none">D8-IDNPOCAA – Find Parent Outbound Communication For Async Inbound: This algorithm finds the initial outbound communication associated with the current inbound communication using the request token id.
Evaluate Response	<ul style="list-style-type: none">D8-EVALSTCHG – Itron - Evaluate Response for StatusChanged: This algorithm performs a task based on the values of the arriving StatusChanged request. If the Status is Completed and the Result is Success or Failure, the parent outbound communication is completed. This alerts the activity to initiate the next outbound communication.

Outbound Communication — Itron - On Demand Read Result

Business Object: D8-ReadOnDemandReadResultDR

This is the second of two outbound requests within the Itron Contingency Read API. The outbound request submits the request token ID. The response contains error information collected by the Itron server during the execution of the Contingency Read process.

Schema

The portions of the schema that contain the payload of the web service request and response communications are the `sendDetail` element (constructed using the D8-ReadODRRResultRequestDR data area) and the `responseDetail` element (constructed using the D8-ReadODRRResultResponseDR data area). The XSLs used to create or decipher XML conforming to the Itron structure use these elements as a basis.

Lifecycle and Algorithms

The table below outlines some of the important algorithms used by the On-Demand Read Result outbound communication.

Lifecycle State	Algorithms
Awaiting Response	<ul style="list-style-type: none">D8-PSDODRRDR – Itron - Populate OnDemand Read Result Send Details: This algorithm populate the <code>sendDetail</code> element for the outbound message. Primarily, this consists of the request token ID.D8-CODRROBDR – Create Outbound Message for On Demand Read Result: This algorithm determines the correct outbound message to create based upon the input Processing Role. The reply from the head end system will be stored in the <code>responseDetails</code> element and log entries will be created for the creation of the outbound message and the result (whether it is a success or a failure).
Evaluate Response	<ul style="list-style-type: none">D8-EVODRRSLT – Create Outbound Message for On Demand Read Result: This algorithm evaluates the response from Itron and determines whether the command was successful or was a failure.

-
- **D8-VDVCMCDR** – Validate if Device has appropriate Measuring Component: This algorithm performs a check to ensure that the reading has a proper measuring component.
-
-

Service Script: Itron - DataArrived Request

This Groovy—based service script handles the incoming DataArrived requests. It saves the payload to file storage locations (including Cloud Object Storage buckets in the case of cloud implementations) based on configuration.

Schema

The schema maps closely to the Itron DataArrived message. It includes the D8-DataArrived data area.

Steps

Step 10 Edit Data – Invoke Main Groovy Method

This step shows how to trigger a Groovy script from other OUAF objects. It is similar to a main method in other programming languages. In this case, it is called by an Inbound Web Service method.

Step 20 – Groovy Imports

This step imports other classes needed by the script.

Step 30 – Groovy Members

1. Look up the Master Configuration object
2. Use the Master Configuration to find the File Storage details
 - a. Find the File Adapter type
 - b. Compute a filename using a configured generation script
 - c. Compute a fill URL using the bucket, filename, and other details
3. Use the FileStorageAdapter business service to save the file to the targeted location.

Message Sender XSLs

Outbound messages created by on-demand read outbound communications use the following XSL files:

ContingencyReadByEndpoints

- **Request XSL:** D8-ContingencyReadByEndpointsRequest.xml
- **Response XSL:** D8-ContingencyReadByEndpointsResponse.xml

GetContingencyReadByEndpointsResult

- **Request XSL:** D8-GetContingencyReadByEndpointsResultRequest.xml
- **Response XSL:** D8-GetContingencyReadByEndpointsResultResponse.xml

Refer to [Creating Message Senders](#) for more information about creating message senders.

Inbound Web Services

The Itron on-demand read process uses the following inbound web services.

D8-RequestStatusChangedService

- **Operation Name:** StatusChanged
- **Schema Name:** Itron — Status Changed BO
- **Request XSL:** D8-RequestStatusChangedServiceRequest.xml
- **Response XSL:** D8-RequestStatusChangedServiceResponse.xml

D8-DataSubscriberService

- **Operation Name:** DataArrived
- **Schema Name:** Itron — DataArrived Request Script
- **Request XSL:** D8-DataSubscriberServiceRequest.xml
- **Response XSL:** D8-DataSubscriberServiceResponse.xml

Itron On-Demand Read XSL Transformations

The Oracle Utilities Smart Grid Gateway Adapter for Itron OpenWay supports multiple versions of the Itron OpenWay API. To achieve this support, several of the request XSLs check a version number embedded in the source schema. Similarly, the responses XSLs are designed to handle different source XML and map the values to the common SGG format.

The Itron on-demand read process uses the following XSL transformations.

D8-ContRdByEndptsRequest.xml

```
<xsl:stylesheet version="1.0"
  xmlns:xsl="http://www.w3.org/1999/XSL/Transform"
  xmlns:xsi="http://www.w3.org/2001/XMLSchema-instance"
  xmlns:ns1="http://www.itron.com/ami/2008/10/data"
  xmlns:ns2="http://www.itron.com/ami/2008/10/common"
  xmlns:ns3="http://schemas.microsoft.com/2003/10/Serialization/Arrays">

  <xsl:output method="xml" encoding="UTF-8" omit-xml-declaration="yes" indent="yes"/>

  <xsl:template match="/*">
    <ContingencyReadByEndpoints xmlns="http://www.itron.com/ami/2008/10/data">
      <xsl:apply-templates select="./requestEnvelope/ContingencyReadByEndpoints/*"/>
    </ContingencyReadByEndpoints>
  </xsl:template>

  <xsl:template match="ElectronicSerialNumbers">
    <xsl:element name="ns2:ElectronicSerialNumbers">
      <xsl:for-each select="./string">
        <xsl:element name="ns3:string">
          <xsl:value-of select="."/>
        </xsl:element>
      </xsl:for-each>
    </xsl:element>
  </xsl:template>

  <xsl:template match="StatusChangedService">
    <xsl:element name="ns2:StatusChangedService">
      <xsl:value-of select="."/>
    </xsl:element>
  </xsl:template>

  <xsl:template match="Parameters">
    <ns1:Parameters>
      <ns1:ReadingStartTime><xsl:value-of select="./ReadingStartTime"/></
ns1:ReadingStartTime>
```

```

        <ns1:ReadingEndTime><xsl:value-of select="./ReadingEndTime" /></ns1:ReadingEndTime>
        <xsl:if test="string-length(./PerformDemandReset) > 0">
            <ns1:PerformDemandReset><xsl:value-of select="./PerformDemandReset" /></
ns1:PerformDemandReset>
        </xsl:if>
        <xsl:if test="string-length(./RetrieveHomeNetworkData) > 0">
            <ns1:RetrieveHomeNetworkData><xsl:value-of select="./RetrieveHomeNetworkData" /></
ns1:RetrieveHomeNetworkData>
        </xsl:if>
        <xsl:if test="string-length(./RetrieveInstantaneousData) > 0">
            <ns1:RetrieveInstantaneousData><xsl:value-of select="./
RetrieveInstantaneousData" /></ns1:RetrieveInstantaneousData>
        </xsl:if>
        <xsl:if test="string-length(./RetrieveLastDemandReset) > 0">
            <ns1:RetrieveLastDemandReset><xsl:value-of select="./RetrieveLastDemandReset" /></
ns1:RetrieveLastDemandReset>
        </xsl:if>
        <xsl:if test="string-length(./RetrieveLoadProfileData) > 0">
            <ns1:RetrieveLoadProfileData><xsl:value-of select="./RetrieveLoadProfileData" /></
ns1:RetrieveLoadProfileData>
        </xsl:if>
        <xsl:if test="string-length(./RetrieveLogEvents) > 0">
            <ns1:RetrieveLogEvents><xsl:value-of select="./RetrieveLogEvents" /></
ns1:RetrieveLogEvents>
        </xsl:if>
        <xsl:if test="string-length(./RetrieveNetworkStatistics) > 0">
            <ns1:RetrieveNetworkStatistics><xsl:value-of select="./
RetrieveNetworkStatistics" /></ns1:RetrieveNetworkStatistics>
        </xsl:if>
        <xsl:if test="string-length(./RetrievePriorSelfRead) > 0">
            <ns1:RetrievePriorSelfRead><xsl:value-of select="./RetrievePriorSelfRead" /></
ns1:RetrievePriorSelfRead>
        </xsl:if>
        <xsl:if test="string-length(./RetrieveRecentRegisters) > 0">
            <ns1:RetrieveRecentRegisters><xsl:value-of select="./RetrieveRecentRegisters" /></
ns1:RetrieveRecentRegisters>
        </xsl:if>
        <xsl:if test="string-length(./RetrieveVoltageMonitorData) > 0">
            <ns1:RetrieveVoltageMonitorData><xsl:value-of select="./
RetrieveVoltageMonitorData" /></ns1:RetrieveVoltageMonitorData>
        </xsl:if>
        <xsl:if test="string-length(./ReportSelfReadOption) > 0">
            <ns1:ReportSelfReadOption><xsl:value-of select="./ReportSelfReadOption" /></
ns1:ReportSelfReadOption>
        </xsl:if>
        <xsl:if test="string-length(./RetrieveExtendedCurrentData) > 0">
            <ns1:RetrieveExtendedCurrentData><xsl:value-of select="./
RetrieveExtendedCurrentData" /></ns1:RetrieveExtendedCurrentData>
        </xsl:if>
        <xsl:if test="string-length(./RetrievePriorExtendedSelfReadData) > 0">
            <ns1:RetrievePriorExtendedSelfReadData><xsl:value-of select="./
RetrievePriorExtendedSelfReadData" /></ns1:RetrievePriorExtendedSelfReadData>
        </xsl:if>
        <xsl:if test="string-length(./RetrieveInstrumentationProfileData) > 0">
            <ns1:RetrieveInstrumentationProfileData><xsl:value-of select="./
RetrieveInstrumentationProfileData" /></ns1:RetrieveInstrumentationProfileData>
        </xsl:if>
        <xsl:if test="string-length(./RetrieveExtendedLoadProfileData) > 0">
            <ns1:RetrieveExtendedLoadProfileData><xsl:value-of select="./
RetrieveExtendedLoadProfileData" /></ns1:RetrieveExtendedLoadProfileData>
        </xsl:if>
        <xsl:if test="string-length(./RetrieveToolboxData) > 0">
            <ns1:RetrieveToolboxData><xsl:value-of select="./RetrieveToolboxData" /></
ns1:RetrieveToolboxData>
        </xsl:if>
        <xsl:if test="string-length(./RetrieveTemperatureMonitoringData) > 0">
            <ns1:RetrieveTemperatureMonitoringData><xsl:value-of select="./
RetrieveTemperatureMonitoringData" /></ns1:RetrieveTemperatureMonitoringData>
        </xsl:if>
    </ns1:Parameters>
</xsl:template>

```



```

    <xsl:template match="*">
      <xsl:element name="{local-name()}" namespace="http://www.itron.com/ami/2008/10/data">
        <xsl:apply-templates select="*|text()"/>
      </xsl:element>
    </xsl:template>
  </xsl:stylesheet>

```

D8-ContRdByEndptsResponse.xsl

```

<xsl:stylesheet
  version="1.0"
  xmlns:xsl="http://www.w3.org/1999/XSL/Transform"
  xmlns:env="http://schemas.xmlsoap.org/soap/envelope/"
  xmlns:ns1="http://www.itron.com/ami/2008/10/data"
  xmlns:com="http://www.itron.com/ami/2008/10/common"
  exclude-result-prefixes="env ns1 com">

  <xsl:output method="xml" encoding="utf-8" indent="yes"/>

  <xsl:template match="env:Envelope">
    <xsl:apply-templates select="./env:Body/*"/>
  </xsl:template>

  <xsl:template match="ns1:ContingencyReadByEndpointsResponse">
    <responseDetail>
      <responseEnvelope>
        <ContingencyReadByEndpointsResponse>
          <xsl:apply-templates select=".*"/>
        </ContingencyReadByEndpointsResponse>
      </responseEnvelope>
    </responseDetail>
  </xsl:template>

  <xsl:template match="env:Fault[./detail/*[contains('|OperationFault|NoValidTargetsFoundFault|
  InvalidUriFormatFault|InvalidDateTimeRangeFault|ArgumentFault|TooManyConcurrentRequestsFault|
  SecurityFault|', concat('|',local-name(),'|'))]]">
    <fault>
      <xsl:apply-templates select="./detail/*"/>
    </fault>
  </xsl:template>

  <xsl:template match="env:Fault">
    <fault>
      <xsl:apply-templates select=".*"/>
    </fault>
  </xsl:template>

  <xsl:template match="detail">
    <detail><xsl:apply-templates select=".*" mode="serialize"/></detail>
  </xsl:template>

  <xsl:template match="*">
    <xsl:variable name="name">
      <xsl:value-of select="local-name()"/>
    </xsl:variable>
    <xsl:element name="{ $name }" namespace="">
      <xsl:apply-templates select="*|text()"/>
    </xsl:element>
  </xsl:template>

  <xsl:template match="*" mode="serialize">
    <xsl:text><</xsl:text>
    <xsl:value-of select="local-name()"/>
    <xsl:for-each select="@*">

```

```

        <xsl:value-of select="concat(' ', local-name())"/>
        <xsl:text>=</xsl:text>
        <xsl:value-of select="."/>
        <xsl:text></xsl:text>
    </xsl:for-each>
    <xsl:text>></xsl:text>
    <xsl:apply-templates select="*" mode="serialize"/>
    <xsl:value-of select="."/>
    <xsl:text></xsl:text>
    <xsl:value-of select="local-name()"/>
    <xsl:text>></xsl:text>
</xsl:template>
</xsl:stylesheet>

```

D8-GetContRdByEndptsRsReq.xsl

```

<xsl:stylesheet version="1.0"
  xmlns:xsl="http://www.w3.org/1999/XSL/Transform"
  xmlns:xsi="http://www.w3.org/2001/XMLSchema-instance"
  xmlns:ns1="http://www.itron.com/ami/2008/10/data"
  xmlns:ns2="http://www.itron.com/ami/2008/10/common">

  <xsl:output method="xml" encoding="UTF-8" omit-xml-declaration="yes" indent="yes"/>

  <xsl:template match="/*">
    <GetContingencyReadByEndpointsResult xmlns="http://www.itron.com/ami/2008/10/data">
      <xsl:apply-templates select="./requestEnvelope/GetContingencyReadByEndpointsResult/*" />
    </GetContingencyReadByEndpointsResult>
  </xsl:template>

  <xsl:template match="Id">
    <xsl:element name="ns2:Id">
      <xsl:value-of select="."/>
    </xsl:element>
  </xsl:template>

  <xsl:template match="*">
    <xsl:element name="{local-name()}" namespace="http://www.itron.com/ami/2008/10/data">
      <xsl:apply-templates select="*|text()"/>
    </xsl:element>
  </xsl:template>
</xsl:stylesheet>

```

D8-GetContRdByEndptsRsResp.xsl

```

<xsl:stylesheet
  version="1.0"
  xmlns:xsl="http://www.w3.org/1999/XSL/Transform"
  xmlns:env="http://schemas.xmlsoap.org/soap/envelope/"
  xmlns:ns1="http://www.itron.com/ami/2008/10/data"
  xmlns:com="http://www.itron.com/ami/2008/10/common"
  exclude-result-prefixes="env ns1 com">

  <xsl:output method="xml" encoding="utf-8" indent="yes"/>

  <xsl:template match="env:Envelope">
    <xsl:apply-templates select="./env:Body/*"/>
  </xsl:template>

  <xsl:template match="ns1:GetContingencyReadByEndpointsResultResponse">
    <responseDetail>
      <responseEnvelope>
        <GetContingencyReadByEndpointsResultResponse>
          <xsl:apply-templates select=".*"/>
        </GetContingencyReadByEndpointsResultResponse>
      </responseEnvelope>
    </responseDetail>
  </xsl:template>

```

```

<xsl:template match="*">
<xsl:variable name="name">
  <xsl:value-of select="local-name()"/>
</xsl:variable>
<xsl:element name="{ $name }" namespace="">
  <xsl:apply-templates select="*" | text()"/>
</xsl:element>
</xsl:template>

<xsl:template match="env:Fault[./detail/*[contains(' |OperationFault |RequestNotFoundFault |
RequestNotFinishedFault |ArgumentFault |TooManyConcurrentRequestsFault |
SecurityFault|', concat('|',local-name(),'|'))]]">
  <fault>
<xsl:apply-templates select="./detail/*"/>
</fault>
</xsl:template>

<xsl:template match="env:Fault">
<fault>
<xsl:apply-templates select=".*"/>
</fault>
</xsl:template>

<xsl:template match="detail">
  <detail><xsl:apply-templates select=".*" mode="serialize"/></detail>
</xsl:template>

<xsl:template match="*" mode="serialize">
  <xsl:text><</xsl:text>
  <xsl:value-of select="local-name()"/>
  <xsl:for-each select="@*">
    <xsl:value-of select="concat(' ', local-name())"/>
    <xsl:text>="</xsl:text>
    <xsl:value-of select="."/>
    <xsl:text>"</xsl:text>
  </xsl:for-each>
  <xsl:text>></xsl:text>
  <xsl:apply-templates select="*" mode="serialize"/>
  <xsl:value-of select="."/>
  <xsl:text></xsl:text>
  <xsl:value-of select="local-name()"/>
  <xsl:text>></xsl:text>
</xsl:template>

</xsl:stylesheet>

```

D8-DataSubSvcRequest.xsl

```

<xsl:stylesheet version="1.0"
  xmlns:xsl="http://www.w3.org/1999/XSL/Transform"
  xmlns:soap11="http://schemas.xmlsoap.org/soap/envelope/"
  xmlns:soap12="http://www.w3.org/2003/05/soap-envelope"
  xmlns:data="http://www.itron.com/ami/2008/10/data"
  xmlns:com="http://www.itron.com/ami/2008/10/common"
  xmlns:ev="http://www.itron.com/ami/2008/10/events"
  xmlns:xsi="http://www.w3.org/2001/XMLSchema-instance"
  exclude-result-prefixes="data com ev soap11 soap12">

  <xsl:template match="soap11:Envelope">
    <xsl:apply-templates select="//data:DataArrived"/>
  </xsl:template>

  <xsl:template match="soap11:Body">
    <xsl:apply-templates select="//data:DataArrived"/>
  </xsl:template>

  <xsl:template match="data:DataArrived">
    <DataArrived>

```

```

    <input>
      <RequestToken>
        <Id><xsl:value-of select="./data:input/data:RequestToken/com:Id"/></Id>
      </RequestToken>
      <ReadDataCollection>
        <xsl:for-each select="./data:input/data:ReadDataCollection/data:ReadData">
          <ReadData>
            <Identifier><xsl:value-of select="./data:Identifier"/></Identifier>
            <DeviceClass><xsl:value-of select="./data:DeviceClass"/></
DeviceClass>
            <ScalingType><xsl:value-of select="./data:ScalingType"/></
ScalingType>
            <xsl:call-template name="EventLog"/>
            <xsl:call-template name="LoadProfileChannels"/>
            <xsl:call-template name="NetworkStatistics"/>
            <xsl:call-template name="RegisterValues"/>
            <xsl:call-template name="BlockInfo"/>
            <xsl:if test="./data:DeviceSerialNumber">
              <DeviceSerialNumber><xsl:value-of select="./
data:DeviceSerialNumber"/></DeviceSerialNumber>
            </xsl:if>
          </ReadData>
        </xsl:for-each>
      </ReadDataCollection>
      <xsl:if test="count(./data:input/data:RequestMetadata/*) > 0">
        <RequestMetadata>
          <xsl:copy-of select="./data:input/data:RequestMetadata/*"/>
        </RequestMetadata>
      </xsl:if>
    </input>
  </DataArrived>
</xsl:template>

  <xsl:template name="EventLog">
    <xsl:if test="count(./data:EventLog/ev:MeterEvents/*) > 0 or count(./data:EventLog/
ev:UnreportedEventCount) > 0">
      <EventLog>
        <xsl:if test="count(./data:EventLog/ev:MeterEvents/*) > 0">
          <MeterEvents>
            <xsl:for-each select="./data:EventLog/ev:MeterEvents/ev:MeterEvent">
              <MeterEvent>
                <Timestamp><xsl:value-of select="./ev:Timestamp"/></Timestamp>
                <Category><xsl:value-of select="./ev:Category"/></Category>
                <LogType><xsl:value-of select="./ev:LogType"/></LogType>
                <Name><xsl:value-of select="./ev:Name"/></Name>
                <xsl:if test="count(./ev:Arguments/*) > 0">
                  <Arguments>
                    <xsl:for-each select="./ev:Arguments/ev:Argument">
                      <Argument>
                        <Name><xsl:value-of select="./ev:Name"/></Name>
                        <Value><xsl:value-of select="./ev:Value"/></
Value>
                      </Argument>
                    </xsl:for-each>
                  </Arguments>
                </xsl:if>
                <xsl:if test="./ev:ID">
                  <ID><xsl:value-of select="./ev:ID"/></ID>
                </xsl:if>
                <xsl:if test="./ev:Source">
                  <Source><xsl:value-of select="./ev:Source"/></Source>
                </xsl:if>
                <xsl:if test="./ev:SequenceNumber">
                  <SequenceNumber><xsl:value-of select="./ev:SequenceNumber"/
></SequenceNumber>
                </xsl:if>
              </MeterEvent>
            </xsl:for-each>
          </MeterEvents>
        </xsl:if>
      <xsl:if test="./data:EventLog/ev:UnreportedEventCount">

```

```

        <UnreportedEventCount><xsl:value-of select="./data:EventLog/
ev:UnreportedEventCount"/></UnreportedEventCount>
    </xsl:if>
    </EventLog>
</xsl:if>
</xsl:template>

<xsl:template name="LoadProfileChannels">
    <xsl:if test="count(./data:LoadProfileChannels/data:LoadProfileChannel/
data:IntervalLength) > 0">
        <LoadProfileChannels>
            <xsl:for-each select="./data:LoadProfileChannels/data:LoadProfileChannel">
                <LoadProfileChannel>
                    <IntervalLength><xsl:value-of select="./data:IntervalLength"/></
IntervalLength>
                    <PulseMultiplier><xsl:value-of select="./data:PulseMultiplier"/></
PulseMultiplier>
                    <Quantity><xsl:value-of select="./data:Quantity"/></Quantity>
                    <TimeDataEnd><xsl:value-of select="./data:TimeDataEnd"/></TimeDataEnd>
                    <IntervalValues>
                        <xsl:for-each select="./data:IntervalValues/data:IntervalValue">
                            <IntervalValue>
                                <ChannelValue><xsl:value-of select="./data:ChannelValue"/></
ChannelValue>
                                <xsl:for-each select="./data:ProfileStatuses/
data:ProfileStatus">
                                    <ProfileStatuses>
                                        <ProfileStatus><xsl:value-of select="."/></
ProfileStatus>
                                    </ProfileStatuses>
                                </xsl:for-each>
                            </IntervalValue>
                        </xsl:for-each>
                    </IntervalValues>
                </LoadProfileChannel>
            </xsl:for-each>
        </LoadProfileChannels>
    </xsl:if>
</xsl:template>

<xsl:template name="NetworkStatistics">
    <xsl:if test="count(./data:NetworkStatistics/data:NetworkStatistic/data:Name) > 0">
        <NetworkStatistics>
            <xsl:for-each select="./data:NetworkStatistics/data:NetworkStatistic">
                <NetworkStatistic>
                    <Name><xsl:value-of select="./data:Name"/></Name>
                    <NetworkKind><xsl:value-of select="./data:NetworkKind"/></NetworkKind>
                    <Value><xsl:value-of select="./data:Value"/></Value>
                </NetworkStatistic>
            </xsl:for-each>
        </NetworkStatistics>
    </xsl:if>
</xsl:template>

<xsl:template name="RegisterValues">
    <xsl:if test="count(./data:RegisterValues/data:RegisterValue/data:Quantity) > 0">
        <RegisterValues>
            <xsl:for-each select="./data:RegisterValues/data:RegisterValue">
                <RegisterValue>
                    <Quantity><xsl:value-of select="./data:Quantity"/></Quantity>
                    <Source><xsl:value-of select="./data:Source"/></Source>
                    <Timestamp><xsl:value-of select="substring(./data:Timestamp, 1, 19)"/></
Timestamp>
                    <Value><xsl:value-of select="./data:Value"/></Value>
                    <xsl:if test="count(./data:Status/data:string) > 0">
                        <Status>
                            <xsl:for-each select="./data:Status/data:string">
                                <string><xsl:value-of select="."/></string>
                            </xsl:for-each>
                        </Status>
                    </xsl:if>
                </RegisterValue>
            </xsl:for-each>
        </RegisterValues>
    </xsl:if>
</xsl:template>

```

```

                </Status>
            </xsl:if>
        </RegisterValue>
    </xsl:for-each>
</RegisterValues>
</xsl:if>
</xsl:template>

<xsl:template name="BlockInfo">
    <xsl:if test="count(./data:BlockInfo/data:Block) > 0">
        <BlockInfo>
            <Block><xsl:value-of select="./data:BlockInfo/data:Block"/></Block>
            <TotalBlocks><xsl:value-of select="./data:BlockInfo/data:TotalBlocks"/></
TotalBlocks>
        </BlockInfo>
    </xsl:if>
</xsl:template>

<!-- When the SOAP Message has already been transformed by the SOAP Proxy -->
<xsl:template match="DataArrived[namespace-uri(.) != 'http://www.itron.com/ami/2008/10/
data']">
    <xsl:copy-of select="."/>
</xsl:template>
</xsl:stylesheet>

```

D8-DataSubSvcResponse.xsl

```

<xsl:stylesheet version="1.0"
    xmlns:xsl="http://www.w3.org/1999/XSL/Transform"
    xmlns:soap11="http://schemas.xmlsoap.org/soap/envelope/"
    xmlns:tns="http://www.itron.com/ami/2008/10/data">

    <xsl:template match="/">
        <soap11:Envelope>
            <soap11:Header/>
            <soap11:Body>
                <tns:DataArrivedResponse/>
            </soap11:Body>
        </soap11:Envelope>
    </xsl:template>
</xsl:stylesheet>

```

D8-ReqStsChgSvcRequest.xsl

```

<xsl:stylesheet version="1.0"
    xmlns:xsl="http://www.w3.org/1999/XSL/Transform"
    xmlns:soap11="http://schemas.xmlsoap.org/soap/envelope/"
    xmlns:soap12="http://www.w3.org/2003/05/soap-envelope"
    xmlns:com="http://www.itron.com/ami/2008/10/common"
    exclude-result-prefixes="soap11 soap12 com">

    <xsl:template match="soap11:Envelope">
        <xsl:apply-templates select="//com:StatusChanged"/>
    </xsl:template>

    <xsl:template match="soap11:Body">
        <xsl:apply-templates select="//com:StatusChanged"/>
    </xsl:template>

    <xsl:template match="com:StatusChanged">
        <StatusChanged>
            <bo/>
            <input>
                <RequestStatus>
                <RequestToken>

```

```

        <Id><xsl:value-of select="./com:input/com:RequestStatus/com:RequestToken/
com:Id"/></Id>
        </RequestToken>
        <State><xsl:value-of select="./com:input/com:RequestStatus/com:State"/></
State>
        <EndpointsScheduled><xsl:value-of select="./com:input/com:RequestStatus/
com:EndpointsScheduled"/></EndpointsScheduled>
        <Result><xsl:value-of select="./com:input/com:RequestStatus/com:Result"/></
Result>
        <SuccessfulEndpoints><xsl:value-of select="./com:input/com:RequestStatus/
com:SuccessfulEndpoints"/></SuccessfulEndpoints>
        <FailedEndpoints><xsl:value-of select="./com:input/com:RequestStatus/
com:FailedEndpoints"/></FailedEndpoints>
        <xsl:if test="string-length(./com:input/com:RequestStatus/
com:CreatedWhen) > 0">
            <CreatedWhen><xsl:value-of select="substring(./com:input/
com:RequestStatus/com:CreatedWhen, 1, 23)"/></CreatedWhen>
        </xsl:if>
        <xsl:if test="string-length(./com:input/com:RequestStatus/
com:FinishedWhen) > 0">
            <FinishedWhen><xsl:value-of select="substring(./com:input/
com:RequestStatus/com:FinishedWhen, 1, 23)"/></FinishedWhen>
        </xsl:if>
        <xsl:if test="count(./com:input/com:RequestStatus/com:Metadata/*) > 0">
            <Metadata>
                <xsl:copy-of select="./com:input/com:RequestStatus/com:Metadata/*"/>
            </Metadata>
        </xsl:if>
    </RequestStatus>
</input>
</StatusChanged>
</xsl:template>

<!-- When the SOAP Message has already been transformed by the SOAP Proxy -->
<xsl:template match="StatusChanged[namespace-uri(.) != 'http://www.itron.com/ami/2008/10/
common']">
    <xsl:copy-of select="."/>
</xsl:template>

</xsl:stylesheet>

```

D8-RequestStatusChangedServiceResponse.xsl

```

<xsl:stylesheet version="1.0"
    xmlns:xsl="http://www.w3.org/1999/XSL/Transform"
    xmlns:soap11="http://schemas.xmlsoap.org/soap/envelope/"
    xmlns:tns="http://www.itron.com/ami/2008/10/common">

    <xsl:template match="/">
        <soap11:Envelope>
            <soap11:Header/>
            <soap11:Body>
                <tns:StatusChangedResponse/>
            </soap11:Body>
        </soap11:Envelope>
    </xsl:template>

</xsl:stylesheet>

```

Adapter Development Kit - Common Information Model Commands

This section describes how the Oracle Utilities Smart Grid Gateway Adapter Development Kit can be configured to process smart meter commands in the Common Information Model (CIM) format.

CIM Commands Introduction and Overview

The Adapter Development Kit supports smart meter commands in the Common Information Model (CIM) format. The CIM formats and standards supported by the Adapter Development Kit are based on the International Standard (IEC 61968-9, Edition 2.0), available [here](#). Reference to specific data elements from the CIM command messages used in this section are based on this document. Refer to this document for detailed information about the CIM commands.

Adapter Development Kit CIM Command Flows

The table below lists the communication flows used with Common Information Model (CIM) commands, including:

- **Command:** The specific smart meter command
- **Outbound Communication:** The outbound communication business object created by the command. This sends the command request to the head end system.
- **Inbound Communication:** The inbound communication created by the response from the head end system
- **Completion Event:** The completion event(s) triggered by the command, if any. Completion events are used to update data in the system as a result of a smart meter command. For example, if a command changes the status of a device, the completion event is responsible for making that change.

Command	Outbound Communication	Inbound Communication	Completion Event
Device Status Check	ADK CIM Ping Direct Route (DG-CIMPingDR)	ADK CIM Ping Response Direct Route (DG-CIMPingResponseDR)	
On-Demand Read (Interval) [CIM]	ADK CIM On-Demand Read Direct Route (Interval) (DG-CIMGetMtrReadIntervalDR)	ADK CIM On-Demand Read Response Direct Route (DG-CIMMtrReadResponseDR)	Create IMD Completion Event
On-Demand Read (Scalar) [CIM]	ADK CIM On-Demand Read Direct Route (Scalar) (DG-CIMGetMtrReadScalarDR)	ADK CIM On-Demand Read Response Direct Route (DG-CIMMtrReadResponseDR)	Create IMD Completion Event

Configuring Command Types

The following communication business objects (from the table above) all have corresponding communication types that must be configured before communications based on those business objects can be created. The table below lists the communication type business objects used with each.

Communication Business Object	Communication Type Business Object
ADK CIM Ping Direct Route (DG-CIMPingDR)	ADK - CIM Ping DR Type (DG-CIMPingDRType)
ADK CIM Ping Response Direct Route (DG-CIMPingResponseDR)	ADK - CIM Ping Async Response DR Type (DG-CIMPingResponseDRType)
ADK CIM On-Demand Read Direct Route (Interval) (DG-CIMGetMtrReadIntervalDR)	ADK - CIM On-Demand Read (Interval) DR Type (DG-CIMGetMtrReadIntervalType)
ADK CIM On-Demand Read Direct Route (Scalar) (DG-CIMGetMtrReadScalarDR)	ADK - CIM On-Demand Read (Scalar) DR Type (DG-CIMGetMtrReadScalarType)
ADK CIM On-Demand Read Response Direct Route (DG-CIMMtrReadResponseDR)	ADK - CIM AsyncReply MeterReads DR Type (DG-CIMMtrReadResponseDRType)

Refer to [Communication Types](#) for more information about communication types.

CIM Command Extendable Lookups

Processing of CIM commands requires configuration of values for a number of extendable lookups. This topic outlines the extendable lookups used with processing CIM commands.

Payload Processing Extendable Lookups

Processing of measurement data returned via on-demand read commands requires configuration of values for the following extendable lookups:

- **Unit of Measure Mapping:** Unit of measure mapping is based on the ReadingType string in the CIM payload and uses the ADK - UOM Code to Standard UOM Mapping (DG-HeadendUOMLookup) extendable lookup.
- **Interval Size Mapping:** Interval size (expressed as seconds per interval or SPI) mapping is based on the measuringPeriod value extracted from the ReadingType string and uses the ADK CIM Measuring Period Lookup (DG-CIMMeasuringPeriodLookup) extendable lookup.
- **Condition Code Mapping:** Condition code mapping is based on the ReadingQualityType string in the CIM payload (if present) and uses the the ADK - Interval Sts Code to Cond Map (DG-IntStsCodeToCondMapLookup) extendable lookup.

See [CIM Payload Processing Data Mapping and Extendable Lookups](#) for more information about these extendable lookups.

ADK CIM Header Verb Lookup

The ADK CIM Header Verb Lookup (DG-CIMHeaderVerbLookup) extendable lookup defines values for message type verbs used in CIM messages. Refer to Annex A in the [International Standard document](#) (LINK) for detailed information about verbs. This extendable lookup is pre-populated with values from the International Standard document.

ADK CIM Reply Code Lookup

The ADK CIM Reply Code Lookup (DG-CIMReplyCodeLookup) extendable lookup contains the enumeration of the values in the Reply / Error / Code element in replies from the head end system. The values are defined in Annex B in the [International Standard document](#) (LINK). Values comprise two numbers separated by a dot. Example: ReplyCode = <ReplyCode Category> "." <ReplyCode Index>

This extendable lookup is pre-populated with values from **Table B.10 – Common enumerations** in the International Standard document.

ADK CIM Reply Result Lookup

The ADK CIM Reply Result Lookup (DG-CIMResponseReplyRsltLookup) extendable lookup contains the enumeration of the values for the Reply.Result value returned from the head end system. This extendable lookup is pre-populated with values from the International Standard document (Refer to Annex B).

ADK CIM Data Source Extendable Lookup

The ADK CIM Data Source Extendable Lookup (DG-DataSourceLookup) extendable lookup is used to map descriptions to data sources defined in the head end system. Each value defined for the CIM Data Source extendable lookup should include the following:

- **Data Source:** The CIM code for the data source
- **Description:** A description of the data source
- **Status:** The status of the lookup value (can be Active or Inactive)

This extendable lookup is pre-populated with two values : AMI and Database.

Sending CIM Command Outbound Communications

This topic describes the configuration required to process (CIM) outbound communications.

Adapter Development Kit CIM Outbound Message Types

Outbound message types must be configured for each command you plan to use in your implementation. The base package includes a set of outbound message types that can be used.

This table lists the outbound message types used with Adapter Development Kit CIM commands, along with the business objects used with each.

Command	Outbound Message Type / Business Object
Device Status Check	ADK - CIM Get MeterReadings (DG-CIMGMR) /
	ADK CIM GetMeterReads OB Message (DG-CIMGetMtrRdOBMsg)
On-Demand Read (Interval)	ADK - CIM Get MeterReadings (DG-CIMGMR) /
	ADK CIM GetMeterReads OB Message (DG-CIMGetMtrRdOBMsg)
On-Demand Read (Scalar)	ADK - CIM Get MeterReadings (DG-CIMGMR) /
	ADK CIM GetMeterReads OB Message (DG-CIMGetMtrRdOBMsg)

See [Outbound Messages](#) in the *Administrative User Guide* for more information about creating message senders.

Adapter Development Kit CIM Message Senders

You must create message senders for each outbound communication that will be sent to the head end system as part of the command communication process.

Note: When creating message senders as part of the command communication process used with native implementations, the Message Class MUST be set to SOAPSNDR (Sender for real-time HTTP / SOAP messages).

See [Message Senders](#) in the *Administrative User Guide* for more information about creating message senders.

Adapter Development Kit CIM External System

You must create an external system that represents the head end system and defines a set of outbound message types that can be sent to the head end system.

Adapter Development Kit CIM XSL Files

The table below lists the XSL provided for use with outbound message types based on the outbound message business objects provided for use with Adapter Development Kit CIM commands.

Outbound Message Type	Outbound Message Business Object	Message XSL	Response XSL
ADK - CIM Get MeterReadings (DG-CIMGMR)	ADK CIM GetMeterReads OB Message (DG-CIMGetMtrRdOBMsg)	DG-CIMGetMtrReadsRequest.xsl	DG-CIMGetMtrReadsResponse.xsl

Adapter Development Kit CIM Processing Methods

In order to send smart meter commands to a head end system, appropriate processing methods must be configured on the head end system record.

This table lists the details appropriate to configuring processing methods for each command used with the Adapter Development Kit.

Command	Processing Role	Business Object	Outbound Message Business Object
Device Status Check	Device Status Check	ADK CIM Ping Direct Route (DG-CIMPingDR)	ADK CIM GetMeterReads OB Message (DG-CIMGetMtrRdOBMsg)
On-Demand Read (Scalar)	On-Demand Read (Scalar)	ADK CIM On-Demand Read Direct Route (Scalar) (DG-CIMGetMtrReadScalarDR)	ADK CIM GetMeterReads OB Message (DG-CIMGetMtrRdOBMsg)
On-Demand Read (Interval)	On-Demand Read (Interval)	ADK CIM On-Demand Read Direct Route (Interval) (DG-CIMGetMtrReadIntervalDR)	ADK CIM GetMeterReads OB Message (DG-CIMGetMtrRdOBMsg)

See [Configuring Processing Methods](#) for more information.

Receiving CIM Command Inbound Communications

Inbound web services are used to receive inbound communications from external systems.

The table below lists the inbound web service provided for use with Adapter Development Kit CIM commands.

Name	Description
DG-CIMPingResponse	This Inbound Web Service receives incoming asynchronous callback requests for Device Status Check. This web service accepts requests for the Response method defined in http://iec.ch/TC57/2011/abstract}Generic.wsdl .
DG-CIMODRRResponse	This Inbound Web Service receives incoming asynchronous callback requests for On-Demand Reads. This web service accepts requests for the Response method defined in http://iec.ch/TC57/2011/abstract}Generic.wsdl .

See [Inbound Web Services](#) for more information.

Cloud Service Test Harness

The Smart Grid Gateway Cloud Service Test Harness is used to simulate a head end system for testing smart meter commands in a cloud implementation.

The test harness is "stateless", meaning it does not store meters or their current status. The harness is designed to return a successful result to all command requests by default. Devices must be created in a specific manner to return an error.

How the Test Harness Works

The test harness includes SOAP web service implementations for each command supported by the various Smart Grid Gateway adapters. The Test Harness's container is managed by Oracle cloud services and internal routing definitions allow web service requests to locate the proper container without requiring users to update ports or other configurations. There is no user-accessible configuration required for the test harness itself.

Creating Devices for use with the Test Harness

The test harness works with any sort of device capable to sending smart meter commands. By default, all commands are successful.

Devices must be created in a specific manner in order for errors to be returned from the test harness. Specifically, commands for devices whose identifiers (badge number, serial number, internal meter number, pallet number, external ID,

MDM external ID, and asset ID) end in "ERR" will return an error. This means that when setting up devices for testing via the test harness, you must create separate devices for successful and unsuccessful (error) results.

The simplest approach when creating "error" devices is to use the same identifier value for all identifiers, but at a minimum, "ERR" MUST be the final part of the identifier value for the **AMI Device ID Type** and **AMI Pre-Commissioning Device ID Type** configured on the head end system.

Defining Head End Systems, Processing Methods, Outbound Message Types, and Message Senders for use with the Test Harness

This section provides guidelines for creating data and records used with smart meter commands when using the test harness.

Head End System

When configuring a head end system for use with the test harness, note the identifier types specified in the **AMI Device ID Type** and **AMI Pre-Commissioning Device ID Type** fields. When creating devices intended to return an error, the identifier values for the identifier type(s) specified for these fields MUST end in "ERR" to return an error from the test harness.

Outbound Message Types

When creating outbound message types for use with the test harness, use the appropriate outbound business object based on the specific command. See [Smart Meter Command Flows](#) for details.

Message Senders

When creating message senders for use with the test harness, use the following settings:

Main tab:

- **Invocation Type:** Real-Time
- **Message Class:** SOAPSNDR
- **Active:** <checked>
- **Msg Encoding:** UTF-8 message encoding

Context tab:

- **HTTP Header:** soapAction: <soapaction>

where <soapaction> is the URI (Soap Action) for the command as shown under [Adapter-Specific Test Harness Commands](#) below.

Note the format used here is:

SoapAction: {URI}

That's using a **colon, followed by a space** between the SoapAction and the value. You **cannot** use an equals (=) sign. For example:

```
SoapAction: http://www.multispeak.org/Version_4.1_Release/MeterAddNotification
```

- **HTTP Login User:** A user which has been assigned to the SGGHarnessUser role in Oracle Identity Cloud Service (IDC).
- **HTTP Login Password:** The password for the user above.
- **HTTP Method:** POST
- **HTTP URL 1:** <endpoint_URL>

where <endpoint_URL> is the HTTP URL or the command as shown under [Adapter-Specific Test Harness Commands](#) below, formatted as follows:

```
@SGGTEST@<adapter_name>/<webservice>
```

where:

- @SGGTEST@ is a token that combines the protocol, host, port, tenant, domain, and application
- <adapter_name> is one “lg”, “itron”, “ssn”, or “sensus”, as appropriate
- <webservice> is a name specific to each adapter (e.g. OD_Server, MR_CB, DeviceManager, and so on. See [Adapter-Specific Test Harness Commands](#))

External Systems

When creating outbound message types on external systems and for use with the test harness, be sure to specify the appropriate Message XSL and Response XSL files based on the outbound message business object. See [Creating an External System](#) for lists of these files.

Processing Methods

Command processing methods for a head end system used with the test harness should reference an Outbound Message Type, either the **Default Outbound Message Type** or an **Outbound Message Type** for a specific **Device Type**.

Adapter-Specific Test Harness Commands

This section provides specific details for invoking commands for specific adapters.

Each adapter comprises multiple web services that enable commands. The commands available for each web service for each adapter are provided below.

Itron OpenWay Commands

Control Service

The table below lists details for commands available via the Itron OpenWay Control Service web service.

Command	Web Method	Soap Action (HTTP Header)	HTTP URL
Connect	ReconnectMeter	http://www.itron.com/ ami/2008/10/control/ ControlService/ReconnectMeter	@SGGTEST@/itron/ www.itron.com.ami.2008.10.control
Connect (Result)	GetReconnectMeterResult	http://www.itron.com/ ami/2008/10/control/ ControlService/ GetReconnectMeterResult	@SGGTEST@/itron/ www.itron.com.ami.2008.10.control
Disconnect	DisconnectMeter	http://www.itron.com/ ami/2008/10/control/ ControlService/DisconnectMeter	@SGGTEST@/itron/ www.itron.com.ami.2008.10.control
Disconnect (Result)	GetDisconnectMeterResult	http://www.itron.com/ ami/2008/10/control/ ControlService/ GetDisconnectMeterResult	@SGGTEST@/itron/ www.itron.com.ami.2008.10.control
Load Check	DetectLoadSideVoltageByMeter	http://www.itron.com/ ami/2008/10/control/ ControlService/ DetectLoadSideVoltageByMeter	@SGGTEST@/itron/ www.itron.com.ami.2008.10.control
Load Check (Result)	GetDetectLoadSideVoltageByMeterResult	http://www.itron.com/ ami/2008/10/control/	@SGGTEST@/itron/ www.itron.com.ami.2008.10.control

Command	Web Method	Soap Action (HTTP Header)	HTTP URL
		ControlService/ GetDetectLoadSideVoltageByMeterResult	

Control Diagnostic

The table below lists details for commands available via the Itron OpenWay Control Diagnostic web service.

Command	Web Method	Soap Action (HTTP Header)	HTTP URL
Device Status Check	PingByEndpoints	http://www.itron.com/ ami/2012/03/control/ diagnostic/DiagnosticService/ PingByEndpoints	@SGGTEST@/itron// www.itron.com.ami.2012.03.control.diagnostic
Device Status Check (Result)	GetPingByEndpointsResult	http://www.itron.com/ ami/2012/03/control/ diagnostic/DiagnosticService/ GetPingByEndpointsResult	@SGGTEST@/itron// www.itron.com.ami.2012.03.control.diagnostic
Read Disconnect State	ReadDisconnectStateByMeters	http://www.itron.com/ ami/2012/03/control/ diagnostic/DiagnosticService/ ReadDisconnectStateByMeters	@SGGTEST@/itron// www.itron.com.ami.2012.03.control.diagnostic
Read Disconnect State (Result)	GetReadDisconnectStateByMetersResult	http://www.itron.com/ ami/2012/03/control/ diagnostic/DiagnosticService/ GetReadDisconnectStateByMetersResult	@SGGTEST@/itron// www.itron.com.ami.2012.03.control.diagnostic

Data Service

The table below lists details for commands available via the Itron OpenWay Data Service web service.

Command	Web Method	Soap Action (HTTP Header)	HTTP URL
On-Demand Read	ContingencyReadByEndpoints	http://www.itron.com/ ami/2008/10/data/DataService/ ContingencyReadByEndpoints	@SGGTEST@/itron// www.itron.com.ami.2008.10.data
On-Demand Read (Result)	GetContingencyReadByEndpointsResult	http://www.itron.com/ ami/2008/10/data/DataService/ GetContingencyReadByEndpointsResult	@SGGTEST@/itron// www.itron.com.ami.2008.10.data
Scheduled Read	InterrogateByGroup	http://www.itron.com/ ami/2008/10/data/DataService/ InterrogateByGroup	@SGGTEST@/itron// www.itron.com.ami.2008.10.data
Scheduled Read (Result)	GetInterrogateByGroupResult	http://www.itron.com/ ami/2008/10/data/DataService/ GetInterrogateByGroupResult	@SGGTEST@/itron// www.itron.com.ami.2008.10.data

Provisioning Service

The table below lists details for commands available via the Itron OpenWay Provisioning Service web service.

Command	Web Method	Soap Action (HTTP Header)	HTTP URL
Commission	AddMeterDefinitions	http://www.itron.com/ ami/2009/08/provisioning/ ProvisioningService/ AddMeterDefinitions	@SGGTEST@/itron/ www.itron.com.ami.2009.08.provisioning
Decommission	DeregisterMeters	http://www.itron.com/ ami/2009/08/provisioning/ ProvisioningService/ DeregisterMeters	@SGGTEST@/itron/ www.itron.com.ami.2009.08.provisioning

Landis+Gyr Commands

MR_CB

The table below lists details for commands available via the Landis+Gyr MR_CB web service.

Command	Web Method	Soap Action (HTTP Header)	HTTP URL
Commission	MeterAddNotification	http://www.multispeak.org/ Version_3.0/ MeterRemoveNotification	@SGGTEST@/lg/MR_CB
Decommission	MeterRemoveNotification	http://www.multispeak.org/ Version_3.0/MeterAddNotification	@SGGTEST@/lg/MR_CB
Meter Retire	MeterRetireNotification	http://www.multispeak.org/ Version_3.0/ MeterRetireNotification	@SGGTEST@/lg/MR_CB
On-Demand Read	InitiateMeterReadByMeterNumber	http://www.multispeak.org/ Version_3.0/ InitiateMeterReadByMeterNumber	@SGGTEST@/lg/MR_CB
Scheduled Demand Reset	ScheduleDemandReset	http://www.multispeak.org/ Version_3.0/ ScheduleDemandReset	@SGGTEST@/lg/MR_CB

CD_MR

The table below lists details for commands available via the Landis+Gyr CD_MR web service.

Command	Web Method	Soap Action (HTTP Header)	HTTP URL
Meter Exchange	MeterExchangeNotification	http://www.multispeak.org/ Version_3.0/ MeterExchangeNotification	@SGGTEST@/lg/CB_MR

CD_CB

The table below lists details for commands available via the Landis+Gyr CD_CB web service.

Command	Web Method	Soap Action (HTTP Header)	HTTP URL
Connect/Disconnect	InitiateConnectDisconnect	http://www.multispeak.org/ Version_3.0/ InitiateConnectDisconnect	@SGGTEST@/lg/CD_CB

Metering

The table below lists details for commands available via the Landis+Gyr Metering web service.

Command	Web Method	Soap Action (HTTP Header)	HTTP URL
Add Meter to Inventory	AddMeterToInventory	turtletech.com/TS2/ AddMeterToInventory	@SGGTEST@/lg/Metering

CIM

The table below lists details for commands available via the Landis+Gyr CIM web service.

Command	Web Method	Soap Action (HTTP Header)	HTTP URL
On Demand Read (Interval & Scalar)	AMIRequest	urn:LandisGyr.GSIS.CimService.CIMService	@SGGTEST@/lg/CIM
Device Status Check			

Note: The Landis+Gyr ScheduleDemandReset API does not offer a way to pass a callback URL in. In actual use, L+G allows the callback to be configured in their system. To handle the scenario in the Test Harness, add an additional HTTP header named **SGG-Callback-Endpoint** to the callback URL in the Message Sender. The value of the header should be the address of the D3-CB_MR Inbound Web Service, for example: SGG-Callback-Endpoint: "https://144.25.14.142:8086/iddev2/prod/ccs/soap/api/iws/D3-CB_MR". The URL value is located near the bottom of the WSDL on the Inbound Web Service record.

Sensus Commands

MR_Server

The table below lists details for commands available via the Sensus MR_Server web service.

Command	Web Method	Soap Action (HTTP Header)	HTTP URL
Commission	MeterAddNotification	http://www.multispeak.org/ Version_4.1_Release/ MeterAddNotification	@SGGTEST@/sensus/MR_Server
Decommission	MeterRemoveNotification	http://www.multispeak.org/ Version_4.1_Release/ MeterRemoveNotification	@SGGTEST@/sensus/MR_Server
On-Demand Read	InitiateMeterReadingsByMeterNumber	http://www.multispeak.org/ Version_4.1_Release/ InitiateMeterReadingsByMeterID	@SGGTEST@/sensus/MR_Server

CD_Server

The table below lists details for commands available via the Sensus CD_Server web service.

Command	Web Method	Soap Action (HTTP Header)	HTTP URL
Connect/Disconnect	InitiateConnectDisconnect	http://www.multispeak.org/ Version_4.1_Release/ InitiateConnectDisconnect	@SGGTEST@/sensus/CD_ Server

OD_Server

The table below lists details for commands available via the Sensus OD_Server web service.

Command	Web Method	Soap Action (HTTP Header)	HTTP URL
Device Status Check	InitiateOutageDetectionEventRequest	http://www.multispeak.org/ Version_4.1_Release/ InitiateOutageDetectionEventRequest	@SGGTEST@/sensus/OD_ Server

Silver Spring Networks Commands

Note: The Silver Spring Networks adapter works differently from the other adapters. This adapter does not use SoapAction identifiers on the operations, so the HTTP Header can be left off of the Message Sender configuration.

DataAggregation

The table below lists details for commands available via the Silver Spring Networks DataAggregation web service.

Command	Web Method	HTTP URL
	GetMeterFieldStatus	@SGGTETST@/ssn/DataAggregation

DeviceManager

The table below lists details for commands available via the Silver Spring Networks DeviceManager web service.

Command	Web Method	HTTP URL
All	FindDevice	@SGGTETST@/ssn/DeviceManager
Commission	ReplaceLocation	@SGGTETST@/ssn/DeviceManager
Decommission	ReplaceDeviceAtLocation	@SGGTETST@/ssn/DeviceManager

JobManager

The table below lists details for commands available via the Silver Spring Networks JobManager web service.

Command	Web Method	HTTP URL
Connect/Disconnect	addRemoteProvisioningJob	@SGGTETST@/ssn/JobManager
On-Demand Read	addMeterReadJob	@SGGTETST@/ssn/JobManager
Device Status Check	addPingJob	@SGGTETST@/ssn/JobManager
On-Demand Read, Device Status Check	getJobStatus	@SGGTETST@/ssn/JobManager
Connect/Disconnect	getJobStatusForDevice	@SGGTETST@/ssn/JobManager

DeviceResults

The table below lists details for commands available via the Silver Spring Networks DeviceResults web service.

Command	Web Method	HTTP URL
Connect/Disconnect	getRemoteProvisioningResultsByJobID	@SGGTETST@/ssn/DeviceResults
On-Demand Read	getMeterReadResultsByJobID	@SGGTETST@/ssn/DeviceResults
Device Status Check	getPingresultsByJobID	@SGGTETST@/ssn/DeviceResults

Master Configurations

Master configurations define configuration settings for individual adapters. The sections below provide details for the master configuration provided for each Smart Grid Gateway adapter.

Itron OpenWay Master Configuration

The “Itron – Master Config” master configuration defines details used by the Itron OpenWay commands and payload processing, including the following:

- **Itron Version:** Used to specify the version of the Itron OpenWay head end system being used.
- **Command Status Changed URL Configuration:** Used to define URL configuration for asynchronous callback requests.
 - **Status Changed Service URL Script:** Used to define a service script which composes the URL for asynchronous callbacks. The script should include an /output/applicationUrl field containing the results. When determining the URL, the system initially checks if a script has been configured on this field, and if so, that script is used. If this field is blank (which is the default), the Determine Application URL (D1-DetStChSU) script is used to compose the URL.
 - **Default Status Changed Service URL:** The base portion of a URL sent to the head end system which provides a location to which it should send an asynchronous callback request. This base URL is appended by command-specific URL components defined as algorithm parameters on "Populate Send Details." algorithms on outbound communication business objects.
 - **Commands:** Command-specific base URLs for asynchronous callback requests
- **Arrived Data Save Locations:** Used to define how payloads and exceptions are routed and processed by the Itron DataSubscriberService, Itron EventSubscriberService, and Itron ExceptionSubscriberService inbound web services.
- **DataArrived Output Configuration:** Defines how payloads are routed and processed by the Itron DataSubscriberService inbound web service.
 - **Save to Staging:** A flag that indicates if payloads routed and processed by the Itron DataSubscriberService inbound web service should be saved to a staging area in Oracle Object Storage. This should be set to "Yes" to enable the use of a staging area in Object Storage.
 - **File Storage:** The staging location where payloads are routed for later processing. This should be a File Location Extendable Lookup value.
 - **Output Bucket/Folder Name:** The specific object storage bucket or folder within the file storage location where payloads are routed.
 - **Filename Generation Script:** The name of a service script used to compose the filename when saving incoming payloads to the staging area. By default, the D8-DEFFNGEN script is used.
- **EventsArrived Output Configuration:** Defines how event payloads are routed and processed by the Itron EventSubscriberService inbound web service.

- **Save to Staging:** A flag that indicates if event payloads routed and processed by the Itron EventSubscriberService inbound web service should be saved to a staging area in Oracle Object Storage. This should be set to "Yes" to enable the use of a staging area in Object Storage.
- **File Storage:** The staging location where event payloads are routed for later processing. This should be a File Location Extendable Lookup value.
- **Output Bucket/Folder Name:** The specific object storage bucket or folder within the file storage location where event payloads are routed.
- **Filename Generation Script:** The name of a service script used to compose the filename when saving incoming event payloads to the staging area. By default, the D8-DEFFNGEN script is used.
- **ExceptionsArrived Output Configuration:** Defines how exceptions are routed and processed by the Itron ExceptionSubscriberService inbound web service
 - **Save to Staging:** A flag that indicates if exceptions routed and processed by the Itron ExceptionSubscriberService inbound web service should be saved to a staging area in Oracle Object Storage. This should be set to "Yes" to enable the use of a staging area in Object Storage.
 - **File Storage:** The staging location where exceptions are routed for later processing. This should be a File Location Extendable Lookup value.
 - **Output Bucket/Folder Name:** The specific object storage bucket or folder within the file storage location where exceptions are routed.
 - **Filename Generation Script:** The name of a service script used to compose the filename when saving exceptions to the staging area. By default, the D8-DEFFNGEN script is used.

Landis+Gyr Master Configuration

The “L+G – Master Config” master configuration defines details used by the Landis+Gyr commands and payload processing, including the following:

- **Command Status Changed URL Configuration:** Used to define URL configuration for asynchronous callback requests
 - **Status Changed Service URL Script:** Used to define a service script which composes the URL for asynchronous callbacks. The script should include an /output/applicationUrl field containing the results. When determining the URL, the system initially checks if a script has been configured on this field, and if so, that script is used. If this field is blank (which is the default), the Determine Application URL (D1-DetStChSU) script is used to compose the URL.
 - **Default Status Changed Service URL:** The base portion of a URL sent to the head end system which provides a location to which it should send an asynchronous callback request. This base URL is appended by command-specific URL components defined as algorithm parameters on "Populate Send Details." algorithms on outbound communication business objects.
 - **Commands:** Command-specific base URLs for asynchronous callback requests
- **AMI Events Configuration:** Used to define settings for the CIM AMIEvent interface
 - **Save to Staging Area:** Flag that indicate whether to save incoming data to a staging area, such as Oracle Object Storage, or process it directly
 - **Processing Configuration Value:** An SGG Payload Processing Configuration extendable lookup used when immediately processing the AMIEvent payloads

Sensus Master Configuration

The “Sensus Master Configuration” master configuration defines details used by the Sensus commands and outage events, including the following:

- **Command Status Changed URL Configuration:** Used to define URL configuration for asynchronous callback requests
 - **Status Changed Service URL Script:** Used to define a service script which composes the URL for asynchronous callbacks. The script should include an `/output/applicationUrl` field containing the results. When determining the URL, the system initially checks if a script has been configured on this field, and if so, that script is used. If this field is blank (which is the default), the Determine Application URL (D1-DetStChSU) script is used to compose the URL.
 - **Default Status Changed Service URL:** The base portion of a URL sent to the head end system which provides a location to which it should send an asynchronous callback request. This base URL is appended by command-specific URL components defined as algorithm parameters on "Populate Send Details." algorithms on outbound communication business objects.
 - **Commands:** Command-specific base URLs for asynchronous callback requests
- **Outage Events Head End System:** Used to define the head end system expected to which outage events are sent via the `ODEventNotification` interface

Silver Spring Networks Version Master Configuration

The “SSN – Version Master Config” master configuration specifies the version of the Silver Spring Networks head end system with which the system is communicating:

- **SSN Version:** Used to define the version of the Silver Spring Networks head end system. Options include:
 - SSN Version 4.4
 - SSN Version 4.7
 - SSN Version 4.10

NOTE: SSN Version 4.10 is only version of the Silver Spring Networks adapter supported with native implementations.

- **SSN - Get Job Status Configuration:** Used to specify the **Retry Limit** and **Wait Duration (in Seconds)** for the Get Job Status requests sent by outbound communications.

Native Implementation Configuration Checklists

This section provides an overview of the steps involved in configuring Native implementations of Oracle Utilities Smart Grid Gateway adapters, including [Payload Processing](#) and [Smart Meter Command Processing](#).

Payload Processing Checklist

1. Create Keys and Key Rings (Cloud Only). See [Creating Key Rings and Pairs](#) for more information.
2. Configure Object Storage Locations (Cloud Only). See [Creating Object Storage Locations](#) for more information.
3. Configure File Storage Extendable Lookup Values. See [Creating File Storage Extendable Lookup Values](#) for more information.
4. Configure a Head End System to represent the Head End System. See [Creating Head End Systems](#) for more information.
5. Configure Processing Methods for the Head End System appropriate for payload processing, including.
 - Initial Measurement Creation
 - Device Event Mapping
 - UOM Translation

NOTE: These processing methods rely on extendable lookups. See [Configuring Adapter Extendable Lookups](#) for more information.

6. Configure SGG Payload Processing Extendable Lookup Values. See [Creating SGG Payload Processing Extendable Lookup Values](#) for more information.
7. Configure the adapter's Master Configuration (if appropriate). See [Master Configurations](#) for more information.
8. Configure Other Extendable Lookup Values. See [Configuring Adapter Extendable Lookups](#) for more information.
9. Configure Batch Controls. See [Creating Payload Processing Batch Controls](#) for more information.

Smart Meter Command Processing Checklist

1. Configure Activity Types for each command you wish to support in your implementation. Smart meter commands are activities in the system. For each command you plan to support, confirm that you have a corresponding Activity Type configured.
2. Configure Communication Types appropriate for each command you wish to support in your implementation. Each communication sent to the head end system as part of a command request requires a communication type. See the following sections for more information about the specific communications used with each command:
 - [Itron OpenWay Command Flows](#)
 - [Landis+Gyr Command Flows](#)
 - [Sensus Command Flows](#)
 - [Silver Spring Networks Command Flows](#)

NOTE: Note: Most Adapters use outbound communications only.

3. Configure Message Senders for each command you wish to support in your implementation. See [Sending Outbound Communications](#) and [Creating Message Senders](#) for more information.
4. Configure Outbound Message Types each command you wish to support in your implementation. See [Sending Outbound Communications](#) and [Creating Outbound Message Types](#) for more information.
5. Configure an External System to represent the Head End System.
 - a. Configure Message Senders/Outbound Message Types for each command you wish to support in your implementation See [Sending Outbound Communications](#) and [Creating an External System](#) for more information.
6. Configure a Head End System to represent the Head End System. Head End Systems reference the corresponding External System. See [Creating Head End Systems](#) for more information.
7. Configure Processing Methods for the Head End System appropriate for each command you wish to support in your implementation. See [Configuring Processing Methods](#) for more information.
8. Configure Inbound Web Services as appropriate for the Head End System See [Receiving Inbound Communications](#) and [Inbound Web Services](#) for more information.
9. Configure the adapter's Master Configuration (if appropriate) See [Master Configurations](#) for more information.
10. Configure Extendable Lookups See [Configuring Adapter Extendable Lookups](#) for more information.

Configuration Details Reference

Refer to Knowledge Base article [2785031.1](#) on [My Oracle Support](#) for a spreadsheet containing configuration details for the following Adapters:

- Itron OpenWay
- Silver Spring Networks
- Landis+Gyr
- MV90 (Payload Processing Only)

This spreadsheet contains lists of configuration objects used by each adapter, including:

- Activity Types
- Communication Types
- Message Senders
- Head End System
- Outbound Message Type
- External System
- Master Configurations (as applicable)
- Extendable Lookups
- Batch Controls

Defining Settlement Options

Settlement Configuration Overview

This section provides information about set up and configuration of administration data used by calculations and processes provided with Oracle Utilities Market Settlements Management.

Settlement Subscription Types

Understanding Settlement Subscription Types

Settlement subscription types are collections of properties defining a class of settlement subscriptions. Settlement subscription types also control valid values for various attributes of settlement subscriptions.

Settlement subscription types are defined by:

- **Transaction Business Object:** The business object used for settlement transactions based on settlement subscriptions of this type
- **Default Recipient:** The recipient that will be defaulted for settlement subscriptions of this type. A settlement subscription's recipient dictates the system to which results of settlement transactions are sent.
- **Transaction Retention Mode:** Defines how settlement transactions based on settlement subscriptions of this type are retained. "Keep All" indicates that all settlement transactions are retained when a replacement transaction is created (older transactions are sent to a status of "Superseded"). "Keep One Record per Period" indicates that only a single settlement transaction is retained for a time period (older transactions are deleted when the new one is completed).
- **Valid Settlement Calculation Groups:** A list of valid settlement calculation groups for settlement subscriptions of this type
- **Valid Recipients:** A list of valid recipients for settlement subscriptions of this type

- **Communication:** The outbound communication type used to create of outbound communications when sending the results of settlement transactions based on settlement subscriptions of this type

Refer to [Configuring Settlement Units](#) for more information about setting up settlement units and their respective dimension combinations, factors, and factor values.

For a deeper functional understanding, refer to the [About Settlement Subscriptions](#) or [About Settlement Calculation](#) sections .

Configuring Settlement Subscription Types

Refer to [Understanding Settlement Subscription Types](#) for more information.

You can access the portal by selecting **Admin**, then **Settlement**, then **Settlement Subscription Type**.

The following zones may appear as part of the portal's **Main** tab page:

- **Settlement Subscription Type List:** This zone lists all usage subscription type records. Broadcast a record to display the details of the selected record.
- **Settlement Subscription Type:** This zone displays details for the selected usage subscription type.

The settlement subscription type defines a number of lists for valid objects that can be used in conjunction with the overall usage calculation process:

- Valid Settlement Calculation Groups
- Valid Recipients

Settlement subscription types also define the outbound communication type used when sending the results of settlement transactions based on settlement subscriptions of this type.

Settlement Transaction Exception Types

Understanding Settlement Transaction Exception Types

Settlement Transaction Exception Types define the groupings of exceptions for a settlement transaction based on their functional similarity. This provides a way to define Settlement Transaction Exceptions in a distinct enough way to understand the root issue that was generated from the usage calculation rule.

For a deeper functional understanding of Settlement Calculation, refer to the [About Settlement Calculations](#) section.

Configuring Settlement Transaction Exception Types

This portal is used to display and maintain a Settlement Transaction Exception Type.

Refer to [Understanding Settlement Transaction Exception Types](#) for more information.

You can access the portal by selecting **Admin**, then **Settlement**, then **Settlement Transaction Exception Type**.

The following zones may appear as part of the portal's **Main** tab page:

- **Settlement Transaction Exception Type List:** displays all of the Settlement Transaction Exception Types so you can choose the one you want to display in more detail
- **Settlement Transaction Exception Type:** shows the specific configuration for the selected Settlement Transaction Exception Type

Settlement Units

Understanding Settlement Units

Settlement units define the “lowest common denominator set” of aggregation dimensions. For example, if aggregations are performed based on Rate Class, Strata, Procurement Group, and Supplier, the following dimensions would form the “lowest common denominator set” of these dimensions (since these are shared by different suppliers):

- Rate Class
- Strata
- Procurement Group

Settlement units define factor values based on unique combinations of dimension values. Different factor values can be defined for each unique combination of a settlement unit’s dimensions. For example, a Rate Class, Strata, and Procurement Group settlement unit could have different factor values for each unique combination of those dimensions. These multi-variable factor values can be retrieved by value derivation algorithms when performing aggregation, estimation, and forecasting calculations based on the same dimensions as defined for the settlement unit.

For example, an aggregation measuring component that aggregates data based on a specific combination of Rate Class, Strata, and Procurement Group could retrieve a “loss” factor value from a Rate Class, Strata, and Procurement Group settlement unit based on the same combination of dimensions. See [Applying Losses](#) for an example of how settlement units can be referenced in aggregation calculations.

Aggregation processing also uses settlement units to generate counts of accounts for forecasting based on combinations of these dimensions.

Settlement units are defined by:

- **Dimensions:** The attributes by which aggregated data should be analyzed
- **Dimension Combinations:** Unique combinations of the settlement unit’s dimensions (defined in the **Settlement Unit Dimension Combination** zone)
- **Valid Factors:** Valid multi-variable factors (defined in the **Settlement Unit Valid Factors** zone)

Refer to [Configuring Settlement Units](#) for more information about setting up settlement units and their respective dimension combinations, factors, and factor values.

Configuring Settlement Units

Refer to [Understanding Settlement Units](#) for more information.

You can access the portal by selecting **Admin**, then **Settlement**, then **Settlement Unit**. You are brought to a query portal with options for searching. Once your record has been selected you are brought to the maintenance portal to view and maintain the selected record.

The following zones may appear as part of the portal's **Main** tab page:

- **Settlement Unit:** This zone displays details for the settlement unit, including configured dimensions.
- **Settlement Unit Dimension Combinations:** This zone displays combinations of the settlement unit’s dimensions, based on the dimensions configured in the **Settlement Unit** zone. Click **Add Dimension Combination** in the zone’s title bar to add a new combination.
- **Settlement Unit Valid Factors:** This zone displays valid multi-variable factors for the settlement unit. Click **Add Factor** in the zone’s title bar to add a new factor. Values for these factors are defined on the **Multi-Variable Factor** tab.

The following zones appear as part of the portal's **Dimension Combinations** tab page:

- **Settlement Unit Dimension Combinations:** This zone displays a list of dimension combinations for the settlement unit. Broadcast a record to display the details of the selected record. Click **Add Dimension Combination** in the zone's title bar to add a new combination.
- **Dimension Combination Values:** This zone displays factor values for each multi-variable factor defined for the selected dimension combination. You can use this zone to add and/or edit factor values.

The following zones appear as part of the portal's **Multi-Variable Factor** tab page:

- **Multi-Variable Factor List:** This zone displays a list of multi-variable factors for the settlement unit. Broadcast a record to display the details of the selected record.
- **Multi-Variable Factor Value List:** This zone displays factor values for each dimension combination for the selected multi-variable factor. You can use this zone to add and/or edit factor values.

Settlement Data Snapshot Types

Settlement data snapshots capture data as of a specific point in time for use in aggregation and settlement calculations. For instance, data snapshots can capture data such as:

- The state of a settlement account (a Settlement Item) as of the last time something about the account changed
- The state of a settlement account as of the last time the account was billed
- Measurement data used for initial settlement
- Measurement data used for final settlement

Data snapshot types define parameters for specific types of data snapshots. There are two general categories of settlement data snapshot types:

- Attribute Data Snapshot Types
- Measurement Data Snapshot Types

Attribute Groups

Understanding Attribute Groups

Attribute groups define sets of attributes used to model Settlement processing. These attributes when combined can be used to group data for aggregation, identify the appropriate estimation rules, load shapes, among other things. Attribute groups can be shared across several objects as a Settlement Item, Aggregation Measuring Component, and Settlement Unit.

Attribute groups are defined by:

- **Division:** The division to which settlement data based on attribute group belong
- **Attribute Value Business Object:** The business object used for attribute values based on the attribute group
- **Attribute Field Mapping:** Defines the fields and related extendable lookups that define the attributes defined by the attribute group. For each field configured, the related extendable lookup defines the possible values.

Refer to [Configuring Attribute Groups](#) for more information about setting up attribute groups.

Configuring Attribute Groups

Refer to [Understanding Attribute Groups](#) for more information.

You can access the portal by selecting **Admin**, then **Settlement**, then **Attribute Group**.

The following zones may appear as part of the portal's **Main** tab page:

- **Attribute Group List:** This zone lists all attribute groups. Broadcast a record to display the details of the selected record.
- **Attribute Group:** This zone displays details for the selected attribute group.

Attribute Data Snapshot Types

Understanding Attribute Data Snapshot Types

Attribute data snapshots are used to capture settlement account data as of a specific point in time, such as the last time an attribute on the account changed or the last time it was billed. Attribute data snapshot types defines types of attribute data snapshots used by the system.

Attribute data snapshot types are defined by:

- **Division:** The division to which settlement account captured by attribute data snapshots of this type belong
- **Attribute Group:** The attribute group used by attribute data snapshots of this type belong
- **Attribute Data Snapshot Business Object:** The business object used for attribute data snapshots of this type
- **Processing Timetable Type:** defines the schedule for capturing attribute data snapshots of this type.
- **Attribute Field Mapping:** The specific attributes captured by attribute data snapshots of this type

Configuring Attribute Data Snapshot Types

You use the **Attribute Data Snapshot Type** portal to display and maintain attribute data snapshot types.

Refer to [Understanding Attribute Data Snapshot Types](#) for more information.

You can access the portal by selecting **Admin**, then **Settlement**, then **Attribute Data Snapshot Type**.

The following zones may appear as part of the portal's **Main** tab page:

- **Attribute Data Snapshot Type List:** This zone lists all attribute data snapshot type records. Broadcast a record to display the details of the selected record.
- **Attribute Data Snapshot Type:** This zone displays details for the selected attribute data snapshot type.

Measurement Data Snapshot Types

Understanding Measurement Data Snapshot Types

Measurement data snapshots are used to capture measurement data as of a specific point in time, such as the when the data was used for billing. Measurement data snapshot types defines types of measurement data snapshots used by the system.

Measurement data snapshot types are defined by:

- **Division:** The division to which the measurement data captured by measurement data snapshots of this type belong.
- **Measurement Data Snapshot Business Object:** The business object used for measurement data snapshots of this type.
- **Interval Size:** The size of intervals captured by measurement data snapshots of this type (applies to interval measurement data snapshot types only).

- **Interval / Scalar:** A flag that designates the type of measurement data (interval or scalar) captured by measurement data snapshots of this type.
- **Measurement Data Source:** The source of the measurement captured by measurement data snapshots of this type.
- **Consumption Type:** The type of consumption (Billed Quantities, Metered Data, or Unmetered Data) captured by measurement data snapshots of this type (applies to scalar measurement data snapshot types only).
- **Value Identifiers:** The UOM, TOU, SQI, and short hand description for measurement data captured by measurement data snapshots of this type.

Configuring Measurement Data Snapshot Types

You use the **Measurement Data Snapshot Type** portal to display and maintain measurement data snapshot types.

Refer to [Understanding Measurement Data Snapshot Types](#) for more information.

You can access the portal by selecting **Admin**, then **Settlement**, then **Measurement Data Snapshot Type**.

The following zones may appear as part of the portal's **Main** tab page:

- **Measurement Data Snapshot Type List:** This zone lists all measurement data snapshot type records. Broadcast a record to display the details of the selected record.
- **Measurement Data Snapshot Type:** This zone displays details for the selected measurement data snapshot type.

Settlement Calculations

Settlement Calculation Groups

Understanding Settlement Calculation Groups

Settlement calculation groups are collections of settlement calculation rules that are used to perform settlement calculations, including calculating service point quantities, totaling consumption and usage for settlement units, application of losses, and allocation of unaccounted for energy (UFE). During the settlement transaction process, the system executes the settlement calculation rules defined in the settlement calculation group referenced on the settlement subscription. The rules within a settlement calculation group are defined in a specific sequence, allowing control over the order in which the rules are executed.

Settlement calculation groups are associated with specific settlement subscriptions and settlement subscription types (or both). When assigned to settlement subscriptions, settlement calculation groups contain the settlement calculation rules used to perform the appropriate calculations. Settlement calculation groups associated with settlement subscription types are those groups considered valid for settlement subscriptions of that type.

Settlement calculation groups can also be referenced by the [Execute Usage Calculation Group](#) calculation rule.

Understanding Bulk Settlement Calculation Groups

Bulk settlement calculation groups are calculation groups intended for use with high volume calculations, such as UFE allocation.

Some specific differences between bulk settlement calculation groups and standard settlement calculation groups include:

- Bulk settlement calculation groups reference only a single settlement calculation rule.

- Execution of bulk settlement calculation groups is performed by batch execution only, typically within a set of calculations performed during settlement transaction processing.
- Bulk settlement calculation groups use the “Settlement Bulk Calculation Group” business object (D1–SettlementBulkCalcGroup).
- Bulk settlement calculation groups have a **Calculation Group Class** of “Settlement Bulk Calculation”.

Configuring Settlement Calculation Groups

This portal is used to display and maintain a settlement calculation group.

Refer to [Understanding Settlement Calculation Groups](#) for more information.

You can access the portal by selecting **Admin**, then **Settlement**, then **Settlement Calculation Group**. You are brought to a query portal with options for searching. Once your record has been selected you are brought to the maintenance portal to view and maintain the selected record.

The following zones may appear as part of the portal's **Main** tab page:

- **Settlement Calculation Group:** This zone displays basic information about a settlement calculation group.
- **Settlement Calculation Rules List:** This zone lists the settlement calculation rules belonging to the group. Not applicable to bulk calculation groups.
- **Referencing Settlement Calculation Rules List:** This zone lists the settlement calculation rules that reference the group. Not applicable to bulk calculation groups.
- **Referencing Settlement Subscription Type List:** This zone lists the settlement subscription types that reference the group.
- **Referencing Settlement Subscription List:** This zone lists the settlement subscriptions that reference the group.

Configuring Bulk Settlement Calculation Groups

The **Settlement Calculation Group** portal is used to display and maintain bulk settlement calculation groups.

Refer to [Understanding Bulk Settlement Calculation Groups](#) for more information about bulk settlement calculation groups and [Configuring Settlement Calculation Groups](#) for more information about creating and maintaining bulk settlement calculation groups.

The following apply when creating new bulk settlement calculation groups:

- Select “Settlement Bulk Calculation Group” from the **Settlement Calculation Group Business Object** drop-down list.
- Use a naming convention of some sort to identify bulk settlement calculation groups (the **Settlement Calculation Group** portal does not provide a way to search for groups based on **Calculation Group Class**). For instance, consider including “bulk” or “blk” in the **Description** of bulk settlement calculation groups.

Settlement Calculation Rules

Understanding Settlement Calculation Rules

Settlement calculation rules are standard and custom rules that perform settlement calculations, including calculating service point quantities, totaling consumption and usage for settlement units, application of losses, and allocation of unaccounted for energy (UFE). Settlement calculation rules are created for a specific settlement calculation group. For example, if you were configuring two settlement calculation groups and both included a specific usage calculation rule, you would need to create two instances of the settlement calculation rule, one for each group.

On almost every settlement calculation rule, the failure of the rule results in a settlement transaction exception and the [Usage Transaction Exception Type](#) for the failure can be configured on the rule. These usage transaction exception types can also be set to a specific Exception Severity:

- **Information:** Used to highlight minor issues, but not sufficient to cause the settlement transaction to be put into a failure state. Exceptions of this category can be used to report on the frequency of interesting, but not fatal issues.
- **Issues:** Used to report a problem that will prevent the settlement transaction from being sent. Multiple "issue exceptions" can be created during settlement transaction processing. If at least one issue exists after all rules have been applied, the settlement transaction is transitioned to a failure state requiring review and approval.
- **Terminate:** Used to report a severe issue that will cause the settlement calculation process to stop and the settlement transaction to be transitioned immediately to a failure state requiring review and approval. Only one terminate exception can be issued (as the first one causes calculation processing to stop for a settlement transaction). This should be used for cases where manual override / approval isn't accurate.

For a deeper functional understanding of settlement calculation, refer to the [About Settlement Calculation](#) section.

Configuring Settlement Calculation Rules

This portal is used to display and maintain a settlement calculation rule.

Refer to [Understanding Settlement Calculation Rules](#), [Understanding Settlement Calculation Groups](#), and [Understanding Usage Transaction Exception Types](#) for more information.

You can access the portal by selecting **Admin**, then **Settlement**, then **Settlement Calculation Rule**. You are brought to a query portal with options for searching. Once your record has been selected you are brought to the maintenance portal to view and maintain the selected record.

The following zones may appear as part of the portal's **Main** tab page:

- **Settlement Calculation Rule:** This zone displays details for the selected settlement calculation rule, including parameters used when executing the rule
- **Eligibility Criteria List:** Lists the eligibility criteria defined for the rule, if applicable.

Calculation Settlement Calculation Rules

The following is a list of the calculation settlement calculation rules provided as part of the base product. For more information on how each rule executes and can be configured, follow the link provided on the rule.

Settlement Calculation Rule Name	Applicable Data Type(s)	Purpose
Apply Math (Interval Data)	Interval	<p>This rule is used to perform calculations on interval data and stores the results in the settlement transaction's service quantities. A variety of options are available on this rule that include defining the calculation type, variables to use, as well as the equation to use (math functions and expressions).</p> <p>This rule provides aggregated usage for all selected interval measuring components (filter by TOU, SQI & UOM) associated to a settlement subscription.</p> <p>This rule can also multiply total usage by a factor using a custom formula.</p>
Array Math	Interval, arrays, and calculated quantities	This rule is used to perform settlement calculations on arrays and interval data

		and it stores the results in the settlement transaction's service quantities.
Market Award Allocation	Interval	This rule is used to perform settlement calculations to allocate load based on market awards, based on appropriate methods for dividing load out to wholesale contracts.
Measuring Component Set Calculation	Interval and calculated quantities	This rule is used to perform UFE calculations.
Vector and Service Quantity Math	Interval	<p>This rule is designed to facilitate configuration of complex vector calculations. It is based on a series of underlying services with vectors configured as input to the calculations.</p> <p>Typical uses:</p> <p>Perform math using interval data. For example, take the difference between two curves, find max values, find coincident peaks, multiply a curve by a value, apply TOU maps, etc.</p> <p>Define complex formulas using various interval curves, profile factor values or calculated service quantities (bill determinant values).</p> <p>Support math functions: sin, cos, square root, etc.</p> <p>Store derived curves in memory that can be used in subsequent calculations</p> <p>Please note, this rule is not as efficient as other rules.</p>

Decision-Making Settlement Calculation Rules

There are settlement calculation rules delivered as part of the base product that help with decision-making when executing the settlement calculation process. For more information on how each rule executes and can be configured, follow the link provided on the rule.

Settlement Calculation Rule Name	Purpose
Execute Usage Calculation Group	This rule performs a call to execute a separate settlement calculation group which includes execution of all settlement calculation rules within that group.
Exception Handler	This rule is used to terminate processing if exception count criteria specified in the rule is met.

Advanced Aside: Using Factors For Variables

A situation common in some implementations involves converting one unit of measure (UOM) to another. However, the conversion factor used in conversions of this type can differ based on many different types of criteria, such as the location of the service point or other characteristics. This type of calculation can be implemented as a settlement calculation rule that accumulates consumption for one UOM and converts the consumption to a different UOM by applying a factor to it.

Factors used for this purpose have a Factor Class of "Number," and use some unique rules:

- Number factors reference a characteristic type (with pre-defined values).
- Number factors reference an algorithm that retrieves or derives the value of the characteristic type at runtime.

Factor values for a Number factor are effective-dated pairings of a characteristic value and a corresponding value. Because these pairings are effective-dated, the value returned from the factor can change over time for each characteristic value. At run time, the rule retrieves / derives the characteristic value for the factor's characteristic type and then finds the value associated with the respective characteristic value. Factors can be related to any real or dynamic attribute, so rules of this type are very flexible. For example:

- **Real Attribute:** you could create a rule that retrieves a specific value based on the location of a service point.
- **Dynamic Attribute:** you could create a rule that retrieves a percentage value based on the amount the customer conserved as compared to the same period in the prior year, returning one value if the amount conserved is between 5% and 10%, another value if the amount conserved is between 10% and 20%, and a third value if the amount conserved is greater than 20%. The amount conserved is dynamically calculated at execution time and is compared to the characteristic values defined for the factor, and returns the appropriate value. In this example, if the amount conserved was anything less than 5%, no percentage value would be returned.

Calculation Rules

Array Math

This rule is used to perform settlement calculations on arrays and interval data and it stores the results in the settlement transaction's service quantities. Arrays can be derived from either measuring component sets or calculated quantities. Interval data vectors can be derived from measuring component sets, individual measuring components, or calculated quantities. A variety of options are available on this rule that include defining variables to use for arrays and interval data vectors, the specific calculations to perform (leveraging math functions and expressions), and how to save the results.

NOTE:

Additional detail on the logic of this rule can be found in the Detailed Description of the D2-ARRAYMATH Algorithm Type.

For help with the meaning of specific configuration fields, refer to the embedded help on the screen when adding or editing the rule.

Business Object

D2-ArrayMath

Market Award Allocation

This rule is used to perform settlement calculations to allocate load based on market awards, based on appropriate methods for dividing load out to wholesale contracts. This rule takes in a vector from the settlement transaction and divides the load to be allocated to various market awards for a configured market product set. The allocated amounts should be tied to the contract connected to the market award and then saved to the settlement transaction as a new array.

NOTE:

Additional detail on the logic of this rule can be found in the Detailed Description of the D2-AWARDALOC Algorithm Type.

For help with the meaning of specific configuration fields, refer to the embedded help on the screen when adding or editing the rule.

Business Object

D2-MarketAwardAllocation

Measuring Component Set Calculation

This rule is used to perform settlement UFE calculations.

This rule executes a batch program (D1-MCSCA, defined as a parameter on the Execute MC Set Calculation-Apply Rule algorithm), which in turn executes the Perform MC Set Calculation algorithm to perform the calculation. The rule configuration includes definition of variables and the equation used for UFE calculations. Variables can be based on specified measuring component sets, aggregation measuring components, or calculated quantities.

This rule should be used ONLY with Bulk Settlement Calculation Groups.

NOTE:

Additional detail on the logic of this rule can be found in the Detailed Description of the D1-EXEMCSCAL Algorithm Type.

For help with the meaning of specific configuration fields, refer to the embedded help on the screen when adding or editing the rule.

Business Object

D2-MCSetCalculation

Settlement Item Types

Understanding Settlement Item Types

Settlement Item Types define specific types of end-customer settlement accounts.

Settlement item types define the following attributes:

- **Settlement Item Business Object:** The business object to use create settlement items of this type.
- **Settlement Billed Usage Business Object:** The business object to use to capture billed usage for a settlement account.
- **Valid Service Point Types:** Valid service point types for the settlement item type.

NOTE: Settlement item types are similar to usage subscription types used in Meter Data Management, and are based on the Usage Subscription Type maintenance object (D1-USTYPE).

Configuring Settlement Item Types

Refer to [Understanding Settlement Item Types](#) for more information.

You can access the portal by selecting **Admin**, then **Settlement**, then **Settlement Item Type**.

The following zones may appear as part of the portal's **Main** tab page:

- **Settlement Item Type List:** This zone lists all settlement item types. Broadcast a record to display the details of the selected record.
- **Settlement Item Type:** This zone displays details for the selected settlement item type.

Settlement Item Quantity Types

Understanding Settlement Item Quantity Types

Settlement item quantity types define types of quantities that can be stored for a settlement item. These quantity types are often infrequently calculated descriptors of a given customer and how they relate, at an aggregate level, to either the customer base as a whole or their particular rate class.

Settlement item quantity types use the following parameters:

- **Service Type:** The service type (electric, gas, water, etc.) for settlement item quantities of this type.
- **Settlement Item Quantity Business Object:** The business object used for settlement item quantities of this type.
- **Settlement Item Quantity Identifiers:** Value identifiers related to the current settlement item quantity type (used to provide shorthand descriptions of the various types of values measured by settlement item quantities of this type).

Configuring Settlement Item Quantity Types

You use the **Settlement Item Quantity Type** portal to display and maintain settlement item quantity types.

Refer to [Understanding Settlement Item Quantity Types](#) for more information.

You can access the portal by selecting **Admin**, then **Settlement**, then **Settlement Item Quantity Type**.

The following zones may appear as part of the portal's **Main** tab page:

- **Settlement Item Quantity Type List:** This zone lists all settlement item quantity type records. Broadcast a record to display the details of the selected record.
- **Settlement Item Quantity Type:** This zone displays details for the selected settlement item quantity type.

Market Contract Types

Understanding Market Contract Types

Market Contract Types define specific types of market contracts used in settlement processing.

Market contract types define the following:

- The market associated with market contracts of this type
- The pricing category for market contracts of this type
- Whether market contracts of this type have Unique Contract Buyers. When set to "Yes", market contracts of this type are validated to ensure that each buyer only has one valid contract at a point in time for the market contract type.

Configuring Market Contract Types

Refer to [Understanding Market Contract Types](#) for more information.

You can access the portal by selecting **Admin**, then **Market**, then **Market Contract Type**.

The following zones may appear as part of the portal's **Main** tab page:

- **Market Contract Type List:** This zone lists all market contract type records. Broadcast a record to display the details of the selected record.
- **Market Contract Type:** This zone displays details for the selected market contract type.

Market Products

Market Product Sets

Understanding Market Product Sets

Market Product Sets define the highest level grouping for a set of products that will be processed together. Market Product Sets are used by the Market Award Allocation settlement calculation rule as a way to gather a set of products and their related awards for division of load into an array of interval curves / vectors.

Market product sets define the following:

- The market associated with the product set
- The service type (electric, gas, etc.) of the product set

Configuring Market Product Sets

Refer to [Understanding Market Product Sets](#) for more information.

You can access the portal by selecting **Admin**, then **Market**, then **Market Product Set**. You are brought to a query portal with options for searching. Once your record has been selected you are brought to the maintenance portal to view and maintain the selected record.

The following zones may appear as part of the portal's **Main** tab page:

- **Market Product Set:** This zone displays details for the selected market product set.

Market Product Types

Understanding Market Product Types

Market Product Types define types of products used in settlement processing.

There are two primary types of market product types, each based on a specific business object:

- **Market Product Type:** Used for market product types whose award allocation is based on the configuration of the Market Award Allocation settlement calculation rule.
- **Formula-Based Market Type:** Used for market product types with more complex award allocation. This business object provides the ability to configure complex conditional calculations that take in both interval and scalar variables.

Market product types are defined by the following:

- **Division:** The division associated with the market product type.
- **Number of Decimals:** The number of decimal values used for market award quantities based on market products of this type.
- **Product Business Object:** The market product business object used for market products of this type.

- **Award Business Object:** The market award business object used for market awards based on market products of this type.
- **Calculation Details:** Applicable to Formula-Based Product Types only. Details used in performing formula-based calculations for market products of this type. Details include:
 - **Calculation Pre-Processing:** One or more algorithms to be executed prior to performing calculations for products of this type. These can include validation algorithms used to ensure the data being used by the calculations is valid and algorithms that retrieve, calculate, and store values used later in the calculation.
 - **Calculation Inputs:** Input variables (including Fixed Variables, Award Adhoc Characteristics, Factor Numbers, and Calculated Quantities) and Input Vectors (Fixed Vector Variables, Calculated Quantities, and Factor Profiles) that will be used in the calculations performed for products of this type.
 - **Calculations:** One or more calculations (based on the Calculation Inputs) to be performed for products of this type. Calculations can be based on Simple or Conditional formulas.
 - **Calculation Post-Processing:** Details of how the results of the calculations are saved and used in later processing. Options include:
 - **Save Results to Calculated Quantity:** Defines how calculation results are saved as service quantities on the Settlement Transaction that initiated the market product calculation and, if applicable, assigned to market contracts.
 - **Save Results to Characteristics:** Defines how calculation results are saved as characteristic values on the Settlement Transaction that initiated the market product calculation.

Configuring Market Product Types

Refer to [Understanding Market Product Types](#) for more information.

You can access the portal by selecting **Admin**, then **Market**, then **Market Product Type**.

The following zones may appear as part of the portal's **Main** tab page:

- **Market Product Type List:** This zone lists all market product type records. Broadcast a record to display the details of the selected record.
- **Market Product Type:** This zone displays details for the selected market product type.

Settlement Module Configuration

Oracle Utilities Market Settlements Management shares its application environment with other Oracle Utilities meter solution products, including Oracle Utilities Meter Data Management and Oracle Utilities Smart Grid Gateway. The default installation of any of these products provides access to all menu items and functionality provided with these products.

To configure the system such that only menu items and functionality used by Oracle Utilities Market Settlements Management is available, application users should be assigned to the following set of user groups:

- Meter Stack Common Services
- Meter Stack Common Batch Services*
- Settlement Services
- Settlement Batch Services*

*These user groups should be restricted to only those users who will be executing batch processing.

Refer to [Defining Users](#) in the *Oracle Utilities Application Framework Administrative User's Guide* for more information about setting up users.