

Oracle Banking Branch Integration Guide



14.7.5.0.0
G14869-02
September 2024



Oracle Banking Branch Integration Guide, 14.7.5.0.0

G14869-02

Copyright © 2021, 2024, Oracle and/or its affiliates.

This software and related documentation are provided under a license agreement containing restrictions on use and disclosure and are protected by intellectual property laws. Except as expressly permitted in your license agreement or allowed by law, you may not use, copy, reproduce, translate, broadcast, modify, license, transmit, distribute, exhibit, perform, publish, or display any part, in any form, or by any means. Reverse engineering, disassembly, or decompilation of this software, unless required by law for interoperability, is prohibited.

The information contained herein is subject to change without notice and is not warranted to be error-free. If you find any errors, please report them to us in writing.

If this is software, software documentation, data (as defined in the Federal Acquisition Regulation), or related documentation that is delivered to the U.S. Government or anyone licensing it on behalf of the U.S. Government, then the following notice is applicable:

U.S. GOVERNMENT END USERS: Oracle programs (including any operating system, integrated software, any programs embedded, installed, or activated on delivered hardware, and modifications of such programs) and Oracle computer documentation or other Oracle data delivered to or accessed by U.S. Government end users are "commercial computer software," "commercial computer software documentation," or "limited rights data" pursuant to the applicable Federal Acquisition Regulation and agency-specific supplemental regulations. As such, the use, reproduction, duplication, release, display, disclosure, modification, preparation of derivative works, and/or adaptation of i) Oracle programs (including any operating system, integrated software, any programs embedded, installed, or activated on delivered hardware, and modifications of such programs), ii) Oracle computer documentation and/or iii) other Oracle data, is subject to the rights and limitations specified in the license contained in the applicable contract. The terms governing the U.S. Government's use of Oracle cloud services are defined by the applicable contract for such services. No other rights are granted to the U.S. Government.

This software or hardware is developed for general use in a variety of information management applications. It is not developed or intended for use in any inherently dangerous applications, including applications that may create a risk of personal injury. If you use this software or hardware in dangerous applications, then you shall be responsible to take all appropriate fail-safe, backup, redundancy, and other measures to ensure its safe use. Oracle Corporation and its affiliates disclaim any liability for any damages caused by use of this software or hardware in dangerous applications.

Oracle®, Java, MySQL, and NetSuite are registered trademarks of Oracle and/or its affiliates. Other names may be trademarks of their respective owners.

Intel and Intel Inside are trademarks or registered trademarks of Intel Corporation. All SPARC trademarks are used under license and are trademarks or registered trademarks of SPARC International, Inc. AMD, Epyc, and the AMD logo are trademarks or registered trademarks of Advanced Micro Devices. UNIX is a registered trademark of The Open Group.

This software or hardware and documentation may provide access to or information about content, products, and services from third parties. Oracle Corporation and its affiliates are not responsible for and expressly disclaim all warranties of any kind with respect to third-party content, products, and services unless otherwise set forth in an applicable agreement between you and Oracle. Oracle Corporation and its affiliates will not be responsible for any loss, costs, or damages incurred due to your access to or use of third-party content, products, or services, except as set forth in an applicable agreement between you and Oracle.

Contents

1 Integration of FLEXCUBE Universal Banking

1.1	Maintenance for FLEXCUBE Universal Banking	1-1
1.1.1	Maintain Upload Source	1-2
1.1.2	Maintain Upload Source Preferences	1-2
1.1.3	Maintain External System	1-3
1.1.4	Maintain External System Functions	1-4
1.1.5	Maintain Gateway Amendment	1-9
1.1.6	Maintain Customer	1-10
1.1.7	Relationship Pricing Integration	1-11
1.1.7.1	Maintain External Price Components of Relationship Pricing	1-12
1.1.7.2	Maintain External Data Elements of Relationship Pricing	1-12
1.2	Maintenance for Oracle Banking Branch	1-13
1.2.1	Maintenance Using Oracle Banking Routing Hub	1-13
1.2.1.1	Configure Oracle Banking Branch	1-14
1.2.1.2	Configure Teller Transactions	1-15
1.2.1.3	Configure Relationship Pricing	1-19
1.2.1.4	Configure Account Services	1-22
1.2.1.5	Configure CASA 360	1-30
1.2.1.6	Configure Deposit Services	1-33
1.2.1.7	Configure Loan Services	1-38
1.2.2	Direct Access	1-43
1.2.3	Relationship Pricing Integration	1-44
1.2.3.1	Maintain Pricing Source System	1-44
1.2.3.2	Maintain Charge Definition	1-45
1.2.3.3	Charge Decision Maintenance	1-46
1.2.3.4	Transaction Charge Computation	1-46
1.3	Maintenance for Core Replication	1-47
1.3.1	Add Service Consumers	1-48
1.3.2	Maintain External Services	1-51
1.3.3	Maintain Upload Source Code	1-52

2 Integration of Oracle Banking Payments

2.1	Maintenance for Oracle Banking Branch	2-1
-----	---------------------------------------	-----

2.1.1	Create Entity	2-3
2.2	Maintenance for Oracle Banking Payments	2-4
2.2.1	Maintain Source Details and Source Network Preferences	2-4
2.2.2	Maintain External Notification and Queue Connection Profile	2-6

3 Integration of Oracle Banking Virtual Account Management

3.1	Configurations for Oracle Banking Branch	3-1
3.2	Maintenance for Oracle Banking Virtual Account Management	3-2
3.2.1	Maintain Entry in Common Core	3-2
3.2.2	Create User and Assign Role	3-2
3.2.3	Create Upload Source	3-4

Preface

- [Purpose](#)
- [Audience](#)
- [Documentation Accessibility](#)
- [Critical Patches](#)
- [Diversity and Inclusion](#)
- [Conventions](#)
- [Related Resources](#)

Purpose

This guide helps you integrate the Oracle Banking Branch product with FLEXCUBE Universal Banking, Oracle Banking Payments, and Oracle Banking Virtual Account Management.

Audience

This guide is primarily intended for the following user/user role:

Table User Roles - Description

Role	Function
Implementation and IT Staff	Implementation and maintenance of the software

Documentation Accessibility

For information about Oracle's commitment to accessibility, visit the Oracle Accessibility Program website at <http://www.oracle.com/pls/topic/lookup?ctx=acc&id=docacc>.

Access to Oracle Support

Oracle customer access to and use of Oracle support services will be pursuant to the terms and conditions specified in their Oracle order for the applicable services.

Critical Patches

Oracle advises customers to get all their security vulnerability information from the Oracle Critical Patch Update Advisory, which is available at [Critical Patches](#), [Security Alerts and Bulletins](#). All critical patches should be applied in a timely manner to ensure effective security, as strongly recommended by [Oracle Software Security Assurance](#)

Diversity and Inclusion

Oracle is fully committed to diversity and inclusion. Oracle respects and values having a diverse workforce that increases thought leadership and innovation. As part of our initiative to

build a more inclusive culture that positively impacts our employees, customers, and partners, we are working to remove insensitive terms from our products and documentation. We are also mindful of the necessity to maintain compatibility with our customers' existing technologies and the need to ensure continuity of service as Oracle's offerings and industry standards evolve. Because of these technical constraints, our effort to remove insensitive terms is ongoing and will take time and external cooperation.

Conventions

The following text conventions are used in this document:

Convention	Meaning
boldface	Boldface type indicates graphical user interface elements associated with an action, or terms defined in text or the glossary.
<i>italic</i>	Italic type indicates book titles, emphasis, or placeholder variables for which you supply particular values.
monospace	Monospace type indicates commands within a paragraph, URLs, code in examples, text that appears on the screen, or text that you enter.

Related Resources

The related documents in the Oracle Banking Branch Documentation Library are as follows:

- *Getting Started User Guide*
- *Oracle Banking Common Core User Guide*
- *Teller User Guide*
- *Oracle Banking Security Management System User Guide*

The related documents in the FLEXCUBE Universal Banking Documentation Library are as follows:

- *Common Core - Gateway User Guide*
- *Core Entities User Guide*
- *Relationship Pricing User Guide*
- *FLEXCUBE UBS - ELCM Integration Guide*

The related documents in the Oracle Banking Payments Documentation Library are as follows:

- *Payments Core User Guide*

1

Integration of FLEXCUBE Universal Banking

The FLEXCUBE Universal Banking can be integrated with the Oracle Banking Branch through specific maintenances.

The Oracle Banking Branch should be integrated with the FLEXCUBE Universal Banking. The following maintenance procedures are required to integrate these two products.

This topic contains the following subtopics:

- [Maintenance for FLEXCUBE Universal Banking](#)
You need to perform the maintenance in the FLEXCUBE Universal Banking for a particular source system (*OBTLR*) and (*OBSRV*) to complete the gateway setup.
- [Maintenance for Oracle Banking Branch](#)
- [Maintenance for Core Replication](#)
The FLEXCUBE Universal Banking is the host system that replicates the data to Oracle Banking Microservices Architecture core.

1.1 Maintenance for FLEXCUBE Universal Banking

You need to perform the maintenance in the FLEXCUBE Universal Banking for a particular source system (*OBTLR*) and (*OBSRV*) to complete the gateway setup.

This topic contains the following subtopics:

- [Maintain Upload Source](#)
You need to perform the upload source maintenance in the FLEXCUBE Universal Banking for the source system (*OBTLR*).
- [Maintain Upload Source Preferences](#)
You need to maintain the upload source preferences in the FLEXCUBE Universal Banking for the source system (*OBTLR*).
- [Maintain External System](#)
You need to perform the external system maintenance in the FLEXCUBE Universal Banking for the source system (*OBTLR*).
- [Maintain External System Functions](#)
You need to maintain the external system functions in the FLEXCUBE Universal Banking for the source system (*OBTLR* and *EXTSYS*).
- [Maintain Gateway Amendment](#)
You need to perform the gateway amendment maintenance in the FLEXCUBE Universal Banking for the source system (*OBTLR*).
- [Maintain Customer](#)
You need to maintain the utility provider details in the FLEXCUBE Universal Banking on the **Customer Maintenance** screen.
- [Relationship Pricing Integration](#)

1.1.1 Maintain Upload Source

You need to perform the upload source maintenance in the FLEXCUBE Universal Banking for the source system (OBTLR).

Log in to FLEXCUBE Universal Banking Homepage. For information on how to log in, refer to the *Procedures User Guide* in the FLEXCUBE Universal Banking Documentation Library.

To maintain the upload source:

1. On the Homepage, specify **CODSORCE** in the text box, and click the next arrow.
The **Upload Source Maintenance** screen is displayed.
2. On the **Upload Source Maintenance** screen, specify the details in the fields as shown in the figure. For information on the fields, refer to the *Common Core - Gateway User Guide* in the FLEXCUBE Universal Banking Documentation Library.

Figure 1-1 Upload Source Maintenance

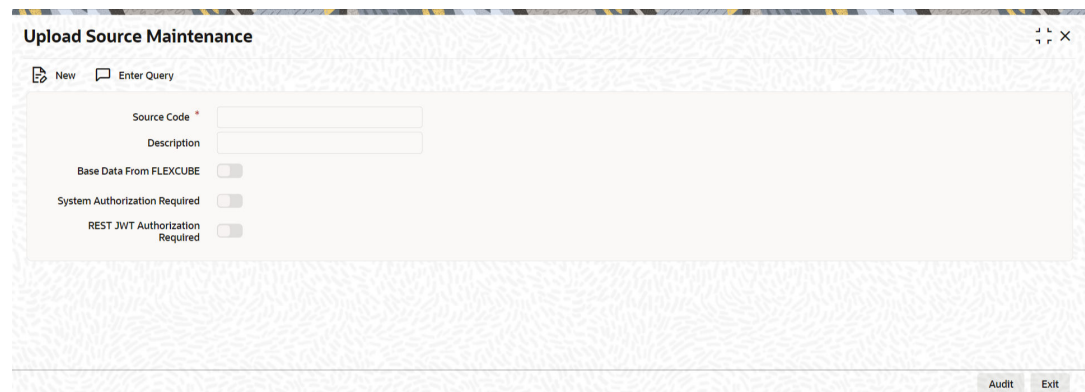

1.1.2 Maintain Upload Source Preferences

You need to maintain the upload source preferences in the FLEXCUBE Universal Banking for the source system (OBTLR).

Log in to FLEXCUBE Universal Banking Homepage. For information on how to log in, refer to the *Procedures User Guide* in the FLEXCUBE Universal Banking Documentation Library.

To maintain the upload source preferences:

1. On the Homepage, specify **CODUPLDM** in the text box, and click the next arrow.
The **Upload Source Preferences Maintenance** screen is displayed.
2. On the **Upload Source Preferences Maintenance** screen, maintain the source system (OBTLR) for the following module codes. For information on the fields, refer to the *Common Core - Gateway User Guide* in the FLEXCUBE Universal Banking Documentation Library.
 - IC
 - CO
 - AC
 - CS

- DL
- IA
- IF
- ST
- CA
- CL
- CI

Figure 1-2 Upload Source Preferences Maintenance

3. On the Homepage, specify **COSUPLDM** in the text box, and click the next arrow. The **Upload Source Preferences Summary** screen is displayed.
4. On the **Upload Source Preferences Summary** screen, verify the maintained source codes and module codes. For information on the fields, refer to the *Common Core - Gateway User Guide* in the FLEXCUBE Universal Banking Documentation Library.

Figure 1-3 Upload Source Preferences Summary

Authorization Status	Record Status	Source Code	Module Code	Status	On Error	On Override	Purge Days
Authorized	Open	ACUMEN	CA	Authorized	Reject	Ignore	

1.1.3 Maintain External System

You need to perform the external system maintenance in the FLEXCUBE Universal Banking for the source system (OBTLR).

Log in to FLEXCUBE Universal Banking Homepage. For information on how to log in, refer to the *Procedures User Guide* in the FLEXCUBE Universal Banking Documentation Library.

To maintain the external system:

1. On the Homepage, specify **GWDETSYS** in the text box and click the next arrow.
The **External System Maintenance** screen is displayed.
2. On the **External System Maintenance** screen, specify the details in the fields as shown in the figure. For information on the fields, refer to the *Common Core - Gateway User Guide* in the FLEXCUBE Universal Banking Documentation Library.

Figure 1-4 External System Maintenance

1.1.4 Maintain External System Functions

You need to maintain the external system functions in the FLEXCUBE Universal Banking for the source system (OBTLR and EXTSYS).

Log in to FLEXCUBE Universal Banking Homepage. For information on how to log in, refer to the *Procedures User Guide* in the FLEXCUBE Universal Banking Documentation Library.

Maintain the external system functions as follows:

1. On the Homepage, specify **GWDEFUN** in the text box, and click the next arrow.
The **External System Functions** screen is displayed.
2. On the **External System Functions** screen, specify the details in the fields as shown in the figure. For information on the fields, refer to the *Common Core - Gateway User Guide* in the FLEXCUBE Universal Banking Documentation Library.

Figure 1-5 External System Functions

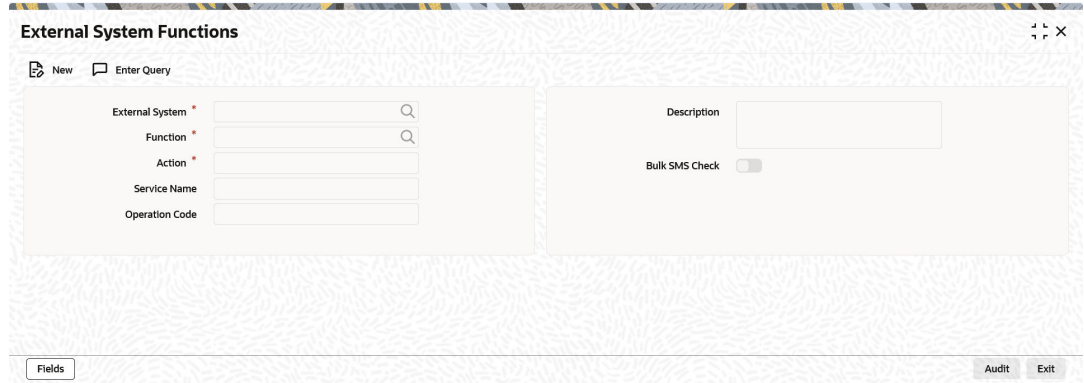

The details of external system functions for each screen are provided in table.

Table 1-1 Details for External System - OBTLR

Function Code	Screen Name	Screen Type	Details of external call	FUNCTION ID	ACTION
TDO1	TD Account Opening	Transaction Screen	FCUBSAccService/ CreateTDCustAcc	STGCUSTD	NEW
			FCUBSSTService/ QueryAccClasMaint	STQACCLS	NEW
TDR1	TD Redemption Against Cash	Transaction Screen	FCUBSTDSservice/ CreateTDRedem	ICGREDMN	NEW
			FCUBSAccService/ QueryCustAccBalance	ACQABLQY	VIEW
TDR2	TD Redemption Against Account	Transaction Screen	FCUBSTDSservice/ CreateTDRedem	ICGREDMN	NEW
			FCUBSAccService/ QueryCustAccBalance	ACQABLQY	VIEW
TDT1	TD Top-Up Against Cash	Transaction Screen	FCUBSAccService/ CreateTDTopUp	STGTDTOP	NEW
			FCUBSAccService/ QueryTDCustAcc	STQCUSTD	VIEW
TDT2	TD Top-Up Against Account	Transaction Screen	FCUBSAccService/ CreateTDTopUp	STGTDTOP	NEW
			FCUBSAccService/ QueryTDCustAcc	STQCUSTD	VIEW
1301	Close-out Withdrawal by Cash	Transaction Screen	FCUBSAccService/ CloseCustAcc	STGCUSAC	CLOSE
			FCUBSAccService/ QueryCustAccBalance	ACQABLQY	VIEW

Table 1-1 (Cont.) Details for External System - OBTLR

Function Code	Screen Name	Screen Type	Details of external call	FUNCTION ID	ACTION
1320	Close-out Withdrawal by Account	Transaction Screen	FCUBSAccService/CloseCustAcc	STGCUSAC	CLOSE
			FCUBSAccService/QueryCustAccBalance	ACQABLQY	VIEW
ACBL	Account Balance Inquiry	Inquiry Screen	FCUBSAccService/QueryAcctBal	STQCUSBL	VIEW
ACST	Account Statement Request	Transaction Screen	FCUBSAccFinService/RequestAccStmt	GWACSTMT	VIEW
CQRQ	Cheque Book Request	Transaction Screen	FCUBSAccService/CreateCheckBook	CAGCHBOO	NEW
CQIN	Cheque Status Inquiry	Inquiry Screen	FCUBSAccService/QueryCheckDetails	CAQCHKDT	VIEW
CADU	Customer Address Update	Transaction Screen	FCUBSCustomerService/ModifyCustomer	STGCIF	UNLOCK
AADU	Account Address Update	Transaction Screen	FCUBSAccService/ModifyCustAcc	STGCUSAC	UNLOCK
CCTU	Customer Contact Details Update	Transaction Screen	FCUBSCustomerService/ModifyCustomer	STGCIF	UNLOCK
7030	Passbook Issue	Transaction Screen	FCUBSRTService/CreateAccPassbook	DEGRTCAP	NEW
7010	Passbook Update	Transaction Screen	FCUBSRTService/UpdateAccPassbook	DEGRTUAP	NEW
CQST	Stop Cheque Request	Transaction Screen	FCUBSAccService/CreateStopPayments	CAGSPMNT	NEW
5001	Loan Disbursement By Cash	Transaction Screen	FCUBSCLService/QueryAccount	CLQACCNT	VIEW
			FCUBSCLService/CreateDisbursement	CLGMNDSB	NEW
5401	Loan Repayment By Cash	Transaction Screen	FCUBSCLService/QueryAccount	CLQACCNT	VIEW
			FCUBSCLService/CreatePayment	CLGPYMNT	NEW
3401	Safe Deposit Rental By Cash	Transaction Screen	RTService/QuerySDRental FCUBSDLService/CreatePayment	DLGPAMNT	NEW

Table 1-1 (Cont.) Details for External System - OBTLR

Function Code	Screen Name	Screen Type	Details of external call	FUNCTION ID	ACTION
5402	Murabaha Payment by Cash	Transaction Screen	FCUBSCIService/QueryAccount	CIQACCNT	VIEW
			FCUBSCIService/CreatePayment	CIGPYMNT	NEW
5403	Islamic Financing Downpayment by Cash	Transaction Screen	FCUBSCIService/QueryAccount	CIQACCNT	VIEW
			FCUBSCIService/Createdownpayment	CIGDPYNT	NEW
TDI1	Islamic TD Account Opening	Transaction Screen	FCUBSIAService/QueryIAAccClass	IAQACCLS	VIEW
			FCUBSIAService/CreateIATDCustAcc	IAGCUSTD	NEW
CDBK	Stop Card Request	Transaction Screen	FCUBSSTService/SummaryQueryCardMaster	STVCRDMS	VIEW
			FCUBSSTService/ModifyCardMaster	STGCRDMS	UNLOCK

Table 1-2 Details for External System - EXTSYS

Screen Name	Screen Type	Details of external call	FUNCTION ID	ACTION
Card Status Change	Maintenance Screen	FCUBSSTService/SummaryQueryCardMaster	STVCRDMS	VIEW
Create Business Product	Maintenance Screen	FCUBSSIService/SummaryQueryProduct	SIVPRMNT	VIEW
Outstanding Account Balance Inquiry	Inquiry Screen	ConsumerLendingAccBalanceService/ConsumerLendingAccBalance/QueryAccBalance	CLDFGSTC	VIEW
Schedule Balance Inquiry	Inquiry Screen	ConsumerLendingSchBalanceService/ConsumerLendingSchBalance/QuerySchBalance	CLDFGSNQ	VIEW
Repayment Date Change	Transaction Screen	ConsumerLendingChangeRpmntDtService/ConsumerLendingChangeRpmntDt/ModifyChangeRpmntDt	CLDFGRDM	UNLOCK
		ConsumerLendingChangeRpmntDtService/ConsumerLendingChangeRpmntDt/QueryChangeRpmntDt	CLDFGRDM	VIEW

Table 1-2 (Cont.) Details for External System - EXTSYS

Screen Name	Screen Type	Details of external call	FUNCTION ID	ACTION
View Account Statement	Transaction Screen	ConsumerLendingLoanStatementService/ ConsumerLendingLoanStatement/ AuthorizeLoanStatement	CLDLSTMT	AUTHORIZE
Loan Renegotiation	Transaction Screen	ConsumerLendingAccRenogService/ ConsumerLendingAccRenog/ ModifyAccRenog	CLDFGREN	UNLOCK
Loan Renegotiation	Transaction Screen	ConsumerLendingAccRenogService/ ConsumerLendingAccRenog/ CreateAccRenog	CLDFGREN	AUTHORIZE
Loan Renegotiation	Transaction Screen	/ ConsumerLendingAccRenogService/ ConsumerLendingAccRenog/ QueryAccRenog/accountNumber/	CLDFGREN	VIEW
Disburse	Transaction Screen	ConsumerLendingAccDsbrService/ ConsumerLendingAccDsbr/ CreateAccDsbr/	CLDFGDSB	UNLOCK
Disburse	Transaction Screen	ConsumerLendingAccDsbrService/ ConsumerLendingAccDsbr/ CreateAccDsbr/	CLDFGDSB	AUTHORIZE
Disburse	Transaction Screen	/ ConsumerLendingAccRenogService/ ConsumerLendingAccRenog/ QueryAccRenog/accountNumber/	CLDFGREN	VIEW
Loan Write-Off	Transaction Screen	ConsumerLendingLoanWriteoffService/ ConsumerLendingLoanWriteoff/ QueryLoanWriteoff/ accountNumber/{accountNumber}/ effectiveDate/{effectiveDate}	CLDFGPWF	VIEW
Loan Write-Off	Transaction Screen	ConsumerLendingLoanWriteoffService/ ConsumerLendingLoanWriteoff/ CreateLoanWriteoff	CLDFGPWF	UNLOCK
Loan Write-Off	Transaction Screen	ConsumerLendingLoanWriteoffService/ ConsumerLendingLoanWriteoff/ CreateLoanWriteoff	CLDFGPWF	AUTHORIZE
Adhoc Refund	Transaction Screen	ConsumerLendingLoanAdhocService/ ConsumerLendingLoanAdhoc/ CreateLoanAdhoc	CLDFGADH	NEW
Adhoc Refund	Transaction Screen	ConsumerLendingLoanAdhocService/ ConsumerLendingLoanAdhoc/ CreateLoanAdhoc	CLDFGADH	AUTHORIZE
Adhoc Refund	Transaction Screen	ConsumerLendingLoanAdhocService/ ConsumerLendingLoanAdhoc/ CreateLoanAdhoc	CLDFGADH	UNLOCK

Table 1-2 (Cont.) Details for External System - EXTSYS

Screen Name	Screen Type	Details of external call	FUNCTION ID	ACTION
Loan Payment	Transaction Screen	ConsumerLendingLoanPaymentService/ ConsumerLendingLoanPayment/ QueryLoanPayment/ accountNumber/{accountNumber}/ valueDate/{valueDate}	CLDFGPMT	VIEW
Loan Payment	Transaction Screen	ConsumerLendingLoanPaymentService/ ConsumerLendingLoanPayment/ CreateLoanPayment	CLDFGPMT	NEW
Loan Payment	Transaction Screen	ConsumerLendingLoanPaymentService/ ConsumerLendingLoanPayment/ CreateLoanPayment	CLDFGPMT	AUTHORIZE
Loan Payment	Transaction Screen	ConsumerLendingLoanPaymentService/ ConsumerLendingLoanPayment/ CreateLoanPayment	CLDFGPMT	UNLOCK
Loan Activation	Transaction Screen	/ ConsumerLendingAccountActivate/ CreateAccountActivate	CLDFGACT	NEW
Consolidated Rollover	Transaction Screen	/ ConsumerLendingConsolRollover/ QueryConsolRollover/ customerId/{customerId}	CLDFGCRL	VIEW
Consolidated Rollover	Transaction Screen	/ ConsumerLendingConsolRollover/ CreateConsolRollover	CLDFGCRL	NEW

1.1.5 Maintain Gateway Amendment

You need to perform the gateway amendment maintenance in the FLEXCUBE Universal Banking for the source system (OBTLR).

Log in to FLEXCUBE Universal Banking Homepage. For information on how to log in, refer to the *Procedures User Guide* in the FLEXCUBE Universal Banking Documentation Library.

To maintain the gateway amendment:

1. On the Homepage, specify **GWDAMDMT** in the text box, and click the next arrow.
The **Gateway Amendment Maintenance** screen is displayed.
2. On the **Gateway Amendment Maintenance** screen, specify the details in the fields as shown in the figure. For information on the fields, refer to the *Common Core - Gateway User Guide* in the FLEXCUBE Universal Banking Documentation Library.

Figure 1-6 Gateway Amendment Maintenance

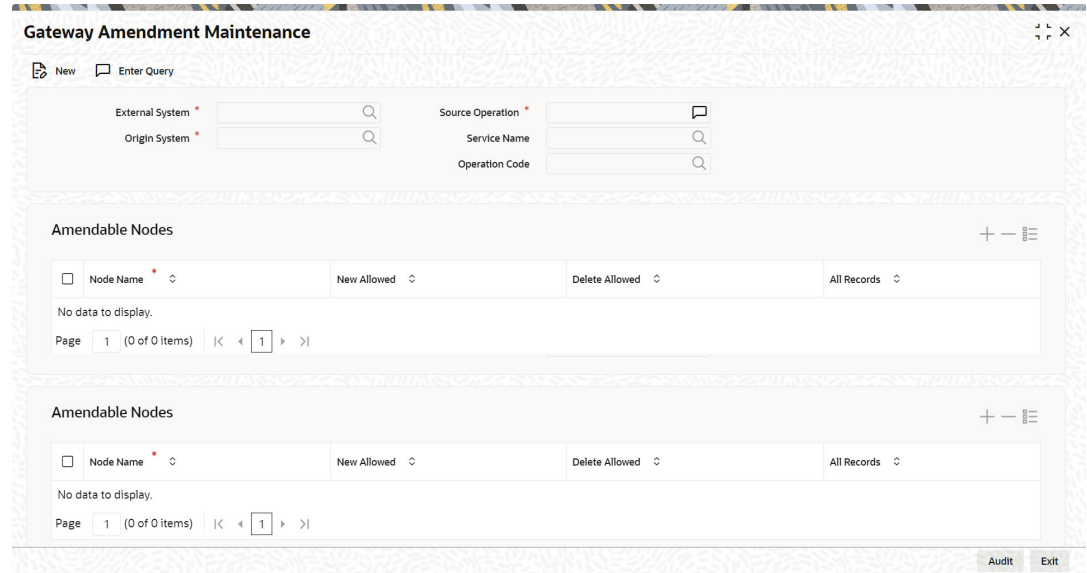

1.1.6 Maintain Customer

You need to maintain the utility provider details in the FLEXCUBE Universal Banking on the **Customer Maintenance** screen.

Log in to FLEXCUBE Universal Banking Homepage. For information on how to log in, refer to the *Procedures User Guide* in the FLEXCUBE Universal Banking Documentation Library.

Maintain the utility provider details as follows:

1. On the Homepage, specify **STDCIF** in the text box, and click the next arrow.
The **Customer Maintenance** screen is displayed.
2. On the **Customer Maintenance** screen, specify the following details in the **Auxiliary** tab.
For information on the fields, refer to the *Common Core - Gateway User Guide* in the FLEXCUBE Universal Banking Documentation Library.
 - **Utility Provider**
 - **Utility Provider Type**
 - **Utility Provider Id**

Figure 1-7 Customer Maintenance

1.1.7 Relationship Pricing Integration

This topic contains the following subtopics:

- [Maintain External Price Components of Relationship Pricing](#)
You need to maintain the external price components of the relationship pricing in the FLEXCUBE Universal Banking.
- [Maintain External Data Elements of Relationship Pricing](#)
You need to maintain the external data elements of the Oracle Banking Branch in the FLEXCUBE Universal Banking.
- [Maintain Pricing Source System](#)
You need to maintain the pricing source system (UBS-RP) to integrate the relationship pricing with the Oracle Banking Branch.
- [Maintain Charge Definition](#)
You need to maintain the charge codes in the **Charge Definition Maintenance** screen and link them to the pricing source system. In addition, you need to link the corresponding External System Elements (EDE) applicable for the charge code.

- [Charge Decision Maintenance](#)
The charge decision maintenance enables the integration of the relationship pricing with the Oracle Banking Branch.
- [Transaction Charge Computation](#)
The transaction charge computation happens through a charge service call from the **Charge Decision Maintenance** screen to the common core.

1.1.7.1 Maintain External Price Components of Relationship Pricing

You need to maintain the external price components of the relationship pricing in the FLEXCUBE Universal Banking.

Log in to FLEXCUBE Universal Banking Homepage. For information on how to log in, refer to the *Procedures User Guide* in the FLEXCUBE Universal Banking Documentation Library.

To maintain the external price components:

1. On the Homepage, specify **CODEXTCO** in the text box, and click the next arrow.
The **Relationship Pricing External Price Components Maintenance** screen is displayed.
2. On the **Relationship Pricing External Price Components Maintenance** screen, specify the fields as shown in the figure. For information on the fields, refer to the *Relationship Pricing User Guide* in the FLEXCUBE Universal Banking Documentation Library.

Figure 1-8 Relationship Pricing External Price Components Maintenance

Note:

You can also specify the function code in the **Product** field. The charge code specified in the **Price Component** field needs to be maintained in the charge definition of the Oracle Banking Branch.

1.1.7.2 Maintain External Data Elements of Relationship Pricing

You need to maintain the external data elements of the Oracle Banking Branch in the FLEXCUBE Universal Banking.

Log in to FLEXCUBE Universal Banking Homepage. For information on how to log in, refer to the *Procedures User Guide* in the FLEXCUBE Universal Banking Documentation Library.

To maintain the external data elements:

1. On the Homepage, specify **CODEDEMT** in the text box, and click the next arrow.
The **Relationship Pricing External Data Elements Maintenance** screen is displayed.
2. On the **Relationship Pricing External Data Elements Maintenance** screen, specify the details in the fields as shown in the figure. For information on the fields, refer to the *Common Core - Gateway User Guide* in the FLEXCUBE Universal Banking Documentation Library.

 **Note:**

The details of the external data elements of the Oracle Banking Branch are provided in the table `FCC_OBREMO_BRANCH_COMMON.SRV_TM_BC_EDE_LIST`.

Figure 1-9 Relationship Pricing External Data Elements Maintenance

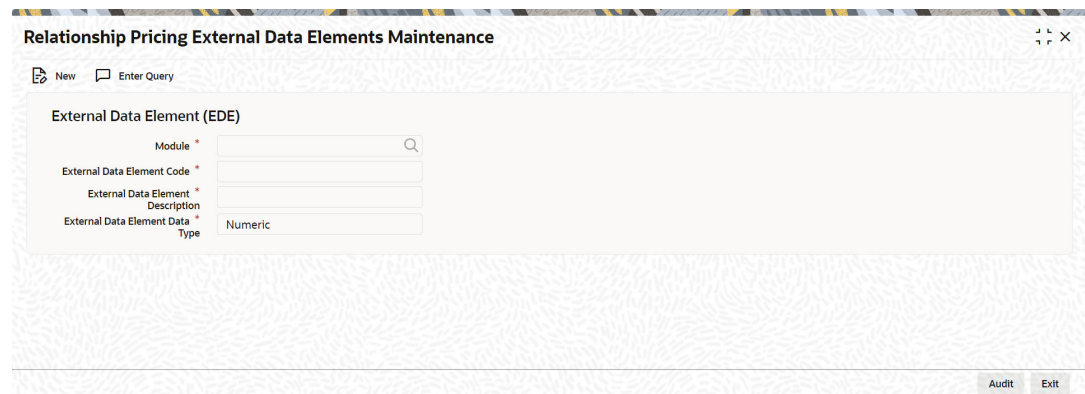

1.2 Maintenance for Oracle Banking Branch

Maintenance for the Oracle Banking Branch needs to be performed to integrate with the FLEXCUBE Universal Banking.

This topic contains the following subtopics:

- [Maintenance Using Oracle Banking Routing Hub](#)
The maintenance for the Oracle Banking Branch can be performed through the Oracle Banking Routing Hub.
- [Direct Access](#)
The specific configurations are needed for the Oracle Banking Branch to integrate with the FLEXCUBE Universal Banking. The direct access feature will be discontinued in the future.
- [Relationship Pricing Integration](#)

1.2.1 Maintenance Using Oracle Banking Routing Hub

The maintenance for the Oracle Banking Branch can be performed through the Oracle Banking Routing Hub.

Oracle Banking Routing Hub enables seamless and standardized integrations between FSGBU Banking Product using configurations provided as part of the product infrastructure.

Figure 1-10 Integrations in Oracle Banking Routing Hub

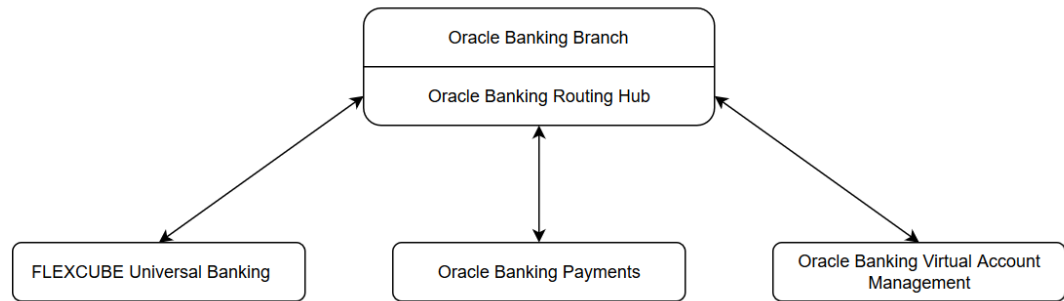

This topic contains the following subtopics:

- [Configure Oracle Banking Branch](#)
You need to perform the specific configurations needed for Oracle Banking Branch to integrate with FLEXCUBE Universal Banking using Oracle Banking Routing Hub.
- [Configure Teller Transactions](#)
You can maintain the routing configuration of Oracle Banking Routing Hub in the common core for Oracle Banking Branch teller transitions to create, update, query, or delete the host system. A host system can be FLEXCUBE Universal Banking, Oracle Banking Payments, etc.
- [Configure Relationship Pricing](#)
The Relationship Pricing Integration for FLEXCUBE Universal Banking and Oracle Banking Branch is performed through REST. The `CreateQueryPrice` REST service is used to derive Relationship Pricing charge computation from the FLEXCUBE Universal Banking pricing engine.
- [Configure Account Services](#)
You can maintain the routing configuration of the Oracle Banking Routing Hub in the common core for CASA transitions of the Oracle Banking Branch to create, update, and query the host system. A host system can be FLEXCUBE Universal Banking.
- [Configure CASA 360](#)
You can maintain the routing configuration of Oracle Banking Routing Hub in the common core for the CASA 360 service of the Oracle Banking Branch to create, update, and query the host system. A host system can be FLEXCUBE Universal Banking.
- [Configure Deposit Services](#)
You can maintain the routing configuration of the Oracle Banking Routing Hub in the common core for Deposit Servicing transitions of the Oracle Banking Branch to create, update, and query the host system. A host system can be FLEXCUBE Universal Banking.
- [Configure Loan Services](#)
You can maintain the routing configuration of the Oracle Banking Routing Hub in common core for Loans transitions of the Oracle Banking Branch to create, update, and query the host system. A host system can be FLEXCUBE Universal Banking.

1.2.1.1 Configure Oracle Banking Branch

You need to perform the specific configurations needed for Oracle Banking Branch to integrate with FLEXCUBE Universal Banking using Oracle Banking Routing Hub.

Connect to the database schema to configure the values in the database tables.

Update the following values in the `BRANCHCOMMON` schema to configure the Oracle Banking Branch:

Set `IS_ROUTING_ENABLED = Y` in the `SRV_TM_BC_FUNCTION_INDICATOR` for the function codes that are routed via Oracle Banking Routing Hub.



Note:

Check if the `SRV_TM_BC_FUNCTION_INDICATOR_ROUTE_DTLS` has an entry for the screen's function code.

1.2.1.2 Configure Teller Transactions

You can maintain the routing configuration of Oracle Banking Routing Hub in the common core for Oracle Banking Branch teller transitions to create, update, query, or delete the host system. A host system can be FLEXCUBE Universal Banking, Oracle Banking Payments, etc.

Log in to Oracle Banking Branch Homepage. For information on how to log in, refer to *Getting Started User Guide* in the Oracle Banking Branch Documentation Library.

To configure teller transactions:

1. On the Homepage, click **Core Maintenance**. Under **Core Maintenance**, click **Routing Hub**, and then select **Service Consumers** or specify **Service Consumers** in the search icon bar and select the screen.

The **Service Consumers** screen is displayed.

Figure 1-11 Service Consumers - Teller Transactions

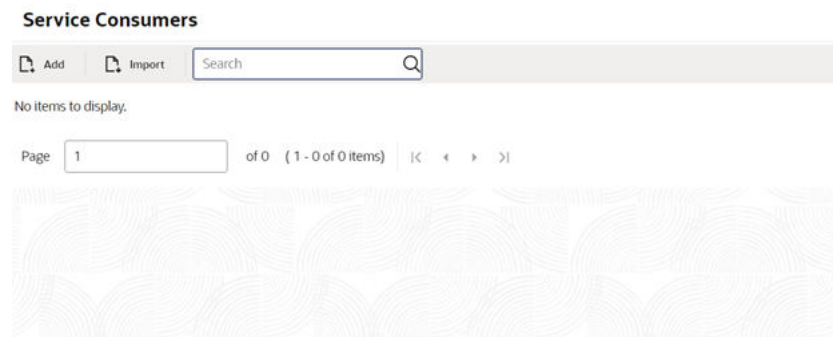

2. Click **Import**.

The **Import Service Consumer** pop-up screen is displayed.

3. On the **Import Service Consumer** pop-up screen, click **Select** and upload the `OBREMO_TELLER_Consumer.json` file provided in the release.



Note:

The folder path for the `OBREMO_TELLER_Consumer.json` file is `\OBBRN_ROUTING_CONFIGURATION`.

4. Click **Extract**.
The data is extracted successfully.
5. Select all the extracted service providers, and click **Import**.

Figure 1-12 Service Provider Selection - Teller

Import Service Consumer

File

OBREMO_TELLER_Consumer.json Select Extract

Name

OBREMO_TELLER

Overwrite extended templates

Yes No

Service Providers

- Name
- FCUBSAccFinService 14.6.0.0.0
- FCUBSAccService 14.6.0.0.0

Import

The service consumers are imported successfully. A sample screen after import operation is shown below.

Figure 1-13 Imported Service Consumers - Teller

Service Consumers

Add Import

OBREMO_TELLER

Page 1 of 1 (1 - 1 of 1 Items) < 1 >

- Click **OBREMO_TELLER**.
The service providers are displayed.

Figure 1-14 View Service Providers - Teller

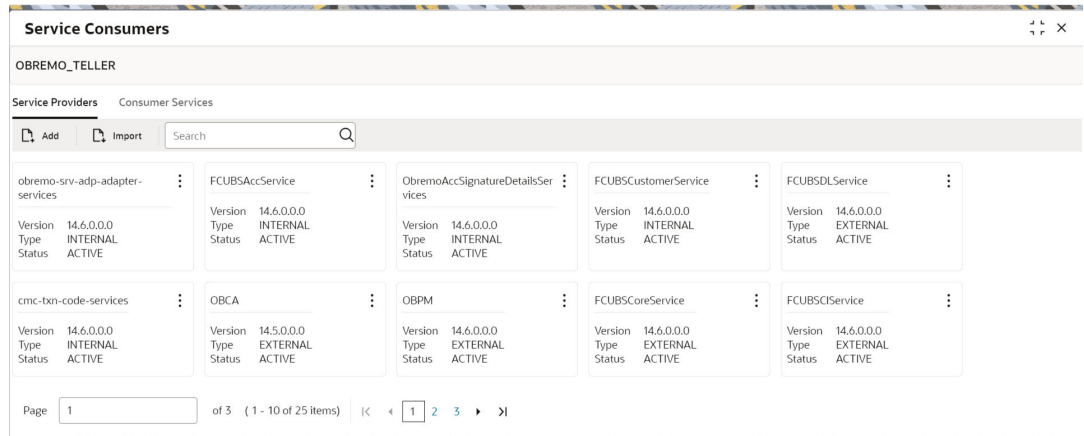

- Select individual service provider, and click **Edit**.
The **Edit Implementation** pop-up screen is displayed.

Figure 1-15 Edit Implementation - Teller

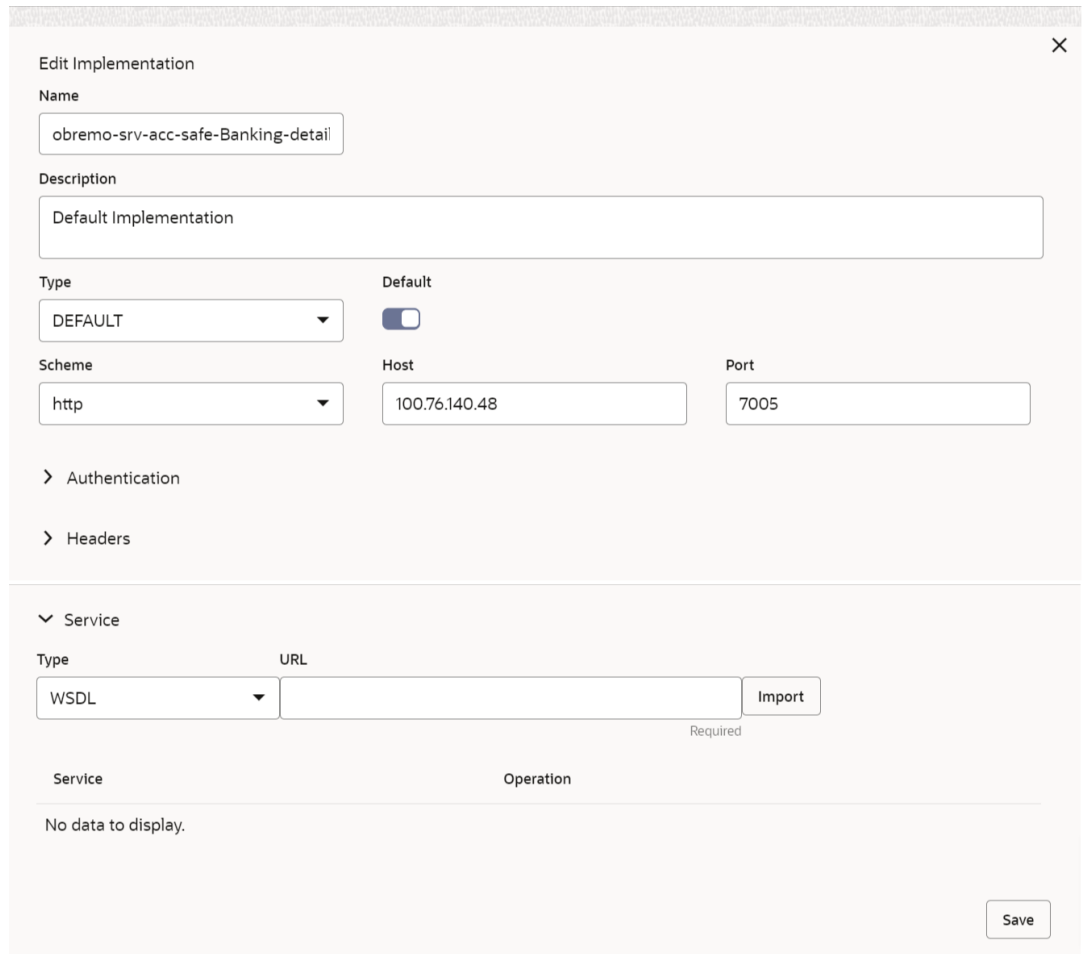

- On the **Edit Implementation** pop-up screen, specify the **Host** and **Port** as per the host system (FLEXCUBE Universal Banking or Oracle Banking Payments) installation, and click **Save**.

The implementation details are saved for the service provider.

- Perform steps 1 thru 8 again for all the service providers. The list of consumer services are shown in the figure below.

Figure 1-16 List of Service Providers

The figure displays four screenshots of the 'Service Consumers' interface for the 'OBREMO_TELLER' entity. Each screenshot shows a table of consumer services with columns for 'Actions', 'Name', and 'Description'. The interface includes navigation elements like 'Add', 'Import', and 'Search' buttons, and a pagination control at the bottom of each table.

Screenshot 1 (Page 1): Shows 3 items. The table contains:

Actions	Name	Description
⋮	postInsDuplicate	Instrument Duplicate
⋮	CreateTDTopUpFS	Create TD top up in host system
⋮	ModifyCustAcclO	Account address update

Screenshot 2 (Page 2): Shows 3 items. The table contains:

Actions	Name	Description
⋮	QueryRDPmtSchInq	Query RD
⋮	postClearingRoutingNoQuery	Fetch routing numbers based on clearing network code
⋮	doTransaction	do transaction

Screenshot 3 (Page 3): Shows 3 items. The table contains:

Actions	Name	Description
⋮	postInstrumentPaymentReversal	Create instrument payment reversal request
⋮	postInstrumentIssue	Instrument Issue
⋮	postSinglePayOut	Single payout for transfer transactions

Screenshot 4 (Page 4): Shows 3 items. The table contains:

Actions	Name	Description
⋮	invokeEcaAction	Create ECA to block money in account
⋮	PassbookReprintFS	Reprint Account Passbook Details
⋮	CreateDisbursementFS	Create Loan Disbursement

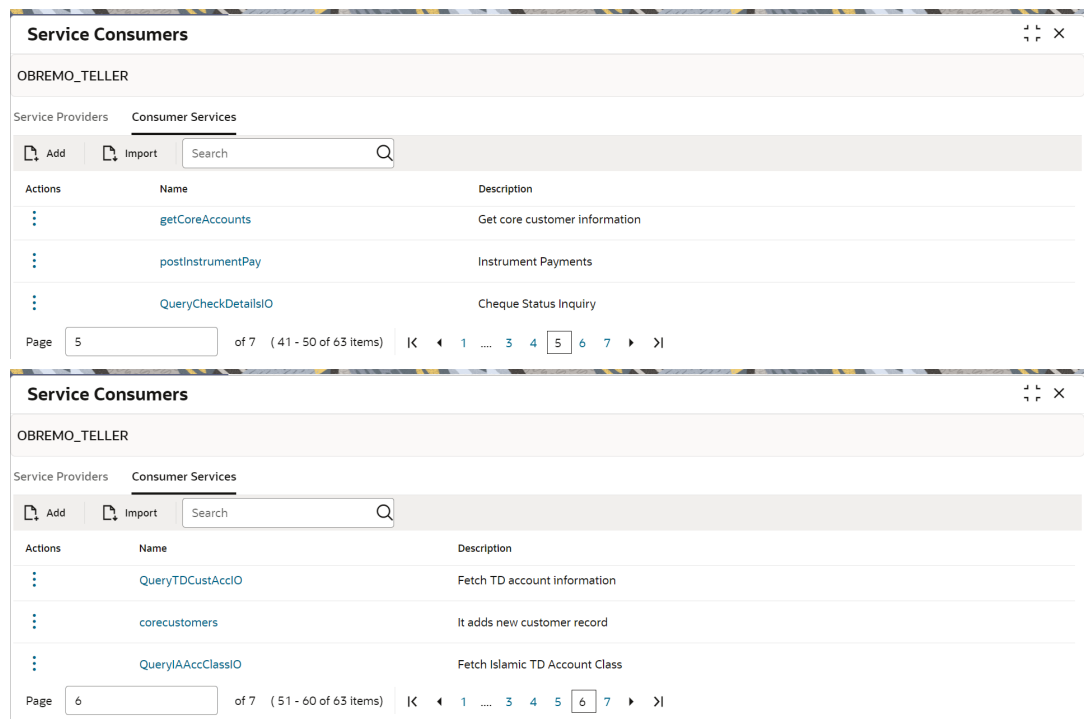

1.2.1.3 Configure Relationship Pricing

The Relationship Pricing Integration for FLEXCUBE Universal Banking and Oracle Banking Branch is performed through REST. The `CreateQueryPrice` REST service is used to derive Relationship Pricing charge computation from the FLEXCUBE Universal Banking pricing engine.

Log in to Oracle Banking Branch Homepage. For information on how to log in, refer to *Getting Started User Guide* in the Oracle Banking Branch Documentation Library.

Oracle Banking Routing Hub is responsible for the handling of API calls between Oracle Banking Branch and external systems (FLEXCUBE Universal Banking in case of Relationship Pricing calls). The configuration templates for Oracle Banking Routing Hub are provided along with the product releases and need to be imported through the **Service Consumers** screen.

To configure relationship pricing:

1. On the Homepage, click **Core Maintenance**. Under **Core Maintenance**, click **Routing Hub**, and then select **Service Consumers** or specify **Service Consumers** in the search icon bar and select the screen.

The **Service Consumers** screen is displayed.

Figure 1-17 Service Consumers - Relationship Pricing



2. Click **Import**.
The **Import Service Consumer** pop-up screen is displayed.
3. On the **Import Service Consumer** pop-up screen, click **Select** and upload the `CMC_CHARGES.json` file provided in the release.

Figure 1-18 Upload JSON file - Relationship Pricing

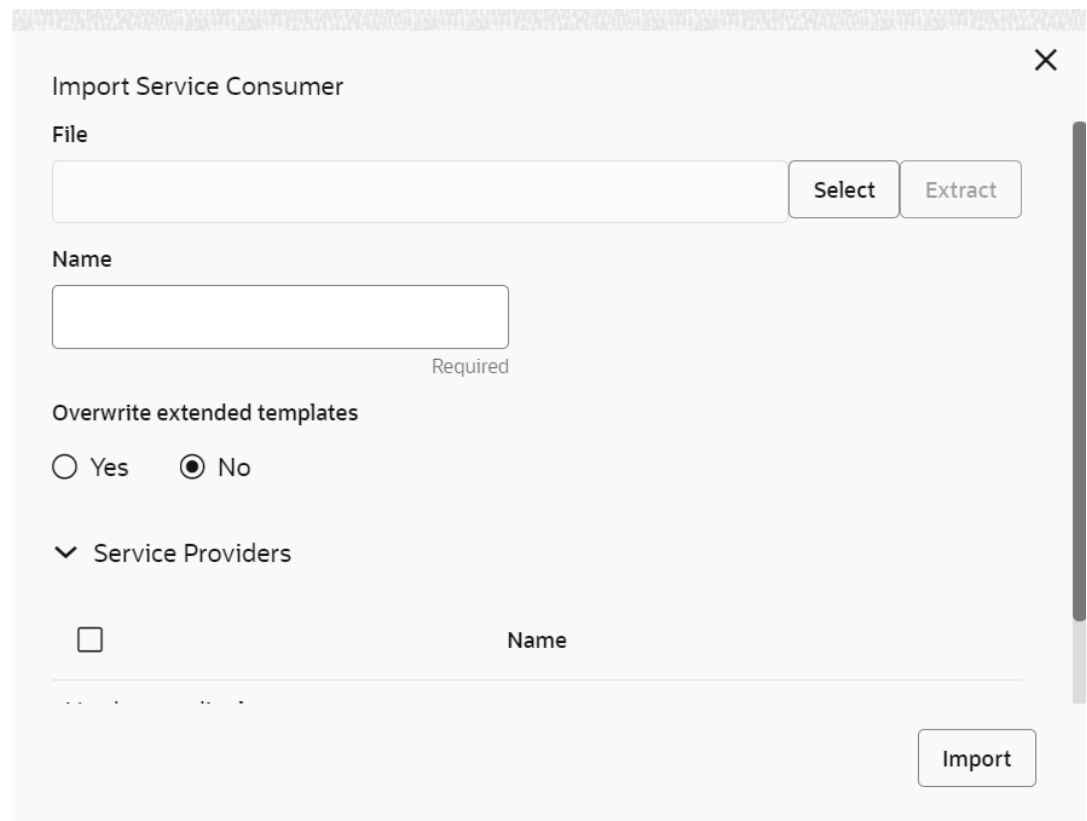

4. Click **Extract**.

 **Note:**

As an alternative method, `CSTB_PARAM -GW_LOGUSER_CHECK` can be maintained as `N`, if the gateway user is an Oracle Banking Branch user.

The data is extracted successfully.

5. Select all the extracted service providers, and click **Import**.

Figure 1-19 Service Provider Selection - Relationship Pricing

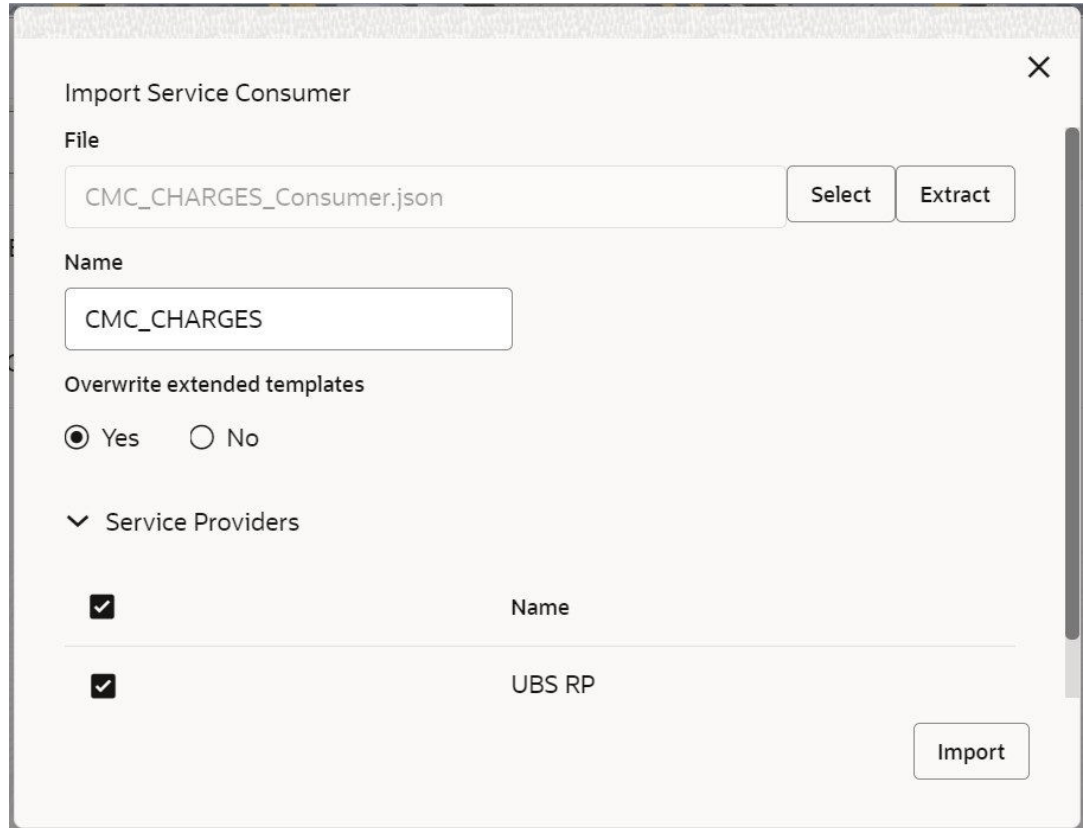

The service consumers are imported successfully. A sample screen after import operation is shown below.

Figure 1-20 Imported Service Consumers - Relationship Pricing

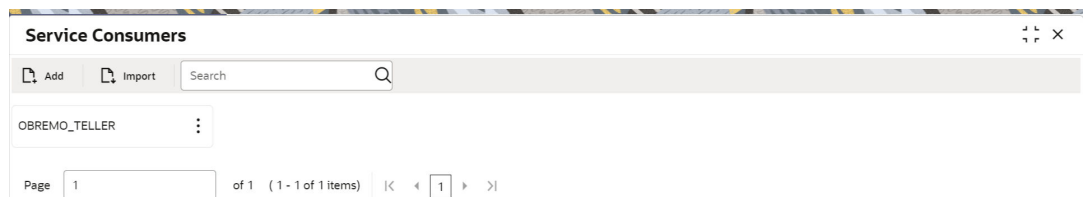

6. Click on the individual service provider.
The details of the imported service provider are displayed.

Figure 1-21 View Service Provider - Relationship Pricing

The screenshot shows the 'Service Consumers' interface for 'OBREMO_TELLER'. It features a search bar and a table with columns for 'Actions', 'Name', and 'Description'. The table lists three services: 'postInsDuplicate' (Instrument Duplicate), 'CreateTDTopUpFS' (Create TD top up in host system), and 'ModifyCustAcclID' (Account address update). A pagination bar at the bottom indicates 'Page 1 of 7 (1 - 10 of 67 items)'.

Actions	Name	Description
⋮	postInsDuplicate	Instrument Duplicate
⋮	CreateTDTopUpFS	Create TD top up in host system
⋮	ModifyCustAcclID	Account address update

1.2.1.4 Configure Account Services

You can maintain the routing configuration of the Oracle Banking Routing Hub in the common core for CASA transitions of the Oracle Banking Branch to create, update, and query the host system. A host system can be FLEXCUBE Universal Banking.

Log in to Oracle Banking Branch Homepage. For information on how to log in, refer to *Getting Started User Guide* in the Oracle Banking Branch Documentation Library.

To configure account services:

1. On the Homepage, click **Core Maintenance**. Under **Core Maintenance**, click **Routing Hub**, and then select **Service Consumers** or specify **Service Consumers** in the search icon bar and select the screen.

The **Service Consumers** screen is displayed.

Figure 1-22 Service Consumers - Account Services



2. Click **Import**.
The **Import Service Consumer** pop-up screen is displayed.
3. On the **Import Service Consumer** pop-up screen, click **Select** and upload the `CASA_SERVICES_Consumer.json` file provided in the release.

Note:

The folder path for the `CASA_SERVICES_Consumer.json` file is `\OBBRN_ROUTING_CONFIGURATION`.

4. Click **Extract**.

The data is extracted successfully.

Figure 1-23 Import Service Consumer - Account Services

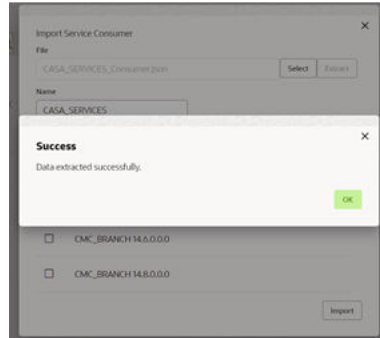

5. Select all the extracted service providers, and click **Import**.

Figure 1-24 Service Provider Selection - Account Services

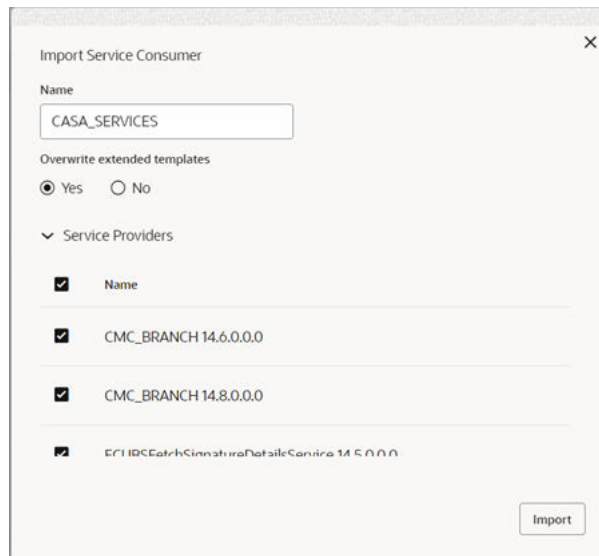

The service consumers are imported successfully. A sample screen after import operation is shown below.

Figure 1-25 Imported Service Consumers - Account Services

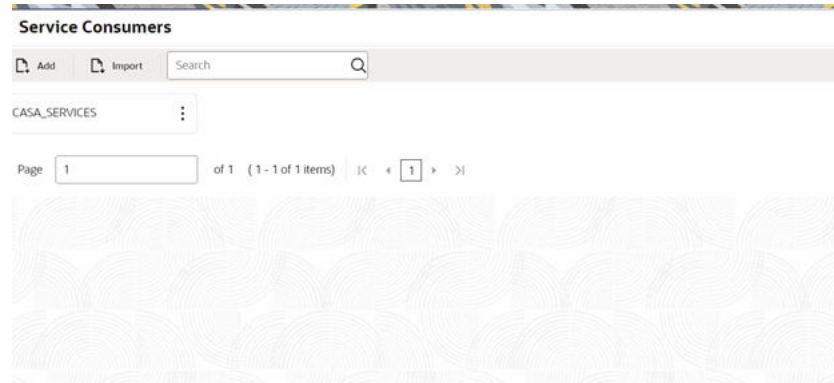

- Click **CASA_SERVICES**.
The service providers are displayed.

Figure 1-26 View Service Providers - Account Services

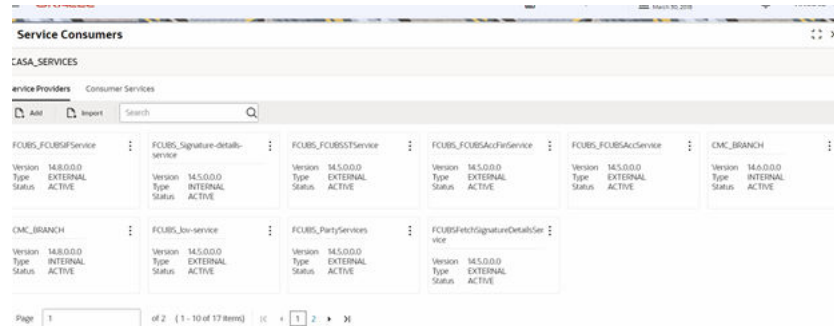

- Click **Import** to import the latest service providers.

Note:

This import will update the existing service providers and add new service providers to `casa_services`

- On the **Import Service Provider** pop-up screen, click **Select** to choose the service providers.

Note:

You can zip and import all service providers at once if more than one service providers are available to import.

- Click **Import**.
A confirmation pop-up screen displays.

Figure 1-27 Confirm Service Provider - Account Services

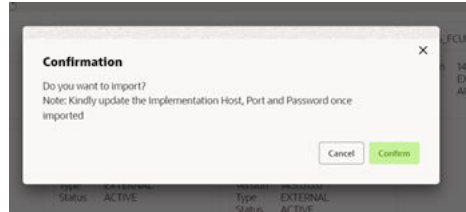

10. Click **Consumer Services** to import latest consumer service.

 **Note:**

This import will update old consumer services and add new consumer services to casa_services.

11. Click **Import**.
12. On the **Import Service** pop-up screen, select **Overwrite extended templates** as **Yes**.
13. Click **Select** to choose consumer services.
14. Click **Import**.

 **Note:**

You can zip and import all service providers at once if more than one service providers are available to import.

Figure 1-28 Import Service - Account Services

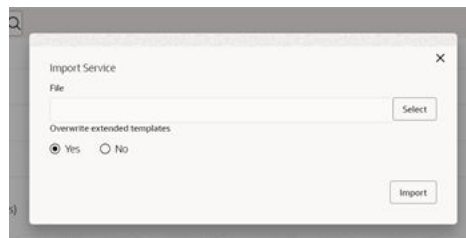

A confirmation pop-up screen displays.

Figure 1-29 Confirm Consumer Services

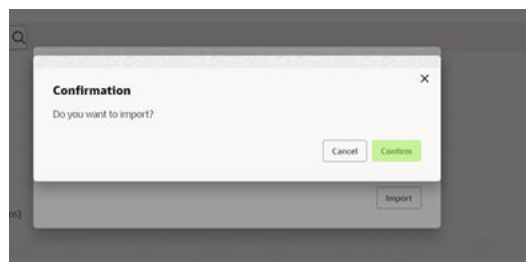

15. Click on the individual service provider, and select **Edit**.

Figure 1-30 Edit Service Provider - Account Services

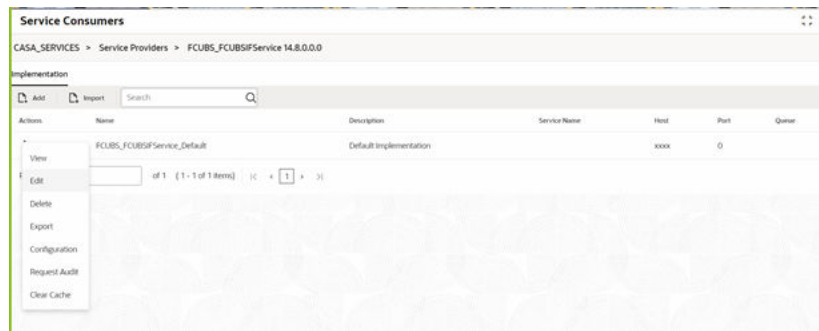

The **Edit Implementation** pop-up screen is displayed.

Figure 1-31 Edit Implementation - Account Services

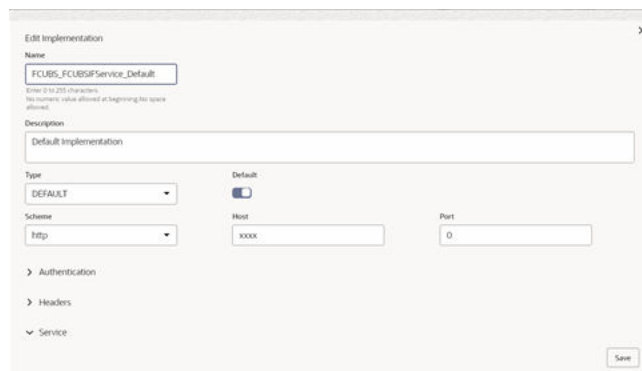

16. On the **Edit Implementation** pop-up screen, specify the **Host** and **Port** as per the host system (FLEXCUBE Universal Banking) installation, and click **Save**.

The implementation details are saved for the service provider.

17. Perform this step if multi entity is enabled.
 - a. Go to Service Consumers and select edit the consumer.

Figure 1-32 Service Consumers - Account Services

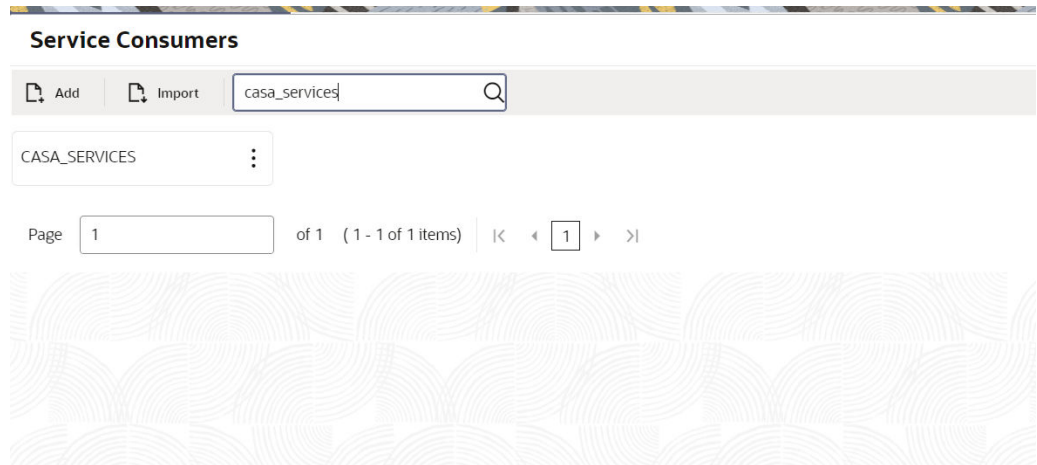

- b. Select Group ENTITY.

Figure 1-33 Service Consumer - Group Entity

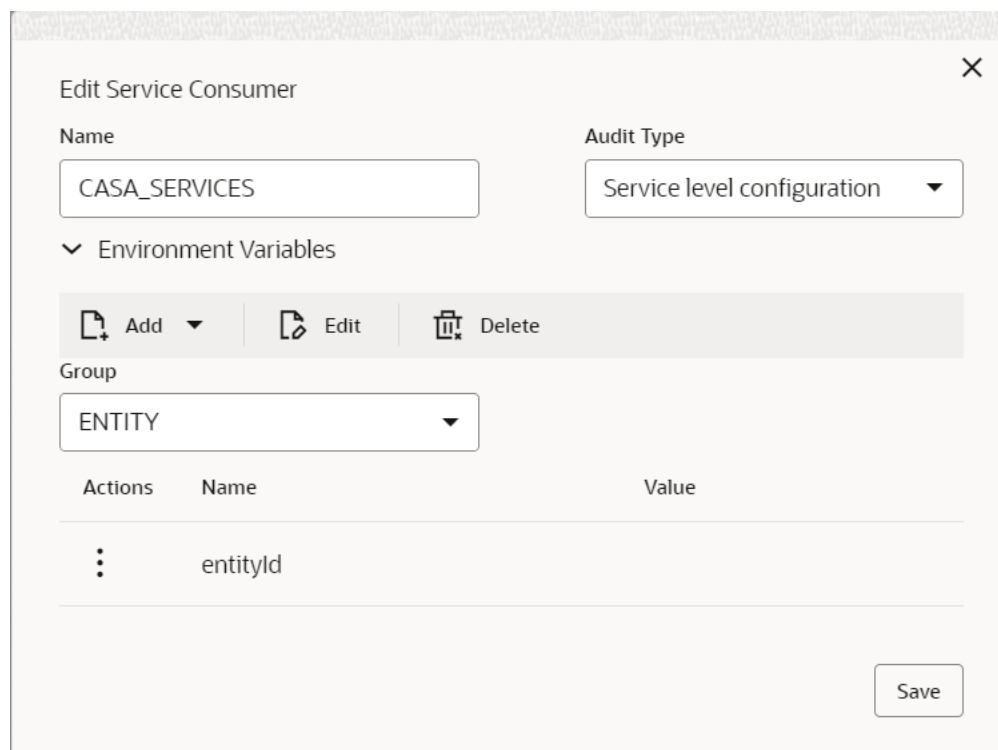

- c. Edit the environment variable and set the entityId value as per the value configured in backoffice setup.

Figure 1-34 Service Consumer - Edit Environment Variable

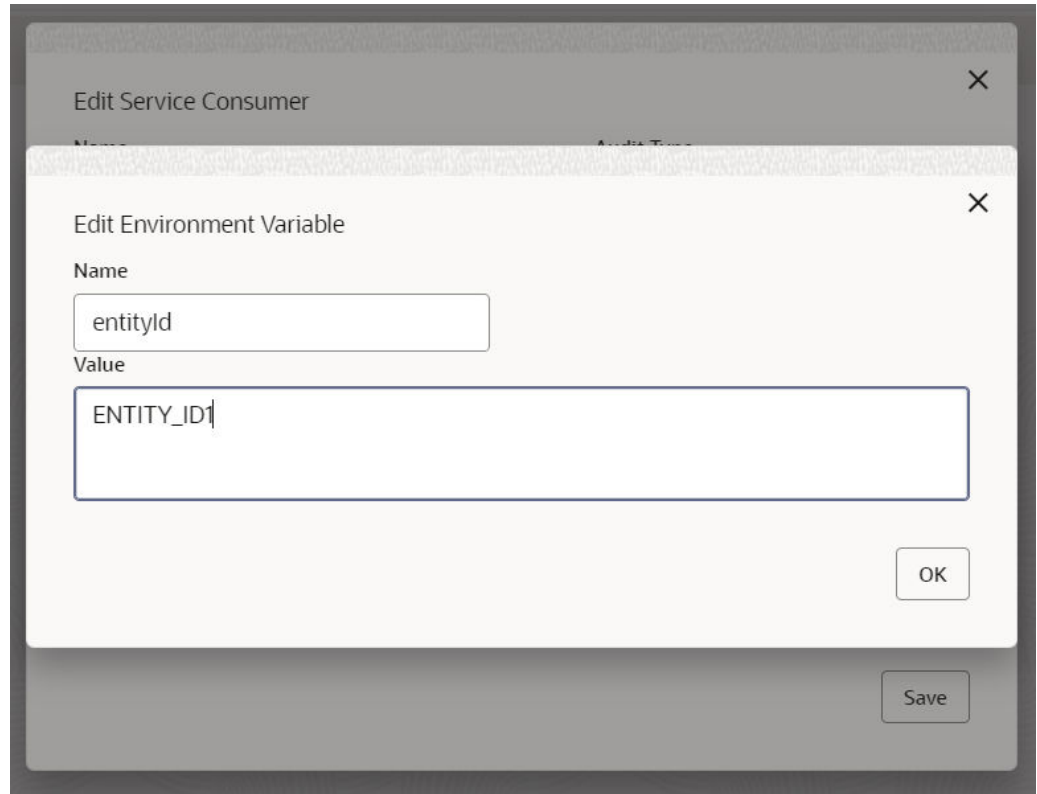

 **Note:**

In our setup it was ENTITY_ID1 for backoffice so same is shown in the screenshot.

- d. Select **Group** BANK_PARAM

Figure 1-35 Service Consumer - Group BANK_PARAM

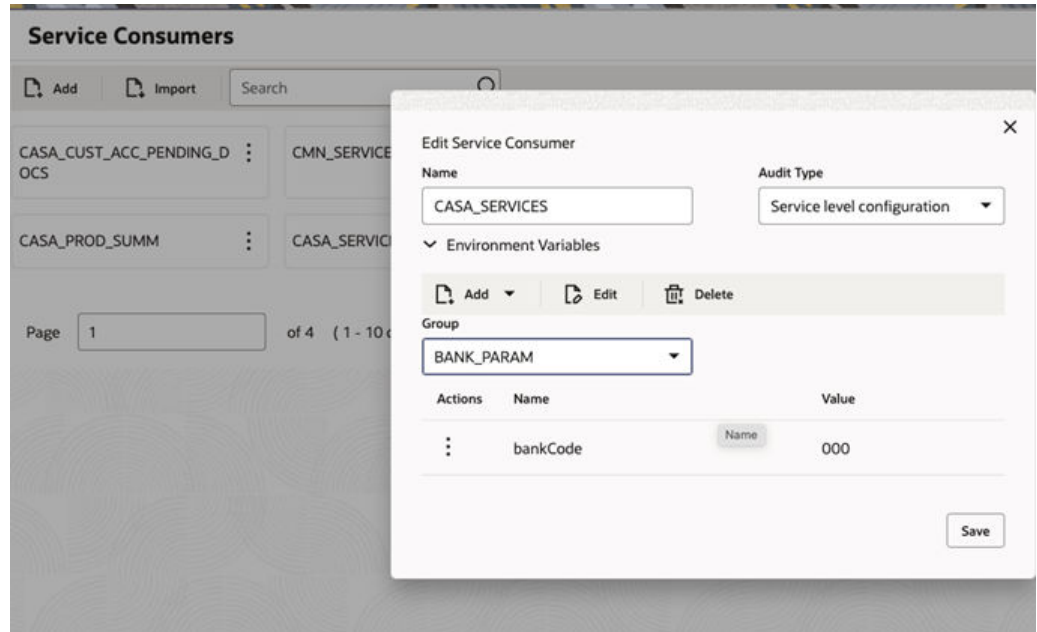

- e. Edit the environment variable and set the bank Code value as per the bank Code value configured in back office setup.

Figure 1-36 Service Consumer - Edit Environment Variable

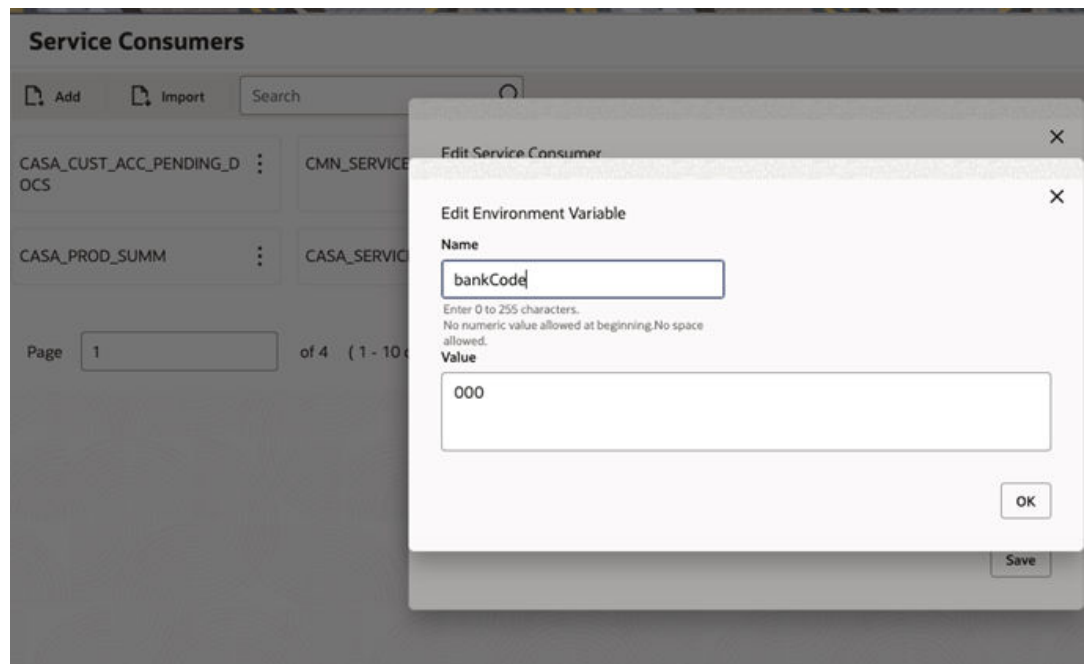

 **Note:**

In the screenshot, the back office value is displayed as 000 according to its setup.

18. Perform steps 1 thru 8 again for the following service providers.

The CASA services are as follows:

- `CASA_SERVICES_Consumer.json`

The services for the CASA dashboard widgets are as follows:

- `CASA_BULLETIN_DASHBOARD_Consumer.json`
- `CASA_CUST_ACC_PENDING_DOCS_Consumer.json`
- `CASA_GET_CUST_SERV_REQ_Consumer.json`
- `CASA_ADD_CUST_SERV_REQ_Consumer.json`

The services for the business product are as follows:

- `CASA_PROD_SUMM_Consumer.json`
- `CASA_BUS_PROD_Consumer.json`

The below list of consumers contains the host and port as per `CustomerAccountService` and `fcubs-co-mo-lov-service` deployed in host server. The same needs to be updated for the service providers `FCUBS_CustomerAccountService` and `FCUBS_lov-service`:

- `CASA_SERVICES`

1.2.1.5 Configure CASA 360

You can maintain the routing configuration of Oracle Banking Routing Hub in the common core for the CASA 360 service of the Oracle Banking Branch to create, update, and query the host system. A host system can be FLEXCUBE Universal Banking.

Log in to Oracle Banking Branch Homepage. For information on how to log in, refer to *Getting Started User Guide* in the Oracle Banking Branch Documentation Library.

To configure 360:

1. On the Homepage, click **Core Maintenance**. Under **Core Maintenance**, click **Routing Hub**, and then select **Service Consumers** or specify **Service Consumers** in the search icon bar and select the screen.

The **Service Consumers** screen is displayed.

Figure 1-37 Service Consumers - CASA 360



2. Click **Import**.

The **Import Service Consumer** pop-up screen is displayed.

3. On the **Import Service Consumer** pop-up screen, click **Select** and upload the `CASA_DETAILS_Consumer.json` file provided in the release.

 **Note:**

The folder path for the `CASA_DETAILS_Consumer.json` file is `\OBBRN_ROUTING_CONFIGURATION`.

4. Click **Extract**.
The data is extracted successfully.

Figure 1-38 Import Service Consumer - CASA 360

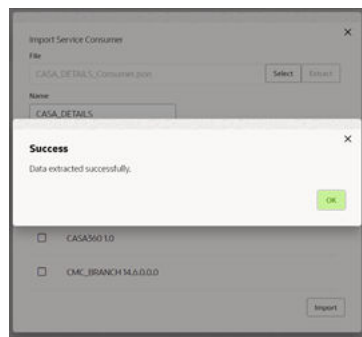

5. Select all the extracted service providers, and click **Import**.

Figure 1-39 Service Provider Selection - CASA 360



The service consumers are imported successfully. A sample screen after import operation is shown below.

Figure 1-40 Imported Service Consumers - CASA 360

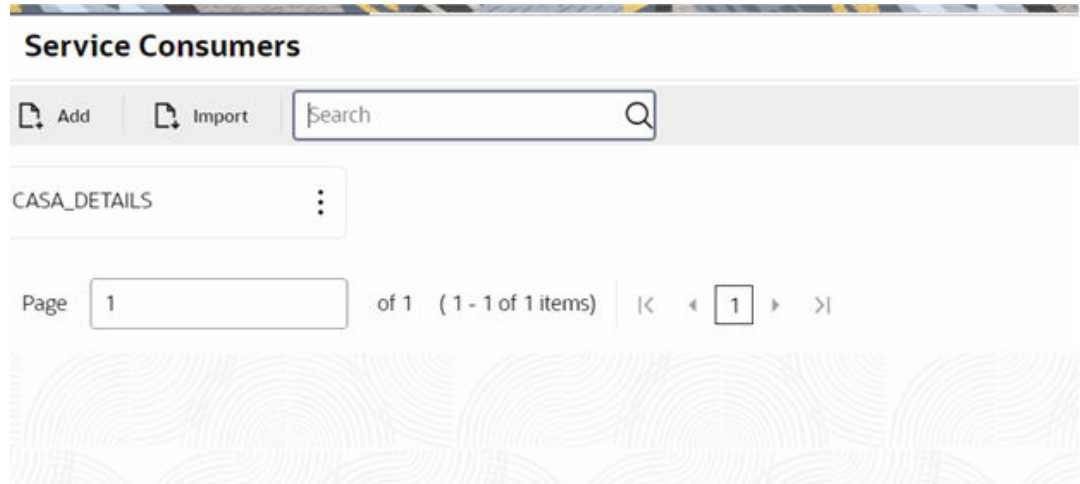

6. Click **CASA_DETAILS**.
The service providers are displayed.

Figure 1-41 View Service Providers - CASA 360

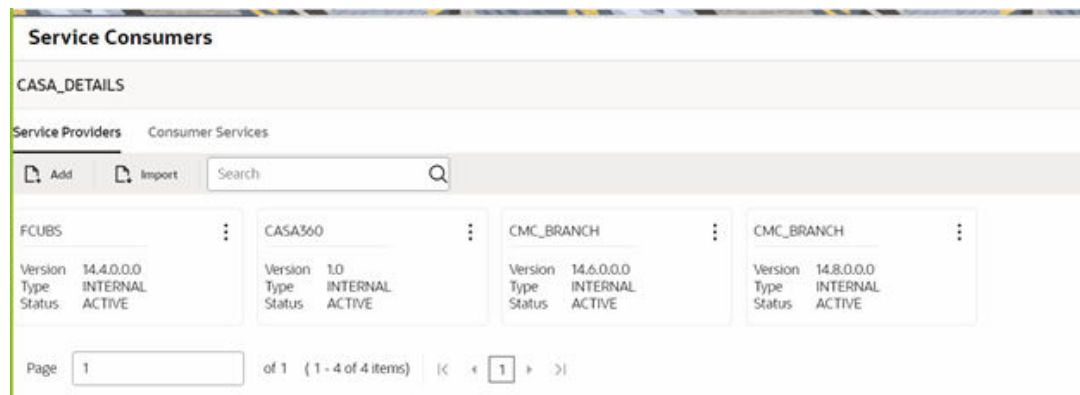

7. Click on the individual service provider, and select **Edit**.

Figure 1-42 Edit Service Provider - CASA 360

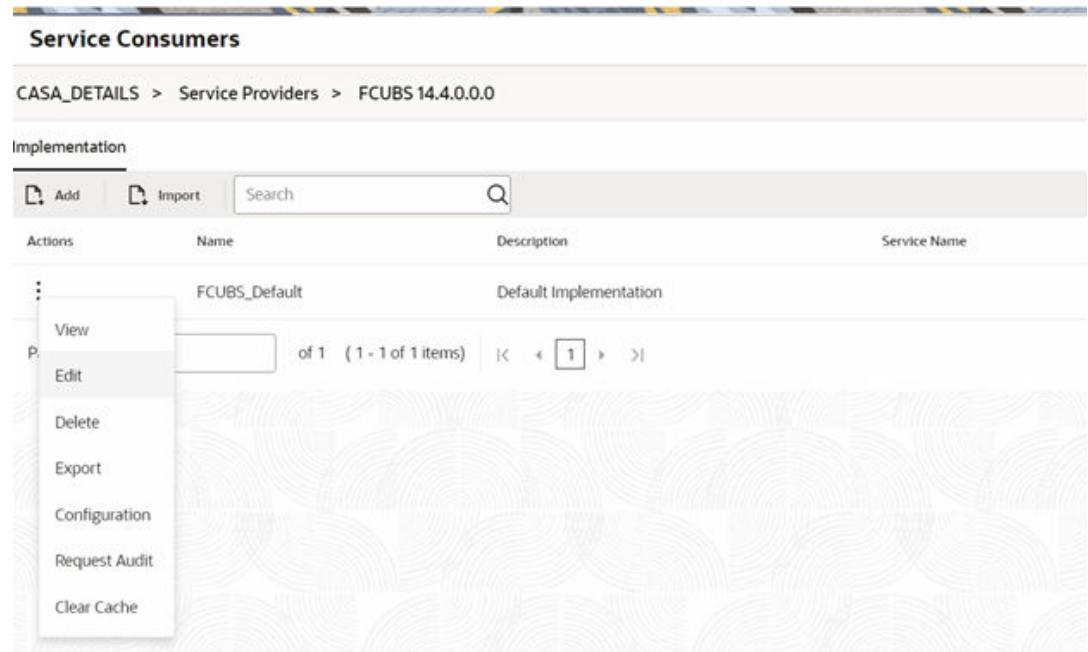

The **Edit Implementation** pop-up screen is displayed.

Figure 1-43 Edit Implementation - CASA 360

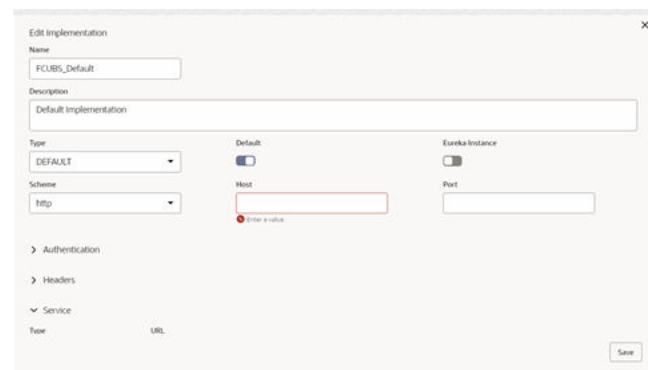

8. On the **Edit Implementation** pop-up screen, specify the **Host** and **Port** as per the host system (FLEXCUBE Universal Banking) installation, and click **Save**.

The implementation details are saved for the service provider.

9. Perform steps 7 and 8 again for the following service providers.

1.2.1.6 Configure Deposit Services

You can maintain the routing configuration of the Oracle Banking Routing Hub in the common core for Deposit Servicing transitions of the Oracle Banking Branch to create, update, and query the host system. A host system can be FLEXCUBE Universal Banking.

Log in to Oracle Banking Branch Homepage. For information on how to log in, refer to *Getting Started User Guide* in the Oracle Banking Branch Documentation Library.

To configure deposit services:

1. On the Homepage, click **Core Maintenance**. Under **Core Maintenance**, click **Routing Hub**, and then select **Service Consumers** or specify **Service Consumers** in the search icon bar and select the screen.

The **Service Consumers** screen is displayed.

Figure 1-44 Service Consumers - Deposit Services



2. Click **Import**.
The **Import Service Consumer** pop-up screen is displayed.
3. On the **Import Service Consumer** pop-up screen, click **Select** and upload the `OBREMO_DSR_Consumer.json` file provided in the release.

 **Note:**

The folder path for the `OBREMO_DSR_Consumer.json` file is `\OBBRN_ROUTING_CONFIGURATION`.

4. Click **Extract**.
The data is extracted successfully.

Figure 1-45 Import Service Consumer - Deposit Services

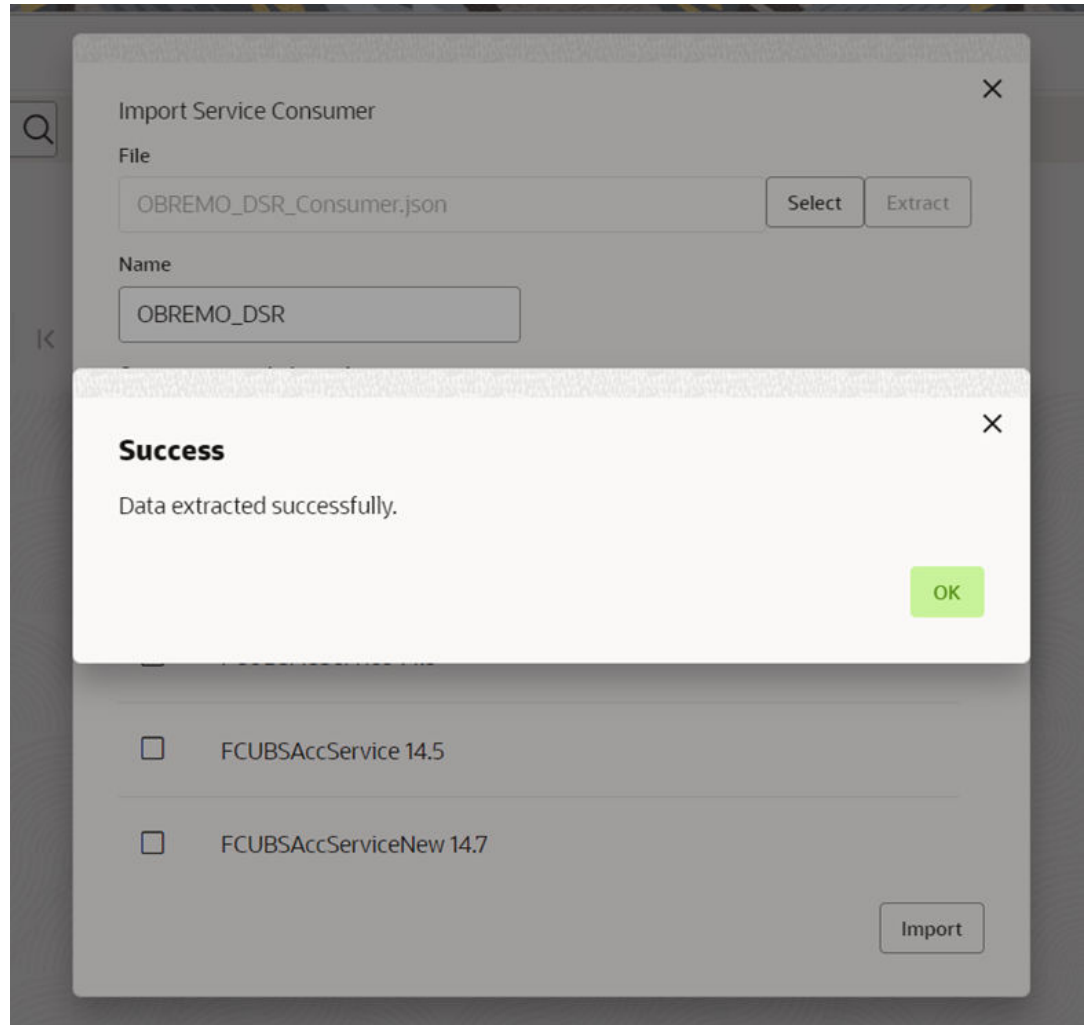

5. Select all the extracted service providers, and click **Import**.

Figure 1-46 Service Provider Selection - Deposit Services

Import Service Consumer

File
OBREMO_DSR_Consumer.json Select Extract

Name
OBREMO_DSR

Overwrite extended templates
 Yes No

Service Providers

- Name
- FCUBSACService 14.5
- FCUBSAccService 14.5
- FCUBSAccServiceNew 14.7

Import

The service consumers are imported successfully. A sample screen after import operation is shown below.

Figure 1-47 Imported Service Consumers - Deposit Services

Service Consumers

Add Import

OBREMO_DSR

Page of 1 (1 - 1 of 1 items) < >

- Click **OBREMO_DSR**.
The service providers are displayed.

Figure 1-48 View Service Providers - Deposit Services

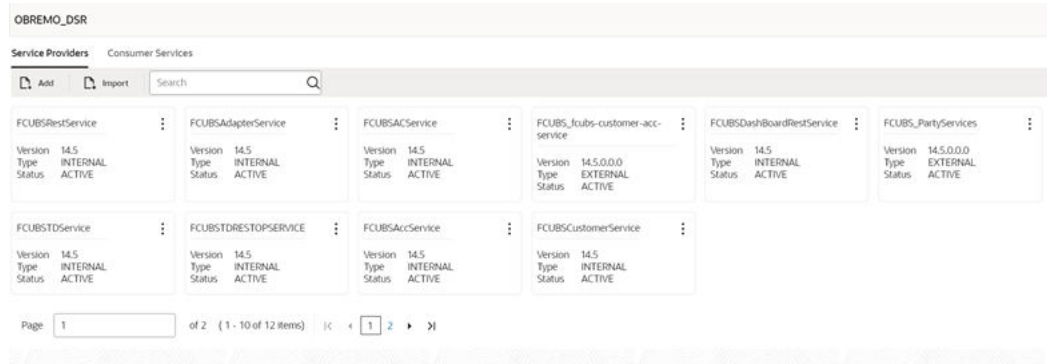

- Click on the individual service provider, and select **Edit**.

Figure 1-49 Edit Service Provider - Deposit Services

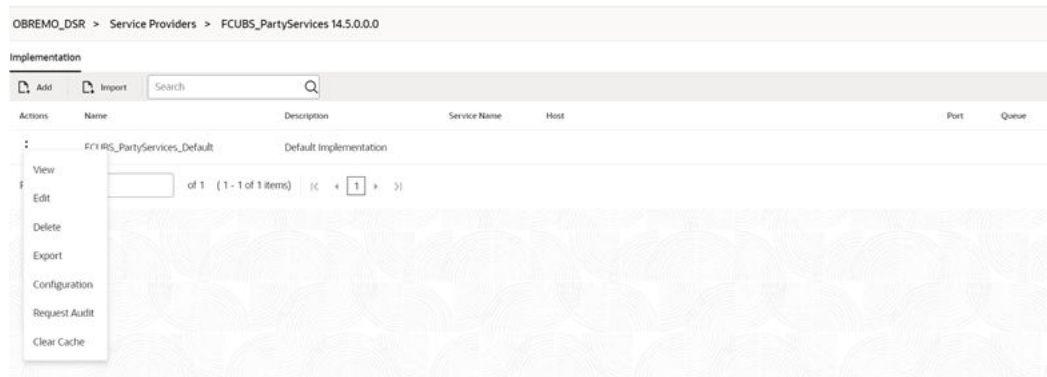

The **Edit Implementation** pop-up screen is displayed.

Figure 1-50 Edit Implementation - Deposit Services

The screenshot shows a dialog box titled "Edit Implementation" with a close button (X) in the top right corner. The form contains the following elements:

- Name:** A text input field containing "FCUBS_PartyServices_Default".
- Description:** A large text area containing "Default Implementation".
- Type:** A dropdown menu set to "DEFAULT".
- Default:** A toggle switch that is currently turned on.
- Scheme:** A dropdown menu set to "https".
- Host:** An empty text input field.
- Port:** An empty text input field.
- Authentication:** A collapsed section indicated by a right-pointing chevron (>).
- Headers:** A collapsed section indicated by a right-pointing chevron (>).
- Service:** A collapsed section indicated by a downward-pointing chevron (v).
- Service Type:** A dropdown menu set to "WSDL".
- URL:** An empty text input field with a "Required" label below it.
- Import:** A button next to the URL field.
- Save:** A button in the bottom right corner.

8. On the **Edit Implementation** pop-up screen, specify the **Host** and **Port** as per the host system (FLEXCUBE Universal Banking) installation, and click **Save**.
The implementation details are saved for the service provider.
9. Perform steps 7 and 8 again for all the service providers.

1.2.1.7 Configure Loan Services

You can maintain the routing configuration of the Oracle Banking Routing Hub in common core for Loans transitions of the Oracle Banking Branch to create, update, and query the host system. A host system can be FLEXCUBE Universal Banking.

Log in to Oracle Banking Branch Homepage. For information on how to log in, refer to *Getting Started User Guide* in the Oracle Banking Branch Documentation Library.

To configure loan services:

1. On the Homepage, click **Core Maintenance**. Under **Core Maintenance**, click **Routing Hub**, and then select **Service Consumers** or specify **Service Consumers** in the search icon bar and select the screen.

The **Service Consumers** screen is displayed.

Figure 1-51 Service Consumers - Loan Services



2. Click **Import**.

The **Import Service Consumer** pop-up screen is displayed.

3. On the **Import Service Consumer** pop-up screen, click **Select** and upload the `OBB_LOAN_Consumer_UBS.json` file provided in the release.

 **Note:**

The folder path for the `OBB_LOAN_Consumer_UBS.json` file is `\OBBRN_ROUTING_CONFIGURATION`.

4. Click **Extract**.

The data is extracted successfully.

Figure 1-52 Import Service Consumer - Loan Services

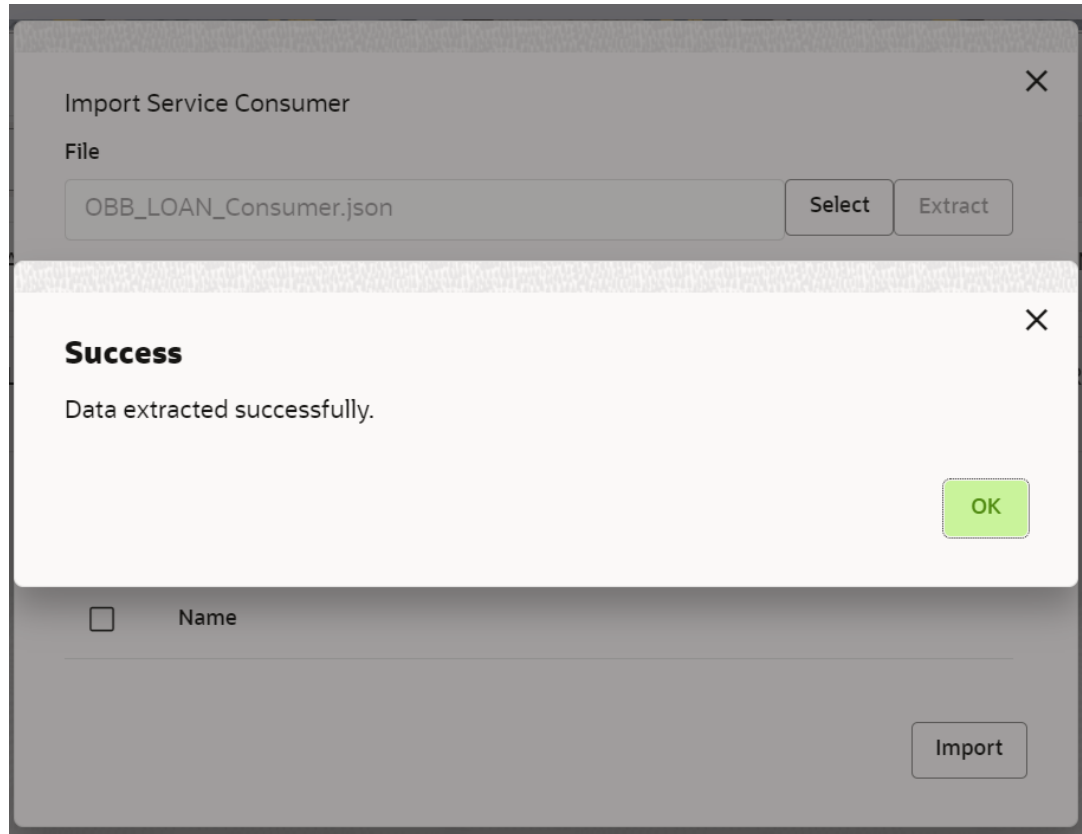

5. Select all the extracted service providers, and click **Import**.

Figure 1-53 Service Provider Selection - Loan Services

Import Service Consumer

Name

OBB_LOAN

Overwrite extended templates

Yes No

Service Providers

Name

FCUBSLoanService 14.6

Import

The service consumers are imported successfully. A sample screen after import operation is shown below.

Figure 1-54 Imported Service Consumers - Loan Services

Service Consumers

Add Import Search

OBB_LOAN

Page 1 of 1 (1 - 1 of 1 Items)

6. Click **OBB_LOAN**.

The service providers are displayed.

Figure 1-55 View Service Providers - Loan Services

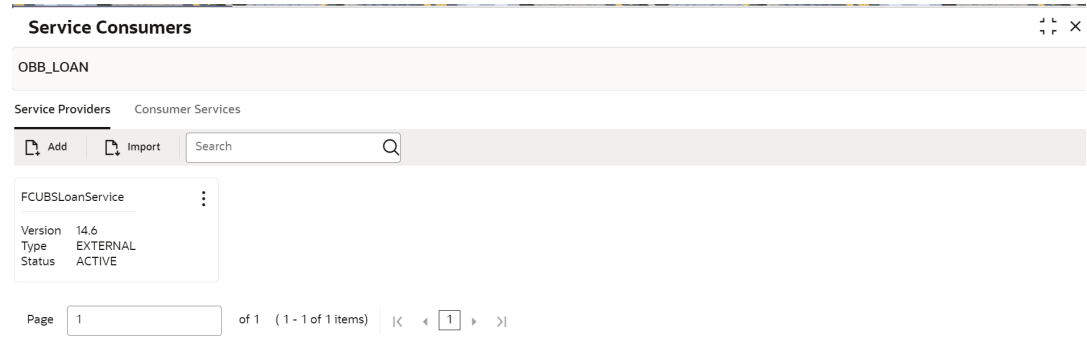

7. Click on the individual service provider, and select **Edit**.

Figure 1-56 Edit Service Provider - Loan Services

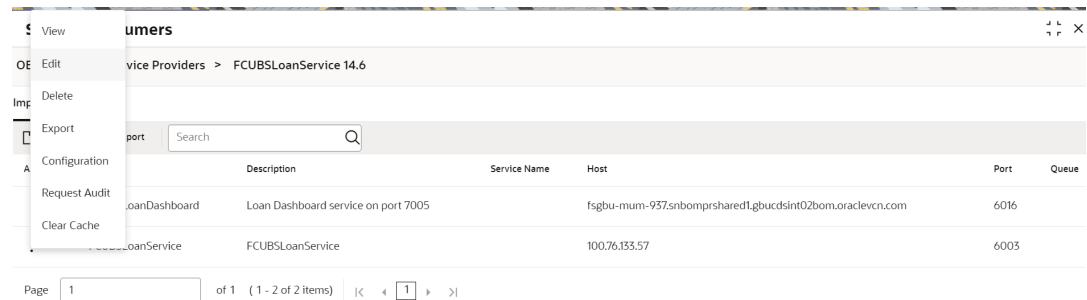

The **Edit Implementation** pop-up screen is displayed.

Figure 1-57 Edit Implementation - Loan Services

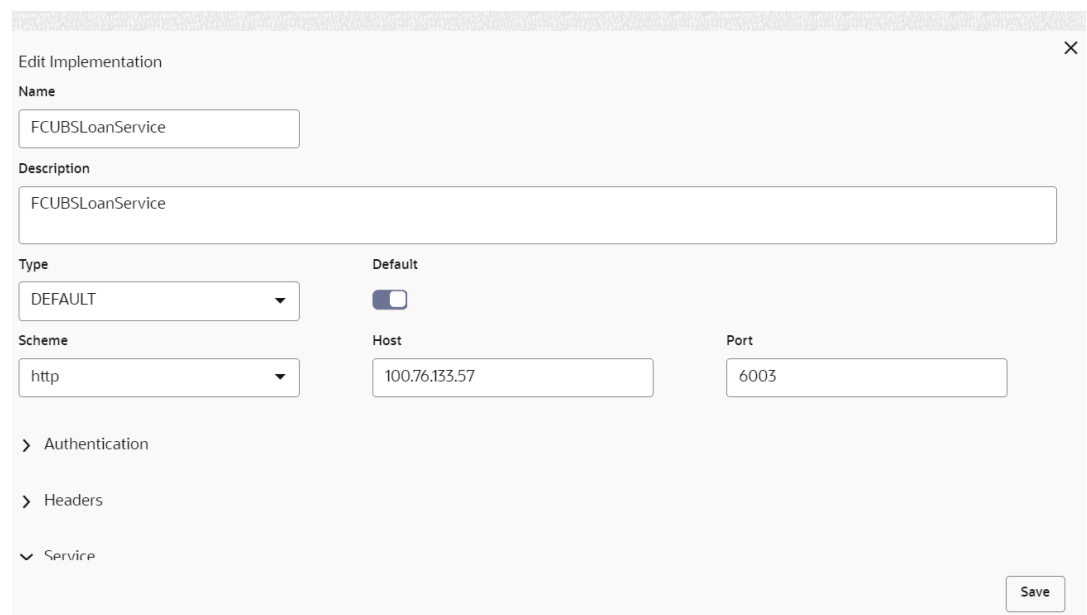

8. On the **Edit Implementation** pop-up screen, specify the **Host** and **Port** as per the host system (FLEXCUBE Universal Banking) installation, and click **Save**.

The implementation details are saved for the service provider.

9. Perform steps 6 thru 8 again for all the service providers.

The Loan Services are as follows:

- OBB_LOAN_Consumer_UBS.json

1.2.2 Direct Access

The specific configurations are needed for the Oracle Banking Branch to integrate with the FLEXCUBE Universal Banking. The direct access feature will be discontinued in the future.

In the SRV_TM_AD_EXT_SYS_DEST_DTLS table, the server IP and port need to be updated in the column HOST_SERVER for services of the FLEXCUBE Universal Banking. The following API services will be called from Oracle Banking Branch during transaction processing and hand-off to FLEXCUBE Universal Banking.

Table 1-3 FLEXCUBE Universal Banking Services

DESTINATION	URL VALUE
ACC_FINSERVICE_URL	FCUBSAccFinService/FCUBSAccFinService
CUSTOMER_SERVICE_URL	FCUBSCustomerService/FCUBSCustomerService
DDA_ACC_URL	fcubs-ext-accounting-services/service/v1/Accounting
DDA_CREDIT_CARD_GL_URL	obremo-srv-acc-credit-card-details-service/web/v1/datasegment/glAccountdetails
DDA_CREDIT_CARD_SAVE_URL	obremo-srv-acc-credit-card-details-service/web/v1/datasegment/CreditCardSave
DDA_CREDIT_CARD_URL	obremo-srv-acc-credit-card-details-service/web/v1/datasegment/creditcarddetails
DDA_CUST_SIG_URL	obremo-srv-acc-signature-details-service/web/v1/datasegment/signaturedetails
DDA_CUST_SRCH_URL	obremo-srv-customer-query-service/corecustomers/getCoreAccounts
DDA_GET_AVL_BAL_URL	fcubs-ext-accounting-services/service/v1/getAvailableBalance
DDA_SAFE_BANKING_URL	obremo-srv-acc-safe-Banking-details-service/web/v1/datasegment/getSafeBankingdetails
ECA_ACTION_URL	fcubs-eca-services/web/v1/EcaWeb/
ECA_URL	obac-srv-dda-eca-services/web/v1/EcaWeb
ExtPriceComponents	ExtPriceComponentsService/ExtPriceComponents/CreateExtPriceComp
FCUBSAccService_URL	FCUBSAccService/FCUBSAccService
FCUBSCIService_URL	FCUBSCIService/FCUBSCIService
FCUBSCLService_URL	FCUBSCLService/FCUBSCLService

Table 1-3 (Cont.) FLEXCUBE Universal Banking Services

DESTINATION	URL VALUE
FCUBSDLService_URL	FCUBSDLService/FCUBSDLService
FCUBSFinService_URL	FCUBSAccFinService/FCUBSAccFinService
FCUBSRTService_URL	FCUBSRTService/FCUBSRTService
GATEWAY_URL	none
MODIFY_CARD_MASTER_URL	FCUBSSTService/FCUBSSTService
SIGN_URL	GWHTTP/GWHttpServlet
SUMMARY_CARD_MASTER_URL	FCUBSSTService/FCUBSSTService
TERMDEPOSIT_URL	GWHTTP/GWHttpServlet

1.2.3 Relationship Pricing Integration

This topic contains the following subtopics:

- [Maintain External Price Components of Relationship Pricing](#)
You need to maintain the external price components of the relationship pricing in the FLEXCUBE Universal Banking.
- [Maintain External Data Elements of Relationship Pricing](#)
You need to maintain the external data elements of the Oracle Banking Branch in the FLEXCUBE Universal Banking.
- [Maintain Pricing Source System](#)
You need to maintain the pricing source system (UBS-RP) to integrate the relationship pricing with the Oracle Banking Branch.
- [Maintain Charge Definition](#)
You need to maintain the charge codes in the **Charge Definition Maintenance** screen and link them to the pricing source system. In addition, you need to link the corresponding External System Elements (EDE) applicable for the charge code.
- [Charge Decision Maintenance](#)
The charge decision maintenance enables the integration of the relationship pricing with the Oracle Banking Branch.
- [Transaction Charge Computation](#)
The transaction charge computation happens through a charge service call from the **Charge Decision Maintenance** screen to the common core.

1.2.3.1 Maintain Pricing Source System

You need to maintain the pricing source system (UBS-RP) to integrate the relationship pricing with the Oracle Banking Branch.

Log in to Oracle Banking Branch Homepage. For information on how to log in, refer to *Getting Started User Guide* in the Oracle Banking Branch Documentation Library.

To maintain the pricing source system:

1. On the Homepage, click **Core Maintenance**. Under **Core Maintenance**, click **Pricing Source System**, and then select **Create Pricing Source System** or specify **Create Pricing Source System** in the search icon bar and select the screen.

The **Create Pricing Source System** screen is displayed.

2. On the **Create Pricing Source System** screen, specify the details in the fields as shown in the figure. For information on the fields, refer to the *Oracle Banking Common Core User Guide* in the Oracle Banking Branch Documentation Library.

Figure 1-58 Pricing Source System

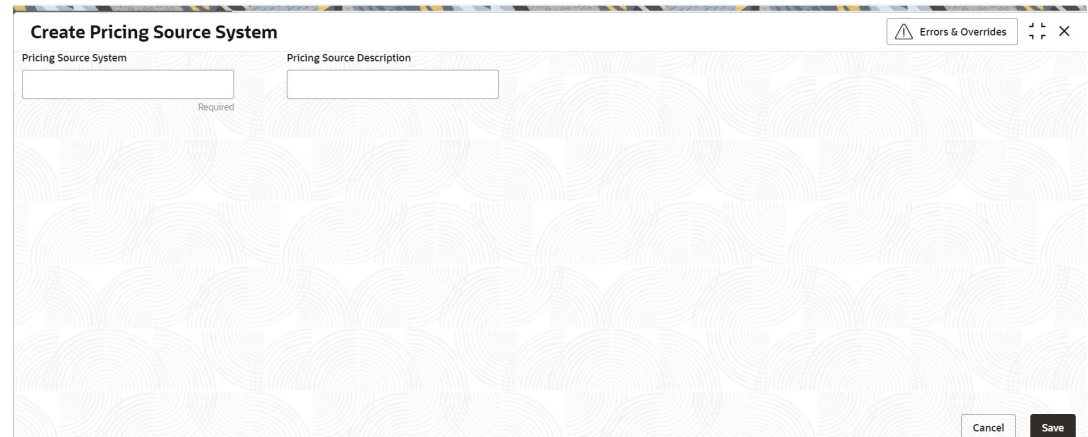

1.2.3.2 Maintain Charge Definition

You need to maintain the charge codes in the **Charge Definition Maintenance** screen and link them to the pricing source system. In addition, you need to link the corresponding External System Elements (EDE) applicable for the charge code.

Log in to Oracle Banking Branch Homepage. For information on how to log in, refer to *Getting Started User Guide* in the Oracle Banking Branch Documentation Library.

The static set of EDEs will be fetched from the list of values as provided by the pricing source system.

To maintain charge definition:

1. On the Homepage, click **Teller**. On Teller Mega Menu, under **Branch Maintenance**, click **Charge Definition Maintenance** or specify **Charge Definition Maintenance** in the search icon bar and select the screen.

The **Charge Definition Maintenance** screen is displayed.

Figure 1-59 Charge Definition Maintenance

The screenshot shows the 'Charge Definition Maintenance' interface. It features several required input fields: 'Charge Code', 'Charge Description', 'Charge Credit Account', 'Charge Debit Account', 'Debit Transaction Code', 'Pricing Source System', and 'Credit Transaction Code'. The 'Charge Category' is a dropdown menu currently set to 'Standard'. Below the input fields is a table for 'EDE Code' with columns for 'EDE Code', 'EDE Description', and 'Action'. The table contains one row with a pencil icon in the 'Action' column. At the bottom right of the screen are 'Cancel' and 'Save' buttons.

2. On the **Charge Definition Maintenance** screen, specify the details in the fields as shown in the figure. For information on the fields, refer to the **Teller User Guide** in the Oracle Banking Branch Documentation Library.

1.2.3.3 Charge Decision Maintenance

The charge decision maintenance enables the integration of the relationship pricing with the Oracle Banking Branch.

The charge codes maintained in the **Charge Definition Maintenance** screen will be linked in the **Charge Decision Maintenance** screen with the pricing rule ID directly or with the charge condition grouping. Oracle Banking Branch uses charge codes to apply Relationship Pricing by invoking the FLEXCUBE Universal Banking pricing engine.

1.2.3.4 Transaction Charge Computation

The transaction charge computation happens through a charge service call from the **Charge Decision Maintenance** screen to the common core.

Figure 1-60 Relationship Pricing Transactional Flow

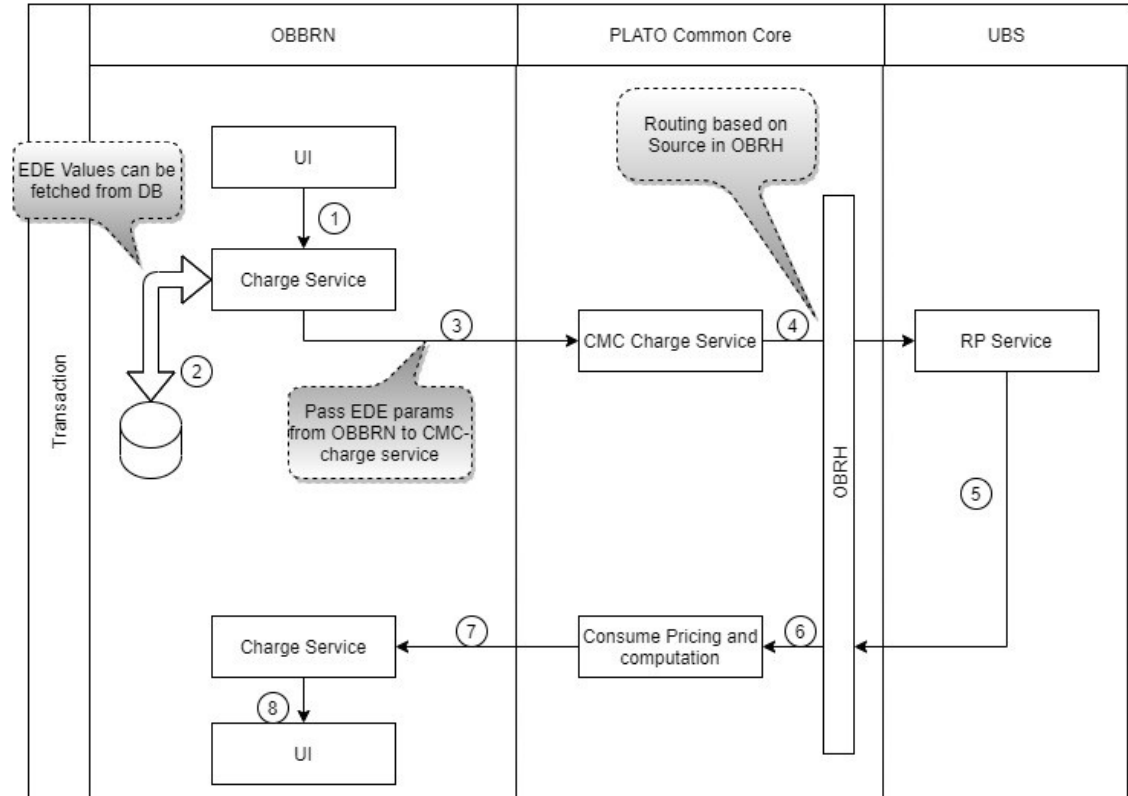

The charge pickup or the charge computation happens on the tab out of the **Amount** field in transaction screens. During charge computation in Oracle Banking Branch, the **Charge Decision Maintenance** screen will identify the list of charge codes for a transaction, and make a charge service call to the common core for charge computation.

CMC-Charge-Service will compute regular charge as per definition, and then make a call to the pricing engine (if the pricing source system is maintained) along with EDE fields and values maintained in the **Charge Definition Maintenance** screen.

The Oracle Banking Branch consumes the response from the pricing engine (FLEXCUBE Universal Banking) and computes the charges accordingly. The below figure represents the transactional flow of the relationship pricing for the integration of Oracle Banking Branch and FLEXCUBE Universal Banking.

1.3 Maintenance for Core Replication

The FLEXCUBE Universal Banking is the host system that replicates the data to Oracle Banking Microservices Architecture core.

Core entities such as customer and account information will be replicated for mid-office products to work with. Replication is supported for the following entities:

- Customer
- Account
- External Chart of Accounts
- Transaction Code

- Exchange Rates
- Currency Holiday Maintenance
- Local Holidays
- Currency Pair
- Currency Rate Type
- Currency Definition

The following operations are provided as a part of replication:

- Create
- Modify
- Reopen
- Close

This topic contains the following subtopics:

- [Add Service Consumers](#)
You can add service producers and consumers for Customers and Account.
- [Maintain External Services](#)
You need to maintain the external services in FLEXCUBE Universal Banking for the external system (PLATOCORE, OBSRV).
- [Maintain Upload Source Code](#)
You need to maintain the upload source code in the Oracle Banking Branch for the source system (*FLEXCUBE*).

1.3.1 Add Service Consumers

You can add service producers and consumers for Customers and Account.

Log in to Oracle Banking Branch Homepage. For information on how to log in, refer to *Getting Started User Guide* in the Oracle Banking Branch Documentation Library.

Service Consumer is an Oracle product, which will invoke the API of the Oracle Banking Routing Hub. Oracle Banking Routing Hub will analyze, evaluate destination product processors, and transform data into a format of the same. It comprises the source and destination integration details.

To add service consumers:

1. On the Homepage, click **Core Maintenance**. Under **Core Maintenance**, click **Routing Hub**, and then select **Service Consumers** or specify **Service Consumers** in the search icon bar and select the screen.

The **Service Consumers** screen is displayed.

Figure 1-61 Service Consumers - Customer and Account

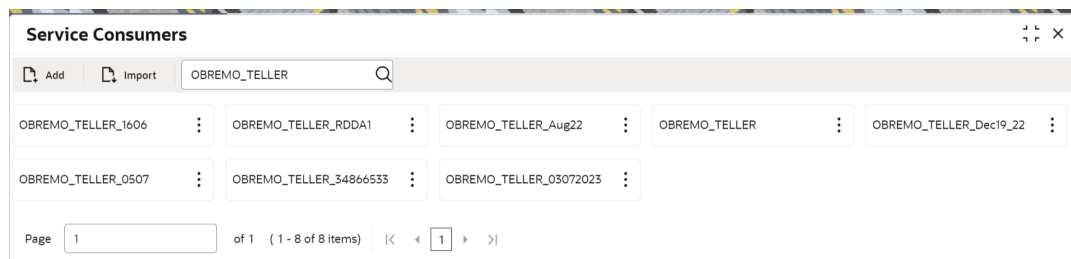

2. On the **Service Consumers** screen, click **Add** to create a new Oracle Banking Routing Hub template.

The **Add Service Consumer** pop-up screen is displayed.

Figure 1-62 Add Service Consumer

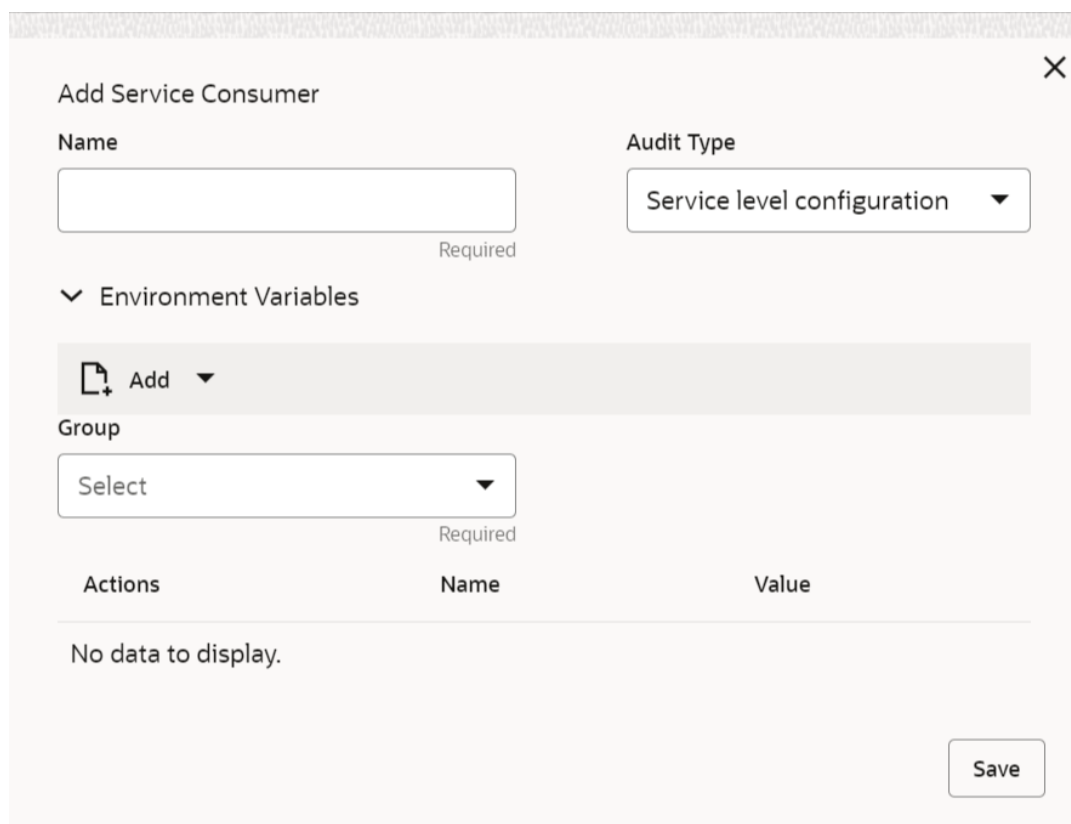

3. On the **Add Service Consumer** pop-up screen, specify the details, and click **Save**.

The confirmation dialog box is displayed with **Confirm** and **Cancel** options.

Figure 1-63 Add Service Consumer – Confirmation

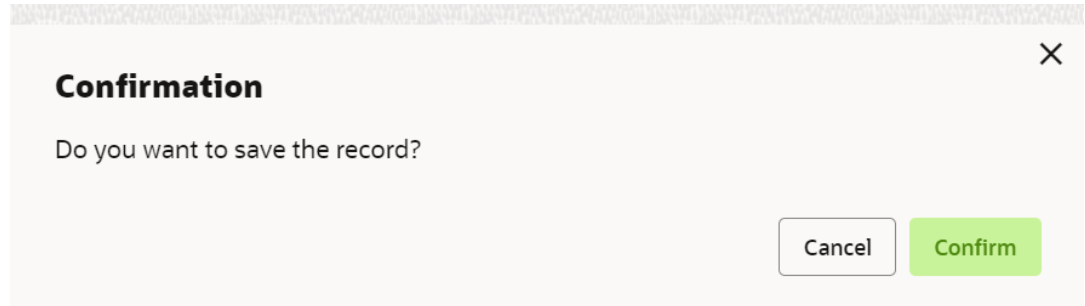

4. Click **Confirm**.
The template is created.

Figure 1-64 Add Service Providers

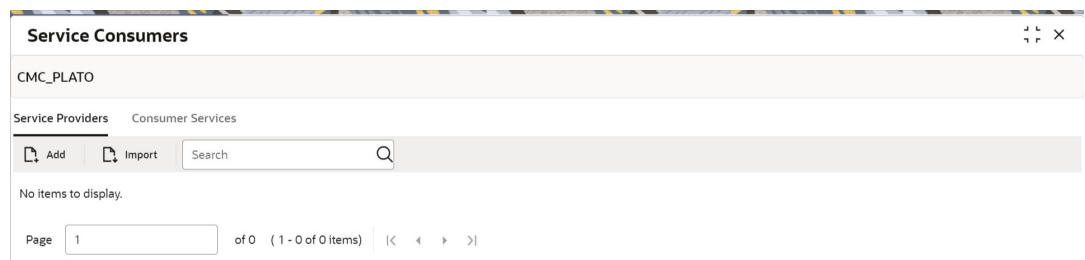

5. On the **Service Consumers** screen, click **CMC_PLATO** and select **Import** to import the necessary file.
The **Import Service Provider** pop-up screen is displayed.

Figure 1-65 Import Service Provider

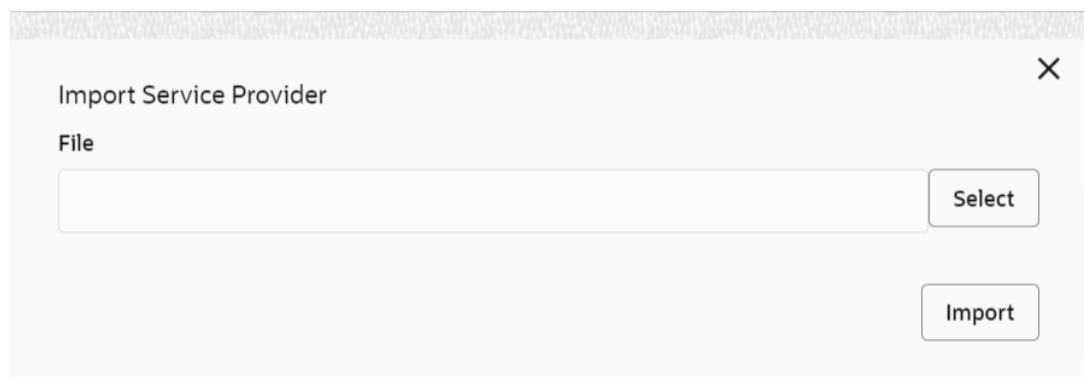

6. On the **Import Service Provider** pop-up screen, click **Select** and select the JSON file.
7. Click **Import**.
The JSON file is imported as the service provider.

1.3.2 Maintain External Services

You need to maintain the external services in FLEXCUBE Universal Banking for the external system (PLATOCORE, OBSRV).

Log in to FLEXCUBE Universal Banking Homepage. For information on how to log in, refer to the *Procedures User Guide* in the FLEXCUBE Universal Banking Documentation Library.

Based on the data created in FLEXCUBE Universal Banking, the quartz scheduler will invoke the Oracle Banking Routing Hub service by using the maintained details.

To maintain the external services:

1. On the Homepage, specify **IFDEXSER** in the text box, and click the next arrow.
The **External Service Maintenance** screen is displayed.
2. On the **External Service Maintenance** screen, specify the details in the fields as shown in the figure. For information on the fields, refer to the *FLEXCUBE UBS - ELCM Integration Guide* in the FLEXCUBE Universal Banking Documentation Library.

Figure 1-66 External Service Maintenance - PLATOCORE

External Service Maintenance

New Unlock Enter Query

External System * PLATOCORE External System AppID CMNCORE

External System Type OBRH Read Time Out (In Seconds)

External User * HARISH Connection Time Out (In Seconds)

Retry Count 0

Archival Days

Rest Service Secured

Type	Service Name	WS Endpoint URL	Rest Service Context	Rest Service IP	Rest Service Port	Rest Service Pattern
<input checked="" type="checkbox"/> REST request	FCUBSCoreentitiesService		cmc-obrh-services	10.40.162.89	7022	route/dispatch

Page 1 of 1 (1 of 1 items) |< < 1 > >|

Audit Exit Save

Figure 1-67 External Service Maintenance - OBSRV

1.3.3 Maintain Upload Source Code

You need to maintain the upload source code in the Oracle Banking Branch for the source system (*FLEXCUBE*).

Log in to Oracle Banking Branch Homepage. For information on how to log in, refer to *Getting Started User Guide* in the Oracle Banking Branch Documentation Library.

To maintain the upload source code:

1. On the Homepage, click **Core Maintenance**. Under **Core Maintenance**, click **Upload Source**, and then select **Create Upload Source**.

The **Create Upload Source** screen is displayed.

2. On the **Create Upload Source** screen, specify the details in the fields as shown in the figure. For information on the fields, refer to the *Oracle Banking Common Core User Guide* in the Oracle Banking Branch Documentation Library.

Figure 1-68 Upload Source Code Maintenance

2

Integration of Oracle Banking Payments

The Oracle Banking Payments can be integrated with the Oracle Banking Branch through specific maintenances.

The following maintenance procedures need to be performed to integrate Oracle Banking Branch with the Oracle Banking Payments:

- [Maintenance for Oracle Banking Branch](#)
You can use the Oracle Banking Routing Hub or direct access method to perform the maintenance for the Oracle Banking Branch.
- [Maintenance for Oracle Banking Payments](#)
The following maintenances are needed to integrate Oracle Banking Branch with Oracle Banking Payments.

2.1 Maintenance for Oracle Banking Branch

You can use the Oracle Banking Routing Hub or direct access method to perform the maintenance for the Oracle Banking Branch.

Using Oracle Banking Routing Hub

For information on maintenances using Oracle Banking Routing Hub, refer to [Maintenance Using Oracle Banking Routing Hub](#).

Direct Access

In the direct access method, specific configurations are needed to integrate the Oracle Banking Branch with the Oracle Banking Payments. In the `SRV_TM_AD_EXT_SYS_DEST_DTLS` table, you need to update the server IP and port in column `HOST_SERVER` and `GL` in column `BRIDGE_GL` for Oracle Banking Payments services.

The API service will be called from Oracle Banking Branch during transaction processing and handoff to Oracle Banking Payments. For information on the API services, refer to the table below.

Table 2-1 API Services

Service	Description
Clearing Network	<p>This service is used to fetch clearing network code from Oracle Banking Payments for outward clearing transactions. The URL is <code>OBPAY_CLG_NETWORK_URL [PmREST/obpmrest/payments/ClearingNetworkQuery]</code>.</p> <div style="border-left: 2px solid #0070C0; padding-left: 10px; margin-top: 10px;"><p> Note: The bridge GL is not applicable.</p></div>

Table 2-1 (Cont.) API Services

Service	Description
Clearing Routing Number	<p>This service is used to fetch the routing number from Oracle Banking Payments for outward clearing transactions. The URL is <code>OBPAY_CLG_ROUTINGNUM_URL [PMReST/obpmrest/payments/ClearingRoutingNoQuery]</code>.</p> <div style="border-left: 2px solid #0070C0; padding-left: 10px; margin-top: 10px;"> <p> Note: The bridge GL is not applicable.</p> </div>
Inward Clearing	This service is used to hand off inward clearing transaction requests to Oracle Banking Payments. The URL is <code>OBPAY_INWRDCLG_URL [PMReST/obpmrest/payments/inclg]</code> .
Inward Clearing Return	This service is used to hand off the return of inward clearing transaction requests to Oracle Banking Payments. The URL is <code>OBPAY_INWRDCLG_RETURN_URL [PMReST/obpmrest/payments/inclgreturn]</code> .
Duplication	This service is used to issue duplicate instruments from Oracle Banking Payments. The URL is <code>OBPAY_DUPLICATION_URL [PMReST/obpmrest/payments/instrumentduplicate]</code> .
Instrument Enquiry	This service is used to enquire the instrument transactions from Oracle Banking Payments. The URL is <code>OBPAY_INSTENQUIRY_URL [PMReST/obpmrest/payments/instrumentinquiry]</code> .
Instrument Issue	This service is used to hand off instrument issue requests to Oracle Banking Payments. The URL is <code>OBPAY_INSTISSUE_URL [PMReST/obpmrest/payments/instrumentissue]</code> .
Instrument Pay	This service is used to hand off instrument payment requests to Oracle Banking Payments. The URL is <code>OBPAY_INSTPAY_URL [PMReST/obpmrest/payments/instrumentpay]</code> .
Revalidation	This service is used to hand off instrument revalidate requests to Oracle Banking Payments. The URL is <code>OBPAY_REVALIDATION_URL [PMReST/obpmrest/payments/instrumentrevalidation]</code> .
Outward Clearing	This service is used to hand off outward clearing transaction request to Oracle Banking Payments. The URL is <code>OBPAY_OUTCLG_URL [PMReST/obpmrest/payments/outclg]</code> .
Outward Clearing Return	This service is used to hand off the return of the outward clearing transaction request to Oracle Banking Payments. The URL is <code>OBPAY_OUTCLG_RETURN_URL [PMReST/obpmrest/payments/outclgreturn]</code> .

Table 2-1 (Cont.) API Services

Service	Description
Single Payout	<p>This service is used to hand off payment transaction request to Oracle Banking Payments. This single service will be used for the following transactions:</p> <ul style="list-style-type: none"> • Book Transfers • In-House Cheque Deposit • Domestic Transfers • International Transfers <p>The URL is <code>OBPAY_SINGLE_PAYOUT_URL [PmREST/obpmrest/payments/singlepayout]</code>.</p>

For information on the additional details, refer to the table below.

Table 2-2 Additional Details

Tag/Service	Description
Host Code	This tag is optional and will be sent as Null from the Oracle Banking Branch for all services.
Source Code	This tag will be populated as <code>OBTLR</code> from the Oracle Banking Branch for all services.
Network Code	<p>This tag needs to be populated for single payout service as below:</p> <ul style="list-style-type: none"> • <code>BOOK</code> for Account Transfer • <code>BOOK</code> for In-House Cheque Deposit • <code>SWIFT</code> for International Transfers
Instrument Issue	<p>The details of the instrument issue service are as follows:</p> <ul style="list-style-type: none"> • For <code>DD</code>, the <code>instrumentCode</code> tag is passed as <code>DEMANDFT</code> and the <code>instrumentType</code> tag is passed as <code>DD</code>. • For <code>BC</code>, the <code>instrumentCode</code> tag is passed as <code>MNGRCHK</code> and the <code>instrumentType</code> tag is passed as <code>MC</code>. • For Remittance Issue, maintain <code>"TELTRF"</code> as instrument code and <code>"RO"</code> as instrument type in <code>OBPM</code>. • For Inward remittance issue, maintain <code>"TLTRFIN"</code> as instrument code and <code>"RI"</code> as instrument type in <code>OBPM</code>.
Instrument Pay	<p>The details of instrument pay service are as follows:</p> <ul style="list-style-type: none"> • For <code>DD</code>, the <code>instrumentCode</code> tag is passed as <code>DEMANDFT</code>. • For <code>BC</code>, the <code>instrumentCode</code> tag is passed as <code>MNGRCHK</code>.

- [Create Entity](#)
You need to create the entity in Oracle Banking Branch to configure the notifications for Oracle Banking Payments.

2.1.1 Create Entity

You need to create the entity in Oracle Banking Branch to configure the notifications for Oracle Banking Payments.

Log in to Oracle Banking Branch Homepage. For information on how to log in, refer to *Getting Started User Guide* in the Oracle Banking Branch Documentation Library.

To create the entity:

1. On the Homepage, click **Entities**. Under **Entities**, click **Create Entity** or specify **Create Entity** in the search icon bar and select the screen.

The **Create Entity** screen is displayed.

2. On the **Create Entity** screen, create an entity with `ENTITY_ID1` as the name. For information on the screen and fields, refer to the *Oracle Banking Common Core User Guide*. A sample is shown in the below figure.

Figure 2-1 Create Entity

2.2 Maintenance for Oracle Banking Payments

The following maintenances are needed to integrate Oracle Banking Branch with Oracle Banking Payments.

This topic contains the following subtopics:

- [Maintain Source Details and Source Network Preferences](#)
You need to maintain the source details and source network preferences to integrate Oracle Banking Branch with Oracle Banking Payments.
- [Maintain External Notification and Queue Connection Profile](#)
You need to maintain the details of the external notification queue and queue connection profile for call-back configuration in the Oracle Banking Payments.

2.2.1 Maintain Source Details and Source Network Preferences

You need to maintain the source details and source network preferences to integrate Oracle Banking Branch with Oracle Banking Payments.

The prerequisites are as follows:

1. Open the login page of Oracle Banking Payments.
2. Specify **Username** and **Password**, and log in to Oracle Banking Payments Homepage.

Maintain source details and source network preferences as follows:

1. On the Homepage, specify **PMDSORCE** in the text box, and click the next arrow.

The **Source Maintenance Detailed** screen is displayed.

2. On the **Source Maintenance Detailed** screen, specify the details as shown in the figure. For information on the fields, refer to the *Payments Core User Guide* in the Oracle Banking Payments Documentation Library.

Figure 2-2 Source Maintenance Detailed

3. On the Homepage, specify **PMDSORNW** in the text box, and click the next arrow. The **Source Network Preferences Detailed** screen is displayed.
4. On the **Source Network Preferences Detailed** screen, specify the details as shown in the figure. For information on the fields, refer to the *Payments Core User Guide* in the Oracle Banking Payments Documentation Library.

Figure 2-3 Source Network Preferences Detailed

2.2.2 Maintain External Notification and Queue Connection Profile

You need to maintain the details of the external notification queue and queue connection profile for call-back configuration in the Oracle Banking Payments.

The prerequisites are as follows:

1. Open the login page of Oracle Banking Payments.
2. Specify **Username** and **Password**, and log in to Oracle Banking Payments Homepage.

After the Oracle Banking Branch hand off the transactions to Oracle Banking Payments and process the transactions, the Oracle Banking Payments will push back the notification to Oracle Banking Branch based on the below configurations.

To maintain external notification and queue connection profile:

1. On the Homepage, specify **PMDEXTNT** in the text box, and click the next arrow.
The **External Notification Queue Detailed** screen is displayed.
2. On the **External Notification Queue Detailed** screen, specify the details as shown in the figure. For information on the fields, refer to the *Payments Core User Guide* in the Oracle Banking Payments Documentation Library.

Figure 2-4 External Notification Queue Detailed

3. On the Homepage, specify **PMDQPROF** in the text box, and click the next arrow.
The **Queue Connection Profile Maintenance Detailed** screen is displayed.
4. On the **Queue Connection Profile Maintenance Detailed** screen, specify the details as shown in the figure. For information on the fields, refer to the *Payments Core User Guide* in the Oracle Banking Payments Documentation Library.

Figure 2-5 Queue Connection Profile Maintenance Detailed

Queue Connection Profile Maintenance Detailed

New Enter Query

Profile ID *
Profile Description
User ID
Password
Context Provider URL
Initial Context Factory Class
Queue Factory JNDI

Queue Authentication Required

Audit Exit

 **Note:**

The **Profile ID** mentioned in the figure needs to be maintained as the Oracle Banking Branch User ID for the specific branch.

The **Profile ID** will be sent as **User ID** in the request header for the call-back from Oracle Banking Payments to Oracle Banking Branch.

3

Integration of Oracle Banking Virtual Account Management

The Oracle Banking Virtual Account Management can be integrated with the Oracle Banking Branch through specific maintenances.

The following maintenance procedures are needed to integrate Oracle Banking Branch with the Oracle Banking Virtual Account Management:

- [Configurations for Oracle Banking Branch](#)
You need to perform specific configurations to integrate Oracle Banking Branch with Oracle Banking Virtual Account Management.
- [Maintenance for Oracle Banking Virtual Account Management](#)

3.1 Configurations for Oracle Banking Branch

You need to perform specific configurations to integrate Oracle Banking Branch with Oracle Banking Virtual Account Management.

Connect to the database schema to configure the values in the database tables.

To configure the values:

1. Update the values in the BRANCHCOMMON and ADAPTER Schemas. For information on tables and values, refer to the table below.

Table 3-1 Configurations for BRANCHCOMMON and ADAPTER Schemas

Schema	Table	Value
BRANCHCOMMON	SRV_TM_BC_PARAM_DTLS	Update the following values: <ul style="list-style-type: none">• PARAM_VALUE = Y• PARAM_NAME='VAM_INTEGRATED'
BRANCHCOMMON	SRV_TM_BC_PARAM_DTLS	Update the following values: <ul style="list-style-type: none">• PARAM_VALUE = Y• PARAM_NAME='VAM_IDENTIFIER'
ADAPTER	SRV_TM_AD_EXT_SYS_DEST_DTLS	Update the following values for the virtual account and virtual identifier services (VAM_ACC_URL and VAM_EAC_CHECK): <ul style="list-style-type: none">• Server IP and port in HOST_SERVER column• GL in BRIDGE_GL column <div style="background-color: #e6f2ff; padding: 10px;"><p> Note:</p><p>The BRIDGE_GL is not required for the virtual identifier.</p></div>

- Update the services of Oracle Banking Payments as follows:

Table 3-2 Oracle Banking Payments Services

Destination	URL Value
VAM_ACC_URL	/obvam-transaction-journal-services/service/txns
VAM_EAC_CHECK	/obvam-transaction-journal-services/service/eac

3.2 Maintenance for Oracle Banking Virtual Account Management

You need to perform the following maintenances to integrate Oracle Banking Virtual Account Management with Oracle Banking Branch.

This topic contains the following subtopics:

- [Maintain Entry in Common Core](#)
 You can maintain the entry in common core to integrate Oracle Banking Branch with Oracle Banking Virtual Account Management.
- [Create User and Assign Role](#)
 You need to create a user for Oracle Banking Branch and assign the role for the user to perform journal transactions in Oracle Banking Virtual Account Management.
- [Create Upload Source](#)
 You need to maintain the upload source code for the external system (Oracle Banking Branch) to integrate with Oracle Banking Virtual Account Management.

3.2.1 Maintain Entry in Common Core

You can maintain the entry in common core to integrate Oracle Banking Branch with Oracle Banking Virtual Account Management.

Connect to the database schema to configure the values in the database tables.

Maintain the entry in common core as follows:

Update the entry in the `CMC_TM_EXT_SYSTEM` table in common core with a valid WSDL URL for `FCUBSCoreentitiesService` web service exposed by Oracle Banking Virtual Account Management.

3.2.2 Create User and Assign Role

You need to create a user for Oracle Banking Branch and assign the role for the user to perform journal transactions in Oracle Banking Virtual Account Management.

Log in to Oracle Banking Virtual Account Management Homepage. For information on how to log in, refer to *Oracle Banking Getting Started User Guide* in the Oracle Banking Virtual Account Management Documentation Library.

To create a user and assign the roles:

1. On the Homepage, click **Security Management**. Under **Security Management**, click **User**, and then select **Create User** or specify **Create User** in the search icon bar and select the screen.

The **Create User** screen is displayed.

2. On the **Create User** screen, specify the details in the fields as shown in the figure. For information on the fields, refer to the *Oracle Banking Security Management System User Guide* in the Oracle Banking Branch Documentation Library.

Figure 3-1 Create User

Create User

User Details

Name Required

Login ID Required

Home Branch Required

Status

User Status Required

Status Changed On

Is Supervisor

Manager ID

Start Date

End Date

System User

Telephone Number Home Phone Number Mobile Number Fax

Language Code Required

User Role Branches

No data to display.

Page 1 (0 of 0 items) |< < 1 > >|

User Applications

Select All Applications

<input type="checkbox"/>	Application Name	Application Description
No data to display.		

Page 1 (0 of 0 items) |< < 1 > >|

Customer Access Groups

<input type="checkbox"/>	Customer Access Group	Customer Access Description
No data to display.		

Page 1 (0 of 0 items) |< < 1 > >|

3. Share the user to Oracle Banking Branch.

3.2.3 Create Upload Source

You need to maintain the upload source code for the external system (Oracle Banking Branch) to integrate with Oracle Banking Virtual Account Management.

Log in to Oracle Banking Branch Homepage. For information on how to log in, refer to *Getting Started User Guide* in the Oracle Banking Branch Documentation Library.

To create the upload source code:

1. On the Homepage, click **Core Maintenance**. Under **Core Maintenance**, click **Upload Source**, and then select **Create Upload Source** or specify **Create Upload Source** in the search icon bar and select the screen.

The **Create Upload Source** screen is displayed.

2. On the **Create Upload Source** screen, specify the details in the fields as shown in the figure. For information on the fields, refer to the *Oracle Banking Common Core User Guide* in the Oracle Banking Branch Documentation Library.

Figure 3-2 Create Upload Source

The screenshot shows the 'Create Upload Source' form. The form has a title bar 'Create Upload Source' with window controls. Below the title bar are four fields: 'Source Code' (with a 'Required' label below it), 'Source Description', 'Base Data From Flexcube' (with a toggle switch), and 'System Authorization Required' (with a toggle switch). The main area of the form is a large grid with a repeating pattern of overlapping circles. At the bottom right, there are 'Cancel' and 'Save' buttons.