

Oracle® Banking Payments

Common Core - Electronic Messaging

Service User Guide



Release 14.8.2.0.0

G53924-01

April 2026

The Oracle logo, consisting of a solid red square with the word "ORACLE" in white, uppercase, sans-serif font centered within it.

ORACLE®

Copyright © 2007, 2026, Oracle and/or its affiliates.

This software and related documentation are provided under a license agreement containing restrictions on use and disclosure and are protected by intellectual property laws. Except as expressly permitted in your license agreement or allowed by law, you may not use, copy, reproduce, translate, broadcast, modify, license, transmit, distribute, exhibit, perform, publish, or display any part, in any form, or by any means. Reverse engineering, disassembly, or decompilation of this software, unless required by law for interoperability, is prohibited.

The information contained herein is subject to change without notice and is not warranted to be error-free. If you find any errors, please report them to us in writing.

If this is software, software documentation, data (as defined in the Federal Acquisition Regulation), or related documentation that is delivered to the U.S. Government or anyone licensing it on behalf of the U.S. Government, then the following notice is applicable:

U.S. GOVERNMENT END USERS: Oracle programs (including any operating system, integrated software, any programs embedded, installed, or activated on delivered hardware, and modifications of such programs) and Oracle computer documentation or other Oracle data delivered to or accessed by U.S. Government end users are "commercial computer software," "commercial computer software documentation," or "limited rights data" pursuant to the applicable Federal Acquisition Regulation and agency-specific supplemental regulations. As such, the use, reproduction, duplication, release, display, disclosure, modification, preparation of derivative works, and/or adaptation of i) Oracle programs (including any operating system, integrated software, any programs embedded, installed, or activated on delivered hardware, and modifications of such programs), ii) Oracle computer documentation and/or iii) other Oracle data, is subject to the rights and limitations specified in the license contained in the applicable contract. The terms governing the U.S. Government's use of Oracle cloud services are defined by the applicable contract for such services. No other rights are granted to the U.S. Government.

This software or hardware is developed for general use in a variety of information management applications. It is not developed or intended for use in any inherently dangerous applications, including applications that may create a risk of personal injury. If you use this software or hardware in dangerous applications, then you shall be responsible to take all appropriate fail-safe, backup, redundancy, and other measures to ensure its safe use. Oracle Corporation and its affiliates disclaim any liability for any damages caused by use of this software or hardware in dangerous applications.

Oracle®, Java, MySQL, and NetSuite are registered trademarks of Oracle and/or its affiliates. Other names may be trademarks of their respective owners.

Intel and Intel Inside are trademarks or registered trademarks of Intel Corporation. All SPARC trademarks are used under license and are trademarks or registered trademarks of SPARC International, Inc. AMD, Epyc, and the AMD logo are trademarks or registered trademarks of Advanced Micro Devices. UNIX is a registered trademark of The Open Group.

This software or hardware and documentation may provide access to or information about content, products, and services from third parties. Oracle Corporation and its affiliates are not responsible for and expressly disclaim all warranties of any kind with respect to third-party content, products, and services unless otherwise set forth in an applicable agreement between you and Oracle. Oracle Corporation and its affiliates will not be responsible for any loss, costs, or damages incurred due to your access to or use of third-party content, products, or services, except as set forth in an applicable agreement between you and Oracle.

Contents

Preface

| | |
|-----------------------------|-----|
| Purpose | i |
| Audience | i |
| Acronyms and Abbreviations | i |
| Documentation Accessibility | ii |
| Critical Patches | ii |
| Diversity and Inclusion | ii |
| Conventions | iii |
| Related Resources | iii |
| Screenshot Disclaimer | iii |
| Basic Actions | iii |
| Symbols & Icons | iv |

1 EMS Maintenance

| | | |
|-------|--|----|
| 1.1 | Message Media Control Maintenance | 2 |
| 1.1.1 | Maintain Message Media Control | 2 |
| 1.2 | Message Queues Mapping Maintenance | 6 |
| 1.2.1 | Maintain Message Queue Mapping | 6 |
| 1.3 | Message Queue Maintenance | 8 |
| 1.3.1 | Maintain Message Queues | 8 |
| 1.4 | SWIFT Message Notification Browser | 9 |
| 1.4.1 | Process SWIFT Message Notification Browser | 10 |
| 1.5 | SWIFT Net Service Definition | 12 |
| 1.5.1 | Maintain SWIFTNet Service Definition | 12 |
| 1.5.2 | Process SWIFT Net Service Definition Summary | 13 |
| 1.6 | SWIFT Local Authentication Maintenance | 14 |
| 1.6.1 | Maintain SWIFT LAU Key | 15 |
| 1.6.2 | Process SWIFT LAU Key Summary | 16 |
| 1.6.3 | Process Outgoing SWIFT LAU | 17 |
| 1.6.4 | Process Incoming SWIFT LAU | 18 |
| 1.7 | Mapping Rule Group | 19 |
| 1.7.1 | Maintain Rule Group Mapping | 19 |
| 1.7.2 | Process Rule Group Mapping Summary | 20 |

| | | |
|--------|--|----|
| 1.8 | Define Rule Group | 21 |
| 1.8.1 | Maintain Rule Group Definition | 21 |
| 1.8.2 | Process Rule Group Definition Summary | 22 |
| 1.9 | Define Routing Rule | 23 |
| 1.9.1 | Maintain Routing Rule Definition | 23 |
| 1.9.2 | Process Routing Rule Definition Summary | 26 |
| 1.10 | Define Protocol Parameter | 27 |
| 1.10.1 | Maintain Protocol Parameter Definition | 27 |
| 1.10.2 | Process Protocol Parameter Definition Summary | 28 |
| 1.11 | File Transfer Adapter Connector Configuration | 29 |
| 1.11.1 | Maintain File Transfer Adapter Connector Configuration | 30 |
| 1.11.2 | Process SWIFTNet FTA Connector Definition Summary | 31 |
| 1.12 | Distinguished Name Definition | 32 |
| 1.12.1 | Maintain Distinguished Name Definition | 33 |
| 1.12.2 | Process Distinguished Name Definition Summary | 34 |
| 1.13 | Define Debulk Rule | 35 |
| 1.13.1 | Maintain De Bulk Rule Definition | 35 |
| 1.13.2 | Process Debulk Rule Summary | 36 |
| 1.14 | Connectivity Operation Manager | 37 |
| 1.14.1 | Maintain Connectivity Operation Manager | 37 |
| 1.15 | Process Outbound File Browser | 38 |
| 1.16 | Process Inbound File Browser | 40 |
| 1.17 | Define Bulk Preference | 41 |
| 1.17.1 | Maintain Bulking Preference Definition | 41 |
| 1.17.2 | Process Bulking Preference Definition Summary | 43 |
| 1.18 | Process Bulk Monitor Summary | 45 |

Index

Preface

This topic contains the following sub-topics:

- [Purpose](#)
- [Audience](#)
- [Acronyms and Abbreviations](#)
- [Documentation Accessibility](#)
- [Critical Patches](#)
- [Diversity and Inclusion](#)
- [Conventions](#)
- [Related Resources](#)
- [Screenshot Disclaimer](#)
- [Basic Actions](#)
- [Symbols & Icons](#)

This guide has the following list of symbols and icons.

Purpose

This user manual is designed to help you quickly get acquainted with the many functions routinely executed everyday in Oracle Banking Payments.

To access information specific to a particular field, place the cursor on the relevant field and press **F1** on the keyboard.

Audience

Table 1 Audience

| Role | Function |
|---------------------------------------|---|
| Back office clerk | Input functions for contracts |
| Back office managers/officers | Authorization functions |
| Product Managers | Product definition and authorization |
| End of Day operators | Processing during End of Day/Beginning of Day |
| Financial Controller/Product Managers | Generation of reports |

Acronyms and Abbreviations

The list of the acronyms and abbreviations used in this guide are as follows:

Table 2 Abbreviation

| Abbreviation | Description |
|--------------|---|
| POSTEOPD | Post End of Previous Day |
| MARKEOPD | Mark End of Previous Day |
| MARKTI | Mark Transaction Input |
| POSTEOBOD | Post End of Beginning of Day |
| MARKBOD | Mark Beginning of Day |
| MARKEOD | Mark End of Day |
| POSTEOED | Post End of End of Day |
| MARKEOFI | Mark End of Financial Input |
| POSTEOFI | Post End of Financial Input |
| MARKEOTI | Mark End of Transaction Input |
| POSTEOTI | Post End of Transaction Input |
| TI | Transaction Input |
| EOC | End of Cycle |
| BOD | Beginning of Day |
| EOD | End of Day |
| EOPD | End of Previous Day |
| FI | Financial Input |
| EOTI | End of Transaction Input |
| SMS | Security Management System |
| OBMA | Oracle Banking Microservice Architecture |
| ODT | Open Development Tool |
| SCIM | System for Cross-domain Identity Management |

Documentation Accessibility

For information about Oracle's commitment to accessibility, visit the Oracle Accessibility Program website at <http://www.oracle.com/pls/topic/lookup?ctx=acc&id=docacc>.

Access to Oracle Support

Oracle customers that have purchased support have access to electronic support through My Oracle Support. For information, visit <http://www.oracle.com/pls/topic/lookup?ctx=acc&id=info> or visit <http://www.oracle.com/pls/topic/lookup?ctx=acc&id=trs> if you are hearing impaired.

Critical Patches

Oracle advises customers to get all their security vulnerability information from the Oracle Critical Patch Update Advisory, which is available at [Critical Patches, Security Alerts and Bulletins](#). All critical patches should be applied in a timely manner to make sure effective security, as strongly recommended by [Oracle Software Security Assurance](#).

Diversity and Inclusion

Oracle is fully committed to diversity and inclusion. Oracle respects and values having a diverse workforce that increases thought leadership and innovation. As part of our initiative to

build a more inclusive culture that positively impacts our employees, customers, and partners, we are working to remove insensitive terms from our products and documentation. We are also mindful of the necessity to maintain compatibility with our customers' existing technologies and the need to ensure continuity of service as Oracle's offerings and industry standards evolve. Because of these technical constraints, our effort to remove insensitive terms is ongoing and will take time and external cooperation.

Conventions

The following text conventions are used in this document:

| Convention | Meaning |
|-----------------|--|
| boldface | Boldface type indicates graphical user interface elements associated with an action, or terms defined in text. |
| <i>italic</i> | Italic type indicates book titles, emphasis, or placeholder variables for which you supply particular values. |
| monospace | Monospace type indicates commands within a paragraph, URLs, code in examples, text that appears on the screen, or text that you enter. |

Related Resources

For more information on any related features, refer to the following documents:

- *Oracle Banking Common Core User Guides*
- *Dashboard User Guide*
- *Exception Queues User Guide*
- *Messaging System User Guide*
- *Payments Core User Guide*
- *Pricing User Guide*

Screenshot Disclaimer

The personal information used in the interface or documents is sample data and does not exist in the real world. It is provided for reference purposes only.

Basic Actions

The basic actions performed in the screens are as follows:

Table 3 Basic Actions

| Actions | Description |
|----------------|--|
| Approve | Click Approve to approve the initiated record. - This button is displayed once the user click Authorize . |
| Audit | Click Audit to view the maker details, checker details of the particular record. - This button is displayed only for the records that are already created. |

Table 3 (Cont.) Basic Actions

| Actions | Description |
|-----------------------------|--|
| Authorize | Click Authorize to authorize the record created. A maker of the screen is not allowed to authorize the same. Only a checker can authorize a record. - This button is displayed only for the already created records. For more information on the process, refer Authorization Process. |
| Cancel | Click Cancel to cancel the action performed. |
| Close | Click Close to close a record. This action is available only when a record is created. |
| Collapse All | Click Collapse All to hide the details in the sections. - This button is displayed once the user click Compare . |
| Compare | Click Compare to view the comparison through the field values of old record and the current record. - This button is displayed in the widget once the user click Authorize . |
| Confirm | Click Confirm to confirm the action performed. |
| Expand All | Click Expand All to expand and view all the details in the sections. - This button is displayed once the user click Compare . |
| New | Click New to add a new record. The system displays a new record to specify the required data. The fields marked with asterisk are mandatory. - This button is displayed only for the records that are already created. |
| OK | Click OK to confirm the details in the screen. |
| Save | Click Save to save the details entered or selected in the screen. |
| Unlock | Click Unlock to update the details of an existing record. The system displays an existing record in editable mode. - This button is displayed only for the records that are already created. |
| View | Click View to view the details in a particular modification stage. - This button is displayed in the widget once the user click Authorize . |
| View Difference only | Click View Difference only to view a comparison through the field element values of old record and the current record, which has undergone changes. - This button is displayed once the user click Compare . |

Symbols & Icons

This guide has the following list of symbols and icons.

Table 4 Symbols and Icons - Common





| Icons | Function |
|---|----------|
| <p>Figure 1 Exit</p>  | Exit |

Table 4 (Cont.) Symbols and Icons - Common

| Icons | Function |
|--|-------------|
| Figure 2 Add Row  | Add row |
| Figure 3 Delete Row  | Delete row |
| Figure 4 Option List  | Option List |

1

EMS Maintenance

This topic provides an overview of the maintenance required on the Electronic Messaging System.

This topic contains the following sub-topics:

- [Message Media Control Maintenance](#)
This topic provides an overview of the maintenance required on the Message Media Control.
- [Message Queues Mapping Maintenance](#)
This topic provides an overview of the message queues mapping maintenance required on the Electronic Messaging System.
- [Message Queue Maintenance](#)
This topic provides an overview of the message queue maintenance required on the Electronic Messaging System.
- [SWIFT Message Notification Browser](#)
This topic provides an overview of the SWIFT Message Notification Browser.
- [SWIFT Net Service Definition](#)
This topic provides an overview of the SWIFT Net Service Definition.
- [SWIFT Local Authentication Maintenance](#)
This topic provides an overview of the SWIFT Local Authentication Maintenance.
- [Mapping Rule Group](#)
This topic provides an overview of the Mapping Rule Group.
- [Define Rule Group](#)
This topic provides an overview of the Rule Group Definition.
- [Define Routing Rule](#)
This topic provides an overview of the Routing Group Definition.
- [Define Protocol Parameter](#)
This topic provides an overview of the Protocol Parameter Definition.
- [File Transfer Adapter Connector Configuration](#)
This topic provides an overview of the file transfer adapter connector configuration.
- [Distinguished Name Definition](#)
This topic provides an overview of the Distinguished Name Definition.
- [Define Debulk Rule](#)
This topic provides an overview of the Debulk Rule Definition.
- [Connectivity Operation Manager](#)
This topic provides an overview of the Connectivity Operation Manager.
- [Process Outbound File Browser](#)
This topic explains systematic instructions to search and view the outbound files.
- [Process Inbound File Browser](#)
This topic explains systematic instructions to process the summary of the inbound file browser.

- [Define Bulk Preference](#)
This topic provides an overview of the Bulk Preference Definition.
- [Process Bulk Monitor Summary](#)
This topic explains systematic instructions to process the summary of messages and executions in bulk.

1.1 Message Media Control Maintenance

This topic provides an overview of the maintenance required on the Message Media Control.

The messages that are sent from and delivered to the bank are transmitted and received over sources that are external to Oracle Banking Corporate Lending. These external sources are called Media Control Systems (MCS).

In a distributed environment, the database of a branch is located in a node or server. The MCS of the messages is also installed in a node. Thus, while defining an MCS, also indicate the node in which it is installed.

An MCS can handle only one media, hence the user needs to set up several media control systems for the various media types maintained for the bank. Apart from indicating the media type for an MCS, the user can indicate separate directories from which Oracle Banking Corporate Lending should read and write incoming and outgoing messages for a given media.

The user can maintain MCS details in the **Message Media Control Maintenance** screen. The details that are specified in this screen control the medium of delivery and reception of messages.

This topic contains the following sub-topics:

- [Maintain Message Media Control](#)
This topic explains systematic instructions to maintain message media control.

1.1.1 Maintain Message Media Control

This topic explains systematic instructions to maintain message media control.

1. On **Homescreen**, type **MSDMGMCS** in the text box, and click **Next**.
The **Message Media Control Maintenance** screen displays.

Figure 1-1 Message Media Control Maintenance - Delivery Preference

The screenshot displays the 'Message Media Control Maintenance' application window. At the top, there are 'New' and 'Enter Query' buttons. The main form area contains several input fields: 'Node *', 'Media Control System *', 'Media *', and 'Status' (set to 'Active'). Below these is a 'Delivery Preference' section with three radio button options: 'Folder' (selected), 'Queue', and 'Message over Rest'. To the right of this section is an 'MX Preference' label. At the bottom of the form, there are three more input fields: 'In Directory', 'Out Directory', and 'File Prefix'. The bottom of the window features a 'Fields' button on the left and 'Audit' and 'Exit' buttons on the right.

2. Click **New** to maintain details of a new media control system.

The **Message Media Control Maintenance** screen displays.

3. On the **Message Media Control Maintenance** screen, specify the fields.

Note

The fields, which are marked with an asterisk, are mandatory.

For more information on fields, refer to the field description table.

Table 1-1 Message Media Control Maintenance - Field Description

| Field | Description |
|-----------------------------|--|
| Node | Click Search and specify the Node from the list of values. A node is the database instance on which Oracle Banking Corporate Lending is installed. On assigning a code to an MCS, specify the node or server at which the MCS is located. A branch's database is located in a node and an MCS is also installed in a node. Thus, while defining an MCS, specify the node at which it has been installed. |
| Media Control System | Click Search and specify the Media Control System from the list of values. In Oracle Banking Corporate Lending, each media control system is identified by a 15- character code called an MCS code. If required, follow own convention for devising this code. The code that is assigned an MCS should be unique as it is used to identify the external source. |
| Media | Click Search and specify the Media from the list of values. Specify the media for which the bank is using the MCS. For example, if an MCS is set as MCSSWIFT and the media type is set as SWIFT , it indicates that Oracle Banking Corporate Lending can receive and transmit SWIFT messages through the media control system MCSSWIFT . |
| Status | Select the status of an MCS from the drop-down list: <ul style="list-style-type: none"> • Active • Passive It is only when an MCS is Active that messages will be directed to it. For example, if an MCS located at the node in which the branch operates malfunctions, indicate that the MCS is Passive . In this case, Oracle Banking Corporate Lending will not write into or read from the directories on the node. No message will be routed through a passive MCS. |
| Delivery Type | Select the delivery type from the Folder and Queue options. Depending on the selection, specify the details in the corresponding fields as follows: <ul style="list-style-type: none"> • Folder - If the Folder option is selected as the Delivery Type, specify the In Directory and the Out Directory. Further, after selecting Folder, if the Unix Swift Server option is checked for a UNIX SWIFT server, then specify the Unix In-Directory and the Unix Out-Directory. For a Windows Server, the In Directory and Out Directory must be maintained. • Queue - If the Queue option is selected as the Delivery Type, specify In Queue, Out Queue, and the type of queue that means Microsoft Message Queue or WebSphere Messaging Queue. |

Table 1-1 (Cont.) Message Media Control Maintenance - Field Description

| Field | Description |
|---------------------------------------|---|
| In Directory and Out Directory | If the Delivery Type is selected as Folder , and the SWIFT server is a Windows server then specify the full path of the directories from which Oracle Banking Corporate Lending should read and write incoming and outgoing messages respectively instead of specifying the node on which an MCS is located. |
| File Prefix | For the Media Control System, identify the outgoing message files generated in a different media with unique prefixes. Specify the unique identifier in this field. |
| In Queue | If the Delivery Type is Queue , then enter the full path of the queue in the node or server into which the MCS should store the incoming message hand-off file. Oracle Banking Corporate Lending by default pickup up and read all incoming messages transmitted through the specified media from this queue. |
| Out Queue | Specify the full path of the queue in the node or server into which the message hand-off file from Oracle Banking Corporate Lending for the specified media should be stored. The MCS which is located on the same node, will by default store the outgoing messages in this queue. |
| Unix Swift Server | Switch this toggle if the SWIFT server is on UNIX at the bank. In this screen, specify the default In and Out Directories for the SWIFT message hand-off files. To continue with the normal banking operations, connect to another node and indicate the directory on that node from which Oracle Banking Corporate Lending should read from and write into. |

The following process flow explains about MCS setup:

Figure 1-2 MCS setup

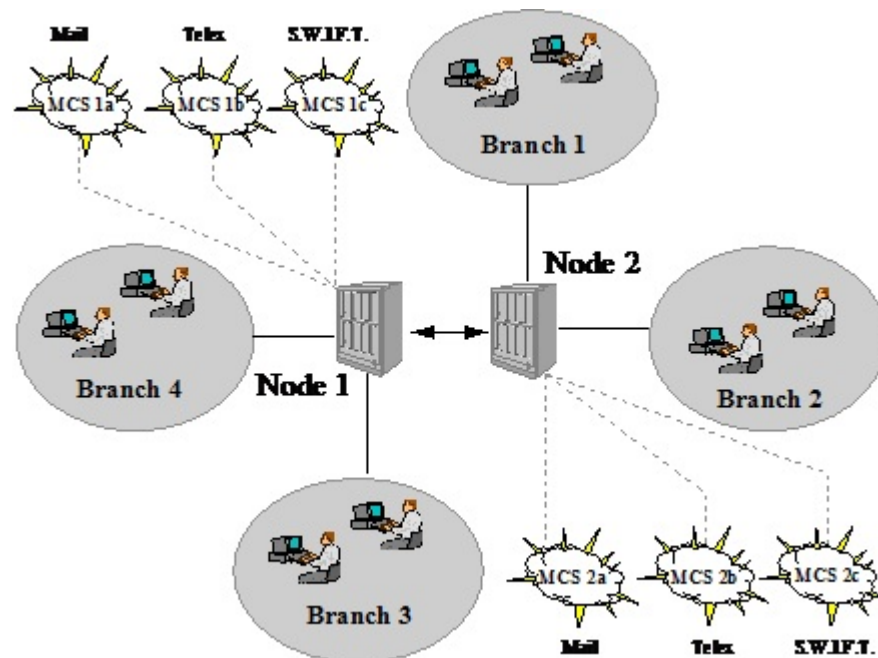

SWIFT Server on UNIX - In the **Message Media Control Maintenance** screen, indicate if the SWIFT server at the bank is on UNIX. Subsequently, specify the default In and Out Directories for the SWIFT message hand-off files.

Table 1-2 SWIFT Server on UNIX - Field Description

| Field | Description |
|---------------------------|---|
| UNIX In-Directory | Specify the full path of the directory on the SWIFT server where would like to store incoming SWIFT message files. Oracle Banking Corporate Lending pickups and process all incoming SWIFT message files from this directory. |
| UNIX Out-Directory | Specify the directory on the SWIFT server where would like to store outgoing SWIFT message hand-off files. |

- Click **MX Preference** tab

Figure 1-3 Message Media Control Maintenance - MX Preference

The screenshot displays the 'Message Media Control Maintenance' application window. At the top, there are search and navigation options. Below, the 'MX Preference' tab is active, showing several configuration panels:

- Delivery Preference:** Includes fields for 'Node', 'Media Control System', and 'Media', all marked with an asterisk (*). The 'Status' is set to 'Active'.
- DataPDU Preferences:** Contains a 'Data PDU Required' toggle switch and an 'XMLv2 Revision' dropdown menu with 'Revision 11' selected.
- Other Preferences:** Features a 'Delivery Notification Required' toggle switch and a 'File Type' text input field.
- SWIFT LAU Preferences:** Includes a 'Swift LAU Required' toggle switch and an 'LAU Type' dropdown menu with 'HMAC' selected.
- LAU Key - Outgoing:** Has two text input fields for 'Key First Part' and 'Key Second Part'.
- LAU Key - Incoming:** Also has two text input fields for 'Key First Part' and 'Key Second Part'.

At the bottom of the window, there are buttons for 'Fields', 'Audit', and 'Exit'.

- On the **Message Media Control Maintenance - MX Preference** tab, specify the fields.

Note

The fields, which are marked with an asterisk, are mandatory.

For more information on fields, refer to the field description table.

Table 1-3 MX Preference - Field Description

| Field | Description |
|---------------------------|---|
| Data PDU Required | Switch this toggle, if the data PDU is required. |
| XMLv2 Revision | Select the XMLv2 revision from the drop-down list: <ul style="list-style-type: none"> Revision 11 Revision 10 |
| Swift LAU Required | Switch this toggle, if the Swift LAU is required. |

Table 1-3 (Cont.) MX Preference - Field Description

| Field | Description |
|---------------------------------------|---|
| LAU Type | Select LAU type from the drop-down list: <ul style="list-style-type: none"> • HMAC • GCM |
| Delivery Notification Required | Switch this toggle to get the delivery notification. |
| File Type | Select the required file extension from the drop-down list: <ul style="list-style-type: none"> • .ia • .xml |

Table 1-4 LAU Key Outgoing - Field Description

| Field | Description |
|------------------------|--|
| Key First Part | Specify LAU outgoing key first part. |
| Key Second Part | Specify LAU outgoing key second part. |

Table 1-5 LAU Key Incoming - Field Description

| Field | Description |
|------------------------|--|
| Key First Part | Specify LAU incoming key first part. |
| Key Second Part | Specify LAU incoming key second part. |

6. After making mandatory entries, save the record.

For the MCS, identify outgoing message files generated in the media with unique prefixes. Oracle Banking Corporate Lending will automatically prefix outgoing message hand-off files for the MCS with the prefix that is specified.

An MCS record that has been created should be authorized by a user, bearing a different **Login ID**, before the End of Day process (EOD) runs.

7. Click **Exit** to end the transaction.

1.2 Message Queues Mapping Maintenance

This topic provides an overview of the message queues mapping maintenance required on the Electronic Messaging System.

This topic contains the following sub-topic:

- [Maintain Message Queue Mapping](#)
This topic explains systematic instructions to maintain the mapping of Message Queues.

1.2.1 Maintain Message Queue Mapping

This topic explains systematic instructions to maintain the mapping of Message Queues.

Note

The fields which are marked in asterisk are mandatory.

1. On **Homescreen**, type **MSDQMAP** in the text box, and click **Next**.
The **Message Queue Mapping Maintenance** screen displays.

Figure 1-4 Message Queue Mapping Maintenance

2. On the **Message Queue Mapping Maintenance** screen, specify the fields.

Note

The fields, which are marked with an asterisk, are mandatory.

For more information on fields, refer to the field description table.

Table 1-6 Message Queue Mapping Maintenance - Field Description

| Field | Description |
|-----------------------|--|
| Media | Click Search and specify the Media from the list of values. This field represents the delivery media. For example, SWIFT |
| BIC Code | Click Search and specify the BIC Code from the list of values. This field represents the receiver's BIC for which a message is to be routed to a specific queue in a particular branch. Select ALL as a BIC Code to specify the wildcard for all entries. |
| Currency | Click Search and specify the Currency from the list of values. This field represents the currency of the incoming message. For example, In an MT103 it would be from tag 32A. This is an additional parameter to determine the Booking Branch and Queue . Select ALL as a currency code to maintain the wild card for all entries. |
| Booking Branch | Click Search and specify the Booking Branch from the list of values. This field indicates the branch in which incoming messages are routed. A set of all the branches having the same SWIFT BIC as that mentioned in the BIC Code field is displayed in the list of values. |
| Branch Name | The system displays the Branch Name . |
| Message Type | Click Search and specify the Message Type from the list of values. This field indicates the message type for which the routing procedure is required. |
| Queue | Click Search and specify the Queue from the list of values. |

While processing **MT700** and **MT701** messages, the system ensures the following points:

- **MT700** and **MT701** are routed to the branch using the incoming routing specifications maintained in the **Message Queue Mapping Maintenance** screen.
- For **MT700**, in case the branch of the corresponding **MT701** is different from that of the **MT700**, it is re-aligned to the branch of the **MT700**.
- **MT701** messages are processed only after the receipt of **MT700**.

Note

It is allowed to maintain the same BIC for the main branch and the sub-branch as well.

3. Click **Exit** to end the transaction.

1.3 Message Queue Maintenance

This topic provides an overview of the message queue maintenance required on the Electronic Messaging System.

This topic contains the following sub-topic:

- [Maintain Message Queues](#)
This topic explains systematic instructions to maintain message queues.

1.3.1 Maintain Message Queues

This topic explains systematic instructions to maintain message queues.

All Incoming SWIFT and Non-SWIFT messages are routed through a messaging queue. Maintain different user queues to which incoming messages are directed. Users with appropriate rights are allowed to access a particular queue. All 798 incoming index messages 770,761,784 are also captured on the **Message Queue Maintenance** screen.

Note

The fields which are marked in asterisk are mandatory.

1. On **Homescreen**, type **MSDQMNT** in the text box, and click **Next**.
The **Message Queue Maintenance** screen displays.

Figure 1-5 Message Queue Maintenance

2. On the **Message Queue Maintenance** screen, specify the fields.
For more information on fields, refer to the field description table.

Table 1-7 Message Queue Maintenance - Field Description

| Field | Description |
|-------------------------|--|
| Queue | Specify a name of a queue. |
| Description | Type a short description of a queue. |
| STP Preference | Select STP preference from the drop-down list: <ul style="list-style-type: none"> • No STP • Auto STP • Suppress Select Auto STP to process the SWIFT message automatically if it is part of any queue. |
| Collection Queue | The codes of various SWIFT and Non-SWIFT messages would be routed to this queue. Switch this toggle button for maintaining the unique queue. Note: The codes of various SWIFT and Non-SWIFT message lists in the grid do not apply to the Collection Queue . |

Assign a message to more than one messaging queue. At the time of maintaining rules for a message (discussed in the subsequent sections of this document), select the appropriate queue for each rule from the list of queues to which the message is linked.

3. Click **Add** to add a message to the queue being defined.
4. Click **Delete** to remove a message from the queue.
5. Click **Exit** to end the transaction.

1.4 SWIFT Message Notification Browser

This topic provides an overview of the SWIFT Message Notification Browser.

This topic contains the following sub-topic:

- [Process SWIFT Message Notification Browser](#)
This topic explains systematic instructions to process the SWIFT message notification browser.

1.4.1 Process SWIFT Message Notification Browser

This topic explains systematic instructions to process the SWIFT message notification browser.

The SWIFT explains the following two types of notification messages to Oracle Banking Corporate Lending:

- **ACK/NAK** acknowledgment messages indicating whether the message has been successfully delivered to **SWIFTNet FIN** service from where it gets forwarded to the receiving system.
- Delivery notification messages indicate whether the message was successfully delivered to the receiving system.

Note

The fields which are marked in asterisk are mandatory.

1. On **Homescreen**, type **MSSNOTIB** in the text box, and click **Next**.
The **SWIFT Message Notification Browser** screen displays.

Figure 1-6 SWIFT Message Notification Browser

2. On the **SWIFT Message Notification Browser** screen, specify the fields.
For more information on fields, refer to the field description table.

Table 1-8 SWIFT Message Notification Browser - Field Description

| Field | Description |
|---------------------------|--|
| Document Number | Click Search and specify the Document Number from the list of values. |
| Reference Number | Click Search and specify the Reference Number from the list of values. |
| User Reference | Click Search and specify the User Reference from the list of values. |
| SWIFT Message Type | Click Search and specify the SWIFT Message Type from the list of values. |

Table 1-8 (Cont.) SWIFT Message Notification Browser - Field Description

| Field | Description |
|--------------------------------------|--|
| Acknowledgment Status | Click Search and specify the Acknowledgment Status from the list of values. |
| Delivery Notification | Click Search and specify the Delivery Notification from the list of values. |
| Non-Delivery Warning | Click Search and specify the Non-Delivery Warning from the list of values. |
| Authorization Status | Select authorization status from the drop-down list: <ul style="list-style-type: none"> • Authorized • Unauthorized • Rejected |
| Process Status | Select the process status from the drop-down list: <ul style="list-style-type: none"> • Processed • Unprocessed |
| Acknowledgment Message Format | Select the acknowledgment message format from the drop-down list: <ul style="list-style-type: none"> • MT • MX |
| Reconciliation Reference | Click Search and specify the Reconciliation Reference from the list of values. |
| Failed Delivery Notification | Click Search and specify the Failed Delivery Notification from the list of values. |

3. Click **Search** after specifying the search parameters.

The system identifies all records satisfying the specified criteria and displays the following details for each one of them:

- **Branch**
- **Document Number**
- **Reference Number**
- **Message Reference**
- **User Reference**
- **SWIFT Message Type**
- **Acknowledgment Status**
- **Delivery Notification**
- **Non-Delivery Warning**
- **Acknowledgment Time**
- **Delivery Notification Time**
- **Non-Delivery Warning Time**
- **Receiver**
- **Branch Date**
- **Authorization Status**
- **Release Time**
- **Running Number**
- **Process Status**

- **Acknowledgment Message Format**
- **Reconciliation Reference**
- **Media**
- **Failed Delivery Warning**
- **Failed Delivery Notification Time**
- **Failed Delivery Notification**

A background job running on this browser updates the outgoing browser with the **ACK/NAK** and the delivery status of the message. The sender MUR from SWIFT is used to match the corresponding outgoing browser record.

4. Select the record and click **View ACK/NAK Message** to view the ACK/NAK message.
5. Select the record and click **View Delivery Notification Message** to view the delivery notification message.
6. Select the record and click **View Non-Delivery Warning Message** to view the non-delivery warning message.
7. Select the record and click **View Failed Delivery Warning Message** to view failed delivery warning message.
8. Click **Exit** to end the transaction.

1.5 SWIFT Net Service Definition

This topic provides an overview of the SWIFT Net Service Definition.

This topic contains the following sub-topics:

- [Maintain SWIFTNet Service Definition](#)
This topic explains systematic instructions to maintain the SWIFTNet service definition.
- [Process SWIFT Net Service Definition Summary](#)
This topic explains systemic instructions to process the SWIFT Net service definition summary.

1.5.1 Maintain SWIFTNet Service Definition

This topic explains systematic instructions to maintain the SWIFTNet service definition.

Note

The fields which are marked in asterisk are mandatory.

1. On **Homescreen**, type **MSDSWTSR** in the text box, and click **Next**.
The **SWIFTNet Service Definition** screen displays.

Figure 1-7 SWIFTNet Service Definition

2. On the **SWIFTNet Service Definition** screen, specify the fields.
For more information on fields, refer to the field description table.

Table 1-9 SWIFTNet Service Definition - Field Description

| Field | Description |
|---------------------|--|
| Service Name | Specify the SWIFTNet service name. |
| Service Mode | Select the service modes from the following options: <ul style="list-style-type: none"> • Real Time (RT) - Select this option to send and receive messages in real time. By default, the Real Time (RT) option is selected. • Store and Forward (SnF) - Select this option to send and receive messages by storing them in a location and then forwarding them accordingly. |
| Requestor DN | Specify the DN that sends the request to the service. Provide at least one DN. |
| Responder DN | Specify the DN that responds request for the service. Provide at least one DN. |

3. Click **Exit** to end the transaction.

1.5.2 Process SWIFT Net Service Definition Summary

This topic explains systemic instructions to process the SWIFT Net service definition summary.

Note

The fields which are marked in asterisk are mandatory.

1. On **Homescreen**, type **MSSSWTSR** in the text box, and click **Next**.
The **Swift Net Service Definition Summary** screen displays.

Figure 1-8 SWIFT Net Service Definition Summary

The screenshot shows the 'Swift Net Service Definition Summary' application window. At the top, there are search options: 'Search', 'Advanced Search', 'Reset', and 'Clear All'. A 'Records per page' dropdown is set to 15. Below this is a search filter section with 'Search (Case Sensitive)' expanded, showing three dropdown menus for 'Authorization Status', 'Record Status', and 'Service Name'. A search results table is visible below, with columns for 'Authorization Status', 'Record Status', and 'Service Name'. The table is currently empty, showing 'No data to display.' At the bottom of the table, there is a page indicator 'Page 1 Of 1' and navigation arrows. An 'Exit' button is located at the bottom right of the application window.

2. On the **Swift Net Service Definition Summary** screen, specify the fields.
For more information on fields, refer to the field description table.

Table 1-10 Swift Net Service Definition Summary - Field Description

| Field | Description |
|-----------------------------|---|
| Authorization Status | Select the authorization status from the drop-down list. The available options are: <ul style="list-style-type: none"> • Authorized • Unauthorized • Rejected |
| Record Status | Select the record status from the drop-down list: <ul style="list-style-type: none"> • Open • Closed |
| Service Name | Click Search and specify the Service Name from the list of values. |

3. Click **Search** after specifying the search parameters.
The system identifies all records satisfying the specified criteria and displays the following details for each one of them:
 - **Authorization Status**
 - **Service Name**
 - **Record Status**
4. Click **Exit** to end the transaction.

1.6 SWIFT Local Authentication Maintenance

This topic provides an overview of the SWIFT Local Authentication Maintenance.

This topic contains the following sub-topics:

- [Maintain SWIFT LAU Key](#)
This topic explains systematic instructions to maintain the SWIFT LAU key.
- [Process SWIFT LAU Key Summary](#)
This topic explains systematic instructions to process SWIFT LAU key maintenance details.

- [Process Outgoing SWIFT LAU](#)
This topic describes the flowchart of the outgoing message SWIFT LAU.
- [Process Incoming SWIFT LAU](#)
This topic describes the flowchart of the incoming message SWIFT LAU.

1.6.1 Maintain SWIFT LAU Key

This topic explains systematic instructions to maintain the SWIFT LAU key.

Through the **SWIFT LAU Key Maintenance** screen, maintain SWIFT authentication parameters. This screen can be accessed from the Head office only. The EMS module refers to SWIFT LAU maintenance data for calculating checksum for outbound and authentication of inbound messages. HMAC-SHA256 algorithm validation will be used to calculate the checksum and ensure the integrity of messages exchanged with SWIFT.

Note

The fields which are marked in asterisk are mandatory.

1. On **Homescreen**, type **MSDLAUMN** in the text box, and click **Next**.
The **SWIFT LAU Key Maintenance** screen displays.

Figure 1-9 SWIFT LAU Key Maintenance

2. On the **SWIFT LAU Key Maintenance** screen, specify the fields.
For more information on fields, refer to the field description table.

Table 1-11 SWIFT LAU Key Maintenance - Field Description

| Field | Description |
|--------------------------|---|
| Host Code | Click Search and specify the Host Code from the list of values. |
| Description | The system displays the description of the host code. |
| Message Direction | Select the direction of the message from the drop-down list based on the key maintained for the SWIFT message: <ul style="list-style-type: none"> • Incoming • Outgoing |

Table 1-11 (Cont.) SWIFT LAU Key Maintenance - Field Description

| Field | Description |
|---------------------------|---|
| SWIFT LAU Required | Switch the toggle button to enable SWIFT local authentication in the bank. If this toggle is enabled, then all other parameters in this screen are mandatory. |
| Key First Part | Specify the first part of the key. The length of the key must be in sixteen hexadecimal characters. |
| Key Second Part | Specify the second part of the key. The length of the key must also be in sixteen hexadecimal characters. |

- Click **Exit** to end the transaction.

1.6.2 Process SWIFT LAU Key Summary

This topic explains systematic instructions to process SWIFT LAU key maintenance details.

Note

The fields which are marked in asterisk are mandatory.

- On **Homescreen**, type **MSSLAUMN** in the text box, and click **Next**.
The **SWIFT LAU Key Summary** screen displays.

Figure 1-10 SWIFT LAU Key Summary

- On the **SWIFT LAU Key Summary** screen, specify the fields.
For more information on fields, refer to the field description table.

Table 1-12 SWIFT LAU Key Summary - Field Description

| Field | Description |
|-----------------------------|--|
| Authorization Status | Select the authorization status from the drop-down list: <ul style="list-style-type: none"> Authorized Unauthorized Rejected |

Table 1-12 (Cont.) SWIFT LAU Key Summary - Field Description

| Field | Description |
|--------------------------|--|
| Record Status | Select the record status from the drop-down list: <ul style="list-style-type: none"> • Open • Closed |
| Host Code | Click Search and specify the Host Code from the list of values. |
| Message Direction | Select the message direction from the drop-down list: <ul style="list-style-type: none"> • Incoming • Outgoing |

3. Click **Search** after specifying the search parameters.

The system identifies all records satisfying the specified criteria and displays the following details for each one of them:

- **Authorization Status**
- **Record Status**
- **Host Code**
- **Message Direction**
- **SWIFT LAU Required**
- **Key First Part**
- **Key Second Part**

4. Click **Exit** to end the transaction.

1.6.3 Process Outgoing SWIFT LAU

This topic describes the flowchart of the outgoing message SWIFT LAU.

Figure 1-11 Outgoing SWIFT LAU

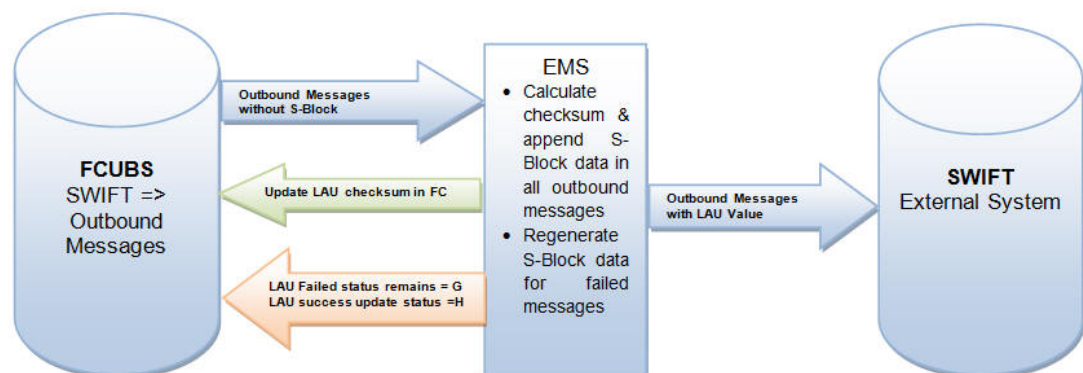

The outbound message workflow is explained below:

- Oracle Banking Corporate Lending generates the S-Block for all outbound SWIFT messages with the message status as **Generated**.

- **Common Core - Electronic Messaging Service User Guide** refers to SWIFT LAU parameters in Oracle Banking Corporate Lending **SWIFT LAU Key Maintenance** screen and applies HMAC-SHA256 algorithm to generate the checksum in S-Block for all outbound messages from Oracle Banking Corporate Lending.
- For all outbound messages, Electronic Messaging Service generated checksum is appended in the S-block of the message, and the same is updated in the **SWIFT LAU** field of the **Outgoing Message Browser** screen.
- Successful generation of S-Block data and message hand-off to the folder will update the message status to **Handoff**. If there is a failure in appending the S-Block data in the message, Electronic Messaging Service will not update the message status to **Handoff** in the **Outgoing Message Browser** screen.
- The next handoff job of Electronic Messaging Service picks up the messages with the status **Generated** regenerates S-Block data, appends the same in the message and updates the message status to **Handoff** in **Outgoing Message Browser** screen.

1.6.4 Process Incoming SWIFT LAU

This topic describes the flowchart of the incoming message SWIFT LAU.

Figure 1-12 Incoming SWIFT LAU

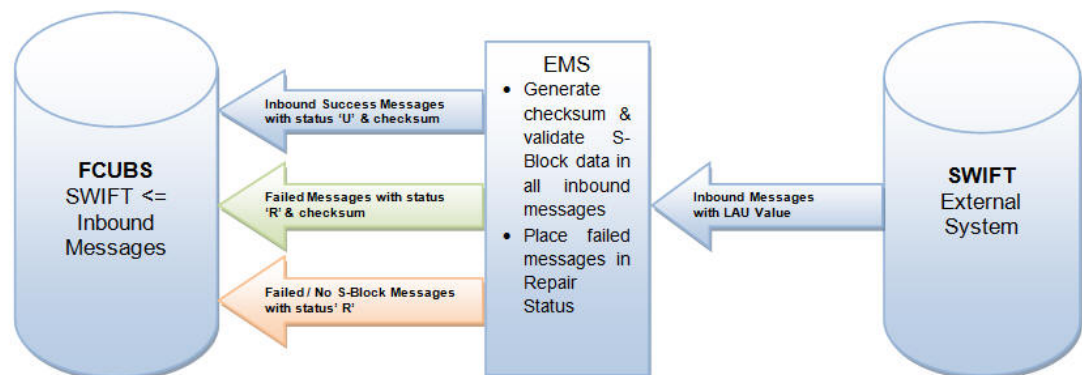

The Inbound message workflow is explained below:

- The user can validate inbound messages with the S-Block data. The checksum value is regenerated in Electronic Messaging Service, based on SWIFT LAU parameters and the HMAC-SHA256 algorithm.
- The regenerated checksum is compared with the checksum present in the received message, and further processing is carried out in Oracle Banking Corporate Lending based on data verification.
- LAU checksum-validated messages are uploaded into the **Incoming Message Browser** screen with the status **Unprocessed**, for Oracle Banking Corporate Lending to create relevant contracts.
- The encrypted S-Block checksum values in the received messages are updated in the **SWIFT LAU** field and the checksum generated by Electronic Messaging Service for all incoming messages are updated in the **LAU Validation** field of the **Incoming Message Browser** screen.

- Messages that have failed in LAU checksum validation are uploaded into the incoming message browser with the status **Repair**.
- Messages with the status **Repair** in the incoming message browser will hold differences in checksum data present in **SWIFT LAU** and **LAU Validation** fields.
- Incoming messages without S-Block are uploaded in the incoming browser with the status **Repair**, and data is not updated in the **SWIFT LAU** field while the Electronic Messaging Service generated checksum is updated in the **LAU VALIDATION** field.

1.7 Mapping Rule Group

This topic provides an overview of the Mapping Rule Group.

This topic contains the following sub-topics:

- [Maintain Rule Group Mapping](#)
This topic explains systematic instructions to maintain the mapping of Rule Groups.
- [Process Rule Group Mapping Summary](#)
This topic explains systematic instructions to process the rule group mapping summary screen.

1.7.1 Maintain Rule Group Mapping

This topic explains systematic instructions to maintain the mapping of Rule Groups.

Note

The fields which are marked in asterisk are mandatory.

1. On **Homescreen**, type **MSDRLMAP** in the text box, and click **Next**.
The **Rule Group Mapping** screen displays.

Figure 1-13 Rule Group Mapping

The screenshot shows a web application interface for 'Rule Group Mapping'. At the top left, there are two buttons: 'New' and 'Enter Query'. Below these are two input fields: 'Module Identification *' and 'Rule Group Name *', each with a search icon. The background of the main area has a repeating pattern of the letters 'M' and 'R'. At the bottom right, there are two buttons: 'Audit' and 'Exit'.

2. On the **Rule Group Mapping** screen, specify the fields.

Table 1-13 Rule Group Mapping - Field Description

| Field | Description |
|------------------------------|---|
| Module Identification | Click Search and specify the module that needs to be mapped to the created rule group. |
| Rule Group Name | Click Search and specify the unique name of the rule group. |

3. Click **Exit** to end the transaction.

1.7.2 Process Rule Group Mapping Summary

This topic explains systematic instructions to process the rule group mapping summary screen.

Note

The fields which are marked in asterisk are mandatory.

1. On **Homescreen**, specify **MSSRLMAP** in the text box, and click **Next**.

The **Rule Group Mapping Summary** screen displays.

Figure 1-14 Rule Group Mapping Summary

2. On the **Rule Group Mapping Summary** screen, specify the fields.

For more information on fields, refer to the field description table.

Table 1-14 Rule Group Mapping Summary - Field Description

| Field | Description |
|------------------------------|--|
| Authorization Status | Select the authorization status from the drop-down list. <ul style="list-style-type: none"> • Authorized • Unauthorized • Rejected |
| Record Status | Select the record status from the drop-down list. <ul style="list-style-type: none"> • Open • Closed |
| Module Identification | Click Search and specify the module ID from the list of values. |

3. Click **Search** after specifying the search parameters.

The system identifies all records satisfying the specified criteria and displays the following details for each one of them:

- **Authorization Status**
- **Record Status**
- **Module Identification**
- **Rule Group Name**

4. Click **Exit** to end the transaction.

1.8 Define Rule Group

This topic provides an overview of the Rule Group Definition.

This topic contains the following sub-topics:

- [Maintain Rule Group Definition](#)
This topic explains systematic instructions to maintain the Rule Group definition.
- [Process Rule Group Definition Summary](#)
This topic explains systematic instructions to process the rule group definition summary.

1.8.1 Maintain Rule Group Definition

This topic explains systematic instructions to maintain the Rule Group definition.

Note

The fields which are marked in asterisk are mandatory.

1. On **Homescreen**, type **MSDRLGRP** in the text box, and click **Next**.
The **Rule Group Definition** screen displays.

Figure 1-15 Rule Group Definition

2. On the **Rule Group Definition** screen, specify the fields.
For more information on fields, refer to the field description table.

Table 1-15 Rule Group Definition - Field Description

| Field | Description |
|-------------------------|--|
| Rule Group Name | Specify the unique rule group name. |
| Description | Type a description of the rule group. |
| Rule Name | Click Search and specify the rule name from the list of values. |
| Rule Description | Type a RULE DESCRIPTION . |
| Priority | Specify the PRIORITY . |
| Move to/Swap to | Specify whether the priority must be swapped or moved. |
| Move | Click Move to move the priority record. |
| Swap | Click Swap to swap the priority record. |

- Click **Exit** to end the transaction.

1.8.2 Process Rule Group Definition Summary

This topic explains systematic instructions to process the rule group definition summary.

Note

The fields which are marked in asterisk are mandatory.

- On **Homescreen**, type **MSSRLGRP** in the text box, and click **Next**.
The **Rule Group Definition Summary** screen displays.

Figure 1-16 Rule Group Definition Summary

- On the **Rule Group Definition Summary** screen, specify the fields.
For more information on fields, refer to the field description table.

Table 1-16 Rule Group Definition Summary - Field Description

| Field | Description |
|-----------------------------|--|
| Authorization Status | Select the authorization status from the drop-down list: <ul style="list-style-type: none"> • Authorized • Unauthorized • Rejected |
| Record Status | Select the record status from the drop-down list: <ul style="list-style-type: none"> • Open • Closed |
| Rule Group Name | Click Search and specify the name of the rule group from the list of values. |

3. Click **Search** after specifying the search parameters.

The system identifies all records satisfying the specified criteria and displays the following details for each one of them:

- **Authorization Status**
- **Record Status**
- **Rule Group Name**
- **Description**

4. Click **Exit** to end the transaction.

1.9 Define Routing Rule

This topic provides an overview of the Routing Group Definition.

This topic contains the following sub-topics:

- [Maintain Routing Rule Definition](#)
This topic explains systematic instructions to maintain the Routing Rule definition.
- [Process Routing Rule Definition Summary](#)
This topic explains systematic instructions to process the routing rule definition summary.

1.9.1 Maintain Routing Rule Definition

This topic explains systematic instructions to maintain the Routing Rule definition.

1. On **Homescreen**, type **MSDRLDFN** in the text box, and click **Next**.
The **Routing Rule Definition** screen displays.

Figure 1-17 Routing Rule Definition

2. On the **Routing Rule Definition** screen, specify the fields.

Note

The fields, which are marked with an asterisk, are mandatory.

For more information on fields, refer to the field description table.

Table 1-17 Routing Rule Definition - Field Description

| Field | Description |
|------------------------------|--|
| Rule Name | Specify the Rule Name . |
| Rule Description | Type a description of the selected Rule Name . |
| Destination Type | Specify the type of destination to which the messages matching the rule criteria are being sent from the drop-down list: <ul style="list-style-type: none"> • SWIFT Net Connectivity • Bulker • Folder • Queue |
| Folder Path | Specify the path of the folder if the Destination Type is selected as a Folder . |
| Queue JNDI Name | Specify the JNDI name of the queue. This field is mandatory if the Destination Type is selected as a Queue . |
| Protocol Type | Specify the type of protocol from the drop-down list: <ul style="list-style-type: none"> • FTA • MQHA This field is mandatory if the Destination Type is selected as a SWIFT Net Connectivity . |
| Protocol Name | Click Search and specify the required protocol name for the selected protocol. |
| SWIFTNet Connectivity | Click Search and specify the name of the connector if the Destination Type is selected as a SWIFT Net Connectivity . |
| Bulk Rule Name | Click Search and specify the Bulk Rule Name from the list of values. |
| Expression Section | Specify the Expression Section . |
| Scope | Specify the Scope . |

Table 1-17 (Cont.) Routing Rule Definition - Field Description

| Field | Description |
|--|--|
| Left Operand Type (LOP Type) | Select the type of the left operand from the drop-down list: <ul style="list-style-type: none"> • Constant • Parameter • Expression |
| Left Operand Data Type (LOP Data Type) | Select the LOP data type from the drop-down list: <ul style="list-style-type: none"> • String • Date • Boolean • Number |
| Left Operand | Click Search and specify the left operand from the list of values. |
| Operator | Select the operator from the drop-down list: <ul style="list-style-type: none"> • Greater Than • Less Than • Equal to • Not Equal to • Greater Than or Equal to • Less Than or Equal to |
| Right Operand Type (ROP Type) | Select the type of the right operand from the drop-down list: <ul style="list-style-type: none"> • Constant • Parameter • Expression |
| Right Operand Data Type (ROP Data Type) | Select the ROP data type from the drop-down list: <ul style="list-style-type: none"> • String • Date • Boolean • Number |
| Right Operand | Click Search and specify the right operand from the list of values. |
| Scope | Specify the Scope . |
| Logical Operators | Select the logical operators from the drop-down list: <ul style="list-style-type: none"> • AND • OR |
| Pre Defined Functions | Select the predefined functions from the drop-down list: <ul style="list-style-type: none"> • Index Of • Substring • Length • Replace • Uppercase • Lowercase • Trim • Replace all |
| Parameter Name | Specify the Parameter Name . |
| Parameter Value | Specify the Parameter Value . |
| Parameter Type | Specify the Parameter Type . |
| Expression For | Select the expression for from the drop-down list: <ul style="list-style-type: none"> • Right Operand • Left Operand |
| Final Expression | Specify the Final Expression . |
| Build Expression | Click Build Expression to build the expression. |

3. Click **Exit** to end the transaction.

1.9.2 Process Routing Rule Definition Summary

This topic explains systematic instructions to process the routing rule definition summary.

Note

The fields which are marked in asterisk are mandatory.

1. On **Homescreen**, type **MSSRLDFN** in the text box, and click **Next**.
The **Routing Rule Definition Summary** screen displays.

Figure 1-18 Routing Rule Definition Summary

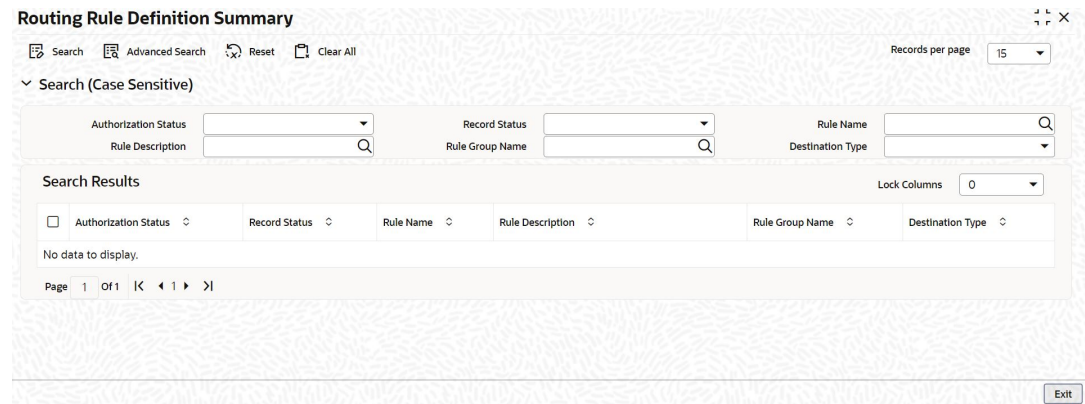

2. On the **Routing Rule Definition Summary** screen, specify the fields.
For more information on fields, refer to the field description table.

Table 1-18 Routing Rule Definition Summary - Field Description

| Field | Description |
|-----------------------------|--|
| Authorization Status | Select the authorization status from the drop-down list: <ul style="list-style-type: none"> • Authorized • Unauthorized • Rejected |
| Record Status | Select the record status from the drop-down list: <ul style="list-style-type: none"> • Open • Closed |
| Rule Name | Click Search and specify the Rule Name from the list of values. |
| Rule Description | Click Search and specify the Rule Description from the list of values. |
| Rule Group Name | Click Search and specify the Rule Group Name from the list of values. |

Table 1-18 (Cont.) Routing Rule Definition Summary - Field Description

| Field | Description |
|-------------------------|--|
| Destination Type | Select the destination type from the drop-down list: <ul style="list-style-type: none"> • Folder • Queue • Swift Net Connectivity • Bulker |

3. Click **Search** after specifying the search parameters.

The system identifies all records satisfying the specified criteria and displays the following details for each one of them:

- **Authorization Status**
- **Record Status**
- **Rule Name**
- **Rule Description**
- **Rule Group Name**
- **Destination Type**

4. Click **Exit** to end the transaction.

1.10 Define Protocol Parameter

This topic provides an overview of the Protocol Parameter Definition.

This topic contains the following sub-topics:

- [Maintain Protocol Parameter Definition](#)
This topic explains systematic instructions to maintain the protocol parameter definition.
- [Process Protocol Parameter Definition Summary](#)
This topic explains systematic instructions to process protocol parameter definition summary.

1.10.1 Maintain Protocol Parameter Definition

This topic explains systematic instructions to maintain the protocol parameter definition.

Note

The fields which are marked in asterisk are mandatory.

1. On **Homescreen**, type **MSDPTPRM** in the text box, and click **Next**.
The **Protocol Parameter Definition** screen displays.

Figure 1-19 Protocol Parameter Definition

2. On the **Protocol Parameter Definition** screen, specify the fields.
For more information on fields, refer to the field description table.

Table 1-19 Protocol Parameter Definition - Field Description

| Field | Description |
|--------------------------------|---|
| Protocol Parameter Name | Specify the name of the protocol for which the parameter list is defined. |
| Description | Specify the description of the protocol parameter. |
| Protocol Type Mode | Select the mode of the protocol type from the drop-down list: <ul style="list-style-type: none"> • FTA • MQHA |
| Parameters | Specify the parameters for the protocol. |
| Value | Specify the value of the parameter. |

3. Click **Exit** to end the transaction.

1.10.2 Process Protocol Parameter Definition Summary

This topic explains systematic instructions to process protocol parameter definition summary.

Note

The fields which are marked in asterisk are mandatory.

1. On **Homescreen**, type **MSSPTPRM** in the text box, and click **Next**.
The **Protocol Parameter Definition Summary** screen displays.

Figure 1-20 Protocol Parameter Definition Summary

The screenshot shows the 'Protocol Parameter Definition Summary' window. At the top, there are search options: 'Search', 'Advanced Search', 'Reset', and 'Clear All'. A 'Records per page' dropdown is set to 15. Below this is a 'Search (Case Sensitive)' section with three dropdown menus: 'Authorization Status', 'Record Status', and 'Protocol Parameter Name'. A search icon is to the right of the last dropdown. Underneath is a 'Search Results' section with a 'Lock Columns' dropdown set to 0. A table header lists columns: 'Authorization Status', 'Record Status', 'Protocol Parameter Name', 'Description', and 'Protocol Type'. The table body contains the text 'No data to display.' At the bottom left, there is a pagination bar showing 'Page 1 of 1' and navigation arrows. An 'Exit' button is located at the bottom right of the window.

2. On the **Protocol Parameter Definition Summary** screen, specify the fields.
For more information on fields, refer to the field description table.

Table 1-20 Protocol Parameter Definition Summary - Field Description

| Field | Description |
|--------------------------------|--|
| Authorization Status | Select the authorization status from the drop-down list: <ul style="list-style-type: none"> • Authorized • Unauthorized • Rejected |
| Record Status | Select the record status from the drop-down list: <ul style="list-style-type: none"> • Open • Closed |
| Protocol Parameter Name | Click Search and select the name of the protocol parameter from the list of values. |

3. Click **Search** after specifying the search parameters.
The system identifies all records satisfying the specified criteria and displays the following details for each one of them:
 - **Authorization Status**
 - **Record Status**
 - **Protocol Parameter Name**
 - **Description**
 - **Protocol Type**
4. Click **Exit** to end the transaction.

1.11 File Transfer Adapter Connector Configuration

This topic provides an overview of the file transfer adapter connector configuration.

Create below folder structure for the Swift Net connectivity:

1. Create an application base directory as per the path mentioned in the `mstm_ems_system_parameters (APP_BASE_DIR)`.
2. Create below folder structure in the application base directory:

- **payload\EMS_OUT**
 - **XSL**
3. In the XSL folder, copy all the XSL required for message transformation

This topic contains the following sub-topics:

- [Maintain File Transfer Adapter Connector Configuration](#)
This topic explains systematic instructions to maintain the **File Transfer Adapter Connector Configuration** screen.
- [Process SWIFTNet FTA Connector Definition Summary](#)
This topic explains systematic instructions to process the SWIFTNet FTA connector definition summary.

1.11.1 Maintain File Transfer Adapter Connector Configuration

This topic explains systematic instructions to maintain the **File Transfer Adapter Connector Configuration** screen.

Note

The fields which are marked in asterisk are mandatory.

1. On **Homescreen**, type **MSDFTACN** in the text box, and click **Next**.
The **File Transfer Adapter Connector Configuration** screen displays.

Figure 1-21 File Transfer Adapter Connector Configuration

2. On the **File Transfer Adapter Connector Configuration** screen, specify the fields.
For more information on fields, refer to the field description table.

Table 1-21 File Transfer Adapter Connector Configuration - Field Description

| Field | Description |
|---------------------------|---|
| FTA Connector Name | Specify the FTA Connector Name . |

Table 1-21 (Cont.) File Transfer Adapter Connector Configuration - Field Description

| Field | Description |
|-----------------------------|---|
| Operation Type | Select the type of operation from the drop-down list: <ul style="list-style-type: none"> Inbound Outbound |
| Node | Specify the Node . This is mandatory for the Inbound operation type. |
| Media | Specify the Media . This is mandatory for the Inbound operation type. |
| Media Control System | Specify the Media Control System . This is mandatory for the Inbound operation type. |
| Host Code | Specify the Host Code . |
| File Directory | Specify store details of the emission directory for outbound connectivity and the reception directory for inbound flow. |
| Success Directory | For outbound connectivity, delivery notification responses related to file transfer status from the SAG are placed in this directory. For inbound connectivity file transfer, success status files are placed in this folder. |
| Log Directory | Specify the responses from SAG. |
| Parameter File | Switch this toggle if FCM creates or receives a parameter file corresponding to every data file in configured file directory along with the data file. |
| Data file LAU | Switch this toggle if FCM calculates the LAU of the data file and puts the calculated value in the parameter file. |
| Companion LAU | Switch this toggle if parameters defined at the emission profile of the SAG side are overridden by information in the companion file. |
| Override | Switch this toggle if parameters defined at the emission profile of the SAG side will be overridden by information in the companion file. |
| Debulk Required | Switch this toggle, if debulk is required for inbound messages. |
| Debulk Rule Name | Specify the Debulk Rule Name . |

- Click **Exit** to end the transaction.

1.11.2 Process SWIFTNet FTA Connector Definition Summary

This topic explains systematic instructions to process the SWIFTNet FTA connector definition summary.

Note

The fields which are marked in asterisk are mandatory.

- On **Homescreen**, type **MSSFTACN** in the text box, and click **Next**.
The **SWIFTNet FTA Connector Definition Summary** screen displays.

Figure 1-22 SWIFTNet FTA Connector Definition Summary

2. On the **SWIFTNet FTA Connector Definition Summary** screen, specify the fields. For more information on fields, refer to the field description table.

Table 1-22 SWIFTNet FTA Connector Definition Summary - Field Description

| Field | Description |
|-----------------------------|---|
| Authorization Status | Select the status of the authorization from the drop-down list: <ul style="list-style-type: none"> • Authorized • Unauthorized • Rejected |
| Record Status | Select the record status from the drop-down list: <ul style="list-style-type: none"> • Open • Closed |
| FTA Connector Name | Click Search and specify the FTA Connector Name from the list of values. |
| Operation Type | Select the operation type from the drop-down list: <ul style="list-style-type: none"> • Inbound • Outbound |

3. Click **Search** after specifying the search parameters.
The system identifies all records satisfying the specified criteria and displays the following details for each one of them:
 - **FTA Connector Name**
 - **Operation Type**
 - **Authorization Status**
 - **Record Status**
4. Click **Exit** to end the transaction.

1.12 Distinguished Name Definition

This topic provides an overview of the Distinguished Name Definition.

This topic contains the following sub-topics:

- [Maintain Distinguished Name Definition](#)
This topic explains systematic instructions to process the distinguished name definition.

- [Process Distinguished Name Definition Summary](#)
This topic explains systematic instructions to process the summary of distinguished name definitions.

1.12.1 Maintain Distinguished Name Definition

This topic explains systematic instructions to process the distinguished name definition.

Note

The fields which are marked in asterisk are mandatory.

1. On **Homescreen**, type **MSDDSTNM** in the text box, and click **Next**.
The **Distinguished Name Definition** screen displays.

Figure 1-23 Distinguished Name Definition

2. On **Distinguished Name Definition** screen, specify the fields.
For more information on fields, refer to the field description table.

Table 1-23 Distinguished Name Definition - Field Description

| Field | Description |
|------------------------------|--|
| Distinguished Name ID | Specify the unique identification of the distinguished name. |
| Distinguished Name | Specify the distinguished name to identify the entity that sends or gets messages. |
| Description | Specify the description of the distinguished name. |

3. Click **Exit** to end the transaction.

1.12.2 Process Distinguished Name Definition Summary

This topic explains systematic instructions to process the summary of distinguished name definitions.

Note

The fields which are marked in asterisk are mandatory.

1. On **Homescreen**, type **MSSDSTNM** in the text box, and click **Next**.
The **Distinguished Name Definition Summary** screen displays.

Figure 1-24 Distinguished Name Definition Summary

2. On the **Distinguished Name Definition Summary** screen, specify the fields.
For more information on fields, refer to the field description table.

Table 1-24 Distinguished Name Definition Summary - Field Description

| Field | Description |
|------------------------------|--|
| Distinguished Name ID | Click Search and specify the unique identification of the distinguished name. |
| Distinguished Name | Click Search and specify the distinguished name to identify the entity that sends or gets messages. |
| Authorization Status | Select the authorization status from the drop-down list: <ul style="list-style-type: none"> • Authorized • Unauthorized • Rejected |
| Record Status | Select the record status from the drop-down list: <ul style="list-style-type: none"> • Open • Closed |

3. Click **Search** after specifying the search parameters.

The system identifies all records satisfying the specified criteria and displays the following details for each one of them:

- **Distinguished Name ID**
 - **Distinguished Name**
 - **Description**
 - **Authorization Status**
 - **Record Status**
4. Click **Exit** to end the transaction.

1.13 Define Debulk Rule

This topic provides an overview of the Debulk Rule Definition.

This topic contains the following sub-topics:

- [Maintain De Bulk Rule Definition](#)
This topic explains systematic instructions to maintain the De Bulk rule definition.
- [Process Debulk Rule Summary](#)
This topic explains systematic instructions to process the summary of debulk rule.

1.13.1 Maintain De Bulk Rule Definition

This topic explains systematic instructions to maintain the De Bulk rule definition.

① Note

The fields which are marked in asterisk are mandatory.

1. On **Homescreen**, type **MSDDEBRL** in the text box, and click **Next**.
The **De Bulk Rule Definition** screen displays.

Figure 1-25 De Bulk Rule Definition

2. On the **De Bulk Rule Definition** screen, specify the fields.
For more information on fields, refer to the field description table.

Table 1-25 De Bulk Rule Definition - Field Description

| Field | Description |
|-------------------------------|---|
| Debulk Rule Name | Specify the name of the debulk file. |
| Payload Delimiter | Specify the delimiter between payloads. |
| Protocol | Select the type of protocol from the drop-down list: <ul style="list-style-type: none"> • MQHA • FTA |
| Decompression Required | Switch this toggle if debulk processing requires decompression. |
| Description | The system displays the description of the Debulk rule. |
| Decompression Type | Select the type of decompression from the drop-down list: <ul style="list-style-type: none"> • Zip • GZIP |

3. Click **Exit** to end the transaction.

1.13.2 Process Debulk Rule Summary

This topic explains systematic instructions to process the summary of debulk rule.

Note

The fields which are marked in asterisk are mandatory.

1. On **Homescreen**, type **MSSDEBRL** in the text box, and click **Next**.
The **Debulk Rule Definition Summary** screen displays.

Figure 1-26 Debulk Rule Definition Summary

2. On **Debulk Rule Definition Summary** screen, specify the details.
For more information on fields, refer to the field description table.

Table 1-26 Debulk Rule Definition Summary - Field Description

| Field | Description |
|-----------------------------|--|
| Authorization Status | Select the authorization status from the drop-down list: <ul style="list-style-type: none"> • Authorized • Unauthorized • Rejected |
| Record Status | Select the record status from the drop-down list: <ul style="list-style-type: none"> • Open • Closed |
| Debulk Rule Name | Click Search and specify the Debulk Rule Name from the list of values. |
| Protocol | Select the protocol from the drop-down list: <ul style="list-style-type: none"> • MQHA • FTA |

3. Click **Search** after specifying the search parameters.

The system identifies all records satisfying the specified criteria and displays the following details for each one of them:

- **Authorization Status**
- **Record Status**
- **Debulk Rule Name**
- **Payload Delimiter**
- **Protocol**

4. Click **Exit** to end the transaction.

1.14 Connectivity Operation Manager

This topic provides an overview of the Connectivity Operation Manager.

This topic contains the following sub-topics:

- [Maintain Connectivity Operation Manager](#)
This topic explains systematic instructions to maintain the connectivity operation manager.

1.14.1 Maintain Connectivity Operation Manager

This topic explains systematic instructions to maintain the connectivity operation manager.

Note

The fields which are marked in asterisk are mandatory.

1. On **Homescreen**, type **MSDCNMGR** in the text box, and click **Next**.
The **Connectivity Operation Manager** screen displays.

Figure 1-27 Connectivity Operation Manager

2. On the **Connectivity Operation Manager** screen, specify the fields.
For more information on fields, refer to the field description table.

Table 1-27 Connectivity Operation Manager - Field Description

| Field | Description |
|--------------------------|---|
| Connectivity Line | Click Search and specify the required connectivity line. |
| Operation Type | Select the type of operation from the drop-down list: <ul style="list-style-type: none"> • Inbound • Outbound |
| Status | The system displays the display line status. |
| Operation | The system displays the operation. |
| Start | Click Start to start the connectivity line. |
| Stop | Click Stop to stop the connectivity line. |

3. Click **Exit** to end the transaction.

1.15 Process Outbound File Browser

This topic explains systematic instructions to search and view the outbound files.

Note

The fields which are marked in asterisk are mandatory.

1. On **Homescreen**, type **MSSFLBRW** in the text box, and click **Next**.
The **Outbound File Browser** screen displays.

Figure 1-28 Outbound File Browser

- On the **Outbound File Browser** screen, specify the fields.
For more information on fields, refer to the field description table.

Table 1-28 Outbound File Browser - Field Description

| Field | Description |
|------------------------------|---|
| File Reference Number | Click Search and specify the File Reference Number from the list of values. |
| File Type | Click Search and specify the File Type from the list of values. |
| Generated Date | Click Search and specify the Generated Date from the list of values. |
| Handoff Status | Click Search and specify the Handoff Status from the list of values. |
| File Status | Click Search and specify the File Status from the list of values. |
| Media | Click Search and specify the Media from the list of values. |
| Network Code | Click Search and specify the Network Code from the list of values. |
| Module | Click Search and specify the Module from the list of values. |

- Click **Search** after specifying the search parameters.
The system identifies all records satisfying the specified criteria and displays the following details for each one of them:

- File Reference Number**
- File Type**
- Generated Date**
- Handoff Status**
- Receiver BIC**
- Sender BIC**
- File Format Type**
- File Status**
- Media**
- Network Code**
- File Name**
- Source Code**

- **Module**
 - **External Reference**
4. Select the record and click **View** to view details.
 5. Click **Exit** to end the transaction.

1.16 Process Inbound File Browser

This topic explains systematic instructions to process the summary of the inbound file browser.

Note

The fields which are marked in asterisk are mandatory.

1. On **Homescreen**, type **MSSIFBRW** in the text box, and click **Next**.
The **Inbound File Browser Summary** screen displays.

Figure 1-29 Inbound File Browser Summary

2. On the **Inbound File Browser Summary** screen, specify the fields.
For more information on fields, refer to the field description table.

Table 1-29 Inbound File Browser Summary - Field Description

| Field | Description |
|---------------------------------|--|
| File Reference Number | Click Search and specify the File Reference Number from the list of values. |
| Received Date | Click Calendar and select the Received Date . |
| Source Code | Click Search and specify the Source Code from the list of values. |
| File Name | Click Search and specify the File Name from the list of values. |
| Host Code | Click Search and specify the Host Code from the list of values. |
| Status | Click Search and specify the Status from the list of values. |
| Media | Click Search and specify the Media from the list of values. |
| Swift Net Connector Name | Click Search and specify the Swift Net Connector Name from the list of values. |

3. Click **Search** after specifying the search parameters.

The system identifies all records satisfying the specified criteria and displays the following details for each one of them:

- **File Reference Number**
- **Host Code**
- **File Format Type**
- **Received Date**
- **Network Code**
- **Status**
- **Source Code**
- **Media**
- **File Name**
- **Swift Net Connector Name**
- **External Reference**
- **Error Code**
- **Error Description**
- **Error Message**
- **Receiver BIC**
- **Sender BIC**

4. Click **Exit** to end the transaction.

1.17 Define Bulk Preference

This topic provides an overview of the Bulk Preference Definition.

This topic contains the following sub-topics:

- [Maintain Bulking Preference Definition](#)
This topic explains systematic instructions to maintain the bulking preference definition.
- [Process Bulking Preference Definition Summary](#)
This topic explains systematic instructions to process bulking preference definition summary.

1.17.1 Maintain Bulking Preference Definition

This topic explains systematic instructions to maintain the bulking preference definition.

Note

The fields which are marked in asterisk are mandatory.

1. On **Homescreen**, type **MSDBLKRL** in the text box, and click **Next**.
The **Bulking Preference Definition** screen displays.

Figure 1-30 Bulking Preference Definition

2. On the **Bulking Preference Definition** screen, specify the fields.

Note

The fields, which are marked with an asterisk, are mandatory.

For more information on fields, refer to the field description table.

Table 1-30 Bulking Preference Definition - Field Description

| Field | Description |
|-------------------------------------|--|
| Bulking Preference Name | Specify the name used for storing the bulk preference. |
| Volume Restriction Required? | Switch this toggle to configure volume based bulking. |
| Maximum number of messages | Specify the maximum number of messages that can be stored in a bulk file. |
| Size Restriction Required? | Switch this toggle to configure size based bulking. |
| Size (In KB) | Specify the size in KB. |
| Scheduler Type | Select the type of scheduler from the following options: <ul style="list-style-type: none"> • Time Based • Frequency |
| Scheduling Number | Specify the scheduling sequence. |
| Start Hour | Specify the start hour of the scheduling sequence. |
| Start Minute | Specify the start minute for frequency based scheduler. |
| Start Time (HH:MM) | Specify the start time of the trigger. Enter the format in HH:MM format. |
| End Time (HH:MM) | Specify the end time of the trigger. Enter the format in HH:MM format. |
| Time Interval in Min | Specify the interval of the repeat in MM format. |

Table 1-30 (Cont.) Bulking Preference Definition - Field Description

| Field | Description |
|--|--|
| Bulk File Name Prefix | Specify the prefix to indicate the name of the bulk file. |
| Maximum size of Bulk File (In KB) | Specify the maximum size of a bulk file in KB. |
| Payload Delimiter | Specify the delimiter while bulking messages. |
| File Extension | Select the file format that must be used while bulking messages. |
| Compression Required | Switch this toggle to indicate that file compression is required. |
| Compression Type | Specify the required type of compression from the drop-down list: <ul style="list-style-type: none"> • Zip • GZip |
| Destination Type | Specify the type of destination from the drop-down list: <ul style="list-style-type: none"> • Folder • Queue • SwiftNet Connectivity If the Destination Type is SwiftNet Connectivity , then a field SwiftNet Connectivity needs to be selected from list of values which gives the list of connectivity lines. |
| Folder Path | Specify the user defined destination folder path. |
| Queue JNDI Name | Specify the JNDI name of the queue if the Destination Type is selected as Queue . |
| Protocol Type | Select the type of protocol from the drop-down list: <ul style="list-style-type: none"> • FTA • MQHA |
| Swift Net Connectivity | Select the Swift Net connectivity from the list of values. |
| Protocol Name | Specify the protocol name for the selected protocol. |

3. Click **Exit** to end the transaction.

1.17.2 Process Bulking Preference Definition Summary

This topic explains systematic instructions to process bulking preference definition summary.

Note

The fields which are marked in asterisk are mandatory.

1. On **Homescreen**, type **MSSBLKRL** in the text box, and click **Next**.
The **Bulking Preference Definition Summary** screen displays.

Figure 1-31 Bulking Preference Definition Summary

- On the **Bulking Preference Definition Summary** screen, specify the fields.
For more information on fields, refer to the field description table.

Table 1-31 Bulking Preference Definition Summary - Field Description

| Field | Description |
|--------------------------------|--|
| Authorization Status | Select the authorization status from the drop-down list: <ul style="list-style-type: none"> Authorized Unauthorized Rejected |
| Record Status | Select the record status from the drop-down list: <ul style="list-style-type: none"> Open Closed |
| Bulking Preference Name | Click Search and specify the name used for storing the bulk preference. |
| Bulk Initiated | Select Yes/No from the drop-down list to configure volume based bulking. |

- Click **Search** after specifying the search parameters.
The system identifies all records satisfying the specified criteria and displays the following details for each one of them:
 - Authorization Status**
 - Record Status**
 - Bulking Preference Name**
 - Max Number of Messages**
 - Size in (in KB)**
 - Bulk File Name Prefix**
 - Maximum Size of Bulk File (in KB)**
 - Bulk Initiated**
- Click **Exit** to end the transaction.

1.18 Process Bulk Monitor Summary

This topic explains systematic instructions to process the summary of messages and executions in bulk.

1. On **Homescreen**, type **MSSBLKMN** in the text box, and click **Next**.

The **Bulk Monitor Summary** screen displays.

Figure 1-32 Bulk Monitor Summary

2. On the **Bulk Monitor Summary** screen, specify the fields.

Note

The fields, which are marked with an asterisk, are mandatory.

For more information on fields, refer to the field description table.

Table 1-32 Bulk Monitor Summary - Field Description

| Field | Description |
|----------------------------------|--|
| Execution Start Date | Click Calendar and select the Execution Start Date . |
| Number of Files Generated | Click Search and specify the Number of Files Generated . |
| Status | Click Search and specify the Status . |
| Bulk Preference Name | Click Search and specify the Bulk Preference Name . |
| Execution End Date | Click Calendar and select the Execution End Date . |
| Process Reference Number | Click Search and specify the Process Reference Number . |

3. Click **Execute Query** after specifying the search parameters.

The system identifies all records satisfying the specified criteria and displays the following details for each one of them:

- **Execution Start Date**
- **Execution Start Time**

- **Number of Files Generated**
 - **Status**
 - **Bulk Preference Name**
 - **Execution End Date**
 - **Execution End Time**
 - **Process Reference Number**
 - **Number of Transactions**
 - **Total Size**
 - **Error Code**
 - **Error Parameter**
 - **Error Description**
4. Double-click a record from the results to view the details of each record in the results. The **Bulk Monitor** screen displays.

Figure 1-33 Bulk Monitor

The screenshot shows the 'Bulk Monitor' application window. It has a title bar with 'Bulk Monitor' and standard window controls. Below the title bar is a search bar with the placeholder text 'Enter Query'. The main area contains a list of input fields for the following fields: Process Reference Number, Execution Start Date, Execution Start Time, Execution End Date, Execution End Time, Status, Bulk Preference Name, No Of Files Generated, Error Code, Error Parameter, and Error Description. At the bottom of the form are three buttons: 'Regenerate', 'Initiate Adhoc Bulking', and 'Exit'.

5. Click **Regenerate** to regenerate the files due to any error in the file generation. The records get generated again.
6. Click **Initiate Adhoc Bulking** to bulk a selected bulk preference ad-hoc.
7. Click **Exit** to end the transaction.

Index

M

- MSDBLKMN - Bulk Monitor screen, [45](#)
- MSDBLKRL - Bulking Preference Definition screen, [41](#)
- MSDCNMGR - Connectivity Operation Manager screen, [37](#)
- MSDDEBRL - De Bulk Rule Definition screen, [35](#)
- MSDDSTNM - Distinguished Name Definition screen, [33](#)
- MSDFTACN - File Transfer Adapter Connector Configuration screen, [30](#)
- MSDLAUMN - SWIFT LAU Key Maintenance screen, [15](#)
- MSDMGMCS - Message Media Control Maintenance screen, [2](#)
- MSDPTPRM - Protocol Parameter Definition screen, [27](#)
- MSDQMAP - Message Queue Mapping Maintenance screen, [6](#)
- MSDQMNT - Message Queue Maintenance screen, [8](#)
- MSDRLDFN - Routing Rule Definition screen, [23](#)
- MSDRLGRP - Rule Group Definition screen, [21](#)
- MSDRLMAP - Rule Group Mapping screen, [19](#)
- MSDSWTSR - SWIFTNet Service Definition screen, [12](#)
- MSSBLKMN - Bulk Monitor Summary screen, [45](#)
- MSSBLKRL - Bulking Preference Definition Summary screen, [43](#)
- MSSDEBRL - Debulk Rule Definition Summary screen, [36](#)
- MSSDSTNM - Distinguished Name Definition Summary screen, [34](#)
- MSSFLBRW - Outbound File Browser screen, [38](#)
- MSSFTACN - SWIFTNet FTA Connector Definition Summary screen, [31](#)
- MSSIFBRW - Inbound File Browser Summary screen, [40](#)
- MSSLAUMN - SWIFT LAU Key Summary screen, [16](#)
- MSSNOTIB - SWIFT Message Notification Browser screen, [10](#)
- MSSPTPRM - Protocol Parameter Definition Summary screen, [28](#)
- MSSRLDFN - Routing Rule Definition Summary screen, [26](#)
- MSSRLGRP - Rule Group Definition Summary screen, [22](#)
- MSSRLMAP - Rule Group Mapping Summary screen, [20](#)
- MSSSWTSR - Swift Net Service Definition Summary screen, [13](#)