

Oracle® Financial Services Lending and Leasing

Line Origination Setup Guide



Release 15.1.0.0.0

G52306-01

April 2026

The Oracle logo, consisting of a solid red square with the word "ORACLE" in white, uppercase, sans-serif font centered within it.

ORACLE®

Copyright © 2022, 2026, Oracle and/or its affiliates.

This software and related documentation are provided under a license agreement containing restrictions on use and disclosure and are protected by intellectual property laws. Except as expressly permitted in your license agreement or allowed by law, you may not use, copy, reproduce, translate, broadcast, modify, license, transmit, distribute, exhibit, perform, publish, or display any part, in any form, or by any means. Reverse engineering, disassembly, or decompilation of this software, unless required by law for interoperability, is prohibited.

The information contained herein is subject to change without notice and is not warranted to be error-free. If you find any errors, please report them to us in writing.

If this is software, software documentation, data (as defined in the Federal Acquisition Regulation), or related documentation that is delivered to the U.S. Government or anyone licensing it on behalf of the U.S. Government, then the following notice is applicable:

U.S. GOVERNMENT END USERS: Oracle programs (including any operating system, integrated software, any programs embedded, installed, or activated on delivered hardware, and modifications of such programs) and Oracle computer documentation or other Oracle data delivered to or accessed by U.S. Government end users are "commercial computer software," "commercial computer software documentation," or "limited rights data" pursuant to the applicable Federal Acquisition Regulation and agency-specific supplemental regulations. As such, the use, reproduction, duplication, release, display, disclosure, modification, preparation of derivative works, and/or adaptation of i) Oracle programs (including any operating system, integrated software, any programs embedded, installed, or activated on delivered hardware, and modifications of such programs), ii) Oracle computer documentation and/or iii) other Oracle data, is subject to the rights and limitations specified in the license contained in the applicable contract. The terms governing the U.S. Government's use of Oracle cloud services are defined by the applicable contract for such services. No other rights are granted to the U.S. Government.

This software or hardware is developed for general use in a variety of information management applications. It is not developed or intended for use in any inherently dangerous applications, including applications that may create a risk of personal injury. If you use this software or hardware in dangerous applications, then you shall be responsible to take all appropriate fail-safe, backup, redundancy, and other measures to ensure its safe use. Oracle Corporation and its affiliates disclaim any liability for any damages caused by use of this software or hardware in dangerous applications.

Oracle®, Java, MySQL, and NetSuite are registered trademarks of Oracle and/or its affiliates. Other names may be trademarks of their respective owners.

Intel and Intel Inside are trademarks or registered trademarks of Intel Corporation. All SPARC trademarks are used under license and are trademarks or registered trademarks of SPARC International, Inc. AMD, Epyc, and the AMD logo are trademarks or registered trademarks of Advanced Micro Devices. UNIX is a registered trademark of The Open Group.

This software or hardware and documentation may provide access to or information about content, products, and services from third parties. Oracle Corporation and its affiliates are not responsible for and expressly disclaim all warranties of any kind with respect to third-party content, products, and services unless otherwise set forth in an applicable agreement between you and Oracle. Oracle Corporation and its affiliates will not be responsible for any loss, costs, or damages incurred due to your access to or use of third-party content, products, or services, except as set forth in an applicable agreement between you and Oracle.

Contents

1 Navigation

1.1	Template and Navigation	1
1.1.1	Home Screen	1
1.1.1.1	Time Zone Preference	6
1.1.2	Screen Navigation	7
1.1.3	Screens	13
1.2	Accessibility	13
1.2.1	Understanding Accessibility	13
1.2.2	Application Accessibility Preferences	14
1.2.3	Documentation Accessibility Preferences	14

2 Administration System

2.1	System Parameters	2
2.1.1	System Parameters Setup	2
2.1.1.1	FCUBS Integration	3
2.1.2	Organization Parameters	4
2.1.3	Company Parameters	6
2.2	Lookups	8
2.3	User Defined Tables	10
2.4	Audit Tables	13
2.5	User Defined Defaults	16
2.6	User Defined Parameters	19
2.6.1	Formula Definition	27
2.6.2	Selection Criteria	29
2.7	Transaction Codes	30
2.7.1	Transaction Codes sub screens	34
2.7.1.1	Parameters	35
2.7.1.2	Access Grid	35
2.7.1.3	Products	36
2.8	Data Files	37
2.8.1	Output tab	37
2.8.1.1	Data File Definitions	37
2.8.1.2	Record Definitions	39

2.8.1.3	Column Definitions	39
2.8.2	Input tab	40
2.8.2.1	Input Data File Definitions	40
2.8.2.2	Column Definitions	42
2.8.2.3	Configurable Bulk Upload	43
2.9	Events	44
2.9.1	Events (Existing Framework)	45
2.9.1.1	Event Types	45
2.9.1.2	Event Action Types	46
2.9.1.3	Online	47
2.9.1.4	Batch	50
2.9.2	Events (New Framework)	53
2.9.3	Monitoring JMS Event Actions	60
2.10	Batch Jobs	60
2.10.1	Batch Jobs	60
2.10.1.1	Batch Jobs	60
2.10.1.2	Job Holidays	64
2.10.2	Batch Jobs Available	65
2.11	Producer Cycles	134
2.12	Vendors	137
2.12.1	Cycles Tab	137
2.12.2	Vendor Services Tab	139
2.12.3	Vendor Fees Tab	141
2.12.4	Invoice Rules tab	142
2.13	Reports	143
2.14	Error Messages	144
2.15	Translation	146
2.15.1	Setup Translation	146
2.15.2	Message Translation Setup	148
2.16	Label Configuration	151
2.17	Seed Data	154
2.17.1	Factory Data	155
2.17.1.1	Update/Skip Seed Data	156
2.17.2	Current Data	157
2.17.3	Comparison Data	158
2.17.4	Download Data	159
2.18	Data Masking	160
2.18.1	Setup Data Masking	162
2.18.1.1	Data Masking Details	162
2.18.1.2	User Access Details	163
2.18.2	Create data redaction policy	164
2.18.3	Masking User defined data	165

2.19	Webhook	166
2.19.1	Webhook Definition	167
2.19.2	Event Details	171
2.19.3	Authentication Attributes	172
2.19.4	Monitoring Webhook Events	173

3 Administration User

3.1	Organization	1
3.2	Companies	7
3.3	Access	13
3.3.1	Data	14
3.3.2	Screen	15
3.3.2.1	Security Access Definition	15
3.3.2.2	Field Access Definition	17
3.3.2.3	Security User Access Definition Details	19
3.3.3	Reports	20
3.3.4	Correspondence	21
3.3.5	Webservice	23
3.4	Users	28
3.4.1	Replacement users	31
3.4.2	Application and Oracle Identity Manager Synchronization	31
3.5	Credit Bureau	32
3.5.1	Credit Bureau	33
3.5.1.1	Report Formats	33
3.5.1.2	Connections	37
3.5.1.3	Zip Matrix	41
3.5.1.4	Parameters	42
3.5.1.5	Score Reasons	43
3.5.1.6	Reporting	45
3.5.2	Special Metro II Code reporting	46
3.5.3	Oracle Wallet Manager setup	47
3.5.4	Oracle JVM Security setup	49
3.5.5	Importing a trusted certificate into an Oracle Wallet	49
3.5.6	Importing the Certificates into an Oracle Wallet	51
3.5.7	De-duping Credit Bureau data	53
3.6	Correspondence	55
3.6.1	Correspondence	56
3.6.1.1	System Functions	57
3.6.1.2	Elements	58
3.6.1.3	E-Form Elements	59
3.6.1.4	Documents	60

3.6.1.5	Correspondence	64
3.6.2	Creating Correspondence	66
3.6.3	Generating Correspondence	68
3.7	Queues	70
3.7.1	Origination Tab	71
3.7.1.1	Selection Criteria	73
3.7.1.2	Sort	74
3.7.1.3	Responsibilities and Users	75
3.7.1.4	Data Node Assignments	75
3.7.1.5	Group Assignment	76
3.7.2	User Groups Tab	76
3.8	Printers	78
3.9	Intelligent Segmentation	80
3.9.1	Machine Learning for Queue Creation	81
3.9.2	Machine Learning Data visualization	81
3.9.2.1	Cluster view	82
3.9.2.2	Segment View	82
3.9.2.3	Insights View	83
3.9.2.4	Selection Criteria Attributes	83
3.9.3	View Machine Learning Generated Queue	83
3.9.4	Create ML Based Queue	84
3.10	Bank Details	85
3.11	Standard Payees	88
3.12	Check Details	90
3.13	Currencies	91
3.13.1	Currency Definition	92
3.13.2	Currency Pair link	93
3.14	Zip Codes	94
3.15	Payment Hierarchy	95
3.15.1	Payment Appropriation Methods	96
3.15.2	Excess Payment Appropriation	98
3.16	Number Generation	101
3.16.1	Overview	101
3.16.2	Navigation	101
3.16.3	Number Generation Definition	102
3.16.3.1	Number Sequence	103

4 Product

4.1	Asset Types	1
4.1.1	Usage/Rental Details	5
4.1.2	Usage Charge Matrix	8

4.1.3	Rental Charge Matrix	8
4.2	Index Rates	9
4.3	Currency Exchange	11
4.4	Scoring Parameters	12
4.5	Products	14
4.5.1	Product Itemizations	18
4.6	Pricings	18
4.7	Contract	22
4.7.1	Balances	34
4.7.2	Amortized Balances	35
4.7.3	Itemizations	36
4.7.4	Fees	38
4.8	Edits	39
4.8.1	Interfacing OFSLL with Oracle Rule Author	44
4.9	Cycles	44
4.10	Scoring Models	51
4.10.1	Credit Score Models	51
4.11	Fees	55
4.12	Asset Billing Rate	59
4.12.1	Asset Billing Rate Definition	59
4.12.2	Asset Billing Rate Details	61
4.12.2.1	Tiered Rate Details sub tab	63
4.12.3	Asset billing Calculations	63
4.12.3.1	Flat Amount Calculation	63
4.12.3.2	Rate Calculation	64
4.12.3.3	Flat Amt + Rate Calculation	64
4.12.3.4	Tiered Rate Calculation	65
4.12.3.5	Slab Formula Calculation	65
4.12.4	Asset Billing Rate Setup - File upload	65
4.12.5	Asset Billing Batch Job	66
4.13	Origination Fees	68
4.14	Insurance	70
4.15	Checklists	73
4.16	Stipulations	75
4.17	Letters	77
4.18	Promotions	80

A Appendix : Summary of the Application Credit Scoring Parameters

A.1	Glossary	A-1
A.2	Credit Scoring Parameters by Category	A-1
A.2.1	Applicant Details / Debt Ratios	A-2

A.2.2	Line of Credit Details	A-4
A.2.3	Auto Trades / Inquiries	A-4
A.2.4	Bank Trades / Inquiries	A-5
A.2.5	Card Trades / Inquiries	A-7
A.2.6	Installment Trades / Inquiries	A-8
A.2.7	Line of Credit Finance Trades / Inquiries	A-9
A.2.8	Mortgage Trades / Inquiries	A-10
A.2.9	Retail Trades / Inquiries	A-11
A.2.10	Revolving Trades	A-12
A.2.11	Sales Finance Trades / Inquiries	A-14
A.2.12	Other Trades	A-15
A.2.13	Bankruptcy Information	A-18
A.2.14	Delinquency Information	A-19
A.2.15	Derogatory Trade Information	A-20

B Appendix : Rounding Amounts and Rate Attributes

C Appendix : System Parameters

C.1	Introduction	C-1
C.2	System Parameters	C-1
C.3	Organization Parameters	C-21
C.4	Company Parameters	C-25
C.5	Other Parameters	C-29

D Appendix : Configuration at Company Level

D.1	Introduction	D-1
D.2	Existing Configuration	D-1
D.3	Configuration at Company Level	D-2
D.4	Setup Company Definition	D-2
D.4.1	Holiday Setup and Processing	D-4
D.4.2	Batch Jobs Processing	D-4
D.5	Setup Multiple Companies in Same/Different Time Zone	D-4
D.5.1	Setup for New Company Added Subsequently	D-5
D.6	Impact on Defining Configuration at Company Level	D-5
D.6.1	Company Level Configuration Settings	D-6
D.6.2	Scheduler	D-6
D.6.3	Debug Logs	D-6
D.6.4	Setup Screens	D-6
D.6.5	File Uploads	D-6

D.6.5.1	Input File	D-7
D.6.5.2	Output File	D-7
D.6.6	Transactions	D-7
D.6.7	Web Services	D-7
D.6.8	Letters, Correspondence	D-8
D.6.9	Reports	D-8
D.6.10	Credit Bureau & Metro II	D-8
D.6.11	GL	D-8
D.6.12	ODD1, ODD2, ODD3	D-8
D.6.13	Migration	D-8
D.6.14	Conversion	D-8
D.6.15	Archive	D-8
D.6.16	Purge	D-9
D.6.17	Standard Payees	D-9
D.6.18	Data Masking	D-9
D.6.19	WFP Module	D-9
D.6.20	Batch Jobs and File uploads	D-9
D.6.21	Assumptions	D-9

Preface

This topic contains the following sub-topics:

- [Purpose](#)
- [Before You Begin](#)
- [Module Prerequisite](#)
- [Audience](#)
- [Documentation Accessibility](#)
- [Critical Patches](#)
- [Diversity and Inclusion](#)
- [Conventions](#)
- [Screenshot Disclaimer](#)
- [Basic Actions](#)
- [Basic Operations](#)
- [Module Post-Requisites](#)

Purpose

The purpose of this Setup Guide is to provide clear and structured instructions for configuring the system or application to meet business requirements. It outlines the necessary prerequisites, configuration steps, and validation procedures to ensure a successful and accurate setup. This guide is intended to assist users in implementing the system efficiently and maintaining consistency across environments.

Before You Begin

Refer to the Getting Started User Guide for information on common functionalities like login, navigation, and general settings. Reviewing that guide is advisable before proceeding with this document.

Module Prerequisite

Specify **User ID** and **Password**, and login to Homescreen.

Audience

This document is intended to all Prospective Users who would be working on the application.

Documentation Accessibility

For information about Oracle's commitment to accessibility, visit the Oracle Accessibility Program website at <http://www.oracle.com/pls/topic/lookup?ctx=acc&id=docacc>.

Access to Oracle Support

Oracle customer access to and use of Oracle support services will be pursuant to the terms and conditions specified in their Oracle order for the applicable services.

Critical Patches

Oracle advises customers to get all their security vulnerability information from the Oracle Critical Patch Update Advisory, which is available at [Critical Patches, Security Alerts and Bulletins](#). All critical patches should be applied in a timely manner to make sure effective security, as strongly recommended by [Oracle Software Security Assurance](#).

Diversity and Inclusion

Oracle is fully committed to diversity and inclusion. Oracle respects and values having a diverse workforce that increases thought leadership and innovation. As part of our initiative to build a more inclusive culture that positively impacts our employees, customers, and partners, we are working to remove insensitive terms from our products and documentation. We are also mindful of the necessity to maintain compatibility with our customers' existing technologies and the need to ensure continuity of service as Oracle's offerings and industry standards evolve. Because of these technical constraints, our effort to remove insensitive terms is ongoing and will take time and external cooperation.

Conventions

The following text conventions are used in this document:

Table Conventions

Term	Refers to
boldface	Boldface type indicates graphical user interface elements associated with an action, or terms defined in text or the glossary.
<i>italic</i>	Italic type indicates book titles, emphasis, or placeholder variables for which user supply particular values.
monospace	Monospace type indicates commands within a paragraph, URLs, code in examples, text that appears on the screen, or text that user enter.

Screenshot Disclaimer

Personal information used in the interface or documents is dummy and does not exist in the real world. It is only for reference purposes.

Basic Actions

Most of the screens contain buttons to perform all or few of the basic actions.

All or few of these actions are enabled when user select any of the Basic Operations.

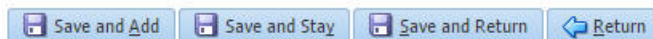

Table Basic Actions

Basic Actions	Description
Save And Add	Click to save and add a new record. This button is displayed when user click Add button.
Save and Stay	Click to save and remain in the same page. This button is displayed when user click Add/Edit button.
Save And Return	Click to save and return to main screen. This button is displayed when user click Add or Edit buttons.
Return	Click to return to main screen without modifications. This button is displayed when user click Add , Edit or View buttons.

The Payment maintenance screens consist of the following actions.







Table Basic Actions

Basic Actions	Description
Post and Stay	Click to post the transaction and remain in the same section. This button is displayed when user click Modify Payment/Modify Payment Transaction button.
Post and Return	Click to save and return to main section. This button is displayed when user click Modify Payment/Modify Payment Transaction buttons.
Return	Click to return to main section without modifications. This button is displayed when user click Modify Payment/Modify Payment Transaction buttons.



The summary screens consist of the following navigations.

Table Navigations

Basic Actions	Description
	Click to navigate to the first record.
	Click to navigate to the previous record.
	Click to navigate to the next record.
	Click to navigate the last record.

Along with the basic actions, the following buttons are available for specific actions.

Table Buttons for Specific Actions

Basic Actions	Description
	Show File - Click to view the details of selected file.
	List Files - Click to generate and view the list of files maintained in the system.
	Download File - Click to download the details of selected data.

Basic Operations

All the screens contain buttons to perform all or few of the basic operations. The four basic operations available:

- Add
- Edit
- View
- Audit



When user click any of the operation tabs, system displays the corresponding records inline, below the respective setup tables.

Table Basic Operation

Basic Operation	Description
Add	Click to add a new record. When user click Add , the system displays a new record enabling user to specify the required data. It is mandatory to specify details for the fields marked with '*' symbol.
Edit	Click to edit an existing record. Select the record user want to edit and click Edit . The system displays an existing record in editable mode. Edit the required details.
View	Click to view an existing record. Select the record user want to view and click View . The system displays the record details in display mode.
Audit	Click to view audit info. If an audit is set for a field, then the system tracks the changes for that field. Select the record for which user want to view the audit info and click Audit . The system displays the details tracked for that field.
Close	Click to close a screen or a record. When user try to close an unsaved, modified record, then the system alerts user with an error message. User can click Yes to continue and No to save the record.

Module Post-Requisites

After finishing all the requirements, please log out from the Homescreen.

1

Navigation

This topic provides information about navigation within the application, helping users access and manage screens efficiently.

This document provides an overview of the basic template, navigation, common operations that can be performed, and keyboard short cuts available in Oracle Financial Services Lending and Leasing. Since this section details the general options available in the User Interface, some or all the parts of this section are applicable to User as per access provisions and licensing.

Note

The application can be best viewed in 1280 x 1024 screen resolution.

The document is organized into below topics:

- [Template and Navigation](#)
This section provides a brief input on the template and navigation of the system.
- [Accessibility](#)
This topic provides information about accessibility features that ensure the system can be used effectively by individuals with diverse abilities.

1.1 Template and Navigation

This section provides a brief input on the template and navigation of the system.

Details are grouped into two categories to enable easy understanding. These include:

- [Home Screen](#)
This topic describes the information about the home screen.
- [Screen Navigation](#)
This topic explains screen navigation using panes and search options.
- [Screens](#)
This topic provides information about the screens and their functions within the application.

1.1.1 Home Screen

This topic describes the information about the home screen.

Once user login to the application with valid credentials, the system authenticates the details and displays the Home screen.

The Home screen consists of the following components:

- Header
- Left Pane
- Right Pane/Work Area

Figure 1-1 Home Screen

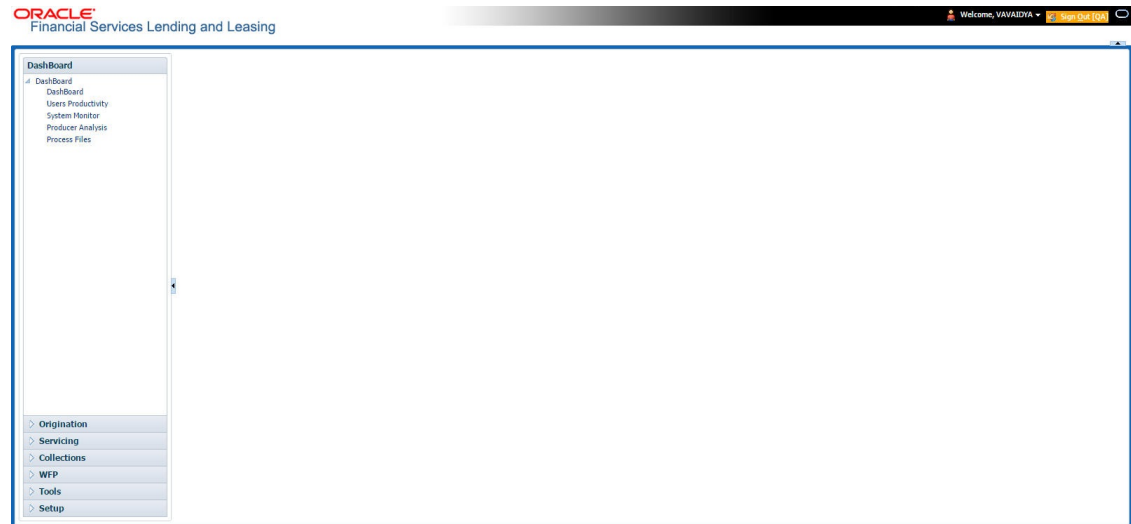

User can view the application version details and copyright information by clicking **About** link at the right bottom corner of the screen.

The **About** screen displays.

Figure 1-2 About

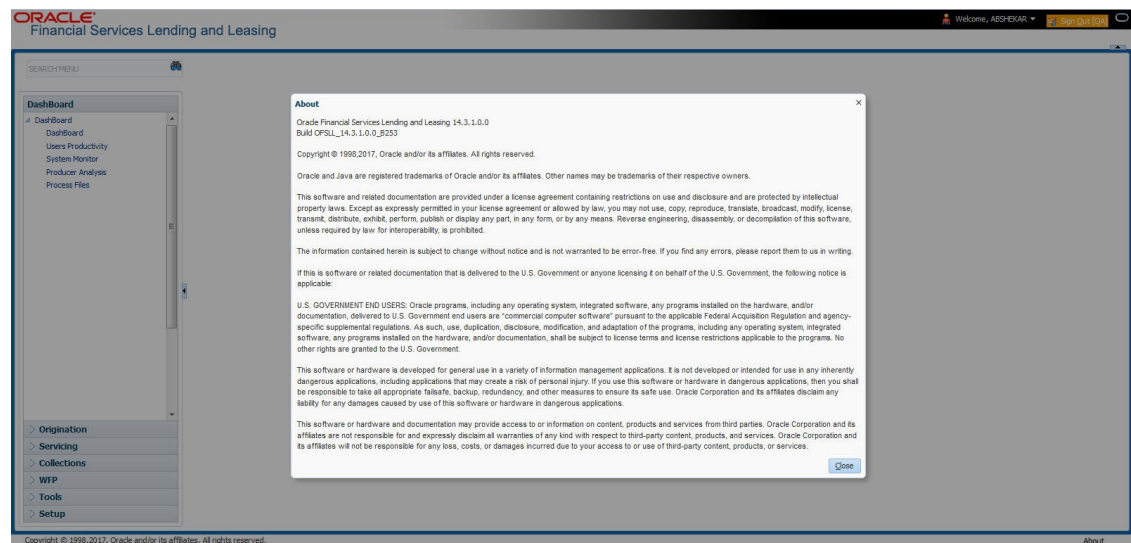

Header

In the Header, system displays the following:

- **Sign Out** - Sign Out option along with the application environment details based on information maintained in ENVIRONMENT_TYPE_CD lookup code.
- **User ID** that user have currently logged/Signed in. Click the adjoining drop-down arrow, the system displays the following options:

Figure 1-3 User ID - Options



1. Click the **Change Password** to change the current password.
The **Change Password** screen displays.

Figure 1-4 Change Password

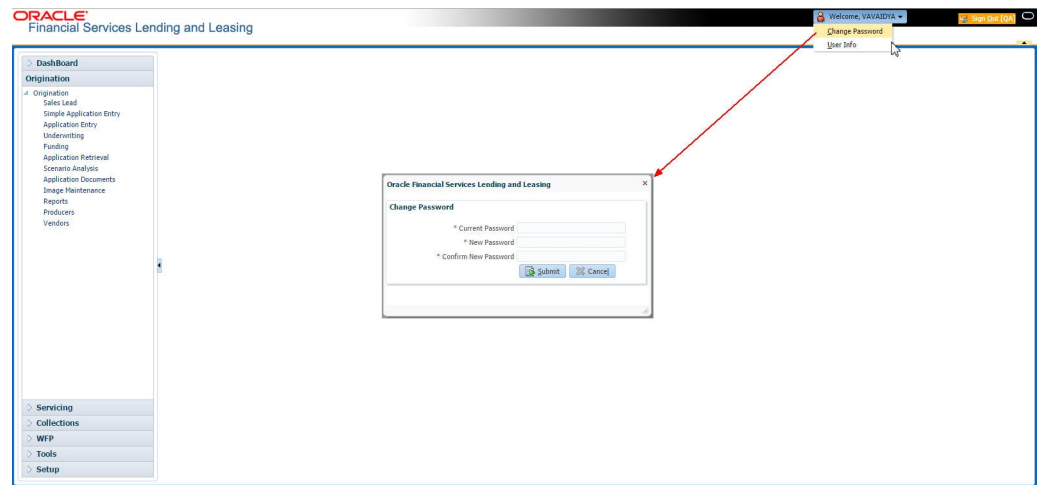

For more information on fields, refer to the field description table.

Table 1-1 Change Password - Field Description

Field	Description
Current Password	Specify the current password.
New Password	User wish to maintain as a new password.
Confirm Password	Re-enter the new password.

2. Click **Submit** to change the password.
3. Click the **User Info** to view the current user information.

The **User Info** screen displays.

Figure 1-5 User Info

For more information on fields, refer to the field description table.

Table 1-2 User Information

Field	Description
Organization	Displays the organization name.
Division	Displays the specific subdivision or department within the organization.
First Name	Displays the user's first name.
Last Name	Displays the users last name.
Responsibility	Displays the users role or access level within the system.
GL Post Date	Displays the General Ledger posting date assigned to the user.
Last Login Date	Displays the last time and date the user logged into the system.
Session Language	Select a language that user need to set for the session, from the drop-down list.
Debug Enabled Ind	Check this box to enable the debug indicator.
Time Zone Level	Select the time zone level from the drop-down list. The available options are: <ul style="list-style-type: none"> – Application Server Time Zone – Company Branch Time Zone – User Time Zone
User Time Zone	The specific time zone setting for the user session.
Company Branch Time Zone	Displays the company branch time zone.
Server Time Zone	Displays the time zone in which the application server is running.
Skin Family	Select the skin family from the drop-down list.

In this screen, apart from viewing the user info, user can also set Session Language, enable error log, and specify the time zone preference.

Debug Enabled Ind – Check this box to enable the debug indicator.

On selection, system records all the debugs into logs files depending on the following two types of system parameters:

Table 1-3 System Parameter



System Parameter	Condition to record debug data
CMN_DEBUG_METHOD	If parameter value is 1, then debug data is recorded into a file in Database Server. If parameter value is 4, then debug data is recorded into the table LOG_FILES_HEADER.
CMN_DEBUG_LEVEL	If parameter value is greater than 0, only then the debug data is recorded.

- Navigate to the **Dashboard**. Under **Dashboard**, click **System Monitor**. Under **System Monitor**, click **Database Server Log Files**.

The **Database Server Log Files** screen displays.

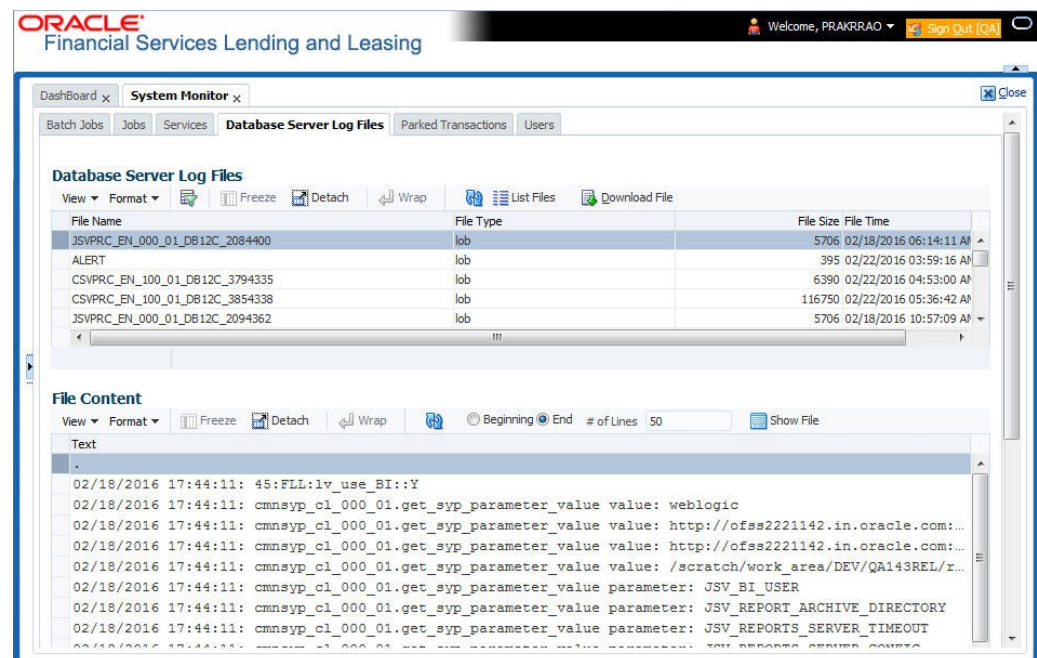
Figure 1-6 Database Server Log Files



- User can click on  **List Files** button to view the list of logged files.
 - Click on  **Show File** button to view the selected file contents in the **File Content** section.
 - User can also click  **Download File** button to extract a copy of debug details.
 - Click **Submit** to save the changes or **Close** to close the screen without changes.
- NextGenUI** - This is Next Generation User Interface option which is an enhanced interface provided in OFSLL using the Oracle JavaScript Extension Toolkit (Oracle JET) frame work. This is an additional interface supported from OFSLL to the existing system and both intended to coexist in the system till further updates.

This option is enabled only, if the corresponding system parameter is enabled in the base system as configured by user system administrator. For more information, refer to **Appendix - Oracle JET Interface** section in Servicing guide.

This section consists of the following topic:

- [Time Zone Preference](#)
This topic provides information about setting and managing time zone preferences in the application.

1.1.1.1 Time Zone Preference

This topic provides information about setting and managing time zone preferences in the application.

Figure 1-7 User Info

The screenshot shows the 'User Info' window in the Oracle Financial Services Lending and Leasing application. The window title is 'Oracle Financial Services Lending and Leasing'. The 'User Info' section contains the following fields:

Organization	DMC	Time Zone Level	USER TIME ZONE
Division	US01	User Time Zone	UNDEFINED
First Name	VARSHA	Company	US/CENTRAL (CENTRAL STANDARD TIME)
Last Name	VAIDYA	Branch Time Zone	
Responsibility	SUPERUSER	Server Time Zone	ASIA/CALCUTTA (INDIA STANDARD TIME)
GL Post Date	02/10/2016	Skin Family	Skyros (Default)
Last Login Date	02/10/2016 03:21:07 AM		
Session Language	DEFAULT		
Debug Enabled Ind	<input type="checkbox"/>		

At the bottom of the window, there are two buttons: 'Submit' and 'Close'.

User can select any of the following three time zones from the User Info screen:

- Application Server Time Zone
- Company Branch Time Zone
- User Time Zone

The time zones set up at each of these levels are displayed in the user info screen. However, data is always stored in the application server time zone and based on the user preference of time zone, the display time would be User or Company or Application Server time zone. Any time zone related changes done at UI does not impact the other time bound activities which are dependent on database time.

Application Server Time Zone (Server Time Zone)

The Application Server Time Zone by default is the Production Server Time Zone. Selecting this time zone will have all date and time fields defined as per the time stored in application server. There is no offset in time, if both storage (database server) and display (application server) are in the same time zone.

Company Branch Time Zone (Organization - Division Time Zone)

This is the Company time zone and is setup at the organization - division definition level. The various divisions defined under an organization can be set up with different time zones depending on geographical locations. This time can be modified as per requirement.

To modify the Company Branch Time Zone:

- Navigate to **Setup**. Under **Setup**, click **Administration**. Under **Administration**, click **User**.
- Under **User**, click **Organization** and select the company or division listed under **Division Definition**.
- In the Display Formats tab, select **Time Zone** and click **Edit**.
- In the Format field, select the required time zone from the adjoining options list and click **Save**.

If **Company Branch Time Zone** is selected as the time zone in User Info screen, then on save, all the time and date fields are automatically updated with the time zone of the company branch.

User Time Zone

User Time Zone or User Preference Time Zone can be set up at the User Level in the User Definition screen. Various Users under same divisions defined under an organization can be set up with different time zones depending on geographical locations.

To modify the User Time Zone:

- Navigate to **Setup**. Under **Setup**, click **Administration**. Under **Administration**, click **User**. Under **User**, click **Users**.
- Select the required User record listed in **User Definition** section and click **Edit**.
- In the Time Zone field, select the required time zone from the adjoining options list and click **Save**.

If **User Time Zone** is selected as the time zone in User Info screen, then on save, all the time and date fields are automatically updated with the current updated time.

1.1.2 Screen Navigation

This topic explains screen navigation using panes and search options.

Left Window



In the left pane, system lists and provides drop-down links for various modules available in the product. Click  to expand the Module Master Tabs and  to collapse them.

Figure 1-8 Left Pane



To open a screen, navigate to Module Master Tab to which the screen belongs, expand the tabs, and click the screen link user wish to open.

Menu Search in Left Window

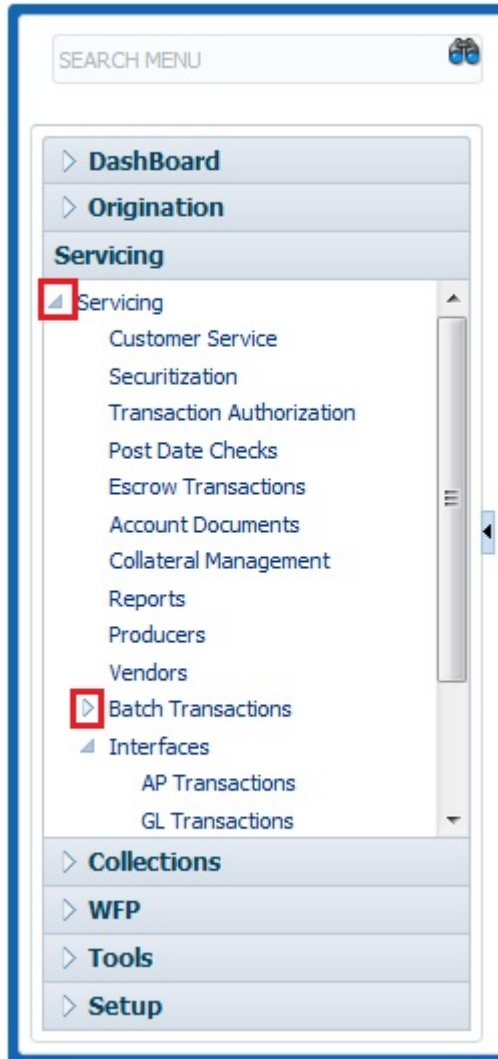
In the left window user can make use of the search option to directly search and open the screen that user are familiar with, and avoid multiple steps of navigation from the LHS menu.

The Search box in the LHS facilitates for an intuitive search of required screens in Oracle Financial Services Lending and Leasing. For example, on typing the first letter of the screen, the search box displays a list of all available screens starting with the letter entered in alphabetical order. User can click on the required screen and press **Enter**. The screen is displayed in the main window/work area.

Figure 1-9 Left Pane Search

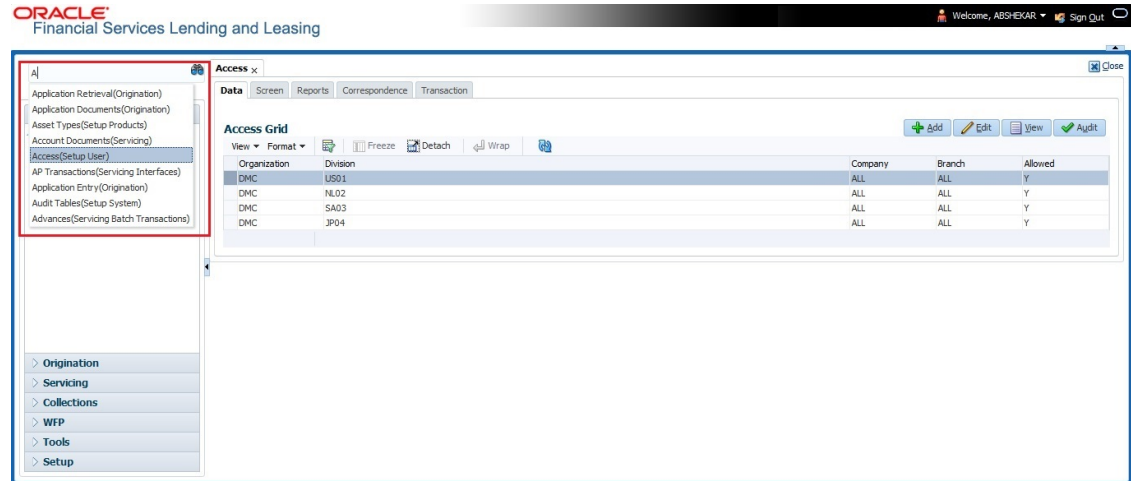

When there are multiple matches with same screen name, user can filter the results through the module from which the screen is accessed which is indicated in angular brackets. For example typing **VEN** displays the following options for selection - Vendors(Collections), Vendors(Origination), Vendors(Servicing), Vendors(Setup System). For subsequent search, user need to clear the data in the search field.

Right Window

The Right Window can also be termed as work area. When user click the screen link on left pane, system displays the corresponding screen in the right pane.

Figure 1-10 Right Pane

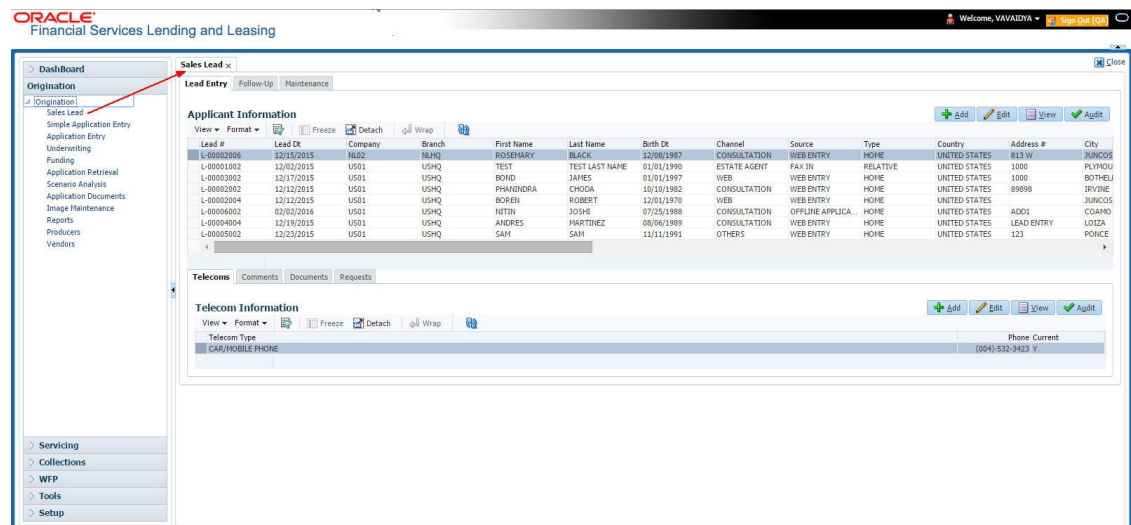

User can open a maximum of 15 screens at a go. Once the maximum limit is reached, the system displays an error message.

Figure 1-11 15 Screens

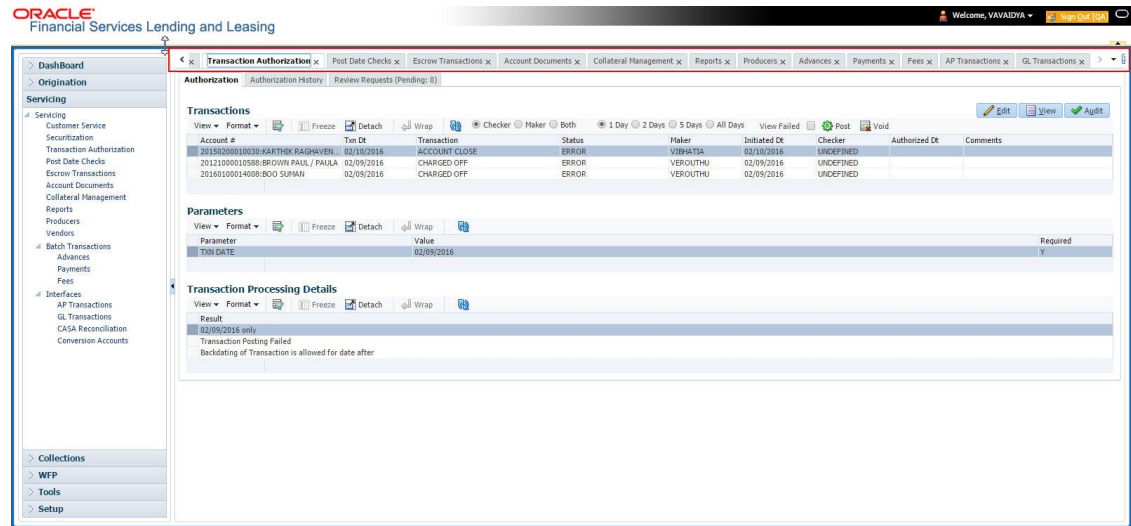

Each active screen is displayed as a tab at the top of right pane, across its width. To view a screen, click the screen tab. User can identify the active screen with its white background. Also, operation on any of the screen will not affect the data in other screens.

User can also open multiple Applications at the same time as separate tabs in the right window, provided the users system administrator has enabled the option '**Mac_Multi_tab_Ind**' = 'Y' in MENU_ACCESS table.

Having this option enabled user can view and update a maximum of 15 Applications in parallel tabs and Oracle Financial Services Lending and Leasing renders dynamic data across all the opened tabs.

However, this option is restricted only to the following screens in Origination Module Master Tab. In the Left Menu of Origination Module Master Tab, user can open multiple applications by click on the following links. Each successive click, opens a new Origination tab.

- Simple Application Entry
- Application Entry
- Underwriting
- Funding

Figure 1-12 Multi Tab - Origination

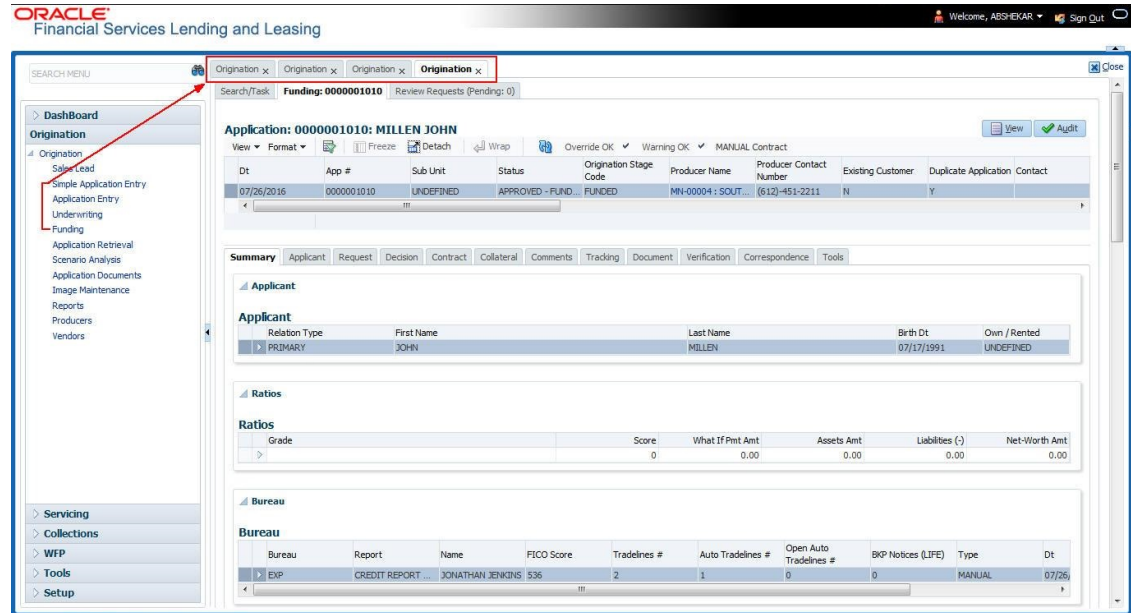



Few screens in Origination are identical and are linked. Hence, when multi tab option is not enabled, User can open only one screen at a time from the group. A sample of the grouping structure is given below, based on stages of the screens:

Origination:

- Simple Application Entry
- Application Entry
- Underwriting
- Funding

As per the above listing, user will be able to open only one screen in the corresponding list and need to close the same to open any other screen.

Right Splitter/Action Window

The Right Splitter/Action Window has quick access to search and other options to avoid switching between tabs or navigating into sub tabs periodically. User can access the Right Splitter/Action Window while working on Application screens. User can click  and  to toggle the view of Right Splitter/Action Window.

Origination Screens

1. Navigate to **Origination**, click **Origination**. Under **Origination**, click **Funding**.

The user can use the Right Splitter/Action Window to do the following:

Figure 1-13 Right Split Window Application

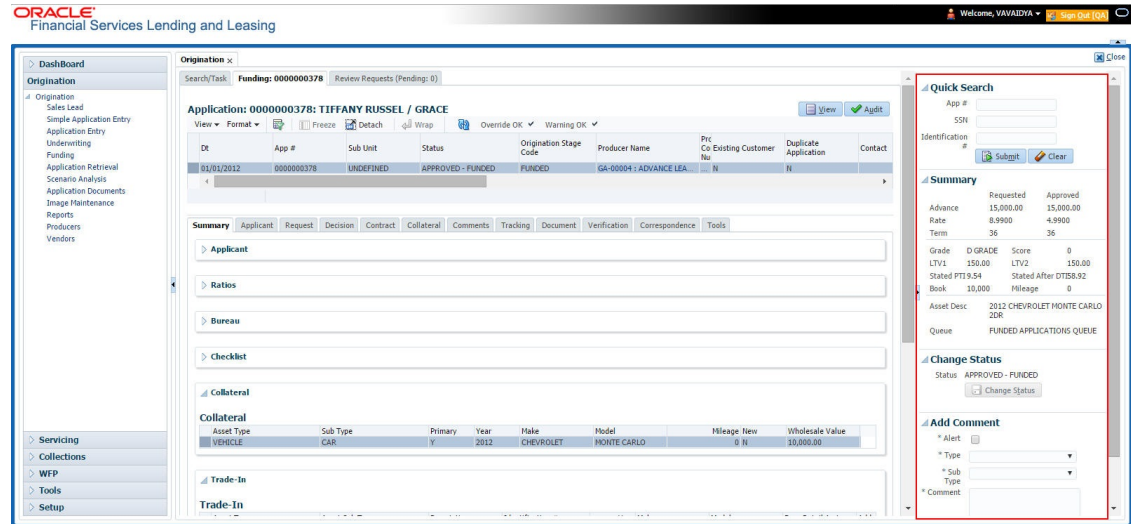

For more information on fields, refer to the field description table.

Table 1-4 Quick Search

Field	Description
Quick Search	It displays the Quick Search section.
App#	Enter the unique Application Number to quickly search for a specific application.
SSN	Enter the last 4 digits of the applicant’s Social Security Number for application lookup.
Identification #	If multiple applications or accounts are found during Identification # search, the system displays an error message as “Multiple Matches found for the Identification #, Please use normal Search”.
Submit	Click to execute the search based on the entered criteria.
Clear	Click to reset the entered search fields for a new search.
Summary	Summary section displays critical information that has to be referred repeatedly during origination like – DTI, PTI, Book Value, Grade, FICO Score, Approved Advance, Rate and Term.
Change Status	Use Change Status section to change the application status to next level. If the application edit status is restricted, then the Change Status will be read-only.
Add Comment	Use Add Comment section to post an alert or comment during Underwriting and Funding stages.

For detailed information on the above options, refer to respective sections in the document.

The height of Header and width of the Left and Right Panes do not change, with resizing of application screen.

The system facilitates toggling Header and Left and Right Panes of the home screen to increase the visible area of the screens. Click to toggle upper pane and to toggle left pane. To un-toggle click and respectively.

1.1.3 Screens

This topic provides information about the screens and their functions within the application.

Details in few main screens are grouped into different sections. These sections are displayed as tabs, horizontally within the screen. In turn, details in few of these tabs are again grouped horizontally. The details are displayed when user click the tab under which they are grouped. As similar to the main screen tabs, user can identify the active tab with its white background.

For example, Customer Service main screen has four main tabs. When user click on **Customer Service** tab, the corresponding tabs are displayed.

Figure 1-14 Customer Service_Example

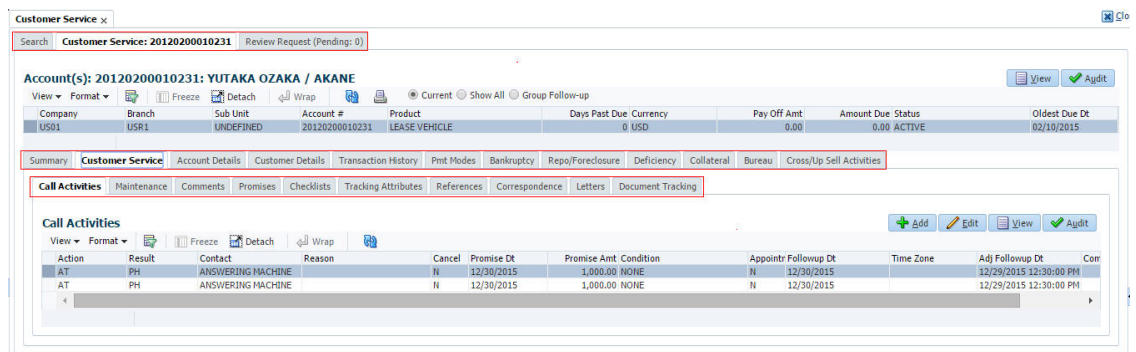

User can click » to view the hidden tabs, if any.

1.2 Accessibility

This topic provides information about accessibility features that ensure the system can be used effectively by individuals with diverse abilities.

This section consists of the following:

- [Understanding Accessibility](#)
This topic provides information about understanding accessibility features and ensuring inclusive application usage.
- [Application Accessibility Preferences](#)
This topic provides information about configuring application accessibility preferences to enhance usability for all users.
- [Documentation Accessibility Preferences](#)
This topic provides information about configuring Documentation Accessibility Preferences to improve readability and ease of use.

1.2.1 Understanding Accessibility

This topic provides information about understanding accessibility features and ensuring inclusive application usage.

Accessibility is making the application usable for multiple user groups, which includes users with physical challenges. One of the most important reasons to make the application

accessible is to provide them the opportunity to work. The four main categories of disabilities are visual, hearing, mobility and cognitive.

A person with disability might encounter one or more barriers that can be eliminated or minimized by making the electronic information user-friendly and approachable.

1.2.2 Application Accessibility Preferences

This topic provides information about configuring application accessibility preferences to enhance usability for all users.

Oracle Financial Services Lending and Leasing is facilitated with the feature of Accessibility to make the application more usable for the people who are differently abled.

By default, the following accessibility options are provided and there is no need to define special accessibility preference in the application:

- The application user interface contents are readily accessible for all types of users without the need to select special accessibility modes.
- The components within the user interface are optimized for use with a screen reader by default.
- The contents are zoom-able by default, eliminating the need for an application large fonts mode.
- The user interface components auto-detect, if operating system (OS) is set to high contrast mode and automatically render content that is compatible with OS high contrast, eliminating the need for an application high contrast mode.

Note that, Oracle Financial Services Lending and Leasing application user interface is built on Oracle Application Development Framework (ADF) and the default accessibility feature supported by ADF are made available. For additional information, refer to ADF documentation on accessibility preferences.

1.2.3 Documentation Accessibility Preferences

This topic provides information about configuring Documentation Accessibility Preferences to improve readability and ease of use.

Apart from assigning the logical sequence and organizing topics, the following techniques are used to enhance the accessibility of documentation.

- Addition of text equivalent to all graphics
- Usage of standard fonts and avoiding shadow or reversed text
- Usage of strong foreground and background color contrast
- Color usages as per Oracle Accessibility guidelines have been ensured
- Usage of styles and formatting elements
- Documentation in simple language to ensure easy understanding
- Including accurate and effective navigational features, such as cross-reference, tables of content and bookmarks as appropriate.

2

Administration System

In **Administration > System**, you can record setup data related to the application's overall functionality and performance. This data affects;

- The mechanics of the system
- The processes of the system
- The search for Location of files to complete the tasks.

Navigating to Administration System

On the Oracle Financial Services Lending and Leasing home screen, click **Setup > Setup > Administration > System**

The **System** drop-down link records the following data. Using the below screens, you can control the behavior of the system from a technical perspective. For example, determine parameter values, define what information is audited, and record default values. However, note that the product provides default values for parameters in all these screens.

- [System Parameters](#)
- [Lookups](#)
- [User Defined Tables](#)
- [Audit Tables](#)
- [User Defined Defaults](#)
- [User Defined Parameters](#)
- [Transaction Codes](#)
- [Data Files](#)
- [Events](#)
- [Batch Jobs](#)
- [Producer Cycles](#)
- [Vendors](#)
- [Reports](#)
- [Error Messages](#)
- [Translation](#)
- [Label Configuration](#)
- [Seed Data](#)
- [Data Masking](#)
- [Webhook](#)

2.1 System Parameters

System parameters define information or values used throughout the system. They act as switches that control the manner in which a function is implemented, or whether or not the system performs a particular task. Parameters are used throughout the system to control everything from user access to what information is stored on any given form. Parameters also define configuration data, such as the location of the system files, the URLs for the report and image servers, and other administration controlled data. Some of the system parameters are setup when the system is installed, but the values associated with the parameters need to be reviewed and maintained.

There are three types of parameters in the system, grouped by what part of the system they affect:

Table 2-1 Types of Parameters

Parameter Type	Parameter Range
System parameters	These parameters apply to the entire system. Examples: batch processes, archiving, aging.
Organization parameters	These parameters apply to the organization, division, and user responsibility. Examples: User login control, password expiration.
Company parameters	These parameters apply to the company and branch. Examples: decision fax control, scoring model.

Hence, the System Parameters screen contains the following three tabs:

- [System Parameters Setup](#)
- [Organization Parameters](#)
- [Company Parameters](#)

2.1.1 System Parameters Setup

The System Parameters Setup screen displays and records each system wide parameter, along with its current value and whether or not it is enabled. These parameters relate to the overall processing of the system, such as application server file locations and data purging configuration.

Note

You can only define these parameters. Changing the values of any of these parameters affects the related processing.

To set up the System Parameters

1. Click **Setup > Setup > Administration > System > System Parameters > System**. The system displays the **System Parameter** screen.
2. In the **System Parameters** section, perform any of the [Basic Operations](#) mentioned in Navigation chapter.

Figure 2-1 System Parameters

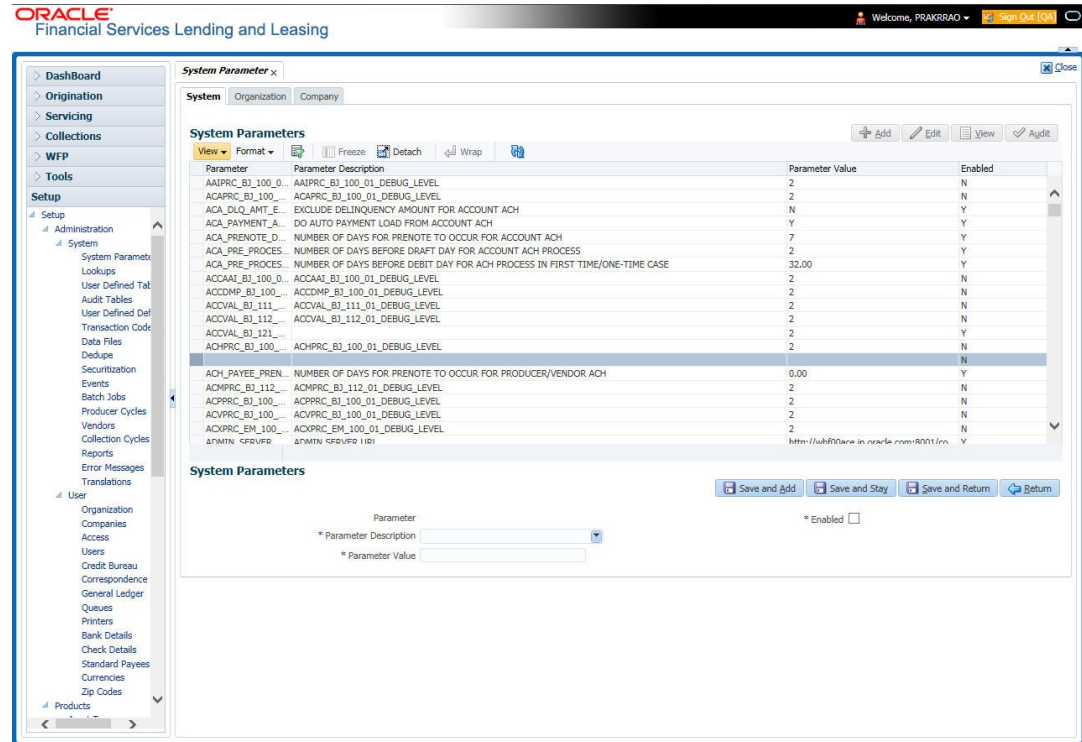

A brief description of the fields is given below:

Table 2-2 System Parameters setup

Parameter Type	Parameter Range
Parameter	System parameter of the specified parameter description is displayed here.
Parameter Description	Select the description of system parameter from the drop-down list.
Parameter Value	Specify the value for the system parameter (required).
Enabled	Check this box to enable the parameter.

3. Perform any of the [Basic Actions](#) mentioned in Navigation chapter.

For a detailed list of available parameters, refer to Appendix [System Parameters](#) chapter.

This section consists of the following topic:

- [FCUBS Integration](#)

2.1.1.1 FCUBS Integration

Oracle Financial Services Lending and Leasing (OFSL) is integrated with Oracle FLEXCUBE Universal Banking System (FCUBS) with the capability to integrate the centralized CIF (Customer Information Files), ELCM (Enterprise Limits and Collateral Management) and CASA (Current Account and Savings Account) modules.

To work with the integrated environment functionalities, you need to enable the following core banking indicator.

Table 2-3 FCUBS Integration

Parameter	Parameter Description
CMN_CORE_BANK	CORE BANKING INTERFACE INDICATOR

Note

Re-qualification is pending for Core and Direct Banking Integration.

For detailed information about integration changes, you can refer to 'FCUBS Integration Documents' section at OTN library (http://docs.oracle.com/cd/E59770_01/homepage.htm).

2.1.2 Organization Parameters

The Organization parameters control the system functions related to user log in, such as passwords and expiration dates, responsibility levels and the ability to access the system features. Individual parameters can be created with different values for uniquely defined organizations, divisions, and responsibility combinations.

When determining which parameter to use, the system selects the best match based on a hierarchical sort by the Organization, Division, and Responsibility fields, with values of ALL being a lower order match than an exact match.

For example:

Assume the organization parameter `UIX_APP_VIEW_ALL_APPS` (VIEW ALL APPLICATIONS) is as follows:

- If a user belongs to an organization as **DMC** with a responsibility of SUPERUSER and is using the Underwriting screen of Lending menu, the system will return with a value N, and the system will not allow the user to view all applications.
- If the user belongs to any organization with a responsibility of SUPERUSER, and is using the Underwriting screen of Lending menu, the system will return with a value Y, and the system will allow the user to view all applications.

Note

Be aware that while the system allows for Organization parameters to be defined at all three hierarchical (organization, division, and responsibility) levels, not all will be applicable to each parameter. For example, while you can define the `UIX_SMTP_SERVER` (EMAIL SERVER FOR USER) for a responsibility, you would normally want only to define this parameter based on organization or division.

To set up the Organization Parameters

1. Click **Setup > Setup > Administration > System > System Parameters > Organization** tab.
2. In the **Organization Parameters** section, perform any of the [Basic Operations](#) mentioned in Navigation chapter.

Figure 2-2 Origination System Parameters Setup

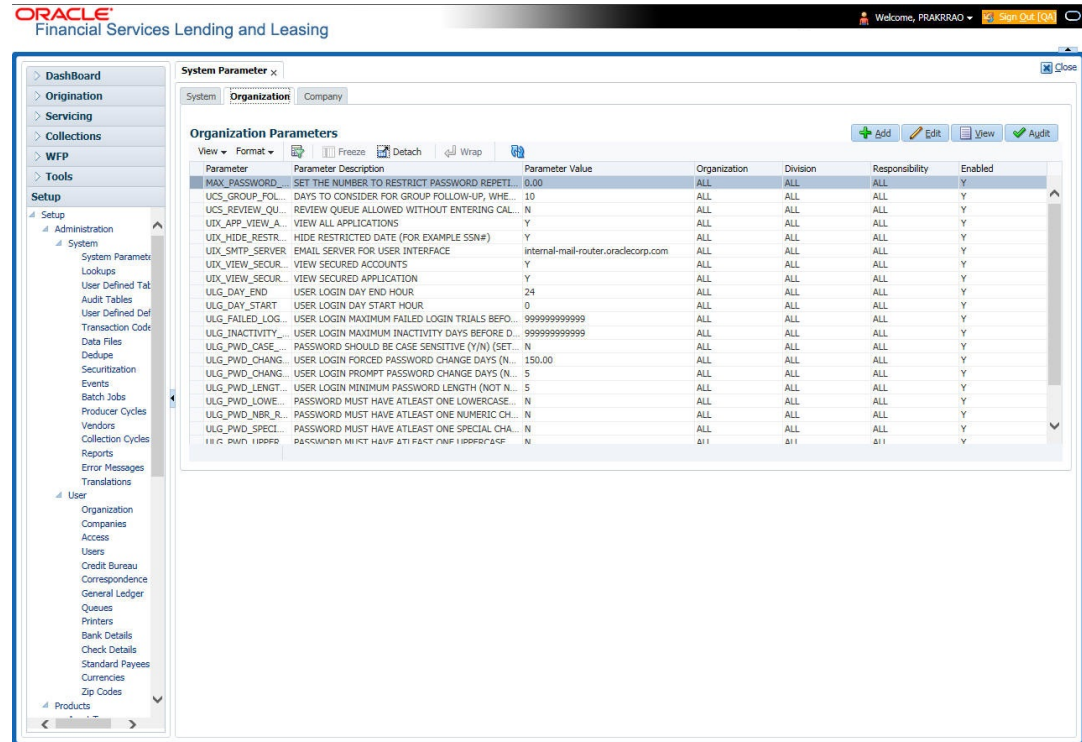

A brief description of the fields is given below:

Table 2-4 Organization Parameters

Field	Do this
Parameter	Parameter of the specified parameter description is displayed here.
Parameter Description	Select the description of system parameter from the drop-down list.
Parameter Value	Specify the value for the system parameter.
Organization	Select the organization for which the parameter will be valid from the drop-down list.
Division	Select the department for which the parameter will be valid from the drop-down list.
Responsibility	Select the responsibility for which the parameter will be valid from the drop-down list. IMPORTANT: In selecting which organization parameter to use, the system searches for a best match using the following attributes: 1. Organization 2. Division 3. Responsibility

Hence, Oracle Financial Services Software recommends creating a version of each organization parameter, where ALL is these fields.

Table 2-4 (Cont.) Organization Parameters

Field	Do this
Enabled	Check this box to enable the parameter.

3. Perform any of the [Basic Actions](#) mentioned in Navigation chapter.

For a detailed list of available parameters, refer to Appendix [System Parameters](#) chapter.

2.1.3 Company Parameters

The Company parameters control the system processes associated with functions that may vary for different companies or branches. These parameters address credit scoring, credit bureau interfaces, fax services, and fax generation. Individual parameters may be set up with different values for uniquely defined company and branch combinations.

When these parameters values are requested by the system, the system responds with the **best** match based on a hierarchical sort ordered on company and branch fields, with values of ALL being a lower order match than an exact match. For example, assume the company parameter UIX_RUN_AAI_ACT (ONLINE ACCOUNT CREATION AND ACTIVATION) has been defined as:

The system uses these two parameters to determine whether to create and activate an account online.

- When processing items for the company US01, the system will return a value N and not create and activate an account online.
- When processing items for the company other than US01 and within the value ALL, the system will return with a value Y and create and activate an account online.

To set up the Company Parameters

1. Click **Setup > Setup > Administration > System > System Parameters > Company** tab.
2. On the Company Parameters screen, perform any of the [Basic Operations](#) mentioned in Navigation chapter.

Figure 2-3 Company Parameters

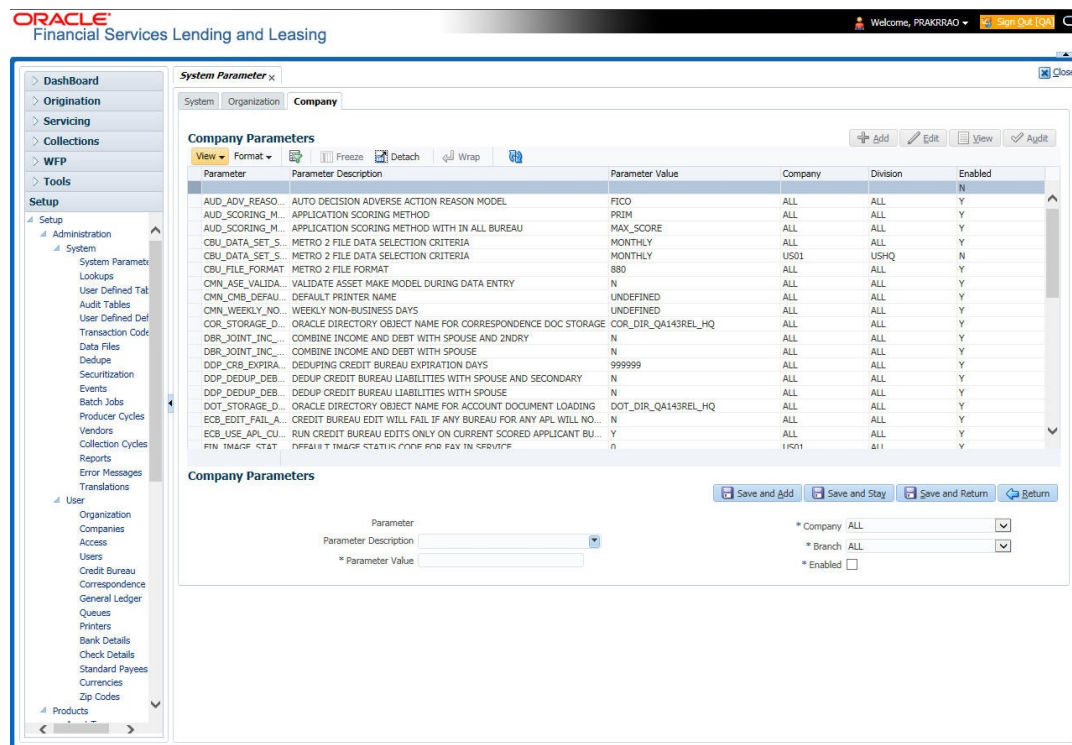

A brief description of the fields is given below:

Table 2-5 Company Parameters setup

Field	Do this
Parameter	The system displays the parameter, when you select parameter description.
Parameter Description	Select the description of system parameter from the drop-down list.
Parameter Value	Specify the value for the system parameter.
Company	Select the portfolio company for which the parameter will be valid from drop-down list.
Branch	Select the portfolio branch for which the parameter will be valid from the drop-down list (required). IMPORTANT: In selecting which company parameter to use, the system searches for a best match using the following attributes: 1. Company 2. Branch For this reason, the Software recommends creating a version of each company parameter where ALL is the value in these fields.
Enabled	Check this box to enable the parameter.

3. Perform any of the [Basic Actions](#) mentioned in Navigation chapter.

For a detailed list of available parameters, refer to Appendix [System Parameters](#) chapter.

2.2 Lookups

The Lookups setup screen defines the contents in many drop-down fields used throughout the system. Fields that make use of drop-down field will accept only entries that are stored on this screen.

The Lookups screen contains two sections: **Lookup Types** and **Lookup Codes**. Lookup types and codes can be system-defined or user-defined. The lookup types describe the function of the related lookup codes.

For system-defined lookup types, only the Description field may be changed.

A system-defined lookup type (**Lookup Types** block, **System Defined** is selected) is one that is critical to the system and cannot be changed. However, you can still modify the lookup type description and Record indicator (Enabled/Disabled).

A user-defined lookup type (**Lookup Types** block, **System Defined** is not selected) is one that can be modified, depending on a user's business needs. You can modify the description, system indicator and record indicator. If a lookup type is user-defined, the lookup code belonging to that lookup type can either be system-defined or user-defined.

A system-defined lookup code (**Lookups** screen, **System Defined** is selected) is one on which the system processing is dependent. Without this lookup code, the process produces incorrect results or fails.

A user-defined lookup code (**Lookups** screen, **System Defined** is not selected) is one that can be defined or altered by a user.

WARNING: System-defined lookup types are those that are required by the system. Their related lookup codes will also be system defined. If you update and save a user-defined lookup type as a system-defined-lookup type (that is, change the System Defined button from **No** to **Yes** in the Lookup Type sub screen), the system will not allow you to change the lookup type back to user-defined in the future.

Note

Lookup codes cannot be deleted, as they may have been used in the past, and the display and processing of that data is still dependent on the existing setup.

Typically, the system Administrator would modify the descriptions of lookup codes and add new lookup codes to the existing lookup types as needed.

To set up the Lookups

1. Click **Setup > Setup > Administration > System > Lookups**. The system displays the **Lookups** screen. The details are grouped into two:
 - Lookup Types
 - Lookup Codes
2. In the **Lookup Types** section, perform any of the [Basic Operations](#) mentioned in Navigation chapter.

Figure 2-4 Lookups

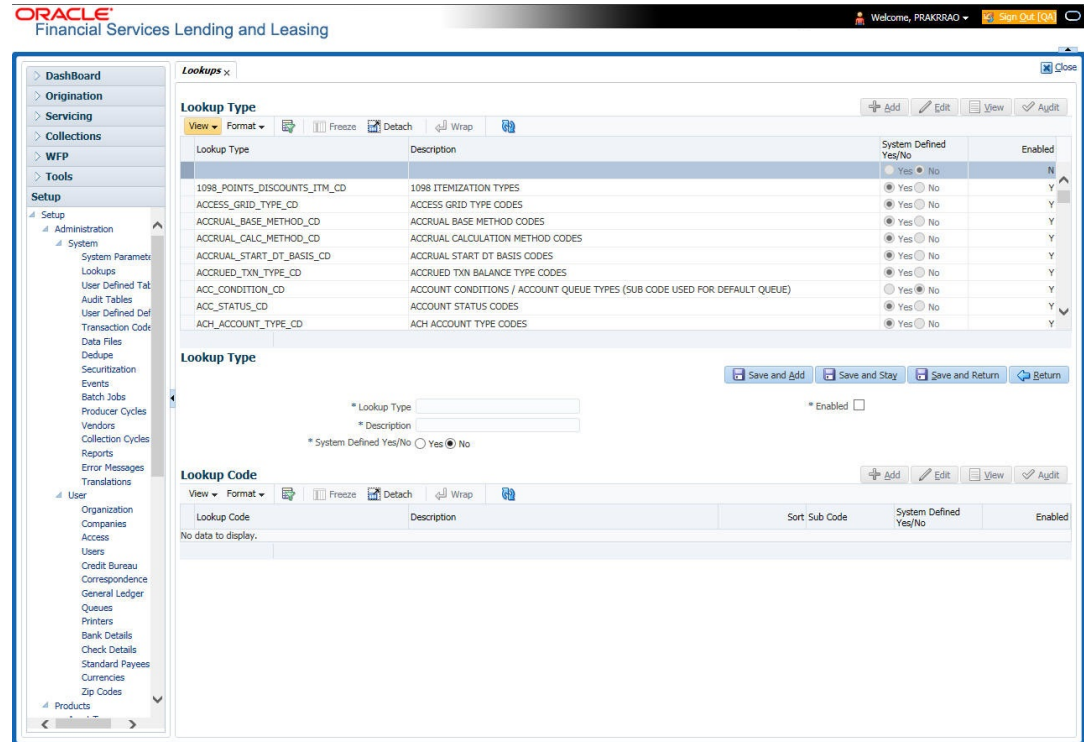

A brief description of the fields is given below:

Table 2-6 Lookups setup

Field	Do this
Lookup Type	Specify the lookup type.
Description	Specify the description for the lookup type.
System Defined Yes/No	Select Yes , if you wish to maintain the lookup type as system defined and No , if you wish to maintain lookup type as User defined.
Enabled	Check this box to enable the lookup type.

3. Perform any of the [Basic Actions](#) mentioned in Navigation chapter.
4. In the **Lookup Codes** section, you can setup individual codes that a field or process using the related lookup type can have. Perform any of the [Basic Operations](#) mentioned in Navigation chapter.

A brief description of the fields is given below:

Table 2-7 Lookup Codes

Field	Do this
Lookup Code	Specify the lookup code. These are solely dependent on the function of the Lookup Type.
Description	Specify the lookup code description. This may be changed as per your business requirement.

Table 2-7 (Cont.) Lookup Codes

Field	Do this
Sort	Specify the sort order for the lookup code. This determines the order these lookup codes are displayed or processed.
Sub Code	Specify the sub code for the lookup code.
System Defined Yes/No	Select Yes , if you wish to maintain the lookup code as system defined and No , if you do not want to maintain it as system defined. System defined lookup codes cannot be modified, except for changing the Description or Sorting fields. If the lookup type is not system defined, then the code can be modified.
Enabled	Check this box to enable the lookup code.

5. Perform any of the [Basic Actions](#) mentioned in Navigation chapter.

2.3 User Defined Tables

In User Defined Tables you can maintain user-defined tables, such as the data attributes the system uses on its Search screens.

In the following example, the list of attributes in the Criteria column are computed from the User Defined Tables screen.

To set up a user-defined table, you must:

1. Define the fields on the table.
2. Join the related tables.
3. Assign the table a lookup type.

You can create tables for different products, funding, and collateral types.

After creating the user-defined tables, the system sorts the attributes to make the system usage more efficient. These details are used with different functions of the system, including:

- Tracking follow-up items
- Creating details in bankruptcy, foreclosure/repossession, and deficiency

Note

Many of these tables, (ASSET TRACKING ATTRIBUTES for example) may be configured during the initial setup of the application to provide for your specific business needs. Others, such as APPLICATION SEARCH, may be changed whenever your business needs change. Still others should not be changed without consulting Oracle Financial Services Software, as changing them would require changes to existing code for the expected results to be implemented. As a thumb rule, it is better to add or disable information on the User Defined Tables screen than to edit existing entries.

To set up the User Defined Tables

1. Click **Setup > Setup > Administration > System > User Defined Tables**. The system displays the User Defined Tables screen. The details are grouped into two:

- User Defined Tables
 - User Defined Table Attributes
2. In the **User Defined Tables** section, perform any of the [Basic Operations](#) mentioned in Navigation chapter.

Figure 2-5 User Defined Tables

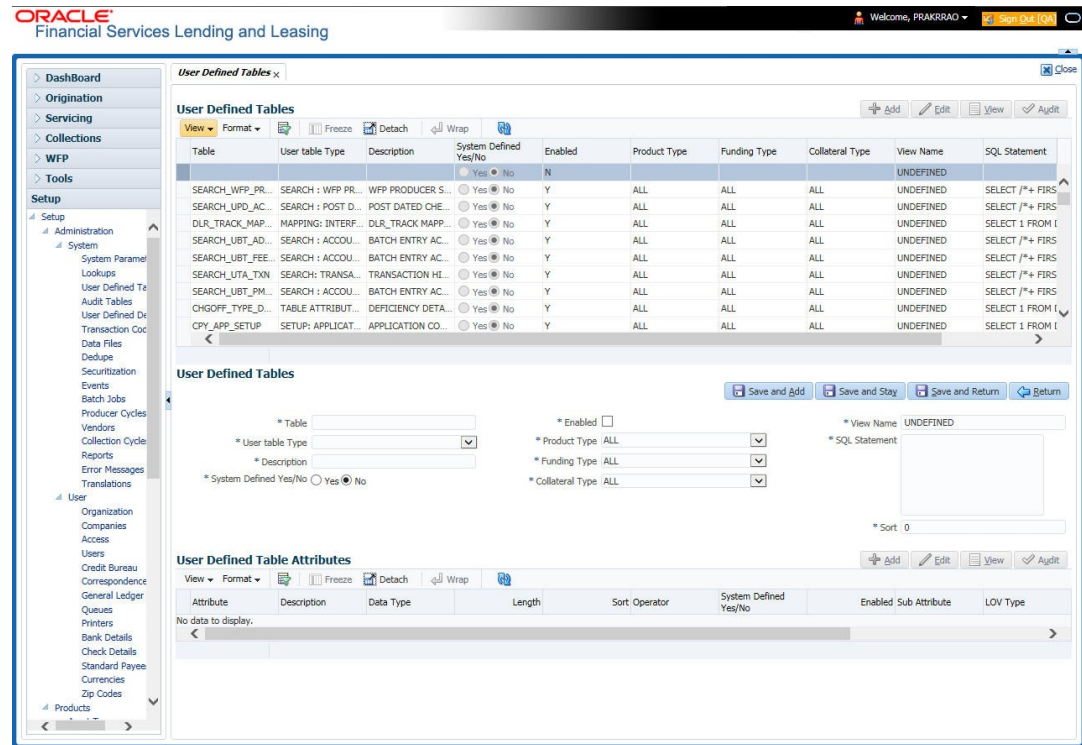

A brief description of the fields is given below:

Table 2-8 User Defined Tables

Field	Do this
Table	Specify the user-defined table name.
User Table Type	Select the user-defined table type from the drop-down list. This determines where and how the related data is being used.
Description	Specify the description for user-defined table.
System Defined Yes/NO	Select Yes , if you wish to maintain the User table type as system defined and No , if you do not want to maintain it as system defined. System defined entries cannot be modified. If the entry is not system defined, then it can be modified.
Enabled	Check this box to enable the user-defined table (optional).
Product Type	Select the product type from the drop-down list.
Funding Type	Select the funding type associated with the user-defined table from the drop-down list.

Table 2-8 (Cont.) User Defined Tables

Field	Do this
Collateral Type	Select the collateral type associated with the user-defined table from the drop-down list.
View Name	Specify the view name.
SQL Statement	Specify the SQL version of the statement. For Example: For SEARCH_ACC_ACCOUNTS table, the SQL is as follows: SELECT /*+ FIRST_ROWS */ ACC_AAD_ID FROM ACCOUNTS WHERE Note: For the above SQL, the where criteria is part of the User Defined Table Attributes
Sort	Specify the sort order for the user-defined table relative to other tables of the same type.

3. Perform any of the [Basic Actions](#) mentioned in Navigation chapter.
4. In the **User Defined Table Attributes** section, perform any of the [Basic Operations](#) mentioned in Navigation chapter.

Figure 2-6 User Defined Table Attributes

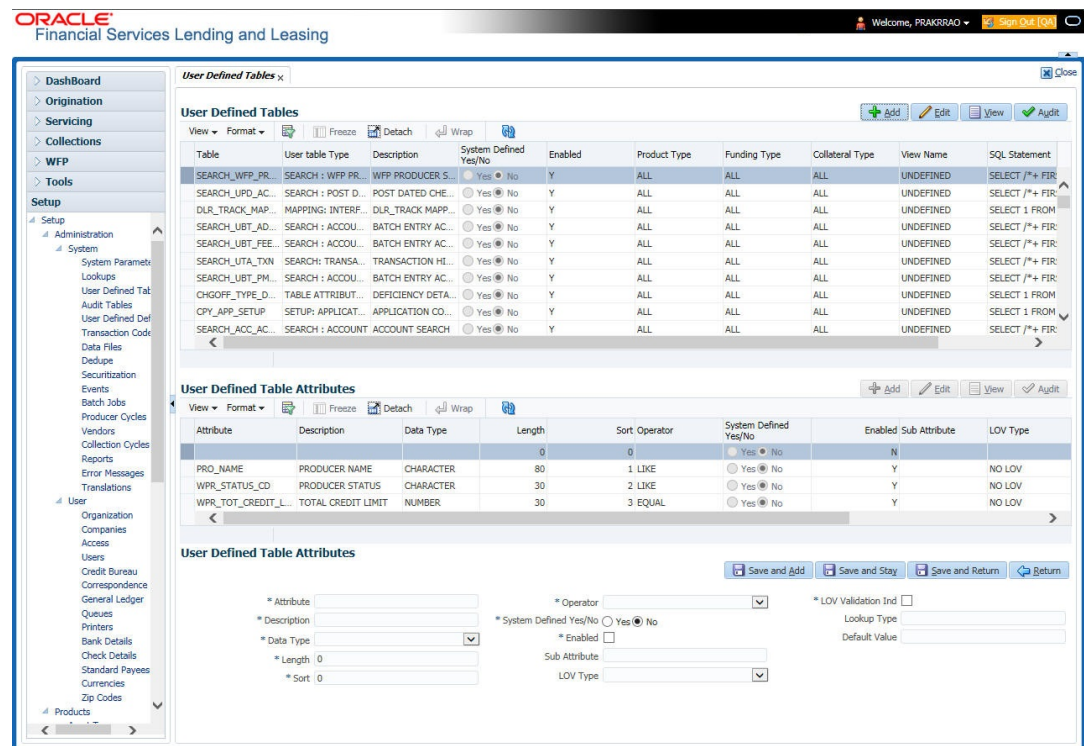

A brief description of the fields is given below:

Table 2-9 User Defined Table Attributes

Field	Do this
Attribute	Specify the user-defined table attribute.
Description	Specify the description for the user-defined table attribute.
Data Type	Select the data type for the attribute (CHARACTER, NUMBER, or DATE) from drop-down list.
Length	Specify the maximum length of the user-defined table attribute.
Sort	Specify the sort order of the user-defined table attribute. If the sort order is changed it will only affect new instances of the User Defined Table, and will not affect existing data.
Operator	Select the operator for the user-defined table attribute from the dropdown list.
System Defined Yes/No	Select Yes , if you wish to maintain the User table attribute as system defined and No , if you do not want to maintain it as system defined. System defined entries cannot be modified. If the entry is not system defined, then it can be modified.
Enabled	Check this box to enable the user-defined table attribute so that the attribute will be considered when creating new instances of the User Defined Table.
Sub Attribute	Specify the sub-attribute for the attribute (sub attributes are used to associate related attributes).
LOV Type	Select the list of value (LOV) type for the user-defined table attribute from the drop-down list.
LOV Validation Ind	Check this box to enable LOV validation of the user-defined table attribute. This indicates whether the data must come from the LOV.
Lookup Types	Specify the lookup type of the LOV associated with the user-defined table attribute.
Default Value	Specify the default value for the user-defined table attribute.

5. Perform any of the [Basic Actions](#) mentioned in Navigation chapter.

2.4 Audit Tables

The system allows you to track changes in the database during line of credit origination. This includes the tracking of:

- Application status history
- Audit history of specified fields

The Audit Tables Setup screen records the tables and columns requiring an audit. the system stores the following details for the fields you want to audit for changes:

- Current value in field
- New value field
- User who changed the field's content

- Date and time when the value was changed

IMPORTANT: The system recommends that only a database administrator perform the following steps.

To set up the Audit Tables

1. Click **Setup > Setup > Administration > System > Audit Tables**. The system displays the Audit Tables screen. The details are grouped into two:
 - Audit Tables
 - Audit Columns
2. In the **Audit Tables** section, perform any of the [Basic Operations](#) mentioned in Navigation chapter.

Figure 2-7 Audit Tables

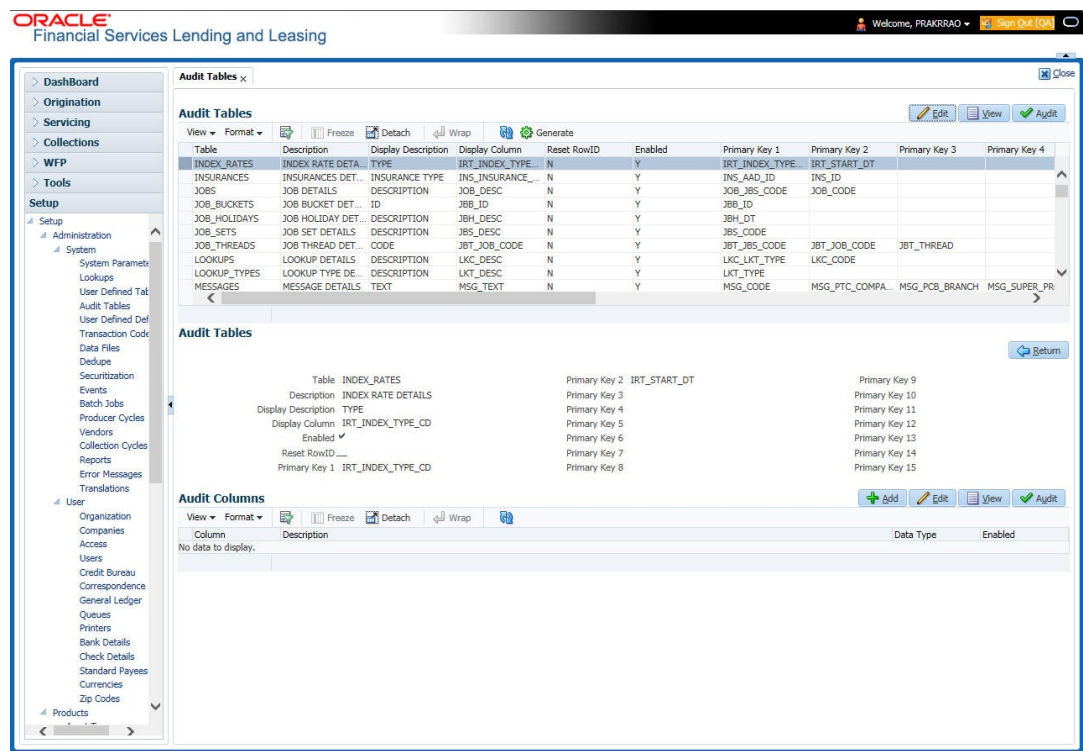

A brief description of the fields is given below:

Table 2-10 Audit Tables

Field	Do this
Table	The table name on which audit trigger needs to be created is displayed here (the system table being audited).
Description	Specify the table description.
Display Description	Specify the column description to be displayed on audit screen.

Table 2-10 (Cont.) Audit Tables

Field	Do this
Display Column	Select the table column to be displayed on audit screen from the drop-down list.
Enabled	Check this box to enable the audit table so that it will be considered while generating the database triggers.
Reset Row ID	Check this box to allow resetting the row identifier.
Primary Key 1 (unlabeled)	The table primary key column 1 is displayed here. (These columns define how to access the data in the table.)
Primary Key 2 (unlabeled)	The table primary key column 2 is displayed here.
Primary Key 3 (unlabeled)	The table primary key column 3 is displayed here.
Primary Key 4 (unlabeled)	The table primary key column 4 is displayed here.
Primary Key 5 (unlabeled)	Table primary key column 5 is displayed here.
Primary Key 6 (unlabeled)	Table primary key column 6 is displayed here.
Primary Key 7 (unlabeled)	The table primary key column 7 is displayed here.
Primary Key 8 (unlabeled)	The table primary key column 8 is displayed here.
Primary Key 9 (unlabeled)	The table primary key column 9 is displayed here.
Primary Key 10 (unlabeled)	The table primary key column 10 is displayed here.
Primary Key 11 (unlabeled)	The table primary key column 11 is displayed here.
Primary Key 12 (unlabeled)	The table primary key column 12 is displayed here.
Primary Key 13 (unlabeled)	The table primary key column 13 is displayed here.
Primary Key 14 (unlabeled)	The table primary key column 14 is displayed here.
Primary Key 15 (unlabeled)	The table primary key column 15 is displayed here.

3. Perform any of the [Basic Actions](#) mentioned in Navigation chapter.
4. In the **Audit Tables Columns** section, perform any of the [Basic Operations](#) mentioned in Navigation chapter.
A brief description of the fields is given below:

Table 2-11 Audit Tables Columns

Field	Do this
Column	Specify the column name on which the audit needs to be created from drop-down list (column in the table that is being audited)
Description	Specify the column description (description of the data contained in the column).

Table 2-11 (Cont.) Audit Tables Columns

Field	Do this
Data Type	The data type for the attribute is displayed here.
Enabled	Check this box to enable the audit column.

5. Perform any of the [Basic Actions](#) mentioned in Navigation chapter.
6. Once the required fields data is created or updated, click **Generate** in Audit Tables section to initiate a trigger to update the details in the system.

2.5 User Defined Defaults

The User Defined Defaults Setup screen allows you to set up default values to automatically populate in frequently used fields on the Application Entry screen. This streamlines the data entry process when entering an application.

To set up the User Defined Defaults

1. Click **Setup > Setup > Administration > System > User Defined Defaults**. The system displays User Defined Defaults screen.
2. In the **Application Defaults** section, perform any of the [Basic Operations](#) mentioned in Navigation chapter.

Figure 2-8 Application Defaults

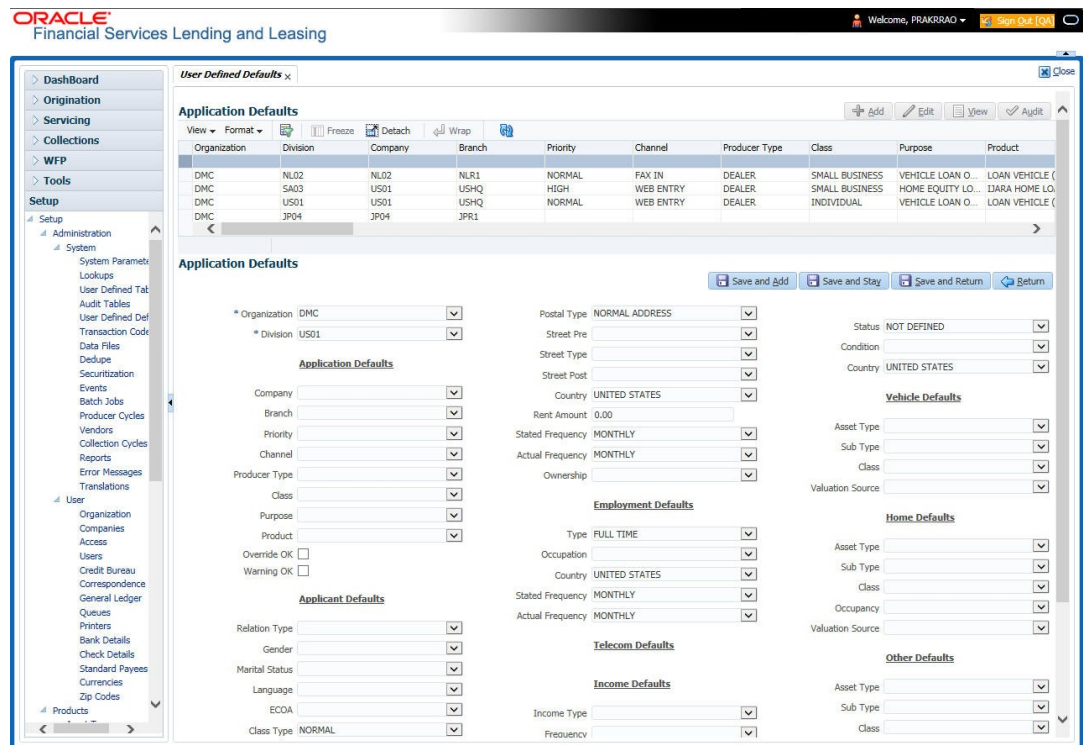

A brief description of the fields is given below:

Table 2-12 Application Defaults

Field	Do this
Org	Select the organization for which these defaults are applicable from drop-down list.
Division	Select the division for which these defaults are applicable from dropdown list.
Application Defaults	
Company	Select the company from the drop-down list.
Branch	Select the branch from the drop-down list.
Priority	Select the priority from the drop-down list.
Channel	Select the channel from the drop-down list.
Producer Type	Select the producer type from the drop-down list.
Purpose	Select the purpose from the drop-down list.
Product	Select the product from the drop-down list.
Applicant Defaults	
Relation Type	Select the applicant relation type from the drop-down list.
Gender	Select the applicant gender from the drop-down list.
Marital Status	Select the applicant marital status from the drop-down list.
Language	Select the applicant language from the drop-down list.
ECOA	Select the applicant ecoa from the drop-down list.
Class Type	Select the applicant class type from the drop-down list.
Race National Origin	Select the applicant race or national origin from the drop-down list.
Privacy Opt-Out	Check this box to indicate that the applicant has elected to refrain from the non-public sharing of information.
Address Defaults	
Address Type	Select the address type from the drop-down list.
Postal Type	Select the postal address type from the drop-down list
Street Pre	Select the street pre type from the drop-down list.
Street Type	Select the street type from the drop-down list.
Street Post	Select the street post type from the drop-down list.
Country	Select the country from the drop-down list.
Rent Amount	Specify the rent amount. The system defaults this rent amount if the rent amount received from the interface is zero. This rent amount will be defaulted for a new application also.
State Frequency	Select the stated frequency from the drop-down list.
Actual Frequency	Select the actual frequency from the drop-down list.

Table 2-12 (Cont.) Application Defaults

Field	Do this
Ownership	Select the ownership type from the drop-down list.
Employment Defaults	
Type	Select the employment type from the drop-down list.
Occupation	Select the occupation from the drop-down list.
Country	Select the country from the drop-down list.
Stated Frequency	Select the stated frequency from the drop-down list.
Actual Frequency	Select the actual frequency from the drop-down list.
Income Defaults	
Income Type	Select the income type from the drop-down list.
Frequency	Select the frequency from the drop-down list.
Liability Defaults	
Liability Type	Select the liability type from the drop-down list.
Frequency	Select the frequency from the drop-down list.
Asset Defaults	
Status	Select the asset status from the drop-down list.
Condition	Select the asset condition from the drop-down list.
Country	Select the country from the drop-down list.
Vehicle Defaults	
Asset Type	Select asset type from the drop-down list.
Sub Type	Select asset sub type from the drop-down list.
Class	Select the asset class from the drop-down list.
Valuation Source	Select the asset valuation source from the drop-down list.
Home Defaults	
Asset Type	Select asset type from the drop-down list.
Sub Type	Select asset sub type from the drop-down list.
Class	Select the asset class from the drop-down list.
Occupancy	Select the occupancy type from the drop-down list.
Valuation Source	Select the asset valuation source from the drop-down list.
Other Defaults	
Asset Type	Select asset type from the drop-down list.
Sub Type	Select asset sub type from the drop-down list.
Class	Select the asset class from the drop-down list.
Valuation Source	Select the asset valuation source from the drop-down list.
Comment Defaults	
Comment Type	Select the comment type from the drop-down list.
Comment Sub Type	Select the comment sub type from the drop-down list.

3. Perform any of the [Basic Actions](#) mentioned in Navigation chapter.

2.6 User Defined Parameters

The User Defined Parameters setup screen facilitates to define field-level configurations which helps to perform various day to day business specific calculations. In this screen you can define parameters and logic for each field to compute and populate data.

For example, you can setup User Defined Parameters in the system to calculate Trade Equity, Collateral Coverage Ratio, Net Rental Yield and so on.

Note

Currently system supports defining user defined parameters for entities like Account and Collateral. The computed values are populated into Customer Service > Account Details > Account Information section and Servicing > Collateral Management > Collateral Details screen respectively on clicking Calculate Parameters button.

Defining user defined parameters basically involves identifying a scenario and creating/configuring the required parameters. Here, a scenario can refer to what category of accounts are to be considered for computation.

User defined parameters consists of the following two types of configurable parameters:

Table 2-13 Types of configurable parameters

Parameter	Description
Target Parameters	<p>These parameters store values for the customizable user defined fields in user defined tables and is used for calculation based on Selection Criteria.</p> <p>These parameters are available as per the View Name defined in user defined tables for each Account and Collateral Entity and persist the calculation values into the table columns of database after its first execution.</p>
Formula Parameters	<p>These parameters are used for computation of the target parameters. These contain the generic formula/logic that can be used for any computation based on System Defined Functions and Table Columns. These parameters does not persist the calculation values into the table columns of database.</p>

Since system supports Account and Collateral entity types, the configurable user defined Target/Formula parameters along with selection criteria can be defined using specific table type as indicated below:

Table 2-14 Account and Collateral entity types

Entity Type	Parameter Type	Description
Accounts	Formula Parameters	<p>Formula parameters are used for computation of the target parameters for Account Entity.</p> <p>OFSLL supports predefined set of calculation based Formula Parameters. These parameter definitions start with \$ in User Defined Tables.</p> <p>These parameters does not have any selection criteria.</p> <p>Existing factory shipped seed data provided by OFSLL product like GL date, System Date, ACC_DLQ_DAYS and so on is based on below User Defined Table Type:</p> <p>USER DEFINED: ACCOUNTS FORMULA PARAMETERS</p> <p>USER DEFINED: COMMON FORMULA PARAMETERS</p> <p>USER DEFINED: COMMON CUSTOMER SERVICE FORMULA PARAMETERS</p>
	Target Parameters	<p>These calculations are based on formula parameters and other target parameters.</p> <p>A selection criteria is available for each calculation.</p> <p>These are based on User Defined Table Type: USER DEFINED: ACCOUNT TARGET PARAMETERS</p>
	Selection Criteria	<p>These parameters define the criteria on which accounts are picked for calculation of defined target parameters.</p> <p>These are available only for Target parameters and are based on User Defined Table Type: USER DEFINED: ACCOUNT CRITERIA PARAMETERS</p>

Table 2-14 (Cont.) Account and Collateral entity types

Entity Type	Parameter Type	Description
Collateral	Formula Parameters	These Formula parameters are used for computation of the target parameters for Collateral Entity. They are based on below User Defined Table Type: USER DEFINED: COLLATERAL FORMULA PARAMETERS USER DEFINED: COMMON FORMULA PARAMETERS USER DEFINED: COMMON CUSTOMER SERVICE FORMULA PARAMETERS
	Target Parameters	These are based on User Defined Table Type: USER DEFINED: COLLATERAL TARGET PARAMETERS
	Selection Criteria	These are available only for Target parameters and are based on User Defined Table Type: USER DEFINED: COLLATERAL CRITERIA PARAMETERS

Note

The execution of User Defined Parameters require additional processing at the server level and can have significant performance impact delaying the EOD processing. Hence it is recommended to have careful consideration while defining the Target and Formula parameter configurations.

In this framework, you can either create new parameters and/or use the available pre-defined formula parameters to populate computed values to custom user defined fields.

For example - a formula parameter can be defined with an expression as `*$TOTAL_ITM_GRP_IEQ + $PAID_BAL_ADV` which is total equity in itemizations on account added with total advance amount paid. An expression can have a stored function (represented with \$ sign) and Account Columns (fields).

There are some formula parameters in the system with basic pre-defined calculation which can readily be used for configuration along with account fields. Pre-defined formula parameters are associated with specific acronyms appended with parameter name for identification. The table below lists the available pre-defined formula parameters. However, you can also define custom formula parameters with acronyms.

Table 2-15 Pre-defined formula parameters

User Defined Column Description	Description
<code>\$GL_DATE</code>	Value of GL Date System Parameter
<code>\$SYSTEM_DATE</code>	Current System Date

Table 2-15 (Cont.) Pre-defined formula parameters

User Defined Column Description	Description
\$COLLATERAL_VALUE	Sum of all collateral current valuation
\$PRIMARY_COLLATERAL_VALUE	Sum of all primary collateral current valuation
\$ASE_GRAND_FATHER_POINTS	Sum of all grandfather points
\$ASE_TIER_POINTS	Total Tier Points
\$INTEREST_ACCRUED	Interest Accrued on Account for a specific date. This is used to calculate Trade Equity Calculation.
\$OUTSTANDING_AMOUNT	Current Account Outstanding Amount
\$OUTSTANDING_BAL_ (BALANCE TYPE *)	This is a dynamic balance value calculation based on type variable. For example: <ul style="list-style-type: none"> \$OUTSTANDING_BAL_ADV - Will calculate outstanding Advance/Principal amount
\$PAID_BAL_(BALANCE TYPE *)	This is a dynamic balance value calculation based on type variable. For example: <ul style="list-style-type: none"> \$PAID_BAL_ADV - Will calculate paid Advance/ Principal amount
\$SUM_PRIN_ESC_MAX_EXPIRY_DT	This is used to calculate sum of total principal amount till Extended Service Warranty Max Expiry Date.
\$TOTAL_ITM_GRP_ (ITM GROUP*)	This is a dynamic itemization group value calculation based on type variable. For example: <ul style="list-style-type: none"> \$TOTAL_ITM_GRP_IDC - Will calculate total ITM DOWN PAYMENT CASH group amount \$TOTAL_ITM_GRP_IPF - Will calculate total ITM PREPAID FEE group amount
\$TOTAL_ITM_ (ITM*)	This is a dynamic itemization value calculation based on type variable. For example: <ul style="list-style-type: none"> \$TOTAL_ITM_IDC_1 - Will calculate total ITM DOWN PAYMENT amount \$TOTAL_ITM_IUN_4 - Will calculate total ITM CASH DOWN amount

Both the parameters (formula and target) supports the following data types:

- Number / Integer (both are considered as floating numbers)
- Date
- Character

While defining specific parameter, system auto-filters the variable list based on the supported data type.

To enable any target parameters, ensure that there is at the least one enabled formula parameter and selection criteria defined. Also while defining target parameters, ensure that there is no circular dependency where two or more parameters are either directly or indirectly dependent on each other. For example, If formula parameter A is defined as ACC_FIELD1 + formula parameter B, and formula parameter B is defined as ACC_FIELD2 + formula

parameter A. In such a case, system displays an error indicating 'CIRCULAR DEPENDENCY DETECTED FOR PARAMETER:<<PARAMETER NAME>>'.
'.

The user defined parameters calculation can be triggered in any of the following ways:

Table 2-16 User Defined Parameters

Option	Trigger	Action Type
User Interface	<p>Clicking Calculate Parameters button in Account Details screen, Account Information section.</p> <p>Target parameters of Frequency = None and Daily are computed and updated for an account and all collaterals associated to the account.</p> <hr/> <p>Clicking Calculate Parameters button in Collateral Management, Collateral Details screen.</p> <p>Target parameters of Frequency = None and Daily are computed and updated only for the selected collateral.</p>	<p>System calculates and updates target parameter through background job process which is created to update UDP values asynchronously.</p> <p>Error/Validation messages received during calculation of user defined fields are displayed under Background job and not displayed in UI.</p>
Batch Job for Account Target Parameters update	<p>On executing batch jobs - USER DEFINED ROOT BATCH JOB and USER DEFINED ACCOUNT TARGET PARAMETER CALCULATOR in SET-CUP batch job-set</p>	<p>On execution, this batch job calculates all target parameters defined for Account that satisfy the selection criteria.</p> <p>Root batch job is parent batch job and is executed first to pick all accounts eligible for calculation for the child batch job i.e. Account Target Parameter Calculator. This helps to enhance system performance.</p> <p>The batch job periodically calculates for target parameters of frequency other than None and updates the Next Run Date for parameter as per frequency defined.</p> <p>Note that, batch job picks-up accounts only once per day and refers to company specific GL date.</p> <p>Accounts in OFSLL are associated to specific company - branch combination. Hence this batch set and job should be configured at every company branch level.</p>

Table 2-16 (Cont.) User Defined Parameters

Option	Trigger	Action Type
Batch Job for Collateral Target Parameters update	On executing batch jobs - USER DEFINED ROOT BATCH JOB and USER DEFINED COLLATERAL TARGET PARAMETER CALCULATOR in SET-CUP1 batch job-set	<p>On execution, this batch job calculates all target parameters defined for collateral entity that satisfy the selection criteria.</p> <p>Root batch job is parent batch job and is executed first to pick all accounts eligible for calculation for the child batch job i.e. Collateral Target Parameter Calculator. This helps to enhance system performance.</p> <p>The batch job periodically calculates for target parameters of frequency other than None and updates the Next Run Date for parameter as per frequency defined.</p> <p>Note that, batch job picks-up accounts only once per day and refers to company = ALL GL date. Collateral in OFSLL are not associated to any specific company hence this batch set and job should be configured for company = All.</p>
Event	<p>Configured Event Action Type -</p> <ol style="list-style-type: none"> 1. UPDATE ACCOUNT USER DEFINED PARAMETERS 2. UPDATE COLLATERAL USER DEFINED PARAMETERS <p>For more details on defining event action type, refer to Events (New Framework) section.</p>	<p>Update Account/Collateral Target Parameters of frequency = None and Daily when specific type of changes occurs in OFSLL for Account/Collateral event entity.</p>
Restful Web Service	Calculate Parameter Update Service (available in common Swagger module)	<p>When third-party system post a request to update specific or all Target Parameters for a single Account, single Collateral or all collateral associated to an account based on Entity Type parameter updated in web service request.</p> <p>This parameter accepts only ACC for accounts and ASE for Collateral target parameters. Target parameter of frequency None and Daily are updated through this web service.</p> <p>Refer swagger documentation for more details.</p>

During executing, system looks into the enabled user defined parameters, and considering only those accounts matching the selection criteria, values are computed into the user defined fields.

During computation of target parameters, system displays an error if there are more than one definition defined for a target parameter.

To set up the User Defined Parameters

1. Click **Setup > Setup > Administration > System > User Defined Parameters.**

Figure 2-9 User Defined Parameters Setup

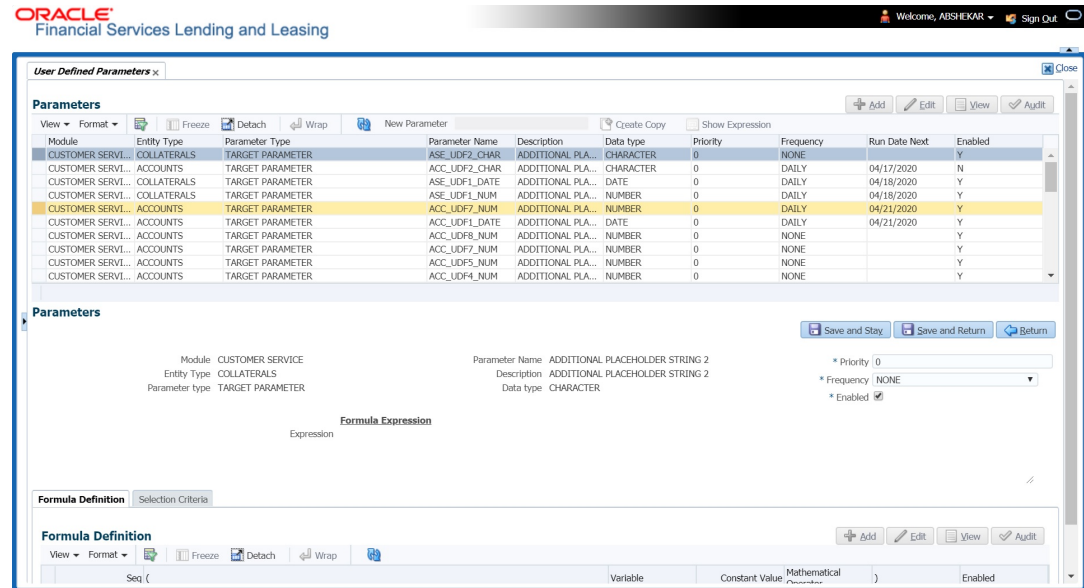

2. In the **Parameters** section, do one of the following:
 - Use the **Create Copy** feature to quickly create new parameter with the existing parameter details. For Target Parameters, select required record and click **Create Copy**. For Formula Parameters, select required record, specify **New Parameter** name and click **Create Copy**. The new parameter created this way will be in disabled state by default.
 - Add/Edit user defined parameter by performing any of the [Basic Operations](#) mentioned in Navigation chapter. A brief description of the fields is given below:

Table 2-17 Parameters section

Field	Do this
Module	Select the module from the drop-down list. The list is displayed based on the modules that support User Defined Parameters calculation. Currently only Customer Serving (accounts) is supported.

Table 2-17 (Cont.) Parameters section

Field	Do this
Entity Type	<p>Select the required entity for which calculation is to be defined from the drop-down list. The list is populated based on entity type maintained in CUP_ENTITY_CD lookup code.</p> <p>Currently, system supports ACCOUNTS and COLLATERALS entity types.</p> <p>Note that, entity can be selected only while creating User Defined Parameter and the same cannot be modified in Edit mode.</p>
Parameter Type	<p>Select the type of parameter to be defined as either Target Parameter or Formula Parameter from the drop-down list.</p>
Parameter Name	<p>For Target Parameter, system displays the list of custom fields available in user defined table for selection. Select the required Parameter from the drop-down list. By default the first field in the user defined table is selected.</p> <p>For Formula Parameter, this is a text field to record the new parameter name. Specify the name of the formula parameter.</p>
Description	<p>For Target Parameter, the description is auto-populated from user defined table and is Read-Only.</p> <p>For Formula Parameter, specify the description of the formula parameter.</p>
Data Type	<p>For Target Parameter, the data type associated for the parameter is auto-populated from user defined table and is Read-Only.</p> <p>For Formula Parameter, select the data type as one of the following from the drop-down list - INTEGER, DATE, NUMBER, or CHARACTER</p>
Priority	<p>Specify the order in which system should evaluate the parameter definitions while executing the batch job or on clicking Calculate Parameters button.</p> <p>For example, if a formula parameter A has dependency on parameter B, then B has to be calculated first in the order and priority is set as 0.</p>

Table 2-17 (Cont.) Parameters section

Field	Do this
Frequency	<p>Select the required frequency at which the target parameters are to be calculated from the drop-down list.</p> <p>Frequency field is applicable only for Target Parameters and the list of frequency supported is populated based on values maintained in CUP_FREQUENCY_TYPE_CD lookup code.</p> <p>Note the following:</p> <ul style="list-style-type: none"> – Frequency can be defined only in Edit mode. – Frequency is not applicable for Formula Parameters. – Frequency None can be selected for target parameters that are required to be calculated on adhoc basis.
Run Date Next	<p>View the date on which the Target parameter is calculated. The Run Date Next is auto calculated based on frequency defined.</p> <p>This field is applicable only for Target parameters and for frequency other than None.</p> <p>Note the following:</p> <ul style="list-style-type: none"> – For multi-company implementation, it is recommended to add same User Defined Parameter definition multiple times for each company. This in-turn updates Run Date Next for each company and supports updating values at different zone based on batch job setup. – Currently the Run Date Next is updated even if not all the records are computed based on selection criteria. Since this impacts to restart failed records, the same shall be addressed in subsequent patch releases.
Enabled	Check this box to enable the parameter definition.

3. Perform any of the [Basic Actions](#) mentioned in Navigation chapter.

This section consists of the following topics:

- [Formula Definition](#)
- [Selection Criteria](#)

2.6.1 Formula Definition

The **Formula Definition** section allows you to define a mathematical expression of the formula to evaluate the parameter definition. The expression may consist of one or more sequenced entries. All arithmetic rules apply to the formula definition. If errors exist in the formula definition, the system displays an error message in this section when you choose Show Expression.

1. In the **Formula Definition** section, perform any of the [Basic Operations](#) mentioned in Navigation chapter.
A brief description of the fields is given below:

Table 2-18 Formula Definition

Field	Do this
Seq	Specify the sequence number (the order in which the formula definition variable will be assembled and evaluated).
(Specify a left bracket, if you need to group part of your formula definition.
Variable	<p>Select the variable from the drop-down list which consists of a validated list derived from user defined table type as indicated below:</p> <ul style="list-style-type: none"> • For Number, system displays only numeric fields • For Date, system displays numeric + date fields • For String, system displays numeric + character fields <p>Parameters for Account entity type in Customer Service is derived from: USER DEFINED: ACCOUNTS FORMULA PARAMETERS USER DEFINED: COMMON FORMULA PARAMETERS USER DEFINED: COMMON CUSTOMER SERVICE FORMULA PARAMETERS</p> <p>Parameters for Collateral entity type in Customer Service is derived from: USER DEFINED: COLLATERAL FORMULA PARAMETERS USER DEFINED: COMMON FORMULA PARAMETERS USER DEFINED: COMMON CUSTOMER SERVICE FORMULA PARAMETERS</p>
Constant Value	<p>Specify the constant value (optional).</p> <ul style="list-style-type: none"> • For Number, system supports only numeric constants • For Date, system supports only numeric constants • For String, system supports both numeric and character constants <p>Note: System displays an error indicating 'VARIABLE OR CONSTANT VALUE IS REQUIRED' if both Variable and Constant Value or None is provided.</p>

Table 2-18 (Cont.) Formula Definition

Field	Do this
Mathematical Operator	<p>Select the math operator to be used on the adjacent formula definition rows, from the drop-down list. The list is derived and displayed based on data type / variable as indicated below:</p> <ul style="list-style-type: none"> For Number, system allows all numeric operators (+, -, x, and %). For Date, system supports (+ and -) operators. For String, system supports concatenation (i.e. +) operator.
)	Specify a right bracket, if you are grouping part of your formula definition.
Enabled	Check this box to enable the formula and indicate that it is included when building a parameter definition.

Note

In the Parameter's section if the Data Type is selected as 'Character', then the mathematical operator can be selected as either Blank or Plus. System does not allow to select other mathematical operators and displays an error 'Operation Minus, Multiplication and Division not allowed for Parameter of CHARACTER data type'.

- Perform any of the [Basic Actions](#) mentioned in Navigation chapter.
- In the Parameters section, click **Show Expression**. The mathematical expression appears in the Formula Expression section (in sequential order) in the Expression field.

2.6.2 Selection Criteria

The sub tab is enabled only for Target Parameters and facilitates to define the selection criteria indicating the type of accounts to be picked for computation. The parameters are derived from user defined table - USER DEFINED: ACCOUNT CRITERIA TYPE CODE and USER DEFINED: COLLATERAL TYPE CODE as per Account and Collateral Entity type.

- In the Selection Criteria section, perform any of the [Basic Operations](#) mentioned in Navigation chapter.

Note

Although system allows to define customized selection criteria, the execution of additional selection criteria requires additional processing at server level and can have significant performance impact delaying the EOD processing/web services. Hence it is recommended to have careful consideration while defining the additional selection criteria (like using user-defined tables and columns) and/or get approval from your database administrator before using any selection criteria.

A brief description of the fields is given below:

Table 2-19 Selection Criteria

Field	Do this
Seq	Specify sequence numbers.
(Specify left bracket.
Parameter	Select the parameter from the drop-down list. The list is populated based on the values maintained in user defined table - Customer Service: USER DEFINED: CUSTOMER SERVICE CRITERIA PARAMETERS.
Comparison Operator	Select comparison operator from the drop-down list.
Criteria Value	Specify criteria value.
)	Specify right bracket.
Logical Expression	Select logical operator from the drop-down list.
Enabled	Check this box to enable the selection criteria.

2. Perform any of the [Basic Actions](#) mentioned in Navigation chapter.
3. Click **Check Criteria** for system to validate the query and display the results.

If the formula expression is mathematically incorrect when parameters are calculated, system displays error indicating 'INVALID FORMULA EXPRESSION: <<FORMULA PARMETER>>'.

2.7 Transaction Codes

The system uses transaction codes to define the actions and tasks it can perform; for example, activating an account, changing a due date, applying a late fee, and charging off an account.

The Transaction Codes Setup screen catalogs and defines these core system actions.

The system organizes transaction codes in **Super Groups**. All transaction codes within a particular super group are processed in a similar manner. The transaction super groups in the system are as follows:

Table 2-20 Transaction Super Group

Super Group Type	Description
ACCOUNT CONDITION TXN	These transaction codes control a user's ability to open and close account conditions.
ACCOUNT MONETARY TXN	These transaction codes affect the monetary value of accounts in the system; for example, activating accrual of interest, the assessment of fees, and closing the account.
ACCOUNT NON MONETARY TXN	These transaction codes do not have a direct effect on the monetary value of the account, but are used in maintaining account information. This includes changing a customer's driving license, or adding information for automated clearing house (ACH).
AMORTIZATION TXN	These transaction codes affect the amortized balances of the accounts in the system.

Table 2-20 (Cont.) Transaction Super Group

Super Group Type	Description
CORRESPONDENCES	These transaction codes relate to the system correspondences.
ESCROW ANALYSIS AND DISBURSEMENTS	These transaction codes allow for reviewing and approving escrow analysis, stopping an escrow override, and posting escrow disbursement.
ESCROW MONETARY TRANSACTIONS	These transaction codes affect the monetary value of escrow accounts in the system; for example, disbursing escrow to a customer and insurance, and receiving payment.
ESCROW NON MONETARY TRANSACTIONS	These transaction codes do not have a direct effect on the monetary value of an escrow account, but are used in maintaining account information, such as changing insurance maturity date and adding new escrow tax details.
FEE ASSESSMENTS	These transaction codes determine if fees such as nonsufficient funds fees or membership fees are to be applied.
FUNDING TXN	These transaction codes affect the funding of applications and accounts within the system.
ITEMIZATION TXN	These transaction codes affect the itemization of applications and accounts within the system.
MENU TXN	These transaction codes affect the menus within the system.
PRODUCER MONETARY TXN	These transaction codes relate to the monetary transactions that apply to the system producers (or dealers).
REPORTS	These transaction codes are related to generating the system reports.
SETUP LOCK/UNLOCK	These transaction codes limit a user's ability to change the existing setup data, even if they are allowed access to the form, by restricting access to the Lock/ Unlock Record icon on the system tool bar.
ACCOUNT CONDITION TXN	These transaction codes control a user's ability to open and close account conditions.
CORRESPONDENCES	These transaction codes relate to the system correspondences.
MENU TXN	These transaction codes affect the menus within the system.
REPORTS	These transaction codes are related to generating the system reports.
SETUP LOCK/UNLOCK	These transaction codes limit a user's ability to change the existing setup data, even if they are allowed access to the form, by restricting access to the Lock/ Unlock Record icon on the system tool bar.

Three sub screens, Parameters, Access Grid, and Products, record any additional information required to perform a transaction, the user types that can perform the transaction, and the product type to which the transaction codes apply.

Note

The Software recommends that you restrict the access to the seed data once you are in production.

To set up the Transaction Codes

1. Click **Setup > Setup > Administration > System > Transaction Codes**. The system displays the Transaction Codes screen.
2. In **Transaction Super Group** section, you can view the following information.

Figure 2-10 Transaction Super Group

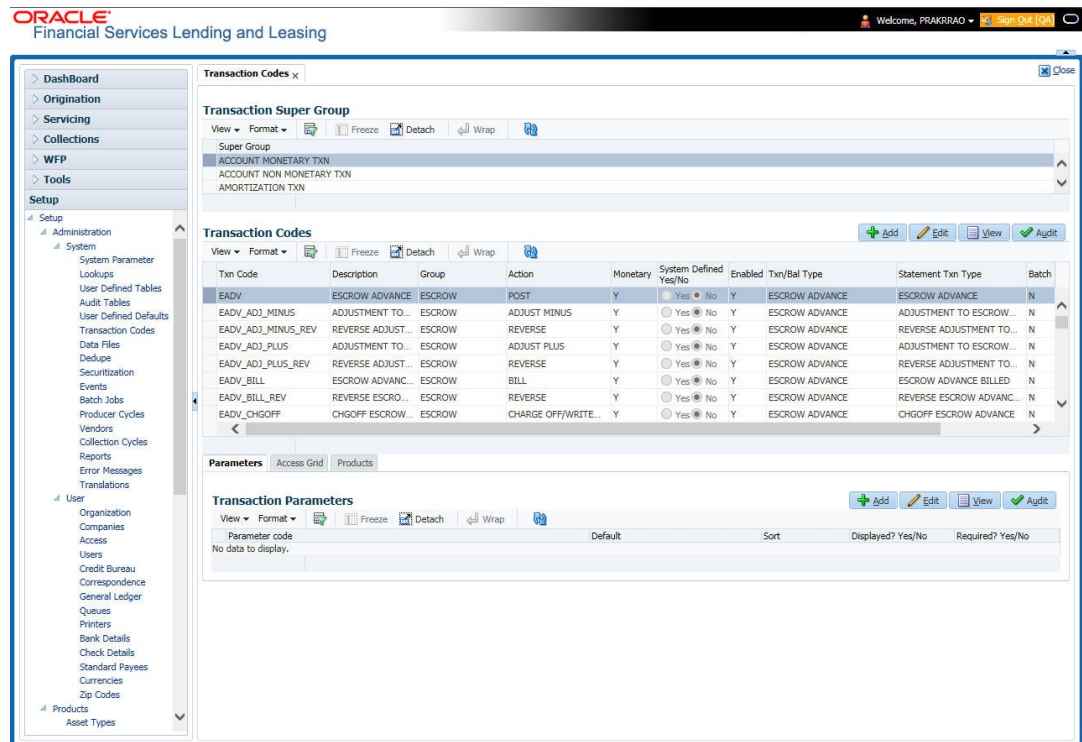

A brief description of the fields is given below:

Table 2-21 Transaction Super Group Fields

Field	Do this
Super Group	Select the Super Group you want to work with in the Transaction Codes screen.

3. Perform any of the [Basic Actions](#) mentioned in Navigation chapter.
4. In the **Transaction Codes** section, perform any of the [Basic Operations](#) mentioned in Navigation chapter.

Figure 2-11 Transaction Codes

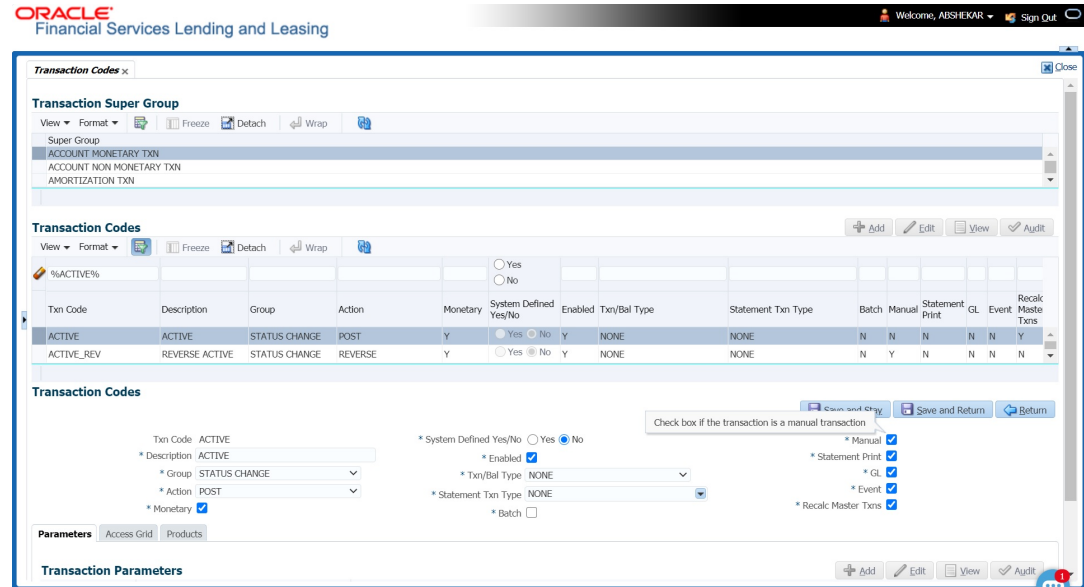

A brief description of the fields is given below:

Table 2-22 Transaction Codes Fields

Field	Do this
Txn Code	Specify the transaction code (required).
Description	Specify the description for the transaction.
Group	Select the transaction group (the group within the Transaction Super Group that the transaction code belongs to) from the drop-down list.
Action	Select the action type code for the transaction (what action will take place when the transaction occurs) from the drop-down list.
Monetary	Check this box to maintain the transaction as a monetary transaction. If unchecked, then the transaction is nonmonetary.
System Defined Yes/ No	Select Yes , if you wish to maintain the transaction code as system defined and No , if you do not want to maintain it as system defined. System defined entries cannot be modified. If entry is not system defined, then it can be modified.
Enabled	Check this box to enable the transaction.
Txn/Bal Type	Select the transaction / balance type affected by the Transaction from the drop-down list.
Statement Txn Type	Select the statement transaction type (how the transaction should appear on the customer statement) from the drop-down list.
Batch	Check this box to perform the transaction in a batch process.

Table 2-22 (Cont.) Transaction Codes Fields

Field	Do this
Manual	Check this box, if the transaction is a manual transaction. If you define a transaction as manual, the system recommends that the transaction that reverses it also be defined as manual.
Stmt Print	Check this box to print the transaction on customer statements.
GL	Check this box, if the transaction is a general ledger transaction.
Event	<p>On selecting this check box, the particular Monetary/Non-Monetary transaction is considered for triggering of respective Monetary and Nonmonetary transaction posting Event type. The particular Monetary/Non-Monetary transaction is available while defining Event Actions.</p> <p>For more information, refer to Events (New Framework) section.</p>
Recalc Master Txns	<p>Check this box for system to recalculate and repost consolidated fee at Master Account level. This is done automatically by identifying those monetary transactions which should trigger recalculation of Late Charge, Cycle Based Late Fee and Cycle Based Collection Late Fee at Master Account level when backdated transaction is posted on any Associated Account that is marked for fee consolidation.</p> <p>For more information, refer to Cycle Based Fees and Fee Consolidation sections in Contract setup screen.</p>

5. Perform any of the [Basic Actions](#) mentioned in Navigation chapter.

This section consists of the following topic:

- [Transaction Codes sub screens](#)

2.7.1 Transaction Codes sub screens

Note

Please contact your System Administrator / Implementation Manager before making any changes in these sub screens.

The Transaction Codes screen contains three sub screens:

- [Parameters](#)
- [Access Grid](#)
- [Products](#)

2.7.1.1 Parameters

Here, you can define the parameter information for the associated transaction. The Parameters apply exclusively to these super groups:

- ITEMIZATION TXN
- AMORTIZATION TXN
- PRODUCER MONETARY TXN
- FUNDING TXN
- ACCOUNT CONDITION TXN
- CORRESPONDENCES
- FEE ASSESSMENTS

Note

Treat the Transaction Parameters sub screen as containing view-only information. This is very sensitive data and you should not change it without consulting Oracle Financial Services Lending and Leasing.

To set up the Parameters

1. Click **Setup > Setup > Administration > System > Transaction Codes > Parameters**.
2. In the **Transaction Parameters** section, perform any of the [Basic Operations](#) mentioned in Navigation chapter.
A brief description of the fields is given below:

Table 2-23 Transaction Parameters

Field	Do this
Parameter Code	Select the parameter code associated with the transaction code, from the drop-down list.
Default	Specify the default value for the transaction parameter (value to initially populate, or used if no value is supplied).
Sort	Specify the sort order for the transaction parameter.
Displayed? Yes/No	Select Yes to display the parameter and No if you do not want to display in current use.
Required? Yes/No	Select Yes if the parameter is required and No if you do not require the parameter. (You must select Required as empty values are not allowed.)

3. Perform any of the [Basic Actions](#) mentioned in Navigation chapter.

2.7.1.2 Access Grid

The Access Grid sub screen allows you to control access to each transaction according to user responsibility, account status, and account condition. It allows the administrator to control when

these transactions may be conducted. Normally, you would create or modify the access based on either the user responsibility or account condition. Account status access is left unchanged.

To set up the Access Grid sub screen

1. Click **Setup > Setup > Administration > System > Transaction Codes > Access Grid**.
2. In the **Transaction User Access Definition** section, perform any of the [Basic Operations](#) mentioned in Navigation chapter.

A brief description of the fields is given below:

Table 2-24 Transaction User Access Definition

Field	Do this
Access Type	Select the access grid function type (ACCOUNT CONDITION AND ACCOUNT STATUS) that is being used to control the creation of the associated transaction, from the drop-down list.
Access Value	Select the access function grid value from the drop-down list (based on a lookup associated with the Access Type. Multiple entries for each access type may be created as long as each has a different access value).
Allowed? Yes/No	Select Yes if the access is allowed and No if the access is not allowed (indicates whether the current Access Type / Access Value may create the associated transaction).
System Defined Yes/ No	Select Yes , if you wish to maintain access type as system defined and No , if you do not want to maintain it as system defined. System defined entries cannot be modified. If entry is not system defined, then it can be modified.

3. Perform any of the [Basic Actions](#) mentioned in Navigation chapter.

2.7.1.3 Products

The Products sub screen allows you to define the products to which the transaction codes apply. It allows the administrator to control if the associated transaction code will be available for use for specific product types and or funding types.

Normally, an Access Value of ALL is defined for one or more Access Types with a given Allowed value. Additional Access Values are then defined for the same Access Types with the opposite Allowed value. This controls access to the associated transaction.

To set up the Products sub screen

1. Click **Setup > Setup > Administration > System > Transaction Codes > Products**.
2. In the **Transaction Product Definition** section, perform any of the [Basic Operations](#) mentioned in Navigation chapter.

A brief description of the fields is given below:

Table 2-25 Transaction Product Definition

Field	Do this
Product Type	Select the product type associated with the transaction code from the drop-down list.

Table 2-25 (Cont.) Transaction Product Definition

Field	Do this
Funding Type	Select the funding type associated with the transaction code from the drop-down list.
Allowed? Yes/No	Select Yes if the transaction is allowed and No if the transaction is not allowed (indicates whether the current Access Type / Access Value may create the associated transaction).

3. Perform any of the [Basic Actions](#) mentioned in Navigation chapter.

2.8 Data Files

The Data Files Setup screen organizes information pertaining to the various input/output data files that the system can generate. The system uses the Data Files Setup screen to outline the file layouts of each data file produced/received within the system, including the length and data type of each column name.

These files are typically produced during the nightly process.

One major advantage for the system-defined data files is the format mask of each column name within each data file. A format mask is like a stencil that forces data input to be of the same format before accepting the data.

You can change the order in which the fields are displayed in the file.

Note

Any addition or removal of a field or change in the data type length requires the Software involvement.

Data Files screen consists of the following two tabs:

- [Output tab](#)
- [Input tab](#)

2.8.1 Output tab

The "Output tab" in the **Data Files screen** allows you to define the structure of output data file through the following sections:

- [Data File Definitions](#)
- [Record Definitions](#)
- [Column Definitions](#)

2.8.1.1 Data File Definitions

The Data File Definitions section defines specific data files. Each is associated with a specific Output Data Definition (ODD) batch job that gathers the data that the file will contain. While new data file definitions may be created they will have no use unless a batch job is also created to populate the data.

To set up Data File Definitions

1. Click **Setup > Setup > Administration > System > Data Files > Output** tab.
2. In the **Data Files Definitions** section, perform any of the [Basic Operations](#) mentioned in Navigation chapter.

Figure 2-12 Data Files Definitions

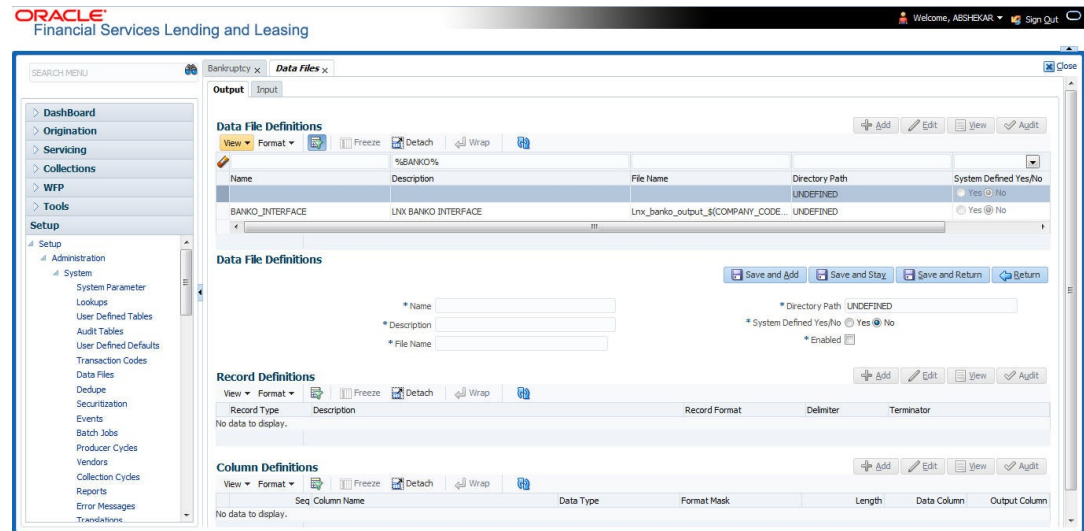

A brief description of the fields is given below:

Table 2-26 Data Files Definitions

Field	Do this
Name	Specify data file type (name of data file definition).
Description	Specify data file description.
File Name	Specify data file name. Prefix used for files generated for this Data File. This is the only field on the Data File Definitions screen that can or should be modified by your Administrator. The generated file name will be in the form of <FILE NAME>_<COMPANY ID>_<BRANCH ID>_<MMDDYYYY>_<PROCESS ID>.DAT. The inclusion of _<COMPANY ID> and _<BRANCH ID> depends entirely on the associated batch process.
Directory Path	Specify the directory path.
System Defined Yes/No	Select Yes , if you wish to maintain the data file definition as system defined and No , if you do not want to maintain it as system defined. System defined entries cannot be modified. If the entry is not system defined, then it can be modified.
Enabled	Check this box to enable the data file definition.

3. Perform any of the [Basic Actions](#) mentioned in Navigation chapter.

2.8.1.2 Record Definitions

Each data file definition is made up of one or more record definitions. These define organization of the data. The associated batch file determines how these records are used. The order in which the data is populated determines the order in which those records will appear in the output file. This is generally related to the order the records appear in the Data File Definition section.

1. In the **Record Definitions** section, perform any of the [Basic Operations](#) mentioned in Navigation chapter.

A brief description of the fields is given below:

Table 2-27 Record Definitions

Field	Do this
Record Type	Specify the type of record being defined.
Description	Specify record description.
Record Format	Select the format of output data (FIXED, VARIABLE) from the dropdown list.
Delimiter	Specify the delimiter (column separator used with VARIABLE format).
Terminator	Select the record terminator code (how the end of each record is indicated within the file -- CARRIAGE RETURN, LINE FEED, or CARRIAGE RETURN AND LINE FEED) from the drop-down list.

2. Perform any of the [Basic Actions](#) mentioned in Navigation chapter.

2.8.1.3 Column Definitions

Each record definition is made up of one or more column definitions. These define the output of the data. Much of this data is informational; it indicates what data is being provided by the associated batch job. Unless otherwise noted, the data should not be changed without changing the associated batch job.

1. In the **Column Definitions** section, perform any of the [Basic Operations](#) mentioned in Navigation chapter.

A brief description of the fields is given below:

Table 2-28 Column Definitions

Field	Do this
Seq	Specify the order in which the output data dump will process the column information.
Column Name	Specify name/description of the column (informational only).
Data Type	Specify the data type. This describes the type of data the column is expected to contain (CHARACTER, DATE, or NUMBER). This effects how the ODD process handles the data, and should not be changed.

Table 2-28 (Cont.) Column Definitions

Field	Do this
Format Mask	Select the format mask for the column from the drop-down list. For DATE or NUMBER columns, this field defines the output format of the data. For example; Date fields may be entered using the MM/DD/ YYYY format, Number fields may be entered as decimal numbers with varying degrees of precision. Other formats for each data type are available.
Length	Specify the column length (the maximum number of characters of the output data to be included in the output file). Each output data details column may contain up to 240 characters of data. If the output data details column contains more data than the length value the data will be truncated. For VARIABLE records the length should be set to "-1" or a Delimited file will be created with FIXED LENGTH columns.
Data Column	Specify the data column sequence. This is the column that will be used to select the data that is being output. This should not be changed.
Output Column	Specify the output column sequence. This is the column that will appear in Output File. The Output Data Dump process allows for the output of 250 columns of data per record. No output column should be repeated in the setup for a record.

2. Perform any of the [Basic Actions](#) mentioned in Navigation chapter.

2.8.2 Input tab

Oracle Financial Services Lending and Leasing facilitates processing of a input data file received from external interface into the system through an automated batch job (IDDPRC_BJ_000_01) triggered on regular intervals.

The "Input tab" in the **Data Files screen** allows you to define the input data file through the following sections:

- [Input Data File Definitions](#)
- [Column Definitions](#)
- [Configurable Bulk Upload](#)

2.8.2.1 Input Data File Definitions

In the Input Data File Definitions section, you can define and maintain the structure of input data file to populate data from external system.

Oracle Financial Services Lending and Leasing also supports bulk upload of data into the system through input file processing for a set of process listed in Setup > Administration > System > Lookups > Lookup Code section.

Lookup Type: INCOMING_FILE_TYPE_CD

Description: INCOMING LOG FILE TYPE CODE

In addition, there is also an option for configurable bulk upload of data in which the input file delimiter is configurable to required value. For more information, refer to [Configurable Bulk Upload](#) section.

To set up Input Data File Definitions

1. Click **Setup > Setup > Administration > System > Data Files > Input tab**.
2. In the Input Data Files Definitions section, you can make use of the copy option to copy the Input file definition and corresponding column definitions. To do so, click on the required record in the list, select the target company for which records needs to be created from **Company** drop-down list and click **Create Copy**. The following records are copied:
 - ITU_TXN_UPLOAD
 - ASSET_ASE_UPLOAD
 - ASSET_ATA_UPLOAD
 - ASSET_ATR_UPLOAD
 - ASSET_AVL_UPLOAD
 - CURE_LTR
 - BKRP_NEW
 - BKRP_UPDATE

Records for above files are created with **External Table Name** as **External Table Name_Company code**.
3. Perform any of the [Basic Operations](#) mentioned in Navigation chapter.

Figure 2-13 Input Data File Definitions

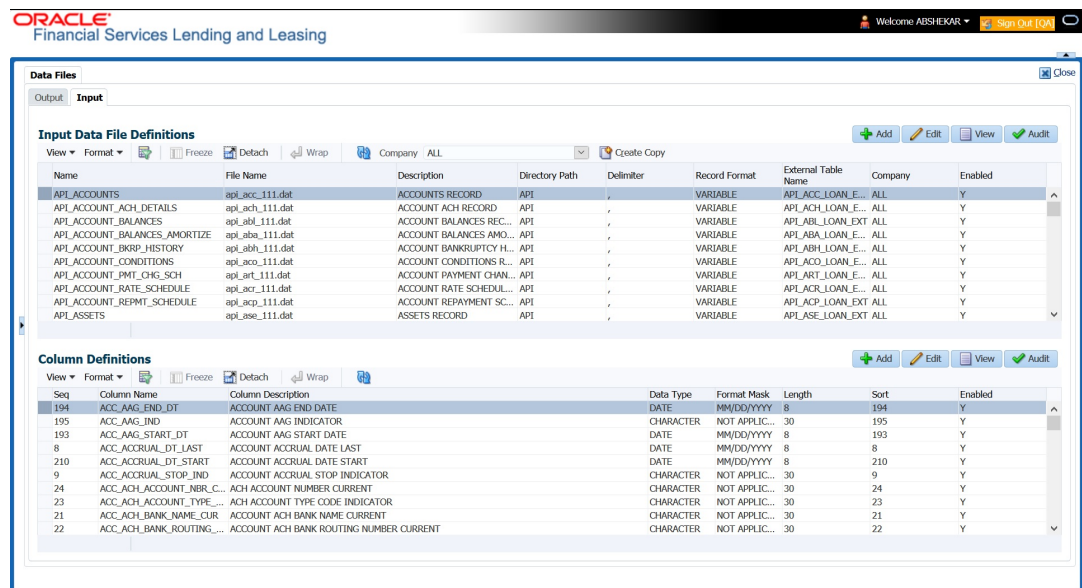

A brief description of the fields is given below:

Table 2-29 Input Data File Definitions

Field	Do this
Name	Specify a unique name for the input data file.
File Name	Specify the data file name with the correct prefix.
Description	Specify data file description.
Directory Path	Specify the directory path configured within OFSLL Database server to process the input data file.
Delimiter	Specify the delimiter used to separate column data. (Ex: Comma).
Record Format	System defaults the record format as VARIABLE .
External Table Name	View the name of external table from which input data is populated.
Company	View the company name selected in external table.
Enabled	Check this box to enable the input data file definition.

4. Perform any of the [Basic Actions](#) mentioned in Navigation chapter.

2.8.2.2 Column Definitions

Each input data file definition is made up of one or more column definitions. These define the structure of data to be loaded from external system.

1. In the **Column Definitions** section, perform any of the [Basic Operations](#) mentioned in Navigation chapter.

A brief description of the fields is given below:

Table 2-30 Column Definitions

Field	Do this
Seq	Specify the order in which the input data dump will process the column information.
Column Name	Specify name of the column.
Column Description	Specify description of the column.
Data Type	Select the data type from the drop-down list. The selected data type describes the type of data the column is expected to contain such as INTEGER/DATE/NUMBER/CHARACTER. This effects how the input data file processing handles the data, and should not be changed.
Format Mask	Select the format mask for the column from the drop-down list. The list displays the format depending on the Data Type selected. For example; Date fields may be entered using the MM/DD/YYYY format, Number fields may be entered as decimal numbers with varying degrees of precision. Other formats for each data type are available.

Table 2-30 (Cont.) Column Definitions

Field	Do this
Length	Specify the column length (the maximum number of characters of the data to be included in the input file) Each input data details column may contain up to 240 characters of data. If the output data details column contains more data than the length value the data will be truncated. For VARIABLE records the length should be set to "-1" or a Delimited file will be created with FIXED LENGTH columns.
Sort	Specify the order in which the column definitions are to be sorted for display in the external interface screen (Customer Service > External Interfaces). There can be a maximum of 61 column definitions.
Enabled	Default selected. If not, you can check this box to enable the column definition.

2. Perform any of the [Basic Actions](#) mentioned in Navigation chapter.

2.8.2.3 Configurable Bulk Upload

In the process of configurable bulk upload of data, the input file delimiter is configurable to required value and data is processed based on the column definitions defined. This option is supported for Transactions and Collateral uploads to create new transactions and asset records in bulk.

For bulk upload of data, the input CSV (comma separated values) file is to be constructed in specific format as defined in Setup > Data Files > Input screen's **Input Data File Definitions** and **Column Definitions** sections.

For example, consider the following Column Definition details:

Table 2-31 Column Definition Details

Seq	Column Name	Column Description	Data Type	Length	Sort
1	ASE_OPERATI ON_IND	OPERATION IND	CHARACTER	30	1
2	ASE_NBR	ASSET NUMBER	NUMERIC	30	2
3	ASE_REGN_D T	REGISTRATIO N DATE	DATE	30	3

If the delimiter in Input Data file definitions is set as ',' (comma), then the csv can be constructed in same format and sequence of column definition as indicated below with each row as one record:

```
ASE_OPERATION_IND,ASE_NBR,ASE_REGN_DT
NEW,20151200010476,12/08/2015
EXISTING,20111300010468,13/10/2011
```

NEW,20101400010812,14/11/2016

The CSV file is to be placed in the directory path/work area which is the base path defined in system parameter - `UIX_INCOMING_FILE_PATH` (INCOMING FILE PATH OF APP SERVER) by the system administrator and further appended by the configurable sub folder name such as ITU or ICC. For example: `/scratch/work_area/<domain name>/input/itu`.

Following are the Lookup code maintained in Setup > Administration > System > Lookups > Lookup Code section for respective process type:

Table 2-32 Lookup Code

Process Type	Lookup Code	Description
Transaction File Upload	ITU	TRANSACTION UPLOAD
Asset File Upload	ICC	INPUT CREATE COLLATERAL

- For Transaction File Upload, only one csv file can be created with multiple records and on processing, the data is populated into Servicing > Customer Service > Transaction > History > Transactions tab.
- For Asset File Upload, separate csv files are to be created to upload the data into Collateral Management screen's Collateral details, Valuation, Addons/Attributes, and Tracking sections respectively.

On executing the scheduled batch job in SET-IFP, IDDP RC_BJ_000_02 (BULK INPUT DATA INSERTION), the data in csv file is processed and is displayed in Servicing Customer Service > External Interfaces tab. Such data does not need authorization and is directly uploaded on validating the sequence, position, and format.

The status of batch job can be viewed in Dashboard > System Monitor > Batch Jobs screen. The records which resulted in error are listed in the bad file.

2.9 Events

In the current version of Oracle Financial Service Lending and Leasing, the Events framework has undergone changes in the processing type from earlier Engine based framework to Entity based framework and OFSLL is enabled to support both old and new type of events processing.

If you have upgraded from an older version of OFSLL, the existing events listed in **Event Types** tab and action types listed in **Event Action Types** tab will still be functional as intended but cannot be added or modified. Along with these two tabs, the data in **Online** and **Batch** tab are also displayed in read-only mode. However, new events and action types can only be created in **Events** tab.

- For existing events defined in the system, refer to [Events \(Existing Framework\)](#).
- To work with new events framework, refer to [Events \(New Framework\)](#).

This section consists of the following topics:

- [Events \(Existing Framework\)](#)
- [Events \(New Framework\)](#)
- [Monitoring JMS Event Actions](#)

2.9.1 Events (Existing Framework)

During Origination, when an application moves from one status/sub status to another, or changes condition, the system can trigger an event and perform the associated event actions. This can occur either online or in batch mode.

Note

Only predefined events and actions can be set up on the Events Setup screen. You cannot create new event types or action types.

As processing events and associated actions require additional processing at the server level, the performance of the transactions, for which the events are setup, may be adversely affected dependent upon your specific configuration.

In the Events screen you can view **trigger events** with associated actions which the system performs during application entry. The fields on this screen are both system and user defined. There are four sub screens on the Events screen to set up and maintain these events:

- Events Types
- Event Action Types
- Online
- Batch

Event Types and Action Types sections of this screen provide a master table for setting up the online and batch events. This setup triggers the event, which in turn triggers the actions associated with the events, during application entry.

Navigating to Events

On the Oracle Financial Services Lending and Leasing home screen, click **Setup > Setup > Events**.

This section consists of the following topics:

- [Event Types](#)
- [Event Action Types](#)
- [Online](#)
- [Batch](#)

2.9.1.1 Event Types

1. Click **Setup > Setup > Administration > System > Events > Line of credit > Events Types**.
2. In the Event Types tab, you can view the existing events and its details maintained in the system.

Figure 2-14 Events Setup

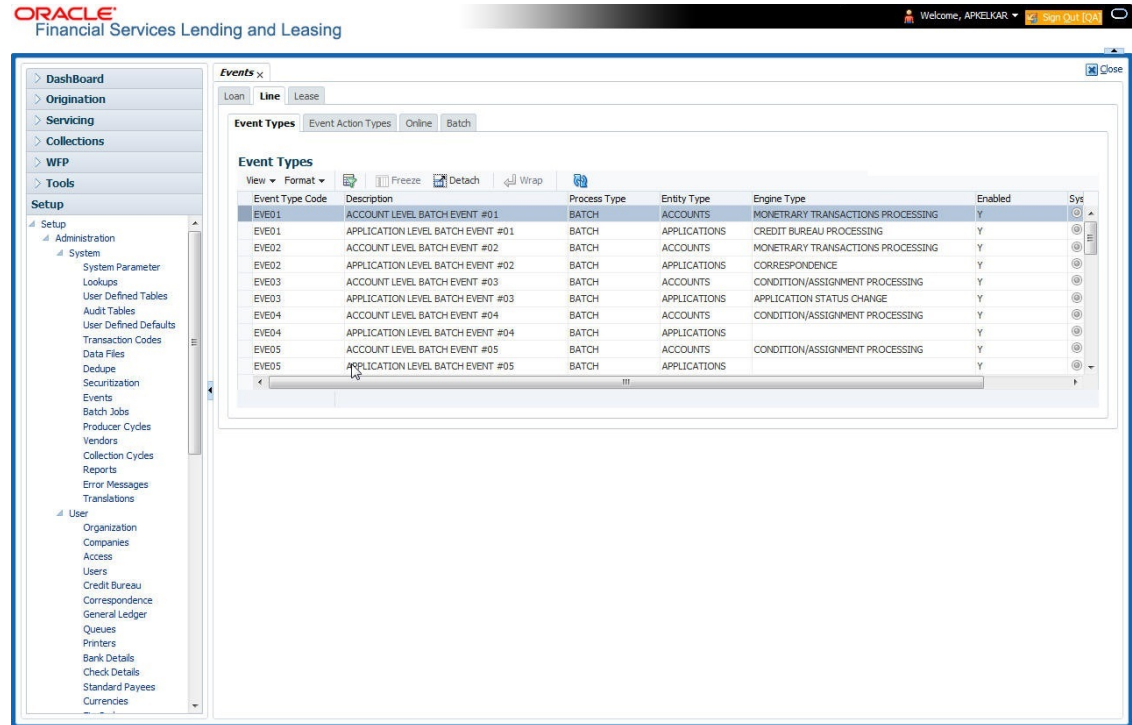

A brief description of the fields is given below:

Table 2-33 Event Types

Field	Do this
Event Type Code	View the event type code.
Description	View the event description.
Process Type	View the event action processing type (BATCH or ONLINE).
Entity Type	View the entity type (ACCOUNTS or APPLICATIONS).
Engine Type	View the engine type (MONETARY TRANSACTIONS PROCESSING, NON-MONETARY TRANSACTION PROCESSING, CONDITION/ASSIGNMENT PROCESSING, APPLICATION STATUS CHANGE, CREDIT BUREAU PROCESSING, LETTERS PROCESSING or CORRESPONDENCE).
Enabled	Y indicates event type is enabled and N indicates disabled.
System Defined	If Yes indicates that the event type is system defined. If No indicates that the event type is user defined.

2.9.1.2 Event Action Types

The Event Action Types section is system defined and lists the action codes supported in the system.

1. Click **Setup > Setup > Administration > System > Events > Line of credit > Event Action Types.**

Figure 2-15 Events Action Setup

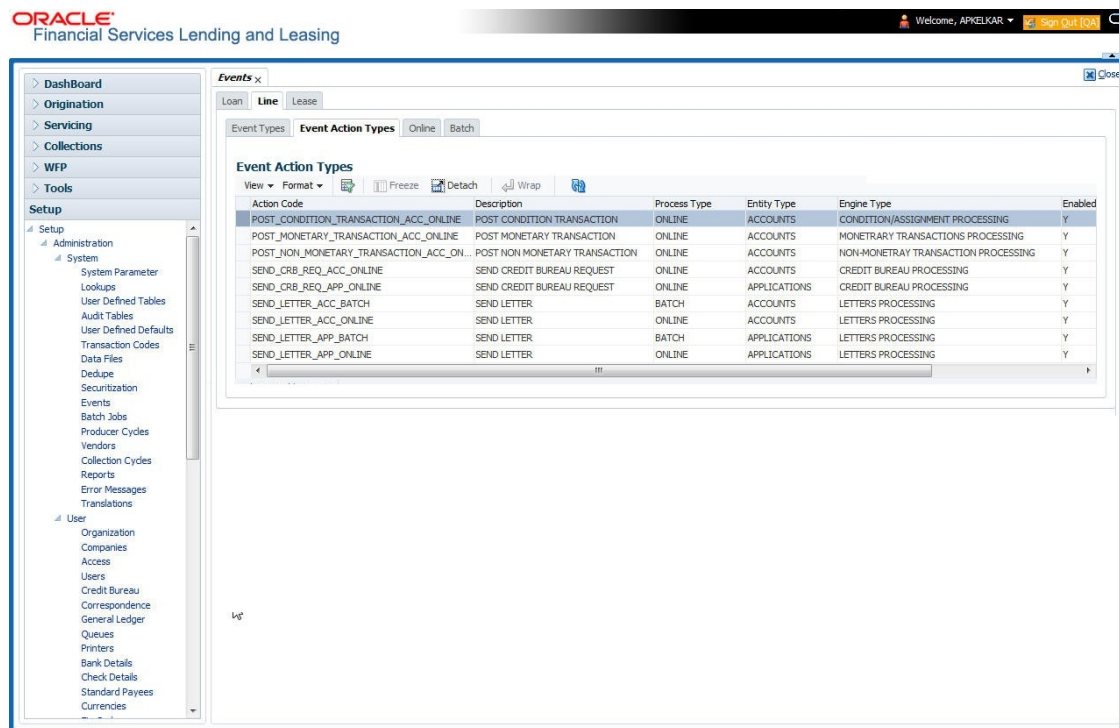

A brief description of the fields is given below:

Table 2-34 Event Action Types

Field	Do this
Action Code	View the action code.
Description	View the action description.
Process Type	View the event action processing type (BATCH or ONLINE).
Entity Type	View the entity type.
Engine Type	View the engine type.
Enabled	Y indicates event action type is enabled and N indicates disabled.
System Defined	If Yes indicates that the event action type is system defined. If No indicates that the event action type is user defined.

2.9.1.3 Online

The Online tab allows you to view the online events defined in the system along with the event criteria actions. The system supports the following online events:

1. The system processes the event's actions during:

- CHG OFF Reversal
- Paid Off Reversal
- BKRP is closed
- BKRP Is Opened
- When Queue is Closed
- When status/ Sub status changed to **Approved- Rehashed**
- Account condition SCHG is closed
- Account condition SCHG is Opened
- Change in application status / sub status to APPROVED – REHASHING

The events that can be performed online after each of the events listed above are as follows:

- Generate correspondence for an application
- Send a credit bureau request for an application.

To view Online Event

Click **Setup > Setup > Administration > System > Events >Line of credit > Online.**

Figure 2-16 Online Setup

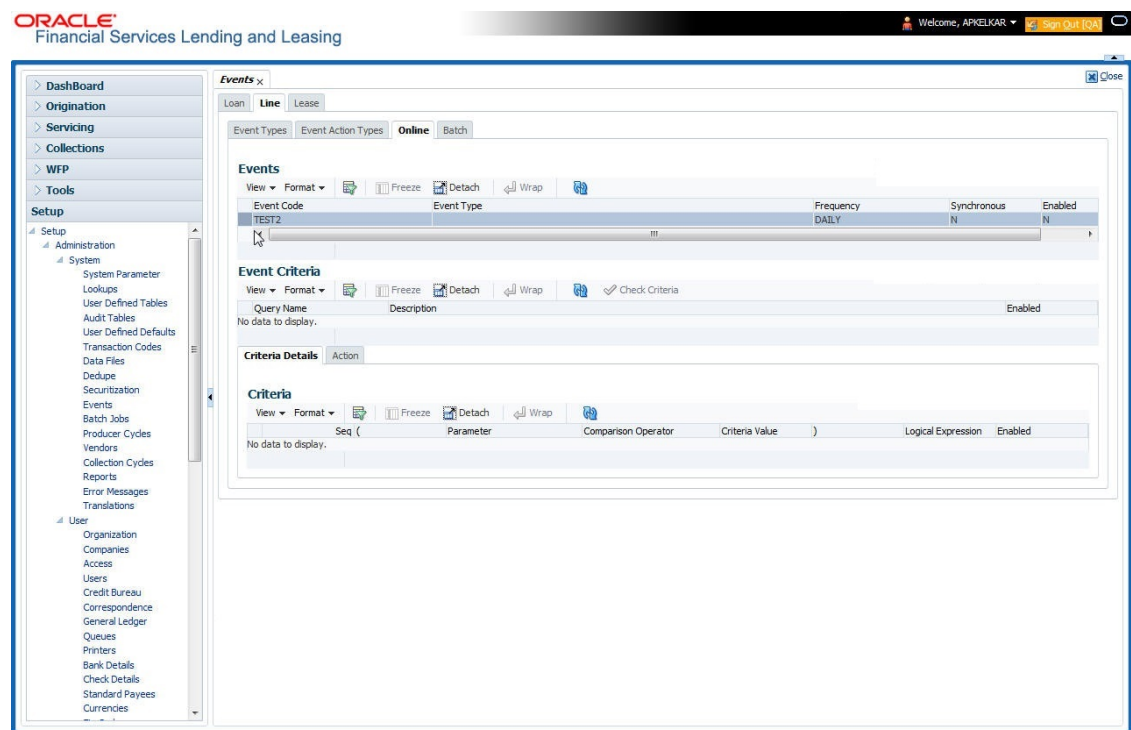

A brief description of the fields is given below:

Table 2-35 Online Event

Field	Do this
Event Code	View the event code.
Event Type	View the event type.
Synchronous	S indicates that the event is synchronous (i.e. any failure in triggering the event will fail to trigger the entire transaction). If A indicates that the event is asynchronous (i.e. any failure in the event will not affect the transaction, which will be successfully completed).
Enabled	Y indicates event type is enabled and N indicates disabled.

The **Event Criteria** section allows you to view the query defined for an event.

A brief description of the fields is given below:

Table 2-36 Event Criteria

Field	Do this
Query Name	View the query name.
Description	View the query description.
Enabled	Y indicates event criteria is enabled and N indicates disabled.

Criteria Details

The Criteria Details sub tab allows you to view the defined selection criteria for the event. System uses these criteria to determine which application to include in the event action.

Note

Although system allows to define customized selection criteria, the execution of additional selection criteria requires additional processing at server level and can have significant performance impact delaying the EOD processing/web services. Hence it is recommended to have careful consideration while defining the additional selection criteria (like using user-defined tables and columns) and/or get approval from your database administrator before using any selection criteria.

A brief description of the fields is given below:

Table 2-37 Criteria Details

Field	Do this
Seq	View sequence number.
(Indicates opening bracket.
Parameter	View the parameter selected for the criteria.
Comparison Operator	View the comparison operator selected for the criteria.

Table 2-37 (Cont.) Criteria Details

Field	Do this
Criteria Value	View the criteria value.
)	Indicates closing bracket.
Logical Expression	View the logical operator selected for the criteria.
Enabled	Y indicates event selection criteria is enabled and N indicates disabled.

Actions

In the Actions sub tab, you can view the actions that the system performs when event is triggered. There can be more than one event action for a particular event and the Seq field defines the order in which the event action should occur.

A brief description of the fields is given below:

Table 2-38 Actions

Field	Do this
Description	View the event action description.
Seq	View sequence number defined for the action.
Enabled	Y indicates event action is enabled and N indicates disabled.

For each event action, view the **Action Parameters** defined. A brief description of the fields is given below:

Table 2-39 Action Parameters

Field	Do this
Description	View the parameter description.
Value	View the parameter value.
Required	Y indicates action parameter is required and N indicates not-required

2.9.1.4 Batch

The Batch screen allows you to view the events performed as a batch transaction by the system. The system supports the following predefined batch events for application processing. (These batch events are listed in the Events Types tab):

- APPLICATION LEVEL BATCH EVENT #01
- APPLICATION LEVEL BATCH EVENT #02
- APPLICATION LEVEL BATCH EVENT #03
- APPLICATION LEVEL BATCH EVENT #04
- APPLICATION LEVEL BATCH EVENT #05
- APPLICATION LEVEL BATCH EVENT #06
- APPLICATION LEVEL BATCH EVENT #07

- APPLICATION LEVEL BATCH EVENT #08
- APPLICATION LEVEL BATCH EVENT #09
- APPLICATION LEVEL BATCH EVENT #10

To view the Batch Event

Click **Setup > Setup > Administration > System > Events > Line of credit > Batch.**

Figure 2-17 Batch Setup

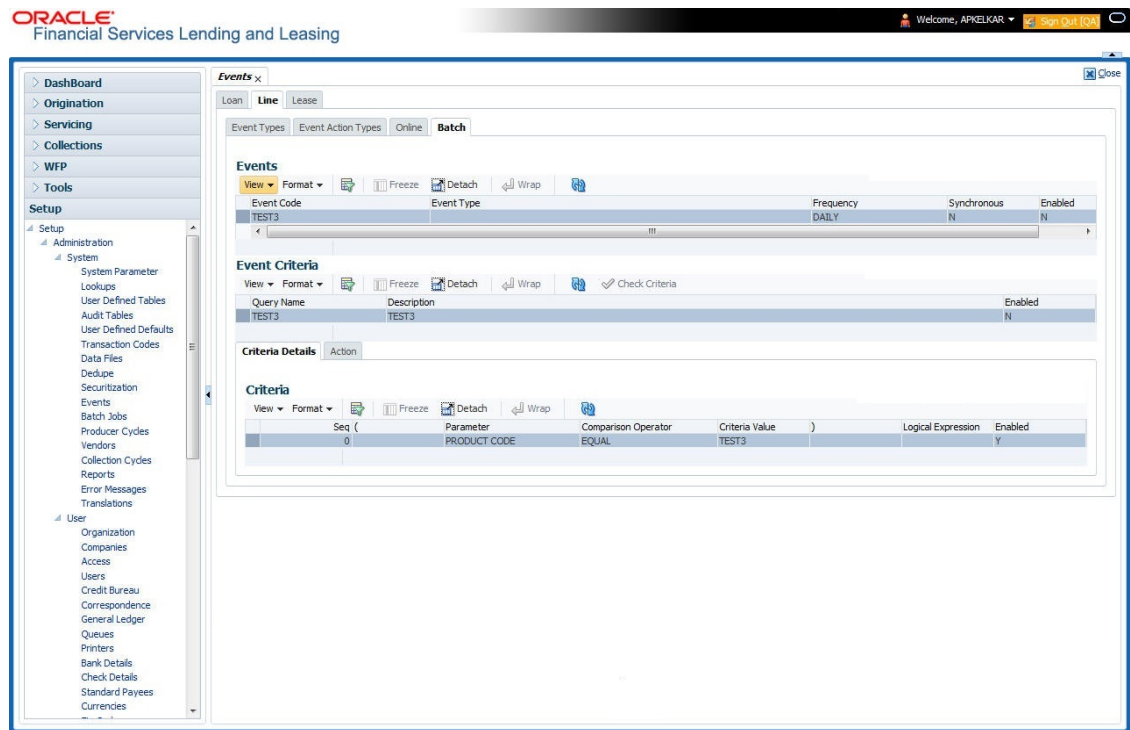

A brief description of the fields is given below:

Table 2-40 Batch Event

Field	Do this
Event Code	View the event code.
Event Type	View the event type.
Frequency	View the event frequency.
Enabled	Y indicates event type is enabled and N indicates disabled.

The **Events Criteria** section allows you to view the query name and event description defined for an event.

A brief description of the fields is given below:

Table 2-41 Events Criteria

Field	Do this
Query Name	View the query name.
Description	View the event description
Enabled	Y indicates event criteria is enabled and N indicates disabled.

Criteria Details

The Criteria Details sub tab allows you to view the defined selection criteria for the event. System uses these criteria to determine which application to include in the event action.

Note

Although system allows to define customized selection criteria, the execution of additional selection criteria requires additional processing at server level and can have significant performance impact delaying the EOD processing/web services. Hence it is recommended to have careful consideration while defining the additional selection criteria (like using user-defined tables and columns) and/or get approval from your database administrator before using any selection criteria.

A brief description of the fields is given below:

Table 2-42 Criteria Details

Field	Do this
Seq	View sequence number.
(Indicates opening bracket.
Parameter	View the parameter selected for the criteria.
Comparison Operator	View the comparison operator selected for the criteria.
Criteria Value	View the criteria value.
)	Indicates closing bracket.
Logical Expression	View the logical operator selected for the criteria.
Enabled	Y indicates event selection criteria is enabled and N indicates disabled.

Action

In the Actions sub tab, view the actions that the system performs after the event is triggered. There can be more than one event action for a particular event. The Seq field defines the order in which the event action should occur. System supports the following batch event actions:

- Send letter for an application
- Generate correspondence for an application

A brief description of the fields is given below:

Table 2-43 Action

Description	View the event action description.
Seq	View sequence number defined for the action.
Enabled	Y indicates event action is enabled and N indicates disabled.

For each event action, view the **Action Parameters** defined. A brief description of the fields is given below:

Table 2-44 Action Parameters

Field	Do this
Description	View the parameter description.
Value	View the parameter value.
Required	Y indicates action parameter is required and N indicates not-required

2.9.2 Events (New Framework)

Events in OFSLL refers to user/system generated actions on the system such as updating an account condition as delinquent or moving the status of a collateral from **INACTIVE** to **ACTIVE** and so on. Whenever such a type of event occurs some defined action can be performed by the system.

When there is change in entities like Account, Customer and so on by performing an insert/update operation on the base table, system can trigger a defined event with an associated event action to expose the same for third-party applications through JMS message or perform OFSLL actions like posting Comment/Call Activity and so on.

The Events tab serves as a common framework for Line module. In a single flow you can define **events** with associated actions for entities like Account, Customer and so on with the type of processing mode as either Online or Batch mode. Further, you can define one or more event criteria as a trigger when the corresponding event occurs. For each defined criteria you can define the available event action and associated action parameter(s) to initiate corresponding action in external / internal system.

Figure 2-18 Events Workflow

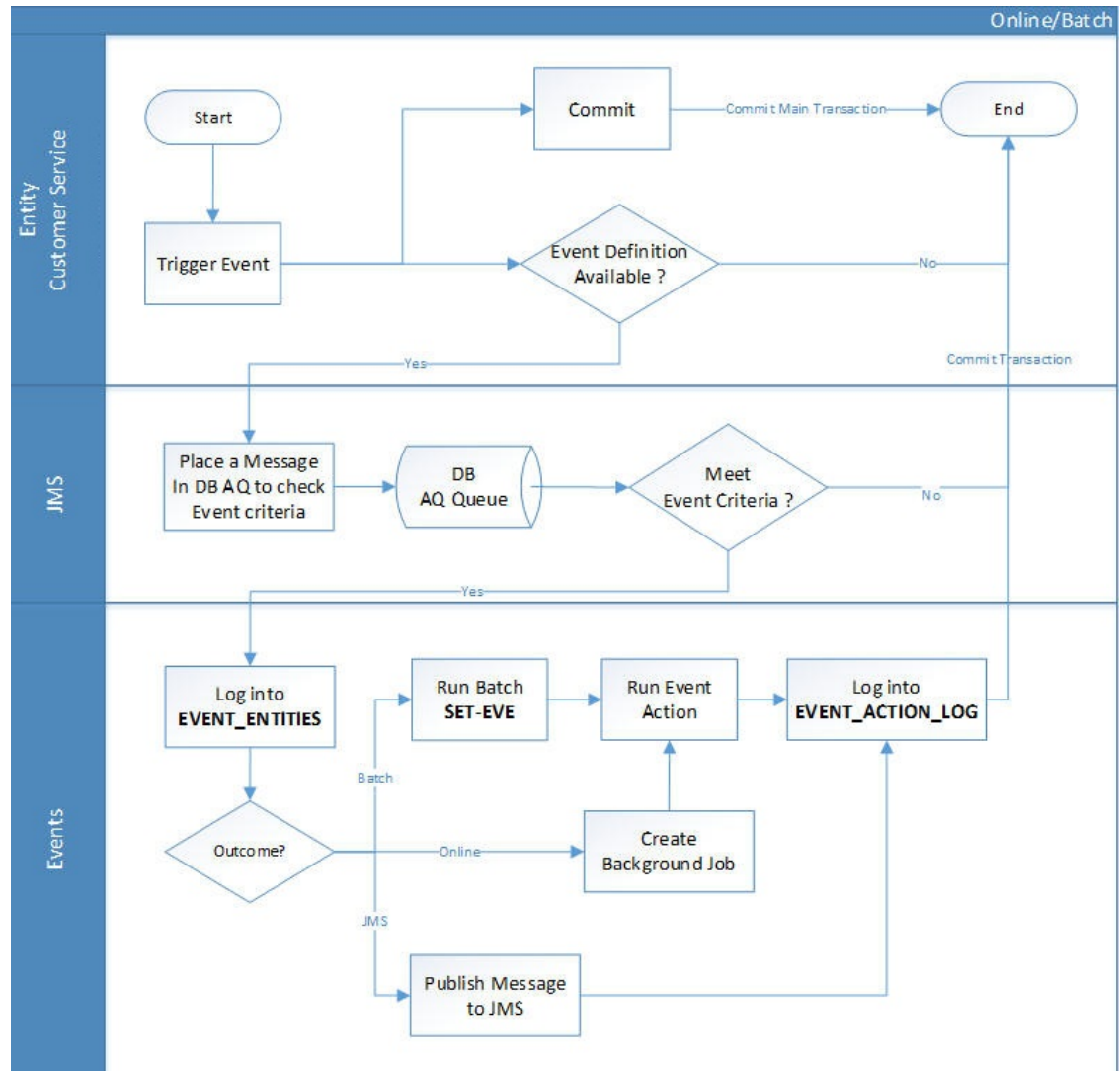

As per the above workflow:

- During Servicing stage, when an event is triggered, the main transaction is committed and a new parallel transaction is created to check if there is an event definition available.
- If there is an event definition available, system places an AQ (Advanced Queueing) message in database to check for any matching event criteria. There can be one or more criteria for an event in database which is further evaluated to get the matching criteria. On identifying a matching criteria, the defined event with criteria is logged into event entities.
- Based on the Event Type, system executes the associated Event Actions.
 - If the event is configured to Batch mode, the event action is performed when the following batch jobs - EVEPRC_BJ_100_01 (BATCH EVENTS PROCESSING for the Entities Account/Application/Assets) and/or EVEPRC_BJ_100_03 (BATCH EVENTS PROCESSING for the Entities Customer/Business/Vendors/Producers) is executed.
 - If the event is configured to Online mode, system performs the corresponding actions immediately.

- If the Event Action is defined as JMS, a json message is generated with the below format. You can configure additional details into the message by using response User Defined Tables. The data added in this table will be represented in Custom Block as illustrated in the example below.

Figure 2-19 Events_Json_format

```
{
  "EventDetail": {
    "EventID": 8535,
    "EventType": "ACC_CREATE",
    "EventMessage": "ACO CREATE ACCOUNT LINE",
    "EntityNbr": "201XXXXXXXX9",
    "EventStartDt": "2019-04-05T02:48:35",
    "EventProcessedDt": "2019-04-05T02:48:35",
    "Custom": [
      {
        "CustomTabName": "User Defined Table 1",
        "DateData": [{
          "KeyName": "CreationDate",
          "KeyValue": "2017-12-18T00:00:00"
        }],
        "NumberData": [{
          "KeyName": "BusinessPhoneNumber",
          "KeyValue": 1234567890
        }],
        "StringData": [{
          "KeyName": "OrgName",
          "KeyValue": "Oracle"
        }]
      },
      {
        "CustomTabName": "User Defined Table 2",
        "DateData": [{
          "KeyName": "CreationDate",
          "KeyValue": "2017-12-18T00:00:00"
        }],
        "NumberData": [{
          "KeyName": "BusinessPhoneNumber",
          "KeyValue": 1234567890
        }],
        "StringData": [{
          "KeyName": "OrgName",
          "KeyValue": "Oracle"
        }]
      }
    ]
  }
}
```

- The following table indicates parameters available for JMS action type definition.

Table 2-45 JMS action type definition

Parameter	Description	Display
EVENTID	System Generated Sequence	N
EVENTTYPE	Lookup Code of Event Type Code	N
EVENTMESSAGE	User entered event action message	Y
ENTITYNBR	Entity Number. For example, Account / Customer Number	N

Table 2-45 (Cont.) JMS action type definition

Parameter	Description	Display
EVENTSTARTDATE	Event Generation Date and Time	N
EVENTPROCESSDATE	Event Process Date and Time	N

Note

The parameter marked as **Y** in Display column are only available in event action screen for user configuration. Other parameters are system defined and will be part of every event.

- For each Event Action, there is a User Defined Table maintained in the system and the same is configurable. There is also User Defined Table maintained based on Response Parameters and the response fields can be used to configure Entity Key, Non-Key and Data columns for custom block of json message. Following combination of Event to UDT mapping are maintained in the system:
 - Entity Type | Event | Criteria UDT Type
 - Entity | Event Action | UDT Type | UDT Response Type

For complete list of the Events and Actions mapping maintained in the table **event_action_type_mapping**, refer to the reference below: https://docs.oracle.com/cd/F40454_01/pdf/refdocs/Events_UDT_Mapping.pdf

Navigating to Events

On the Oracle Financial Services Lending and Leasing home screen, click **Setup > Administration > System > Events > Events** tab.

To define an Event

1. Click **Setup > Setup > Administration > System > Events > Events** tab.

Figure 2-20 Define an Event

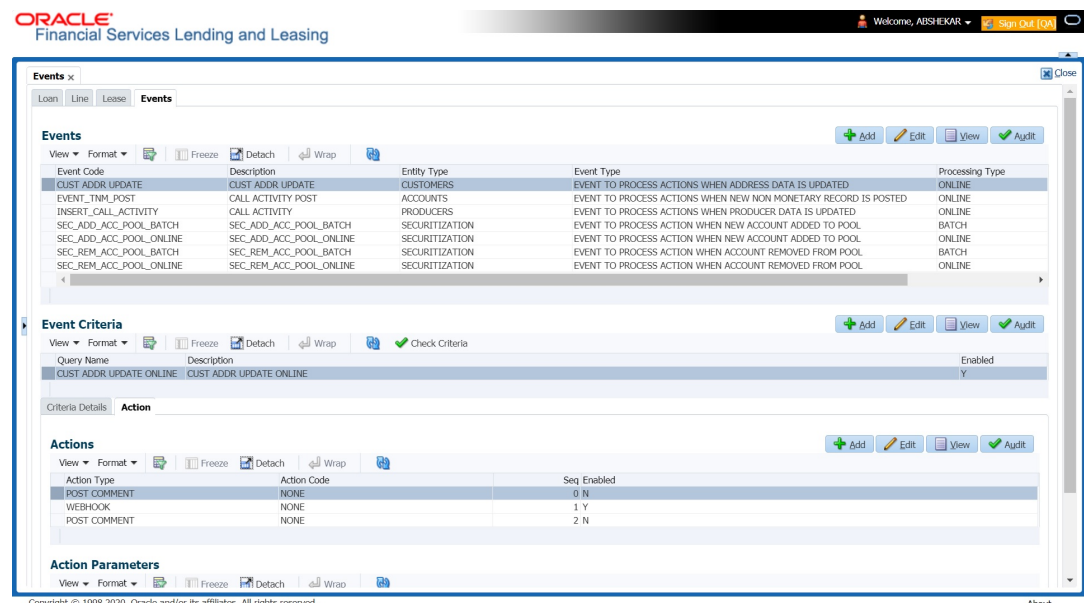

A brief description of the fields is given below:

Table 2-46 Navigation to Events

Field	Do this
Event Code	Specify the unique event code.
Description	Specify the event description.
Entity Type	Select the entity type from the drop-down list. The list is populated based on EVENT_ENTITY_TYPE_CD lookup code.
Event Type	Select the event identification type for the entity from the dropdown list. The list is populated based on EVENT_TYPE_CD lookup code.
Processing Type	Specify the processing type as either ONLINE or BATCH from the drop-down list. The list is populated based on EVENT_PROCESS_TYPE_CD lookup code. <ul style="list-style-type: none"> For Online events, when the event is triggered corresponding actions are processed immediately. Here all the event action executions are asynchronous and does not impact main transaction. For Batch events, the event is triggered when the following batch jobs - EVEPRC_BJ_100_01 (BATCH EVENTS PROCESSING for the Entities Account/Application/Assets) and/or EVEPRC_BJ_100_03 (BATCH EVENTS PROCESSING for the Entities Customer/Business/Vendors/Producers) is executed and actions are processed.
Enabled	Check this box to activate the event type.

- Perform any of the [Basic Actions](#) mentioned in Navigation chapter. In the **Event Criteria** sub tab, you can create a query to an event.
- In the **Event Criteria** sub tab, perform any of the [Basic Operations](#) mentioned in Navigation chapter.
A brief description of the fields is given below:

Table 2-47 Event Criteria

Field	Do this
Query Name	Specify the unique query name.
Description	Specify the event criteria description.
Enabled	Check this box to enable the event criteria.

- Perform any of the [Basic Actions](#) mentioned in Navigation chapter.
Criteria Details

The Criteria Details sub tab allows you to define the selection criteria for the event. System uses these criteria to determine which application to include in the event action.

- In the **Criteria Details sub tab**, perform any of the [Basic Operations](#) mentioned in Navigation chapter.

Note

Although system allows to define customized selection criteria, the execution of additional selection criteria requires additional processing at server level and can have significant performance impact delaying the EOD processing/web services. Hence it is recommended to have careful consideration while defining the additional selection criteria (like using user-defined tables and columns) and/or get approval from your database administrator before using any selection criteria.

A brief description of the fields is given below:

Table 2-48 Criteria Details

Field	Do this
Seq	Specify sequence number.
(Specify the opening bracket.
Parameter	Select the parameter from the drop-down list.
Comparison Operator	Select comparison operator from the drop-down list.
Criteria Value	Specify the criteria value.
)	Specify the closing bracket.
Logical Expression	Select the logical operator from the drop-down list.
Enabled	Check this box to enable the criteria details.

- Perform any of the [Basic Actions](#) mentioned in Navigation chapter.

Actions

In the Actions sub tab, you can define the event action that the system need to perform when the event is triggered. You can define more than one event action for a particular event and use the Seq field to define the order in which the event action should occur.

- In the Action sub tab, perform any of the [Basic Operations](#) mentioned in Navigation chapter.

A brief description of the fields is given below:

Table 2-49 Actions

Field	Do this
Action Type	Select the action type from the drop-down list. The list is populated based on EVENT_ACTION_TYPE_CD lookup code.
Action Code	The action code is displayed as None by default.
Seq	Specify the sequence number of executing the event action.
Enabled	Check this box to enable the event action.

- Perform any of the [Basic Actions](#) mentioned in Navigation chapter.

Action Parameters

In the **Action Parameters** sub tab, you can define the action parameters with corresponding values for each event action.

9. To define the Action Parameters, in the **Action** sub tab, click Add or Edit. You can also perform any of the [Basic Operations](#) mentioned in Navigation chapter.
10. Click **Load Parameters**. The applicable Action Parameters are loaded for update. A brief description of the fields is given below:

Table 2-50 Action Parameters

Field	Do this
Description	System auto populate the description from user defined table based on Action code selected.
Value Type	<p>Select the value type as one of the following which is to be included during event action execution from the drop-down list. The list is populated based on EVENT_VALUE_TYPE_CODE lookup code.</p> <ul style="list-style-type: none"> • CONSTANT • SYSTEM DRIVEN • USER INPUT • COLUMN VALUE (For this value type, the Action Parameter values are displayed from User Defined Tables based on the Event Type. However, note that if the column value cannot be fetched due to multiple records or if no record exist, then action parameter value is displayed blank/null). <p>Currently the Column Value is configured to refer only Accounts table (Entity Type) and can process the following Event Actions Type:</p> <ul style="list-style-type: none"> • POST COMMENT • POST MONETARY TRANSACTION • POST NON MONETARY TRANSACTION <p>For SEND CORRESPONDENCE Action Type, there are additional parameters - USER DEFINED ELEMENT and USER DEFINED CONSTANT available in Setup > Correspondence screen to provide input during execution of Event Action. The same is available in Events screen and can be modified before triggering the event action.</p>
Value	<p>If the Value Type is selected as CONSTANT, specify the required action parameter value.</p> <p>If the Value Type is selected as SYSTEM DRIVEN, you can add the following values for system to derive the parameter values during the execution of the Event.</p> <p>\$GLDATE - GL DATE System Parameter Value</p> <p>\$PAYMENTAMOUNT - Account Monthly Payment Amount</p> <p>\$OUTSTANDINGAMOUNT - Account Total Outstanding Amount</p> <p>\$RATE - Account Rate</p> <p>\$TOTALTERM - Account Total Term</p> <p>\$AVAILABLETERM - Account Available Term</p>
Required	Y indicates the action parameter is required, else No .

11. Perform any of the [Basic Actions](#) mentioned in Navigation chapter.

2.9.3 Monitoring JMS Event Actions

You can verify the status of events and event actions on the Monitor Jobs screen of the System Monitor screen.

To monitor events

1. On the Oracle Financial Services Lending and Leasing home screen, click **Dashboard > Dashboard > System Monitor > JMS Queues**.
The JMS Queues screen displays the **Status** for all asynchronous events processed in the system.

For more details, refer to Dashboard > System Monitor section in any of the User Guides.

2.10 Batch Jobs

Batch jobs refer to the back-end processes that automatically run at a certain time. There are two types of batch jobs:

- Business processes (such as billing and delinquency processing)
- Housekeeping tasks (such as application aging and application purging)
- [Batch Jobs](#)
- [Batch Jobs Available](#)

2.10.1 Batch Jobs

The Batch Job screen allows you to set up, monitor, and maintain batch jobs in the system.

Batch jobs can be set up to be performed on a daily, weekly, monthly, and ad-hoc basis. Batch jobs can also be configured to trigger an e-mail or phone message if a batch job fails.

Critical batch jobs control job flow and system date rollover to allow recovery during errors. Errors are instances where a process did not successfully complete. Failures indicate that a particular job encountered errors that require remedial action. The number of errors allowed before failure is defined for each job. Some errors automatically result in a failure.

Navigating to Batch Jobs:

1. On the Oracle Financial Services Lending and Leasing home screen, click **Setup > Setup > Administration > System > Batch Jobs**. The Batch Jobs details are further grouped into two tabs:
 - [Batch Jobs](#)
 - [Job Holidays](#)

2.10.1.1 Batch Jobs

In the Batch Job Setup screen, you can track and maintain all batch processes within the system. Using this form, the system administrator can configure the frequency and start time of each batch process, as well as set the number of threads to improve performance.

Threading allows a specific job to be separated into smaller units that are processed at the same time. This allows Oracle Financial Services Lending and Leasing to complete the job in less time.

You can set up multiple batch jobs within a batch set. In the Batch Job Sets section, each process is listed with the last run date (Last Run Dt field) and the next scheduled process date (Next Run Dt field). In the Freq Code and Freq Value fields, you can determine the frequency of each batch set, such as daily, weekly and monthly. You can also set up batch sets to incorporate a dependency on another batch set. This way, if the initial batch fails, the dependent set will not be processed.

In the Batch Jobs section, you can configure the process to run on weekends and holidays using the respective option boxes.

CAUTION: As the batch job setup widely affects the Oracle Financial Services Lending and Leasing system, Oracle Financial Services Software suggests that the system administrator has a clear understanding of the various functionalities within Oracle Financial Services Lending and Leasing before creating and updating the batch processes.

For the standard job set please review the Visio document, **dbk_std_detail_design_job_sets.vsd**

Configure Batch Jobs at Company Level

OFSL is enabled to process the configured batch jobs at each Company level giving a flexibility to schedule and run batch job or EOD processing at desired time zone. Irrespective of Company or Branch, the batch jobs can be run independently on specific time in scheduler. For more details on configuring the batch job at each company definition level, refer to Appendix - Configuration at Company Level chapter.

To setup a Batch job

1. Click **Setup > Setup > Administration > System > Batch Jobs**.
2. In the Batch Job Sets section, you can make use of the copy option to copy the whole batch job set at one go with header and detailed records for each company definition. To do so, select the Company from drop-down list and click **Create Copy**. System copies the batch job sets from the selected Company record to the Company selected from dropdown list. All those batch job set which are not already available in the selected Company are copied.
Note that:
 - The **Create Copy** option can be used multiple times.
 - The Company drop-down list is displayed based on the User Access defined for the logged-in user.
3. Perform any of the [Basic Operations](#) mentioned in Navigation chapter.

Figure 2-21 Batch Jobs

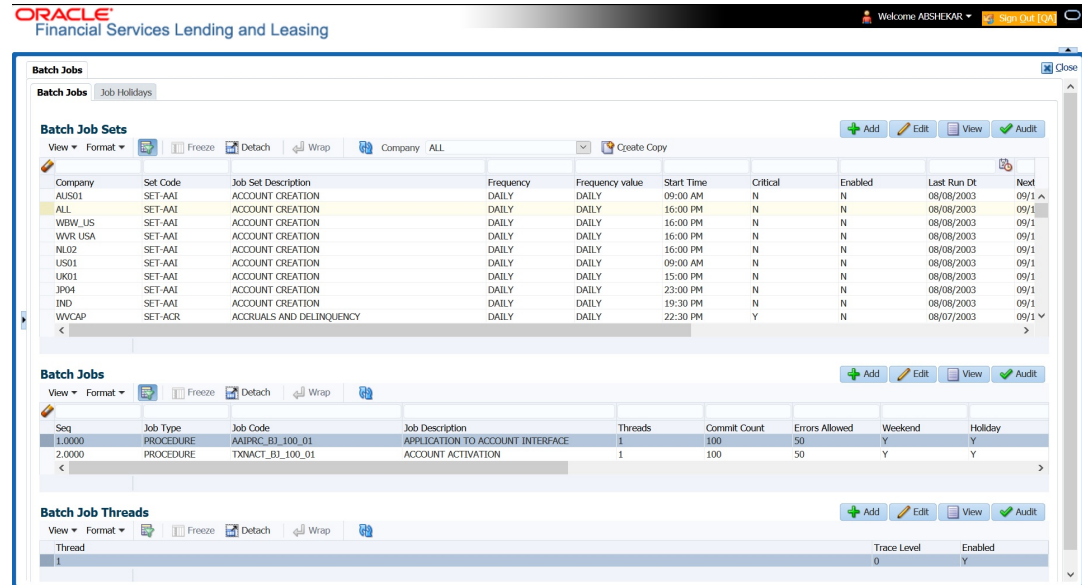

A brief description of the fields is given below:

Table 2-51 Batch job - Setup

Field	Do this
Company	Select the company from the drop-down list. The list is populated only with those Company Definitions to which you have been provisioned access. This company is considered if system is setup to process batch jobs at Company level. For more information, refer to Appendix - Company Level GL Date Configuration section.
Set Code	Specify the code for the batch job set.
Job Set Description	Specify the description for the batch job set.
Frequency	Select the frequency at which the job set is to be executed from the drop-down list.
Frequency Value	Select the frequency value from the drop-down list. The frequency value will be displayed based on the frequency code selected.
Start Time	Specify the start time for the job set.
Critical	Check this box to set job as critical. A critical job is one that prevents the General Ledger (GL) post date from rolling forward, should the job fail.
Enabled	Check this box to enable the job set.
Last Run Dt	The system displays the last run date of the job set.
Next Run Dt	Specify the next run date for job set. You can select the data from adjoining calendar icon.
Parent	Select the parent job set from drop-down list.

Table 2-51 (Cont.) Batch job - Setup

Field	Do this
Dependency	Select the type of dependency on the parent from drop-down list.

- Perform any of the [Basic Actions](#) mentioned in Navigation chapter.
- In the **Batch Job** section, perform any of the [Basic Operations](#) mentioned in Navigation chapter.
A brief description of the fields is given below:

Table 2-52 Batch Job - Navigation

Field	Do this
Seq	Specify the batch job sequence number. Note: Within a job set, jobs are executed sequentially based on the sequence number assigned.
Job Type	Select the batch job request type from the drop-down list.
Job Code	Specify the batch job request code.
Job Description	Specify the batch job description.
Threads	The system displays the number of threads used by the job.
Commit Count	Specify the number of rows after which auto-commit is triggered.
Errors Allowed	Specify the number of errors allowed.
Weekend	Check this box to perform batch jobs on weekend.
Holiday	Check this box to perform batch jobs on a holiday. (Holidays are defined on the Job Holidays screen.)
Enabled	Check this box to enable the batch job.
Parent	Select the parent batch job from the drop-down list.
Dependency	Select the dependency clause of the batch job from the drop-down list.
Command	Specify the command line for the job (required).
RollbackSegment	If you choose, use this field to specify the rollback segment for job.

- Perform any of the [Basic Actions](#) mentioned in Navigation chapter.
- In the **Batch Job Thread** section, perform any of the [Basic Operations](#) mentioned in Navigation chapter.
A brief description of the fields is given below:

Table 2-53 Batch Job Thread

Field	Do this
Thread	Specify the name of thread.

Table 2-53 (Cont.) Batch Job Thread

Field	Do this
Trace	Specify the SQL trace level (0, 1, 4, 8, 12). The higher the number, the more activities the system can trace.
Enabled	Check this box to enable the thread.

8. Perform any of the [Basic Actions](#) mentioned in Navigation chapter.

2.10.1.2 Job Holidays

The system allows you to define holidays within the company on Job Holidays screen. You can then use the Batch jobs screen to set up whether you want the system to perform batch jobs on these days or not, using the Holiday box of Batch Jobs section.

To define job holidays

1. Click **Setup > Setup > Administration > System > Batch Jobs > Job Holidays**.
2. In the **Job Holidays** section, perform any of the [Basic Operations](#) mentioned in Navigation chapter.

Figure 2-22 Job Holidays

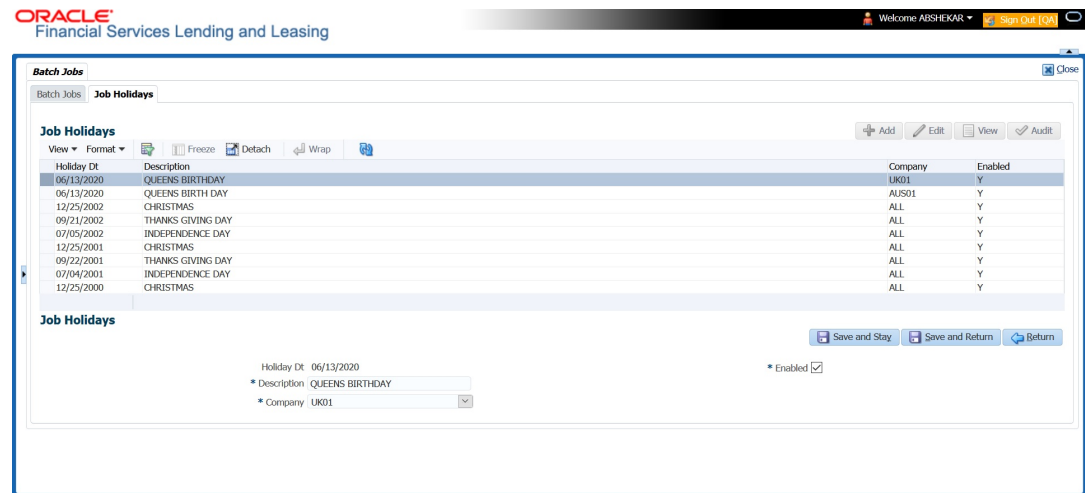

A brief description of the fields is given below:

Table 2-54 Job Holidays

Field	Do this
Holiday Dt	Specify the date of the job holiday. You can select the date from the adjoining calendar icon.
Description	Specify the job holiday description (required).

Table 2-54 (Cont.) Job Holidays

Field	Do this
Company	Select the company from the drop-down list. The list is populated only with those Company Definitions to which you have been provisioned access. This company is considered if system is setup to process holiday at Company level. For more information, refer to Appendix - Company Level GL Date Configuration section.
Enabled	Check this box to enable the holiday.

3. Perform any of the [Basic Actions](#) mentioned in Navigation chapter.

2.10.2 Batch Jobs Available

The below table provides a list of Batch Jobs maintained in the system and a brief description to each:

Table 2-55 Batch Jobs Available

Engine Type	Description	Batch Job	Description	Origination	Servicing	Collection	Product	Comment
AAE	Application Account Interface	aaiprc_bj_100_01	APPLICATION TO ACCOUNT INTERFACE	No	Yes	No	Common	This process periodically picks up applications in Approved-Verified status and creates accounts.
ACH	ACH Accounts	acaprc_bj_100_01	ACCOUNT ACH PROCESSING	No	Yes	No	Common	This process produces the ACH file for the eligible customer payments.
ACH	ACH Producers	acpprc_bj_100_01	PRODUCER ACH PROCESSING	Yes	Yes	No	Common	This process produces the ACH file for the eligible producer payments
ACH	ACH Vendors	acvprc_bj_100_01	VENDOR ACH PROCESSING	No	Yes	No	Common	This process produces the ACH file for the eligible vendor payments.

Table 2-55 (Cont.) Batch Jobs Available

Engine Type	Description	Batch Job	Description	Origination	Servicing	Collection	Product	Comment
ACH	ACH Producer/ Vendors/ Customer/ Third Party	acxprc_bj_100_01	ACH Producer/ Vendors/ Customer/ Third Party	Yes	Yes	No	Common	This process produces the ACH file for the eligible Producer/ Vendors/ Customer/ Third Party
AGE	Aging Applications	agaapp_bj_100_01	APPLICATION AGING PROCESS	Yes	No	No	Common	This process puts applications into Aged-Application substatus.
AGE	Aging Contracts	agcon_bj_100_01	CONTRACT AGING PROCESS	Yes	No	No	Common	This process puts contracts into Aged-Contract substatus.
ALTPFS	ALLOTMENT EXTRACT FILE DUMP	PFSEFT PRC_BJ_111_01	BACKUP EFT	No	Yes	No	Common	This process creates the Backup EFT file
ALTPFS	ALLOTMENT EXTRACT FILE DUMP	PFSLBA PRC_BJ_100_01	POSTING ALLOTMENT PAYMENTS	No	Yes	No	Common	This process posts the payments from the allotment file received from the bank
ALTPFS	ALLOTMENT EXTRACT FILE DUMP	PFSOD DALT_BJ_100_01	ALLOTMENT EXTRACT FILE DUMP	No	Yes	No	Common	This process sends the allotment draft notice to the bank
ALTPFS	ALLOTMENT EXTRACT FILE DUMP	PFSNSF PRC_BJ_100_01	NSF BATCH	No	Yes	No	Common	This process posts the NSF file received from the bank
API	API Accounts	accaai_bj_100_01	API AAI	No	Yes	No	Common	This process creates accounts from validated conversion applications/ contracts

Table 2-55 (Cont.) Batch Jobs Available

Engine Type	Description	Batch Job	Description	Origination	Servicing	Collection	Product	Comment
API	API Accounts	accdmp_bj_100_01	MOVE API_XX TO ITABS	No	Yes	No	Common	This process copies data from conversion API tables to conversion applications table
API	API Accounts	accval_bj_111_01	VALIDATE ITABS (LOAN)	No	Yes	No	Loan	This process validate all conversion applications loan accounts by running the edits
API	API Accounts	accval_bj_112_01	VALIDATE ITABS (LINE)	No	Yes	No	Line	This process validate all conversion applications line of credit accounts by running the edits
API	API Accounts	acmprc_bj_100_01	LOAD API_COMMENTS	No	Yes	No	Common	This process creates account comments from conversion applications/ contracts

Table 2-55 (Cont.) Batch Jobs Available

Engine Type	Description	Batch Job	Description	Origination	Servicing	Collection	Product	Comment
API	API Accounts	APIDMP_BJ_100_01	LOAD API RECORDS	No	Yes	Yes	Common	<p>This process directly reads data from database folder and using the external tables loads it into API tables for creating accounts.</p> <p>This eliminates the need/dependency of SQL loader and Control files.</p> <p>Ensure that account data in Input file has same structure as defined in Setup > Data Files > Input definition specifically for Loan, Line & Lease accounts.</p>

Table 2-55 (Cont.) Batch Jobs Available

Engine Type	Description	Batch Job	Description	Origination	Servicing	Collection	Product	Comment
SETAPI2	ASYNCHRONOUS ACCOUNT CREATION	ACXVAL_BJ_100_01	VALIDATE IAPP TABS	Yes	Yes	Yes	Common	<p>This process is used to validate the data from the Account On-Boarding request.</p> <p>This process is the first stage in processing asynchronous account creation using Account on-boarding web service and is controlled based on value defined in system parameter - ACCOUNT_PROCESSING_THRESHOLD.</p>

Table 2-55 (Cont.) Batch Jobs Available

Engine Type	Description	Batch Job	Description	Origination	Servicing	Collection	Product	Comment
SETAPI2	ASYNCHRONOUS ACCOUNT CREATION	ACXAAI_BJ_100_01	ASYNCHRONOUS ACCOUNT CREATION	Yes	Yes	Yes	Common	<p>This process is used for asynchronous accounts creation using Account onboarding web service.</p> <p>This process is the next stage after successful validation of account creation request without any errors.</p> <p>Based on the request and system parameter value in ACCOUNT_PROCESSING_THRESHOLD accounts are created in the system with all the details and with Status of account as Active, Error, Void.</p> <p>Note: These Accounts can have Account Number generated externally or require OFSLL to generate these number.</p>
COL	Appointment Cancellation	caprc_bj_100_01	APPOINTMENT CANCELLING	No	Yes	Yes	Common	This process cancels all the expired appointments.

Table 2-55 (Cont.) Batch Jobs Available

Engine Type	Description	Batch Job	Description	Originat ion	Servicin g	Collecti on	Product	Comment
COL	Payment Promise Processing	cpprc_bj_100_01	BROKEN PROMISE PROCESSING	No	Yes	No	Common	This process updates any broken promises as of the run time.
CRB	Credit Bureau Reporting	cbuutl_bj_100_01	CREATE METRO2 FILE	No	Yes	No	Common	This process creates the METRO2 file for Credit Bureau reporting for the specified date.
DOT	Document Tracking Load	dolprc_bj_000_01	ACCOUNT DOCUMENT LOAD	No	Yes	Yes	Common	This process reads acct_doc_load directory. Attach the documents to specified accounts and move documents to appropriate directory
DLX	Accounts Dialer Exclusion	ODXPR C_BJ_100_01	ACCOUNTS DIALER EXCLUSION	No	Yes	Yes	Common	This process generates a dialer exclusion file with account details and checks if the maintained call action result entry is made on any account during the specified time interval.
GLP	GL Interface	gliprc_bj_100_01	GL SUMMARIZATION	No	Yes	No	Common	This process summarizes GL transactions for the day.
GOV	Debt Reporting IRS 1099A / 1099C	gdraap_bj_100_01	IRS 1099-A PROCESSING	No	Yes	No	Common	This process generates the 1099-A flat file for government reporting.

Table 2-55 (Cont.) Batch Jobs Available

Engine Type	Description	Batch Job	Description	Origination	Servicing	Collection	Product	Comment
GOV	Debt Reporting IRS 1099A / 1099C	gdrcad_bj_100_01	IRS 1099-C PROCESSING	No	Yes	No	Common	This process generates the 1099-C flat file for government reporting.
GOV	HMDA Reporting	ghrprc_bj_100_01	IRS HMDA PROCESSING	Yes	No	No	Common	This process generates the HMDA flat file for government reporting.
GOV	Interest Reporting IRS 1098	girprc_bj_100_01	IRS 1098 PROCESSING	No	Yes	No	Common	This process generates the 1098 flat file for government reporting.
JOB	Scheduler	jsctst_bj_000_01	Scheduler	Yes	Yes	Yes	Common	This process test the job scheduler
LBP	Lockbox	lboxprc_bj_100_01	LOAD LOCKBOX PROCESSING	No	Yes	No	Common	This process loads any lockbox files available. This process can be set to run periodically throughout the day.
LNT	Lien Tracking	OFDPR_C_BJ_11_03	OUTPUT LIEN TRACKING FOR DATA CHANGE	No	Yes	No	Common	This process generates output file with changes in customer information such as Address/ Phone no./ Borrower/ Coborrower name.
LNT	Lien Tracking	OFDPR_C_BJ_11_04	OUTPUT LIEN TRACKING FOR VOID ACCOUNT	No	Yes	No	Common	This process generates output file for Void Accounts to be sent to dealer track.

Table 2-55 (Cont.) Batch Jobs Available

Engine Type	Description	Batch Job	Description	Origination	Servicing	Collection	Product	Comment
LTR	Collections Letter	lcolt1_bj_100_01	GENERATE FIRST COLLECTION LETTER	No	No	Yes	Common	This process generates the first collection letter for eligible accounts.
LTR	Collections Letter	lcolt2_bj_100_01	GENERATE SECOND COLLECTION LETTER	No	No	Yes	Common	This process generates the second collection letter for eligible accounts.
LTR	Collections Letter	lcolt3_bj_100_01	GENERATE THIRD COLLECTION LETTER	No	No	Yes	Common	This process generates the third collection letter for eligible accounts.
LTR	Customer Service Letter	lcspdf_bj_111_01	PAID IN FULL LETTER	No	Yes	No	Loan	This process generates the paid-in full letter for the relevant accounts.
LTR	Customer Service Letter	lcspoq_bj_111_01	PAYOFF QUOTE LETTER	No	Yes	No	Common	This process generates the payoff quote letter for the requested accounts.
LTR	Customer Service Letter	lcsstm_bj_100_01	CUSTOMER STATEMENT LETTER	No	Yes	No	Common	This process generates the customer/business statement letter for requested accounts.
LTR	Customer Service Letter	lcswel_bj_111_01	WELCOME LETTER	No	Yes	No	Loan	This process generates the welcome letter for the newly funded accounts.
LTR	Origination Letter	loraco_bj_111_01	Origination Adverse Action Letter (Conditional) (Loan)	Yes	No	No	Loan	This process generates the adverse action letter for relevant applications.

Table 2-55 (Cont.) Batch Jobs Available

Engine Type	Description	Batch Job	Description	Origination	Servicing	Collection	Product	Comment
LTR	Origination Letter	loradv_bj_111_01	Origination Adverse Action Letter (Loan)	Yes	No	No	Loan	This process generates the adverse action letter for relevant applications.
ODD	Coupon Book Dump File	ocnprc_bj_100_01	CUSTOMER COUPON BOOK GENERATION	No	Yes	No	Common	This process generates coupon books, if appropriate.
ODD	Output Data Dump File	oddprc_bj_000_01	CREATE OUTPUT DATA DUMP FILES	Yes	Yes	Yes	Common	This process creates any defined output data dump files set in the system.
ODD	Collections Letter	olclt1_bj_100_01	COLLECTION LETTER 1 FILE CREATION	No	No	Yes	Common	This process generates the first collection letter for eligible accounts.
ODD	Collections Letter	olclt2_bj_100_01	COLLECTION LETTER 2 FILE CREATION	No	No	Yes	Common	This process generates the second collection letter for eligible accounts.
ODD	Collections Letter	olclt3_bj_100_01	COLLECTION LETTER 3 FILE CREATION	No	No	Yes	Common	This process generates the third collection letter for eligible accounts.
ODD	Origination Letter	oloaco_bj_100_01	ADVERSE ACTION CONDITIONAL LETTER FILE CREATION	Yes	No	No	Common	This process generates the adverse action letter for relevant applications.
ODD	Origination Letter	oloadv_bj_100_01	ADVERSE ACTION LETTER FILE CREATION	Yes	No	No	Common	This process generates the adverse action letter for relevant applications.

Table 2-55 (Cont.) Batch Jobs Available

Engine Type	Description	Batch Job	Description	Origination	Servicing	Collection	Product	Comment
ODD	Customer Service Letter	olspdf_bj_100_01	PAID IN FULL FILE CREATION	No	Yes	No	Common	This process generates the paid-in full letter for the relevant accounts.
ODD	Customer Service Letter	olspoq_bj_100_01	PAY OFF QUOTE FILE CREATION	No	Yes	No	Common	This process generates the payoff quote letter for the requested accounts.
ODD	Customer Service Letter	olswel_bj_100_01	WELCOME LETTER FILE CREATION	No	Yes	No	Common	This process generates the welcome letter for the newly funded accounts.
ODD	Producer Statement Dump File	opsprc_bj_100_01	DEALER STATEMENTS GENERATION	No	Yes	No	Common	This process generates the dealer/producer statements at the specified frequency.
ODD	Customer Statement Dump File	ostprc_bj_100_01	CUSTOMER STATEMENTS GENERATION	No	Yes	No	Common	This process generates the customer/business statement for eligible accounts.
PRQ	Payable Requisition Customer	pcuprc_bj_100_01	CUSTOMER REFUND PAYMENT REQUISITIONS	No	Yes	No	Common	This process creates requisitions for customer/business overpayment refunds.
PRQ	Payable Requisition Producer	ppores_bj_100_01	MONTH END DEALER RESERVE PAYMENT REQUISITIONS	No	Yes	No	Common	This process creates requisitions for dealer compensation payments on month-end.
PRQ	Payable Requisition Vendor	pvnprc_bj_100_01	VENDOR INVOICE PAYMENT REQUISITIONS	No	Yes	No	Common	This process creates requisitions for vendor invoice payments.

Table 2-55 (Cont.) Batch Jobs Available

Engine Type	Description	Batch Job	Description	Origination	Servicing	Collection	Product	Comment
PUR	Archive Accounts	pacarc_bj_100_01	ARCHIVE ACCOUNT DATA TO OTABLES	No	Yes	Yes	Common	This process archives account data from ACCOUNTS table to OACCOUNTS table.
PUR	Archive Accounts	pacarc_bj_100_02	ARCHIVE ACCOUNT DATA TO OOTABLES	No	Yes	Yes	Common	This process archives account data from OACCOUNTS table to OOACCOUNTS table.
PUR	Archive Applications	paparc_bj_100_01	ARCHIVE APPLICATION DATA TO OTABLES	Yes	No	No	Common	This process archives application-related data from APPLICATIONS to OAPPLICATIONS table.
PUR	Archive Applications	paparc_bj_100_02	ARCHIVE APPLICATION DATA TO OOTABLES	Yes	No	No	Common	This process archives application-related data from OAPPLICATIONS to OOAPPLICATIONS table.
PUR	Archive GL	pglarc_bj_100_01	ARCHIVE GL DATA TO OTABLES	No	Yes	Yes	Common	This process archives General Ledger data from GL tables to OGL tables.
PUR	Archive GL	pglarc_bj_100_02	ARCHIVE GL DATA TO OOTABLES	No	Yes	Yes	Common	This process archives General Ledger data from OGL tables to OOGL tables.
PUR	Purge Job Requests	pjrjrq_bj_100_01	Purge Job Requests	Yes	Yes	Yes	Common	This process purges job requests from the system.

Table 2-55 (Cont.) Batch Jobs Available

Engine Type	Description	Batch Job	Description	Origination	Servicing	Collection	Product	Comment
PUR	Purge Output Data Dump	pododh_bj_100_01	PURGE OUTPUT DATA HEADERS	No	Yes	Yes	Common	This process purges Output Data Headers from the system based on the days defined in system parameter POD_ARCHIVE_DAYS..
PUR	Archive Securitization	ppaarc_bj_100_01	ARCHIVE POOL DATA TO OTABLES	No	Yes	No	Common	This process archives securitization data from TABLE to corresponding OTABLE.
PUR	Archive Securitization	ppaarc_bj_100_02	ARCHIVE POOL DATA TO OOTABLES	No	Yes	No	Common	This process archives securitization data from OTABLE to corresponding OOTABLE.
PUR	Archive Producers	pprarc_bj_100_01	ARCHIVE PRODUCER DATA TO OTABLES	Yes	Yes	Yes	Common	This process archives producer data from PRODUCERS table to OPRODUCERS table.
PUR	Archive Producers	pprarc_bj_100_02	ARCHIVE PRODUCER DATA TO OOTABLES	Yes	Yes	Yes	Common	This process archives producer data from OPRODUCERS table to OOPRODUCERS table.
PUR	Archive Producers Txns	ppxarc_bj_100_01	ARCHIVE PRODUCER TXNS DATA TO OTABLES	No	Yes	No	Common	This process archives producer transaction data from PRODUCERS table to OPRODUCERS table.

Table 2-55 (Cont.) Batch Jobs Available

Engine Type	Description	Batch Job	Description	Origination	Servicing	Collection	Product	Comment
PUR	Archive Producers Txns	ppxarc_bj_100_02	ARCHIVE PRODUCER TXNS DATA TO OOTABLES	No	Yes	No	Common	This process archives producer transaction data from OPRODUCE RS table to OOPRODUCERS table.
PUR	Archive Statements	pstarc_bj_100_01	ARCHIVE ACCOUNT STATEMENT AND TXNS DATA TO OTABLES	No	Yes	No	Common	This process archives account statement and transaction data from TABLE to corresponding OTABLE.
PUR	Archive Statements	pstarc_bj_100_02	ARCHIVE ACCOUNT STATEMENT AND TXNS DATA TO OOTABLES	No	Yes	No	Common	This process archives account statement and transaction data from OTABLE to OOTABLE.
PUR	Terminate User	ptusr_bj_100_01	Terminate User	Yes	Yes	Yes	Common	This process terminates user satisfying the selection criteria.
PUR	Archive Txns (To O tables)	ptxarc_bj_100_01	ARCHIVE TXNS DATA TO OTABLES	No	Yes	No	Common	This process archives data from TXNS table to OTXNS table.
PUR	Archive Txns (To OO tables)	ptxarc_bj_100_02	ARCHIVE TXNS DATA TO OOTABLES	No	Yes	No	Common	This process archives data from OTXNS table to OOTXNS table.

Table 2-55 (Cont.) Batch Jobs Available

Engine Type	Description	Batch Job	Description	Origination	Servicing	Collection	Product	Comment
SET-PUR	ARCHIVE PURGE JOB SET	PTXARC_BJ_100_11	NEW ARCHIVE TXNS DATA TO OTABLES	No	Yes	No	Common	<p>This process archives the following table data based on the number of archive days configured in system parameter PTX_INACTIVE_TXN_ARCHIVE_DAYS + inactive transactions (if txn_primary_ind = NO) and when the 'transaction post date (txn_post_dt) is less than batch job process date.</p> <ul style="list-style-type: none"> • TXNS to OTXNS • TXN_GROUPS_TEMP to OTXN_GROUPS_TEMP • TXNS_AUTHORIZATION_HISTORY to OTXNS_AUTHORIZATION_HISTORY <p>Also, this process archives table data from:</p> <ul style="list-style-type: none"> • TXNS_TEMP when the txn_post_dt less than batch job

Table 2-55 (Cont.) Batch Jobs Available

Engine Type	Description	Batch Job	Description	Origination	Servicing	Collection	Product	Comment
								process dt and based on the number of archive days configured in system parameter PTX_TMP_ARCHIVE_DAYS. • From PAYMENTS_TEMP to OPAYMENTS_TEMP when the pmt_dt less than batch job process dt and based on the number of archive days configured in system parameter PTX_TEMP_ARCHIVE_DAYS.

Table 2-55 (Cont.) Batch Jobs Available

Engine Type	Description	Batch Job	Description	Origination	Servicing	Collection	Product	Comment
SET-PUR	ARCHIVE PURGE JOB SET	PTXARC_BJ_100_12	NEW ARCHIVE TXNS DATA TO OOTABLES	No	Yes	No	Common	<p>This process archives the following table data based on the number of archive days configured in system parameter PTX_INACTIVE_TXN_OARCHIVE_DAYS + inactive transactions (if txn_primary_ind = NO) and when the 'transaction post date (txn_post_dt) is less than batch job process date.</p> <ul style="list-style-type: none"> • OTXNS to OOTXNS • OTXN_GROUPS_TEMP to OOTXN_GROUPS_TEMP • OTXNS_AUTHORIZATION_HISTORY to OOTXNS_AUTHORIZATION_HISTORY <p>Also, this process archives table data from:</p> <ul style="list-style-type: none"> • OTXNS_TEMP to OOTXNS_TEMP when the txn_post_dt less than

Table 2-55 (Cont.) Batch Jobs Available

Engine Type	Description	Batch Job	Description	Origination	Servicing	Collection	Product	Comment
								<p>batch job process dt and based on the number of archive days configured in system parameter PTX_TXN_TMP_OARCHIVE_DAYS.</p> <ul style="list-style-type: none"> From OPMT_TMP to OPMT_TMP when the pmt_dt less than batch job process dt and based on the number of archive days configured in system parameter PTX_PMT_TMP_OARCHIVE_DAYS.
PUR	Purge User Logins	pululg_bj_100_01	Purge User Logins	Yes	Yes	Yes	Common	This process purges user login data from the system.

Table 2-55 (Cont.) Batch Jobs Available

Engine Type	Description	Batch Job	Description	Origination	Servicing	Collection	Product	Comment
PUR	Archive Vendor Assignments	pvaarc_bj_100_01	ARCHIVE VENDOR ASSIGNMENTS DATA TO OTABLES	No	Yes	Yes	Common	This process archives vendor assignment data from TABLE to OTABLE. The criteria for archival is based on following validation - Work Order Status = Closed / Completed / Repossessed + Days mentioned in system parameter PVA_ARCHIVE_DAYS .
PUR	Archive Vendor Invoices	pviarc_bj_100_01	ARCHIVE VENDOR INVOICES DATA TO OTABLES	No	Yes	Yes	Common	This process archives vendor invoice data from TABLEs to OTABLEs. The criteria for archival is based on following validation - Invoice Status = Close + Days mentioned in system parameter PVI_ARCHIVE_DAYS .

Table 2-55 (Cont.) Batch Jobs Available

Engine Type	Description	Batch Job	Description	Origination	Servicing	Collection	Product	Comment
PUR	Archive Vendor Invoices	pviarc_bj_100_02	ARCHIVE VENDOR INVOICES DATA TO OOTABLES	No	Yes	Yes	Common	This process archives vendor invoice data from OOTABLEs to OOTABLEs based on the days mentioned in system parameter PVI_OARCHIVE_DAYS .
PUR	Archive Vendors	pvearc_bj_100_01	ARCHIVE VENDORS DATA TO OOTABLES	No	Yes	Yes	Common	This process archives vendor invoice data from TABLEs to OOTABLEs. The criteria for archival is based on following validation - Vendor end date is less than system date - Days mentioned in system parameter PVE_ARCHIVE_DAYS .
PUR	Archive Vendors	pvearc_bj_100_02	ARCHIVE VENDORS DATA TO OOTABLES	No	Yes	Yes	Common	This process archives vendor invoice data from OOTABLEs to OOTABLEs based on the days mentioned in system parameter PVE_OARCHIVE_DAYS .
QUE	Queue Customer Service	qcsprc_bj_100_01	CUSTOMER SERVICE QUEUE PROCESSING	No	Yes	Yes	Common	This process creates the customer service/ collections queues

Table 2-55 (Cont.) Batch Jobs Available

Engine Type	Description	Batch Job	Description	Origination	Servicing	Collection	Product	Comment
SETQCS	QUEUES	QCCPRC_BJ_100_01	CRITERIA BASED CONDITION POSTING	No	Yes	Yes		This process facilitates to post criteria based conditions on Account.
SETQRT	REAL TIME QUEUES	QCCPRC_BJ_100_02	CRITERIA BASED CONDITION POSTING REAL TIME PROCESSING		Yes	Yes		This batch job processes criteria based condition posting queues marked as real time based on refresh frequency setup in the job set.
RDB1	RDB1 Accounts	racdmp_bj_100_01	Data Dump Accounts	No	Yes	Yes	Common	This process transfers the account data from (OLTP) Regular tables to Temporary T tables
RDB1	RDB1 Applications	rapdmp_bj_100_01	LOAD APPLICATION RELATED DATA INTO T TABLES	Yes	No	No	Common	This process transfers the application data from (OLTP) Regular tables to Temporary T tables
RDB1	RDB1 Asset Tracking	ratdmp_bj_100_01	LOAD ASSET RELATED DATA INTO T TABLES	No	Yes	No	Common	This process transfers the account asset data from (OLTP) Regular tables to Temporary T tables

Table 2-55 (Cont.) Batch Jobs Available

Engine Type	Description	Batch Job	Description	Origination	Servicing	Collection	Product	Comment
RDB1	RDB1 Bankruptcy	rbktmp_bj_100_01	LOAD BANKRUPTCY DATA TO T TABLES	No	No	Yes	Common	This process transfers the account bankruptcy data from (OLTP) Regular tables to Temporary T tables
RDB1	RDB1 Call Activities	rcadmp_bj_100_01	LOAD CALL ACTIVITIES DATA INTO T TABLES	No	No	Yes	Common	This process transfers the account call activity data from (OLTP) Regular tables to Temporary T tables
RDB1	RDB1 Deficiency	rchdmp_bj_100_01	LOAD DEFICIENCY DATA INTO T TABLES	No	No	Yes	Common	This process transfers the account deficiency data from (OLTP) Regular tables to Temporary T tables
RDB1	RDB1 Contracts	rcodmp_bj_100_01	LOAD CONTRACT DATA INTO T TABLES	Yes	Yes	No	Common	This process transfers the account contracts data from (OLTP) Regular tables to Temporary T tables
RDB1	RDB1 Repossessions	rfodmp_bj_100_01	LOAD REPO FORECLOSURE DATA INTO T TABLES	No	No	Yes	Common	This process transfers the account bankruptcy data from (OLTP) Regular tables to Temporary T tables

Table 2-55 (Cont.) Batch Jobs Available

Engine Type	Description	Batch Job	Description	Origination	Servicing	Collection	Product	Comment
RDB1	RDB1 Producers	rprdmp_bj_100_01	LOAD PRODUCER AND ITS TXNS DATA INTO T TABLES	No	Yes	No	Common	This process transfers the producer and producer transactions data from (OLTP) Regular tables to Temporary T tables
RDB1	RDB1 Setup	rstdmp_bj_100_01	LOAD SETUP RELATED DATA INTO T TABLES	Yes	Yes	Yes	Common	This process transfers the setup data from (OLTP) Regular tables to Temporary T table
RDB1	RDB1 Txns	rtxdmp_bj_100_01	LOAD TXN DATA INTO T TABLES	No	Yes	No	Common	This process transfers the account transactions data from (OLTP) Regular tables to Temporary T tables
RDB2	RDB2 Accounts	racacc_bj_100_01	Load Reporting Tables Accounts	No	Yes	Yes	Common	This process transfers the account data from T tables to RDB tables
RDB2	RDB2 Accounts (Derived Fields)	racdrv_bj_100_01	Update Reporting Tables Accounts	No	Yes	Yes	Common	This process updates the codes with description for account RDB tables
RDB2	RDB2 Applications	rapapp_bj_100_01	Load Reporting Tables Applications	Yes	No	No	Common	This process transfers the application data from T tables to RDB tables
RDB2	RDB2 Applications (Derived Fields)	rapdrv_bj_100_01	Update Reporting Tables Applications (Derived Fields)	Yes	No	No	Common	This process updates the codes with description for application RDB tables

Table 2-55 (Cont.) Batch Jobs Available

Engine Type	Description	Batch Job	Description	Originat ion	Servicin g	Collecti on	Product	Comment
RDB2	RDB2 Asset Tracking	ratase_bj_100_01	Load Reporting Tables Asset Tracking	No	Yes	No	Comm on	This process transfers the account asset tracking data from T tables to RDB tables
RDB2	RDB2 Asset Tracking (Derived Fields)	ratdrv_bj_100_01	Update Reporting Tables Asset Tracking (Derived Fields)	No	Yes	No	Comm on	This process updates the codes with description for account asset tracking RDB tables
RDB2	RDB2 Bankrup tcy	rbkabd_bj_100_01	Load Reporting Tables Bankruptcy	No	No	Yes	Comm on	This process transfers the account bankruptcy data from T tables to RDB tables
RDB2	RDB2 Call Activities	rcacac_bj_100_01	Load Reporting Tables Call Activities	No	No	Yes	Comm on	This process transfers the account call activities data from T tables to RDB tables
RDB2	RDB2 Deficien cy	rchaof_bj_100_01	Load Reporting Tables Deficiency	No	No	Yes	Comm on	This process transfers the account deficiency data from T tables to RDB tables
RDB2	RDB2 Contract s	rcocon_bj_100_01	Load Reporting Tables Contracts	Yes	Yes	No	Comm on	This process transfers the account contract data from T tables to RDB tables
RDB2	RDB2 Contract s (Derived Fields)	rcodrv_bj_100_01	Update Reporting Tables Contracts (Derived Fields)	Yes	Yes	No	Comm on	This process updates the codes with description for account contract RDB tables
RDB2	RDB2 Reposse ssions	rfoafr_bj_100_01	Load Reporting Tables Repossession s	No	No	Yes	Comm on	This process transfers the account repossession data from T tables to RDB tables

Table 2-55 (Cont.) Batch Jobs Available

Engine Type	Description	Batch Job	Description	Originat ion	Servicin g	Collecti on	Product	Comment
RDB2	RDB2 Producers (Derived Fields)	rprdrv_bj_100_01	Update Reporting Tables Producers (Derived Fields)	No	Yes	No	Common	This process updates the codes with description for producer and producer transactions RDB tables
RDB2	RDB2 Producers	rprpro_bj_100_01	Load Reporting Tables Producers	No	Yes	No	Common	This process transfers the producer and producer transactions data from T tables to RDB tables
RDB2	RDB2 Setup	rststp_bj_100_01	Load Reporting Tables Setup	Yes	Yes	Yes	Common	This process transfers the setup data from T tables to RDB tables
RDB2	RDB2 Txns	rtxdrv_bj_100_01	Load Reporting Tables Txns	No	Yes	Yes	Common	This process transfers the account transaction data from T tables to RDB tables
RDB2	RDB2 Txns (Derived Fields)	rtxtxn_bj_100_01	Update Reporting Tables Txns (Derived Fields)	No	Yes	Yes	Common	This process updates the codes with description for account transactions RDB tables
SEC	Pool Summary	ssmprc_bj_100_01	POOL SUMMARY TABLE POPULATION	No	Yes	No	Common	This process populates summary tables for all pools
SETOV R	OVERPAYMENT REALLOCATIONS	PFSTXN_OVR_BJ_100_01	OVERPAYMENT REALLOCATIONS	No	Yes	No	Common	This process handles the overpayments / overages existing on an account
TPE	Earning/Amortization	tamprc_bj_100_01	AMORTIZATION TRANSACTIONS PROCESSING	No	Yes	No	Common	This process creates the monthend interest accrual transactions on monthend.

Table 2-55 (Cont.) Batch Jobs Available

Engine Type	Description	Batch Job	Description	Origination	Servicing	Collection	Product	Comment
TPE	Earning/Amortization	tamprc_bj_111_01	MONTH END AMORTIZATION TRANSACTIONS	No	Yes	No	Loan	This process creates the monthend interest accrual transactions on monthend.
TPE	Escrow Non Monetary Transactions	tenbmt_bj_100_01	Escrow Non Monetary Batch Transactions	No	Yes	Yes	Common	This process posts escrow non monetary transactions in the background at the specified time interval.
TPE	Escrow Analysis & Disbursements	tesanl_bj_100_01	Escrow Analysis Posting	No	Yes	No	Common	This process posts all approved escrow analysis to the account
TPE	Escrow Analysis & Disbursements	tesanl_bj_100_02	Create batches for Customer Refund Requests	No	Yes	No	Common	This process creates company branch wise batches for customer refund requests.
TPE	Escrow Analysis & Disbursements	tesanl_bj_100_03	Create Transaction of Customer Refund Requests	No	Yes	No	Common	This process populate customer refund request in respective batch created above
TPE	Escrow Analysis & Disbursements	tesanl_bj_100_04	Compute control totals for customer refund request batches	No	Yes	No	Common	This process populates control totals for the bathes created for customer refund requests.
TPE	Escrow Analysis & Disbursements	tesanl_bj_100_05	Escrow compliance checking	No	Yes	No	Common	This process checks escrowable account for compliance

Table 2-55 (Cont.) Batch Jobs Available

Engine Type	Description	Batch Job	Description	Origination	Servicing	Collection	Product	Comment
TPE	Escrow Analysis & Disbursements	tesdsb_bj_100_05	Escrow disbursement posting & requisition creation	No	Yes	No	Common	This process posts processed escrow disbursement and creates requisitions.
TPE	Non Monetary Transactions	tnmbmt_bj_100_01	NON MONETARY TRANSACTIONS POSTING	No	Yes	Yes	Common	This process posts non monetary transactions in the background at the specified time interval.
TPE	Compensation	tprcom_bj_111_01	Compensation	No	Yes	No	Loan	This process creates transaction for month-end producer compensation
TPE	Statement	tprpsg_bj_111_01	Producer Statement	No	Yes	No	Loan	This process creates the monthend interest accrual transactions on monthend.
TPE	Monetary Transactions	txnacr_bj_100_01	INTEREST ACCRUAL AND DELINQUENCY PROCESSING	No	Yes	No	Common	This process posts any payment batches open in the system. This process can be set to run periodically.
TPE	Monetary Transactions	txnact_bj_100_01	ACCOUNT ACTIVATION	No	Yes	No	Common	This job activates new accounts i.e. changes status from PENDING to ACTIVE.
TPE	Monetary Transactions	txnavd_bj_112_01	Advance Posting	No	Yes	No	Line	This process posts any advance batches open in the system. This process can be set to run periodically.

Table 2-55 (Cont.) Batch Jobs Available

Engine Type	Description	Batch Job	Description	Origination	Servicing	Collection	Product	Comment
TPE	Monetary Transactions	txnnann_bj_100_01	ANNIVERSARY PROCESSING	No	Yes	No	Common	This process carries out the anniversary processing for eligible accounts
TPE	Monetary Transactions	txnbmt_bj_100_01	MONETARY TRANSACTIONS POSTING	No	Yes	No	Common	This process posts monetary transactions in the background at the specified time interval.
TPE	Monetary Transactions	txnchg_bj_100_01	Chargeoff Processing	No	Yes	No	Common	This process charges off eligible or scheduled for chargeoff accounts.
TPE	Monetary Transactions	txnchg_bj_100_03	Chargeoff reversal	No	Yes	No	Common	On posting charge off reversal transaction, this process moves the remaining expense and fee from charge off balance to active balance.
TPE	Monetary Transactions	txnccls_bj_100_01	VOID/PAID ACCOUNT CLOSE PROCESSING	No	Yes	No	Common	This process closes void and paid off accounts.

Table 2-55 (Cont.) Batch Jobs Available

Engine Type	Description	Batch Job	Description	Origination	Servicing	Collection	Product	Comment
TPE	Monetary Transactions	txnddt_bj_100_01	BILLING/DUE DATES PROCESSING	No	Yes	No	Common	This process creates/updates the due dates for the accounts in the system. In addition, this process can also do Asset Billing using asset parameters defined for Home collateral. For more details, refer to Asset Billing Rate section.
TPE	Monetary Transactions	txnfpd_bj_100_01	FIRST PMT DEDUCTION PROCESSING	No	Yes	No	Common	This process posts the first payment deduction payment to the eligible accounts.
TPE	Monetary Transactions	txnfpr_bj_111_01	FIRST PMT REFUND PROCESSING	No	Yes	No	Loan	This process posts the first payment deduction payment to the eligible accounts.
TPE	Monetary Transactions	txnltc_bj_100_01	LATE CHARGE PROCESSING	No	Yes	No	Common	This process assesses late charge depending on the rules, for all accounts in the system.
TPE	Monetary Transactions	txnmtd_bj_100_01	MONTH END PROCESSING	No	Yes	No	Common	This process populates the month end balances and carries over the balances to next month.
TPE	Monetary Transactions	txnpmt_bj_100_01	Payment Posting	No	Yes	No	Common	This process does the daily accrual and delinquency processing.

Table 2-55 (Cont.) Batch Jobs Available

Engine Type	Description	Batch Job	Description	Origination	Servicing	Collection	Product	Comment
TPE	Monetary Transactions	txnprm_bj_100_01	PROMOTION END PROCESSING	No	Yes	No	Common	This process ends the promotion on the account.
TPE	Monetary Transactions	txnprm_bj_100_03	TLP PROMOTION CANCEL PROCESSING	No	Yes	No	Common	This process Cancels the promotion on the account.
TPE	Monetary Transactions	txnrat_bj_100_01	RATE CHANGE PROCESSING	No	Yes	No	Common	This process changes the prevalent rate on an account.
TPE	Monetary Transactions	txnsch_bj_100_01	SCHEDULE FOR CHARGED OFF PROCESSING	No	Yes	No	Common	This process puts the Schedule for Charge Off condition on eligible accounts.
TPE	Monetary Transactions	txntip_bj_100_01	TERMINATION PROCESSING	No	Yes	No	Common	This process puts the Paid status on eligible accounts
TPE	Monetary Transactions	txnytd_bj_100_01	YEAR END PROCESSING	No	Yes	No	Common	This process populates the year end balances and carries over the balances to next year.
TPE	Usage Charge Processing	TXNUSG_BJ_100_01	Billing Batch job to process and post lease usage/ rental fees on account	No	Yes	Yes	Common	This process is used to derive the billing amount to be charged for Lease Usage/ Rental based asset for consumed units calculated by the applicable charge matrix.

Table 2-55 (Cont.) Batch Jobs Available

Engine Type	Description	Batch Job	Description	Origination	Servicing	Collection	Product	Comment
TPE	MOCK BILLING / DUE DATES PROCESSING	TXNMDT_BJ_100_01	MOCK BILLING/ DUE DATES PROCESSING	Yes	Yes	Yes	Common	This process generates the future dues/ balances based on the parameters defined in the criteria. This batch job is a prerequisite run for the mock statements to get generated.
TPE	CAPITALIZATION PROCESSING	TXNCPT_BJ_100_01	CAPITALIZATION PROCESSING	Yes	Yes	Yes	Common	This process is used to capitalize the balance on all qualified accounts and is configured to run after running the billing batch job.
TPE	POST MATURITY EVER GREEN TRANSACTION PROCESSING	TXNEGC_BJ_121_01	POST MATURITY EVER GREEN TRANSACTION PROCESSING		Yes			This process is used to pick-up accounts matching the criteria for evergreen renewal, waits for maturity date based on grace days and posts Evergreen Lease transaction.
TPE	CYCLE BASED COLLECTION LATE FEE PROCESSING	TXNCBC_BJ_100_01	CYCLE BASED COLLECTION LATE FEE PROCESSING	Yes	Yes	Yes	Common	This process facilitates to calculate Cycle based Collection Late Fee at account level and update the balances.

Table 2-55 (Cont.) Batch Jobs Available

Engine Type	Description	Batch Job	Description	Origination	Servicing	Collection	Product	Comment
TPE	CYCLE BASED LATE FEE PROCESSING	TXNCBL_BJ_100_01	CYCLE BASED LATE FEE PROCESSING	Yes	Yes	Yes	Common	This process facilitates to calculate Cycle Based Late Fee at account level and update the balances.
XPR	DEALER TRACK PRODUCER LOAD	XPRPST_EW_100_01	DEALER TRACK PRODUCER LOAD	No	Yes	Yes	Common	This process dumps producer details maintained in the system into Dealer Track. System can either use MDB flow by generating outbound JMS message if system parameter OUTBOUND_DLR_TRACK_Q is set to Y or use existing flow by making database synchronous outbound calls to producer data dump web service.

Table 2-55 (Cont.) Batch Jobs Available

Engine Type	Description	Batch Job	Description	Origination	Servicing	Collection	Product	Comment
XPR2	ROUTE ONE PRODUCER LOAD	XPRPST_EW_100_01	ROUTE ONE PRODUCER LOAD	No	Yes	Yes	Common	This process dumps producer details maintained in the system into ROUTEONE. System can either use MDB flow by generating outbound JMS message if system parameter OUTBOUND_ROUTEONE_Q is set to Y or use existing flow by making database synchronous outbound calls to producer data dump web service.
LTR	CONDITIONAL ADVERSE ACTION LETTER	LORACO_BJ_100_01	CONDITIONAL ADVERSE ACTION LETTER GENERATION	Yes	No	No	Loan	This process generates the adverse action letter for relevant applications.
LTR	ADVERSE ACTION LETTER	LORADV_BJ_100_01	ADVERSE ACTION LETTER GENERATION	Yes	No	No	Loan	This process generates the adverse action letter for relevant applications.
RPT	ACCOUNT LIST	ROPACC_EM_100_01	ACCOUNT LIST	No	Yes	No	Common	
RPT	ADVANCE POSTING LIST	ROPADV_EM_100_01	ADVANCE POSTING LIST	No	Yes	No	Common	
RPT	ASSET TRACKING DETAILS	ROPATK_EM_100_01	ASSET TRACKING DETAILS	No	Yes	No	Common	

Table 2-55 (Cont.) Batch Jobs Available

Engine Type	Description	Batch Job	Description	Origination	Servicing	Collection	Product	Comment
RPT	BANKRUPTCY ACCOUNT LIST	ROPBK_EM_100_01	BANKRUPTCY ACCOUNT LIST	No	Yes	No	Common	
RPT	COLLECTOR ACTIVITY DETAILS	ROPCL_EM_100_01	COLLECTOR ACTIVITY DETAILS	No	Yes	No	Common	
RPT	DEFICIENCY ACCOUNT LIST	ROPDF_EM_100_01	DEFICIENCY ACCOUNT LIST	No	Yes	No	Common	
RPT	DELINQUENT ACCOUNT LIST	ROPDL_Q_EM_100_01	DELINQUENT ACCOUNT LIST	No	Yes	No	Common	
RPT	FUNDING CONTRACT LIST	ROPFN_EM_100_01	FUNDING CONTRACT LIST	No	Yes	No	Common	
RPT	GL TXN DETAILS LIST	ROPGLI_EM_100_01	GL TXN DETAILS LIST	No	Yes	No	Common	
RPT	APPLICATIONS LIST	ROPORG_EM_100_01	APPLICATIONS LIST	No	Yes	No	Common	
RPT	PAYMENT ALLOCATION POSTING DETAILS	ROPPAL_EM_100_01	PAYMENT ALLOCATION POSTING DETAILS	No	Yes	No	Common	
RPT	PAYMENT POSTING LIST	ROPPT_EM_100_01	PAYMENT POSTING LIST	No	Yes	No	Common	
RPT	PAYABLE REQUISITION LIST	ROPQR_Q_EM_100_01	PAYABLE REQUISITION LIST	No	Yes	No	Common	

Table 2-55 (Cont.) Batch Jobs Available

Engine Type	Description	Batch Job	Description	Originat ion	Servicin g	Collecti on	Product	Comment
RPT	REPOSSESION/FORECLOSURE ACCOUNT LIST	ROPREP_EM_100_01	REPOSSESION/FORECLOSURE ACCOUNT LIST	No	Yes	No	Common	
RPT	SCHEDULE TO CHARGE OFF LIST	ROPSCHEM_100_01	SCHEDULE TO CHARGE OFF LIST	No	Yes	No	Common	
RPT	TERMINATION IN PROGRESS LIST	ROPTIP_EM_100_01	TERMINATION IN PROGRESS LIST	No	Yes	No	Common	
RPT	NON MONETARY TXN POSTING LIST	ROPTNM_EM_100_01	NON MONETARY TXN POSTING LIST	No	Yes	No	Common	
RPT	MONETARY TXN POSTING LIST	ROPTXN_EM_100_01	MONETARY TXN POSTING LIST	No	Yes	No	Common	
RPT	BATCH JOB SETUP	CMNBJB_EM_100_01	BATCH JOB SETUP	No	Yes	No	Common	
RPT	BATCH JOB LOG	CMNBJB_EM_100_02	BATCH JOB LOG	No	Yes	No	Common	
RPT	NUMBER OF CREDIT APPLICATIONS ENTERED BY USER	OUNADE_EM_100_01	NUMBER OF CREDIT APPLICATIONS ENTERED BY USER	No	Yes	No	Common	
RPT	CREDIT APPLICATIONS IMAGES BY STATUS	OUNADE_EM_100_02	CREDIT APPLICATIONS IMAGES BY STATUS	No	Yes	No	Common	

Table 2-55 (Cont.) Batch Jobs Available

Engine Type	Description	Batch Job	Description	Origination	Servicing	Collection	Product	Comment
RPT	UNDERWRITING STATUS BY MONTH AND PRODUCER (LOAN)	OUNUND_EM_11_11	UNDERWRITING STATUS BY MONTH AND PRODUCER (LOAN)	No	Yes	No	Common	
RPT	UNDERWRITING STATUS BY MONTH AND UNDERWRITER (LOAN)	OUNUND_EM_11_12	UNDERWRITING STATUS BY MONTH AND UNDERWRITER (LOAN)	No	Yes	No	Common	
RPT	UNDERWRITING STATUS BY MONTH (LOAN)	OUNUND_EM_11_13	UNDERWRITING STATUS BY MONTH (LOAN)	No	Yes	No	Common	
RPT	UNDERWRITING STATUS BY UNDERWRITER (LOAN)	OUNUND_EM_11_14	UNDERWRITING STATUS BY UNDERWRITER (LOAN)	No	Yes	No	Common	
RPT	UNDERWRITING STATUS BY MONTH AND PRODUCER (LINE)	OUNUND_EM_12_11	UNDERWRITING STATUS BY MONTH AND PRODUCER (LINE)	No	Yes	No	Common	

Table 2-55 (Cont.) Batch Jobs Available

Engine Type	Description	Batch Job	Description	Originat ion	Servicin g	Collecti on	Product	Comment
RPT	UNDER WRITIN G STATUS BY MONTH AND UNDER WRITER (LINE)	OUNUN D_EM_1 12_12	UNDERWRIT ING STATUS BY MONTH AND UNDERWRIT ER (LINE)	No	Yes	No	Commo n	
RPT	UNDER WRITIN G STATUS BY MONTH (LINE)	OUNUN D_EM_1 12_13	UNDERWRIT ING STATUS BY MONTH (LINE)	No	Yes	No	Commo n	
RPT	UNDER WRITIN G STATUS BY UNDER WRITER (LINE)	OUNUN D_EM_1 12_14	UNDERWRIT ING STATUS BY UNDERWRIT ER (LINE)	No	Yes	No	Commo n	
RPT	UNDER WRITIN G STATUS BY MONTH AND PRODU CER (LEASE)	OUNUN D_EM_1 21_11	UNDERWRIT ING STATUS BY MONTH AND PRODUCER (LEASE)	No	Yes	No	Commo n	
RPT	UNDER WRITIN G STATUS BY MONTH AND UNDER WRITER (LEASE)	OUNUN D_EM_1 21_12	UNDERWRIT ING STATUS BY MONTH AND UNDERWRIT ER (LEASE)	No	Yes	No	Commo n	
RPT	UNDER WRITIN G STATUS BY MONTH (LEASE)	OUNUN D_EM_1 21_13	UNDERWRIT ING STATUS BY MONTH (LEASE)	No	Yes	No	Commo n	

Table 2-55 (Cont.) Batch Jobs Available

Engine Type	Description	Batch Job	Description	Originat ion	Servicin g	Collecti on	Product	Comment
RPT	UNDERWRITING STATUS BY UNDERWRITER (LOAN)	OUNUND_EM_121_14	UNDERWRITING STATUS BY UNDERWRITER (LOAN)	Yes	No	No	Lease	
RPT	ACCOUNT PAYABLE (ORIGINATION)	OFNAPY_EM_100_01	ACCOUNT PAYABLE (ORIGINATION)	Yes	No	No	Common	
RPT	ACCOUNT PAYABLE (SERVICING)	OFNAPY_EM_100_02	ACCOUNT PAYABLE (SERVICING)	No	Yes	No	Common	
RPT	PRE-FUNDING CONTRACTS (LOAN)	OFNFND_EM_111_01	PRE-FUNDING CONTRACTS (LOAN)	Yes	No	No	Loan	
RPT	FUNDED CONTRACTS (LOAN)	OFNFND_EM_111_02	FUNDED CONTRACTS (LOAN)	Yes	No	No	Loan	
RPT	PRE-FUNDING CONTRACTS (LINE)	OFNFND_EM_112_01	PRE-FUNDING CONTRACTS (LINE)	Yes	No	No	Loan	
RPT	FUNDED CONTRACTS (LINE)	OFNFND_EM_112_02	FUNDED CONTRACTS (LINE)	Yes	No	No	Common	
RPT	PRE-FUNDING CONTRACTS (LEASE)	OFNFND_EM_121_01	PRE-FUNDING CONTRACTS (LEASE)	Yes	No	No	Common	
RPT	FUNDED CONTRACTS (LEASE)	OFNFND_EM_121_02	FUNDED CONTRACTS (LEASE)	Yes	No	No	Loan	

Table 2-55 (Cont.) Batch Jobs Available

Engine Type	Description	Batch Job	Description	Originat ion	Servicin g	Collecti on	Product	Comment
RPT	ACCOU NT PAYABL E LOG BY PRODU CER	OCSAP P_EM_1 00_01	ACCOUNT PAYABLE LOG BY PRODUCER	Yes	No	No	Loan	
RPT	ACCOU NT PAYABL E LOG BY VENDO R	OCSAP V_EM_1 00_01	ACCOUNT PAYABLE LOG BY VENDOR	Yes	No	No	Loan	
RPT	COLLAT ERAL TRACKI NG LOG	OCSAS T_EM_1 00_01	COLLATERA L TRACKING LOG	Yes	No	No	Commo n	
RPT	GL POSTIN G LOG	OCSGLI _EM_10 0_01	GL POSTING LOG	Yes	No	No	Commo n	
RPT	PAYMEN T POSTIN G (DAILY CASH) LOG	OCSPM T_EM_1 00_01	PAYMENT POSTING (DAILY CASH) LOG	Yes	No	No	Commo n	
RPT	PAYMEN T POSTIN G ERROR LOG	OCSPM T_EM_1 00_02	PAYMENT POSTING ERROR LOG	Yes	No	No	Commo n	
RPT	ACCOU NT LISTING (LOAN)	OCSAC C_EM_1 11_01	ACCOUNT LISTING (LOAN)	Yes	No	No	Loan	
RPT	EXCES S PAYMEN T (REFUN D) LOG (LOAN)	OCSPM T_EM_1 11_03	EXCESS PAYMENT (REFUND) LOG (LOAN)	Yes	No	No	Loan	
RPT	PAYMEN T HISTOR Y (LOAN)	OCSPM T_EM_1 11_04	PAYMENT HISTORY (LOAN)	Yes	No	No	Loan	

Table 2-55 (Cont.) Batch Jobs Available

Engine Type	Description	Batch Job	Description	Origination	Servicing	Collection	Product	Comment
RPT	PAYMENT ALLOCATIONS LOG (LOAN)	OCSPMT_EM_11_05	PAYMENT ALLOCATION S LOG (LOAN)	Yes	No	No	Loan	
RPT	PAYMENT ALLOCATIONS LOG BY GL POST DT (LOAN)	OCSPMT_EM_11_06	PAYMENT ALLOCATION S LOG BY GL POST DT (LOAN)	Yes	No	No	Loan	
RPT	PRODUCER STATEMENT (LOAN)	OCSPSM_EM_11_01	PRODUCER STATEMENT (LOAN)	Yes	No	No	Loan	
RPT	PRODUCER MONETARY TXNS LOG BY GL POST DT (LOAN)	OCSPTX_EM_11_01	PRODUCER MONETARY TXNS LOG BY GL POST DT (LOAN)	Yes	No	No	Loan	
RPT	SCHEDULED FOR CHARGEOFF ACCOUNTS LOG (LOAN)	OCSSCH_EM_11_01	SCHEDULED FOR CHARGEOFF ACCOUNTS LOG (LOAN)	Yes	No	No	Loan	
RPT	AMORTIZED TXNS LOG BY GL POST DT (LOAN)	OCSTAM_EM_11_01	AMORTIZED TXNS LOG BY GL POST DT (LOAN)	Yes	No	No	Loan	

Table 2-55 (Cont.) Batch Jobs Available

Engine Type	Description	Batch Job	Description	Originat ion	Servicin g	Collecti on	Product	Comment
RPT	SCHED ULED FOR TERMIN ATION ACCOU NTS LOG (LOAN)	OCSTE R_EM_1 11_01	SCHEDULED FOR TERMINATIO N ACCOUNTS LOG (LOAN)	Yes	No	No	Loan	
RPT	MONET ARY TXNS LOG BY GL POST DT (LOAN)	OCSTX N_EM_1 11_01	MONETARY TXNS LOG BY GL POST DT (LOAN)	Yes	No	No	Loan	
RPT	ACCOU NT LISTING (LINE)	OCSAC C_EM_1 12_01	ACCOUNT LISTING (LINE)	Yes	No	No	Loan	
RPT	ADVAN CE POSTIN G LOG (LINE)	OCSAD V_EM_1 12_01	ADVANCE POSTING LOG (LINE)	Yes	No	No	Loan	
RPT	ADVAN CE POSTIN G ERROR LOG (LINE)	OCSAD V_EM_1 12_02	ADVANCE POSTING ERROR LOG (LINE)	Yes	No	No	Loan	
RPT	PAYMEN T HISTOR Y (LINE)	OCSPM T_EM_1 12_04	PAYMENT HISTORY (LINE)	Yes	No	No	Loan	
RPT	PAYMEN T ALLOCA TIONS LOG (LINE)	OCSPM T_EM_1 12_05	PAYMENT ALLOCATION S LOG (LINE)	Yes	No	No	Commo n	
RPT	PAYMEN T ALLOCA TIONS LOG BY GL POST DT (LINE)	OCSPM T_EM_1 12_06	PAYMENT ALLOCATION S LOG BY GL POST DT (LINE)	Yes	No	No	Commo n	

Table 2-55 (Cont.) Batch Jobs Available

Engine Type	Description	Batch Job	Description	Origination	Servicing	Collection	Product	Comment
RPT	SCHEDULED FOR CHARGEOFF ACCOUNTS LOG (LINE)	OCSSC H_EM_1 12_01	SCHEDULED FOR CHARGEOFF ACCOUNTS LOG (LINE)	Yes	No	No	Common	
RPT	AMORTIZED TXNS LOG BY GL POST DT (LINE)	OCSTAM_EM_1 12_01	AMORTIZED TXNS LOG BY GL POST DT (LINE)	Yes	No	No	Common	
RPT	SCHEDULED FOR TERMINATION ACCOUNTS LOG (LINE)	OCSTER_EM_1 12_01	SCHEDULED FOR TERMINATION ACCOUNTS LOG (LINE)	Yes	No	No	Common	
RPT	MONETARY TXNS LOG BY GL POST DT (LINE)	OCSTXN_EM_1 12_01	MONETARY TXNS LOG BY GL POST DT (LINE)	Yes	No	No	Common	
RPT	ACCOUNT LISTING (LEASE)	OCSACC_EM_1 21_01	ACCOUNT LISTING (LEASE)	Yes	No	No	Common	
RPT	PAYMENT HISTORY (LEASE)	OCSPMT_EM_1 21_04	PAYMENT HISTORY (LEASE)	Yes	No	No	Common	
RPT	PAYMENT ALLOCATIONS LOG (LEASE)	OCSPMT_EM_1 21_05	PAYMENT ALLOCATIONS LOG (LEASE)	Yes	No	No	Common	

Table 2-55 (Cont.) Batch Jobs Available

Engine Type	Description	Batch Job	Description	Origination	Servicing	Collection	Product	Comment
RPT	PAYMENT ALLOCATIONS LOG BY GL POST DT (LEASE)	OCSPMT_EM_121_06	PAYMENT ALLOCATION S LOG BY GL POST DT (LEASE)	Yes	No	No	Common	
RPT	SCHEDULED FOR CHARGE OFF ACCOUNTS LOG (LEASE)	OCSSCH_EM_121_01	SCHEDULED FOR CHARGE OFF ACCOUNTS LOG (LEASE)	Yes	No	No	Common	
RPT	AMORTIZED TXNS LOG BY GL POST DT (LEASE)	OCSTAM_EM_121_01	AMORTIZED TXNS LOG BY GL POST DT (LEASE)	Yes	No	No	Common	
RPT	SCHEDULED FOR TERMINATION ACCOUNTS LOG (LEASE)	OCSTER_EM_121_01	SCHEDULED FOR TERMINATION ACCOUNTS LOG (LEASE)	Yes	No	No	Common	
RPT	MONETARY TXNS LOG BY GL POST DT (LEASE)	OCSTXN_EM_121_01	MONETARY TXNS LOG BY GL POST DT (LEASE)	Yes	No	No	Common	
RPT	BANKRUPTCY LOG	OCOBNK_EM_100_01	BANKRUPTCY LOG	Yes	No	No	Common	
RPT	COLLECTOR ACTIVITY (DETAILED) LOG	OCOCOL_EM_100_01	COLLECTOR ACTIVITY (DETAILED) LOG	No	No	Yes	Common	

Table 2-55 (Cont.) Batch Jobs Available

Engine Type	Description	Batch Job	Description	Originat ion	Servicin g	Collecti on	Product	Comment
RPT	COLLEC TOR PRODU CTIVITY BY QUEUE	OCOCO L_EM_1 00_02	COLLECTOR PRODUCTIVI TY BY QUEUE	No	No	Yes	Commo n	
RPT	DELINQ UENCY ANALYS IS BY PRODU CER	OCOCO L_EM_1 00_03	DELINQUEN CY ANALYSIS BY PRODUCER	No	No	Yes	Commo n	
RPT	DELINQ UENCY ANALYS IS BY CREDIT GRADE	OCOCO L_EM_1 00_04	DELINQUEN CY ANALYSIS BY CREDIT GRADE	No	No	Yes	Commo n	
RPT	DELINQ UENCY ANALYS IS BY STATE	OCOCO L_EM_1 00_05	DELINQUEN CY ANALYSIS BY STATE	No	No	Yes	Commo n	
RPT	PAYMEN T PROMIS E LOG	OCOCO L_EM_1 00_06	PAYMENT PROMISE LOG	No	No	Yes	Commo n	
RPT	COLLEC TOR ACTIVIT Y LOG	OCOCO L_EM_1 00_07	COLLECTOR ACTIVITY LOG	No	No	Yes	Commo n	
RPT	DEFICIE NCY LOG	OCODE F_EM_1 00_01	DEFICIENCY LOG	No	No	Yes	Commo n	
RPT	DELINQ UENCY LOG	OCODL Q_EM_1 00_01	DELINQUEN CY LOG	No	No	Yes	Commo n	
RPT	REPOS SESSIO N/ FOREC LOSUR E LOG	OCORE P_EM_1 00_01	REPOSSESS ION/ FORECLOSU RE LOG	No	No	Yes	Commo n	
RPT	NON MONET ARY TXNS LOG	OCOTN M_EM_1 00_01	NON MONETARY TXNS LOG	No	No	Yes	Commo n	
RPT	VENDO R INVOIC E LOG	OCOVIN _EM_10 0_01	VENDOR INVOICE LOG	No	No	Yes	Commo n	

Table 2-55 (Cont.) Batch Jobs Available

Engine Type	Description	Batch Job	Description	Origination	Servicing	Collection	Product	Comment
RPT	VENDOR WORK ORDER LOG	OCOVN A_EM_1 00_01	VENDOR WORK ORDER LOG	No	No	Yes	Common	
RPT	POOL DELINQUENCY SUMMARY (LOAN)	OCSSE C_EM_1 11_01	POOL DELINQUENCY SUMMARY (LOAN)	No	Yes	No	Common	
RPT	POOL DEFAULTS (NON LIQUIDATED) (LOAN)	OCSSE C_EM_1 11_02	POOL DEFAULTS (NON LIQUIDATED) (LOAN)	No	Yes	No	Common	
RPT	POOL PAYOFFS (LOAN)	OCSSE C_EM_1 11_03	POOL PAYOFFS (LOAN)	No	Yes	No	Common	
RPT	POOL RECOVERY (LOAN)	OCSSE C_EM_1 11_04	POOL RECOVERY (LOAN)	No	Yes	No	Common	
RPT	POOL DELINQUENCY (LOAN)	OCSSE C_EM_1 11_05	POOL DELINQUENCY (LOAN)	No	Yes	No	Common	
RPT	POOL REPURCHASED ACCOUNTS (LOAN)	OCSSE C_EM_1 11_06	POOL REPURCHASED ACCOUNTS (LOAN)	No	Yes	No	Common	
RPT	POOL MONTHLY ACTIVITY (LOAN)	OCSSE C_EM_1 11_07	POOL MONTHLY ACTIVITY (LOAN)	No	Yes	No	Common	
RPT	POOL LIQUIDATED CONTRACTS (LOAN)	OCSSE C_EM_1 11_08	POOL LIQUIDATED CONTRACTS (LOAN)	No	Yes	No	Common	

Table 2-55 (Cont.) Batch Jobs Available

Engine Type	Description	Batch Job	Description	Origination	Servicing	Collection	Product	Comment
RPT	POOL TXNS LOG BY GL POST DT (LOAN)	OCSSE C_EM_11_09	POOL TXNS LOG BY GL POST DT (LOAN)	No	Yes	No	Common	
SETQRT	Real time Queues processing	QCSPR C_BJ_100_02	Real time Queues processing	No	Yes	Yes	Common	This batch job processes queues marked as real time based on refresh frequency setup in the job set.
TAM	MONTH END COMPENSATION DISBURSEMENT PROCESSING	TPRCO M_BJ_100_01	MONTH END COMPENSATION DISBURSEMENT PROCESSING	No	Yes	No	Common	
TAM	PRODUCER STATEMENTS	TPRPS G_BJ_100_01	PRODUCER STATEMENTS	No	Yes	No	Common	
TAM	PRODUCER STATUS CHANGE	TPRSTA_BJ_100_01	PRODUCER STATUS CHANGE	No	Yes	No	Common	
TAM	Depreciation calculator batch job	TAMDE P_BJ_121_01	DEPRECIATION RATE PROCESSING	Yes	Yes	Yes	Lease	This process is used to calculate the delta depreciation value of the asset from previous to current period (current indicator is set as Y by default).

Table 2-55 (Cont.) Batch Jobs Available

Engine Type	Description	Batch Job	Description	Origination	Servicing	Collection	Product	Comment
TAM	Amortization schedule batch job	TAMIMP_BJ_100_01	IMPUTED INTEREST AMORTIZATION TRANSACTIONS PROCESSING	Yes	Yes	Yes	Common	This process is used to generate Amortization schedule based on imputed interest rate for loan contracts with Imputed Interest
TPE	Escrow Analysis & Disbursements	TXNCHG_BJ_100_02	CHARGEOFF PROCESSING FOR ACTIVE ACCOUNTS	No	Yes	No	Common	This package contains procedures related to Batch Job for chargeoff processing
ESC	ESCROW ANALYSIS POSTING	TESANL_BJ_100_01	ESCROW ANALYSIS POSTING	No	Yrs	No	Common	This package contains procedures related to Batch Job for escrow analysis processing
ESC	CREATE BATCHES FOR CUSTOMER REFUND REQUEST	TESANL_BJ_100_02	CREATE BATCHES FOR CUSTOMER REFUND REQUESTS	No	Yes	No	Common	This package contains procedures related to Batch Job for escrow analysis processing
ESC	COMPUTE CONTROLS FOR CUSTOMER REFUND REQUEST BATCHES	TESANL_BJ_100_04	COMPUTE CONTROLS FOR CUSTOMER REFUND REQUEST BATCHES	No	Yes	No	Common	

Table 2-55 (Cont.) Batch Jobs Available

Engine Type	Description	Batch Job	Description	Origination	Servicing	Collection	Product	Comment
ESC	ESCROW COMPLIANCE CHECKING	TESANL_BJ_100_05	ESCROW COMPLIANCE CHECKING	No	Yes	No	Common	
ESC	CREATE PAYABLE REQUISITIONS FROM APPROVED DISBURSEMENT REQUESTS	TESDSB_BJ_100_01	CREATE PAYABLE REQUISITIONS FROM APPROVED DISBURSEMENT REQUESTS	No	Yes	No	Common	
PUR	ARCHIVE ACCOUNT DATA TO OTABLES	PACARC_BJ_100_01	ARCHIVE ACCOUNT DATA TO OTABLES	No	Yes	No	Common	
EVE	BATCH EVENTS FOR ACCOUNTS	EVBACC_BJ_100_01	BATCH EVENTS FOR ACCOUNTS		Yes			
EVE	BATCH EVENTS FOR APPLICATIONS	EVBAPP_BJ_100_01	BATCH EVENTS FOR APPLICATIONS	Yes				
EVE	MAIN BATCH JOB FOR BATCH EVENTS PROCESSING	EVBPRC_BJ_100_01	MAIN BATCH JOB FOR BATCH EVENTS PROCESSING		Yes			
ODD2	BATCH JOB TO GENERATE METRO 2 DATA	CBUUTL_BJ_100_02	BATCH JOB TO GENERATE METRO 2 DATA	Yes				

Table 2-55 (Cont.) Batch Jobs Available

Engine Type	Description	Batch Job	Description	Origination	Servicing	Collection	Product	Comment
ODD2	BATCH JOB FOR CREATING METRO 2 DATA FILE	CBUUTL_BJ_100_03	BATCH JOB FOR CREATING METRO 2 DATA FILE	Yes				
ODD2	THIRD PARTY ACH PROCESSING	ACTPRC_BJ_100_01	THIRD PARTY ACH PROCESSING		Yes			
ODD2	THIRD PARTY OUTPUT DATA DUMP SERVICE	ACTPRC_BJ_100_01	CREATE THIRD PARTY CUSTOMER FILE		Yes			This process pulls the customer account details shared in input data files for processing.
ESC	JOB TO GENERATE ESCROW DISCLOSURE STATEMENT	OEDPRC_BJ_100_01	JOB TO GENERATE ESCROW DISCLOSURE STATEMENT		Yes			
EDF	ADR FILE	EDFADR_BJ_100_01	ADR FILE		Yes			
EDF	IVR FILE	EDFIVR_BJ_100_01	IVR FILE		Yes			
TPE	CONTRACTUAL PROMOTION CANCEL PROCESSING	TXNPRM_BJ_100_04	CONTRACTUAL PROMOTION CANCEL PROCESSING		Yes			

Table 2-55 (Cont.) Batch Jobs Available

Engine Type	Description	Batch Job	Description	Origination	Servicing	Collection	Product	Comment
TPE	RATE CHANGE PROCESSING FOR BACKDATED INDEXES	TXNRAT_BJ_100_02	RATE CHANGE PROCESSING FOR BACKDATED INDEXES		Yes			
RDB1	LOAD ACCOUNT RELATED DATA INTO TABLES	RACDMP_BJ_100_01	LOAD ACCOUNT RELATED DATA INTO TABLES		Yes			
TPE	EXPIRED INSURANCE PROCESSING	TXNINS_BJ_100_01	EXPIRED INSURANCE PROCESSING		Yes			
ADT	UPDATE ROWID IN AUDIT TABLE (RUN THIS JOB AFTER EXPORTIMPORT OF TABLES)	ADTPRC_BJ_100_01	UPDATE ROWID IN AUDIT TABLE (RUN THIS JOB AFTER EXPORTIMPORT OF TABLES)		Yes			
RDB1	LOAD INSURANCE DATA TO TABLES	RINDMP_BJ_100_01	LOAD INSURANCE DATA TO TABLES		Yes			
AGS	SALE LEAD AGING	AGSSAL_BJ_100_01	SALE LEAD AGING	Yes				
BOD	PROCESS PARKED TRANSACTIONS	JOBBD_BJ_00_02	PROCESS PARKED TRANSACTIONS		Yes			

Table 2-55 (Cont.) Batch Jobs Available

Engine Type	Description	Batch Job	Description	Origination	Servicing	Collection	Product	Comment
BOD	MARK SYSTEM FOR BEGINNING OF DAY	JOBBO D_BJ_00_01	MARK SYSTEM FOR BEGINNING OF DAY		Yes			
EOD	SET SYSTEM MODE TO END-OF-DAY	JOBEOD_BJ_00_01	SET SYSTEM MODE TO END-OF-DAY		Yes			
ACR	DAILY TRIAL BALANCE DATA	TABACC_BJ_100_01	DAILY TRIAL BALANCE DATA GENERATION		Yes			
LTR2	RATE CHANGE PRE-INTIMATION LETTER	LCSRAT_BJ_100_01	RATE CHANGE PRE-INTIMATION LETTER		Yes			
BLK	BULK UPLOAD FOR PRICING SETUP	BLKPRP_BJ_100_01	BULK UPLOAD FOR PRICING SETUP	Yes				
BLK	BULK UPLOAD FOR GL ATTRIBUTES	BLKGLS_BJ_100_01	BULK UPLOAD FOR GL ATTRIBUTES				Common	
BLK	BULK UPLOAD FOR GL TRANSLATION	BLKGLS_BJ_100_02	BULK UPLOAD FOR GL TRANSLATION DEFINITION				Common	
BLK	BULK UPLOAD FOR GL TRANSACTION TYPES	BLKGLS_BJ_100_03	BULK UPLOAD FOR GL TRANSACTION TYPES DETAILS				Common	

Table 2-55 (Cont.) Batch Jobs Available

Engine Type	Description	Batch Job	Description	Originat ion	Servicin g	Collecti on	Product	Comment
BLK	BULK UPLOA D FOR GL TRANS ACTION LINKS	BLKGLS _BJ_100 _04	BULK UPLOAD FOR GL TRANSA CTION LINKS				Commo n	
ODD2	RATE CHANG E LETTER FILE	OLSRAT _BJ_100 _01	RATE CHANGE LETTER FILE CREATION		Yes			
TPE	EXPIRE D DRAW PERIOD PROCES SING (STAGE FUNDE D LOANS)	TXNDR W_BJ_1 11_01	EXPIRED DRAW PERIOD PROCES SING (STAGE FUNDE D LOANS)		Yes			
ODD2	DEALER SUBVE NTION STATEM ENTS	OPSSB V_BJ_1 00_01	DEALER SUBVENTIO N STATEMENT S GENERATIO N				Commo n	
TAM	SUBVE NTION RECEIV ABLE PROCES SING (PAY AS GO)	TPRSBV _BJ_100 _01	SUBVENTIO N RECEIVABLE PROCES SING (PAY AS GO)				Commo n	
ODD2	PRODU CER CHECK PRINT	OPCPR C_BJ_1 00_01	PRODUCER CHECK PRINT GENERATIO N				Commo n	
BSR	BEHAVI ORAL SCORIN G	BSRPR C_BJ_1 00_01	BEHAVIORAL SCORING		Yes			
AGE	TRANS ACTION IN WAITIN G FOR APPRO VAL AGING	TXNAG E_BJ_1 00_01	TRANSA CTION IN WAITING FOR APPROVAL AGING PROCESS		Yes			

Table 2-55 (Cont.) Batch Jobs Available

Engine Type	Description	Batch Job	Description	Origination	Servicing	Collection	Product	Comment
ACR	PREPARE BATCH DATA FOR INTEREST ACCRUAL AND DELINQUENCY	TXNACR_BJ_100_02	PREPARE BATCH DATA FOR INTEREST ACCRUAL AND DELINQUENCY PROCESSING		Yes			
PDC	POST DATED CHECKS	PDCPRC_BJ_100_01	POST DATED CHECKS		Yes			
PDC	PENDING PDC	PDCPND_BJ_100_01	PENDING PDC PROCESSING		Yes			
LTR2	PDC RENEWAL LETTER	LCSPDC_BJ_100_01	PDC RENEWAL LETTER GENERATION		Yes			
DOT	APPLICATION DOCUMENT LOAD	DOLPRC_BJ_000_02	APPLICATION DOCUMENT LOAD	Yes				
ODD2	ONE TIME ACH POST DATED PAYMENT LETTER	OLSPDP_BJ_100_01	ONE TIME ACH POST DATED PAYMENT LETTER PROCESSING		Yes			
ODD2	OUTPUT DATA DUMP SERVICING	OSTPRC_BJ_100_02	MASTER CUSTOMER STATEMENT GENERATION		Yes			This process is used to generate consolidated Account statements associated for each Master Account.
WFP	BILLING	WTXBIL_BJ_132_01	BILLING PROCESSING		Yes			
WFP	DELINQUENCY	WTXDLQ_BJ_132_01	DELINQUENCY PROCESSING		Yes			

Table 2-55 (Cont.) Batch Jobs Available

Engine Type	Description	Batch Job	Description	Origination	Servicing	Collection	Product	Comment
WFP	LATE CHARGE	WTLTC_BJ_132_01	LATE CHARGE ASSESSMENT		Yes			
WFP	STATEMENT	WTXPSG_BJ_132_01	STATEMENT GENERATION		Yes			
WFP	RATE CHANGE	WTXRA_T_BJ_132_01	RATE CHANGE PROCESSING		Yes			
WFP	TERMINATION	WTXTIP_BJ_132_01	TERMINATION PROCESSING		Yes			
TPE	PERIODIC MAINTENANCE FEE	TXNPMF_BJ_100_01	PERIODIC MAINTENANCE FEE PROCESSING					
WFP	UNIT UPLOAD	WUPPRC_BJ_132_01	UNIT UPLOAD				Common	
ODD2	BATCH JOB FOR MONTHLY HANDSOFF FILE FOR SIMAH	CBUUTL_BJ_100_04	BATCH JOB FOR MONTHLY HANDSOFF FILE FOR SIMAH					
PUR	PURGE ALL PTT TABLES	PTTPRC_BJ_100_01	PURGE ALL PTT TABLES				Common	
TPE	BATCH JOB FOR SETTING MATURED ACCOUNT CONDITION	TXNMAC_BJ_100_01	BATCH JOB FOR SETTING MATURED ACCOUNT CONDITION		Yes			
TPE	NON REFUND GL	TXNRFD_BJ_100_01	NON REFUND GL PROCESSING				Common	

Table 2-55 (Cont.) Batch Jobs Available

Engine Type	Description	Batch Job	Description	Origination	Servicing	Collection	Product	Comment
TPE	PAYMENT ARRANGEMENT	TXNPAP_BJ_100_01	PAYMENT ARRANGEMENT PROCESSING		Yes			
TPE	DELAY FEE	TXNDLY_BJ_100_01	DELAY FEE PROCESSING		Yes			
TPE	STATEMENT PAST MATURITY	TXNSTM_BJ_100_01	STATEMENT PAST MATURITY PROCESSING		Yes			
TPE	BLACK BOOK INTERFACE	VEVBBK_BJ_100_01	BLACK BOOK INTERFACE				Common	
LBT	BULK NSF PAYMENT REVERSALS	TXNNSF_BJ_100_01	BULK NSF PAYMENT REVERSALS					
ACR	STOP INTEREST ACCRUAL	TXNACR_BJ_100_03	STOP INTEREST ACCRUAL PROCESSING		Yes			
QRT	CUSTOMER SERVICE REAL TIME QUEUE	QCSPRC_BJ_100_02	CUSTOMER SERVICE REAL TIME QUEUE PROCESSING		Yes			
ODD2	OUTBOUND CUSTOMER EXTRACTS TO PAYMENT AGENCIES	OCPPRC_BJ_100_01	OUTBOUND CUSTOMER EXTRACTS TO PAYMENT AGENCIES		Yes			This process generates Customer Payment File Extract file with individual account dues or consolidated dues at Master account level in column definitions.

Table 2-55 (Cont.) Batch Jobs Available

Engine Type	Description	Batch Job	Description	Origination	Servicing	Collection	Product	Comment
ODD2	MASTER ACCOUNT CUSTOMER MOCK STATEMENT GENERATION	OMSPRC_BJ_100_01	MASTER ACCOUNT CUSTOMER MOCK STATEMENT GENERATION	Yes	Yes	Yes	Common	This process generates Asset billing Mock Statements based on preferences defined in Contract.
ODD2	Output Data Dump File	OACPRC_BJ_100_01	ACCOUNT DATA EXTRACTION FILE GENERATION	Yes	Yes	Yes	Common	This process generates an outbound file with required data for external systems to process. The output file data generated is based on accounts selected in OACPRC_BJ_100_02 process.

Table 2-55 (Cont.) Batch Jobs Available

Engine Type	Description	Batch Job	Description	Origination	Servicing	Collection	Product	Comment
ODD2	Output Data Dump File	OACPRC_BJ_100_02	PREPARE BATCH DATA FOR ACCOUNT DATA EXTRACTION FILE GENERATION	Yes	Yes	Yes	Common	This process decides the data or accounts to be picked up for file generation and can be controlled using the lookups OAC_ACC_STATUS_CD (account statuses) and OAC_ACC_CONDITION_CD (account conditions). During the batch processing, system checks the Account Status & Conditions set maintained in the lookups and only those accounts will be part of the output file.
IFP	OFFLINE CALL ACTIVITY POSTING	ICAPRC_BJ_100_01	OFFLINE CALL ACTIVITY POSTING		Yes			
ACR	RE-START INTEREST ACCRUAL	TXNACR_BJ_100_04	RE-START INTEREST ACCRUAL		Yes			
IFP	UPLOAD TRANSACTION	ITUPRC_BJ_100_01	UPLOAD TRANSACTIONS		Yes			

Table 2-55 (Cont.) Batch Jobs Available

Engine Type	Description	Batch Job	Description	Origination	Servicing	Collection	Product	Comment
IFP	POST UPLOADED TRANSACTIONS	ITUPRC_BJ_100_02	POST UPLOADED TRANSACTIONS		Yes			
IFP	INPUT FILE PROCESSING - CURRENCY EXCHANGE RATE FILE UPLOAD	ICEPRC_BJ_100_01	CURRENCY EXCHANGE RATE FILE UPLOAD	Yes	Yes	Yes	Common	This process extracts currency exchange rates from desired source at scheduled intervals.
IFP	INPUT FILE PROCESSING - INPUT DATA INSERTION	IDDPRC_BJ_000_01	INPUT DATA INSERTION		Yes			This process updates customer account information corresponding to the details received from external system. Ex: Bankruptcy details in External Interface screen or Cure Letter details in Account Information screen.
IFP	INPUT FILE PROCESSING	IPIPRC_BJ_100_01	PI INFORMATION FILE UPLOAD PROCESSING	Yes	Yes	Yes	Common	This process uploads input file with PII data into the data masking screen.

Table 2-55 (Cont.) Batch Jobs Available

Engine Type	Description	Batch Job	Description	Origination	Servicing	Collection	Product	Comment
IFP	INPUT FILE PROCESSING	IUHPRC_BJ_100_01	ASSET USAGE HISTORY FILE UPLOAD	Yes	Yes	Yes	Common	This process uploads asset usage details into the system. Driven through Setup > Data File tab, when placed in corresponding folder and batch job is run, system processes the file and loads in External Interfaces tab.

Table 2-55 (Cont.) Batch Jobs Available

Engine Type	Description	Batch Job	Description	Origination	Servicing	Collection	Product	Comment
IFP	INPUT FILE PROCESSING	ICPPRC_BJ_100_01	CUSTOMER PAYMENT FILE UPLOAD	Yes	Yes	Yes	Common	<p>This process uploads customer/business based payment details and are displayed in Payment Entry screen with Multi Account check box selected.</p> <p>The status of Payment batch is updated based on the value of system parameter PMT_BATCH_POSTING PREFERENCE).</p> <p>If the value is set to P (POSTED), payment job request is submitted and payment is posted. On successful posting, the payment record is available in Payment Maintenance screen.</p>
IFP	INPUT FILE PROCESSING	ISPPRC_BJ_100_01	SECURITIZATION POOL FILE UPLOAD		Yes			<p>This process reads the Securitization upload file and either attach or detach the accounts of the Pool.</p>

Table 2-55 (Cont.) Batch Jobs Available

Engine Type	Description	Batch Job	Description	Origination	Servicing	Collection	Product	Comment
IFP	INPUT FILE PROCESSING	IADPRC_BJ_100_01	ACCOUNT DUES FILE UPLOAD		Yes			This process reads the input file to derive future prorated due on a particular account. For more information refer to Proration of Future Account Dues section in Dashboard > Process Files.
PUR	ARCHIVE PURGE JOB SET	PJRPAC_BJ_100_01	PURGE ACCOUNTS DATA	Yes	Yes	Yes	Common	This process purges accounts data in archival tables based on the days defined in system parameter PAC_PURGE_DAYS.
PUR	ARCHIVE PURGE JOB SET	PJRPAP_BJ_100_01	PURGE APPLICATION DATA	Yes	Yes	Yes	Common	This process purges application data in archival tables based on the days defined in system parameter PAP_PURGE_DAYS.
PUR	ARCHIVE PURGE JOB SET	PJRPGL_BJ_100_01	PURGE GL TXNS DATA	Yes	Yes	Yes	Common	This process purges general ledger transaction data in archival tables based on the days defined in system parameter PGL_PURGE_DAYS.

Table 2-55 (Cont.) Batch Jobs Available

Engine Type	Description	Batch Job	Description	Origination	Servicing	Collection	Product	Comment
PUR	ARCHIVE PURGE JOB SET	PJRPPA_BJ_100_01	PURGE POOLS DATA	Yes	Yes	Yes	Common	This process purges pools and its transactions data in archival tables based on the days defined in system parameter PPA_PURGE_DAYS.
PUR	ARCHIVE PURGE JOB SET	PJRPPX_BJ_100_01	PURGE PRODUCER TXNS DATA	Yes	Yes	Yes	Common	This process purges producer transaction data in archival tables based on the days defined in system parameter PPX_PURGE_DAYS.
PUR	ARCHIVE PURGE JOB SET	PJRPTX_BJ_100_01	PURGE TXNS DATA	Yes	Yes	Yes	Common	This process purges account transaction data in archival tables based on the days defined in system parameter PTX_PURGE_DAYS.
PUR	ARCHIVE PURGE JOB SET	PJRPVA_BJ_100_01	PURGE VENDOR ASSIGNMENTS DATA	Yes	Yes	Yes	Common	This process purges vendor assignment data in archival tables based on the days defined in system parameter PVA_PURGE_DAYS.

Table 2-55 (Cont.) Batch Jobs Available

Engine Type	Description	Batch Job	Description	Origination	Servicing	Collection	Product	Comment
REV1	Revenue Recognition job set	REVRE C_BJ_100_01	DAILY REVENUE RECOGNITION PROCESSING	Yes	Yes	Yes	Common	This process is used to validate if Account Revenue Recognition Equity is greater than or equal to Target Revenue Recognition Equity and update the Current Qualification Indicator.
REV2	Revenue Recognition job set	REVRE C_BJ_100_02	MONTH END REVENUE RECOGNITION PROCESSING	Yes	Yes	Yes	Common	This process is used to validate the status of Account Revenue Recognition Qualifier indicator and update the following fields: <ul style="list-style-type: none"> • Account Revenue Recognition Qualifier Month End indicator (after month end processing) • Account Revenue Recognition Qualifier Date • Last Account Revenue Recognition Qualifier Date

Table 2-55 (Cont.) Batch Jobs Available

Engine Type	Description	Batch Job	Description	Origination	Servicing	Collection	Product	Comment
SETEVE	BATCH EVENTS PROCESSING	EVEPRC_BJ_100_01	BATCH EVENTS PROCESSING	Yes	Yes	Yes	Common	This process is used for BATCH EVENTS PROCESSING for the Entities Account/ Application/ Assets.
SETEVE2	EVENTS PROCESSING FOR CUSTOMER AND BUSINESS	EVEPRC_BJ_100_03	BATCH EVENTS PROCESSING (CUSTOMER AND BUSINESS ENTITIES)	Yes	Yes	Yes	Common	This process is used for BATCH EVENTS PROCESSING for the Entities Customer/ Business/ Vendors/ Producers.
SET-RTP	REAL TIME PROCESSING	IRTPRC_BJ_100_01	INCOMING FILE PROCESSING	Yes	Yes	Yes	Common	This process reads the processed data from external system loaded in the inbound_requests and inbound_request_details table with the status 'R'. Required actions like Call Activity, Transaction Posting and so on are updated in the system and after processing the status is changed to 'P' or 'F'.

Table 2-55 (Cont.) Batch Jobs Available

Engine Type	Description	Batch Job	Description	Origination	Servicing	Collection	Product	Comment
SET-ODD2	OUTPUT DATA DUMP SERVICING	OACPRC_BJ_100_01	ACCOUNT DATA EXTRACTION FILE GENERATION	No	Yes	No	Common	This process generates an Account details data dump outbound file with the data required by any external system for processing. Data for output file generation is created by OACPRC_BJ_100_02 batch job.
SET-ODD2	OUTPUT DATA DUMP SERVICING	OACPRC_BJ_100_02	PREPARE BATCH DATA FOR ACCOUNT DATA EXTRACTION FILE GENERATION	No	Yes	No	Common	This process generates the batch data needed for OACPRC_BJ_100_01 batch job. The batch consists of account details based on the Account Status and Account Condition that is configured in the lookups - OAC_ACC_STATUS_CD (ACCOUNT STATUS FOR ACCOUNT DETAILS FILE GENERATION) and OAC_ACC_CONDITION_CD (ACCOUNT CONDITION FOR ACCOUNT DETAILS FILE GENERATION).

Table 2-55 (Cont.) Batch Jobs Available

Engine Type	Description	Batch Job	Description	Origination	Servicing	Collection	Product	Comment
SET-CUP	USER DEFINED TARGET PARAMETERS CALCULATOR	CUPACC_BJ_11_01	LOAN USER DEFINED ACCOUNT TARGET PARAMETER CALCULATOR	No	Yes	No	Common	This process generates a batch of LOAN accounts for target parameter calculation. The accounts are picked based on the status maintained in lookup code CUP_ACC_STATUS_CD and if 'Skip User Parameters Calculation' is disabled in Setup > Products.
SET-CUP	USER DEFINED TARGET PARAMETERS CALCULATOR	CUPACC_BJ_12_01	LINE USER DEFINED ACCOUNT TARGET PARAMETER CALCULATOR	No	Yes	No	Common	This process generates a batch of LINE OF CREDIT accounts for target parameter calculation. The accounts are picked based on the status maintained in lookup code CUP_ACC_STATUS_CD and if 'Skip User Parameters Calculation' is disabled in Setup > Products.

Table 2-55 (Cont.) Batch Jobs Available

Engine Type	Description	Batch Job	Description	Origination	Servicing	Collection	Product	Comment
SET-CUP	USER DEFINED TARGET PARAMETERS CALCULATOR	CUPACC_BJ_121_01	LEASE USER DEFINED ACCOUNT TARGET PARAMETER CALCULATOR	No	Yes	No	Common	This process generates a batch of LEASE accounts for target parameter calculation. The accounts are picked based on the status maintained in lookup code CUP_ACC_STATUS_CD and if 'Skip User Parameters Calculation' is disabled in Setup > Products.
SET-PUR	ARCHIVE PURGE JOB SET	PODODH_BJ_100_02	ARCHIVE OUTPUT DATA DUMP TO OOTABLES	Yes	Yes	Yes	Common	This process archives data in ODD tables based on the days defined in system parameter POD_OARCHIVE_DAYS.
SET-PUR	ARCHIVE PURGE JOB SET	PJRPOD_BJ_100_01	PURGE OUTPUT DATA DUMP DATA	Yes	Yes	Yes	Common	This process purges data in ODD tables based on the days defined in system parameter POD_PURGE_DAYS.
SET-PUR	ARCHIVE PURGE JOB SET	PIDIDH_BJ_100_01	ARCHIVING INPUT DATA DUMP TABLES	Yes	Yes	Yes	Common	This process archives data in input data dump tables based on the days defined in system parameter PID_ARCHIVE_DAYS.

Table 2-55 (Cont.) Batch Jobs Available

Engine Type	Description	Batch Job	Description	Origination	Servicing	Collection	Product	Comment
SET-PUR	ARCHIVE PURGE JOB SET	PIDIDH_BJ_100_02	ARCHIVING O INPUT DATA DUMP TABLES	Yes	Yes	Yes	Common	This process archives data in 'o' input data dump tables based on the days defined in system parameter PID_OARCHIVE_DAYS.
SET-PUR	ARCHIVE PURGE JOB SET	PJRPID_BJ_100_01	PURGE INPUT DATA DUMP DATA	Yes	Yes	Yes	Common	This process purges data in input data dump tables based on the days defined in system parameter PID_PURGE_DAYS.
SET-PUR	ARCHIVE PURGE JOB SET	PJRPIP_BJ_100_01	PURGE INPUT FILE PROCESSING DATA	Yes	Yes	Yes	Common	This process purges data in input file processing tables based on the days defined in system parameter PIP_PURGE_DAYS.
SET-PUR	ARCHIVE PURGE JOB SET	PJRPOF_BJ_100_01	PURGE OUTPUT FILE PROCESSING DATA	Yes	Yes	Yes	Common	This process purges data in output file processing tables based on the days defined in system parameter POF_PURGE_DAYS.
SET-PUR	ARCHIVE PURGE JOB SET	PJRPOM_BJ_100_01	PURGE OUTBOUND MESSAGES TABLE DATA	Yes	Yes	Yes	Common	This process purges data in outbound messages tables based on the days defined in system parameter POM_PURGE_DAYS.

Table 2-55 (Cont.) Batch Jobs Available

Engine Type	Description	Batch Job	Description	Origination	Servicing	Collection	Product	Comment
SET-PUR	ARCHIVE PURGE JOB SET	PIPIF_BJ_100_01	ARCHIVING INPUT FILE PROCESSING TABLES	Yes	Yes	Yes	Common	This process archives data in input file processing tables based on the days defined in system parameter PIP_ARCHIVE_DAYS.
SET-PUR	ARCHIVE PURGE JOB SET	PIPIF_BJ_100_02	ARCHIVING O INPUT FILE PROCESSING TABLES	Yes	Yes	Yes	Common	This process archives data in 'o' input file processing tables based on the days defined in system parameter PIP_OARCHIVE_DAYS.
SET-PUR	ARCHIVE PURGE JOB SET	POFOP_F_BJ_100_01	ARCHIVING OUTPUT FILE PROCESSING TABLES	Yes	Yes	Yes	Common	This process archives data in output file processing tables based on the days defined in system parameter POF_ARCHIVE_DAYS.
SET-PUR	ARCHIVE PURGE JOB SET	POFOP_F_BJ_100_02	ARCHIVING O OUTPUT FILE PROCESSING TABLES	Yes	Yes	Yes	Common	This process archives data in 'o' output file processing tables based on the days defined in system parameter POF_OARCHIVE_DAYS.

Table 2-55 (Cont.) Batch Jobs Available

Engine Type	Description	Batch Job	Description	Origination	Servicing	Collection	Product	Comment
SET-PUR	ARCHIVE PURGE JOB SET	POMOB M_BJ_100_01	ARCHIVING OUTBOUND MESSAGES TABLES	Yes	Yes	Yes	Common	This process archives data in outbound messages tables based on the days defined in system parameter POM_ARCHIVE_DAYS.
SET-PUR	ARCHIVE PURGE JOB SET	POMOB M_BJ_100_02	ARCHIVING O OUTBOUND MESSAGES TABLES	Yes	Yes	Yes	Common	This process archives data in 'o' outbound messages tables based on the days defined in system parameter POM_OARCHIVE_DAYS.

2.11 Producer Cycles

The Producer setup screen enables you to define the dealer or producer status cycle. This tells the system which status a producer can cycle through. (This information is recorded in the Status field on the Producers section of the Producer setup screen.

For example,

Figure 2-23 Producer Cycle

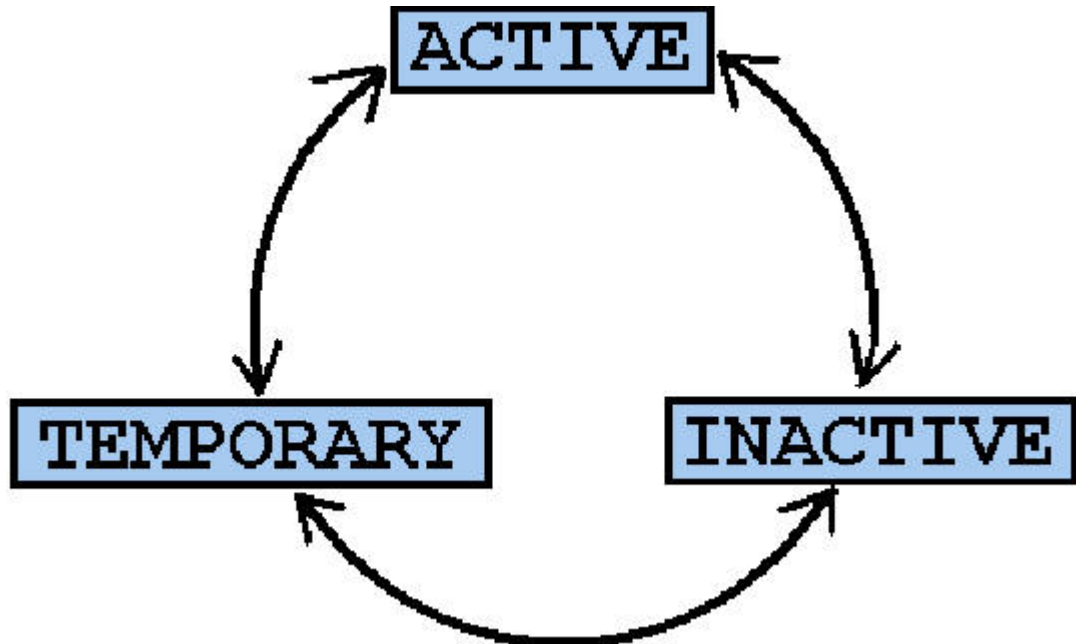

The Producer Setup screen also defines the user responsibilities capable of changing the producer status.

Note

The system enables only producers/dealers with a status of ACTIVE to fund contracts.

To set up Producer Cycles

1. On the Oracle Financial Services Lending and Leasing home screen, click **Setup > Setup > Administration > System > Producer Cycles**.
2. The system displays the Producer Cycles screen. The producer cycle screen contains three sections:
 - Cycle Definition
 - Current/Next Status
 - Status Change Responsibilities

Figure 2-24 Producer Cycles

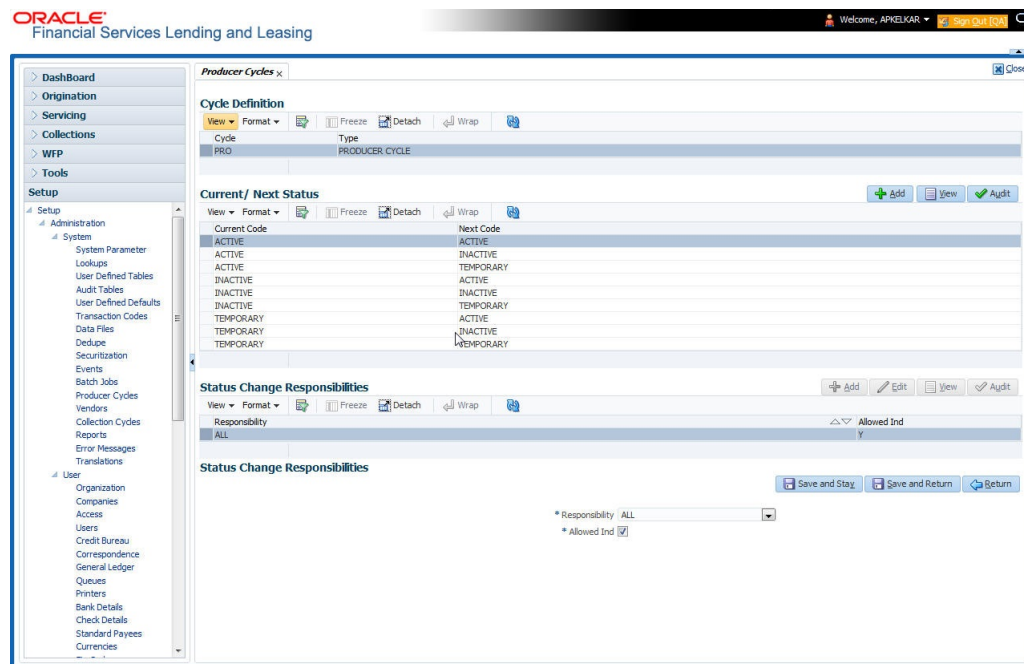

3. In the **Cycle Definitions** section, you can view the following information.

Table 2-56 Cycle Definitions

Field	View This
Cycle	Displays the cycle name.
Type	Displays the cycle type.

4. In the **Cycle/Next Status** section, perform any of the [Basic Operations](#) mentioned in Navigation chapter.
A brief description of the fields is given below:

Table 2-57 Cycle/Next Status

Field	Do this
Current Code	Select the current code from which you need to perform transition, from the drop-down list.
Next Code	Select the code to which you need to perform transition, from the drop-down list.

5. Perform any of the [Basic Actions](#) mentioned in Navigation chapter.
6. In the **Status Change Responsibilities** section, perform any of the [Basic Operations](#) mentioned in Navigation chapter.
A brief description of the fields is given below:

Table 2-58 Status Change Responsibilities

Field	Do this
Responsibility Code	Select the responsibility that will be capable of executing this transition, from the drop-down list.

Table 2-58 (Cont.) Status Change Responsibilities

Field	Do this
Allowed Indicator	Check this box to enable the responsibility to execute the transition.

2.12 Vendors

During the life of an account, a financial institution might require the use of specialized services of a vendor for various purposes; for example, repossessing a vehicle, retaining an attorney for bankruptcy court proceedings, or making field calls. With the system's Vendors screen, you can define the following:

- [Cycles Tab](#)
- [Vendor Services Tab](#)
- [Vendor Fees Tab](#)
- [Invoice Rules tab](#)

2.12.1 Cycles Tab

The Cycle link allows you to define the various vendor cycles and the responsibilities that can gain access to the various transactions in each cycle. The different categories are:

- You can define vendor status cycle and restrict the status change based on responsibility.

Figure 2-25 Vendor Status Cycle

- You can define vendor invoice status cycle and restrict the status change based on responsibility.

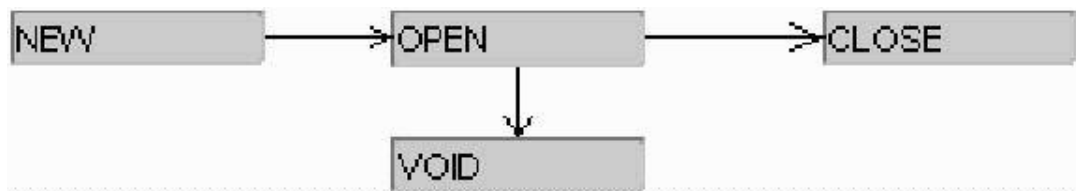
Figure 2-26 Vendor invoice status cycle

- You can define vendor assignment status cycle and restrict the status change based on responsibility.

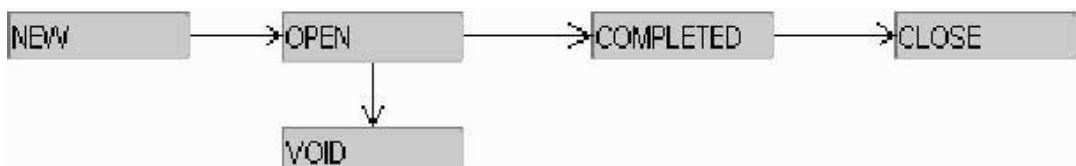
Figure 2-27 Vendor assignment status cycle

- You can define vendor invoice payment status cycle and restrict the status change based on responsibility.

Figure 2-28 Vendor invoice payment status cycle

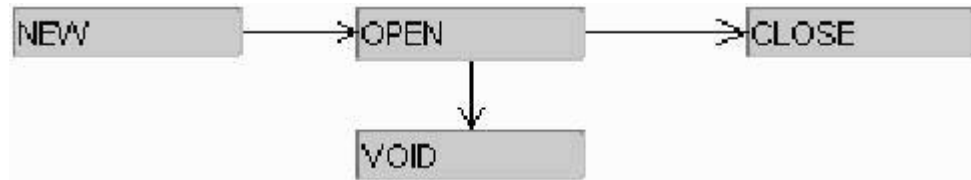

To set up the vendor cycles

- Click **Setup > Setup > Administration > System > Vendors > Cycles**. The screen contains three sections:
 - Status Cycle
 - Current/Next Status
 - Status Change Responsibilities

Figure 2-29 Vendor cycles

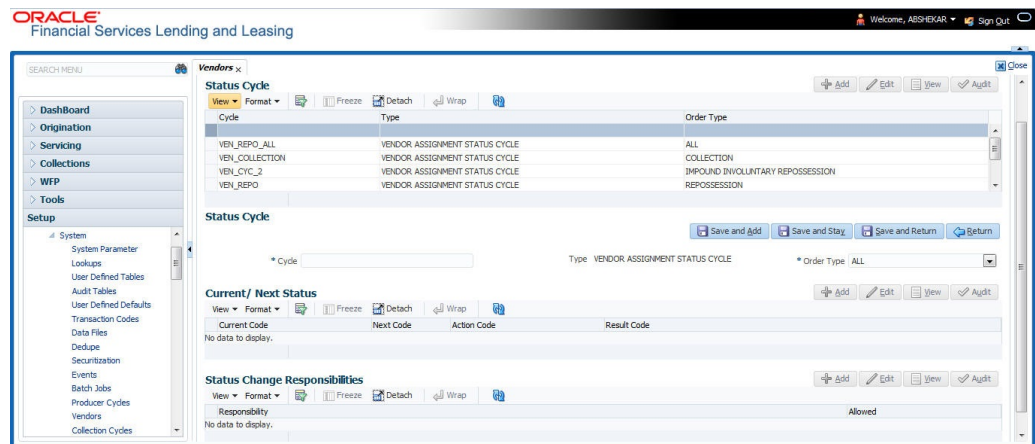

- In the **Status Cycle** section, perform any of the [Basic Operations](#) mentioned in Navigation chapter. A brief description of the fields are given below:

Table 2-59 Status Cycle

Field	View this
Cycle	Specify the status cycle for the vendor.
Type	Displays the type of vendor assignment status cycle.
Order Type	Select the work order type for the vendor from the drop-down list.

- Perform any of the [Basic Actions](#) mentioned in Navigation chapter.
- In the **Current/Next Status** section, perform any of the [Basic Operations](#) mentioned in Navigation chapter.

A brief description of the fields is given below:

Table 2-60 Vendor cycles

Field	Do this
Current Code	Select the current code from which you need to transition, from the drop-down list
Next Code	Select the Next status code to which you need to transition, from the drop-down list
Action Code	Select the call activity action code from the drop down list.
Result Code	Depending on the call activity action code, you can select the result code from the drop down list.

Note

When there is a change in status from **Current** to **Next**, system posts respective call activity on the account based on selected Action and Result code.

- Perform any of the [Basic Actions](#) mentioned in Navigation chapter.
- In the **Status Change Responsibilities** section, perform any of the [Basic Operations](#) mentioned in Navigation chapter:
A brief description of the fields is given below:

Table 2-61 Status Change Responsibilities

Field	Do this
Allowed	Select Yes to enable the responsibility to execute the transition and No to disable
Responsibility	Select the responsibility that will be capable of executing this transition (from current code to the next code), from the drop-down list.

- Perform any of the [Basic Actions](#) mentioned in Navigation chapter.

2.12.2 Vendor Services Tab

The Vendor Service screen enables you to establish the links between the service type, vendor group, and the work order type. It records which vendor groups can provide which type of services and which service type belongs to which work order types.

For each service type (Service Type field), there can be multiple vendor groups and/or multiple work order type(s). Each vendor (Group field) can belong to one or multiple vendor group(s).

- Click **Setup > Setup > Administration > System > Vendors > Vendor Services**. The screen contains three sections:
 - Services
 - Vendor Groups
 - Work Order Types

Figure 2-30 Vendor Services

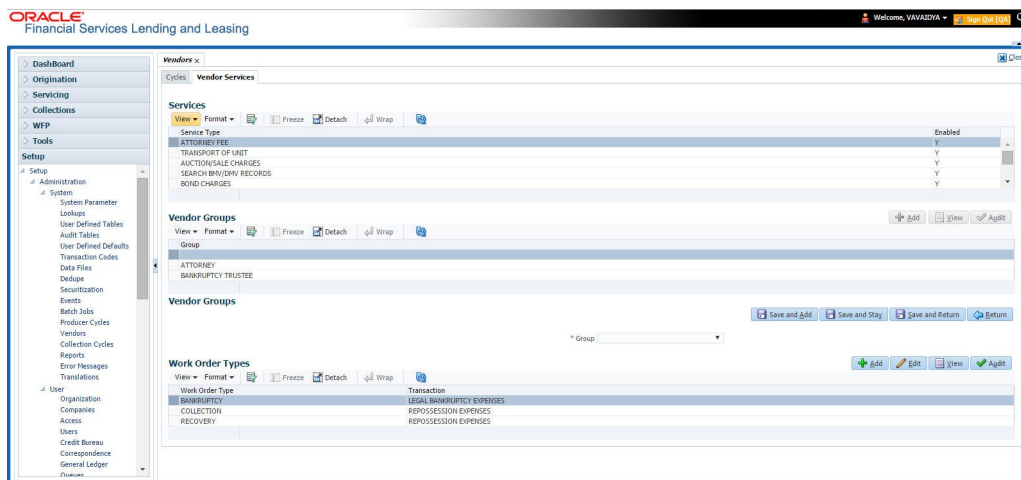

- In the **Services** section, you can view the following information:

Table 2-62 Services

Field	View this
Service Type	Displays the service type.
Enabled	Displays if the service is enabled or not.

- In the **Vendor Groups** section, perform any of the [Basic Operations](#) mentioned in Navigation chapter.
A brief description of the fields is given below:

Table 2-63 Vendor Groups

Field	Do this
Group	Select the vendor group from the drop-down list.

- Perform any of the [Basic Actions](#) mentioned in Navigation chapter.
- In the **Work Order Types** section, perform any of the [Basic Operations](#) mentioned in Navigation chapter:
A brief description of the fields is given below:

Table 2-64 Work Order Types

Field	Do this
Work Order Type	Select the work order type from the drop-down list.
Transaction	Select the associated transaction for the service type from the drop-down list.

- Perform any of the [Basic Actions](#) mentioned in Navigation chapter.

2.12.3 Vendor Fees Tab

The Vendor Fees tab allows you to define fee structure (with specific amount) for each service offered by specific vendor. The defined fees is auto populated as the estimated cost of the assignment when a specific vendor and service is selected during work order creation.

To define vendor fees

1. Click **Setup > Setup > Administration > System > Vendors > Vendor Fees**. The screen consists of Vendor Service Fee Definition section with option to define vendor fees.

Figure 2-31 Vendor Fees

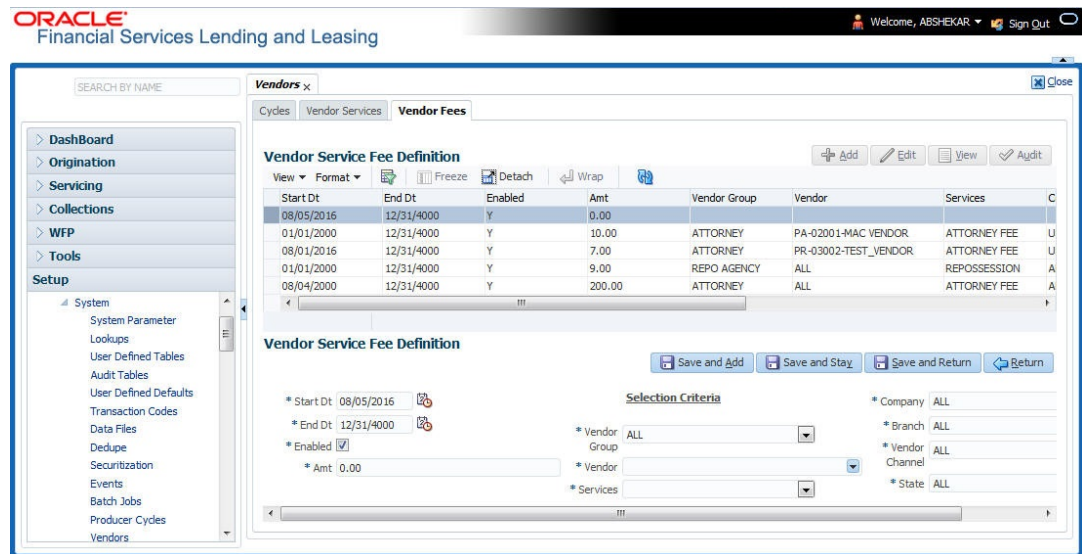

2. In the **Vendor Service Fee Definition** section, perform any of the [Basic Operations](#) mentioned in Navigation chapter. A brief description of the fields is given below:

Table 2-65 Vendor Service Fee Definition

Field	Do this
Start Dt	System defaults the current date as the start date. You can modify the same to a future date using the adjoining calendar.
End Dt	Specify the end date from the adjoining Calendar.
Enabled	Select the check box to enable the fee structure.
Amt	Specify the amount charged by the vendor for a specific service.
Selection Criteria	
Vendor Group	Select the vendor group from the drop-down list. You can also select ALL (default option) if the fee structure is applicable across vendor groups.

Table 2-65 (Cont.) Vendor Service Fee Definition

Field	Do this
Vendor	Select the vendor from the drop-down list. You can also select ALL if you have selected the Vendor Group as ALL . The list is sorted depending on the vendor group selected.
Services	Select the service from the drop-down list. The list is sorted depending on the services offered by the selected Vendor.
Company	System defaults this value based on the vendor selected. You can also select the required company from the drop-down list.
Branch	System defaults this value based on the vendor selected. You can also select the required branch from the drop-down list.
Vendor Channel	System defaults this value based on the vendor selected. You can also select the required vendor channel from the drop-down list.
State	System defaults the state in which the vendor operates. You can also select the state from the drop-down list.

3. Perform any of the [Basic Actions](#) mentioned in Navigation chapter.

2.12.4 Invoice Rules tab

The Invoice Rules tab allows you to define state specific rules with a combination of service and work order status. This helps to decide if a particular service fees in a work order is **Collectable or Not** from the customer.

When the same combination of service, work order status and state is detected during auto invoice validation, the **Collectible** check box in Vendors > Invoice tab > Invoice Details section is selected. Further, the collectible amount is posted as an expense on the customer account.

To define invoice rules

1. Click **Setup > Setup > Administration > System > Vendors > Invoice Rules**.
2. In the **Invoice Rules** section, perform any of the [Basic Operations](#) mentioned in Navigation chapter.

A brief description of the fields is given below:

Table 2-66 Invoice Rules

Field	Do this
Service	Select the service from the drop-down list. The list consists of services offered by Vendors which can be associated with a work order.
Work Order Status	Select the work order status from the drop-down list.
Close Reason	Select the close reason from the drop-down list. This field is enabled only if the work order status is selected as CLOSE .

Table 2-66 (Cont.) Invoice Rules

Field	Do this
State	Select the state from the drop-down list. The selection here indicates that the state rules allow to collect the service fee for selected service from the customer.
Enabled	Select the check box to enable the invoice rule.

3. Perform any of the [Basic Actions](#) mentioned in Navigation chapter.

2.13 Reports

The Reports screen allows you to setup reports in the system.

To set up the Reports

1. Click **Setup > Setup > Administration > System > Reports** link. The system displays the Report screen. The details are grouped into two:
 - Reports
 - Report Parameters
2. In the **Reports** section, perform any of the [Basic Operations](#) mentioned in Navigation chapter.

Figure 2-32 Reports

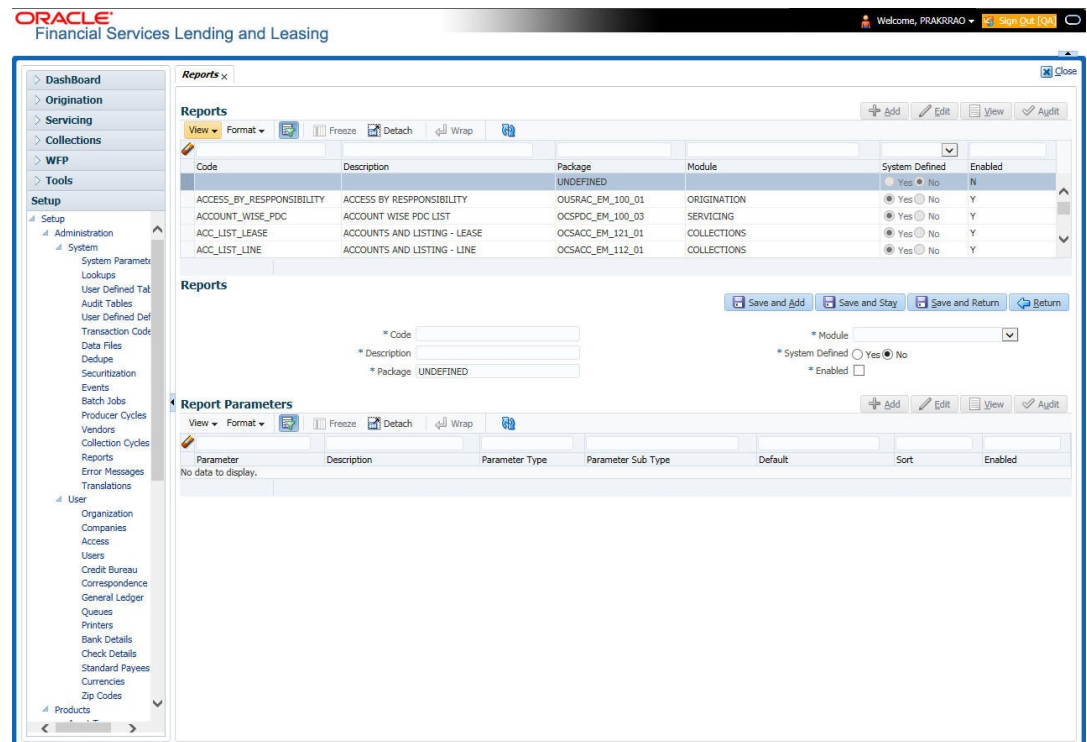

A brief description of the fields is given below:

Table 2-67 Reports

Field	Do this
Code	Specify the code of the report.
Description	Specify the description of the report.
Package	Specify the package.
Module	Select the code of the report from the drop-down list.
System Defined Yes/ No	Select Yes , if you wish to maintain the Report as system defined and No , if you do not want to maintain it as system defined. System defined entries cannot be modified. If the entry is not system defined, then it can be modified.
Enabled	Check this box to enable the report definition.

3. Perform any of the [Basic Actions](#) mentioned in Navigation chapter.
4. In the **Report Parameters** section, perform any of the [Basic Operations](#) mentioned in Navigation chapter.
A brief description of the fields is given below:

Table 2-68 Report Parameters

Field	Do this
Parameter	Specify the parameter code of the report.
Description	Specify the description of the parameter.
Parameter Type	Select the parameter type of the report from the drop-down list.
Parameter Sub Type	Select the parameter sub type of the report from the drop-down list.
Default	Specify the default value for the report parameter (value to initially populate, or used if no value is supplied) (optional).
Sort	Specify the sort order for the look up code. This determines the order these report parameters are displayed or processed.
Enabled	Check this box to enable the report definition.

5. Perform any of the [Basic Actions](#) mentioned in Navigation chapter.

2.14 Error Messages

In the Error Messages Setup screen, you can translate or modify the text of error messages. the system displays all messages as they appear to the system users in the Error Message section's Message field.

New messages created with the Error Messages screen can then be translated with the **Setup > Setup > Administration > System > Translation > Message Translation** screen.

To set up the Error Messages Setup screen

1. Click **Setup > Setup > Administration > System > Error Messages**. The system displays the Error Message screen.

2. On the **Error Messages Setup** screen's **Error Type** section, use the **Error Type** field to select the error type. These are the categories of error messages available for creating or editing.
3. The error messages associated with the error type you selected appear in the Error Message section.
4. In the **Error Messages** section, perform any of the [Basic Operations](#) mentioned in Navigation chapter.

Figure 2-33 Error Messages

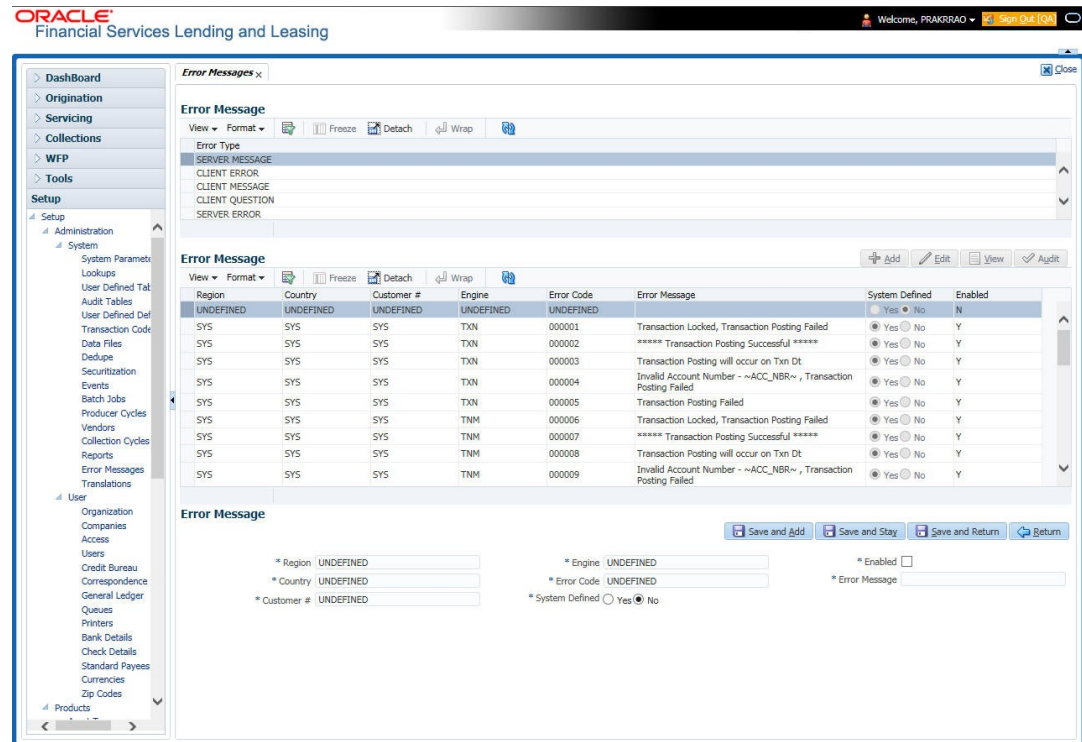

A brief description of the fields is given below:

Table 2-69 Error Messages

Field	Do this
Region	Specify the region code.
Country	Specify the country code.
Customer	Specify the customer code.
Engine	Specify the engine code.
Error Code	Specify the error code.
System Defined	Displays whether the record is system defined or not.
Enabled	Check this box to enable the data error message.
Error Message	Specify the error message.

5. Perform any of the [Basic Actions](#) mentioned in Navigation chapter.

2.15 Translation

You can setup translation properties.

Navigating to Translation

1. Click **Setup > Setup > Administration > System > Translation**. The system displays the Translation screen.
2. In this screen you can Setup Translation and Translate Error Messages in the following tabs:
 - [Setup Translation](#)
 - [Message Translation Setup](#)

2.15.1 Setup Translation

In the Setup Translation tab, you can translate the contents of a predefined list of setup description fields into a different language.

After you translate an entry in the Translation Data section, the system adds the new data to the setup form.

To set up the Translation Setup

1. Click **Setup > Setup > Administration > System > Translation > Setup Translation**.
2. In the **Language** section, you can select the language for which you need to setup the translation.

Figure 2-34 Translation Setup

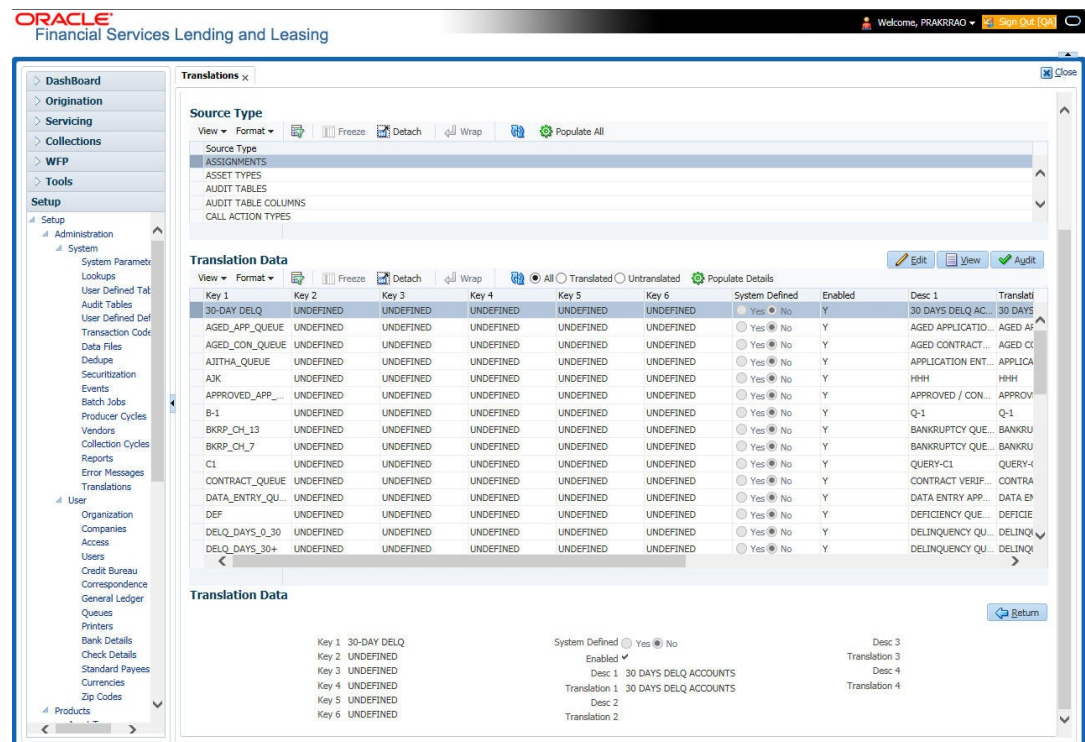

Note

For more information, refer Language setup at the end of this chapter.

3. In the **Source Type** section, you can select the source (or location in the system) of the item you want to translate.
4. Click **Populate All** in the **Source Type** section and the system loads the setup data descriptions in the Translation section screen for the selected source type. If you have new entries and are unsure as to which setup items have been updated since the last translation, click **Populate All**, the system loads the additional data for all items with no impact to the previously translated data for any of the entries.
5. In the **Translation Data** section, Select:
 - **All** – to view all the records (both translated and un-translated) in the Translation Data section.
 - **Translated** – to view all the translated records in the Translation Data section.
 - **Un Translated** – to view all the un-translated records in the Translation Data section.
6. In the **Translation Data** section, perform any of the [Basic Operations](#) mentioned in Navigation chapter.

Note

You cannot add a new record.

A brief description of the fields is given below:

Table 2-70 Translation Data

Field	Do this
Key 1	Displays the first reference key value.
Key 2	Displays the second reference key value.
Key 3	Displays the third reference key value.
Key 4	Displays the fourth reference key value.
Key 5	Displays the fifth reference key value.
Key 6	Displays the sixth reference key value.
System Defined	Select Yes , if you wish to maintain the data as system defined and No , if you do not want to maintain it as system defined.
Enabled	Check this box to indicate that the record is active.
Desc 1 Translation 1	Specify the first translated description.
Desc 2 Translation 2	Specify the second translated description.
Desc 3 Translation 3	Specify the third translated description.
Desc 4 Translation 4	Specify the fourth translated description.

7. Perform any of the [Basic Actions](#) mentioned in Navigation chapter.

2.15.2 Message Translation Setup

In the Message Translation tab, you can translate the contents of a predefined list of error messages into a different language.

After you translate an entry in the Error Message section, the system adds the new data to the error message.

To set up the Message Translation Setup

1. Click **Setup > Setup > Administration > System > Translation > Message Translation**.
2. In the **Language** section, you can select the language for which the translation needs to be done.

Figure 2-35 Message Translation Setup

The screenshot displays the Oracle Financial Services Lending and Leasing Message Translation Setup interface. The interface is divided into three main sections: Language, Error Type, and Error Message.

Language Section: A dropdown menu is set to 'ENGLISH'. Other options include 'DEFAULT' and 'FRENCH'.

Error Type Section: A dropdown menu is set to 'CLIENT ERROR'. Other options include 'CLIENT MESSAGE', 'CLIENT QUESTION', 'CLIENT WARNING', and 'SERVER ERROR'. A 'Populate All' button is visible.

Error Message Section: A table displays error messages. The table has columns: Region, Country, Customer #, Engine, Error Code, System Defined, Enabled Message, and English Translation.

Region	Country	Customer #	Engine	Error Code	System Defined	Enabled Message	English Translation
SYS	SYS	SYS	UAD	000001	Y	Y Only one ACH Def...	Only one ACH Def...
SYS	SYS	SYS	UAD	000002	Y	Y Please select a pro...	Please select a pro...
SYS	SYS	SYS	UBT	000003	Y	Y ACH details are no...	ACH details are no...
SYS	SYS	SYS	UBT	000004	Y	Y Can not view a se...	Can not view a se...
SYS	SYS	SYS	UBT	000005	Y	Y Manual batch crea...	Manual batch crea...

Below the table, there are fields for Region (SYS), Country (SYS), Customer # (SYS), Engine (UAD), Error Code (000001), System Defined (Y), and Enabled Message (ONLY ONE ACH DEFINITION OF THE SAME TYPE CAN BE ENABLED AT ONE TIME). The English Translation field contains the text: ONLY ONE ACH DEFINITION OF THE SAME TYPE CAN BE ENABLED AT ONE TIME.

Note

For more information, refer **Language** setup at the end of this chapter.

3. In the **Error Type**, you can select the type of error message you want to translate.
4. Click **Populate All** in the **Error Type** section and the system loads the error messages in the Error Message section for the selected error type.
If you have new entries and are unsure as to which error messages have been updated since the last translation, click **Populate All**, the system loads the additional data for all items with no impact to the previously translated data for any of the entries.
5. In the **Error Message** section, select:

- **All** – to view all the records (both translated and un-translated) in the Error Message section.
 - **Translated** – to view all the translated records in the Error Message section.
 - **Untranslated** – to view all the un-translated records in the Error Message section.
6. In the **Error Message** section, perform any of the [Basic Operations](#) mentioned in Navigation chapter.

Note

You cannot add a new record.

A brief description of the fields is given below:

Table 2-71 Error Message

Field	Do this
Region	Displays the region code.
Country	Displays the country code.
Customer	Displays the customer code.
Engine	Displays the engine name.
Error Code	Displays the error code.
System Defined	Check this box to indicate that the record is system defined.
Enabled	Check this box to indicate that the record is active.
Message	Specify the error message.
English Translation	Specify the English translated description.

7. Perform any of the [Basic Actions](#) mentioned in Navigation chapter.

Language setup

On the Lookup master tab's Lookup Types screen, you can add other languages to the TRD_LANGUAGE_CD lookup type and perform translations for those languages.

However, translated data only appears in one language, which is defined by the User Language parameter. This parameter can be defined in the system configuration file, typically named `DBKWEB.CFG`, which defines the parameter as:

Parameter: `otherparams=ORA_USER=<schema_name> USR_LANG=<native language>`

Note

<native language> should match lookup codes in the TRD_LANGUAGE_CD lookup type on the Administration form's Lookups screen.

The system supports the following pre-defined list of setup items for translation:

1. Asset Sub Types
2. Asset Types

3. Assignments
4. Audit Table Columns
5. Audit Tables
6. Call Action Result Types
7. Call Action Types
8. Checklist Action Types
9. Checklist Types
10. Commission Plans
11. Companies
12. Company Branch Departments
13. Company Branches
14. Compensation Plans
15. Credit Bureau Score Reasons
16. Credit Models
17. Credit Scoring Parameters
18. Edits
19. Escrow Disburse Rules
20. Escrow Sub Types
21. Flex Table Attributes
22. Flex Tables
23. GL Transaction Types
24. GL Translators
25. Job Sets
26. Jobs
27. Lookup Codes
28. Lookup Types
29. Portfolio Companies
30. Portfolio Company Branches
31. Producers
32. Product Instruments
33. Product Insurances
34. Product Pricings
35. Products
36. Promotions
37. Spreads
38. Standard Correspondences
39. Standard Document Definitions
40. Standard Element Definitions

41. Standard Function Definitions
42. Transaction Codes
43. Error Messages
44. Org. Fees

2.16 Label Configuration

The Label Configuration screen facilitates for field label customizations to modify the default field's label which are provided as part of seed data during product installation / upgrade. Using this screen, you can modify the field's User Defined Label, update Tool tip, set Default Value (if required), set display (Y/N) option and enable / disable the field. The changes done here are populated to respective screen in the application.

Note

- Label configuration is controlled by the value defined for system parameter `UIX_CUSTOM_LABEL_ENABLED_IND` and indicates whether configurable option is enabled or not.
- Also the **Update** button in Label Configuration screen is enabled only if `UIX_CUSTOM_LABEL_ENABLED_IND` is set to **Y**.

Field in the UI are categorized into two types:

- Base fields - these are default fields in the UI consisting of both mandatory and non-mandatory fields.
- User Defined Fields - these are additional fields provided in disabled status which can be enabled and customized as required.

Note the following:

- Configuring field details is only an optional functionality and has to be used sensitively.
- Field customizations are to be done cautiously and is recommended to be performed by someone who is well-versed with the product. For example, label change of a particular field is to be done at both **Section** and **Header** block to avoid inconsistency.
- Field customizations are to be performed at your sole discretion and OFSLL is not responsible for any impact/damage/mismatch in the data being represented or resulting out of this change.

The Label Configuration screen displays all the Base and User defined fields provided for the below listed screens and its sub tabs. Apart from base fields, there are additional **User Defined Fields** provided with the below combination in disabled status.

- 10 free text fields - **User Defined Field Char**
- 30 numeric fields - **User Defined Field Num**
- 10 date fields - **User Defined Field Date**

List of screens enabled with the above User Defined Fields for configuration:

- Producer Screen
- Customer Service > Checklists > Checklist Types, Action - Regular sub tab, and Action - Document sub tab.

- Customer Service > Correspondence > Correspondences sub tab, Documents sub tab, and Document Elements sub tab.
- Customer Service > Letters
- Customer Service > Collateral
- Customer Service > Account Details
- Servicing > Collateral Management > Collateral Details
- Conversion Accounts > Account Boarding > Collateral and Account Details sub tab
- Origination > Underwriting > Bureau > Report Header sub tab and all 10 sub tabs

Note

The corresponding web services are also enhanced to include the User Defined Fields. Refer to swagger web service release documentation available in OTN library ([https:// docs.oracle.com/cd/F22291_01/webservice.htm](https://docs.oracle.com/cd/F22291_01/webservice.htm)).

Ensure that the field(s) for which label changes are to be done is enabled in the UI from Access setup screen. For more information, refer to Field Access Definition section.

You can update the field properties for all the user defined fields. For Base -non mandatory fields, you can set the display (Y/N) option, define as mandatory / non mandatory and enable or disable the same in UI.

The below table indicates the supported field update options based on field type.

Table 2-72 The supported field update options based on field type

Parameter	Base Field	User Defined Field	Comment
Label change	Allowed to modify	Allowed to modify	
Data Type	Not allowed to modify - Display only	Not allowed to modify - Display only	Default data type supported by the field
Default Value	Allowed to modify	Allowed to modify	No default value
Required	Not allowed to modify	Allowed to modify	
Display (Yes/ No)	Allowed to modify for non-mandatory fields	Allowed to modify for non-mandatory fields	Cannot modify mandatory Base field

The Label Configuration screen displays the field records based on specific combination of **Language** and **Division**. By default the combination is set to **ALL** and can further be filtered by selecting required combination from respective drop-down list.

Note that the Label Configuration done for a specific division (for example US01) is displayed to those users who are mapped to the same division (US01). Else, the default labels defined for **ALL** division is displayed.

After updating the required changes in Label Configuration screen, you need to logout and relogin for changes to appear in respective UI. This is basically to refresh session cache and fetch the updated field information from database server. Though, there is **Update** option, clicking on the same only refreshes the cache and reloads the record.

To customize Label Configuration

1. Click **Setup > Setup > Administration > System > Label Configuration**.

Figure 2-36 Label Configuration

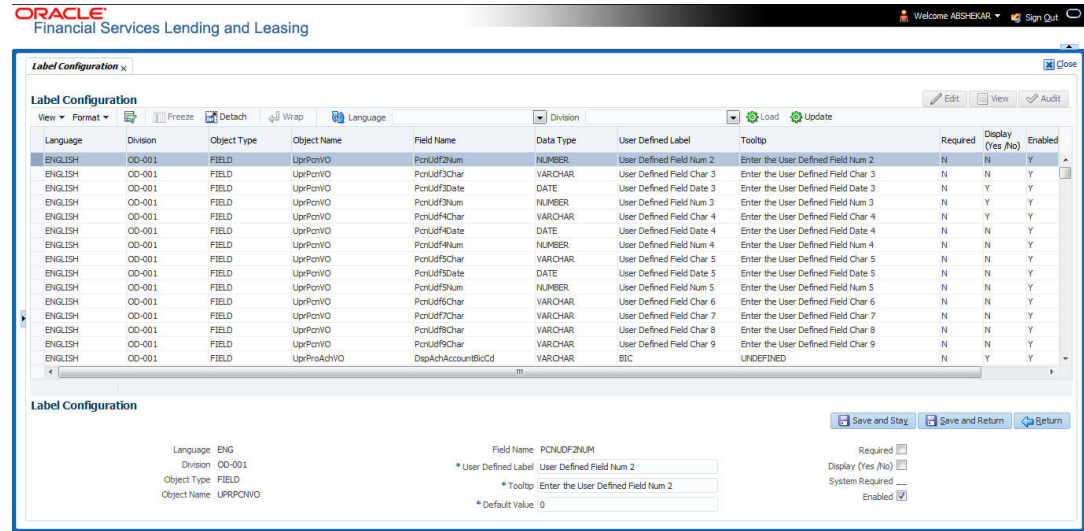

- To filter the records in Label Configuration section, select the required combination of **Language** and **Division** from the drop-down list and click **Load**.
- Select the required record and click **Edit**. You can also perform any of the [Basic Operations](#) mentioned in Navigation chapter. While looking for a specific field to customize, you might notice multiple records with similar data since one record is populated in section and other on header. Carefully differentiate and select the required record for update.

A brief description of the fields is given below:

Table 2-73 Label Configuration

Field	Do this
Language	View the language category of the field.
Division	View the division category of the field.
Object Type	View the type of object category of the field such as Tab / Field / Button / Header / Sub header.
Object Name	View the object name maintained in database.
Field Name	View the field name maintained in database.
User Defined Label	Specify the field label name to be updated in the UI.
Tooltip	Enter the tooltip indicating the type of value to be populated for the field. The same is displayed on mouse over.
Default Value	Specify the default value to be populated in UI. Based on field type, the default value set to UNDEFINED for varchar, 0 for Number, and system date for Date.
Required	Check this box to mark the field as mandatory for input in UI.

Table 2-73 (Cont.) Label Configuration

Field	Do this
Display (Yes /No)	Check this box to display the field in UI. By default, the same checked for Base - non mandatory fields. Note: Option defined here takes precedence with the display (Y/ N) option selected in Setup > Administration > Access > Screen > Field Access Configuration tab.
System Required	Y indicates the field is system required and other parameters such as Required, Display, and Enabled options are disabled. N indicates the field is user configurable.
Enabled	Check this box to enable the field and apply the label configuration changes on save.

4. Perform any of the [Basic Actions](#) mentioned in Navigation chapter.
5. Click **Update**. System refreshes the cache automatically and fetches the updated field details from database server to display in header section.

2.17 Seed Data

Seed data in general is referred to as any data delivered with the standard product installation and is required to be present in the production environment for application to work properly. Seed data basically consists of Table with its associated data that are uploaded into the system through DAT files.

Seed Data screen in Oracle Financial Services Lending and Leasing displays the seed data details maintained in the system along with the updated seed data provided with the latest release or patch installation.

Note that, when you upgrade OFSLL from an existing version to higher version,

- New seed data provided as part of that release is automatically updated into the system.
- Seed data which are modified from previous release to current release needs to be manually accepted and updated into the system.

The modified seed data can have updates on base tables and/or its associated data and the changes can either be updated or skipped depending on the need.

Navigating to Seed Data screen

1. Click **Setup > Setup > Administration > System > Seed Data**. The system displays the Seed Data screen.
2. On this screen you can do the following:
 - View the factory shipped seed data and update/skip the seed data differences between existing and updated seed data in **Factory Data** tab.
 - View the customized (i.e. changed or configured) seed data as part of implementation in **Current Data** tab.
 - View the differences between Factory data and Current data in **Comparison Data** tab
 - Download all or only the required table specific seed data in **Download Data** tab.

This section consists of the following topics:

- [Factory Data](#)
- [Current Data](#)
- [Comparison Data](#)
- [Download Data](#)

2.17.1 Factory Data

The Factory Data tab displays the list of both existing and updated seed data which are provided through release/patch installation. In the Factory Data tab you can select and update only the required seed data changes into the respective seed data tables. During update, you can also skip the seed data changes for later updates (if required).

Accordingly, you can sort the view in Factory Data tab by selecting **Skipped**, **Update** or **All** options to display the list of corresponding seed data.

In the **Patch #** drop-down list, you can further sort the list to display **ALL** the seed data or only the additions or updates available as part of latest patch which has seed data changes.

To View Factory Data

Click **Setup > Setup > Administration > System > Seed Data > Factory Data** tab.

Figure 2-37 Seed Data_Factory

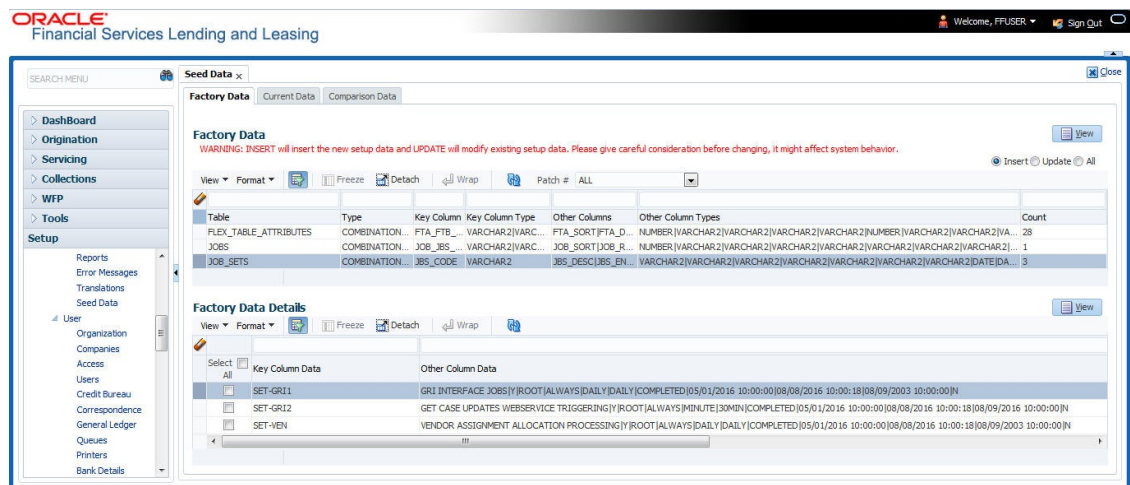

The **Factory Data** section displays the list of seed data with the following details:

Table 2-74 Factory Data

Field	View this
Table	Displays the seed data table name.
Type	Displays the category of seed data as either System or Combination Data.
Key Column	Displays the unique identifier columns.
Key Column Type	Displays the unique identifier column data types.
Other Columns	Displays the non unique identifier column names.

Table 2-74 (Cont.) Factory Data

Field	View this
Other Column Types	Displays the non unique identifier column data types.
Count	Displays the total count of updated records in the seed data table.

The **Factory Data Details** section displays the associated data of the selected seed data table along with the following details:

Table 2-75 Factory Data Details

Field	View this
Key Column Data	Displays the unique identifier column names.
Other Column Data	Displays the non unique identifier column names.
Patch #	Displays the patch number with which the seed data changes are identified.
Status	<p>Displays the current status of seed data as one of the following:</p> <p>INSERT: This status indicates new seed data.</p> <p>UPDATE: This status indicates if there are changes in the record when compared to the seed data released in previous patch.</p> <p>POSTED: This status indicates that the seed data changes are updated into the main tables and is subsequently updated from previous status - SKIPPED OR UPDATE OR INSERT.</p> <p>SKIPPED: This status indicates that the seed data is not updated into the main tables</p> <p>DEPRECATED - This status indicates that the seed data is no longer used.</p>

In the **Factory Data** tab, you can click  (refresh) to fetch the latest details and click **View** to display the detailed information of the selected record.

This section consists of the following topic:

- [Update/Skip Seed Data](#)

2.17.1.1 Update/Skip Seed Data

The **Update** option in the Factory Data tab allows you to replace the existing seed data with the current update. However, ensure to double check the details before performing **Update** operation since the same can have significant impact on system behaviour.

To Update/Skip Data

1. In the **Factory Data** tab, select **Update**. System displays those records which can be updated to the existing seed data tables.
2. Inspect the required record in Factory Data section with the Factory Data Details in subsequent section.

3. Select the required record to be updated by clicking on the adjacent check box. You can also click **Select All** to select all the records.
4. Do one of the following:
 - Click **Update Data**. This action updates the existing seed data with the updated seed data provided as part of the current patch release.
 - Click **Skip Data**. This action skips the seed data changes received as a part of the patch release. The skipped records can be viewed by selecting **Skipped** option in Factory Data tab. However, the same can further be updated into the system, by selecting **Update Data**.
5. Click **Yes** in confirmation dialog to confirm the setup data changes. On successful update, system does the following:
 - When individual records are selected and updated, the same is removed from Factory Data Details section and the **Count** column in Factory Data section is updated with the remaining number of records.
 - In case of Bulk update, the record is removed from Factory Data tab.

2.17.2 Current Data

The Current data tab displays the customized seed data which are changed or configured as part of implementation. In the **Current Data** tab, you can click  (refresh) to fetch the latest details and click **View** to display the detailed information of the selected record.

Additionally you can click **Refresh Data** to pull the seed data details from the production system and update the current seed data tables.

To View Current Data

Click **Setup > Setup > Administration > System > Seed Data > Current Data** tab.

Figure 2-38 Seed Data_Current

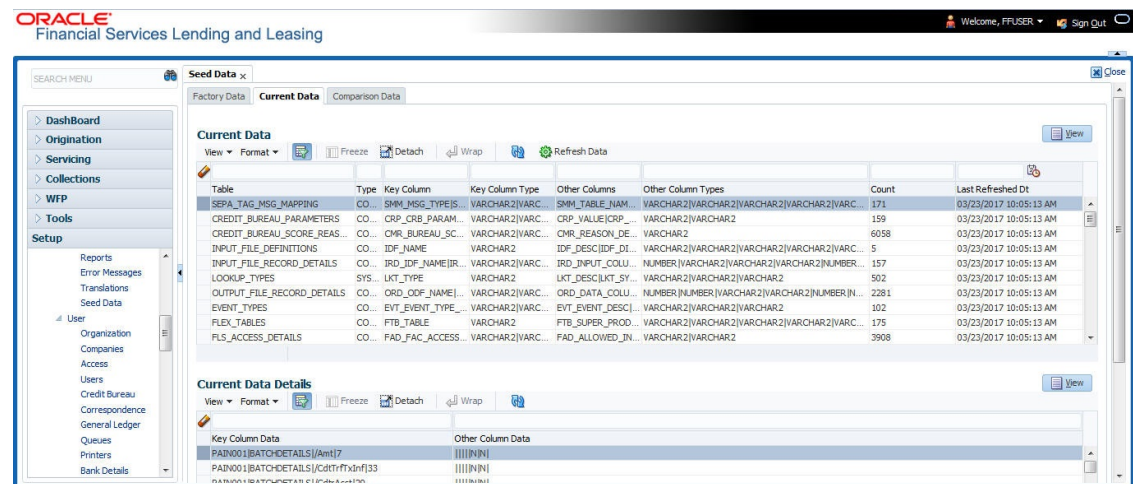

The screenshot displays the Oracle Financial Services Lending and Leasing interface. The main window is titled "Seed Data" and has tabs for "Factory Data", "Current Data", and "Comparison Data". The "Current Data" tab is active, showing a table of seed data records. The table has the following columns: Table, Type, Key Column, Key Column Type, Other Columns, Other Column Types, Count, and Last Refreshed Dt. Below the table is a "Current Data Details" section showing a detailed view of a selected record.

Table	Type	Key Column	Key Column Type	Other Columns	Other Column Types	Count	Last Refreshed Dt
SEPA_TAG_MSG_MAPPING	CO	SMM_MSG_TYPEIS...	VARCHAR2 VARC...	SMM_TABLE_NAM...	VARCHAR2 VARCHA...	171	03/23/2017 10:05:13 AM
CREDIT_BUREAU_PARAMETERS	CO	CRP_CRB_PARAM...	VARCHAR2 VARC...	CRP_VALUE CRP...	VARCHAR2 VARCHA...	159	03/23/2017 10:05:13 AM
CREDIT_BUREAU_SCORE_REAS...	CO	CMR_BUREAU_SC...	VARCHAR2 VARC...	CMR_REASON_DE...	VARCHAR2	6058	03/23/2017 10:05:13 AM
INPUT_FILE_DEFINITIONS	CO	IDF_NAME	VARCHAR2	IDF_DESC IDF_D...	VARCHAR2 VARCHA...	5	03/23/2017 10:05:13 AM
INPUT_FILE_RECORD_DETAILS	CO	IRD_ID_NAME IR...	VARCHAR2 VARC...	IRD_INPUT_COLL...	NUMBER VARCHA...	157	03/23/2017 10:05:13 AM
LOOKUP_TYPES	SYS	LKT_TYPE	VARCHAR2	LKT_DESC LKT_SY...	VARCHAR2 VARCHA...	502	03/23/2017 10:05:13 AM
OUTPUT_FILE_RECORD_DETAILS	CO	ORD_OOF_NAME ...	VARCHAR2 VARC...	ORD_DATA_COLL...	NUMBER NUMBER VARCHA...	2281	03/23/2017 10:05:13 AM
EVENT_TYPES	CO	EVT_EVENT_NAME ...	VARCHAR2 VARC...	EVT_EVENT_DESC ...	VARCHAR2 VARCHA...	102	03/23/2017 10:05:13 AM
FLEX_TABLES	CO	FTB_TABLE	VARCHAR2	FTB_SUPER_PROD...	VARCHAR2 VARCHA...	175	03/23/2017 10:05:13 AM
FLS_ACCESS_DETAILS	CO	FAD_FAC_ACCESS...	VARCHAR2 VARC...	FAD_ALLOWED_IN...	VARCHAR2 VARCHA...	3908	03/23/2017 10:05:13 AM

The "Current Data Details" section shows a detailed view of a selected record with the following columns: Key Column Data and Other Column Data. The data for the selected record is as follows:

Key Column Data	Other Column Data
PAIN001 BATCHDETAILS Amt 7	N N
PAIN001 BATCHDETAILS CdtTf TxH 33	N N
PAIN001 BATCHDETAILS CdtTf TxH 100	N N

The **Current Data** section displays the following details:

Table 2-76 Current Data

Field	View this
Table	Displays the current seed data table name.
Type	Displays the category of seed data as either System or Combination Data.
Key Column	Displays the unique identifier columns.
Key Column Type	Displays the unique identifier column data types.
Other Columns	Displays the non unique identifier column names.
Other Column Types	Displays the non unique identifier column data types.
Count	Displays the total count of records in the seed data table.
Last Refreshed Dt	Displays the date and time when seed data for the selected table was last updated in the system.

The subsequent **Current Data Details** section displays the associated data of the selected seed data table along with the following details:

Table 2-77 Current Data Details

Field	View this
Key Column Data	Displays the unique identifier column names.
Other Column Data	Displays the non unique identifier column names.

2.17.3 Comparison Data

The **Comparison Data** tab displays the differences between factory shipped seed data and current customized seed data.

To View Comparison Data

Click **Setup > Setup > Administration > System > Seed Data > Comparison Data** tab.

Figure 2-39 Seed Data_Comparison

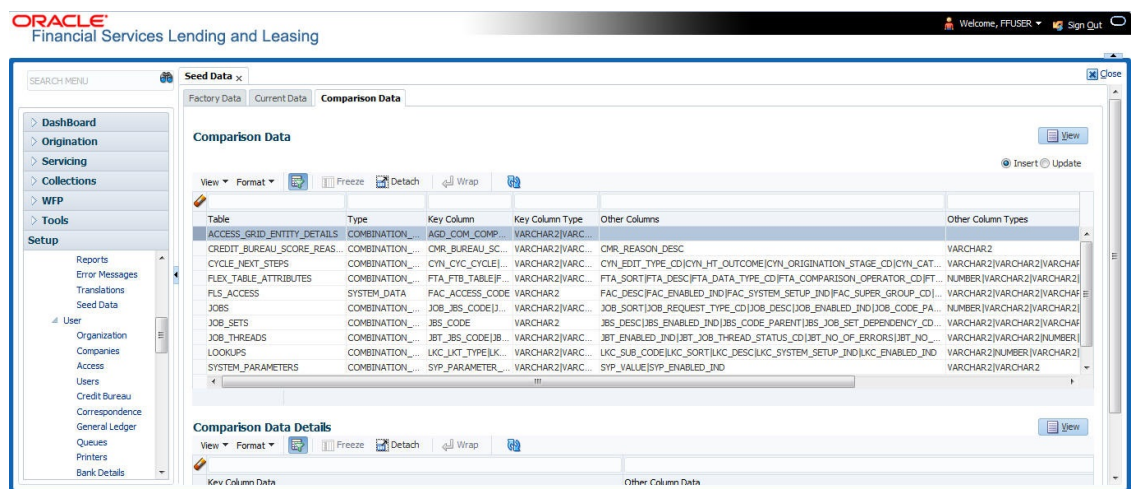

The **Comparison Data** section displays the list of seed data records with the following details:

Table 2-78 Comparison Data

Field	View this
Table	Displays the seed data table name to be inserted or updated.
Type	Displays the category of seed data as either System or Combination Data.
Key Column	Displays the unique identifier columns.
Key Column Type	Displays the unique identifier column data types.
Other Columns	Displays the non unique identifier column names.
Other Column Types	Displays the non unique identifier column data types.
Count	Displays the total count of records in the seed data table.

The subsequent **Comparison Data Details** section displays the associated data of the selected seed data table along with the following details:

Table 2-79 Comparison Data Details

Field	View this
Key Column Data	Displays the unique identifier column names.
Other Column Data	Displays the non unique identifier column names.
Patch #	Displays the patch release version with which the seed data was inserted/updated.

In the **Comparison Data** tab, you can click  (refresh) to fetch the latest details and click **View** to display the detailed information of the selected record.

2.17.4 Download Data

The Download Data tab allows you to download table specific seed data available in the system in `.dat` format. While migrating from one environment to other, you can use the Download Data tab to download the existing seed data and perform a bulk upload of all/required files.

Similar to other file download process, based on the value defined for the system parameter `CMN_FILE_PROCESS_TO_LOB`, the seed data download file can be accessed from the Process Files interface (if value is **Y**) or Database Files system (if value is **N**). For more information on handling Incoming/Outgoing process files, refer to **Dashboard** section in User Guides.

To Download Data

1. Click **Setup > Setup > Administration > System > Seed Data > Download Data** tab.

Figure 2-40 Seed Data_Download

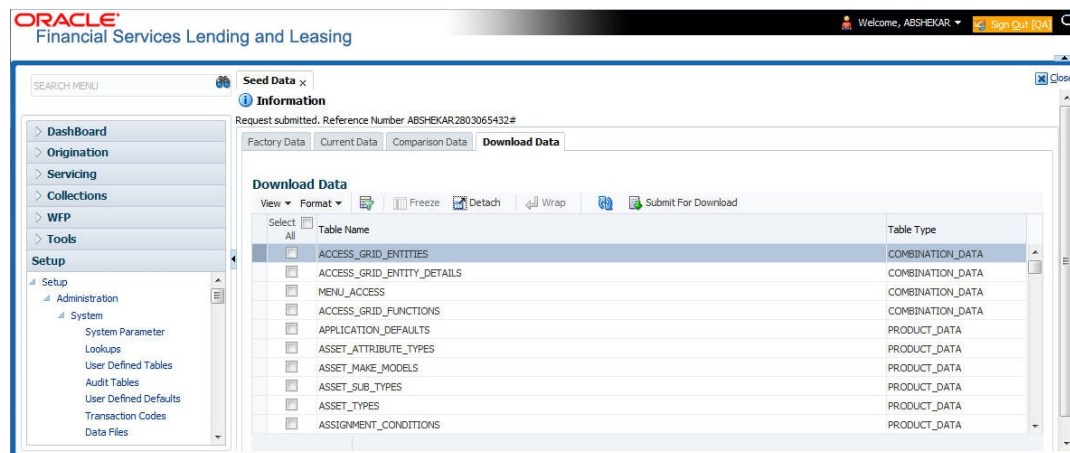

The Download Data section displays the list of tables maintained in the system with **Table Name** and **Table Type**. Click  (refresh) to fetch the latest details.

2. Select the check box adjacent to the required table in the list. You can choose **Select All** check box to select all the tables with seed data maintained in the system.
3. Click **Submit For Download** button. System displays an information message in the header indicating that the request has been submitted along with a reference number. The reference number is generated in format - useridDDMMHMISS# followed by table name with .dat extension. For example, (USER1230603121517#lookups.dat)
4. (Optional) If CMN_FILE_PROCESS_TO_LOB is set to **Y**, navigate to Dashboard > Process Files screen > Outgoing Process File tab to download the selected seed data file which will be listed with the same reference number. The file can be downloaded to Application server.

2.18 Data Masking

Data masking screen in Oracle Financial Services Lending and Leasing facilitates to mask Personally Identifiable Information (PII) displayed in the application to safeguard the sensitive and confidential information while protecting them from offenders.

As part of the product installation, standard set of identified fields (seed data) which is likely to contain either organization / customer PI information are provided for data masking in disabled status. Based on need, the required fields can be enabled and masked for specific user responsibility in the Data Masking screen. Also if there are additional PII fields identified for masking, the same can be pooled into the system using input file processing method and masked using Data Masking screen.

The data masking process involves the following steps:

- Identify and enable field(s) (seed data) to be masked
- Select user responsibility for whom the data has to be masked
- Execute batch job to create data redaction policy
- Compile the data redaction policy
- (Optional) Process user identified PII data for masking.

The following table indicates the standard pre-defined fields (seed data) identified in respective screens/tabs which can be readily masked using the Data Masking screen.

Table 2-80 Data Masking

Tab Name	Field Names
Origination	
Applicant	First Name, MI, Last Name, Family Name, Birth Dt, Nationality, National ID, Visa #, Passport #, License #, Marital status, Mother's maiden name, Passport number, Gender, Language, Dependents, Ethnicity, Disability, Email, Race, and Education.
Applicant > FATCA	Birth Place, Birth Country, and Permanent US Resident Status.
Applicant > Power of Attorney	Holder Name, Address, Country, Nationality, and Telephone Number.
Applicant	Active Military Duty, Military Effective Date, Duty Order Number, and Active Military duty Release date.
Addresses	Country, Postal Address Type, Address #, Street Pre, Street Name, Street Type, Street Post, Apt #, Address 1, Address 2, Address 3, Zip, Zip Extn, City, State, and Phone.
Telecoms	Phone and Extn
Employments	Employer, Country, Address #, Address 1, Address 2, Zip, Zip Extn, City, State, Phone, Extn, Income Amt - Stated, Income Amt - Actual, Salary - Stated, Salary - Actual, and Title.
Applicant > Financials	Type, Source, Account #, and Currency.
Existing Accounts	Account # and Title.
Servicing	
Customer	Name, Birth Dt, Nationality, National ID, Visa #, Passport #, License #, Marital status, Mother's maiden name, Passport #, Language, Disability, Email, and Education.
Customer > FATCA	Birth Place, Birth Country, and Permanent US Resident Status.
Customer > Power of Attorney	Holder Name, Address, Country, Nationality, and Telephone Number.
Customer	Active Military Duty, Military Effective Date, Duty Order Number, and Active Military duty Release date.
Addresses	Country, Postal Address Type, Address #, Street Pre, Street Name, Street Type, Street Post, Apt #, Address 1, Address 2, Address 3, Zip, Zip Extn, City, State, Phone, and Address.
Employments	Employer, Country, Address #, Address 1, Address 2, Zip, Zip Extn, City, State, Phone, Extn, and Title.
Assets tab	
Assets	Identification #, Lien Status, Lien Event Date, Second Lien Holder, Comments, Lien Release Entity, and Entity Name.

Masking Format

Oracle Financial Services Lending and Leasing supports only complete masking (not partial) of both factory shipped and user identified PII data. On masking, the masked data is presented in same structural format to facilitate internal validations. The below table indicates the default values used for masking fields based on data type:

Table 2-81 Masking Format

Data Type	Masking Value
NUMBER	9
VARCHAR	X
DATE	31/12/9999
Phone number	For UI represented format - 000-000-0009 (Masked with 0's and last digit as 9) and for generic, masked as 9999999999
Email	xxxxx.xxx@<domain>.com

Note

It is recommended to avoid modifying masked data for user(s) with masked responsibility. However, while editing masked data (if permitted) requires to input full data replacing the masked characters. For example, editing a masked SSN (xxx.xx.xxxx) requires to specify all nine digits of SSN and not just the last four digits.

This section consists of the following topics:

- [Setup Data Masking](#)
- [Create data redaction policy](#)
- [Masking User defined data](#)

2.18.1 Setup Data Masking

1. Click **Setup > Administration > System > Data Masking**.
2. Define the parameters available in following tabs.
 - [Data Masking Details](#)
 - [User Access Details](#)

2.18.1.1 Data Masking Details

On clicking Data Masking link, the Data Masking Details tab is displayed by default and allows you to enable the required fields for masking.

Figure 2-41 Data Masking Details

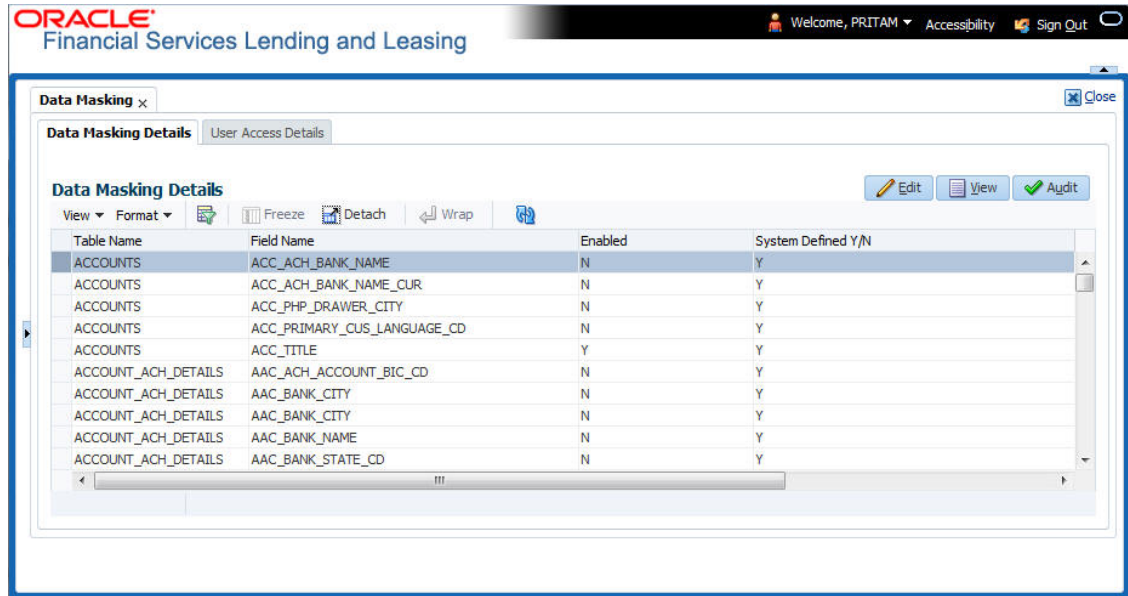

- In the Data Masking Details section, perform any of the [Basic Operations](#) mentioned in Navigation chapter.
A brief description of the fields are given below:

Table 2-82 Data Masking Details

Field	Do this
Table Name	View the table name which contains the selected field details.
Field Name	View the selected field name.
Enabled	Check this box to enable masking of the selected field.
System Defined	View the type of seed data maintained in the system. Y indicates factory shipped seed data and N indicates user defined seed data.

- Perform any of the [Basic Actions](#) mentioned in Navigation chapter.

2.18.1.2 User Access Details

The User Access Details tab facilitates to define the user responsibility to whom the PII data should be masked. By default, all the selected PII data in Data Masking Details tab appears as masked for one or more user(s) selected in this tab.

- Click **Setup > Administration > System > Data Masking > User Access Details**.

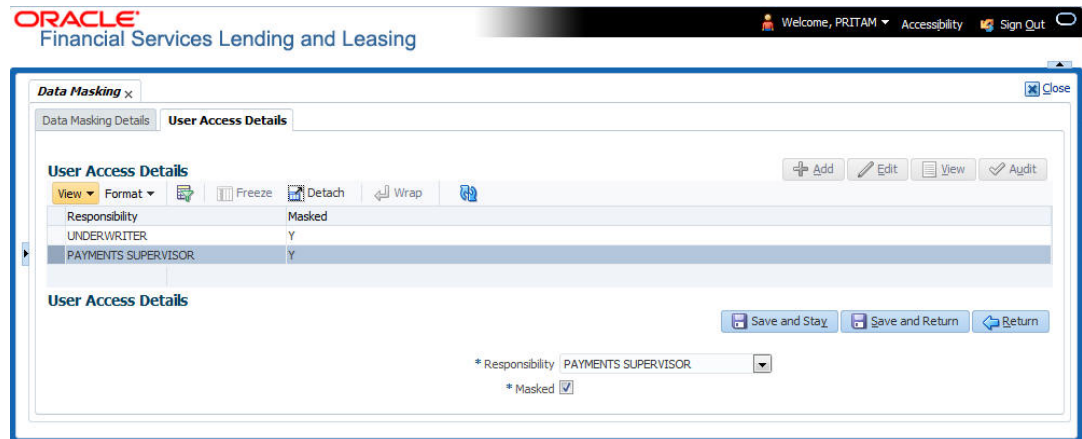
Figure 2-42 User Access Details

- In the User Access Details section, perform any of the [Basic Operations](#) mentioned in Navigation chapter.
A brief description of the fields are given below:

Table 2-83 User Access Details

Field	Do this
Responsibility	Select the user responsibility from the drop-down list.
Masked	Check this box to enable masking for the selected user. Note: Defining a user and not selecting the masked check box will only create the record and masking rules are not applied.

- Perform any of the [Basic Actions](#) mentioned in Navigation chapter.

2.18.2 Create data redaction policy

Once the data masking details are defined and stored in the database, you need to create a data redaction policy which facilitates for field level masking while displaying the details to the respective user. A data redaction policy file contains the policies on the columns enabled in the Data Masking Details screen.

To create data redaction policy

Click **Setup > Administration > System > Batch Jobs** and execute the following batch job (in single thread mode only):

Table 2-84 Create data redaction policy

Set Code	Description	Job Code
SET-RED	POLICY CREATION FOR PERSONAL IDENTIFIABLE INFORMATION DATA	REDPRC_BJ_100_01

This batch job can either be scheduled for regular run or executed on-demand and facilitates to generate data redaction policy picking only the enabled data masking field information from

database. On every run, the batch job drops and re-creates new set of policies in the file based on the details updated in Data Masking Details screen.

The generated policy is either written into CLOB or sql file depending on the following option:

- if the value of system parameter `CMN_FILE_PROCESS_TO_LOB` is set to **Y**, the policy file is generated in CLOB and can be accessed by navigating to DashBoard > Process Files screen. For more information on handling Incoming/Outgoing process files, refer to **Dashboard** section in User Guides.
- If the value of system parameter `CMN_FILE_PROCESS_TO_LOB` is **N**, the policy is generated as an sql file and stored in the repository path as defined in the system parameter - `CMN_SERVER_HOME`. For example, `/scratch/OFSLL/<release>/sql`.

Further, the policy file needs to be manually compiled into database schema to apply the masking rules for respective fields for that particular user. Either a system administrator or any other user having administration privileges needs to compile the policies in the database.

Note

For every change in the data masking details such as masking additional fields or unmasking / disabling masked fields, a new policy is to be created by executing the batch job.

2.18.3 Masking User defined data

Apart from factory shipped seed data, additional user identified PII data can be masked by uploading an input file with field details and processing it in Data Masking screen using input file processing method.

1. On identifying the fields, create an input file (in text file format) with table name, column name, and enabled indicator (Y/N) for each field level record. If enabled indicator is **N**, the record is not processed for data masking.
For example, `BUSINESS_APPL_DETAILS,BSD_LEGAL_NAME,N`
2. Place the input file to the path as defined in system parameter `IPI_DIRECTORY`. For example, `$OFSLL_HOME/input/ipi`
3. Navigate to **Setup > Administration > System > Batch Jobs** screen and execute the following batch job:

Table 2-85 Masking User defined data

Set Code	Description	Job Code
SET-IFP	PI INFORMATION FILE UPLOAD PROCESSING	IPIPRC_BJ_100_01

On execution, the batch job picks the file from the location, processes it and loads the seed data into Data Masking screen. By default, all the user identified PII data from input file is categorized separately in Data Masking screen by assigning the value of **System Defined** property as **N**.

Once the data is available in Data Masking screen, enable the required fields, assign user responsibility and run the processing batch job - `redprc_bj_100_01` to generate a redaction policy. For more details, refer [Create data redaction policy](#) section.

Note

In addition, an xml sample file with PII fields data is provided in the installation bundle (docs folder). The same is generated through Application Data Model (ADM) and can be imported to view the details of PII masked fields. However to do so, you need to have Oracle Cloud 13c installed.

2.19 Webhook

Webhook in OFSLL provides a facility to integrate with third-party external applications by sending REST API based notifications of changes through system generated Webhook event actions.

In the Webhook screen, you can register third-party applications to which you can notify the changes that are done in OFSLL by triggering Webhook request as an event action.

In this type of integration, the server which is OFSLL propagates the information to the dependant third-party applications (client) when a specific type of change has happened in OFSLL. For example, when customer details are updated in OFSLL.

In the Webhook screen, you can maintain Webhook definition details and associate Event Details along with Authentication Attributes.

Figure 2-43 Webhook

The screenshot displays the Oracle Financial Services Lending and Leasing Webhook configuration interface. The top navigation bar includes the Oracle logo, 'Financial Services Lending and Leasing', and user information: 'NextGenUI Welcome ABSHEKAR Sign Out (PROD)'. The main window is titled 'Webhook' and contains a table of existing webhooks and a configuration form for a selected one.

Channel	Authentication Mode	Enabled
test	OAUTH2.0	Y
opds	ORACLE BANKING ROUTING HUB	Y

The configuration form for the selected 'opds' channel includes the following fields:

- Channel: OPDS
- Client Secret Key: ZxIKMGVYQWIPaUpLvjFRaUxDS mhiR21pT2IKSVV6XhnaJusLm V55ngkV9lpT2IKWJF3Y5KJUMDIMS
- * Authentication mode: ORACLE BANKING ROUTING HUB
- * User Name: TESTUSER1
- * Password: *****
- * Token Header Key: Authorization
- Response Token Key: token
- Request Authorization Header: Bearer
- Prefix: Verified
- * Service URL: http://whf00dva.in.oracle.com:7003/ofsl14
- Test Service URL: http://whf00dva.in.oracle.com:7003/ofsl14
- * Token URL: http://whf00dva.in.oracle.com:7003/ofsl14
- * Enabled:

Below the configuration form is the 'Authentication Attributes' section, which contains a table of attributes:

Attribute Type	Attribute Key	Attribute Value	Enabled
REQUEST HEADER	SERVICE-CONSUMER-SERVICE	fetchCreditDecisionScore	Y
REQUEST HEADER	enbyId	DEFAULTITY	Y
REQUEST HEADER	appId	CMNCORE	Y
REQUEST HEADER	userId	TESTUSER1	Y
REQUEST HEADER	SERVICE-CONSUMER	OBX_FOR_CDS	Y
TOKEN REQUEST HEADER	appId	SECSR001	Y
REQUEST HEADER	branchCode	000	Y

This section consists of the following topics:

- [Webhook Definition](#)
- [Event Details](#)

- [Authentication Attributes](#)
- [Monitoring Webhook Events](#)

2.19.1 Webhook Definition

In a Webhook definition, you can create a Channel with specific third party authentication mode, provide test and service url and generate secret key.

To setup Webhook Definition

1. Select Setup > Administration > System > Webhook.
2. In the **Webhook** section, perform any of the [Basic Operations](#) mentioned in Navigation chapter.

A brief description of the fields are given below:

Table 2-86 Webhook Definition

Field	Do this
Channel	Specify the channel name of interfaced third-party application for identification. The same will be added into weblogic Key Store.
Client Secret Key	The client secret key is auto generated by the system on clicking Generate button after defining the details. If already generated, the same can be used to regenerate
Service URL	Specify the context path of third-party application's Webhook Service URL used for communication where POST request is to be provided. You can define multiple service end-point URLs for the same channel.
Test Service URL	Specify the GET web service Webhook URL of third-party application to check service availability. Click Test button to generate sample test call. The status, either success or error of the test call is displayed on the screen as SERVICE URL TEST SUCCESSFUL/FAILED. Refer step 4 below for more information.
Enabled	Check this box to enable the Webhook definition.

Table 2-86 (Cont.) Webhook Definition

Field	Do this
Authentication mode	<p>Select the authentication mode of third-party application from the drop-down list. The list is displayed based on lookup code WHK_AUTH_MODE_CD. System supports the following options:</p> <p>BASIC - On selecting this option, you need to define User Name and Password to authenticate.</p> <p>OAUTH2.0 - On selecting this option, you need to define additional enabled fields such as Grant Type, Client Id, Client Secret, Identity Domain, Token and Header Key.</p> <p>ORACLE BANKING ROUTING HUB - On selecting this option, you need to define User Name, Password, Token Header Key, Response Token Key, and Request Authorization Header Prefix to authenticate.</p> <p>Note: Based on the above selection, additional Webhook definition fields are enabled and need to be populated accordingly.</p>
The following additional fields are available for BASIC type of Authentication mode:	
User Name	Specify the Basic Authentication User Name.
Password	Specify the Basic Authentication User Password.
The following additional fields are enabled for OAUTH2.0 type of Authentication mode:	
Token URL	Specify the third-party OAUTH 2.0 token generation URL.
Grant Type	Select the OAUTH 2.0 grant type from the drop-down list. The list is populated based on lookup code WHK_GRANT_TYPE_CD.
Client Id	Specify the identification name of third-party OAUTH 2.0 client.
Client Secret	Specify the secret code of third-party OAUTH 2.0 client.
Identity Domain	Specify the domain name of the third-party OAUTH 2.0 client.
Token Header Key	Specify the token header key of third-party OAUTH 2.0 client.
Response Token Key	<p>Specify the Response Token Key of third-party OAUTH 2.0 client which is the key name of Authentication Response Header. The same is used to identify token value used as input for subsequent calls.</p> <p>Note: If value is not provided, system defaults to access_token.</p>
Request Authorization Header Prefix	<p>Specify the Request Authorization Header Prefix of third-party OAUTH 2.0 client This is the prefix used to Request Authorization Header based on token generation mechanism like Basic, Bearer, JWT and so on.</p> <p>Note: If value is not provided, system defaults to Bearer.</p>

Table 2-86 (Cont.) Webhook Definition

Field	Do this
User Name	If Authentication mode is selected as OAUTH2.0 and Grant Type as Resource Owner Password , specify the third-party OAUTH 2.0 Resource Owner User Name.
Password	If Authentication mode is selected as OAUTH2.0 and Grant Type as Resource Owner Password , specify the third-party OAUTH 2.0 Resource Owner User Password.
The following additional fields are enabled for ORACLE BANKING ROUTING HUB (OBRH) type of Authentication mode:	
User Name	Specify the third-party OBRH Resource Owner User Name.
Password	Specify the third-party OBRH Resource Owner Password.
Token Header Key	Specify the token header key of third-party OBRH client.
Response Token Key	Specify the Response Token Key of third-party OBRH client which is the key name of Authentication Response Header. The same is used to identify token value used as input for subsequent calls. Note: If value is not provided, system defaults to <code>access_token</code> . An example is indicated below where token element is the key name:
	
Request Authorization Header Prefix	Specify the Request Authorization Header Prefix of third-party OBRH client This is the prefix used to Request Authorization Header based on token generation mechanism like Basic, Bearer, JWT and so on. Note: If value is not provided, system defaults to Bearer. An example is indicated below:
	

Table 2-86 (Cont.) Webhook Definition

Field	Do this
Bureau <Check if required>	<p>Select the Credit Bureau from the drop-down list. This is required if the Credit Bureau report format is to be processed externally as defined in Setup > Administration > User > Credit Bureau screen.</p> <p>The list is populated with credit bureau details maintained in CRB_SOURCE_CD lookup. This field is enabled only during ADD process and is Read-Only during EDIT.</p> <p>Ensure that the selected Bureau is not already selected for the enabled record. Else, system displays an error indicating Record already exist with same bureau and need to disable the existing record and enable the new record with the new Bureau.</p> <p>Note: The Event Details section is not displayed if the Credit Bureau report format is to be processed externally.</p>
Verified	<p>This check box is auto selected on verifying the channel data by clicking TEST button and if the test server connection is successful.</p>

3. Perform any of the [Basic Actions](#) mentioned in Navigation chapter.
4. Click **Test** button to verify the configuration details of third-party application.
 - Th external system generates base 64 X-Hmac header using HMAC SHA 256 and propagate this as part of response header to OFSLL.
 - Channel name is used in HMAC digest as given below. This will be passed to the external interface using HTTP Header Key **ChannelName**. This value will be in base 64 encoded format.
 - System will validate this response and update the Verified indicator. Only HTTP status code 200 is considered as success.

Format: "OFSLL": Base64 Encoded [HMAC SHA 256 of ["Http Method Types": "Base64 Encoded Channel Name": "Service URL"] with Client Secret Key]

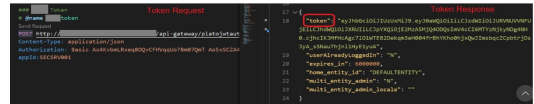
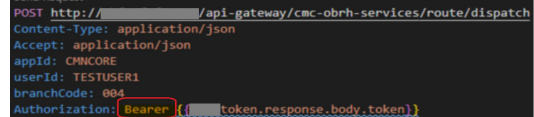
For example:

Client Secret Key

```
ZXlKMGVYQWlPaUpLVjFRaUxDSmhiR2NpT2lKSVV6VXhNaUo5LmV5SnpkV0lp
T2lKWFJVSk1UMDlMSWl3aVEwaEJUazVGVENJNklrVllWRVZTVGtGTVNVNVVS
VkpHUVVORkxVOUJWVlJjTWpBaUxDSnBjM0lpT2lKUFJsTk1URjlyU1VKSVQw
OUxJaXdpWlhod0lqb3hOVFUxTmPnMU1qSXpMQ0pwVWVhRaU9qRTFOVFUyT0
RRNU1qTjkuemxMb0lzdWduek1FRnhyblcxYXJJeXNMSFliSmVQd0R5SUxvdDdU
aXZDMEFVUktEbm5WcDJpWmRiT1pJald5aHNfSWxNaG1lV1dWZUF0YmZRUnl
1X2c=
```

Cipher Text for HMAC SHA 256

```
GET:RVhURVJOQUxJTlRFUkZBQ0UtT0FVVEgyMA==:application/json:https://
Hostname:Port/webhook_oauthqa/service/api/resources/webhook/test
```

Generated Sample **X-Hmac** header

```
OFSLL:F/jj07qhgM3g5z91EHU/rdxYbaJ266SRnXsBRoUxgUc=
```

 **Note**

Configuration details for OBRH application cannot be verified using Test option since OBRH currently does not support return of customizing HTTP header [X-Hmac].

- Clicking **Generate** button OFSLL generates Client Secret Key. This key is used in generation of X-HMAC header that is sent to the third-party channel to validate origination of the request.

System generated **X-HMAC** header uses base 64 encoded HMAC SHA 256 algorithm. This algorithm uses below logic:

Format: "OFSLL": Base64 Encoded [HMAC SHA 256 of ["Http Method Types":"Base64 Encoded Payload":" Http Content Types": "Service URL"] with Client Secret Key]

For example.

Client Secret Key

```
T0ZTTExfQjJCX1RFU1RfQ0xJRU5UOndlbnGNvbWUx
```

Cipher Text for HMAC SHA 256

```
POST:ewogICAgIlJlcXVlc3RUeXB1IjogIk9VVEJPVU5EIgp9:application/json:http://  
Hostname:Port/webhook/service/api/resources/webhook/basic
```

Generated Sample **X-Hmac** header

```
OFSLL:q6xCpZrnudfB8owvYEi2+Aac4c1M3b/XFVTVrChdQKA=
```

2.19.2 Event Details

The Event Details section acts as a single point of entry to define and update required Webhook Events in the system. In Event Details, you can define service end points of thirdparty application which accepts the communicated changes. Multiple end points can be defined to a single channel for each Event Criteria. These details are displayed as Webhook Event Action in Setup > Administration > System > Events screen.

To define Event Details

- Select Setup > Administration > System > Webhook.
- Select the required definition in **Webhook** section.
- In the Event Details section, perform any of the [Basic Operations](#) mentioned in Navigation chapter.

A brief description of the fields are given below:

Table 2-87 Event Details

Field	Do this
Event	Select the event code from the drop-down list. The list is populated based on the enabled event codes maintained in Events setup screen.
Event Criteria	Select the event criteria from the drop-down list. The list is populated based on the enabled event criteria maintained for the selected event in Events setup screen.
Service End Point	Specify the third-party application end point URL which is propagated to Event Definition as an Event Action Parameter.
Event Message	Specify the event message which is propagated to Event Definition as an Event Action Parameter.
Enabled	Select this check box to enable the event details in the system.

- Click  button and add the event details to the list.
- Perform any of the [Basic Actions](#) mentioned in Navigation chapter.

2.19.3 Authentication Attributes

For connecting to some of the third-party applications, addition Authentication attributes and Request Header is required to be sent from OFSLL. In the Authentication Attributes, you can define those specific attributes required for authentication. Multiple authentication attributes can be defined to a Webhook definition.

To define Authentication Attributes

- Select Setup > Administration > System > Webhook.
- Select the required definition in **Webhook** section and click **Authentication Attributes** sub tab.
- Perform any of the [Basic Operations](#) mentioned in Navigation chapter. A brief description of the fields are given below:

Table 2-88 Authentication Attributes

Field	Do this
Attribute Type	Select the required Attribute Type which is used to record HTTP header type from the drop-down list: <ul style="list-style-type: none"> TOKEN REQUEST HEADER: This is used to add Authentication request header details. REQUEST HEADER: This is used to add Request header details.
Attribute Key	Specify the HTTP header key.
Attribute Value	Specify the HTTP header value.
Enabled	Select this check box to enable the Authentication Attributes details in the system.

- Perform any of the [Basic Actions](#) mentioned in Navigation chapter.

2.19.4 Monitoring Webhook Events

You can verify the status of all Webhook Event Actions on the JMS Queues screen of the System Monitor screen.

To monitor Webhook events

1. On the Oracle Financial Services Lending and Leasing home screen, click Dashboard > Dashboard > System Monitor > JMS Queues.
The Messages tab displays the **Status** for all outbound Webhook events processed to third-party applications and their request in **Response Message Details** section.

For more details, refer to Dashboard > System Monitor section in any of the User Guides.

3

Administration User

In the **Administration > User**, you can record setup data that define your organization structure and its users. Information in this link is more **data** related, whereas the information stored on the System drop-down link functions more like switches that control system behavior.

Navigating to Administration User

On the Oracle Financial Services Lending and Leasing home screen, click **Setup > Setup > Administration > User**.

The User drop-down link records the following data:

- [Organization](#)
- [Companies](#)
- [Access](#)
- [Users](#)
- [Credit Bureau](#)
- [Correspondence](#)
- [Queues](#)
- [Printers](#)
- [Intelligent Segmentation](#)
- [Bank Details](#)
- [Standard Payees](#)
- [Check Details](#)
- [Currencies](#)
- [Zip Codes](#)
- [Payment Hierarchy](#)
- [Number Generation](#)

3.1 Organization

The Organization screen records the operational hierarchy of your business in terms of people. It groups the human resources of your business in three categories: organization, division, and department. The system uses this data to control access of users to applications. (The Companies screen allows you to setup the location of these applications.)

Note

You can have only one active organization, so use the Organization field to define your organization at its highest level.

Divisions are groups within your organization that will have access to the same applications. Larger organizations often define their divisions by region. Smaller organizations may define division as branch offices or even departments, and might only have one division defined.

Departments are smaller units within a division. They expand on who is in the corresponding Division field. The system uses this sub screen, for example, when setting up the Services screen on the Utility form. At least one department must be defined for each division.

Figure 3-1 Organization Flowchart 1

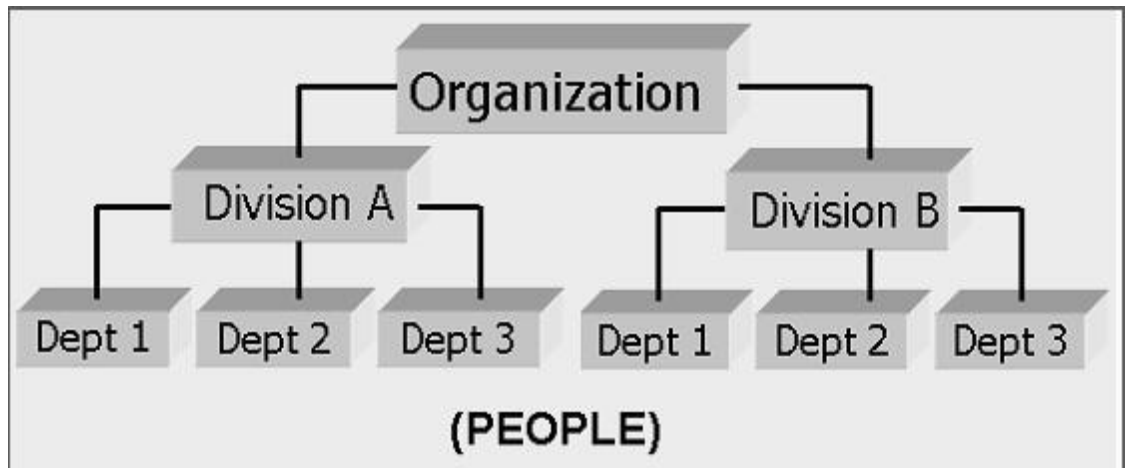

As an example of an organization setup, Oracle Corp. might be defined as:

Organization: O-0001Oracle Corp.ORA

Division: OD-001Central RegionC01

Department: ODD-01OriginationORG

Department: ODD-02FundingFUN

Department: ODD-03ServicingSER

Division: OD-002Eastern RegionE01

Department: ODD-11ServicingSER

Department: ODD-12CollectionCOL

Figure 3-2 Organization Flowchart 2

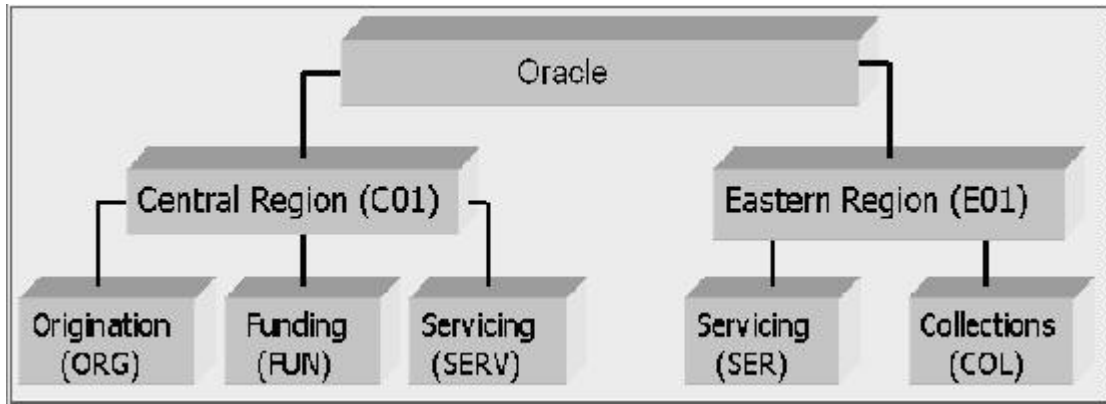
**Note**

The Short Name field on the Organization screen allows you to create the ID that Oracle Financial Services Lending and Leasing will use when referring to the organization, division, and department throughout the system.

To setup the Organization screen

1. Click **Setup > Setup > Administration > User > Organization**.
2. In the **Organization Definition** section, there can be only one active entry, so use this screen to define your organization at its highest level. Perform any of the [Basic Operations](#) mentioned in Navigation chapter.

Figure 3-3 Organization Definition

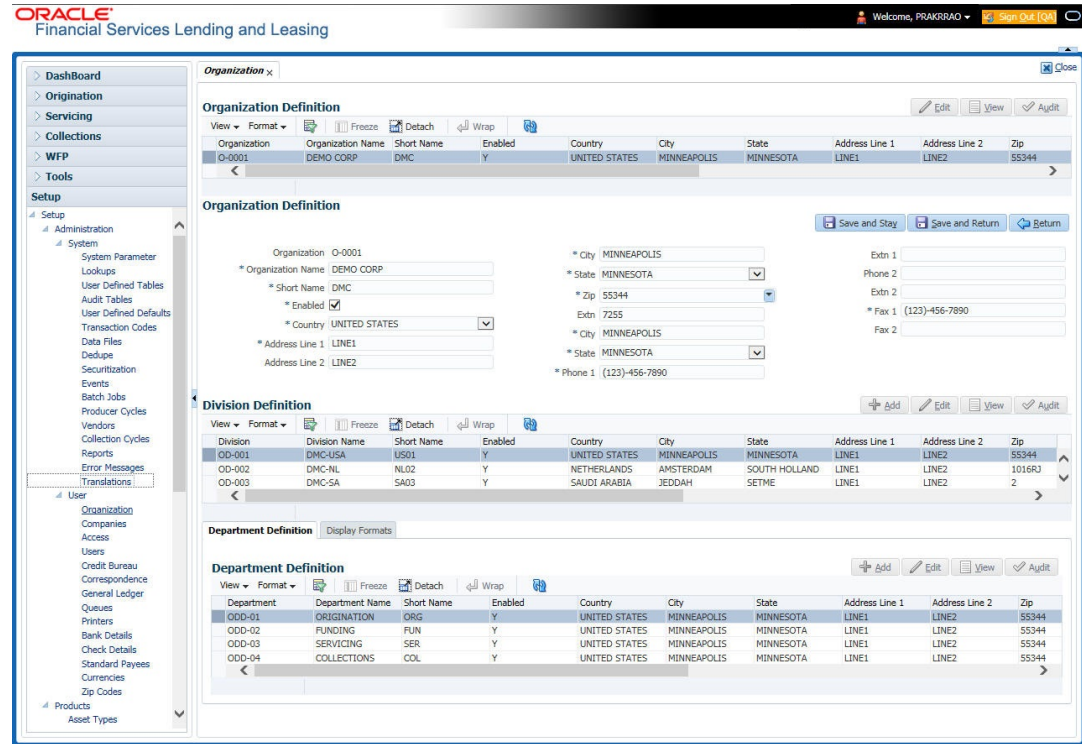

A brief description of the fields is given below:

Table 3-1 Organization Definition

Field	Do this
Organization	Specify the organization ID (the ID is the unique identifier used internally by Oracle Financial Services Lending and Leasing to represent your organization). Note: Do not edit this field.
Organization Name	Specify the organization name.
Short Name	Specify the short name for the organization. Note: This ID represents this organization throughout the system.
Enabled	Check this box to enable the organization. Note: Only one enabled organization is currently allowed by Oracle Financial Services Lending and Leasing.
Country	Select the country where the organization is located from the drop-down list.
City	Specify the city where the organization is located.
State	Select the state where the organization is located from the drop-down list.
Address Line 1	Specify the address line 1 for the organization.
Address Line 2	Specify the address line 2 for the organization.

Table 3-1 (Cont.) Organization Definition

Field	Do this
Zip	Select the zip code of the location where the organization is located from the drop-down list.
Extn	Specify the extension of the selected zip code.
Phone 1	Specify the primary phone number for the organization.
Extn 1	Specify the phone extension for the primary phone number.
Phone 2	Specify the alternate phone number for the organization.
Extn 2	Specify the phone extension for the alternate phone number, if specified.
Fax 1	Specify the primary fax number for the organization.
Fax 2	Specify the alternate fax number for the organization.

3. Perform any of the [Basic Actions](#) mentioned in Navigation chapter.
4. In the **Division Definition** section, you can setup the information for the groups within your organization that will have access to the same applications and accounts. Perform any of the [Basic Operations](#) mentioned in Navigation chapter.
A brief description of the fields is given below:

Table 3-2 Division Definition

Field	Do this
Division	Specify the division ID. The ID is the unique identifier used internally by the system to represent the division within the organization. Note: Once specified, do not edit this field.
Division Name	Specify the division name.
Short Name	Specify the short name for the division. Note: This ID represents this division throughout the system (required).
Enabled	Check this box to enable the division.
Country	Select the country where the division is located from the dropdown list.
City	Specify the city where the division is located.
State	Select the state where the division is located from the drop-down list.
Address Line 1	Specify the address line 1 for the division.
Address Line 2 (unlabeled)	Specify the address line 2 for the division.
Zip	Select the zip code of the location where the division is located from the drop-down list.
Extn	Specify the extension of the selected zip code.
Phone 1	Specify the primary phone number for the division.
Extn 1	Specify the extension for the primary phone number.

Table 3-2 (Cont.) Division Definition

Field	Do this
Phone 2	Specify the alternate phone number for the division.
Extn 2	Specify the extension for the alternate phone number.
Fax 1	Specify the primary fax number for the division.
Fax 2	Specify the alternate fax number for the division.

5. Perform any of the [Basic Actions](#) mentioned in Navigation chapter.
6. Click **Setup > Setup > Administration > User > Organization > Department Definition**.
7. On the **Department Definition** section, perform any of the [Basic Operations](#) mentioned in Navigation chapter.

A brief description of the fields is given below:

Table 3-3 Department Definition

Field	Do this
Department	Specify the department ID. Note: The ID is the unique identifier used internally by the system to represent the department within the division.
Department Name	Specify the department name.
Short Name	Specify the short name for the department. Note: This is the ID that appears throughout the system to represent this department.
Enabled	Check this box to enable the department.
Country	Select the country where the department is located from the drop-down list.
City	Specify the city where the department is located.
State	Select the state where the department is located from the dropdown list.
Address Line 1	Specify the address line 1 for the department.
Address Line 2	Specify the address line 2 for the department.
Zip	Select the zip code where the department is located from the drop-down list.
Extn	Specify the zip extension where the department is located.
Phone 1	Specify the primary phone number for the department.
Extn 1	Specify the phone extension for the primary phone number.
Phone 2	Specify the alternate phone number for the department.
Extn 2	Specify the phone extension for the alternate phone number.
Fax 1	Specify the primary fax number for the department.
Fax 2	Specify the alternate fax number for the department.

8. Perform any of the [Basic Actions](#) mentioned in Navigation chapter.
9. In the **Display Formats** section, you can setup various display formats such as Date Format, Time Format, National ID Format and Time Zone. Click **Setup > Setup > Administration > User > Organization > Display Formats**.

Note

During the Date Format setup, note that this is a one-time setup before starting to use the product. These date-format changes will result in data issues, so changing is not recommended.

10. On the **Display Format** section, perform any of the [Basic Operations](#) mentioned in Navigation chapter.
A brief description of the fields is given below:

Table 3-4 Display Format

Field	Do this
Format Type	Select the type of format from the drop-down list.
Format Sub Type	Select the sub type of the format from the drop-down list. The format sub type will be displayed based on the format type selected.
Format	Specify or select the format based on the format type and format sub type selected. For Date and Time Zone format, select the required option from the drop-down list.
Format Mask	Specify the format mask.
Format Filler	Specify the format filler.
Special Data	Specify the special data, if any.
Enabled	Check this box to enable the display format.

Note

If Format Type = Date Format, system does not limit the date format as MM/DD/YYYY but supports different date formats which are dependent on 'Flex Table' attributes maintained in Date Format Sub Type lookup code `FORMAT_SUB_TYPE_CD`.

11. Perform any of the [Basic Actions](#) mentioned in Navigation chapter.

3.2 Companies

The Companies screen records the hierarchical structure of your portfolio companies and their branches. Just as Oracle Financial Services Lending and Leasing uses the Organization screen to determine the location of people, it uses the information on the Companies screen to determine the location of applications. In completing the Companies screen, there can be more than one company, and each company can have more than one branch.

Accounting is performed at the company level. applications can be sorted down to the branch level. For this reason, branches are set up to reflect different business practices. You would set up different branches if, for example:

- The General Ledger (GL) differs between branches
- The branches work with different accounts
- There is a difference between branches in terms of the tasks they perform (origination, servicing, collections, and so on).

Figure 3-4 Company Flowchart 1

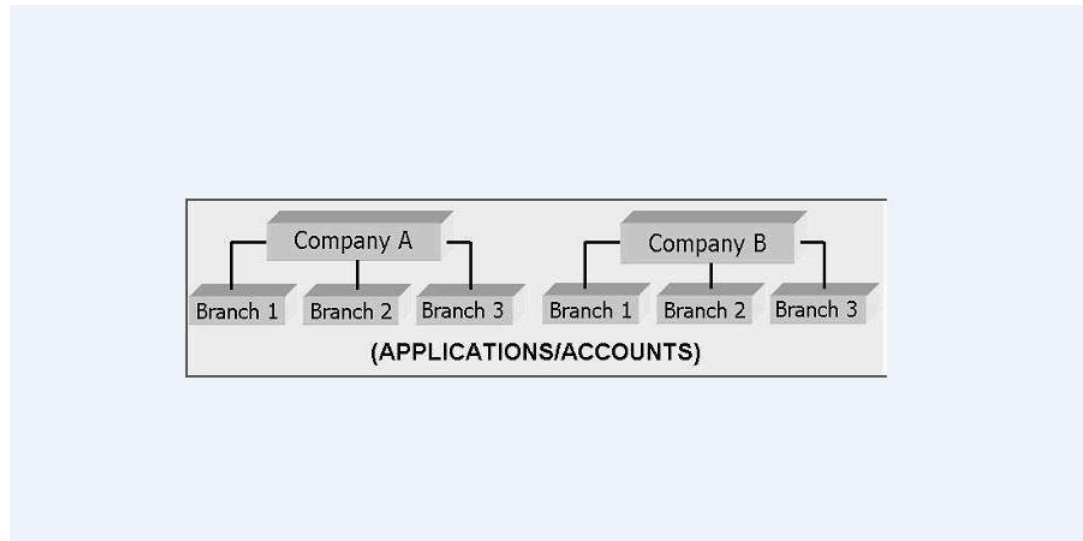

As an example of the companies setup, Oracle Corp. might have the following companies and branches defined as:

Company: C-0001TrustOne Financial CorpTOFC

Branch: CB-01TOFC - HeadquartersHQ

Branch: CB-02Kennedy Plaza KP

Company: C-0002Credtyme Credit CorpCCC

Branch: CB-11CCC - HeadquartersHQ

Branch: CB-12CCC - MissoulaMT

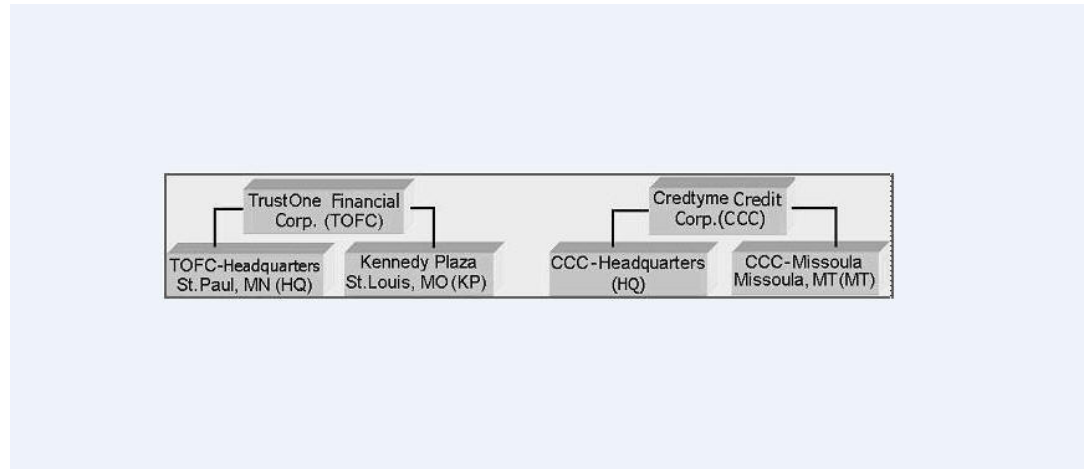
Figure 3-5 Company Flowchart 2**Note**

- The system does not limit the number of companies or associated branches with the company you can enter.
- The Short Name field on the Companies screen allows you to create the ID that the system will use while referring to the company and branch.

KEY CONCEPT: Note the difference between the Company screen and the Organization screen:

- On the **Organization** screen, Oracle Financial Services Lending and Leasing users belong to an organization and division.
- On the **Companies** screen, credit applications and accounts belong to a company and branch.

As you can see in the following Access screen section, the information on the Organization and Companies screens define the operational hierarchy of your companies in terms of which Oracle Financial Services Lending and Leasing users will have access to which applications .

To setup the Companies

1. Click **Setup > Setup > Administration > User > Companies**. The **Companies** screen defines entities within your organization that originate and/or service Line of Credit.
2. In the **Company Definition** section, perform any of the [Basic Operations](#) mentioned in Navigation chapter.

Figure 3-6 Company Definition

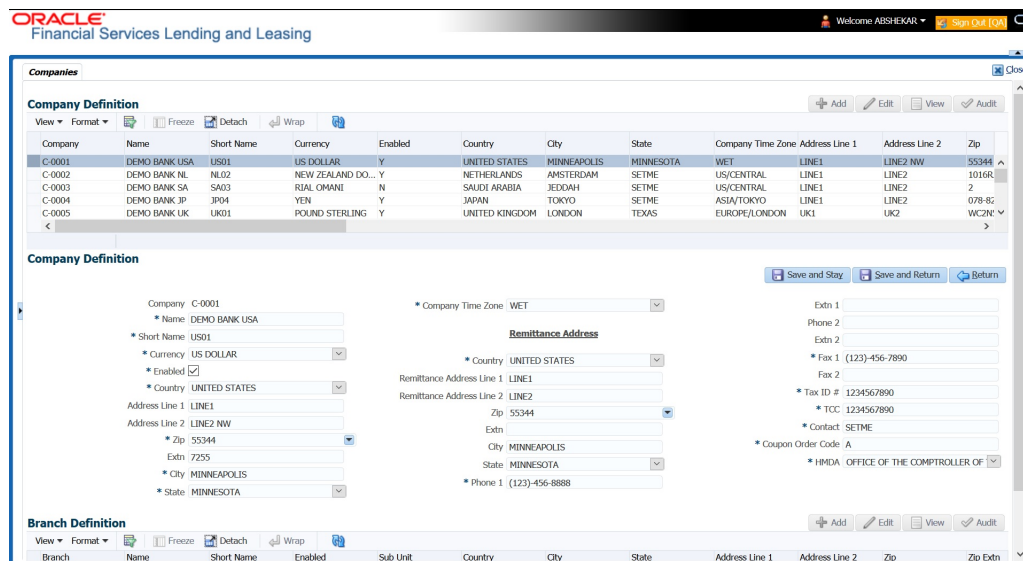

A brief description of the fields is given below:

Table 3-5 Company Definition

Field	Do this
Company	Specify the portfolio company ID. (This ID is the unique identifier used internally by the system to represent the company).
Name	Specify the name of the portfolio company (required).
Short Name	Specify the short name for the portfolio company (ID displayed to represent the company).
Currency	Select the currency of the portfolio company from the drop-down list. The system displays the default value as US DOLLAR .
Enabled	Check this box to enable the portfolio company.
Country	Select the country where the portfolio company is located from the drop-down list. The system displays the default value as UNITED STATES .
Address Line 1	Specify the address line 1 for the portfolio company.
Address Line 2	Specify the address line 2 for the portfolio company.
Zip	Select the zip code of the location where the portfolio company is located from the drop-down list.
Extn	Specify the extension of the zip code where the portfolio company is located.
City	Specify the city where the portfolio company is located.

Table 3-5 (Cont.) Company Definition

Field	Do this
State	Select the state where the portfolio company is located from the drop-down list.
Company Time Zone	Select the time zone in which the company operates using the drop down list. This time zone is considered if system is setup to process GL at Company level. For more information, refer to Appendix - Configuration at Company Level chapter.
Remittance Address section	
Country	Select the remittance address country from the drop-down list. The system displays the default value as UNITED STATES .
Remittance Address 1	Specify the remittance address line 1, if it is different from the company address. This address is included as the remittance address on statements.
Remittance Address 2	Specify the remittance address line 2.
Zip	Select the zip code of the remittance address line 1 from the drop down list.
Extn	Specify the extension of the remittance address zip code.
City	Specify the remittance address city.
State	Select the remittance address state from the drop-down list.
Phone 1	Specify the primary phone number for the portfolio company.
Extn 1	Specify the phone extension for the primary phone number.
Phone 2	Specify the alternate phone number for the portfolio company.
Extn 2	Specify the phone extension for the alternate phone number.
Fax 1	Specify the primary fax number for the portfolio company.
Fax 2	Specify the alternate fax number for the portfolio company.
Tax ID #	Specify the tax identification number for the portfolio company.
TCC	Specify the transmitter control code for the portfolio company (1098 Electronic Filing).
Contact	Specify the contact information about the portfolio company.
Coupon Order Code	If you are using coupons, Specify the coupon order code to be used by a third party printing the coupons for billing statements.
HMDA	Select the HMDA agency (Home Mortgage Disclosure Act reporting agency for the company).

3. Perform any of the [Basic Actions](#) mentioned in Navigation chapter.

4. On the **Branch Definition** section, perform any of the [Basic Operations](#) mentioned in Navigation chapter.
A brief description of the fields is given below:

Table 3-6 Branch Definition

Field	Do this
Branch	Specify the portfolio branch ID. (This ID is the unique identifier used internally by the system to represent the branch within your company).
Name	Specify the name of the portfolio branch (required).
Short Name	Specify the short name for the portfolio branch (ID displayed to represent the branch) (required).
Enabled	Check this box to enable the portfolio branch.
Sub Unit	Select the Sub Unit from the drop-down list. Sub Unit refers the entity which is the source of funds for the credit application/Account. System associates the selected sub unit with the particular company/ branch combination and displays by default when the same is selected during an application/Account creation.
Country	Select the country from the drop-down list. The system displays the default value as UNITED STATES .
City	Specify the city where the portfolio branch is located.
State	Select the state from the drop-down list.
Address Line 1	Specify the address line 1 for the portfolio branch.
Address Line 2	Specify the address line 2 for the portfolio branch.
Zip	Select the zip code of the location where the portfolio branch is located.
Zip Extn	Specify the extension of the zip code, where the portfolio branch is located.
Phone 1	Specify the primary phone number for the portfolio branch.
Extn 1	Specify the phone extension for the primary phone number.
Phone 2	Specify the alternate phone number for the portfolio branch.
Extn 2	Specify the phone extension for the alternate phone number.
Fax 1	Specify the primary fax number for the portfolio branch.
Fax 2	Specify the alternate fax number for the portfolio branch.

5. Perform any of the [Basic Actions](#) mentioned in Navigation chapter.

3.3 Access

Using the organizations, divisions, companies, and branches created on the Organization and Companies screens, you can control the access privileges of applications . On the Access screen, you define which organization/division (users) can gain access to which company/branch (applications) locations.

Normally, for each division within an organization, you would define a record with Company value of ALL and a Branch value of ALL, then select the Allowed box. You then define other records for the same Organization and Division for other Company and Branch combinations with the Allowed box cleared to restrict access.

Figure 3-7 Access Flowchart

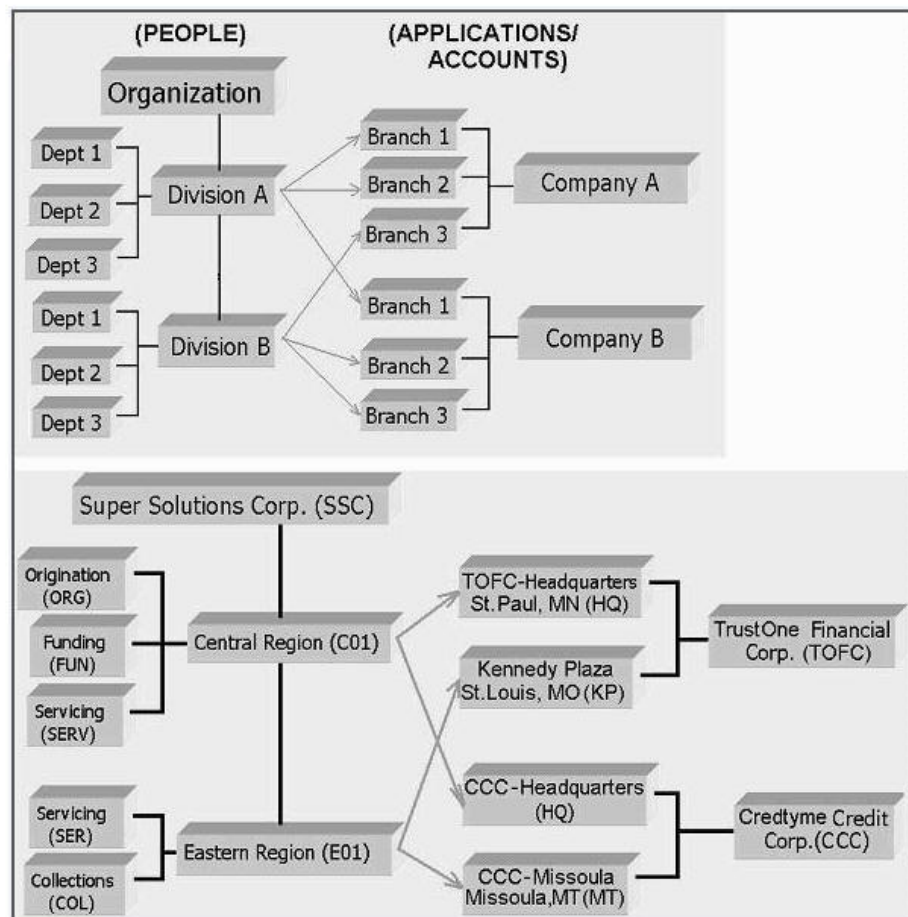

To setup the Access

1. Click **Setup > Setup > Administration > User > Access**. The system displays the Access screen.

2. In this screen, you can control the access privileges of the user for the following categories:
 - [Data](#)
 - [Screen](#)
 - [Reports](#)
 - [Correspondence](#)
 - [Webservice](#)

3.3.1 Data

The Data screen allows you to restrict access to different data.

To setup the Data

1. Click **Setup > Setup > Administration > User > Access > Data**.
2. In the **Access Grid** section, perform any of the [Basic Operations](#) mentioned in Navigation chapter.

Figure 3-8 Access Grid

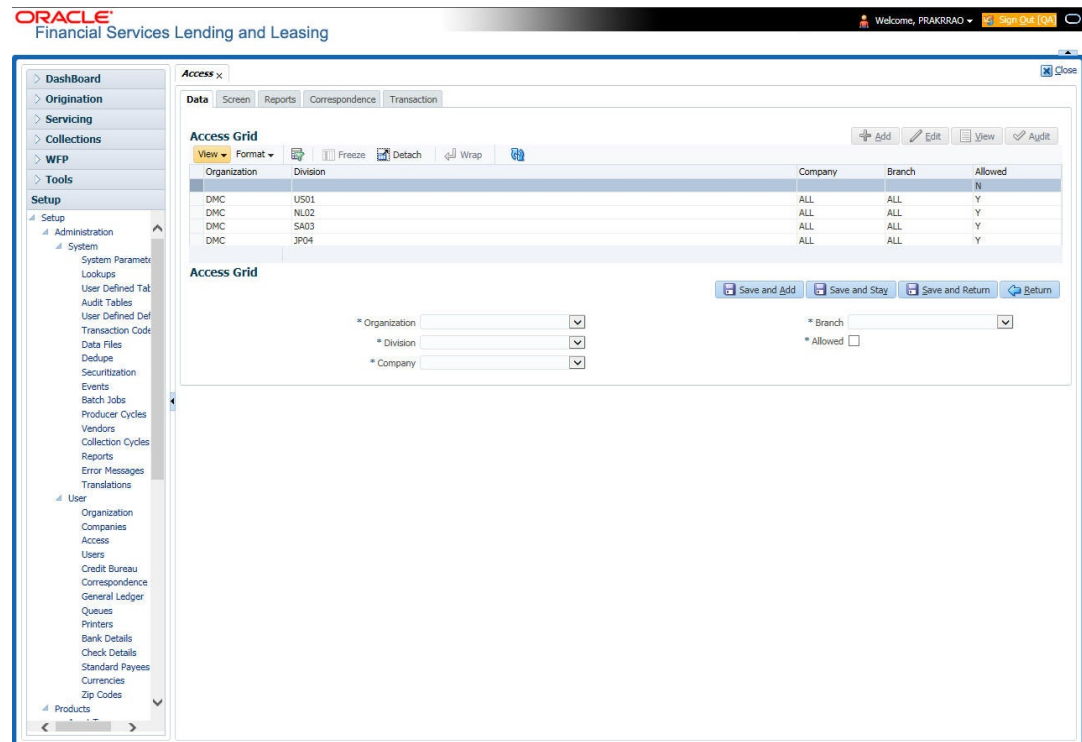

A brief description of the fields is given below:

Table 3-7 Access Grid

Field	Do this
Organization	Select the organization for which you are defining access privileges from the drop-down list.
Division	Select the division within the organization for which you are defining Access privileges from the drop-down list.
Company	Select the portfolio company to which you are defining access privileges for the organization and division specified from the drop-down list.
Branch	Select the portfolio branch of the company to which you are defining access privileges for the organization and division specified from the drop-down list.
Allowed	Check this box to provide access to the data pertaining to the company and branch, for the organization and division specified.

3. Perform any of the [Basic Actions](#) mentioned in Navigation chapter.

3.3.2 Screen

In the screen, you can control the access to the following:

1. Menu – Control access at the application menu level. For example, for **Setup** menu you can provide access only to an Administrator.
2. Screens – Control access to the screens available in the application.
3. Buttons – Control access based on the stage.
For example, Add and Edit buttons can be disabled once an application is funded. If you want to restrict updating the Applicant details, then edit button has to be disabled for the stage.
4. Fields - Control access to base and user defined fields.
The screen allows you to restrict access to different screens and fields using the following tabs:
 - [Security Access Definition](#)
 - [Field Access Definition](#)
 - [Security User Access Definition Details](#)

3.3.2.1 Security Access Definition

To set the Screen Security

1. Click **Setup > Setup > Administration > User > Access > Screen**.
2. In the **Security Super Group** section, you can view the details of the super group you want to work with.

Figure 3-9 Security Super Group

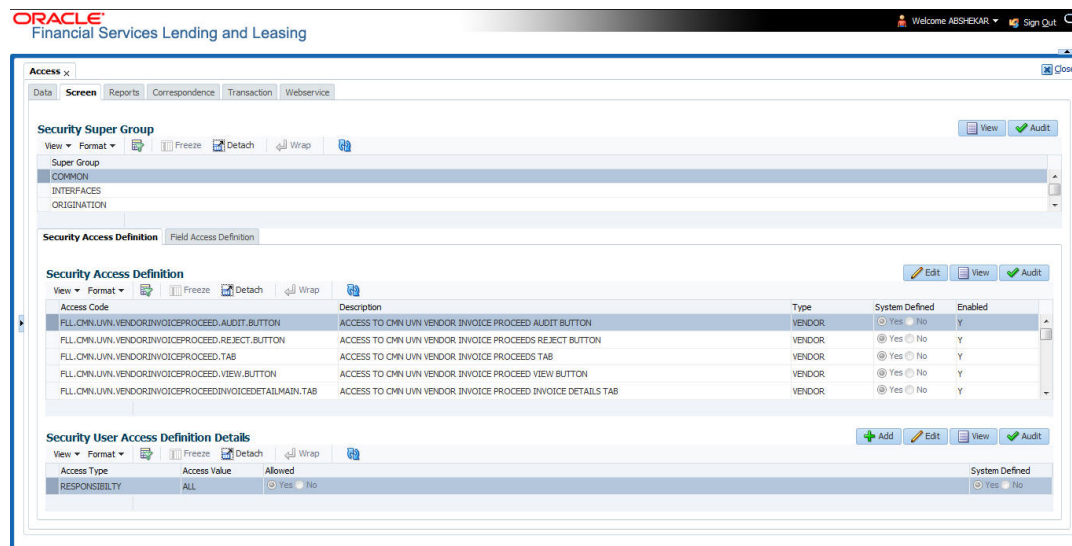

3. In the **Security Access Definition** section, perform any of the [Basic Operations](#) mentioned in Navigation chapter.

Note

You can not add a new record.

A brief description of the fields is given below:

Table 3-8 Security Access Definition

Field	Do this
Access Code	The system displays the selected access code.
Description	Modify the description of the access code.
Type	The system displays the type of security access definition.
System Defined	If Yes is selected, the security access definition entry is system defined. If No is selected, the security access definition entry is manually defined.
Enabled	Check this box to enable the security access definition entry is enabled.

4. Perform any of the [Basic Actions](#) mentioned in Navigation chapter.
5. In the **Security User Access Details** section, perform any of the [Basic Operations](#) mentioned in Navigation chapter.

A brief description of the fields is given below:

Table 3-9 Security User Access Details

Field	Do this
Access Type	Select the access type of the user who will have access to this screen from the drop-down list.
Active Value	Select the active value of the user who will have access to this screen from the drop-down list.
Allowed	Select Yes to allow access to this screen or No to deny access to this screen.
System Defined	Select Yes , if the screen user access definition entry is system defined. Select No , if the screen user access definition entry is manually defined.

6. Perform any of the [Basic Actions](#) mentioned in Navigation chapter.

3.3.2.2 Field Access Definition

The Field Access Definition tab facilitates for field customization in the User Interface (UI) screen. In this tab, you can do the following:

- Enable User Defined Fields (UDFs) to be displayed in respective UI which are provided as part of product installation/upgrade
- Allow or restrict user access to base non-mandatory fields and UDFs maintained in the system
- Regroup base fields to another section in UI

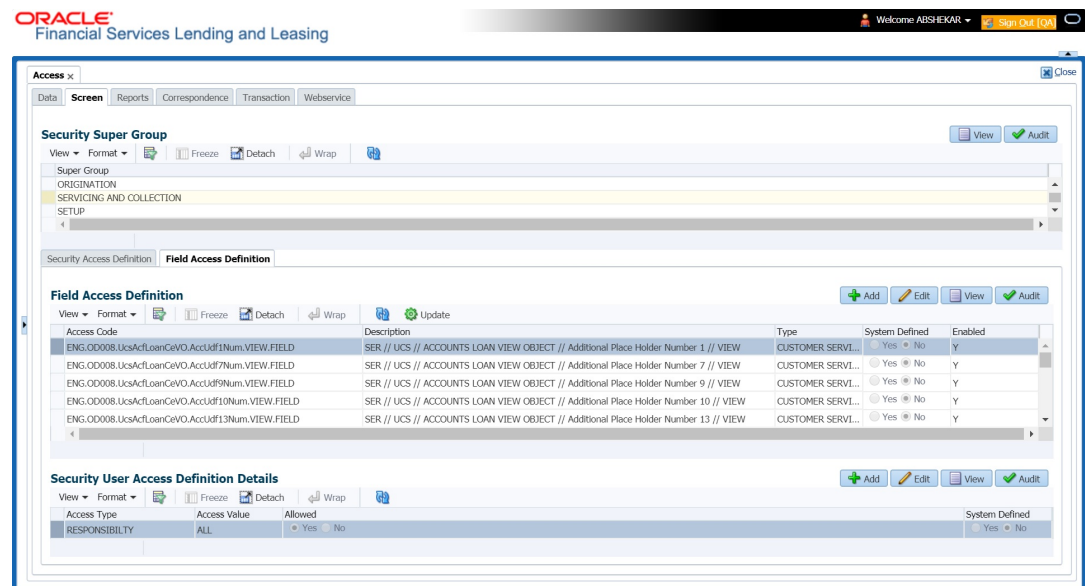
Figure 3-10 AccessGrid_field

Note the following:

- The Field Access Definition tab displays User defined Fields maintained in the system for which you can specifically define access permissions based on user responsibility.

- The base mandatory fields are loaded automatically and Access Responsibility is set to ALL by default during product installation/upgrade. The same cannot be modified and hence are not displayed in this tab.
- Field access and customizations are to be performed at your sole discretion and OFSLL is not responsible for any impact/damage/mismatch in the data being represented or resulting out of this change.
- Field labels can further be customized in Administration > System > [Label Configuration](#) screen.

Before defining field access, refer to the table below which indicates the possible combinations of a particular field being displayed and allowed to edit in UI.

Table 3-10 Field Definition

View Type	Access	Result
VIEW	NO	NON VIEWABLE
VIEW	YES	VIEWABLE AND EDITABLE
LOCK	NO	READONLY
LOCK	YES	VIEWABLE AND EDITABLE

To add/enable new User Defined Fields

1. In the **Field Access Definition** section, click **Add** and populate the following details:

Table 3-11 Field Access Definition

Field	Do this
Language	Select the language of the user(s) who will have access to this field from the drop-down list.
Division	Select the division or group within the organization to which the user belongs from the drop-down list.
Object Name	Select the Object Name from the drop-down list. You can use the search option to query based on specific name. The list is populated based on the combination of Language and Division selected above.
Field Name	Select the field to be updated from the drop-down list. The list is displayed based on the object selected.
Access Type	Select the access type as one of the following from the drop-down list. View - to display and make the field editable. Lock - to only display the field. Note: Option defined here takes precedence with the display (Y/N) option selected in Setup > Administration > System > Label Configuration tab.
System Defined	Select Yes , if the field access definition is system defined. Select No , if the field access definition is manually defined.

Table 3-11 (Cont.) Field Access Definition

Field	Do this
Enabled	Check this box to enable the field access definition.

2. Perform any of the [Basic Actions](#) mentioned in Navigation chapter.
3. Click **Update**. System refreshes the cache and automatically updates the Field Access Details from database to display in header section. After updating the required changes in screen, you need to logout and re-login for changes to be effective. This is basically to refresh session cache and update Field Access information from database server. Though, there is **Update** option, clicking on the same only refreshes the cache and reloads the record.

To enable/disable Base fields

1. In the **Field Access Definition** section, click **Edit** and populate the following details:

Table 3-12 Field Access Definition

Field	Do this
Access Code	View the access code defined for the field.
Description	View the access code description. You can modify the details if required.
Type	By default, system displays the name of the group inside which the field is displayed in UI. To move the field to a different group, select the required type from the drop-down list.
System Defined	Select Yes , if the screen field access definition is system defined. Select No , if the screen field access definition is manually defined.
Enabled	Check this box to enable the field access definition.

3.3.2.3 Security User Access Definition Details

The **Security User Access Definition Details** sub tab is available only for base - non mandatory fields and user defined fields. In the **Security User Access Definition Details** sub tab you can defined field access and set restrictions to specific user responsibility.

1. In the **Security User Access Definition Details** section, perform any of the [Basic Operations](#) mentioned in Navigation chapter. A brief description of the fields is given below:

Table 3-13 Security User Access Definition Details

Field	Do this
Access Type	Select RESPONSIBILITY as the access type from the drop-down list since access to field is based on responsibility by default. This field is disabled during edit.
Active Value	Select the user role who needs to have access to this field from the drop-down list.

Table 3-13 (Cont.) Security User Access Definition Details

Field	Do this
Allowed	Select Yes to allow access to this field or No to deny access to this field.
System Defined	Select Yes , if the field user access definition is system defined. Select No , if the field user access definition is manually defined.

2. Perform any of the [Basic Actions](#) mentioned in Navigation chapter.

3.3.3 Reports

In the Reports screen you can control access to generate certain reports.

To set up Reports

1. Click **Setup > Setup > Administration > User > Access > Reports**.
2. In the **Reports** section, you can view the following information:

Figure 3-11 Reports

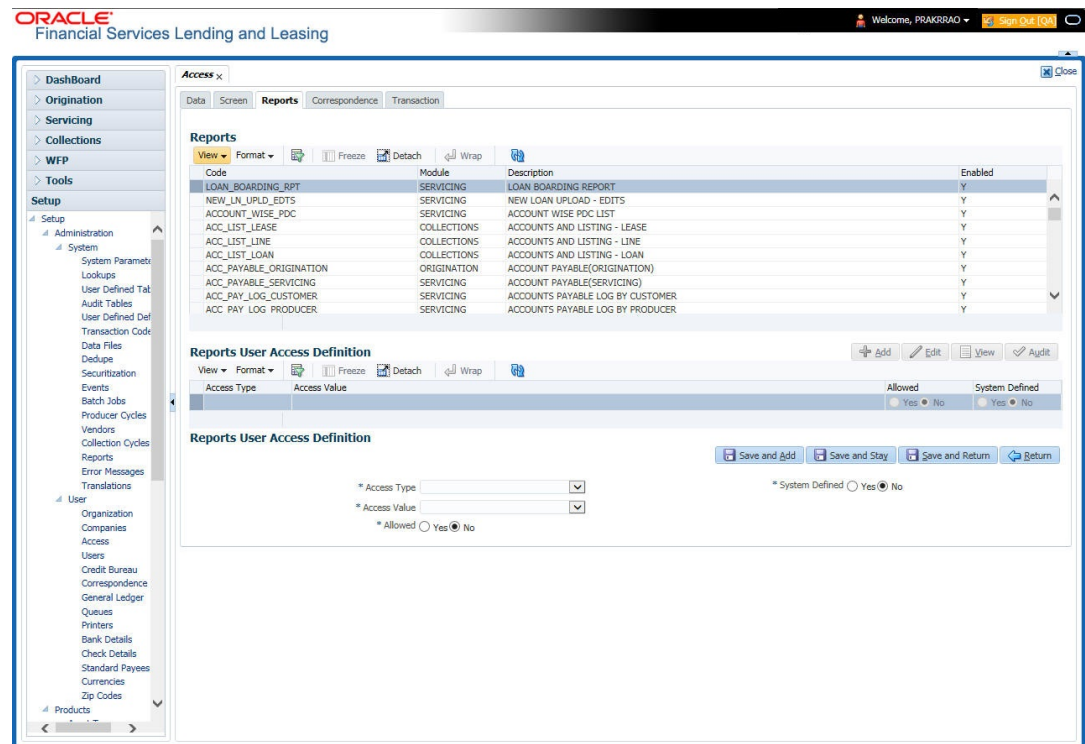

A brief description of the fields is given below:

Table 3-14 Reports

Field	View this
Code	Displays the code of the report.
Module	Displays the code of the report from the drop-down list.
Description	Displays the description of the report.
Enabled	Displays whether the report definition is enabled or not.

- In the **Reports User Access Definition** section, you can set the access rights for the report selected in the Reports section. Perform any of the [Basic Operations](#) mentioned in Navigation chapter.
A brief description of the fields is given below:

Table 3-15 Reports User Access Definition

Field	Do this
Access Type	Select the access grid function type from the drop-down list.
Access Value	Select the access function grid value from the drop-down list.
Allowed	Select Yes to allow access or No to restrict access to the entry based on the access type and value.
System Defined Yes/No	Select Yes , if the report user access definition entry is system defined. Select No , If the report user access definition entry is manually defined.

- Perform any of the [Basic Actions](#) mentioned in Navigation chapter.

3.3.4 Correspondence

The Correspondence screen allows you to restrict access to different correspondence commands on the Letters menu, thus restricting your ability to generate certain correspondence.

If you do not have the responsibility to create a type of correspondence, the corresponding command on the Letters menu is unavailable (dimmed).

To setup the Correspondence

- Click **Setup > Setup > Administration > User > Access > Correspondence**.
- In the **Correspondence Codes** section, perform any of the [Basic Operations](#) mentioned in Navigation chapter.

Figure 3-12 Correspondence Codes

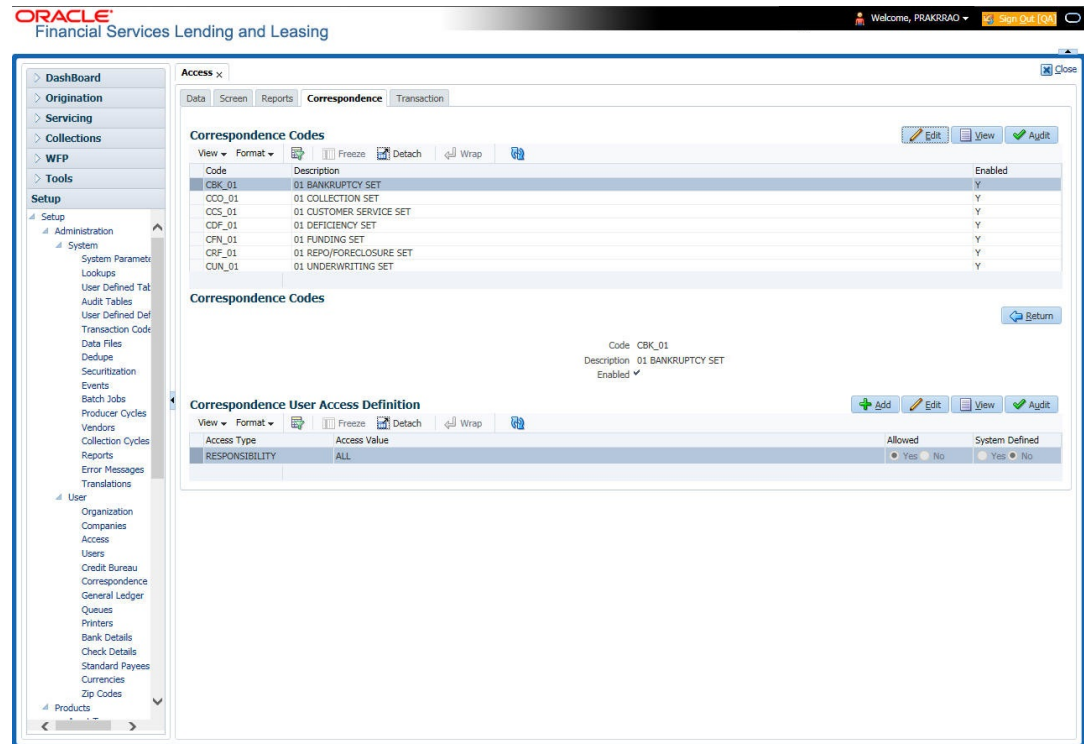

A brief description of the fields is given below:

Table 3-16 Correspondence Codes

Field	Do this
Code	The system displays the correspondence code name you want to work with.
Description	The system displays the description for the correspondence code (display only).
Enabled	Check this box to enable the selected correspondence code entry.

- In the **Correspondence User Access Definition** section, perform any of the [Basic Operations](#) mentioned in Navigation chapter. A brief description of the fields is given below:

Table 3-17 Correspondence User Access Definition

Field	Do this
Access Type	Select the access grid function type from the drop-down list.
Access Value	Select the access function grid value from the drop-down list.
Allowed	Select Yes to allow access or No to restrict access to the entry based on the access type and value.

Table 3-17 (Cont.) Correspondence User Access Definition

Field	Do this
System Defined Yes/No	Select Yes , if the correspondence user access definition entry is system defined. Select No , if the correspondence user access definition entry is manually defined.

4. Perform any of the [Basic Actions](#) mentioned in Navigation chapter.

3.3.5 Webservice

The Webservice screen in Access setup allows you to configure access to the available RESTful webservices in the system. The associated seed data for all the RESTful webservices are loaded during product installation and process of installing the same is detailed in the Installation guide.

As an administrator/superuser, you can Enable/Disable Web Service access to users based on their responsibility and ensure that only authorized user have access to specific type of data in the system. Following list indicates some of the available RESTful webservices in the system and the complete list is made available in swagger JSON file shared in OTN library.

- Generic Post Transaction Service
- Call Activity Service
- Scheduler Service
- Account Search Service
- Account Boarding Service
- Payment Posting Service
- Account Detail Service
- Calculator Service
- Application Search Service
- Get Scenario Analysis Service
- Post Scenario Analysis Service
- Lookup Service
- Dialer Integration Service
- Application GET Service
- Application Entry service
- Application Update Service
- Application Status Change
- Application Checklist
- Application ACH GET Service
- Application ACH POST Service
- Application Comment GET Service
- Application Comment POST Service
- Application Document GET Service

- Application Document POST Service
- Account Comment GET Service
- Account Comment POST Service
- Account Document GET Service
- Account Document POST Service
- Process File Upload Service
- Process File Download Service
- Process File List Service
- Product Service
- Asset Service
- Asset Sub-Type Service
- Scheduler Force ReSubmit
- Remarketing GET Service
- Remarketing POST Service
- Invoice GET Service
- Invoice POST Service

To setup the Webservice access

1. Click **Setup > Setup > Administration > User > Access > Webservice**. The screen consists of the following tabs:
 - Security Super Group
 - Security Access Definition
 - Security User Access Definition Details
 - Security Access Definition Details (This sub tab is available only for **SERVICING AND COLLECTION** Super Group).

Figure 3-13 Webservice

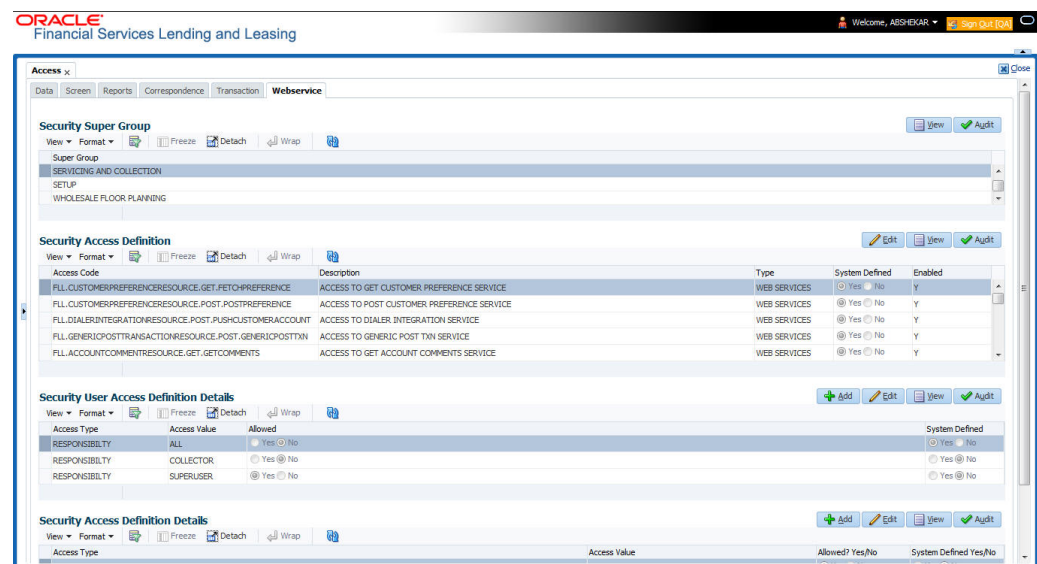

2. The **Security Super Group** section, contains the following super group categories for selection:
 - COMMON
 - INTERFACES
 - ORIGINATION
 - SERVICING and COLLECTIONS
 - SETUP
 - WHOLESALE FLOOR PLANNING
3. Select the required Super Group and the associated data in sub tabs are categorized accordingly.
4. In the **Security Access Definition** section, you can view the following field details and edit only the **Description** and **Enabled** status of selected Security Access Definition.

Table 3-18 Security Access Definition

Field	Do this
Access Code	The system displays the webservice access code.
Description	The system displays the description of the associated webservice access code and can be edited for required changes.
Type	The system displays the type of security access definition.
System Defined	If selected as Yes , the security access definition entry is system defined. If selected as No , the security access definition entry is manually defined.
Enabled	Check this box to enable the selected webservice access code.

5. Perform any of the [Basic Actions](#) mentioned in Navigation chapter.
6. In the **Security User Access Details** section, perform any of the [Basic Operations](#) mentioned in Navigation chapter.
A brief description of the fields are given below:

Table 3-19 Security User Access Details

Field	Do this
Access Type	Select Responsibility (default) as the access type from the dropdown list. For this access type to be available in the drop-down list, ensure that the Lookup Type ACCESS_GRID_TYPE_CD is maintained in the system.

Table 3-19 (Cont.) Security User Access Details

Field	Do this
Access Value	<p>This field is Read-only for System Defined Security Access Definitions which are loaded as part of seed data during installation.</p> <p>For non-system defined Security Access Definitions, select the access value which is the user responsibility who needs to have access to this webservice from the drop-down list.</p> <p>For user responsibilities to be populated in the drop-down list, ensure that the Lookup Type RESPONSIBILITY_CD is maintained in the system.</p>
Allowed	Select Yes to allow user access to this webservice or No to deny access. By default, No is selected.
System Defined	<p>Select Yes, if the webservice user access definition entry is system defined.</p> <p>Select No, if the webservice user access definition entry is manually defined.</p>

7. Perform any of the [Basic Actions](#) mentioned in Navigation chapter.

Security Access Definition Details

If you have selected the Security Super Group as **SERVICING and COLLECTIONS**, there is an additional sub section **Security Access Definition Details** enabled. This sub tab facilitates you to further restrict and control access to specific type of data within the accessible RESTful web services. The restriction can be defined based on specific **Account Condition** or **Account Status**.

For example, out of all the account types maintained in the system you can restrict data access to only delinquent account(s) to a particular user responsibility by selecting Access Type as **Account Condition** and Access Value as **Delinquent**.

Controlling web service data access to permitted user(s)

For any user to access web service data, you need to define atleast one positive (allowed) definition defined in **Security Access Definition Details** section. Else, webservice data is not displayed for that particular user even if that user responsibility has permissions to access web service.

OFSLL supports multiple user conditions on an Account and system requires to have atleast one account condition defined as **Allowed** in setup to display the data. In case, even if any one of the account condition is defined as **Not Allowed** in setup, then system does not allow to access the data.

During the following scenarios, data is either displayed/not displayed in Webservice screen:

Table 3-20 Data in Webservice screen

Scenario	Data displayed
No condition is available on the account and also no condition defined in setup	Data is displayed since there is no restriction.
Condition is available on the account but not defined in setup	Data is not displayed since restriction is applied

Table 3-20 (Cont.) Data in Webservice screen

Scenario	Data displayed
Multiple conditions are available on the account and one condition is defined in setup as Allowed	Data is displayed
Multiple conditions are available on the account and one condition is defined in setup as Not Allowed	Data is not displayed

Whenever user with specific responsibility tries to access the restricted data, following type of error messages are displayed:

- For POST/PUT service, system displays error as **Access denied** with HTTP Error Code 401.
- For GET service with single account record, system displays error message as **No data found** with http error code 400.
- For GET service with multiple account records, of which some have access restriction and other don't, then system displays only the unrestricted records and does not display the restricted records. In such a case, error message is not displayed.

Note

When multiple user access definitions are defined in the system, while processing the data access request to a web service OFSLL first validates for any access restrictions on the user responsibility. If not, then validates the same against **ALL** responsibility before displaying the data in Webservice screen.

For example, if data access restriction is defined for ALL and SUPERUSER responsibilities. when logged in with SUPERUSER responsibility, the data restriction of SUPERUSER is applied. In case, if the user logs in with any other responsibility other than SUPERUSER, then restriction defined for **ALL** is applied.

To define Security Access Definition Details

1. Click **Setup > Setup > Administration > User > Access > Webservice** tab.
2. Select the module in Security Super section as **SERVICING and COLLECTIONS**.
3. Select the user responsibility in **Security User Access Definition Details** section.
4. In the **Security Access Definition Details** section, perform any of the [Basic Operations](#) mentioned in Navigation chapter.

A brief description of the fields are given below:

Table 3-21 Security Access Definition Details

Field	Do this
Access Type	Select the access function type (as either ACCOUNT CONDITION OR ACCOUNT STATUS) that is being used to control the user access from the drop-down list.

Table 3-21 (Cont.) Security Access Definition Details

Field	Do this
Access Value	Select the access value from the drop-down list. The list is sorted based on the Access Type selected. Also, based on a lookup associated with the Access Type multiple entries for each access type can be created as long as each has a different access value.
Allowed? Yes/No	Select Yes if the access is allowed and No if the access is not allowed. This indicates whether the selected combination of Access Type and Access Value is allowed to access the data.
System Defined Yes/ No	Select Yes , if you wish to maintain access type as system defined and No , if you do not want to maintain it as system defined. However, system defined entries cannot be modified.

5. Perform any of the [Basic Actions](#) mentioned in Navigation chapter.

3.4 Users

The Users screen allows you to create and set up an user. In the User Definition section, you can assign a user an identification name and password to log on to the system. You can also assign the organization, division, and department where each user is located. Additional fields allow you to record information for contacting the user. You can also define the time frame within which a user has access to the system to ensure compliance to the company's schedule. This is a very useful feature to prevent logins during scheduled maintenance.

The Responsibility field records the job function of the user and defines the level of access that user has within the system; in particular:

- What menu items does the user have access to?
- What edits can the user perform on the Verification link during origination?

Note

The system's SUPERUSER responsibility grants access to the entire system. Give careful consideration to the number and type of users who receive this responsibility.

To set up the Users screen

1. Click **Setup > Setup > Administration > User > Users**. The system displays the Users screen.
2. In the **User Definition** section, perform any of the [Basic Operations](#) mentioned in Navigation chapter.

Figure 3-14 User Definition

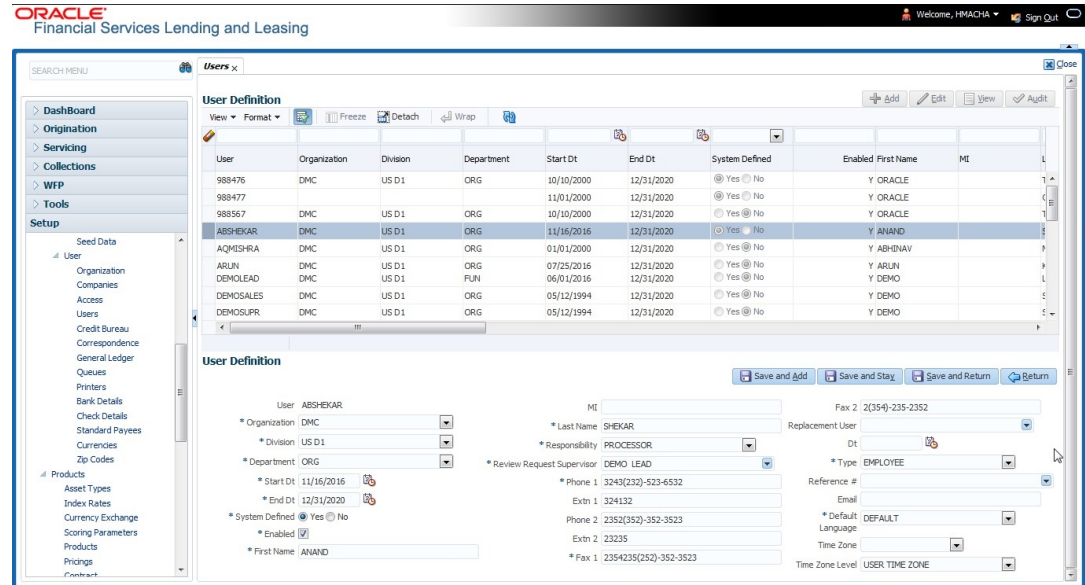

A brief description of the fields is given below:

Table 3-22 User Definition

Field	Do this
User	Specify the user ID. Note: This field is a unique indicator and cannot be updated, edited, or deleted once saved.
Organization	Select the organization to which the user belongs, from the dropdown list.
Division	Select the division to which the user belongs, from the drop-down list.
Department	Select the department to which the user belongs, from the dropdown list.
Start Dt	Specify the start date for the user. You can also select from the adjoining calendar icon.
End Dt	Specify the end date for the user. You can also select from the adjoining calendar icon.
System Defined	Select Yes , if the entry is system defined. System defined entries cannot be modified. Select No , if the entry is not system defined and it can be modified.
Enabled	Check this box to enable the user.
First Name	Specify the first name of the user.
MI	Specify the middle initial of the user.
Last Name	Specify the last name of the user.
Responsibility	Select the responsibility for the user from the drop-down list. Note: The users mapped to the role Responsibility can only view the screens.

Table 3-22 (Cont.) User Definition

Field	Do this
Review Request Supervisor	Select the supervisor responsibility who can also review and respond to review requests from the drop-down list. The list displays the corresponding Review Request Supervisors who are either one or more levels higher from the above selected user Responsibility as maintained in RESPONSIBILITY_CD lookup code.
Phone 1	Specify the user's primary phone number.
Extn 1	Specify the phone extension for the primary phone number.
Phone 2	Specify the user's alternate phone number.
Extn 2	Specify the phone extension for the alternate phone number.
Fax 1	Specify the user's primary fax number.
Fax 2	Specify the user's alternate fax number.
Replacement User	Select the user ID of the replacement user from the drop-down list.
Dt	Specify the date from when the replacement is effective. You can also select from the adjoining calendar icon. Note: These two fields allow you to create a replacement user for the current user. This is particularly useful when a new employee assumes the duties of a former. By completing the Replacement User and Replacement Dt field, the system recognizes the replacement user as the current user on the effective date. For more information, refer the section, Replacement Users .
Type	Select the user type from the drop-down list.
Reference #	Specify the reference number for the user from the drop-down list.
Email	Specify user's email address.
Default language	Select the default language from the drop-down list.
Time Zone	Select the required Time Zone from the drop-down list, The specified time zone would be applicable at company level.
Time Zone Level	Select the time zone level (Organization, Company or User) that would apply by default, when specific time zone is not specified at Company and User level.

3. Perform any of the [Basic Actions](#) mentioned in Navigation chapter.

This section consists of the following topics:

- [Replacement users](#)
- [Application and Oracle Identity Manager Synchronization](#)

3.4.1 Replacement users

By completing the **Replacement User** and **Dt** fields on the Users screen, you can replace an existing user with a new user. The system assigns all responsibilities of the original user to the new user as of the date of the replacement.

The **Replacement User** and **Dt** fields allow you to designate a replacement for the current user in the User ID field. When you complete the **Replacement User** and **Dt** fields, save your entry, and then enable the record, the system replaces the original user. The system changes the **End Dt** field to the date when the original user was replaced (the same date in the Dt field).

The system assigns the queues of the original user to only those replacement users who have the same user responsibilities (or Super User responsibility) as set in the system.

The system updates the following when replacing users:

1. Assigns all applications in the replaced user's underwriting queue with the status NEW to the replacement user's queue.
2. Assigns all applications in the replaced user's funding queue with a status other than FUNDED to the replacement user's queue. The system currently stores the collector name in the back end tables, which are updated with the replacement users ID in the case of the replacement of any user.
3. Also updates the Producer Management screen with the replacement user in the **Underwriter** and **Collector** fields. The system assigns all applications routed to the original user to the replacement user. This also includes any future applications for the replaced user.
4. The system automatically updates the **Collector ID** field in all accounts to the replacement user and routes all accounts assigned to the original user to the replacement user.

Note

The system will not update the replacement user ID for accounts that are closed.

5. On the queue setup of Customer Service screen's Responsibilities sub screen, the record for the original user will be disabled and a new record will be created for the replacement user. If the replacement user already exists in the setup, The system will not create a new record. It updates the user ID and routes all accounts that were assigned to the original user, based on the account condition, to the replacement user.

3.4.2 Application and Oracle Identity Manager Synchronization

Oracle Identity Manager is for user administration. Oracle Financial Services Lending and Leasing has been developed in such a way that it can be implemented with or without Oracle Identity Manager. In case OID has been employed, the user definition is done in OID and then synchronized to the Oracle Financial Services Lending and Leasing Users table using a utility JAR called OID Synchronization JAR. In OID, users are defined across various groups belonging to a realm which is nothing but the directory structure in OID. A user can be configured to belong to multiple groups in a realm. Every time the user tries to login to Oracle Financial Services Lending and Leasing or OBIEE, the system validates the login ID and the password with OID and provides access to those applications.

3.5 Credit Bureau

In the system, an important part of the origination process is pulling a credit report from a credit bureau and scoring that information against a user-defined risk model. These credit reports can be pulled both automatically and manually.

After you enter an application, the system compares its contents against pre-screen criteria. If the application passes a pre-screen edits check, the system advances the status of the application and automatically pulls a credit report.

You can manually request a credit report for an applicant or any other party included on the application, such as co-signers and spouses by selecting the bureau from which you want to pull the report. If more than one report type is defined for the selected bureau, then you can indicate the type of report you want to pull.

The following are few additional Credit Bureau Setup details:

- The credit bureau from which the report is pulled is determined by the applicant's zip code. The credit bureau interface searches the information in the Credit Bureau Zip Matrix tab and matches the applicant's zip code to determine the bureau(s) from which to request a report.
- The number of credit reports automatically pulled per applicant is controlled through the credit request parameter `CRB_MAX_BUREAU_PULL`. If this parameter is set to 1, a credit bureau request will be made for the Bureau1 credit bureau from the zip code matrix. Likewise, if this parameter is set to 2, a credit bureau request will be made for the Bureau1 and the Bureau2 credit bureaus from the zip code matrix.
- The system automatically pulls credit reports for only the primary applicant and the primary applicant's spouse (for joint applications) unless the `CRB_ALL_APL_BUREAU_PULL` credit request parameter is set to Y. However, if the parameter is set to Y, the system pulls credit reports for all of the applicants on the Line of credit, regardless of their relationship to the primary borrower.
- Passwords, default report formats, and other required information from the credit bureaus are set up in the Report Formats screen.
- For identity scan data to flow into Equifax ACRO/ACRO Plus credit reports, the add-on has to be enabled at contract level. Please speak to your representative for enabling the add-on.

Member codes and passwords when switching credit bureau access methods (moving from dial-up to Net Connect). The member codes and passwords are not dependent on the connection method used to access the bureau.

Frame relay access is from the database server to the Experian host though a TCP/IP socket connection. The connection is outbound only and it is to a specific port (699 or 700) on the Experian host.

The credit bureau service will be accessing Experian Net Connect service through HTTP to the ECALS URL supplied by Experian as well as by the HTTPS to the URL returned as a response to the ECALS URL inquiry (the credit request URL). This access is from the database server access.

This section consists of the following topics:

- [Credit Bureau](#)
- [Special Metro II Code reporting](#)

- [Oracle Wallet Manager setup](#)
- [Oracle JVM Security setup](#)
- [Importing a trusted certificate into an Oracle Wallet](#)
- [Importing the Certificates into an Oracle Wallet](#)
- [De-duping Credit Bureau data](#)

3.5.1 Credit Bureau

Navigating to Credit Bureau

On the Oracle Financial Services Lending and Leasing home screen, click **Setup > Setup > Administration > User > Credit Bureau**.

The setup for Credit Bureau spans across the following links:

- [Report Formats](#)
- [Connections](#)
- [Zip Matrix](#)
- [Parameters](#)
- [Score Reasons](#)
- [Reporting](#)

3.5.1.1 Report Formats

The Reports Formats screen captures and tracks the attributes related to the multiple types of reports offered by the credit bureau agencies. When a company enlists the service of a credit bureau, the credit bureau provides a membership code and password. This information needs to be entered on the Reports Formats screen before you can request a credit report. You must define at least one report for each credit bureau from which you want to pull reports.

The information on the Report Formats screen is location-specific. If the business requires different membership codes for each location, be it a company or branch, then individual records must be set up.

The Score Type, Additional Product, and Inquiry Limit fields on the Credit Report Setup section are optional. They may not apply to all credit bureau types and even if they do apply, you may want to leave them blank and rely on a default value set up at the credit bureau.

Note

For more information, refer to the application Installation Guides.

To setup Report Formats

1. Click **Setup > Setup > Administration > User > Credit Bureau > Report Formats**.
2. In the **Credit Bureau** section, perform any of the [Basic Operations](#) mentioned in Navigation chapter.

Figure 3-15 Credit Bureau Report Formats

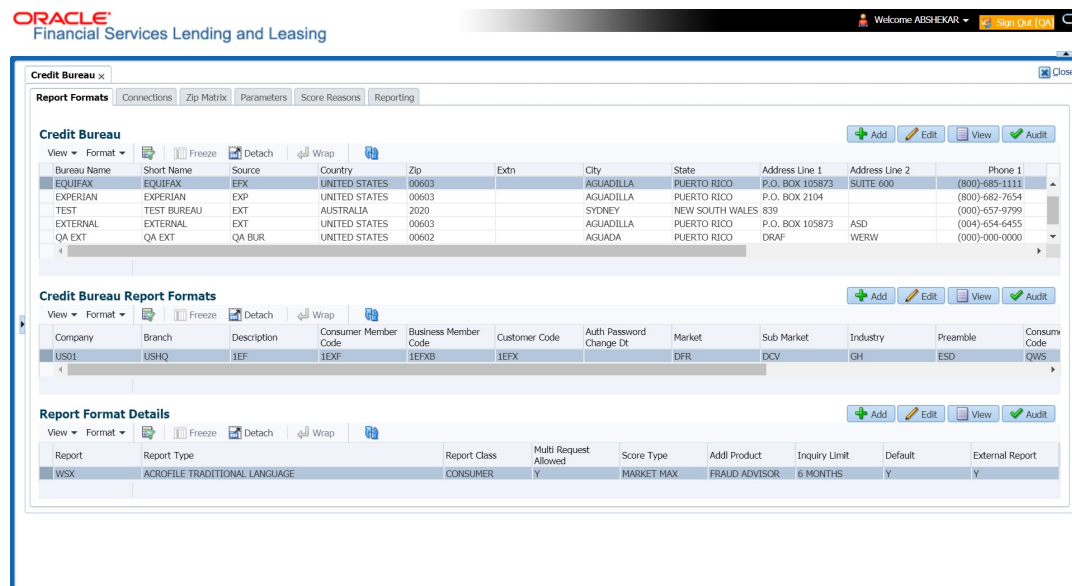

A brief description of the fields is given below:

Table 3-23 Credit Bureau Report Formats

Field	Do this
Bureau Name	Specify the name of the credit bureau company.
Short Name	Specify the abbreviated or short name for the bureau.
Source	Select the credit bureau source from the drop-down list.
Country	Select the country of the credit bureau address from the drop-down list.
City	Specify the city for the credit bureau address.
State	Select the state of the credit bureau address from the drop-down list.
Address Line 1	Specify the address line 1 for the credit bureau.
Address Line 2	Specify the address line 2 for the credit bureau.
Zip	Select the zip code for the credit bureau address from the dropdown list.
Extn	Specify the extension of the zip code for the credit bureau address.
Phone 1	Specify the primary phone number for the credit bureau.
Extn 1	Specify the extension for the primary phone number.
Phone 2	Specify the secondary phone number for the credit bureau.
Extn 2	Specify the extension for the secondary phone number.
Fax 1	Specify the primary fax number for the credit bureau.

Table 3-23 (Cont.) Credit Bureau Report Formats

Field	Do this
Fax 2	Specify the alternative fax number for the credit bureau.

3. Perform any of the [Basic Actions](#) mentioned in Navigation chapter.
4. In the **Credit Bureau Report Formats** section, perform any of the [Basic Operations](#) mentioned in Navigation chapter.
A brief description of the fields is given below:

Table 3-24 Credit Bureau Report Formats

Field	Do this
Company	Select the portfolio company that will be using the above credit bureau from the drop-down list.
Branch	Select the portfolio branch from the company that will be using the above credit bureau from the drop-down list.
Description	Specify the credit report format description.
Member Code	Specify the credit bureau member code (assigned by bureau).
Password	Specify the credit bureau password.
Customer Code	Specify the customer code.
Auth Password Change Dt	<p>Display the last authorization password change date. The Experian Net Connect product requires that the Auth Password (or SSP Password in Experian jargon) be changed every 90 days (or sooner). Equifax may have similar requirements, but they were not known at the time of this writing. Use the date displayed in this field to identify when the password needs to be changed.</p> <p>Note: The password needs to be changed both in the system and at the credit bureau. Changing the password does not initiate or perform a change at the bureau. Changing the password at the bureau must be done outside the system. Contact the credit bureau for the procedure for changing the password (display only).</p>
Auth User ID	Displays the authorization user ID (display only).
Auth Password	<p>Displays the authorization password (display only).</p> <p>Note: This field is not displayed to the user and is also encrypted before being stored in the database (display only).</p>
Change Authorization User Id/Password section	
New Auth User Id	Specify the authorization user ID.
New Auth User Password	Specify the authorization user password.
TransUnion Details section	
(Note: This is only applicable for TransUnion.)	
Market	Specify the TransUnion market id.
Sub Market	Specify the TransUnion Sub Market id.

Table 3-24 (Cont.) Credit Bureau Report Formats

Field	Do this
Industry	Specify the TransUnion Industry code.
Experian Details section (Note: This is only applicable for Experian.)	
Preamble	Specify the Experian preamble code.
Host Code	Specify the Experian host ID.
UIC	Specify the Experian UIC.
Equifax Details section (Note: This is only applicable for Equifax.)	
Service Name	Specify the equifax service name. The service name will be provided to you by Equifax when your company's Internet System to System account is created. Possible values for pulling credit reports are acrotest (for access to the test system) and acro (for access to the production system).

- Perform any of the [Basic Actions](#) mentioned in Navigation chapter.
- In the **Report Format Details** section, you can choose the various parameters of report format and also indicate if the report is to be processed internally or externally. To support geography specific Credit Bureau integration, external interface is also supported in OFSLL. In such case, a webhook request for Credit Bureau Onboarding report is initiated from OFSLL. The same is processed in external bureau service depending on the endpoint configuration (type of bureau to be used as defined in Setup > Administration > System > Webhook screen).

Based on the response received the **Credit Bureau Put** web service is triggered to update the details. Also on processing CREDIT_REQUEST_DETAILS the **Status** of the request received in CRL_CRB_REP_STATUS_CD is updated in **Bureau** tab of Origination and Servicing screens in the following combination:

Table 3-25 Report Format Details

CRL_CRB_REP_STATUS_CD		Bureau Details > Status
Primary	Secondary	
Completed	Completed	Completed
Completed	Failed	Failed
Failed	Completed	Failed
Failed	Failed	Failed
Submitted	Completed	Submitted
Completed	Submitted	Submitted

- Perform any of the [Basic Operations](#) mentioned in Navigation chapter. A brief description of the fields is given below:

Table 3-26 Report Formats

Field	Do this
Report	Specify the report name to be accessed from the credit bureau.
Report Type	Select the report type of the credit bureau report from the drop-down list.
Report Class	Select the report class as either Consumer or Business from the dropdown list.
Multi Request Allowed	Check this box to allow report request from multiple bureaus.
Score Type	Select the credit score type from the drop-down list.
Addl Product	Select the product code from the drop-down list.
Inquiry Limit	Select the inquiry limit for the credit report from the drop-down list.
Default	Check this box set this as default report format.
External Report	Check this box if the Credit Bureau Onboarding report request format is to be processed from external system. If selected, the encoding and decoding of request details and pooling of data into report is handled externally. By default, this check box is not selected and Credit Bureau Onboarding report request is processed within the system.

8. Perform any of the [Basic Operations](#) mentioned in Navigation chapter. A brief description of the fields is given below:

Table 3-27 Report Output

Field	Do this:
Report	Specify the report name to be accessed from the credit bureau.
Report Type	Select the report type of the credit bureau report from the drop-down list.
Score Type	Select the credit score type from the drop-down list.
Addl Product	Select the product code from the drop-down list.
Inquiry Limit	Select the inquiry limit for the credit report from the drop-down list.
Enabled	Check this box to enable the report as default.

9. Perform any of the [Basic Actions](#) mentioned in Navigation chapter.

3.5.1.2 Connections

The Connections screen records and supports various connections to the credit bureau to receive reports from the agencies. The system supports connections to the bureaus through one or more modems attached to the database server, network accessed modem server, or direct network connection (usually frame relay).

For modem-based connections, multiple credit bureaus can be accessed over the same modem. If there are multiple requests in the queue, the order in which the bureaus are listed determines the order in which the requests are processed.

For example,

If the credit bureau service checks the submitted credit requests and finds three Experian, one Equifax, and two TransUnion credit requests and the connections setup is Bureau1=TUC, Bureau2=EFX, and Bureau3=EXP, the two TransUnion requests will be processed first, the Equifax request next, and then the three Experian requests.

Note

For this above example, adding two more modems and assigning a specific bureau to each one would help to avoid the delay caused by queuing all requests through a single modem.

IMPORTANT: Direct network connections must be set up for only one bureau.

Like the Credit Bureau section on the Report Formats screen, the data fields used on the Connections screen are generic and not all fields are used for all access methods. The following table summarizes the data needed for each access method:

Figure 3-16 Credit Bureau_Methods Table

Method	Name	Bureau 1	Bureau 2	Bureau 3	Device	Device Speed
Dial-up	Required	Required (can be EXP, TUC, or EFX)	Optional (can be EXP, TUC, or EFX)	Optional (can be EXP, TUC, or EFX)	Required (can be either a local serial port device or an IP address and port number of a network modem)	Required for locally attached modems
Experian Frame-relay	Required	Must be EXP	Leave blank	Leave blank	Must be the IP address and port number of Experian host	Not applicable
Equifax Frame-relay	Required	Must be EFX	Leave blank	Leave blank	Must be the IP address and port number of Equifax host	Not applicable
TransUnion Frame-relay	Required	Must be TUC	Leave blank	Leave blank	Must be the IP address and port number of TransUnion host	Not applicable
Experian Net Connect	Required	Must be EXP	Leave blank	Leave blank	Must be the ECALS URL provided by Experian	Not applicable
Equifax Internet System to System	Required	Must be EFX	Leave blank	Leave blank	Must be the URL provided by Equifax for connecting to the Internet System to System service	Not applicable
CSC Internet	Required	Must be CSC	Leave blank	Leave blank	Must be the URL provided by CSC	Not applicable
CredcoConnect	Required	Must be CRD	Leave blank	Leave blank	Must be the URL provided by Credco	Not applicable

For frame relay access, specify the IP address provided by the bureau followed by a space and then the port number (for example, 192.168.36.2.700).

Experian Net Connect

At the time of this writing, the Experian product ECALS URL is:

```
http://www.experian.com/lookupServlet1?lookupService  
Name=AccessPoint&lookupServiceVersion=1.0&serviceName=Net  
Connect&serviceVersion=2.0&responseType=text/plain
```

Note

The URL given above is one continuous string. This can be verified by entering the URL with a browser. The displayed value will be an HTTPS URL.

Enter the entire ECALS URL provided by Experian into the Device field. Notice that this URL does not start with https. The ECALS URL is a URL used by the credit bureau service to request the HTTPS URL. The HTTPS URL is not displayed on any setup screen and is only known to the credit bureau interface at runtime.

Equifax Internet System to System

At the time of this writing, the Equifax Internet System to System URL is:

```
https://transport5.ec.equifax.com/servlet/stspost
```

CSC Tri-Merge

At the time of this writing, the CSC URL is:

```
https://www.emortgage.Equifax.com/cgi-bin/emspop.exe
```

To setup the Connections

1. Click **Setup > Setup > Administration > User > Credit Bureau > Connections**.
2. In the **Credit Bureau Connections** section, perform any of the [Basic Operations](#) mentioned in Navigation chapter.

Figure 3-17 Credit Bureau Connections

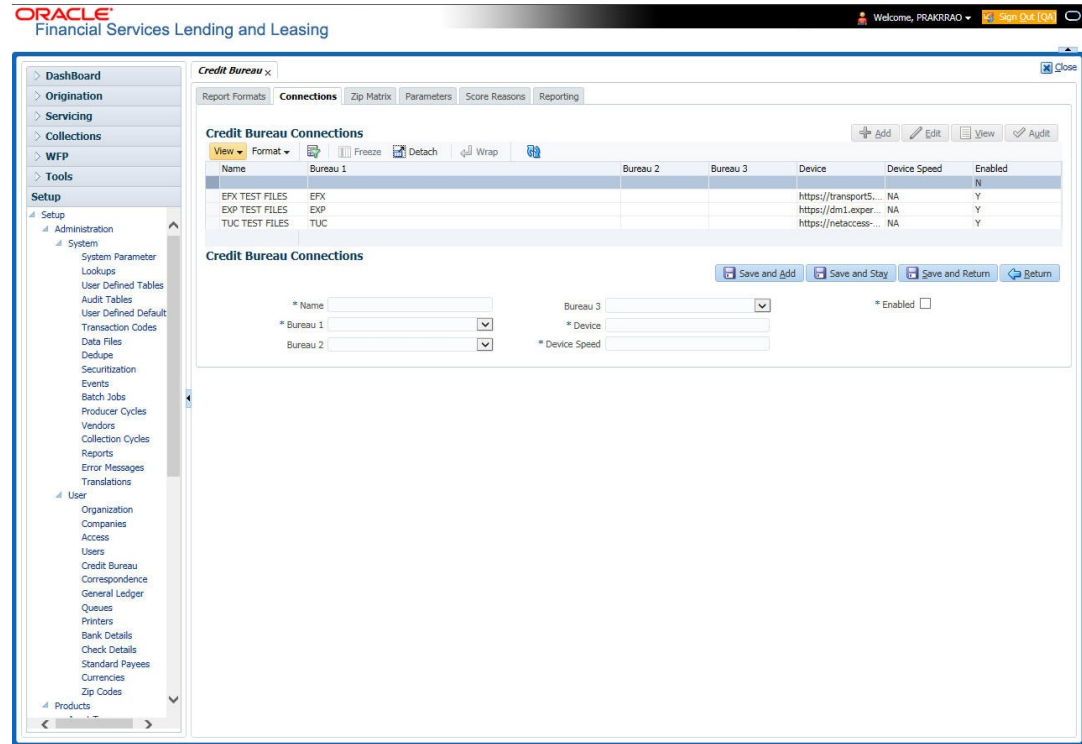

A brief description of the fields is given below:

Table 3-28 Credit Bureau Connections

Field	Do this
Name	Specify connection name.
Bureau 1	Select first credit bureau from the drop-down list.
Bureau 2	Select 2nd credit bureau from the drop-down list.
Bureau 3	Select 3rd credit bureau from the drop-down list. Note: The Bureau1, Bureau2, and Bureau3 fields in the Credit Bureau Connections section specify which bureau types can be accessed over the connection.
Device	Specify the connection device name. The Device field lists the physical device name for a modem, or the IP address for a network accessed connection.
Device Speed	Select the connection device speed. The Device Speed field is only applicable to server-attached modems. It is used to specify the communications speed between the server and the modem.
Enabled	Check this box to enable the connection.

3. Perform any of the [Basic Actions](#) mentioned in Navigation chapter.

3.5.1.3 Zip Matrix

The system uses the zip code of the applicant’s current home address to determine which credit bureau to use when automatically pulling a report. The Zip Matrix screen allows you to record the credit bureau from which a report is pulled based on a range of zip codes, as well as the company, branch and country of the account.

When searching for a zip code match, the system:

1. Reads the first credit bureau defined in the matrix
2. Reads the credit report format to get the appropriate membership code and password for the user’s location
3. Requests a credit report.

If the system cannot pull a report from the first bureau, it pulls one from the second. If the zip code you entered does not fall in the matrix setup, then the system uses a default zip matrix (0000000000 to 0000000000) to select the required bureau.

To set up the Zip Matrix

1. Click **Setup > Setup > Administration > User > Credit Bureau > Zip Matrix**
2. In the **Credit Bureau Zip Code Matrix** section, perform any of the [Basic Operations](#) mentioned in Navigation chapter.

Figure 3-18 Credit Bureau Zip Code Matrix

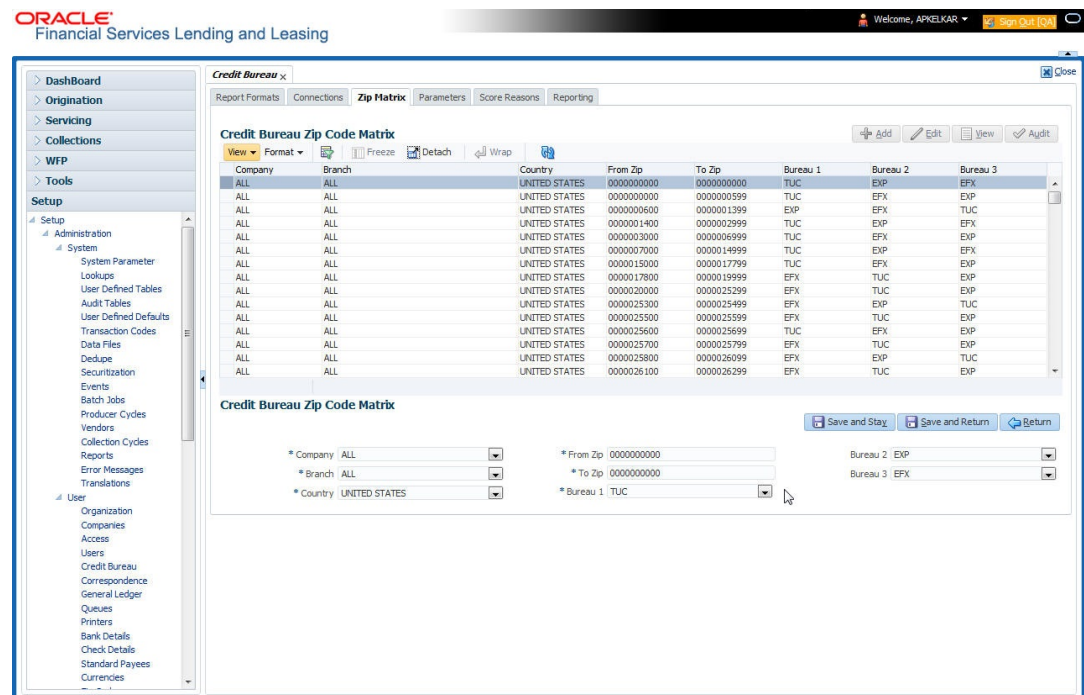

A brief description of the fields is given below:

Table 3-29 Credit Bureau Zip Code Matrix

Field	Do this
Company	Select the portfolio company from the drop-down list.
Branch	Select the portfolio branch from the drop-down list. The branch will be displayed based on the company selected.
Country	Select the country from the drop-down list.
From Zip	Specify the starting zip code (From).
To Zip	Specify the ending zip code (To).
Bureau 1	Select the preferred bureau #1 (first bureau pulled), from the drop-down list. You must enter at least one credit bureau in the Bureau 1 field for each zip code range. The bureau entered in the Bureau 1 field for each range is the primary bureau. For any given range, do not list the same credit bureau in more than one field.
Bureau 2	Select the preferred bureau #2 (second bureau pulled) from the dropdown list.
Bureau 3	Select the preferred bureau 3 (third bureau pulled) from the drop-down list.

3. Perform any of the [Basic Actions](#) mentioned in Navigation chapter.

3.5.1.4 Parameters

The Parameters screen records parameters specifically dealing with credit bureau information. These parameters are divided into three groups:

- Parsing parameters
- Request parameters
- Configuration parameters

Parameters can be defined at the company or branch level. The following credit bureau parameters are configured during the installation:

PARSING PARAMETERS FOR CREDIT BUREAU SERVICE

CONFIGURATION PARAMETERS FOR CREDIT BUREAU SERVICE

The following credit bureau parameters are configured during implementation:

REQUEST PARAMETERS FOR CREDIT BUREAU SERVICE

To setup the Parameters

1. Click **Setup > Setup > Administration > User > Credit Bureau > Parameters**.
2. In the **Credit Bureau Parameters** section, perform any of the [Basic Operations](#) mentioned in Navigation chapter.

Figure 3-19 Credit Bureau Parameters

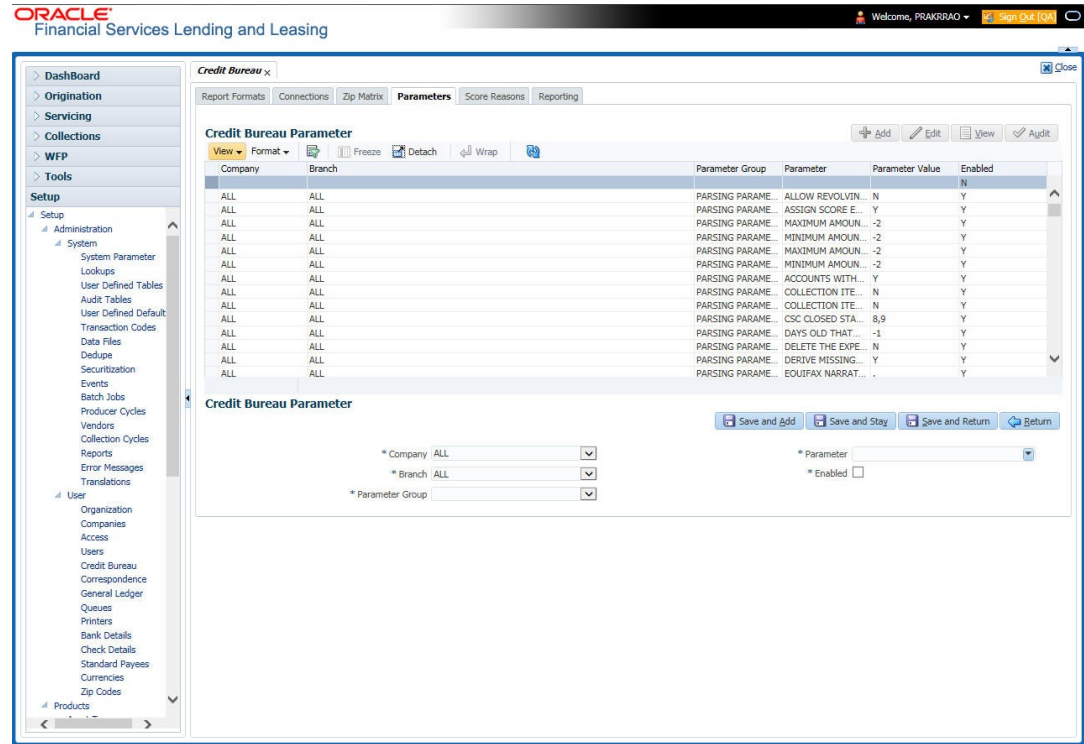

A brief description of the fields is given below:

Table 3-30 Credit Bureau Parameters

Field	Do this
Company	Select the portfolio company from the drop-down list.
Branch	Select the portfolio branch from the drop-down list. The branch will be displayed based on the company selected.
Parameter Group	Select the credit bureau parameter group from the drop-down list.
Parameter	Select the credit bureau parameter from the drop-down list
Parameter Value	Specify the credit bureau parameter value.
Enabled	Check this box to enable the credit bureau parameter.

3. Perform any of the [Basic Actions](#) mentioned in Navigation chapter.

3.5.1.5 Score Reasons

The Score Reasons screen allows you to define or modify the scoring reason codes and descriptions for the predefined scoring models used by the credit bureau agencies.

Note

This information is not associated with the user-defined scores determined by the internal Oracle Financial Services Lending and Leasing model during product setup.

To setup the Score Reasons

1. Click **Setup > Setup > Administration > User > Credit Bureau > Score Reasons**.
2. In the **Score Models** section, you can view the following information.

Figure 3-20 Score Models

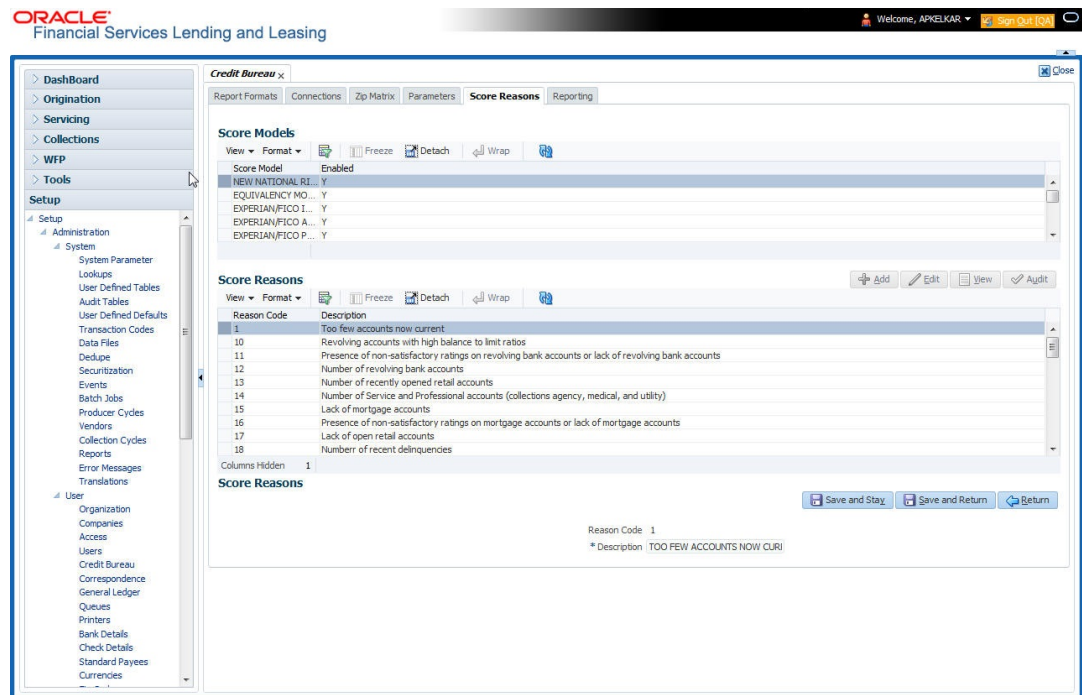

A brief description of the fields is given below:

Table 3-31 Score Models

Field	Do this
Score Model	Displays the credit bureau score model (display only).
Enabled	Displays if the credit bureau score model is enabled or not.

3. On the **Score Reasons** sub screen, perform any of the [Basic Operations](#) mentioned in Navigation chapter.

A brief description of the fields is given below:

Table 3-32 Score Reasons

Field	Do this
Reason Code	Specify the reason code.
Description	Specify the description.

4. Perform any of the [Basic Actions](#) mentioned in Navigation chapter.

3.5.1.6 Reporting

The system reports to the credit bureau agencies in the Metro 2 format with the payment and account status information of each account holder. The Credit Bureau Reporting screen contains the program identifier to be reported to the bureaus.

To setup the Reporting

1. Click **Setup > Setup > Administration > User > Credit Bureau > Reporting**.
2. In the **Credit Bureau Reporting** section, perform any of the [Basic Operations](#) mentioned in Navigation chapter.

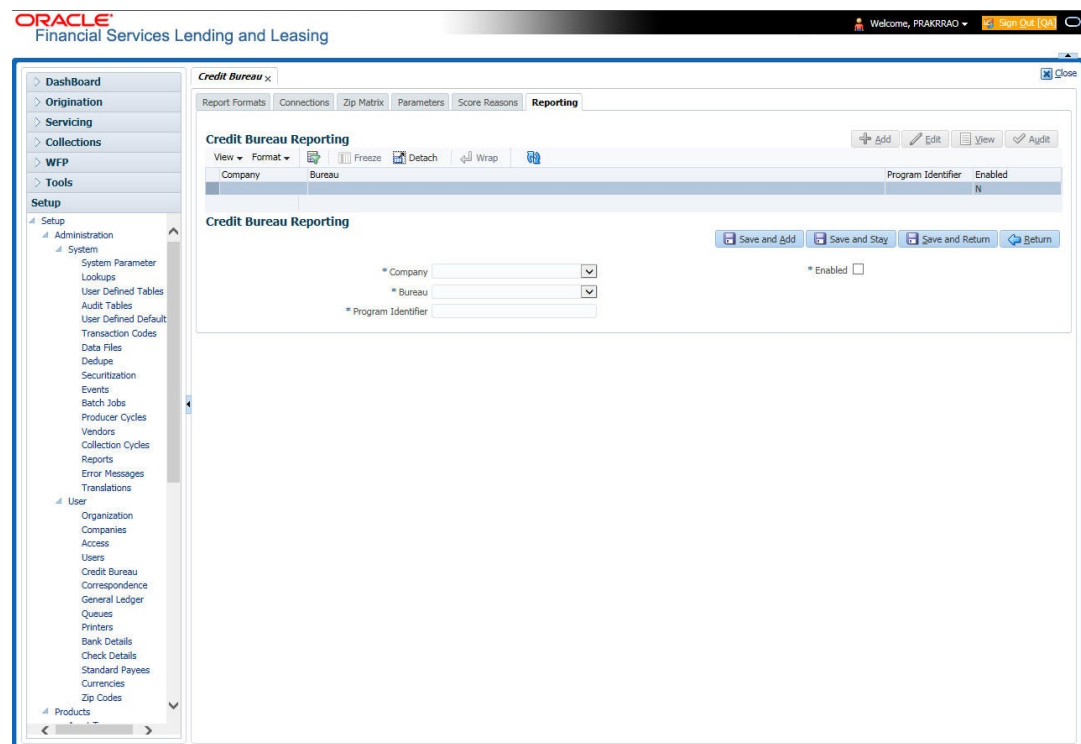
Figure 3-21 Credit Bureau Reporting

A brief description of the fields is given below:

Table 3-33 Credit Bureau Reporting

Field	Do this
Company	Select the portfolio company from the drop-down list.
Bureau	Select the bureau from the drop-down list.
Program Identifier	Specify the program identifier. The customer receives this from the bureau and uses it to identify itself to that bureau. You will need to update this information.
Enabled	Check this box to enable the program.

3. Perform any of the [Basic Actions](#) mentioned in Navigation chapter.

3.5.2 Special Metro II Code reporting

The system allows you to report the following special Metro II segments to the credit bureau output file:

- Consumer Information Indicator Code (CIIC)
- Compliance Condition Code (CCCD)
- Special Comment Code (SPCC).

The system users will need to use call Action/Results and Reason fields on the Call Activities sub screen of the Customer Service form (Lending > Customer Service > Customer Service (2) master tab > Account Details tab > Call Activities sub tab) to place specific account conditions where these Metro II segments are to be reported. The specific segment reported for a given condition will be based on the account condition and call activity reason codes.

Note

It is the responsibility of the Administrator or individual user to setup Special Metro II Code reporting functionality.

When users open one of the following conditions:

Table 3-34 Special Metro II Code reporting

Code	Description
CIIC	CONSUMER INFORMATION INDICATOR CODE (METRO2 - FCRA)
CCCD	COMPLIANCE CONDITION CODE (METRO2)
SPCC	SPECIAL COMMENT CODE (METRO2)

The system recognizes the condition, processes the selected Metro II reporting call activity reason code, and generates the Metro II reporting segment in the Metro II reporting output file.

Note

- You are responsible for selecting the correct Metro II reporting segment reason code to be reported. If you do not select a Metro II reporting segment reason code, the system will not generate information to Metro II output file. If you select an incorrect Metro II reporting segment reason code, the system will report the selected Metro II reporting segment. The system does not validate the contents of the Reason field with the contents of the Condition field.
- To end the reported Special Metro II Special Code, close the open Special Metro II Condition (no reason code needed). The system recognizes the closing of the open Special Metro II Condition and will not create a Metro II reporting segment in the output file.
- The CBU_FILE_FREQUENCY (METRO 2 FILE FREQUENCY) Company system parameter determines if output file is generated and created daily or output file is written with daily data and output monthly.

To setup Metro II Code reporting

1. On the Oracle Financial Services Lending and Leasing home screen, click **Setup > Setup > Administration > User > Queues > Call Action Results** to open and close the following system defined condition codes:

Table 3-35 Metro II Code reporting

Action Code	Description
CIIC	CONSUMER INFORMATION INDICATOR CODE (METRO2 - FCRA)
CCCD	COMPLIANCE CONDITION CODE (METRO2)
SPCC	SPECIAL COMMENT CODE (METRO2)

When setup is completed, you can open and close Special Metro II code conditions.

Note

Opening and closing Special Metro II Code reporting is a manual process.

The CBU_FILE_FREQUENCY (METRO 2 FILE FREQUENCY) Company system parameter determines, if output file is generated and created daily or output file is written with daily data and output monthly.

3.5.3 Oracle Wallet Manager setup

The Experian Net Connect, Equifax Internet System to System, and CSC interfaces within the system credit bureau service use functionality provided by the Oracle Wallet feature. Use the Oracle Wallet Manager on the database server to create and export a wallet for use by the credit bureau service.

Note

All of the above mentioned interfaces use the same Oracle wallet. If a wallet already exists and is in use by one of the credit bureau interfaces, there is no need to create another wallet. Due to differing certificate requirements, there may be a need to import additional trusted certificates into the wallet, but there will not be a need to create a new one. The credit bureau parameter ORA_WALLET_PATH contains the location of the Oracle Wallet used by the credit bureau service.

To create and export a wallet suitable for use by the credit bureau

Refer to the Oracle documentation for more detailed instructions on how to use the Oracle Wallet Manager to create and manage a wallet:

1. If a wallet does not already exist, create one somewhere on the database server. The location must be readable and writable by the Oracle user. Make a note of the full path where the wallet is stored (for example, `/etc/ORACLE/WALLETS/oracle` or `C:\oracle\WALLETS`).
For Transunion credit bureau, a separate wallet file is needed under transunion folder inside the main wallet path (for example: `/etc/ORACLE/WALLETS/oracle/transunion` or `C:\oracle\WALLETS\transunion`).
2. The wallet needs to contain the public key for the certificate authority that issued the server certificate for each HTTPS web site that will be connected to by the credit bureau interface. At the time of this document, those sites are:

Table 3-36 Credit Bureau Location

Location	Credit Bureau
Experian Credit Bureau (https://dm1.experian.com/netconnect2_0Demo/servlets/NetConnectServlet)	Experian
Equifax Credit Bureau (https://api.uat.equifax.com/business/sts-reports/v1/report)	Equifax
CSC Credit Bureau (https://emsws.equifax.com/emsws/services/post/MergeCreditWWW)	CSC
Transunion Credit Bureau (https://netaccess-test.transunion.com)	TUC

This list may change. Use the URL provided to you by the credit bureau when they set up your service. To get the proper Experian HTTPS URL, enter the ECALS URL that was provided by Experian into a web browser. The response returned to the browser is the HTTPS URL that will be used to communicate with Experian.

1. Import the necessary certificate authority's certificate files into the Oracle wallet that was created in Step 1. See the appendix of this chapter for detailed instructions of how to download and install a trusted certificate.
2. Test the wallet by connecting to each web site with a simple command issued from SQLPlus.

```
SQL> select utl_http.request('https://ssl.experian.com', NULL,
'file:/etc/ORACLE/WALLETS/oracle', 'password') from dual;
```

Replace the URL in the above command with each HTTPS URL given to you for use by the credit bureaus. Also replace the wallet path with the path to your wallet and your wallet password. The output from the command is not important, what is important is that it runs without displaying an Oracle error. If there is an Oracle error, then something is wrong with the contents of the wallet, the path to the wallet, and/or the wallet password.

3. When the wallet contains all of the required trusted certificates, export the wallet to a text file. On the **Operations** menu of the Oracle Wallet Manager, choose **Export All Trusted Certificates**. The text file **MUST** be located in the same directory as the wallet and the filename **MUST** be `default.txt`. Anytime a change is made to the trusted certificates in the wallet, the wallet must be re-exported to the same text file.
4. In the **Setup > Setup > Credit Bureau > Parameters** set the `ORA_WALLET_PATH` and `ORA_WALLET_PASSWORD` parameters.

3.5.4 Oracle JVM Security setup

The Experian Net Connect interface within the credit bureau service requires the use of the Oracle Java Virtual Machine (JVM) that is resident in the Oracle database. Furthermore, specific permissions must be granted to the Java classes used by the credit bureau service. These permissions have been added to the `set_java_perms.sql` script that is part of the distribution. This script (as well as many other useful SQL scripts) is available from the Oracle Financial Services Software technical support Oracle Financial Services Lending and Leasing patches web site.

The `set_java_perms.sql` script needs to run as the SYS user (or a user with SYS privileges). The script will prompt for SYS user id and password. Be prepared to provide it when prompted. Also, the script will select the value of the `ORA_WALLET_PATH` parameter from the credit bureau parameters table. Make sure that it has been updated with the proper wallet path before running the `set_java_perms.sql` script (although the script can be safely run again if necessary).

Credit Bureau Service operation

The basic operation of the credit bureau service has not changed. Once setup, there is no operational difference between accessing the credit bureaus via dial-up, frame relay, or the Internet.

3.5.5 Importing a trusted certificate into an Oracle Wallet

The HTTPS servers used by Experian, Equifax, and CSC for their Internet based credit report services (as well as all HTTPS servers) contain a site certificate signed by a trusted Certificate Authority (CA). The CA is an entity that guarantees the identity of the HTTPS server. If the client trusts the CA, and the CA says that the HTTPS server is who they say they are, then the client inherently trusts the HTTPS server. Normally, a client tool such as Microsoft Internet Explorer has a large store of trusted CA certificates which makes secure communication between a client and a trusted HTTPS server relatively seamless and uneventful. Unfortunately, the store of CA certificates in the default Oracle wallet is rather small and it is likely that it will not contain the certificate of the CA that is certifying one or more of the credit bureau web sites. This means that the CA certificate must be imported into the wallet. To do this, the certificates must first be exported from a browser and then imported into the Oracle wallet using the Oracle Wallet Manager.

Using Microsoft Internet Explorer to Export a Certificate

1. Use Microsoft Internet Explorer and connect to one of the HTTPS URLs referenced in the Oracle Wallet Manager Setup section of this document.

If the web site asks for a user id and password, cancel the dialog box and remain on the top-level HTTPS screen.

2. Once connected, from the browser's **File** menu, choose **Properties**.
3. Click the **Certificates** button.
4. Click the **Certification Path** tab. The bottom-most certificate is the one generated by the host itself. The one or more certificates above the bottom-most one are of greater importance to this task. The screen shot below displays a web site with two CAs (an intermediate, and a primary). Whether it is an intermediate CA or a primary one, the steps are the same for saving the certificate as a text file.

Figure 3-22 CreditBureau_Certificate

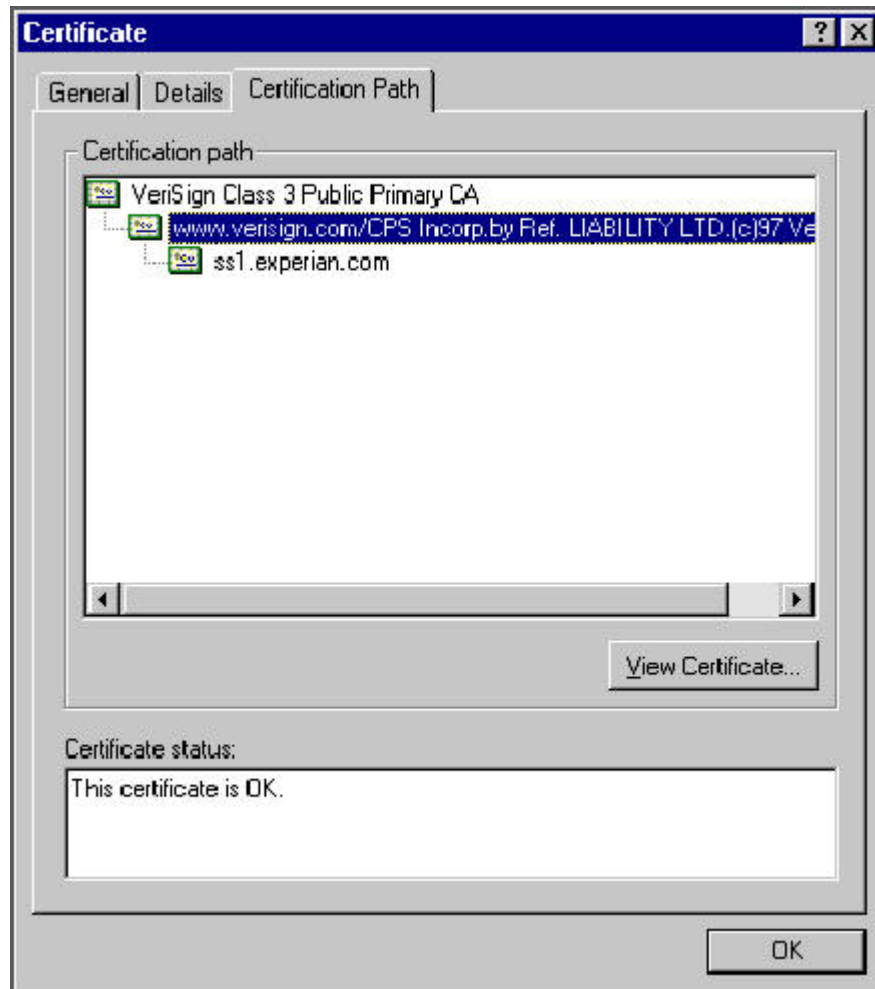

5. Click the first certificate above the bottom-most certificate (it may be the only certificate above the bottom-most certificate).
6. Click the **View Certificate** button.
7. Click the **Details** tab.
8. Click the **Copy to File** button.
9. Click the **Next** button.
10. Choose the **Base 64** encoded format.

11. Click the **Next** button.
12. Enter a filename and location for the file.
13. Click the **Next** button.
14. Click the **Finish** button.
15. Repeat steps 5 through 14 for the next certificate in the certification path, if any.

3.5.6 Importing the Certificates into an Oracle Wallet

1. Copy the certificates exported and saved during the process described above onto the database server (not the iAS server).
2. As the Oracle user (or Administrator on Windows), start the Oracle Wallet Manager.
3. Open the wallet that will be used by the credit bureau service. Create a new wallet if one does not already exist.
4. View the list of Trusted Certificates in the wallet.
5. Check the list of certificates against the list of certificates that are in use on the HTTPS servers used by the credit bureaus (and that were exported and saved during the export process described above).
6. Click the **Trusted Certificates** heading in the left list box of the Oracle Wallet Manager.

Figure 3-23 Oracle Wallet Manager

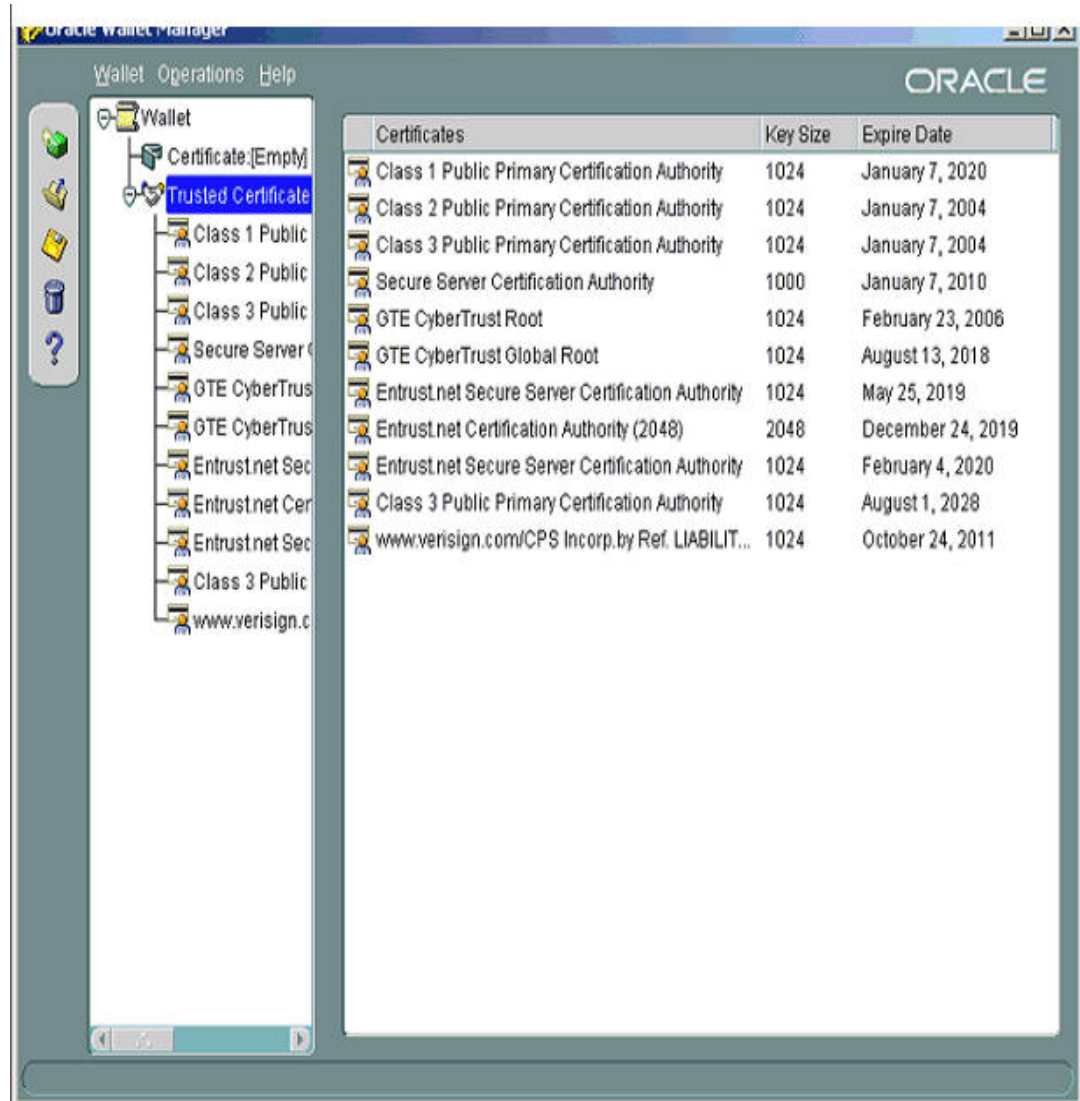

- Use Microsoft Internet Explorer to view the certificate details for the HTTPS web sites (**File > Properties > Certificates > Certification Path > View Certificate > General**) that will be contacted by the credit bureau service. Look through the list of certificates shown in the right panel of the Oracle Wallet Manager and look for a match between the **Issued To** and **Valid To** dates shown in the Internet Explorer View Certificate screen. The screen shot below shows a certificate that is already in the wallet's list of trusted certificates (see the last entry for the **www.verisign.com/CPS** certificate).

Figure 3-24 Certificate

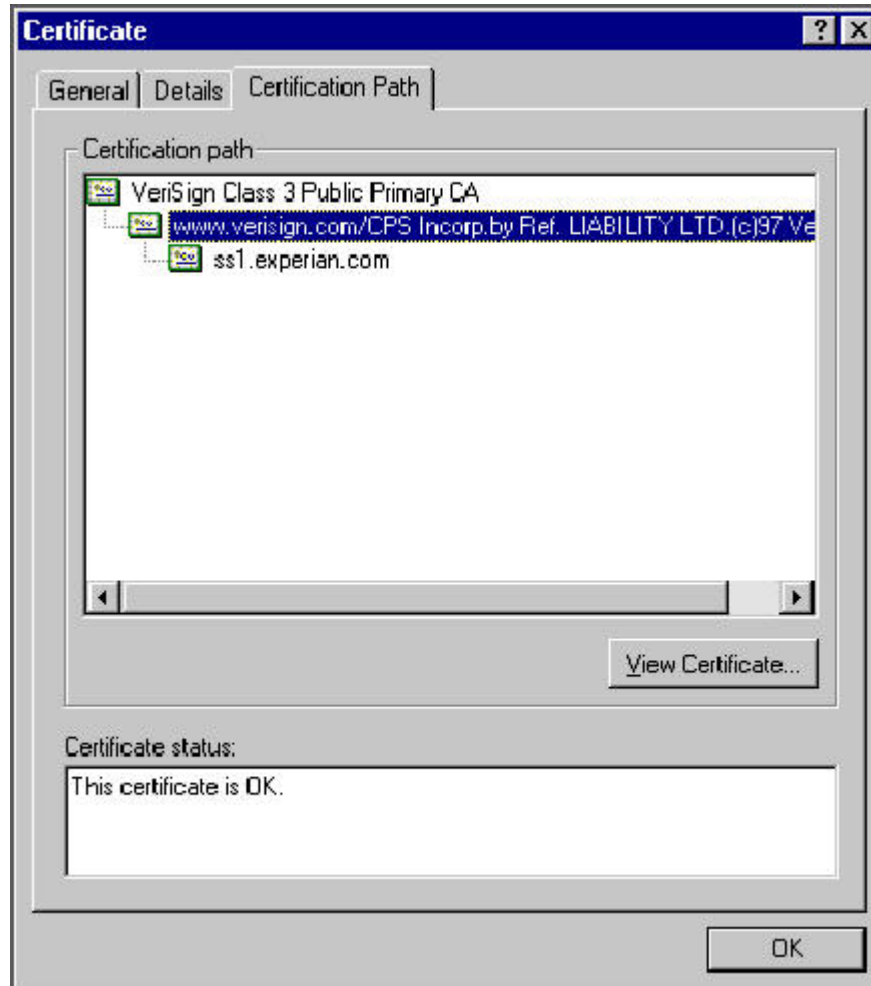

8. On the **Operations** menu, choose **Import Trusted Certificate** and follow the prompts for locating and loading the files that were copied onto the database server in step 1 for any certificate not already stored in the wallet.
9. On the **Wallet** menu, choose **Save** when finished loading certificates.

3.5.7 De-duping Credit Bureau data

Oracle Financial Services Lending and Leasing allows you to remove duplicate (**de-dupe**) liabilities data from the credit bureau information.

De-duping logic

The de-duping logic is based on a number of parameters that the system compares among tradelines (**only**) to determine if they are duplicates. The following fields are used to determine if two tradelines are duplicates:

Table 3-37 De-duping logic

Field	Description
Account #	The account number of the consumer with the lender for the particular account.

Table 3-37 (Cont.) De-duping logic

Field	Description
Open Date	The date the account was opened.
Member Code	The subscriber code of the lender with the respective credit bureau. Note: Since member codes for the same lender differ across bureaus, this field is used only for tradelines reported by the same bureau. Since reports obtained from CSC can have tradelines from different bureaus, this field is only for reports pulled from the credit bureaus.

All available bureau reports pulled later than DEDUP_CRB_EXPIRATION_DAYS days old will be used.

The following system parameters will be set up to provide switches to allow the functionality to be turned on and off:

Figure 3-25 System Parameters

Parameter	Description	Valid Values	Setup Value
JOINT_DEDUP_SPOUSE_LIABILITIES	De-deup the tradelines with spouse	Y, N	Y
JOINT_DEDUP_ALLAPL_LIABILITIES	De-deup the tradelines with spouse and secondary applicants(s).	Y, N	Y
DEDUP_CRB_EXPIRATION_DAYS	Credit report expiration days	Number	90

Whenever two (or more) items are identified as duplicates, Oracle Financial Services Lending and Leasing uses the following hierarchy to pick one of the items as the **correct** one:

- Last Reported Date:** The row that has been reported most recently is used.
- Owner:** In case of a tie on the last reported date, one of the tradelines is picked in the descending order of priority depending on who the tradeline belongs to: Primary, Spouse, then Secondary.

Debt Ratio combination

Oracle Financial Services Lending and Leasing uses the system parameter DBR_JOINT_INC_DEBT_WITH_SPOUSE to decide whether to combine debt ratios of the spouse with the primary applicant. The DBR_JOINT_INC_DEBT_WITH_COAPP parameter decides whether to do the same on a non-spousal joint application.

When this indicator is checked, all liabilities in the Liability section on the Summary sub screen of the Applicant (2) master tab with the Include box selected will be used in the debt ratio calculation.

The following system parameter will be set up to provide switches to allow the functionality to be turned on and off:

De-duping process

The de-duping logic will be integrated into the system decision-making process in the following manner:

Initial credit pulls on new applications

- If the JOINT_DEDUP_SPOUSE_LIABILITIES/ JOINT_DEDUP_ALLAPL_LIABILITIES system parameters are set to **Y**, uses the de-duping logic described above to uncheck the duplicate liabilities in the spouse's/co-applicant's liabilities.
- If the DBR_JOINT_INC_DEBT_WITH_SPOUSE/ DBR_JOINT_INC_DEBT_WITH_ALLAPL parameters are set to **Y**, the system includes the liabilities of the spouse/ co-applicant while calculating the debt ratio of the primary applicant.
- The system will use all available credit reports at the time.

Subsequent credit pulls (manual)

- To remove duplicate liabilities from the calculation, choose the **Dedup Liabilities** button on the **Underwriting** form (**Applicants** master tab > **Summary** sub screen > **Liability** section). (Potential record locking situations force the action to remain manual versus the system automatically doing it).
- If the **Populate Debt** and **Include Debt** boxes are selected in the **Applicant/Customer Detail** section on the **Bureau** master tab on the **Underwriting** form for the credit request and the JOINT_DEDUP_SPOUSE_LIABILITIES/ JOINT_DEDUP_ALLAPL_LIABILITIES system parameters are set to **Y**, the system will use the de-duping logic described above to uncheck the duplicate liabilities in the spouse's/co-applicant's liabilities.
- If the DBR_JOINT_INC_DEBT_WITH_SPOUSE/ DBR_JOINT_INC_DEBT_WITH_COAPL parameters are set to **Y**, the system will include the liabilities of the spouse/ co-applicant while calculating the debt ratio of the primary applicant.
- The system will use all available credit reports at the time of the request that have been requested within the number of days specified in the DEDUP_CRB_EXPIRATION_DAYS parameter.

Restrictions

The de-duping logic will be limited based upon the discussion above. If the system cannot identify two tradelines as duplicates based upon the logic mentioned above, the individual tradelines will be retained. In such circumstances, both tradelines will be used in the debt ratio calculation and it will be the user's responsibility to disregard one of them by clearing the Include check box.

3.6 Correspondence

The Correspondence screen enables you to setup the system's correspondence.

The system provides two types of correspondence: predefined and ad hoc. The following chart provides a quick summary of both:

Figure 3-26 Correspondence Types

TYPE OF CORRESPONDENCE:	AD HOC	PREDEFINED
Created automatically		X
Created manually	X	X
Generated for accounts	X	X
Generated for applications	X	X
Set up with the Correspondence link	X	
Set up with the Letters link on the Product link		X

This chapter explains how to setup ad hoc correspondence with the Correspondence form.

The Correspondence screens provide a cost-effective and easy to use method to build custom documents that draw information from the system's database without additional programming. You can choose what to include in a letter, create a template, and then use this template to produce a letter.

The core of the Correspondence module is the document element -- the information stored in the database merged into the correspondence. The system has document elements defined for commonly used data elements in correspondence, such as account numbers, account balances, customer addresses, telephone numbers, and due dates.

Correspondence consists of a document file with text of your choice and the document elements from the system's database.

You can create a correspondence set that consists of one or more documents. If a correspondence set consists of more than one document, such as the account details letter and a payment overdue letter, it prints both documents every time the system generates correspondence for a customer.

The Correspondence module creates the following standard ad hoc correspondence:

- Microsoft Word (RTF)
- Adobe Acrobat (PDF/XFDF)

Note

In this document and in the system, the term BANKERS SYSTEM is synonymous with Adobe Acrobat.

This section consists of the following topics:

- [Correspondence](#)
- [Creating Correspondence](#)
- [Generating Correspondence](#)

3.6.1 Correspondence

Navigating to Correspondence

On the Oracle Financial Services Lending and Leasing home screen, click **Setup > Setup > Administration > User > Correspondence**.

The Correspondence screen contains the following sub screens:

- [System Functions](#)
- [Elements](#)
- [E-Form Elements](#)
- [Documents](#)
- [Correspondence](#)

3.6.1.1 System Functions

The System Functions screen enables you to view the predefined functions for the appropriate Line of credit product in the system. These are attributes from the database.

Functions define how the system retrieves data to include in correspondence. The data is retrieved as elements which are either specific database columns or calculated values. Elements are recorded on the Elements screen.

To view the predefined system functions

1. Click **Setup > Setup > Correspondence > Line of credit > System Functions**.
2. In the **Function Definition** section, you can view the following information.

Figure 3-27 Correspondence - System Functions

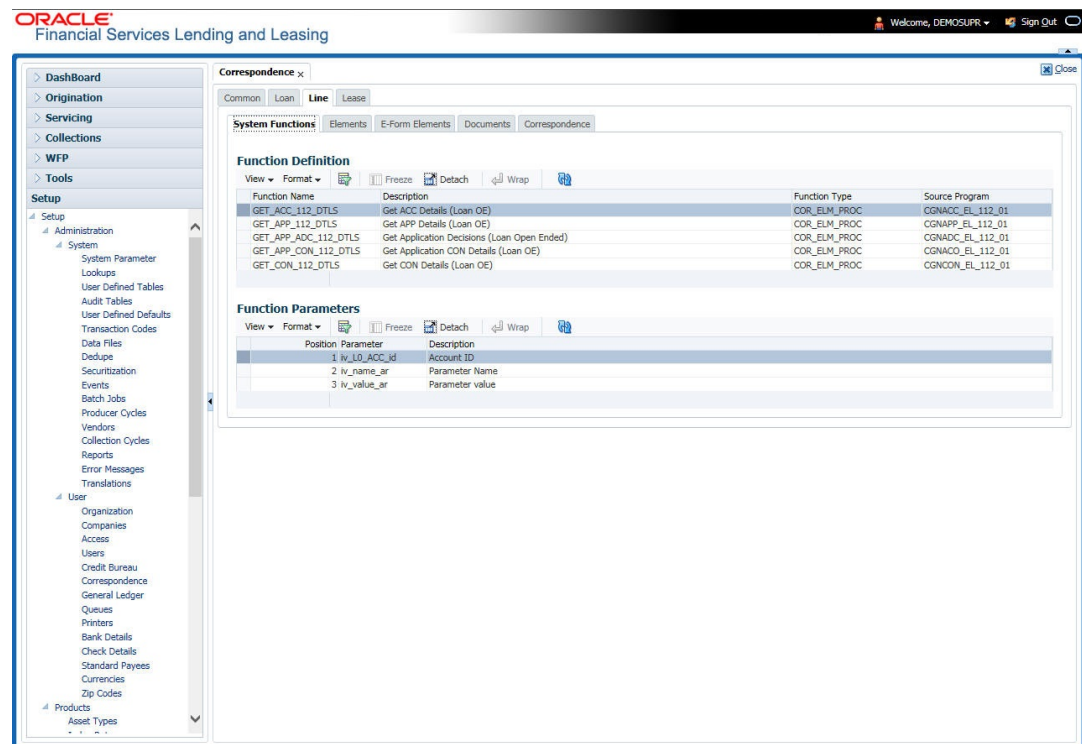

A brief description of the fields is given below:

Table 3-38 Function Definition

Field	View this
Function Name	Displays the function name.
Description	Displays the function description.
Function Type	Displays the function type.
Source Program	Displays the source program.

3. In the **Functions Parameters** section, you can view the following information. A brief description of the fields is given below:

Table 3-39 Functions Parameters

Field	View this
Position	Displays the parameter position.
Parameter	Displays the function parameter.
Description	Displays the function parameter description.

3.6.1.2 Elements

The Elements screen displays the predefined document elements retrieved from the database when the correspondence is generated.

In the Element Definitions section, you can update or edit only the Description field.

To view the Elements

1. Click **Setup > Setup > Administration > User > Correspondence > Line of credit > Elements**
2. On the **Element Definitions** screen, perform any of the [Basic Operations](#) mentioned in Navigation chapter. You cannot add a new record.

Figure 3-28 Correspondence_Line_Elements

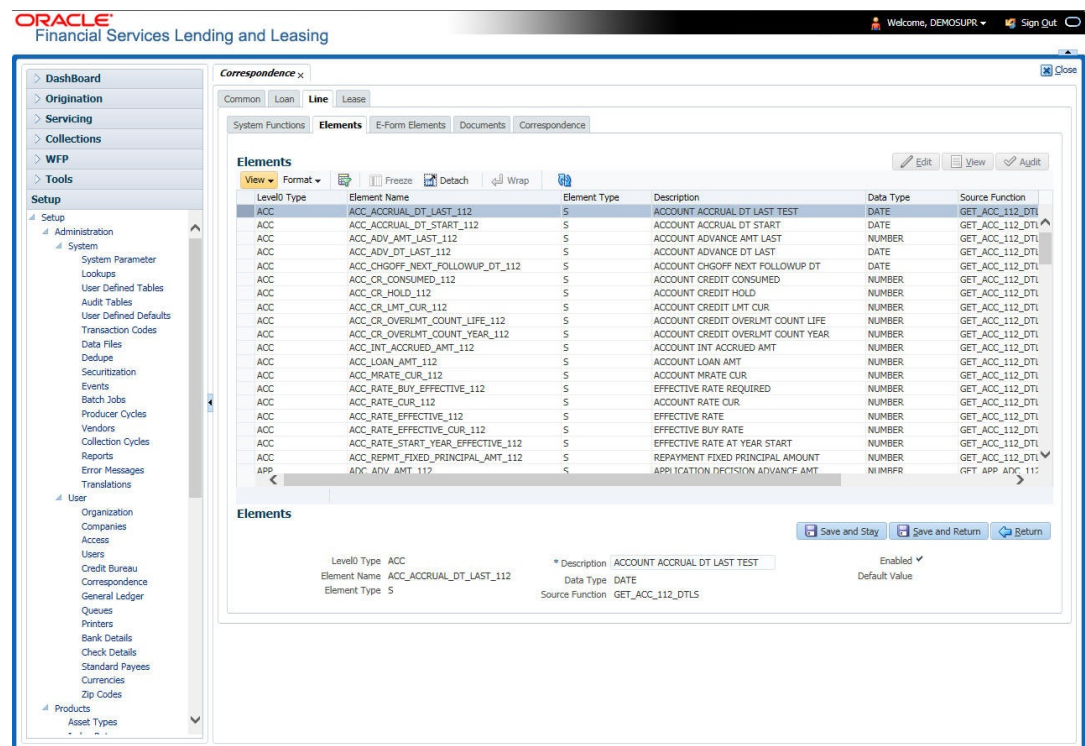

A brief description of the fields is given below:

Table 3-40 Element Definitions

Field	Do this
Level0 Type	Displays the element Level0 type.
Element Name	Displays the element name.
Element Type	Displays the element type.
Description	Specify the element description.
Data Type	Displays the element data type.
Source Function	Displays the element function.
Enabled	Displays if the element is enabled or not.
Default Value	Displays the default value.

3. Perform any of the [Basic Actions](#) mentioned in Navigation chapter.

3.6.1.3 E-Form Elements

The E-forms Elements screen defines elements included when the system generates online correspondence with a browser. The E-forms screen is set up only for PDF elements using the XFDF format. These definitions translate the external element required by the vendor to a systems correspondence element.

For example,

Table 3-41 E-Form Elements

Type	Details
Vendor Element	AllBorrowers.FullNameStreetCityStateZip (Contains names of all borrowers with address of primary customer)
The system's Elements	PRIM_APL_NAME SPOUSE_APL_NAME PRIM_APA_ADDRESS1 PRIM_APA_ADDRESS2 PRIM_APA_ADDRESS3
Translation	PRIM_APL_NAME ',' SPOUSE_APL_NAME ' ' PRIM_APA_ADDRESS1 ';' PRIM_APA_ADDRESS2 ';' PRIM_APA_ADDRESS3

To setup the E-forms Elements

1. Click **Setup > Setup > Administration > User > Correspondence > Line of credit > E-Form Elements**.
2. In the **E-form Elements Definitions** section, perform any of the [Basic Operations](#) mentioned in Navigation chapter.

Figure 3-29 Correspondence - E-Form Elements

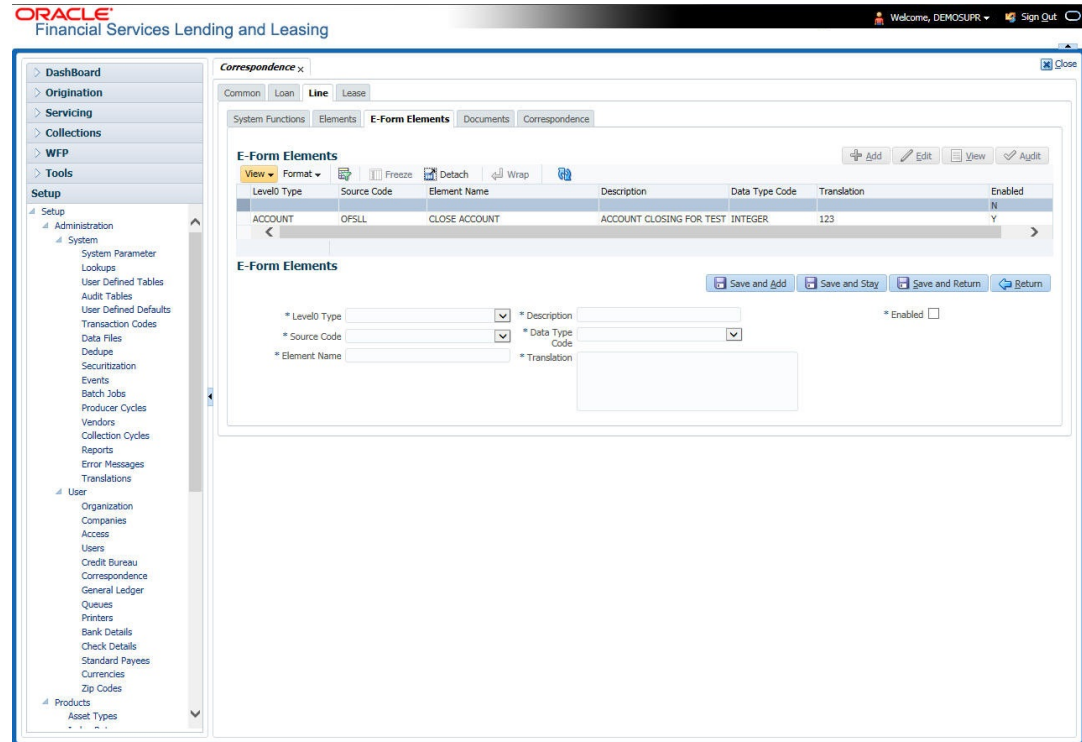

A brief description of the fields is given below:

Table 3-42 E-form Elements Definitions

Field	Do this
Level0 Type	Select the element Level0 type from the drop-down list.
Source Code	Select the element e-form source code from the drop-down list.
Element Name	Specify the element name (the name used in the external form).
Description	Specify the element description.
Data Type Code	Select the element data type code from the drop-down list.
Translation	Select the translation for the e-form element (SQL statement fragment defining the element data), from the drop-down list.
Enabled	Check this box to enable the e-form element.

3. Perform any of the [Basic Actions](#) mentioned in Navigation chapter.

3.6.1.4 Documents

The Documents screen enables you to set up the various documents and the data fields that the system compiles together when creating a correspondence. The system provides two different document formats: Word or XFDF: XML-based form.

Note

Oracle Financial Services Software assumes that the user is familiar with Word and the Merge Document command. If the user is creating e-form documents with XFDF, then Oracle Financial Services Software assumes that person is familiar with Adobe forms.

To setup documents to be compiled in correspondence

1. Click **Setup > Setup > Administration > User > Correspondence > Line of credit > Documents**.
2. In the **Document Definition** section, perform any of the [Basic Operations](#) mentioned in Navigation chapter.

Figure 3-30 Correspondence - Documents

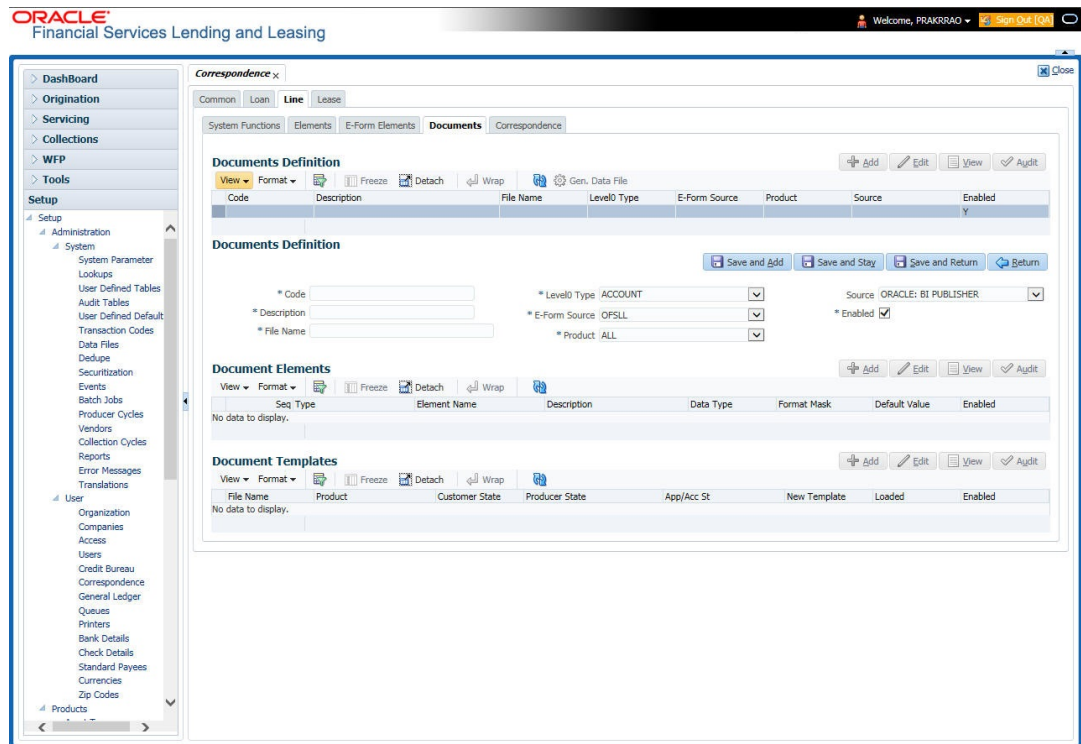

A brief description of the fields is given below:

Table 3-43 Document Definition

Field	Do this
Code	Specify the document code to define the name for the new document.

Table 3-43 (Cont.) Document Definition

Field	Do this
Description	Specify the document description for the new document. This entry appears in the Correspondence section on the Request screen, when you generate an ad hoc correspondence.
File Name	Specify the document file name for the resulting file (Word or XFDF document). Ensure that the name specified here is same as the BIP Template name since system refers to this file name for generating the correspondence.
Level0 Type	Select the level0 type from the drop-down list.
E-form Source	Select the element e-form source from the drop-down list.
Product	Select the document product from the drop-down list.
Source	Select the document source type from the drop-down list.
Enabled	Check this box to enable the document definition.

3. Perform any of the [Basic Actions](#) mentioned in Navigation chapter.
4. In the **Document Elements** section, perform any of the [Basic Operations](#) mentioned in Navigation chapter.
A brief description of the fields is given below:

Table 3-44 Document Elements

Field	Do this
Seq	Specify the sequence number to order the document elements.
Type	Select element type from the following from the drop-down list. This list provides the following options: System-defined – If you select, the value is supplied by the system and cannot be changed in the Correspondence Request screen. Constant. User Defined Element – If you select, you can choose the value and change it in the Correspondence Request screen. User Defined Constant – If you choose, you can choose the value, but you cannot change it in the Correspondence Request screen. Translated Element – If a document contains an e-form element and you do not select this option, then the value will not be translated.
Element Name	Select the element name from the drop-down list.

Table 3-44 (Cont.) Document Elements

Field	Do this
Description	Specify element description. Notes: 1. Check that the element name does not have blank spaces or special characters, such as the forward slash "/" or backward slash "\". 2. If the element is system-defined, then the system will automatically complete this field.
Data Type	Select the element data type from the drop-down list.
Format Mask	Select the element format mask from the drop-down list.
Default Value	Specify the element default value.
Enabled	Check this box to include the element in the document.

5. Perform any of the [Basic Actions](#) mentioned in Navigation chapter.
6. In the **Document Template** section, you can set the information about the template which is attached to the correspondence documents. The template thus saved is similar to the template functionality available in MS word. Perform any of the Basic Operations mentioned in Navigation chapter.
A brief description of the fields is given below:

Table 3-45 Document Template

Field	Do this
File Name	Specify the file name to define the name for the new template.
Product	Select the product for which the template is valid, from the dropdown list.
Customer State	Select the customer state for which the product is valid, from the drop-down list.
Producer State	Select the Producer state for which the product is valid, from the drop-down list.
App/Acc St	Select the Applicant/Account state for which the product is valid, from the drop-down list.
New Template	Check this box to load the template as a new template.
Loaded	Check this box to indicate that the template is loaded.
Enabled	Check this box to enable the template.

Note

You can define multiple templates for each document and the template file name (BIP template) is picked based on following criteria – Product and Producer / Account / Customer State.

7. Perform any of the [Basic Actions](#) mentioned in Navigation chapter.

The Document Elements sub screen records the system's application or account information that appears in the ad hoc correspondence.

To generate a data file for a document

1. In the **Document Definition** section of **Setup > Setup > Administration > User > Correspondence > Line of credit > Documents**, select the record for which you want to generate a data file.
2. Click **Gen. Data File** button.
The system displays a new screen with the following options:

Figure 3-31 Generate a data file

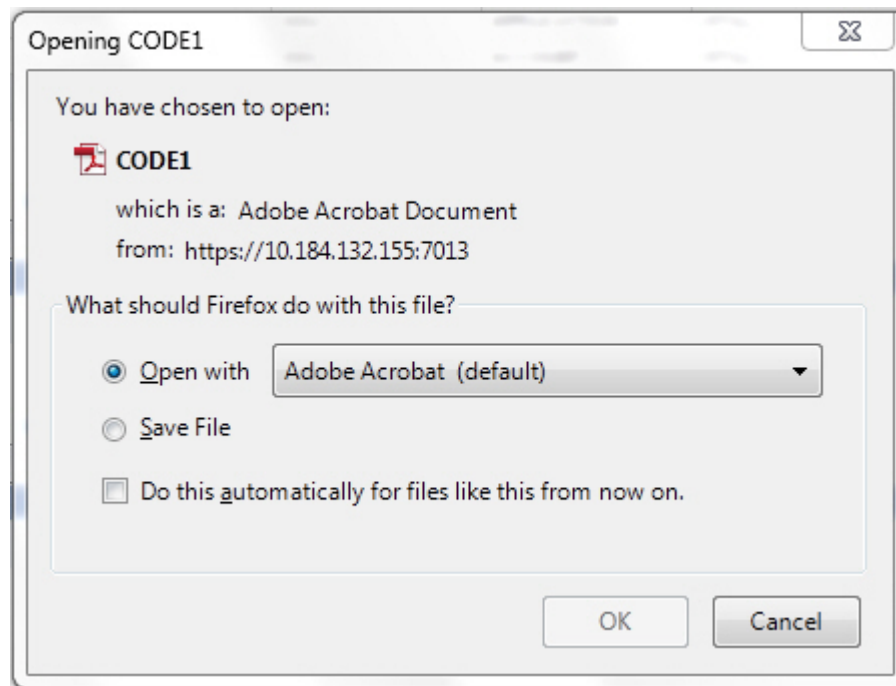

- **Open with** – Select to view the data file in the format you want. The adjacent drop-down list provides a list of formats compatible with the system. The system downloads the file and displays it.
 - **Save File** – Select to save the data file on your system.
3. Check the box **Do this automatically for files like this from now on** to apply selected properties for the files which are similar to the current one.

3.6.1.5 Correspondence

The Correspondence screen enables you to define who will receive the documents you created on the Document Definition screen by creating correspondence sets. Each document must belong to a set, and a set can have more than one document.

To set up a correspondence set

1. Click **Setup > Setup > Administration > User > Correspondence > Line of credit > Correspondence**. The correspondence setup is classified into two:
 - Documents

- Functions
2. In the **Correspondence** section, perform any of the [Basic Operations](#) mentioned in Navigation chapter.

Figure 3-32 Correspondence

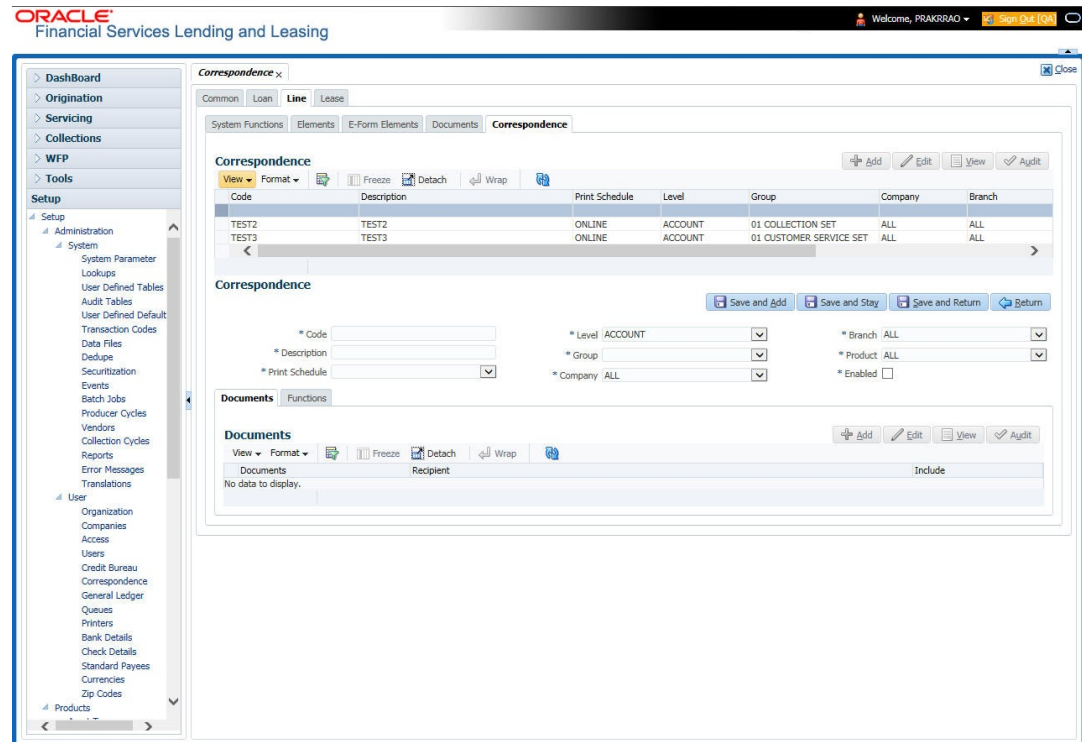

A brief description of the fields is given below:

Table 3-46 Set up a correspondence set

Field	Do this
Code	Specify the correspondence code.
Description	Specify the correspondence description (required).
Print Schedule	Select the correspondence output schedule type from the dropdown list.
Level	Select the correspondence level type from the drop-down list.
Group	Select correspondence group from the drop-down list.
Company	Select the correspondence company from the drop-down list.
Branch	Select the correspondence branch from the drop-down list.
Product	Select the correspondence product from the drop-down list.
Enabled	Check this box to enable the correspondence.

3. Perform any of the [Basic Actions](#) mentioned in Navigation chapter.
4. Click **Setup > Setup > Administration > User > Correspondence > Line of credit > Correspondence > Documents**.
5. In the **Documents** section, perform any of the [Basic Operations](#) mentioned in Navigation chapter.
A brief description of the fields is given below:

Table 3-47 Documents

Field	Do this
Document	Select the correspondence document from the drop-down list.
Recipients	Select the recipients for the document from the drop-down list.
Enabled	Check this box to enable the recipient selected.

6. Perform any of the [Basic Actions](#) mentioned in Navigation chapter.
7. Click **Setup > Setup > Correspondence > Line of credit > Correspondence > Functions**.
8. In the **Functions** sub screen, you can define the functions that should be executed before or after correspondence is generated. Perform any of the [Basic Operations](#) mentioned in Navigation chapter.
A brief description of the fields is given below:

Table 3-48 Functions

Field	Do this
Function	Select the correspondence functions from the drop-down list.
Execute When?	Select when to execute the correspondence function from the drop-down list.

9. Perform any of the [Basic Actions](#) mentioned in Navigation chapter.

3.6.2 Creating Correspondence

1. To create a correspondence add a record in the document definition block. For example: SAMPLE_LOAN_APP
2. In the **Document Elements** section, add the elements required in the correspondence.
3. Click on **Gen.Data File** to generate PDF file of the report.

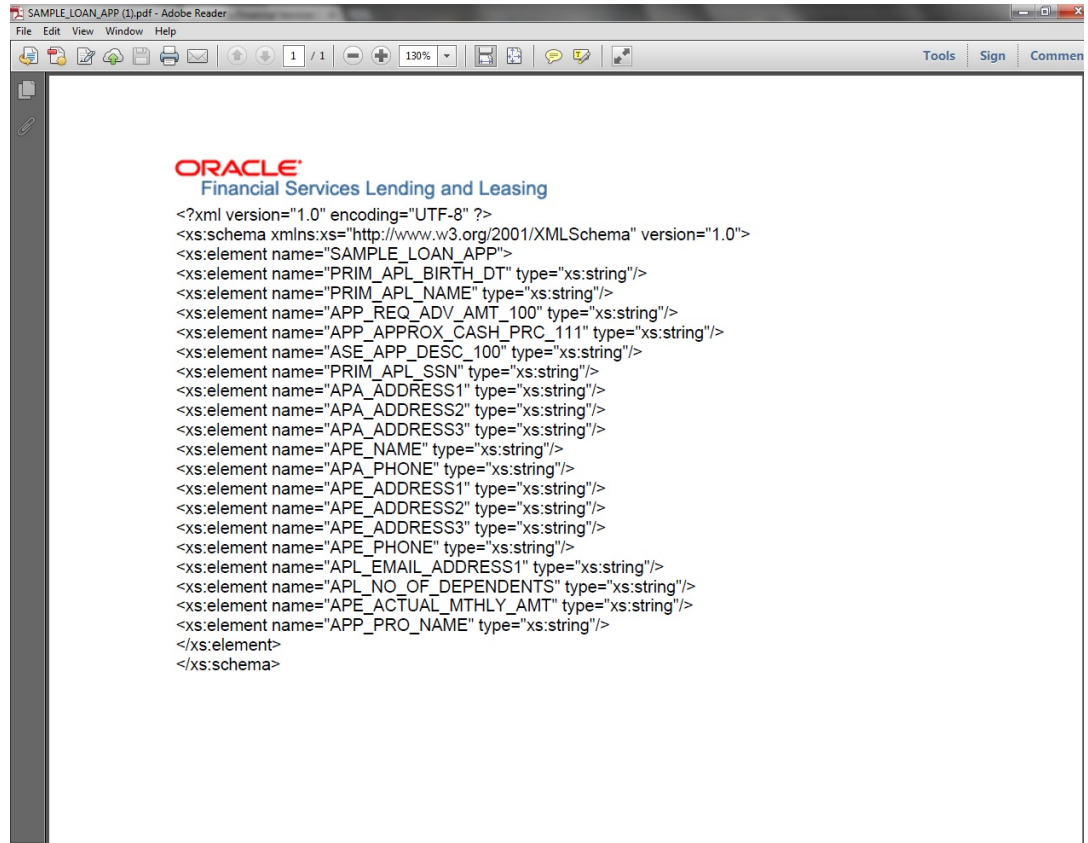
Figure 3-33 To generate PDF file of the report

4. Copy and save the content in the pdf file as an xml file. The saved xml file should have the same name as entered in the Code column of Document Definition section. For Example: SAMPLE_LOAN_APP.xml.
5. Open MS Word.

Note

Oracle Financial Services Software assumes that BIP Desktop Tool is installed and the user is familiar with the BIP Report Tool.

6. In BI Publisher Tab in MS Word, click on **Sample XML** and import the saved xml file. For Example: SAMPLE_LOAN_APP.xml.
7. Create the template by inserting required elements tag.

Figure 3-34 Creating Template

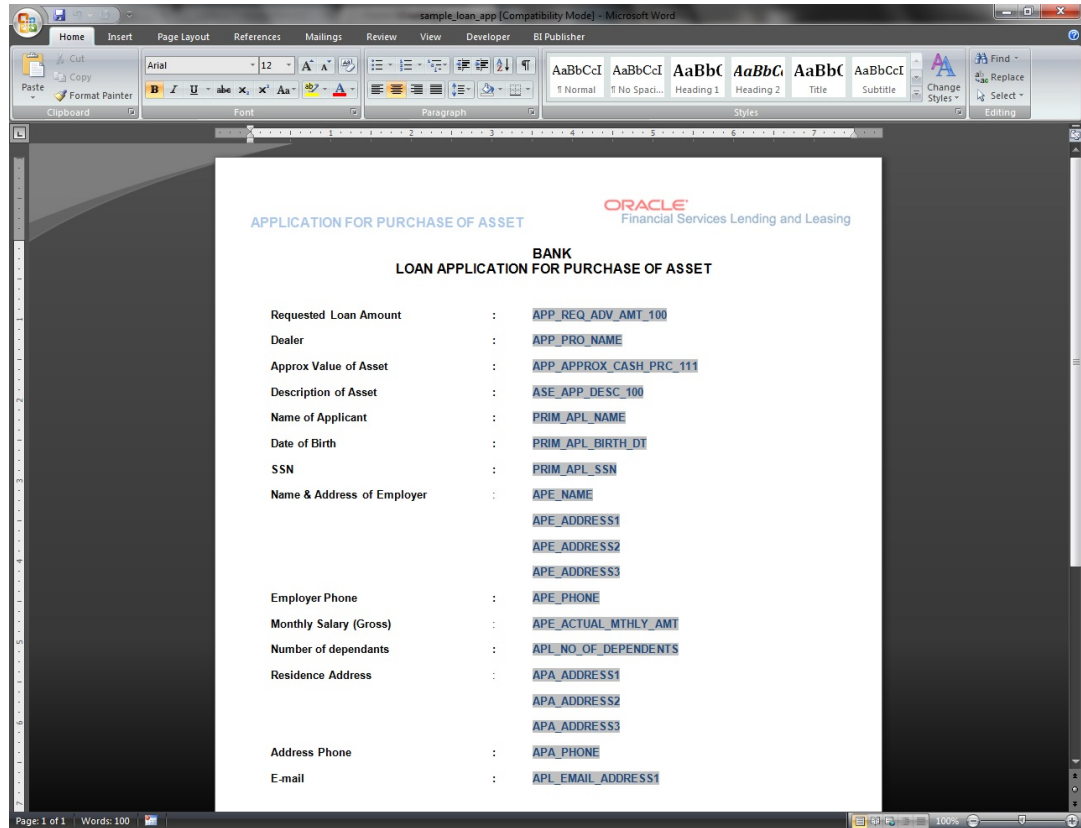

8. The template created in MS Word should be saved with .rtf extension. For Example: SAMPLE_LOAN_APP.rtf

Note

The .xml and .rtf file should be saved with the same name as entered in the **Code** column of Document Definition section.

9. Upload the rtf template in the BIP and create the data model with SQL query as `select CDO_XML_DOCUMENT from correspondence_docs where cdo_id = :docId.`
10. After the data model creation, launch the correspondence screen and click **Correspondence** tab.
11. You can setup a correspondence with the created doc.

3.6.3 Generating Correspondence

1. To generate a correspondence open the application for which the correspondence should be generated.
2. Click **Correspondence** tab. In the **Correspondence** section, click on **Add**.
3. Select the created **Correspondence**. Click **Save and Add** to save and add a new record. Click **Save and Return** to save and return to main screen. Click **Return** to return to main screen without modifications.

Figure 3-35 Correspondence

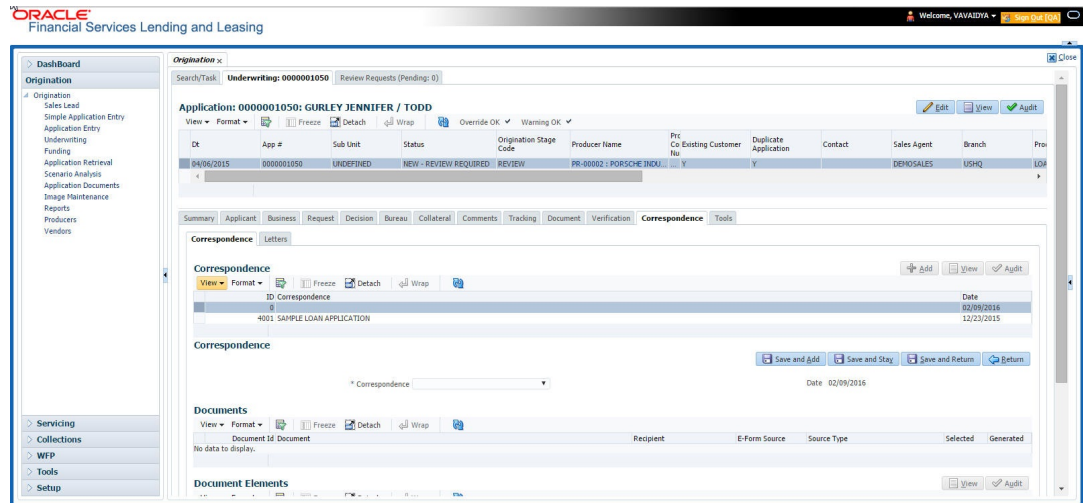

4. Click **Generate** to generate the selected correspondence and **View Correspondence** to view the Correspondence in PDF format.

Figure 3-36 Generated Correspondence

APPLICATION FOR PURCHASE OF ASSET		ORACLE Financial Services Lending and Leasing
BANK		
LOAN APPLICATION FOR PURCHASE OF ASSET		
Requested Loan Amount	:	20000.00
Dealer	:	
Approx Value of Asset	:	.00
Description of Asset	:	2005 TOYOTA CAMRY
Name of Applicant	:	ANDREW WATT
Date of Birth	:	07/15/1975
SSN	:	XXXXX2147
Name & Address of Employer	:	
		58, EAST 19TH STREET
		HOLTSVILLE NY 00544
Employer Phone	:	0
Monthly Salary (Gross)	:	552230.00
Number of dependants	:	0
Residence Address	:	34, WEST 69TH ST N BCH N
		NEW YORK MA 01730 US
Address Phone	:	0
E-mail	:	ANDREW.WATT@XYZ.COM
I declare that the information given in the application is true to the best of my knowledge and belief		
Signature of the Applicant _____		

3.7 Queues

When processing an application, various users might work on the application to complete different tasks. A data entry person might complete the Application Entry screen before an underwriter works on the application using the Applications screen. Later, another user might use the Applications screen to fund the application.

The application processing workflow facilitates the movement of the application from one person to another with queues. Queues create a work section of accounts waiting for a

particular and common task to be performed, such as application entry or verification. The system's powerful queuing module automates this otherwise manual process.

In the Queues setup screen, you can setup and manage workflow and work assignments on a daily basis to ensure that all applications are in the queues of the appropriate users at all times.

Any time an application's status is changed, the system checks whether the application is in the right queue.

The system will sort queues based on an application's status and sub status.

- [Origination Tab](#)
- [User Groups Tab](#)

3.7.1 Origination Tab

The Origination screen on the Queue Setup form allows you to set up queues that direct applications to users during the line of credit origination cycle. Origination queues are based on an application's status and sub status. Whenever an application changes its status/sub status, the system moves the application to a queue based on the information on this screen.

You can define the line of credit origination queues and the corresponding selection criteria based on:

- Application status
- Application sub status
- Product type
- Funding type
- Product
- Underwriter
- State
- Channel
- Producer type
- Producer

With line of credit origination queues set up, the applications in your work queue automatically appear on the Results screen when you open the Underwriting or Funding screen. The queue to which you are assigned appears in the Queue Name field. You would then begin processing the applications in the order of which they are listed, double-clicking the application at the top of the list to load it.

On the **Setup > Setup > Queues** screen, you can determine the direction of the applications to users who process them. Whenever there is a change in the status or sub status of the application, the system places the application in an appropriate queue based on the information available in this screen.

Applications are further filtered based on the following criteria:

- Selection Criteria
- Sort Order
- Responsibilities and Users
- Data Node Assignments

- Group Assignment

To setup Origination Queues

You can either define new Queue Definition details or specify a new name in the **New Queue** field and click **Create Copy** to create a copy of selected queue definition with header and child tab details (except Group Assignment tab).

1. On the Oracle Financial Services Lending and Leasing home screen, click **Setup > Setup > Queues > Origination**.
2. In the **Origination Definition** section, perform any of the [Basic Operations](#) mentioned in Navigation chapter.

Figure 3-37 Origination Definition

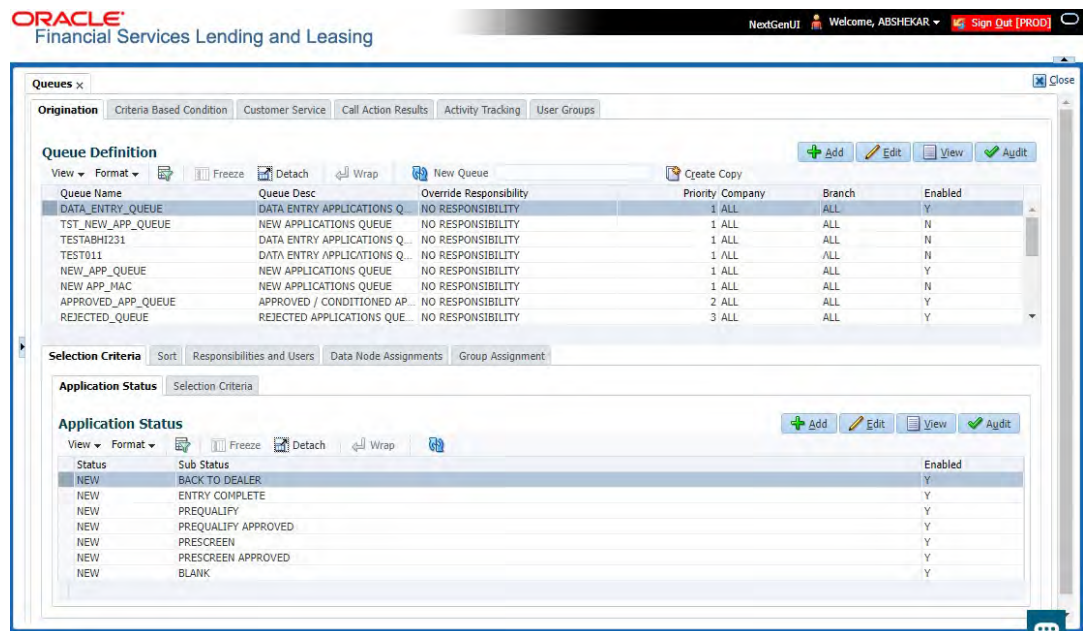

A brief description of the fields is given below:

Table 3-49 Origination Definition

Field	Do this
Queue Name	Specify queue name.
Queue Description	Specify queue description. Note: The system uses this entry when referring to the queue on other forms.
Override Responsibility	Select an override responsibility code from the drop-down list. The system uses this data to determine the User who holds the override responsibility for the specified queue, if an application triggers an override edit.

Table 3-49 (Cont.) Origination Definition

Field	Do this
Priority	Specify the priority number. The system sorts applications by the higher number. For example, an application with a priority # 5 is considered to have a higher priority than the one with a priority # 3.
Company	Select the company from the drop-down list.
Branch	Select the branch drop-down list.
Enabled	Check this box to enable the queue.

3. Perform any of the [Basic Actions](#) mentioned in Navigation chapter.

This section consists of the following topics:

- [Selection Criteria](#)
- [Sort](#)
- [Responsibilities and Users](#)
- [Data Node Assignments](#)
- [Group Assignment](#)

3.7.1.1 Selection Criteria

Here, you can further filter the applications in a particular queue. This criteria is generally used by organizations to categories and allocate large number of applications to different queues.

Note

If you want to execute search on like operators, then use %.

To setup Selection Criteria

1. Click **Setup > Setup > Queues > Origination > Selection Criteria > Application Status**.
2. In the **Application Status** section, use the **Status** and **Sub Status** fields to define the credit application status/sub status combinations that should be considered for the queue.
3. To setup, perform any of the [Basic Operations](#) mentioned in Navigation chapter. A brief description of the fields is given below:

Table 3-50 Setup Selection Criteria

Field	Do this
Status	Select application status from drop-down list.
Sub Status	Select application sub status drop-down list.
Enabled	Select the check box to enable the application status.

4. Perform any of the [Basic Actions](#) mentioned in Navigation chapter.

Note

All is the default value for each field.

5. Click **Setup > Setup > Queues > Origination > Selection Criteria > Selection Criteria**. In the **Selection Criteria** section, use the fields to define the credit application that should be considered for the queue.
6. To setup, perform any of the [Basic Operations](#) mentioned in Navigation chapter. A brief description of the fields is given below:

Table 3-51 Selection Criteria

Field	Do this
Product Type	Select the product type as line of credit from the drop-down list.
Funding Type	Select funding type from the drop-down list.
Product	Select product from the drop-down list.
State	Select state from the drop-down list.
Channel	Select channel from the drop-down list
Underwriter	Select underwriter from the drop-down list.
Producer Type	Select producer type from the drop-down list.
Producer Group	Select producer Group from the drop-down list
Producer	Select producer from the drop-down list.
Region	Select region of the producer from the drop-down list.
Territory	Select territory of the producer from the drop-down list.
Sales Agent	Select sales agent for the producer from the drop-down list.
Funder	Select funder for the producer from the drop-down list.

7. Perform any of the [Basic Actions](#) mentioned in Navigation chapter.

3.7.1.2 Sort

In the Sort sub tab of Queue Definition, the new applications which are in origination queue are displayed here based on sort criteria defined. In case of any overrides, applications would be sorted automatically without the need of a setup definition. However, there is no impact if sort is not defined for a queue.

To setup Sort Criteria

1. Click **Setup > Setup > Queues > Origination > Selection Criteria > Sort**.
2. In the **Sort** section, use the Seq, Sort field, and Order to rearrange the queue.
3. To setup, perform any of the [Basic Operations](#) mentioned in Navigation chapter. A brief description of the fields is given below:

Table 3-52 Setup Sort Criteria

Field	Do this
Seq	Specify the sequence number representing the sorting priority.
Sort Field	Select the sort criteria from the list of parameters available in the dropdown list.
Order	Select either ascending or descending as the sort order.

4. Perform any of the [Basic Actions](#) mentioned in Navigation chapter.

3.7.1.3 Responsibilities and Users

1. Click **Setup > Setup > Queues > Origination > Responsibilities and Users**.
2. In the **Responsibilities** section, use the **Responsibilities** field to define the responsibilities roles which are authorized to work on the queues.
3. To setup, perform any of the [Basic Operations](#) mentioned in Navigation chapter. A brief description of the fields is given below:

Table 3-53 Responsibilities and Users

Field	Do this
Responsibility	Select the responsibility from the drop-down list.
Enabled	Check this box to enable the responsibility.

4. Perform any of the [Basic Actions](#) mentioned in Navigation chapter.
5. In the **Users** section, use the **User** field to define the users who are authorized to work on the queue.
6. To setup, perform any of the [Basic Operations](#) mentioned in Navigation chapter. A brief description of the fields is given below:

Table 3-54 Users

Field	Do this
User	Select user from the drop-down list.
Enabled	Check this box to enable.

7. Perform any of the [Basic Actions](#) mentioned in Navigation chapter.

3.7.1.4 Data Node Assignments

Data node Assignments provides user with the flexibility to view the tabs in origination. User will have option to enable/disable Tabs. All the enabled tabs will be displayed when application is in that particular queue. Disabled tabs for the tabs will not be shown when applications is in respective queue.

For example: Application entry Queue

If summary tab to be disabled, the search for the ULN Summary tab and Disable. IN application Entry summary will not be shown.

1. Click **Setup > Setup > Queues > Origination > Node Assignments**. You can enable the administrator to configure the User interface nodes that should be made available for the applications that are being processed in that particular origination queue.
2. In the **Node Assignments** section, perform any of the [Basic Operations](#) mentioned in Navigation chapter.
A brief description of the fields is given below:

Table 3-55 Node Assignments

Field	Do this
Node	Select the node from the drop-down list.
Enabled	Check this box to enable the record.

3. Perform any of the [Basic Actions](#) mentioned in Navigation chapter.
4. Click **Load Queue Nodes** to display the respective UI nodes in the origination module.

3.7.1.5 Group Assignment

The Group Assignment sub tab allows you to add user groups to Origination Queue.

Note

Modification of user details (adding or disabling users) within a user group which is added to Group Assignment will implicitly be updated in Responsibilities and Users tab also.

To add User Group to Group Assignment

1. On the Oracle Financial Services Lending and Leasing home screen, click **Setup > Administration > User > Queues > Origination > Group Assignment**.
2. In the **User Group** section, Click **Add**. You can also perform any of the [Basic Operations](#) mentioned in Navigation chapter.
A brief description of the fields is given below:

Table 3-56 User Group

Field	Do this
Group Name	Select the user group name from the drop-down list. The list displays the pre-defined user groups available in the system.
Enabled	Check this box to enable the user group.

3. Perform any of the [Basic Actions](#) mentioned in Navigation chapter.

3.7.2 User Groups Tab

The User Groups tab in Queues is a centralized repository which allows you to define user groups, add and remove users from user groups.

The User Groups tab consists of User Group Definition section listing the defined User Groups and User section below listing the associated users of the selected User Group.

Figure 3-38 User Groups

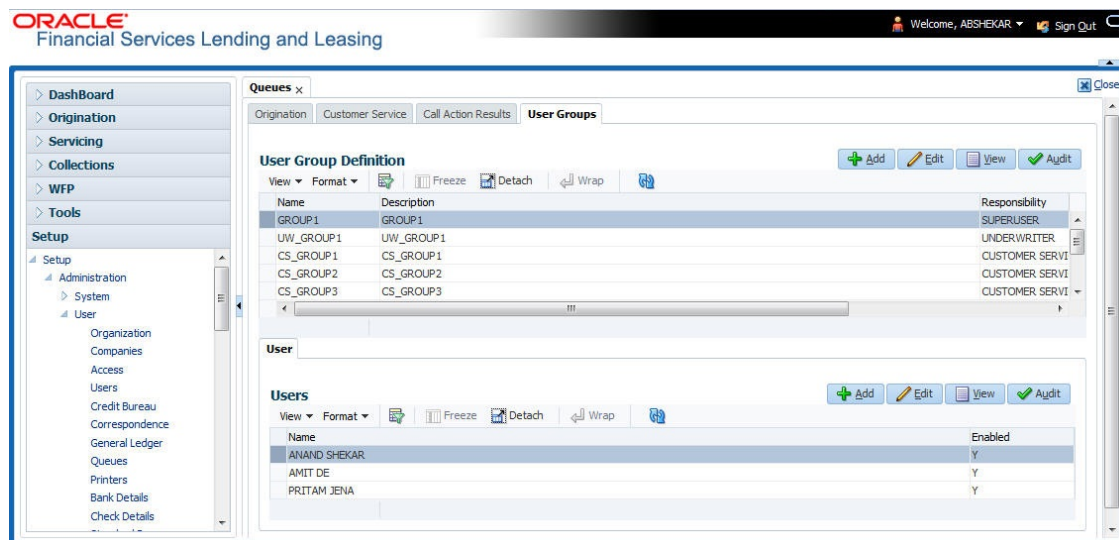

To define a User Group

1. On the Oracle Financial Services Lending and Leasing home screen, click **Setup > Administration > User > Queues > User Groups**.
2. In the **User Groups** section, Click **Add**. You can also perform any of the [Basic Operations](#) mentioned in Navigation chapter.
A brief description of the fields is given below:

Table 3-57 User Groups

Field	Do this
Name	Specify user group name.
Description	Specify an appropriate user group description. The same is used while referring this User Group on other screens.
Responsibility	Select the responsibility of the user group from the drop-down list. You can later add only those Users who have the selected responsibility into the user group.
Enabled	Check this box to enable the user group.

3. Perform any of the [Basic Actions](#) mentioned in Navigation chapter.

To add Users to User Group

1. On the Oracle Financial Services Lending and Leasing home screen, click **Setup > Administration > User > Queues > User Groups**.
2. In the **User Groups** section, select the required User Group.
3. In the **Users** section, Click **Add**. You can also perform any of the [Basic Operations](#) mentioned in Navigation chapter.
A brief description of the fields is given below:

Table 3-58 Users

Field	Do this
Name	Select the user from the drop-down list. The list displays the available users based on the responsibility defined for the user group.
Enabled	Check this box to enable the user.

4. Perform any of the [Basic Actions](#) mentioned in Navigation chapter.

3.8 Printers

The Printers screen allows you to set up an unlimited number of network printers and fax devices to be used with the system server. The system uses the information on this screen while selecting a printer, when the printing process involves a batch job or uses a job scheduler. Examples include printing reports and correspondence.

The printers and fax devices can be set up at each organization, division, or department to promote efficient printing of documents, and reports. The system uses this information during product setup and on the Letters screen in the **Batch Printer** field.

Special printer names

The following printer names are predefined and have specific functions within the system:

Table 3-59 Printer names

Name	Description
UNDEFINED	Indicates that the document to be printed is to be previewed in your browser instead of actually printing the document.
ARCHIVE	Instead of sending an item to the printer, the system generates a PDF document and saves it in the archive directory on your server.
EMAIL	For Line of Credit origination correspondences that can be faxed, the system e-mails the document as a PDF attachment to the consumer for direct Line of Credit or to the producer in the case of in-direct Line of Credit.
FAX	For Line of Credit origination correspondences that can be faxed, the system generates a PDF document and will send to the fax server defined in System Parameters.

Additionally, you may set up composite entries in the Printer Name field to perform two or more functions at the same time. This can be done by defining a printer name with the following format:

```
PRINTER_NAME = <PRINTER_NAME1> + <PRINTER_NAME2>
```

For example, if a printer named JET4050 was previously defined, as were the special printer names listed above, then the following additional printers could be defined:

Table 3-60 Additional printers

Name	Description
JET4050+ARCHIVE	Prints the document with the jet4050 printer and archives the document.
FAX+ARCHIVE	Faxes and archives the document.
EMAIL+ARCHIVE+JET4050	E-mails, archives, and prints the document with the jet4050 printer.

To set up the Printers

1. Click **Setup > Setup > Administration > User > Printers**. The system displays the Printers screen.
2. In the **Printers** section, perform any of the [Basic Operations](#) mentioned in Navigation chapter.

Figure 3-39 Printers

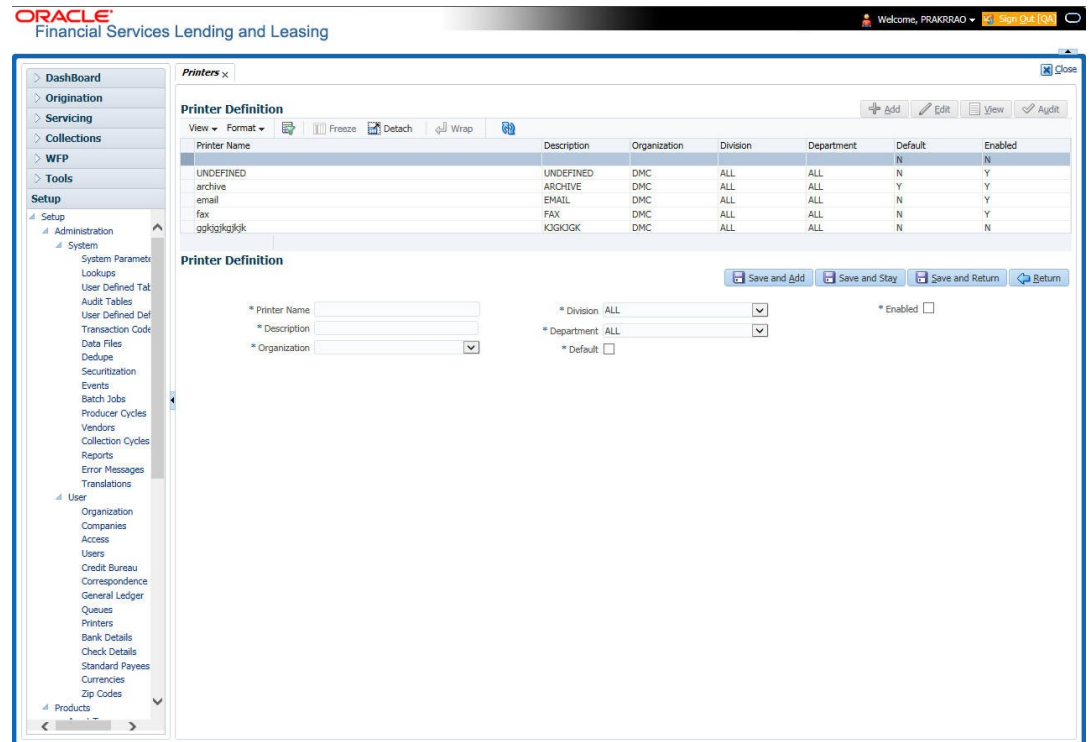

A brief description of the fields is given below:

Table 3-61 Printers

Field	Do this
Printer Name	Specify the printer name. The name of the printer as defined by the server. For a UNIX server, the name might be JET4050, while to access the same printer from a Windows server the name would be: \\servername\jet4050.
Description	Specify the description for the printer.
Organization	Select the organization to which the printer belongs, from the dropdown list.
Division	Select the division to which the printer belongs, from the drop-down list. The division will be displayed based on the organization selected.
Department	Select the department to which the printer belongs, from the drop-down list. The department will be displayed based on the division selected. IMPORTANT: When you select a printer to use, the system searches for a best match using the following attributes: <ol style="list-style-type: none"> 1. Organization 2. Division 3. Department Hence, Oracle recommends creating a version of each edit, where ALL is the value in these fields. It is also recommended that, you define a default printer for an Organization, Division and Department.
Default	Check this box to set the printer as a default printer.
Enabled	Check this box to enable the printer and that the printer is active. Note: Never disable the UNDEFINED printer

3. Perform any of the [Basic Actions](#) mentioned in Navigation chapter.

3.9 Intelligent Segmentation

OFSLL is equipped to leverage the Machine Learning (ML) feature of Oracle Database to suggest and create Customer Servicing Queues by analysing the current system data. Using this functionality, system automatically identifies the possible Queue/Segmentation for Account data using the Machine Learning Algorithm thereby creating an Intelligent Segmentation.

This helps to automate the manual process of queue creation which is otherwise done by identifying different segments of Accounts and assigning day to day Customer Service Activities. Further queue processing workflow continues as detailed in [Queues](#) section.

- [Machine Learning for Queue Creation](#)
- [Machine Learning Data visualization](#)
- [View Machine Learning Generated Queue](#)
- [Create ML Based Queue](#)

3.9.1 Machine Learning for Queue Creation

The Intelligent Segmentation screen in OFSLL is based on the Oracle JavaScript Extension Toolkit (Oracle JET) framework. This facilitates to identify different clusters of data and create queues.

In order to access the Intelligent Segmentation screen from the User Interface menu link, you need to enable the system parameter FLL_SET_JET_INTELLIGENTSEG_URL (JET INTELLIGENT SEGMENTATION URL). For more details on installing and deploying this feature in OFSLL, refer to Installation Manual.

Note

The input data for Machine Learning (ML) data set cluster creation is provided by the Batch Job QMLPRC_BJ_100_03 (ML DATASET CREATION FOR INTELLIGENT SEGMENTATION) available in batch job set SET-QCS.

In this screen, you do the following:

Figure 3-40 Intelligent Segmentation - Workflow



- Identify Cluster of Data for a given Account Condition.
- View hierarchy of cluster and list of accounts falling into different levels of cluster.
- Create a queue by selecting Cluster.

3.9.2 Machine Learning Data visualization

The data generated by the system is represented in the following view formats.

- [Cluster view](#)
- [Segment View](#)
- [Insights View](#)
- [Selection Criteria Attributes](#)

3.9.2.1 Cluster view

Figure 3-41 Cluster view

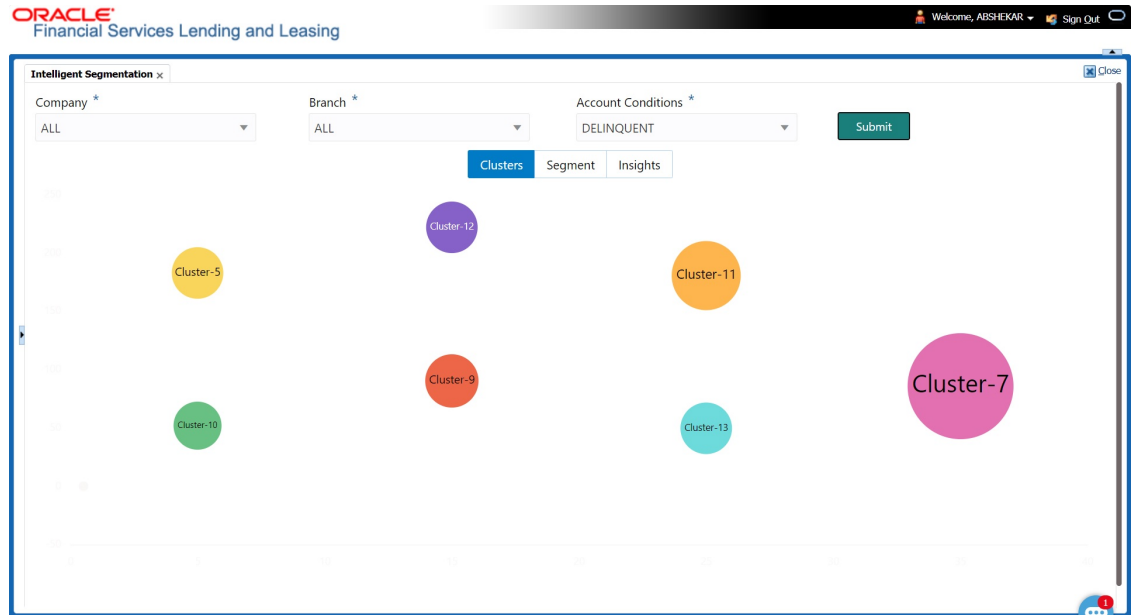

3.9.2.2 Segment View

Figure 3-42 Segment View

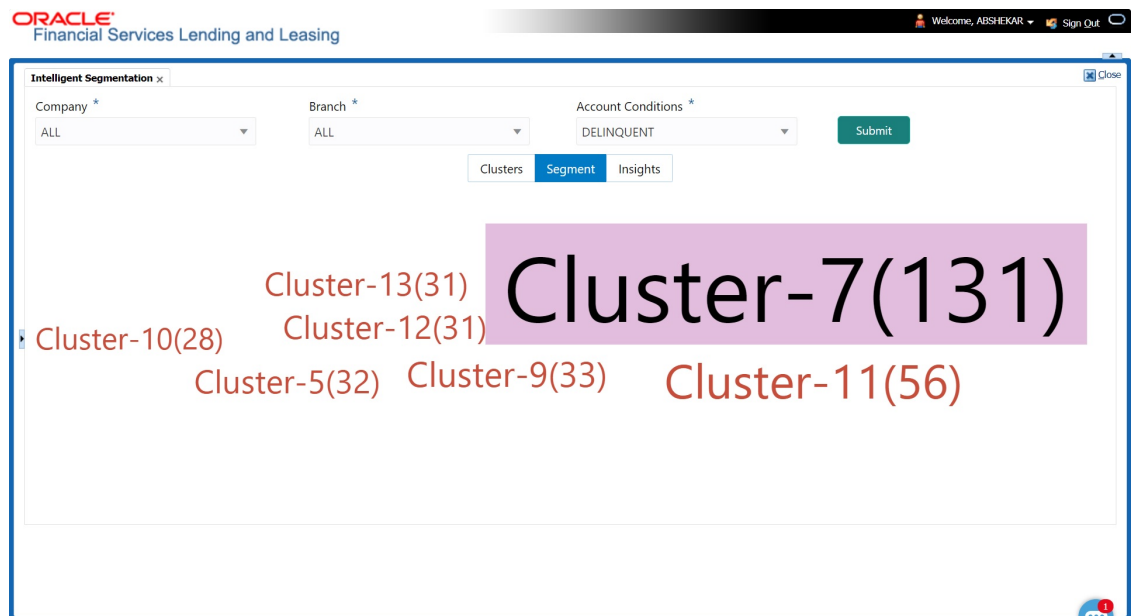

3.9.2.3 Insights View

Figure 3-43 Insights View

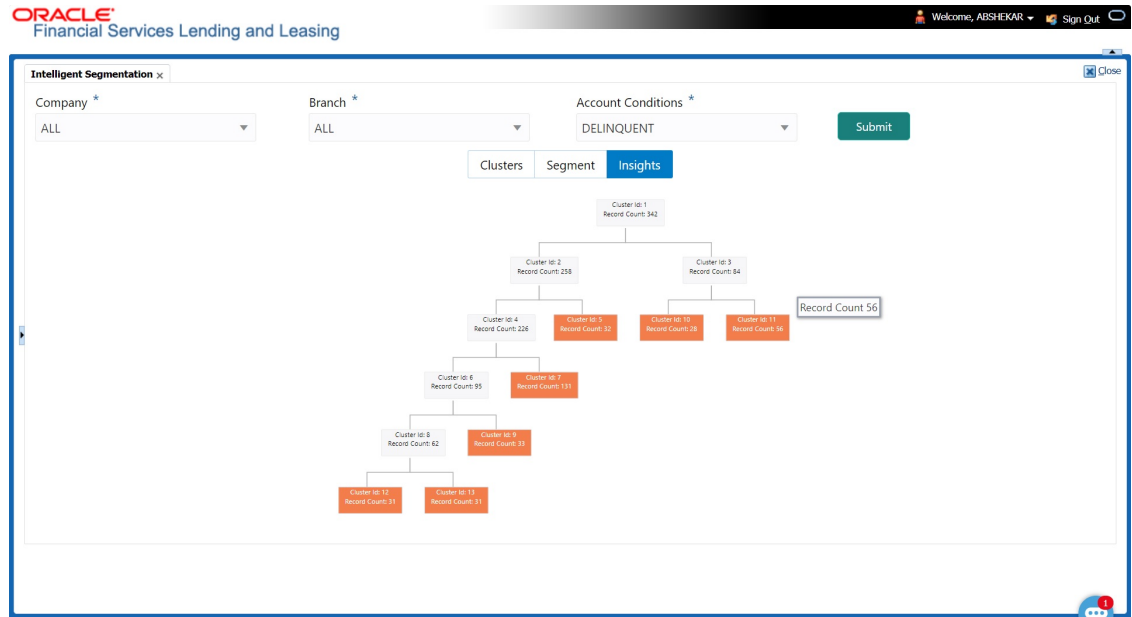

3.9.2.4 Selection Criteria Attributes

Clicking on any of the data segment system displays dynamic record details (Attribute Name and Attribute Value) along with the option to create queue.

Figure 3-44 Selection Criteria Attributes

Records of Cluster - 7 ×

Create

ATTRIBUTE_NAME	ATTRIBUTE_VALUE
ACC_COLLATERAL_TYPE_CD	HOME
ACC_DLQ_CATEGORY	180
ACC_DLQ_DAYS	211.857 to 392.714
ACC_DUE_TOTAL_AMT	0 to 29612.1
ACC_OUTSTANDING_TOTAL_AMT	-10985 to 62604.5

3.9.3 View Machine Learning Generated Queue

To view ML based queue

1. Click **Setup > Setup > Administration > User > Intelligent Segmentation**. The following screen is displayed:

Figure 3-45 View Machine Learning Based Queue

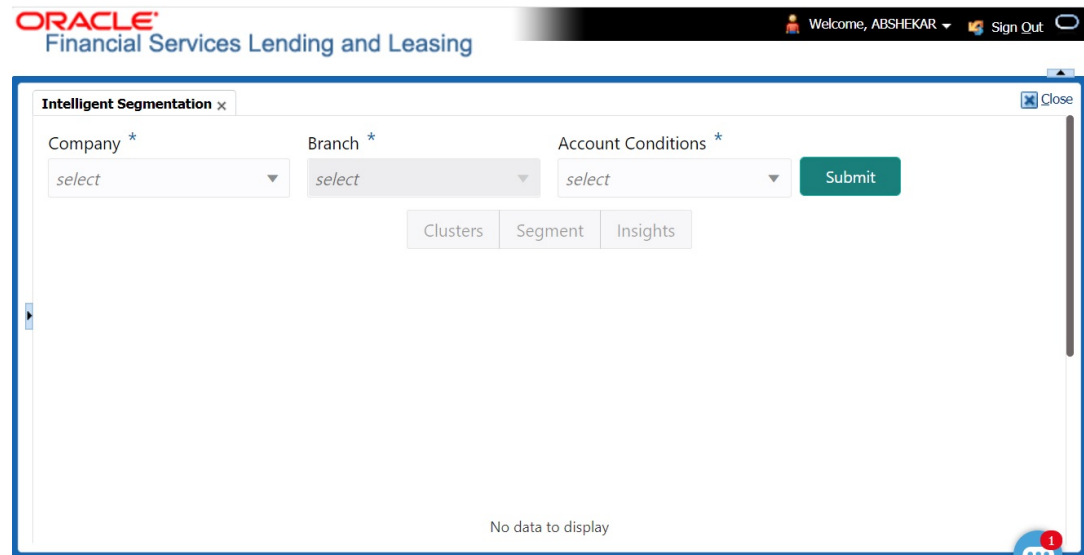

2. Select the following option:

Table 3-62 View Machine Learning Generated Queue

Field	Do this
Company	Select the company from the drop-down list. The list is populated only with those Company Definitions to which you have been provisioned access.
Branch	Select the branch within the company from the drop-down list. This may be ALL or a specific branch. This must be ALL, if you have selected ALL in the Company field.
Account Conditions	Select the required account conditions. There are various Account Conditions which are either posted automatically by the system (like updating DELQ delinquency condition on account) or manually through a transaction or call activity.

3. Click **Submit**. System generates different data segments based on above selected combination using a background job process. By default, the data is represented in clusters and can be viewed on other view formats as detailed in [Machine Learning Data visualization](#) section.

3.9.4 Create ML Based Queue

On generating the data segments in the Intelligent Segmentation screen, you can further drill down to each cluster and view details with different selection criteria. However, the details of each record is based on the data maintained in the system.

Table 3-63 Create ML Based Queue

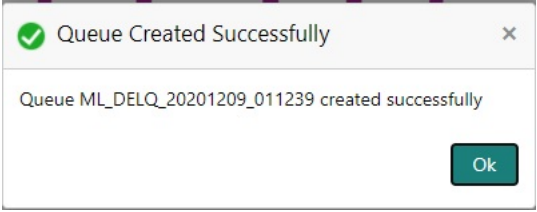
Button	Action
Create	<p>Clicking on this option creates a Queue in OFSLL and the selection criteria of the Queue is populated with the Cluster Attributes. The queue sequence is based on Queue name/Description and is displayed as a confirmation message in the format Queue ML <Account Condition > <Date YYYYMMDD > <Time HHMMSS> created successfully.</p>  <p>The newly created queue is available in Setup > Administration > User > Queues screen.</p>

Note that following with ML generated Queues:

- All Queues are created in **Disabled** status with Selection Criteria **Enabled**.
- Priority is defaulted to 0.
- Company/Branch is defaulted to selected combination.
- Hard Assigned/Group Follow-up/Near Real-Time/Dialler actions are marked as disabled.

3.10 Bank Details

The Banks screen defines the banks, a company/branch uses for processing Automatic Clearing House (ACH) and lock box payments.

Note

This is **behind the scenes** information that the system uses for payments and does not appear on any other forms.

To set up the Banks

1. Click **Setup > Setup > Administration > User > Bank Details** link. The system displays the Bank Details screen.
2. In the **Banks Definition** section, perform any of the [Basic Operations](#) mentioned in Navigation chapter.

Figure 3-46 Banks Definition

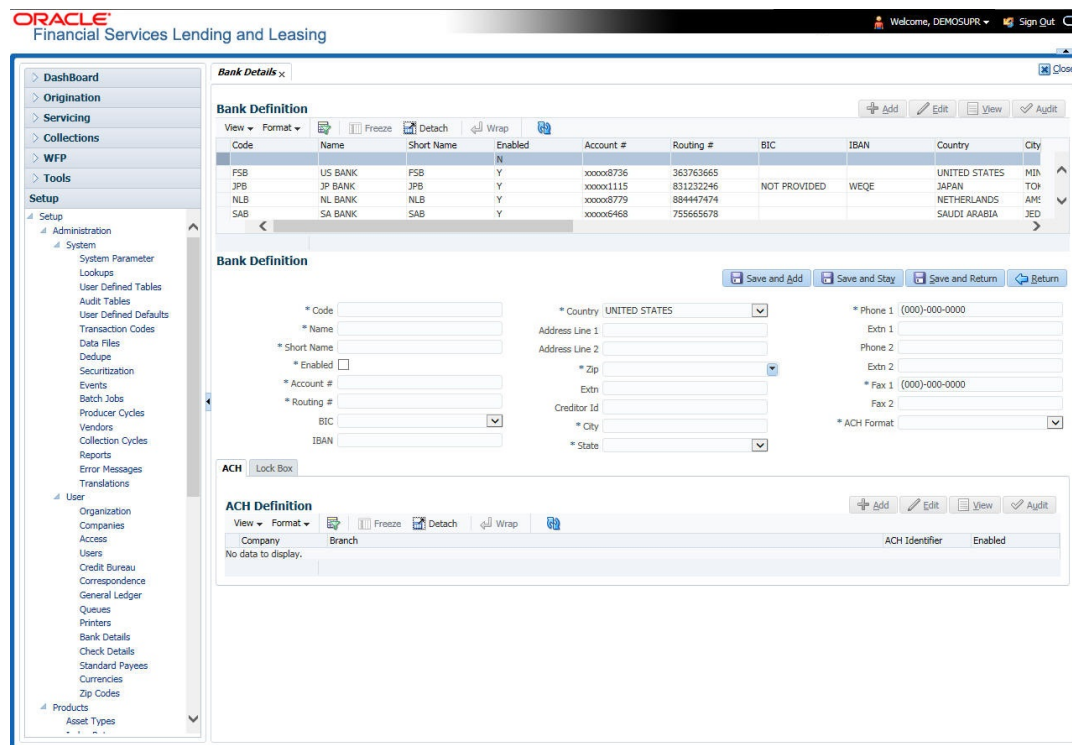

A brief description of the fields is given below:

Table 3-64 Banks Definition

Field	Do this
Code	Specify the bank code (ID used internally by Oracle Financial Services Lending and Leasing to represent the bank).
Name	Specify the name for the bank.
Short Name	Specify the short name for the bank (ID displayed to represent the bank. This may be included in any output files).
Enabled	Check this box to enable and indicate this as an active bank
Account #	Specify the account number used for banking transactions with the bank. Note: If the organizational parameter <code>UIX_HIDE_RESTRICTED_- DATA</code> is set to Y, this appears as a masked number; for example, XXXXX1234.
Routing #	Specify the routing number of the bank.
BIC	Select the Business Identifier Code from the drop-down list. The list displays the BIC codes defined in the system.

Table 3-64 (Cont.) Banks Definition

Field	Do this
IBAN	<p>Specify the IBAN (International Bank Account Number). IBAN is used for identifying bank accounts across national borders with a minimal of risk of propagating transcription errors.</p> <p>Ensure that value entered satisfies the check-digit validation based on modulo 97. On save, system automatically validates the IBAN number length based on country code, characters, white spaces, and checksum. Validation is also done during posting non-monetary transaction (ACH Maintenance).</p> <p>You can maintain the IBAN length and other details required as per the country code in the user defined table (Setup > Administration > System > User Defined Tables).</p> <p>Note: IBAN for NL country code (IBAN_FORMAT_NL) is defined by default with length of IBAN as 18.</p>
Country	Select the country where the bank is located, from the drop-down list.
City	Specify the city where the bank is located.
State	Select the state where the bank is located, from the drop-down list.
Address Line 1	Specify the address line 1 for the bank.
Address Line 2	Specify the address line 2 for the bank.
Zip	Specify the zip code where the bank is located, from the drop-down list.
Extn	Specify the extension of the zip code where the bank is located.
Creditor Id	Specify the creditor identification details.
Phone 1	Specify the primary phone number of the bank.
Extn 1	Specify the phone extension for the primary phone number.
Phone 2	Specify the alternate phone number for the bank.
Extn 2	Specify the phone extension for the alternate phone number.
Fax 1	Specify the primary fax number for the bank.
Fax 2	Specify the alternate fax number for the bank.
ACH Format	<p>Select the ACH format accepted by this bank from the drop-down list. The list displays the following options:</p> <ul style="list-style-type: none"> • NACHA Format • SEPA Format

3. Perform any of the [Basic Actions](#) mentioned in Navigation chapter.
4. Click **Setup > Setup > Administration > User > Bank Details > ACH**.
5. On the **ACH Definition** sub screen, you can create ACH files for the bank listed in the Banks section. Perform any of the [Basic Operations](#) mentioned in Navigation chapter. A brief description of the fields is given below:

Table 3-65 ACH Definition

Field	Do this
Company	Select the portfolio company from the drop-down list.
Branch	Select the portfolio branch from the drop-down list.
ACH Identifier	Specify the lock box ID provided by the bank. This field is used in the ACH files to identify the bank.
Enabled	Check this box to enable the ACH and indicate this as an active ACH identifier.

6. Perform any of the [Basic Actions](#) mentioned in Navigation chapter.
7. Click **Setup > Setup > Administration > User > Bank Details > Lock Box**.
8. On the **Lock Box** sub screen, you can create lock box files for the bank listed in the Banks screen. Perform any of the [Basic Operations](#) mentioned in Navigation chapter. A brief description of the fields is given below:

Table 3-66 Lock Box

Field	Do this
Lock Box Identifier	Specify the lock box ID provided by bank. This field is used in the lock box files to identify the bank.
Company	Select the portfolio company from the drop-down list.
Branch	Select the portfolio branch from the drop-down list.
Enabled	Check this box to enable the lock box.

9. Perform any of the [Basic Actions](#) mentioned in Navigation chapter.

3.11 Standard Payees

The Standard Payees screen defines the third parties that are frequent payees for checks issued within your organization. These payees are then available on the Consumer Lending screen's Advance Entry screen. When you select the Payee # in the Advance Allocation section, the system completes the remaining fields in this screen with information from the Standard Payees screen.

Note

The Payee # field on the Advance Payment forms is a non-validated field. This allows you to select an entry or enter one of your own.

To set up the Standard Payees

1. Click **Setup > Setup > Administration > User > Standard Payee**. The system displays the Standard Payees screen.

- In the **Payee Definition** section, perform any of the [Basic Operations](#) mentioned in Navigation chapter.

Figure 3-47 Standard Payee

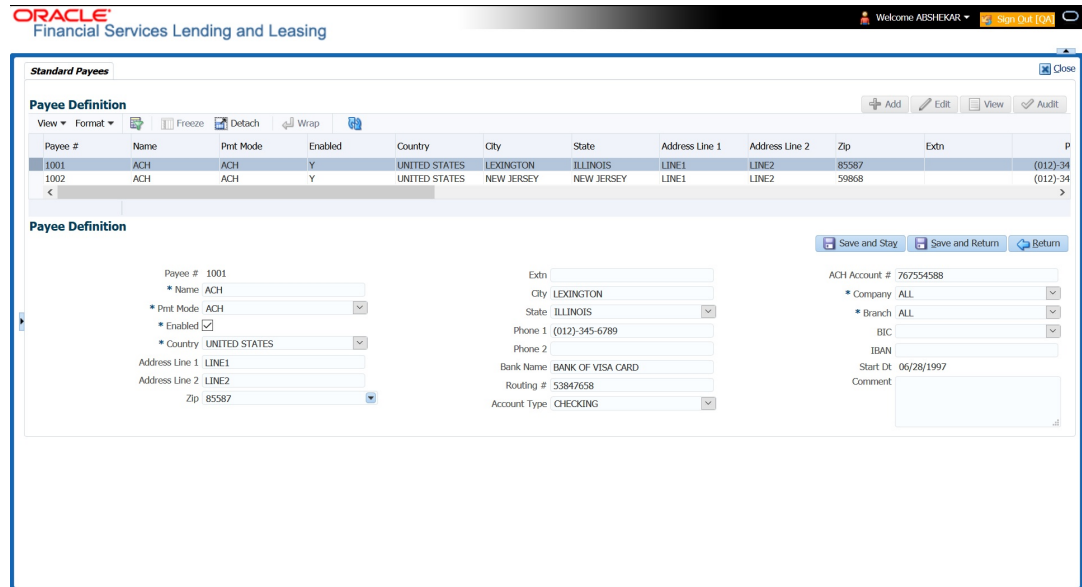

A brief description of the fields is given below:

Table 3-67 Payee Definition

Field	Do this
Payee #	Specify the payee number (Identifier for the payee).
Name	Specify the payee name.
Pmt Mode	Select the payment method for the payee from the drop-down list.
Enabled	Check this box to enabled the payee.
Country	Select the country where the payee is located from the drop-down list.
City	Specify the city where the payee is located.
State	Select the state where the payee is located from the drop-down list.
Address Line 1	Specify the address line 1 for the payee (optional).
Address Line 2	Specify the address line 2 for the payee (optional).
Zip	Select the zip code where the payee is located from the drop-down list.
Extn	Specify the extension of the zip code where the payee is located.
Phone 1	Specify the primary phone number for the payee.
Phone 2	Specify the alternate phone number for the payee.

Table 3-67 (Cont.) Payee Definition

Field	Do this
Bank Name	Specify the payee ACH bank name used by the standard payee.
Routing #	Specify the payee ACH bank routing number of bank used by the standard payee.
Account Type	Select the payee type of ACH bank account maintained by the Standard Payee from the drop-down list.
ACH Account #	Specify the payee ACH bank account number.
Company	Select the company from the drop-down list. The list is populated with Company definitions based on the Country selected.
Branch	Select the branch drop-down list. The list is populated with Company branch based on the Country selected.
BIC	Select the Business Identifier Code from the drop-down list. The list displays the BIC codes defined in the system.
IBAN	<p>Specify the IBAN (International Bank Account Number). IBAN is used for identifying bank accounts across national borders with a minimal of risk of propagating transcription errors.</p> <p>Ensure that value entered satisfies the check-digit validation based on modulo 97. On save, system automatically validates the IBAN number length based on country code, characters, white spaces, and checksum. Validation is also done during posting non-monetary transaction (ACH Maintenance).</p> <p>You can maintain the IBAN length and other details required as per the country code in the user defined table (Setup > Administration > System > User Defined Tables).</p> <p>Note: IBAN for NL country code (IBAN_FORMAT_NL) is defined by default with length of IBAN as 18.</p>
Start Dt	Specify the payment mode start date, the date the current payment method was implemented (defaults on Pmt Mode change). you can also select from the adjoining calendar icon.
Comment	Specify a comment for this advance allocations. This is the default comment to include with payments to this Payee.

3. Perform any of the [Basic Actions](#) mentioned in Navigation chapter.

3.12 Check Details

The Check Details screen allows you to set up check details.

To setup the Check Details

1. Click **Setup > Setup > Administration > User > Check Details**. The system displays the Check Details screen.

- In the **Check Definition** section, perform any of the [Basic Operations](#) mentioned in Navigation chapter.

Figure 3-48 Check Details

A brief description of the fields is given below:

Table 3-68 Check Definition

Field	Do this
Company	Select the company from the drop-down list.
Branch	Select the branch from the drop-down list.
Payee Type	Select the payee type from the drop-down list.
Check #	Specify the check number (required).
Printer Name	Specify the printer name (required).
Enabled	Check this box to enable the check details entry.

- Perform any of the [Basic Actions](#) mentioned in Navigation chapter.

3.13 Currencies

The Currencies link allows you to set up currency details.

Navigating to currencies

Click **Setup > Setup > Administration > User > Currencies**. The system displays the Currencies screen. In this screen, you can set up:

- [Currency Definition](#)
- [Currency Pair link](#)

3.13.1 Currency Definition

The Currency Definition screen allows you to set up currency details.

To set up the currency definition information

1. Click **Setup > Setup > Administration > User > Currencies > Currency**. The system opens the Currency Definition tab by default.
2. In the **Currency** section, perform any of the Basic Operations mentioned in Navigation chapter.

Figure 3-49 Currencies

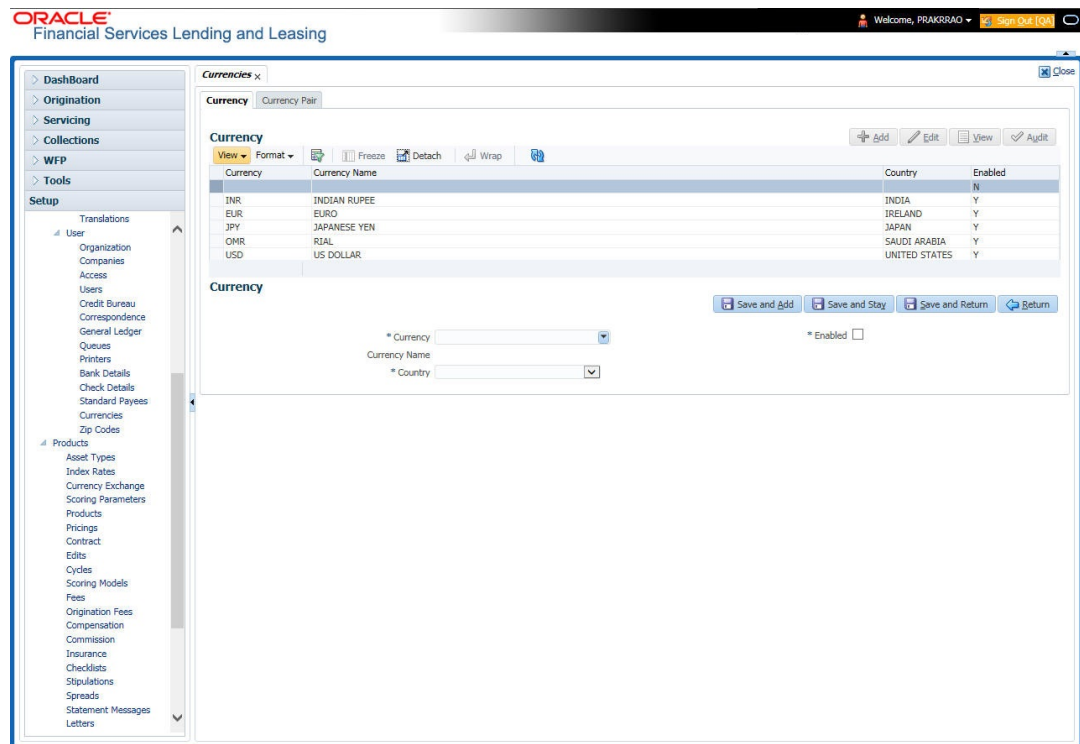

A brief description of the fields is given below:

Table 3-69 Currency Definition

Field	Do this
Currency	Select the currency you want to define, from the drop-down list.
Currency Name	The system displays the currency name based on the currency selected.
Country	Select the country for which the currency is defined, from the dropdown list.

Table 3-69 (Cont.) Currency Definition

Field	Do this
Enabled	Check this box to enable the currency entry.

3. Perform any of the Basic Actions mentioned in Navigation chapter.

3.13.2 Currency Pair link

The Currency Pair Definition link allows you to set up currency pair details.

To set up the currency pair definition information:

1. Click **Setup > Setup > Administration > User > Currencies > Currency Pair**. The system displays the Currency Pair Definition screen.
2. In the **Currency Pair Definition** section, perform any of the Basic Operations mentioned in Navigation chapter.

Figure 3-50 Currency Pair

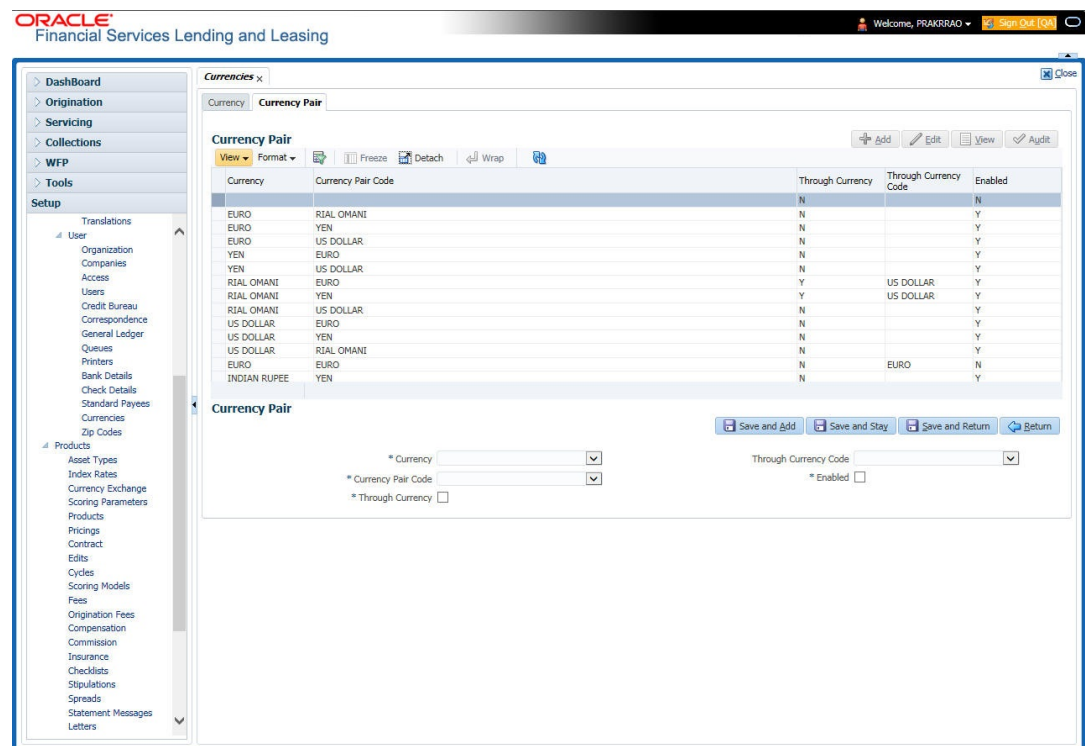

A brief description of the fields is given below:

Table 3-70 Currency Pair Definition

Field	View this
Currency Code	Select the currency code from the drop-down list.
Currency Pair Code	Select the currency pair code from the drop-down list.

Table 3-70 (Cont.) Currency Pair Definition

Field	View this
Through Currency	Check this box to set the selected currency as a through currency.
Through Currency Code	Select the through currency code from the drop-down list.
Enabled	Check this box to enable the currency pair entry.

3. Perform any of the Basic Actions mentioned in Navigation chapter.

3.14 Zip Codes

The Zip Codes screen allows you to set up zip code details.

To set up the zip codes information

1. Click **Setup > Setup > Administration > User > ZipCodes**. The system displays the Zip Codes screen.
2. In the **Zip Codes** section, perform any of the [Basic Operations](#) mentioned in Navigation chapter.

Figure 3-51 Zip Codes

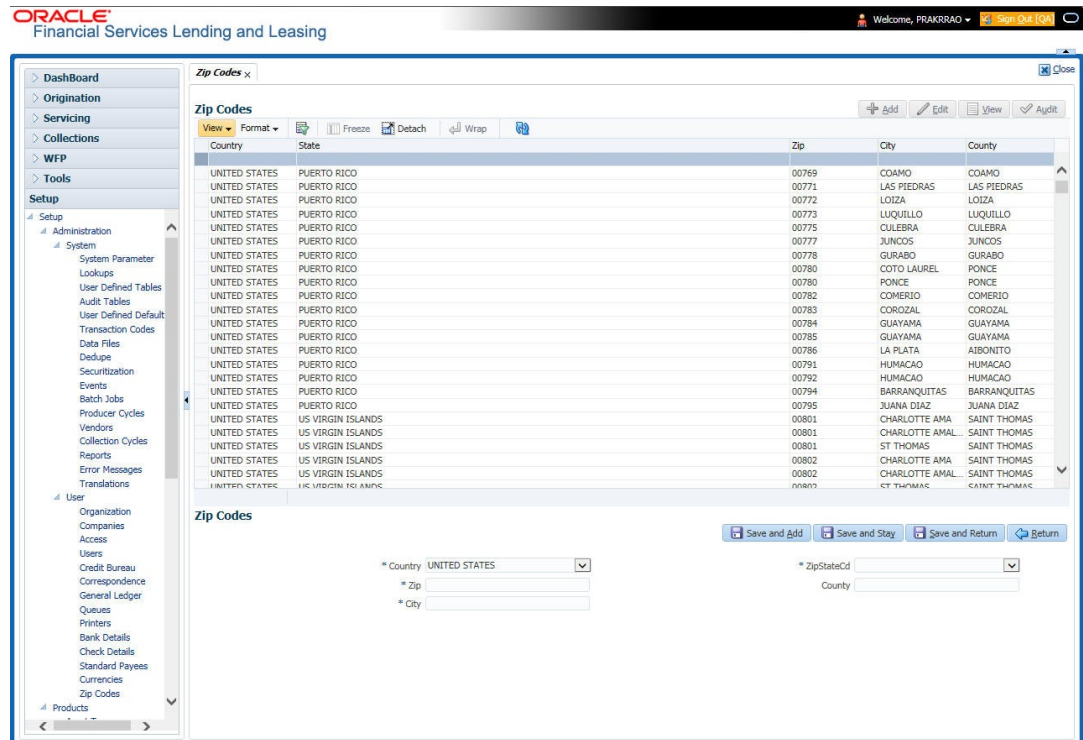

A brief description of the fields is given below:

Table 3-71 Zip Codes

Field	View this
Country	Select the country from the drop-down list.
State	Select the state from the drop-down list.
Zip Code	Specify the zip code (required).
City	Specify the city.
County	Specify the county.

3. Perform any of the [Basic Actions](#) mentioned in Navigation chapter.

3.15 Payment Hierarchy

The Payment Hierarchy screen facilitates to define hierarchy definition along with payment appropriation, excess payment handling, account selection criteria and sort order. These details are required by the system to allocate payments to the matching accounts of a customer, when customer based payments are being processed in **Payment Entry** screen.

Below is an illustration on how payment hierarchy is used to post customer based payments.

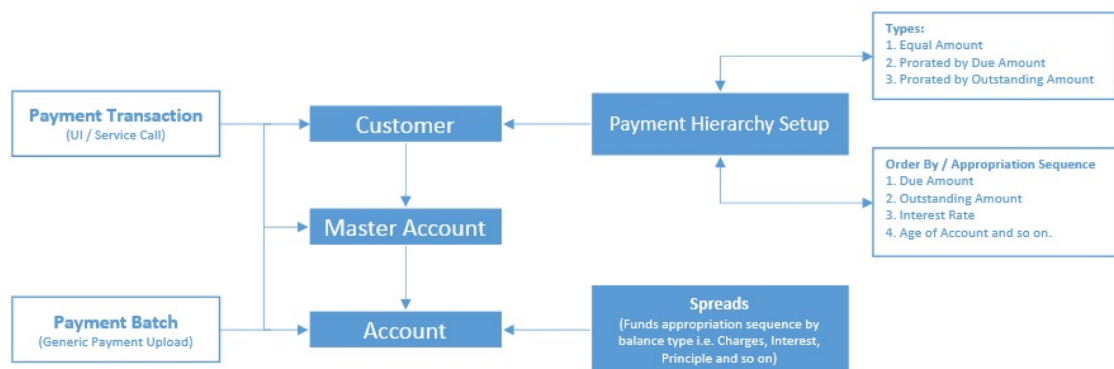
Figure 3-52 Payment Hierarchy - Illustration

Any Payment transaction generated in the system either from UI / Web Service Call or through a Payment Batch (Generic Payment Upload) can be directly posted to an Account or at Customer level.

- If payment is posted directly to an Account, the funds are allocated based on the defined spread with funds appropriation sequence of balance type i.e. Charges, Interest, Principle and so on.
- If payment is posted at Customer level having two accounts and if the payment amount is less than the due, then appropriation sequence is required. Else, one of the account can have a short fall with payment allocation.

In such case, the Payment Hierarchy determines the sequence of payment as to which account is to be appropriated first and which is to be appropriate next. This is based on **order by clause** and **appropriation sequence** defined.

Also the Balance Type determines the distribution type as one of the following:

- Equally to all the accounts

- Prorated by Due amount (i.e. highest due or lowest due first)
- Prorated by Outstanding Amount.

Once the account is narrowed down and payment amount is decided, then based on spread the payment is appropriated. This gives additional flexibility for defining payment modes at the master account level.

If Payment Hierarchy is not defined while funding an application or needs correction, the same can be done by posting **MASTER ACCOUNT PAYMENT HIERARCHY MAINTENANCE** non-monetary transaction in Servicing > Maintenance > Transaction Batch Information section. At Customer level, Payment hierarchy can be updated by posting **CUSTOMER MAINTENANCE** transaction.

This section consists of the following topics:

- [Payment Appropriation Methods](#)
- [Excess Payment Appropriation](#)

3.15.1 Payment Appropriation Methods

While creating Hierarchy definition in the Payment Hierarchy screen, you can use any of the following payment appropriation methods available in Hierarchy Type field. On selecting the specific Hierarchy definition at Application or Account level, the defined method is used to allocate payments to corresponding accounts.

However in all the methods, the payment criteria is also used for identifying the due accounts and careful consideration is required while defining the same.

Table 3-72 Payment Appropriation Methods

Method	Description
EQUAL AMOUNT	To allocate payment equally to all the accounts picked. This is traditional method of payment allocation in which the total payment amount received is divided and adjusted equally to all customer linked accounts.

Table 3-72 (Cont.) Payment Appropriation Methods

Method	Description																																
DELQ DUE AMOUNT RATIO	<p>To allocate payment based on the ratio of amount due on all accounts.</p> <p>In this method, the due accounts are identified based on the defined selection criteria and the payment appropriation is done on the ratio of amount due on each account using the below formula.</p> $\frac{\text{Amount Due} * \text{Payment Amount}}{\text{Total Due Amount}}$ <p>Following is an illustration on payment allocation:</p> <table border="1"> <thead> <tr> <th></th> <th>Amount Due</th> <th>Outstanding Amount</th> </tr> </thead> <tbody> <tr> <td>Master Account</td> <td>30</td> <td>200</td> </tr> <tr> <td>Associated Account 1</td> <td>50</td> <td>250</td> </tr> <tr> <td>Associated Account 2</td> <td>100</td> <td>400</td> </tr> </tbody> </table> <table border="1"> <thead> <tr> <th></th> <th>Due Amount Ratio</th> <th>Outstanding Amount Ratio</th> <th>Equal Amount</th> </tr> </thead> <tbody> <tr> <td>Payment Amount</td> <td>\$90</td> <td>\$90</td> <td>\$90</td> </tr> <tr> <td>Master Account</td> <td>\$15</td> <td>\$21.18</td> <td>\$30</td> </tr> <tr> <td>Associated Account 1</td> <td>\$25</td> <td>\$26.47</td> <td>\$30</td> </tr> <tr> <td>Associated Account 2</td> <td>\$50</td> <td>\$42.35</td> <td>\$30</td> </tr> </tbody> </table>		Amount Due	Outstanding Amount	Master Account	30	200	Associated Account 1	50	250	Associated Account 2	100	400		Due Amount Ratio	Outstanding Amount Ratio	Equal Amount	Payment Amount	\$90	\$90	\$90	Master Account	\$15	\$21.18	\$30	Associated Account 1	\$25	\$26.47	\$30	Associated Account 2	\$50	\$42.35	\$30
	Amount Due	Outstanding Amount																															
Master Account	30	200																															
Associated Account 1	50	250																															
Associated Account 2	100	400																															
	Due Amount Ratio	Outstanding Amount Ratio	Equal Amount																														
Payment Amount	\$90	\$90	\$90																														
Master Account	\$15	\$21.18	\$30																														
Associated Account 1	\$25	\$26.47	\$30																														
Associated Account 2	\$50	\$42.35	\$30																														
DUE AMOUNT RATIO (INCLUDING CURRENT DUE)	<p>To allocate payment by including the existing unpaid delinquent due amount of pre-bill days on all accounts.</p> <p>This is calculated as: (Single Account Total Due Amount Ratio (Including Current Due) * Payment Amount) / All Accounts Total Due Amount Ratio (Including Current Due)</p> <p>The value is derived from lookup code DUE_RATIO_CUR_DUE.</p>																																
OUTSTANDING BALANCE RATIO	<p>To allocate payment based on the ratio of total outstanding due on all accounts.</p> <p>Similar to above, even in this method the due accounts are identified based on the defined selection criteria and the payment appropriation is done on the ratio of outstanding amount due on each account using the below formula.</p> $\frac{\text{Outstanding Balance} * \text{Payment Amount}}{\text{Total Outstanding Balance}}$ <p>This method can be selected if the received payment amount is equal to total outstanding due on all linked accounts indicated in Customer Service > Transaction History > Balances screen.</p>																																

Table 3-72 (Cont.) Payment Appropriation Methods

Method	Description
ACCOUNT COLUMN BASE	To allocate payment based on hierarchy order. In this method, the due accounts are identified based on the defined selection criteria and the payment appropriation is done as per the sequence of due accounts defined either in ascending/ descending order.

During payment appropriation, system allocates the payment amount only up to the total of resulted accounts and remaining amount (if any) are processed based on the excess payment method value.

While onboarding accounts through web services, system considers the value of system parameter PMT_HIERARCHY_CODE to default the payment allocation in Customer/ Business Details screen after account activation.

Also while onboarding if the Payment Hierarchy is not passed as part of the request (Applicant/ Application), then system parameter value is considered.

3.15.2 Excess Payment Appropriation

During or after payment appropriation, there can be a residual amount pending for allocation. For example, \$0.01 remains when \$100 is equally paid to 3 accounts. In such case the residual amount is transferred to last account in the hierarchy sequence. However, note that system performs this residual payment allocation only once.

In other case where there is an excess payment received which is more than account dues, the same can be processed for payment allocation using any of the following **Excess Handling Method** while defining the Hierarchy Definition.

Table 3-73 Excess Handling Method

Method	Description
SUSPENSE	To post the excess amount as suspense on Customer or Master account.
HIERARCHY BASED	To allocate the excess payment based on any of the Hierarchy Definitions maintained in the system.

Based on the selection, system re-allocates the excess amount to corresponding accounts.

To set up payment hierarchy

1. Click **Setup > Setup > Administration > User > Payment Hierarchy**.
2. In the **Hierarchy Definition** section, perform any of the [Basic Operations](#) mentioned in Navigation chapter.

Figure 3-53 Hierarchy Definition

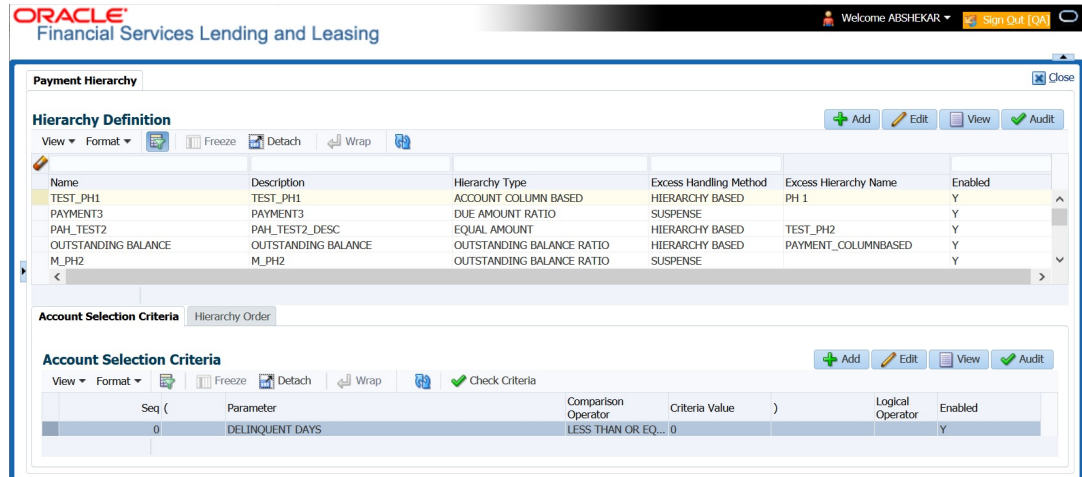

A brief description of the fields is given below:

Table 3-74 Hierarchy Definition

Field	View this
Name	Specify a unique name for the hierarchy definition.
Description	Specify the description for the hierarchy definition.
Hierarchy Type	Select one of the following type of payment allocation method from the drop-down list. The list is populated based on the PMT_HIERARCHY_TYPE_CD lookup. <ul style="list-style-type: none"> • EQUAL AMOUNT • DUE AMOUNT RATIO • OUTSTANDING BALANCE RATIO • ACCOUNT COLUMN BASED For more information on the above methods, refer to Payment Appropriation Methods section. You can define multiple Hierarchy definitions with same Hierarchy type.
Excess Handling Method	Select one of the following type of excess payment allocation method to be used with payment hierarchy definition from the drop-down list. The list is populated based on PMT_HIERARCHY_EXCESS_METHOD_CD lookup. <ul style="list-style-type: none"> • SUSPENSE • HIERARCHY BASED For more information on the above methods, refer to Excess Payment Appropriation section.

Table 3-74 (Cont.) Hierarchy Definition

Field	View this
Excess Hierarchy Name	This field is enabled and is mandatory if the Excess Handling Method is selected as Hierarchy Based . Select the Hierarchy Definition from the drop-down list. This list is populated with all the pre-defined and enabled hierarchy definitions maintained in the system. For more information on the above methods, refer to Excess Payment Appropriation section.
Enabled	By default this check box is enabled for new hierarchy definition.

3. Perform any of the [Basic Actions](#) mentioned in Navigation chapter.

Account Selection Criteria

This sub tab facilitates to define the account selection criteria that is used to identify due account for payment allocation. Atleast one valid account selection criteria is required for all the Hierarchy Types.

1. In the **Account Selection Criteria** section, perform any of the [Basic Operations](#) mentioned in Navigation chapter.

Note

Although system allows to define customized selection criteria, the execution of additional selection criteria requires additional processing at server level and can have significant performance impact delaying the EOD processing/web services. Hence it is recommended to have careful consideration while defining the additional selection criteria (like using user-defined tables and columns) and/or get approval from your database administrator before using any selection criteria.

A brief description of the fields is given below:

Table 3-75 Account Selection Criteria

Field	Do this
Seq	Specify sequence numbers.
(Specify left bracket.
Parameter	Select the parameter from the drop-down list. The list is populated based on the values maintained in CUSTOMER PAYMENT HIERARCHY ORDER PARAMETERS user defined table.
Comparison Operator	Select comparison operator from the drop-down list.
Criteria Value	Specify criteria value.
)	Specify right bracket.
Logical Expression	Select logical operator from the drop-down list.
Enabled	Check this box to enable the selection criteria.

2. Perform any of the [Basic Actions](#) mentioned in Navigation chapter.
3. You can click **Check Criteria** for system to validate the query and display the results.

Hierarchy Order

This sub tab facilitates you to define hierarchy order that is used to sort the due account for payment allocation. This sub tab is enabled only for **ACCOUNT COLUMN BASED** Hierarchy type.

1. In the **Hierarchy Order** section, perform any of the [Basic Operations](#) mentioned in Navigation chapter. A brief description of the fields is given below:

Table 3-76 Hierarchy Order

Field	Do this
Seq	Specify sequence number.
Sort Field	Select sort field from the drop-down list. The list is populated based on values maintained in CUSTOMER PAYMENT HIERARCHY ORDER PARAMETERS user defined table.
Order	Select sort order as either Ascending or Descending from the drop-down list.

2. Perform any of the [Basic Actions](#) mentioned in Navigation chapter.

3.16 Number Generation

Users can create and manage custom auto number generation definitions on the Number Generation screen, which can then be linked to applications, accounts, and other entities.

This topic contains the following subtopics:

- [Overview](#)
- [Navigation](#)
- [Number Generation Definition](#)

3.16.1 Overview

A Number Generation Definition includes the rules a system follows to create unique numbers according to certain criteria. This ensures the production of unique, non-duplicate numbers that validate the related entities and attributes, rather than producing random numbers..

3.16.2 Navigation

Number Generation sub menu link is available under **Setup > Administrator > User** in LHS menu. Clicking on **Number Generation** link, the screen is as displayed:

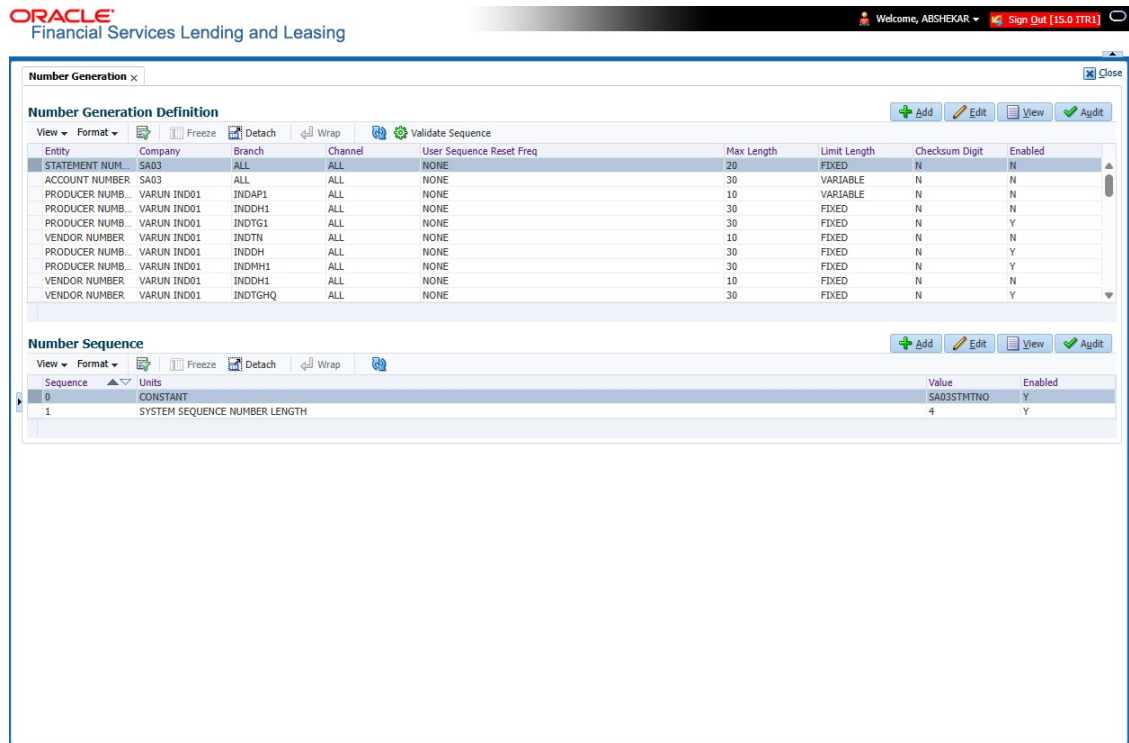

The Number Generation screen consists of the following:

1. Number Generation Definition
2. Number Sequence

3.16.3 Number Generation Definition

The Number Generation Definition section outlines the criteria for generating numbers for specific entities like Account Number and Application Number, based on combinations of Company, Branch, and Entity. However, please note that the system permits only one definition for each unique combination of Company, Branch, and Entity.

In this section, user can do the following:

- Include a new definition and check the list of existing definitions stored in the system.
- Validate the number generation sequence based on the selected parameters.
- Enable or Disable a number generation definition.

Add Number Generation Definition

1. In the **Number Generation Definition** section, perform any of the [Basic Operations](#) mentioned in Navigation chapter.
A brief description of the fields is given below:

Table 3-77 Number Generation Definition

Field Name	Description
Entity	Select the entity from drop-down list for which the system should generate the number. The list is populated with values maintained in NUM_GEN_ENTITY user defined table.
Company	Select the company from drop-down list for which the system should generate the number.
Branch	Select the branch for the selected company from the drop-down list. If company is selected is ALL, then all the Branches are populated.
Channel	Select the channel from the drop-down list on which the system should generate the Number. This can be ALL or a specific channel. For entity as Application or Account Number, system refers to APP_SOURCE_CD lookup.
User Sequence Reset Freq	Select the sequence reset frequency from the drop-down list. This is the interval at which system should reset the sequence and the same can be used as a counter to the number of record within that sequence duration. The list is populated based on values maintained in NUM_GEN_USR_SEQ_RESET_FREQ_CD lookup code.
Max Length	Specify the value between 1 to 80 to indicate the maximum length of the number to be generated.
Limit Length	Select the limit length as either Variable or Fixed . This indicates the system to generate either fixed sequence number or variable sequence number. <ul style="list-style-type: none"> If limit length is Fixed, system ensures that the auto number generated is up to the Max Length field. If it is shorter, zeros are prefixed. If limit length is Variable, then auto number is generated as per format. <p>However, system displays an error if the sequence number generated exceeds the specified Max length.</p>
Checksum Digit	Select the checkbox to indicate the system to add a check sum digit at the end of the auto number generated.

2. Perform any of the [Basic Actions](#) mentioned in Navigation chapter.

Specify a number sequence in the flow to show the order for the system to apply the number generation logic. Additionally, you can add or modify entries in the **Number Sequence** section.

- [Number Sequence](#)

3.16.3.1 Number Sequence

This section displays the Number Sequence set for an entity and allows you to add and modify the number sequence for an existing number generation definition. A number sequence must be established for a Number Generation Definition. The system uses this sequence to perform the number generation process and produce a number for a specific entity

Add Number Sequence

1. In the **Add Number Sequence** section, perform any of the [Basic Operations](#) mentioned in Navigation chapter.
A brief description of the fields is given below:

Table 3-78 Number Sequence

Field Name	Description
Sequence	Specify the sequence number in which system should use in the number generation logic. Once specified, the same can be incremented or decremented using the up or down arrow buttons.
Units	<p>Select the Units using which system should generate the number from the drop-down list. This list is populated based on entity type and values maintained in NUM_GEN_UNIT_CD lookup code.</p> <p>The available options are:</p> <ul style="list-style-type: none"> • Constant • Record Creation Date (DD) • Record Creation Month (MM) • Random Number Length • System Sequence Number Length • User Sequence Number Length • Record Creation Year (YY) • Record Creation Year (YYYY) • Record Creation Year/Month (YYYYMM) <p>It is mandatory to add and enable the System Sequence Number Length. The length of the all units plus the Check Digit (if enabled) together should not be greater than the maximum length specified in the Max Length field.</p>
Value	Specify the value which can either be a Constant or Index Number in reference to the unit selected. Once specified, the same can be incremented or decremented using the up or down arrow buttons.
Enabled	Select the check box to enable and use this parameter in the number generation.

Note

If number generation definition does not exist then you can autogenerate the number using the system sequence number alone. This can work as a mechanism to identify if number should be generated by system or as per user defined logic in this screen.

2. Click **Validate Sequence** in 'Number Generation Definition' to validate the number generation sequence based on the selected parameters.

- a. On validation, system displays the errors if any duplicate sequence exist.
 - b. After successful validation, the system shows a popup with the sample number and an option to Enable the record. Clicking **Yes** saves the record as Enabled. Clicking **No** saves it as Disabled, which can be enabled later by clicking **Validate Sequence** in the 'Number Generation Definition' section.
 - c. If 'Xref/External Application number/Application Number' is enabled, then system sequence is not mandatory.
 - d. Ensure that the Length of all units + Check Digit (if enabled) together should not be greater than the Max Length at the parent record.
3. Perform any of the [Basic Actions](#) mentioned in Navigation chapter.

4

Product

Under the Setup master tab's drop-down link bar, the product Setup link opens screens that enable you to configure the basic business guidelines necessary to support one or more products in the system. This includes defining the types of collateral your company supports, creating lending instruments, and determining what is included in credit bureau reporting. Setting up the Products screens requires a thorough understanding of the current rules of your business and must be completed before you can use Oracle Financial Services Lending and Leasing. The Products drop-down link opens screens to record data of all the products supported by the system and contains the following links:

Navigating to Products

In the Setup > Setup > Products link enables you to setup the options related to the following closed ended products that your company offers. Below sections explain how to setup the screens associated with each one.

- [Asset Types](#)
- [Index Rates](#)
- [Currency Exchange](#)
- [Scoring Parameters](#)
- [Products](#)
- [Pricings](#)
- [Contract](#)
- [Edits](#)
- [Cycles](#)
- [Scoring Models](#)
- [Fees](#)
- [Asset Billing Rate](#)
- [Origination Fees](#)
- [Insurance](#)
- [Checklists](#)
- [Stipulations](#)
- [Letters](#)
- [Promotions](#)

4.1 Asset Types

In Assets types you can setup the asset types that can serve as an application or account's collateral.

The information on the Assets screen is used by the system to automatically display the appropriate collateral screen (Vehicle, Home, or Other) on the Application Entry screen.

The system recognizes the following four types of collateral:

Table 4-1 Collateral

Collateral Type	Description
Home collateral	Homes, manufactured housing, or any real estate collateral.
Vehicle collateral	All vehicle types, such as cars, trucks, and motorcycles.
Household goods and other collateral	All other collateral types not defined as home, vehicle, or unsecured; for example, household items such as water heaters, televisions, and vacuums.
Unsecured collateral	All unsecured lending instruments. (This collateral type makes the collateral tabs on the system forms unavailable.)

The Asset Sub Type section allows you to further categorize an asset; for example, the asset type VEHICLE might be categorized as CAR, TRUCK, or VAN.

The Attributes/Addons and Makes and Models sub screens continue to further detail the asset both in description and value. For example, a VEHICLE asset might include addons such as LEATHER SEATS and CRUISE CONTROL.

Note

Neither asset types nor asset sub types can be deleted. As they may have been used in the past, the display and processing of that data is still dependent on the existing setup.

To set up the Asset Types

You can either define new Asset Type or specify a new name in the **New Asset Type** field and click **Create Copy** to create a copy of selected asset with details.

1. Click **Setup > Setup > Products > Asset Types**.
2. In the **Asset Type** section, perform any of the [Basic Operations](#) mentioned in Navigation chapter.

Figure 4-1 Asset Type

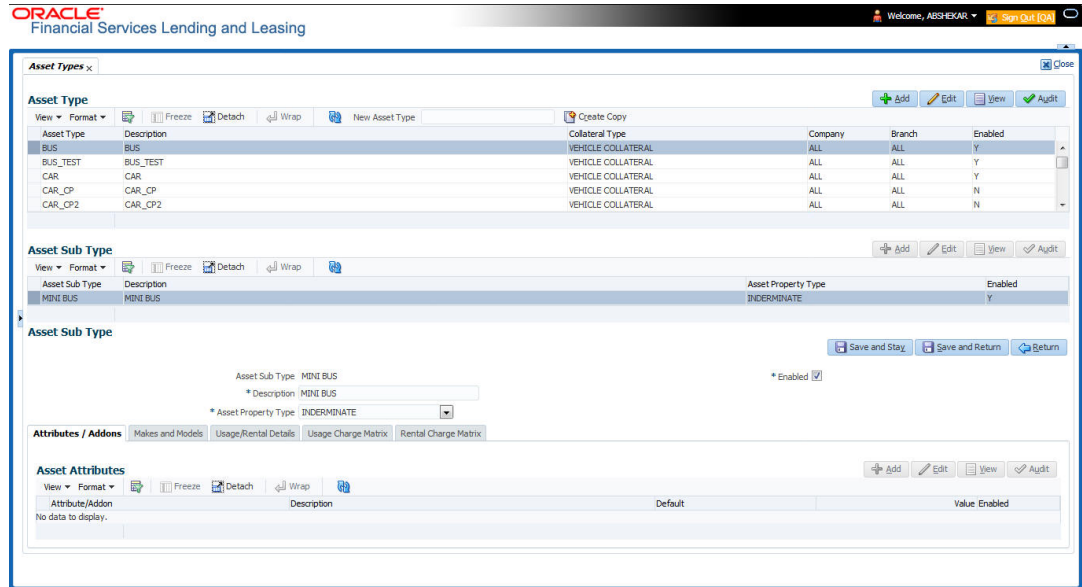

A brief description of the fields is given below:

Table 4-2 Asset Type

Field	Do this
Asset Type	Specify the asset type.
Description	Specify the description for the asset. (This is the asset type which will appear throughout the system).
Collateral Type	Select the collateral type (the general category that the asset type falls within) from the drop-down list. Note: There is no need to define an asset for UNSECURED COLLATERAL, as by definition there is no asset on such account.
Company	Select the portfolio company to which the asset type belongs, from the drop-down list. These are the companies within your organization that can make Line using this asset type. This may be ALL or a specific company.

Table 4-2 (Cont.) Asset Type

Field	Do this
Branch	Select the portfolio branch to which the asset type belongs, from the drop-down list. This is the branch within the selected company that can make Line using this asset type. This may be ALL or a specific branch. This must be ALL if in the Company field you selected ALL. IMPORTANT: By selecting which asset type to use, the system searches for a best match using the following attributes: <ol style="list-style-type: none"> 1. Company 2. Branch Hence, the system recommends creating one version of each asset type where ALL is the value in these fields.
Enabled	Check this box to enable the asset type and indicate that the asset type is currently in use.

3. Perform any of the [Basic Actions](#) mentioned in Navigation chapter.
4. In the **Asset Sub Type** section, perform any of the [Basic Operations](#) mentioned in Navigation chapter.
A brief description of the fields is given below:

Table 4-3 Asset Sub Type

Field	Do this
Asset Sub Type	Specify the asset sub type.
Description	Specify the description for the asset subtype.
Asset Property Type	Select the type of property from the drop-down list.
Enabled	Check this box to enable the asset sub type.

5. Perform any of the [Basic Actions](#) mentioned in Navigation chapter.
6. Click **Setup > Setup > Products > Assets > Attributes/Addons**.
7. In the **Attributes/Addons** section, perform any of the [Basic Operations](#) mentioned in Navigation chapter.
A brief description of the fields is given below:

Table 4-4 Attributes/Addons

Field	Do this
Attribute/Addon	Displays the asset attribute or addon name for the selected asset).
Description	Select the description for the asset attribute/addon from the dropdown list.
Default	Specify the default text to be copied or displayed when the asset attributes and addons fields are completed on an application for this asset.

Table 4-4 (Cont.) Attributes/Addons

Field	Do this
Value	Specify the default monetary value to be copied or displayed when the asset attributes and addons fields are completed on an application for this asset.
Enabled	Check this box to enable the asset attribute/Addons and indicate that it is available for this type of asset.

8. Perform any of the [Basic Actions](#) mentioned in Navigation chapter.
9. Click the **Setup > Setup > Products > Assets > Makes and Models**.
10. In the **Makes and Models** section, perform any of the [Basic Operations](#) mentioned in Navigation chapter.
A brief description of the fields is given below:

Table 4-5 Makes and Models

Field	Do this
Make	Specify asset make.
Model	Specify asset model.
Style	Specify asset style type.
Model Year	Specify asset model year.
Enabled	Check this box to enable the asset make and model and indicate that it is included on fields for this asset type.

11. Perform any of the [Basic Actions](#) mentioned in Navigation chapter.

This section consists of the following topics:

- [Usage/Rental Details](#)
- [Usage Charge Matrix](#)
- [Rental Charge Matrix](#)

4.1.1 Usage/Rental Details

The Usage / Rental Details sub tab allows you to define Usage/Rental definition details to categorize the incoming asset usage/rental data based on different parameters. The details maintained here are populated in Origination screen for billing calculation and can also be modified based on requirement.

1. In the **Usage/Rental Details** section, perform any of the [Basic Operations](#) mentioned in Navigation chapter.
2. A brief description of the fields is given below:

Table 4-6 Usage/Rental Details

Field	Do this
Agreement Type	<p>Select the agreement type as one of the following from the drop-down list. The selected Agreement Type defines the criteria for pricing selection during billing calculation.</p> <ul style="list-style-type: none"> • USAGE • RENTAL • USAGE RENTAL <p>Note: Based on the above selected option, the other fields are either enabled or disabled for selection as indicated below:</p> <p>For Usage Agreement Type, the following fields are editable:</p> <ul style="list-style-type: none"> • Calc Method • Usage Cycle • Min Usage • Max Usage • Discount % • Usage Rollover / Advance • Usage Term Calc Method <p>For Rental Agreement Type, the following fields are editable:</p> <ul style="list-style-type: none"> • Discount % • Discount Amount • Security Deposit <p>For Usage Rental Agreement Type, the following fields are editable:</p> <ul style="list-style-type: none"> • Usage Cycle • Max Usage • Discount % • Discount Amount • Security Deposit
Calc Method	<p>Select the calculation method as one of the following from the dropdown list.</p> <ul style="list-style-type: none"> • TIERED (billing is based on the defined Usage/Rental Charge Matrix) • NON-TIERED (system automatically chooses the applicable slab based on the final usage value)
Usage Cycle	<p>Select the frequency of billing the asset usage from the drop-down list. This field is disabled for RENTAL agreement type.</p>
Min Usage	<p>Specify the minimum usage value of the allowed range. This field is disabled for RENTAL agreement type.</p>
Max Usage	<p>Specify the maximum usage value of the allowed range. This field is disabled for RENTAL agreement type.</p>
Discount %	<p>Specify the percentage of discount exempted from final billing.</p>

Table 4-6 (Cont.) Usage/Rental Details

Field	Do this
Usage Rollover / Advance	<p>Select the type of asset usage calculation as one of the following:</p> <ul style="list-style-type: none"> • ROLLOVER (remaining usage balance is carried forward to next cycle) • NO-ROLLOVER (remaining usage balance is not carried forward) • ROLLOVER AND ADVANCE (remaining usage balance is carried forward to next cycle + total usage limit for current cycle can be utilized upfront) • ADVANCE (total usage limit for current cycle can be utilized upfront) <p>Note: This field is disabled for RENTAL and USAGE RENTAL agreement type and NO-ROLLOVER option is applicable by default.</p>
Reset Frequency	<p>Specify the reset frequency of the billing cycle. This field is disabled for RENTAL and USAGE RENTAL agreement types and is available for ROLLOVER, ADVANCE and ROLLOVER AND ADVANCE methods of asset usage billing.</p>
Usage Term Calc Method	<p>Select the type of asset usage term for billing calculation as one of the following from the drop-down list:</p> <ul style="list-style-type: none"> • ACTUAL - here the current details updated/received is treated as the final record for usage term calculation. • AVERAGE - here system takes the average of usage details received in previous cycles for usage term calculation. <p>The calculation method selected here is populated to Elastic Term Calc Method field in Origination/Servicing Collateral screen. This field is disabled for RENTAL and USAGE RENTAL agreement type.</p>
Discount Amount	<p>If you are defining Usage/Rental Details for RENTAL or USAGE RENTAL type of agreements, specify the discount amount allowed upfront from the final billing. This field is disabled for USAGE agreement type.</p>
Security Deposit	<p>If you are defining Usage/Rental Details for RENTAL or USAGE RENTAL type of agreements, specify the security deposit amount paid upfront for the term. This field is disabled for USAGE agreement type.</p>
Excess Rent Collection Method	<p>If you have selected the Agreement Type as USAGE RENTAL, select one of the following type of Charge Matrix to be used to derive the Excess Rent Collection Method from the drop-down list.</p> <ul style="list-style-type: none"> • USING USAGE MATRIX • USING RENTAL MATRIX

3. Perform any of the [Basic Actions](#) mentioned in Navigation chapter.

4.1.2 Usage Charge Matrix

The Usage Charge Matrix sub tab allows you to define and maintain different chargeable slabs based on the combination of Billing Cycle and Charge Type. The details maintained here are used for billing calculation based on a particular asset usage.

1. In the **Usage Charge Matrix** section, perform any of the [Basic Operations](#) mentioned in Navigation chapter.
A brief description of the fields is given below:

Table 4-7 Usage Charge Matrix

Field	Do this
Billing Cycle	Select the frequency of the billing cycle for the asset from the drop-down list.
Units From	Specify the minimum number of units from which the current usage charge matrix is applicable.
Charge Per Unit	Specify the amount to be charged for every unit.
Charge Type	Select the Charge Type as one of the following from the drop-down list. The list is displayed based on CHARGE_TYPE_CD lookup. <ul style="list-style-type: none"> • BASE (Units considered as base and chargeable at base rate) • EXCESS CYCLE (Units beyond base units and chargeable considering excess cycle) • EXCESS LIFE (Units exceeding the total contracted units and chargeable considering excess life cycle) <p>Excess life is not applicable for Rental agreement type.</p>
Enabled	Check this box to enable the charge matrix for usage calculation.

2. Perform any of the [Basic Actions](#) mentioned in Navigation chapter.

4.1.3 Rental Charge Matrix

The Rental Charge Matrix sub tab allows you to define and maintain different chargeable slabs based on the combination of Billing Cycle, Rental Duration, Charge Per Cycle and Charge Type. The details maintained here are used for billing calculation based on a particular asset usage.

1. In the **Rental Charge Matrix** section, perform any of the [Basic Operations](#) mentioned in Navigation chapter.
A brief description of the fields is given below:

Table 4-8 Rental Charge Matrix

Field	Do this
Billing Cycle	Select the frequency of the billing cycle for the asset from the drop-down list.
Rental Duration From	Specify the minimum duration for which the rental charge is applicable.

Table 4-8 (Cont.) Rental Charge Matrix

Field	Do this
Charge Per Cycle	Specify the amount to be charged for every rental cycle.
Charge Type	<p>Select the Charge Type as one of the following from the drop-down list. The list is displayed based on CHARGE_TYPE_CD lookup.</p> <ul style="list-style-type: none"> • BASE (Chargeable units exceeding from base units allowed) • EXCESS CYCLE (Chargeable units exceeding from billing cycle units) • EXCESS LIFE (Chargeable units exceeding the total contract term) <p>Excess life is not applicable for Rental / Usage, Rental agreement types.</p>
Enabled	Check this box to enable the charge matrix for usage calculation.

2. Perform any of the [Basic Actions](#) mentioned in Navigation chapter.

4.2 Index Rates

The Index Rates screen maintains your organization's history of periodic changes in index rates. It allows you to define index rates to support variable rate lines of credit. The index rate provides the base rate for a credit line where:

$\text{interest rate} = \text{index rate} + \text{margin rate}.$

The Index section displays the currently defined indexes on the Lookups screen. You may create additional user-defined lookup codes for this lookup type as needed.

Note

You cannot tie an index rate to a product rate.

You can also record any index rate change on the Index Rates screen. During nightly batch processing, all the accounts with that index type are included when posting the RATE CHANGE transaction. After the system processes the batch, the interest rate of the account is changed. The system will use this new interest rate when computing all future interest calculations.

To set up Index Rates

1. Click **Setup > Setup > Products > Index Rates**.
2. In the **Index** section, perform any of the [Basic Operations](#) mentioned in Navigation chapter.:

Figure 4-2 Index Rates

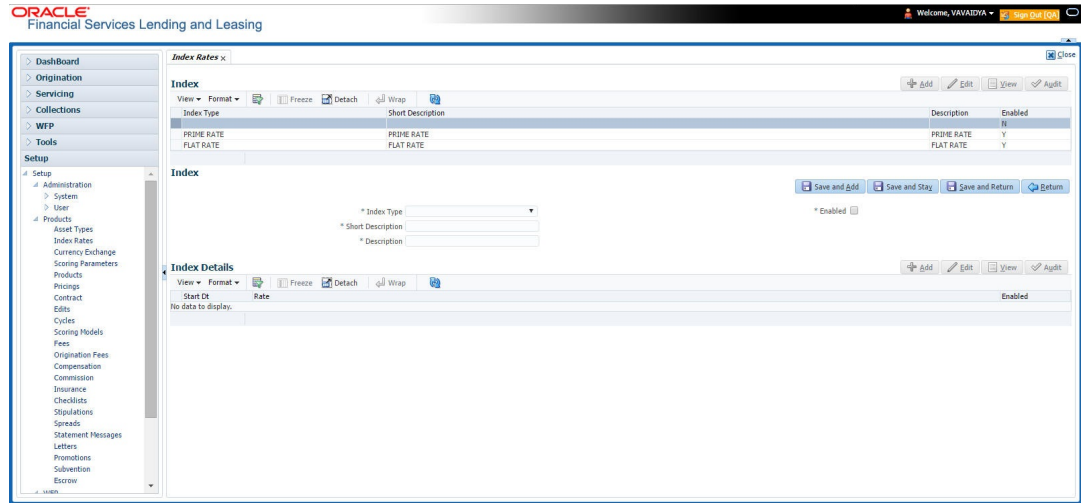

- A brief description of the fields is given below:

Table 4-9 Index

Field	Do this
Index Type	Select the type of index from the drop-down list.
Short Description	Specify a short description of the index.
Description	Specify the index description.
Enabled	Check this box to activate the index type.

- Perform any of the [Basic Actions](#) mentioned in Navigation chapter. The Index Details section allows you to define multiple index values using the Start Dt and Rate fields.

Note

The history appears in descending order, with the most current record at the top.

- In the **Index Details** section, perform any of the [Basic Operations](#) mentioned in Navigation chapter. A brief description of the fields is given below:

Table 4-10 Index Details

Field	Do this
Start Dt	Specify the effective start date for the index rate. You can even select the date from the adjoining Calendar icon.
Rate	Specify the new index rate effective from above mentioned date as a percentage. Note: For the FLAT RATE index there should be only one entry with a Start Dt. = 01/01/1900 and a RATE = 0.0000.

Table 4-10 (Cont.) Index Details

Field	Do this
Enabled	Check this box to activate the index rate effective from start date mentioned above.

6. Perform any of the [Basic Actions](#) mentioned in Navigation chapter.

Note

Variable rate functionality is not extended to pre-compute accounts.

4.3 Currency Exchange

The Currency Exchange screen maintains currency exchange rates. You can define the currency exchange details and schedule a batch job (SET-IFP- ICEPRC_BJ_100_01 - CURRENCY EXCHANGE RATE FILE UPLOAD) which in-turn pulls the currency exchange rates from desired source at scheduled intervals through input file processing.

To set up the Currency Exchange

1. Click **Setup > Setup > Products > Currency Exchange**.
2. In the **Currency Exchange Rates** section, perform any of the [Basic Operations](#) mentioned in Navigation chapter.

Figure 4-3 Currency Exchange Rates

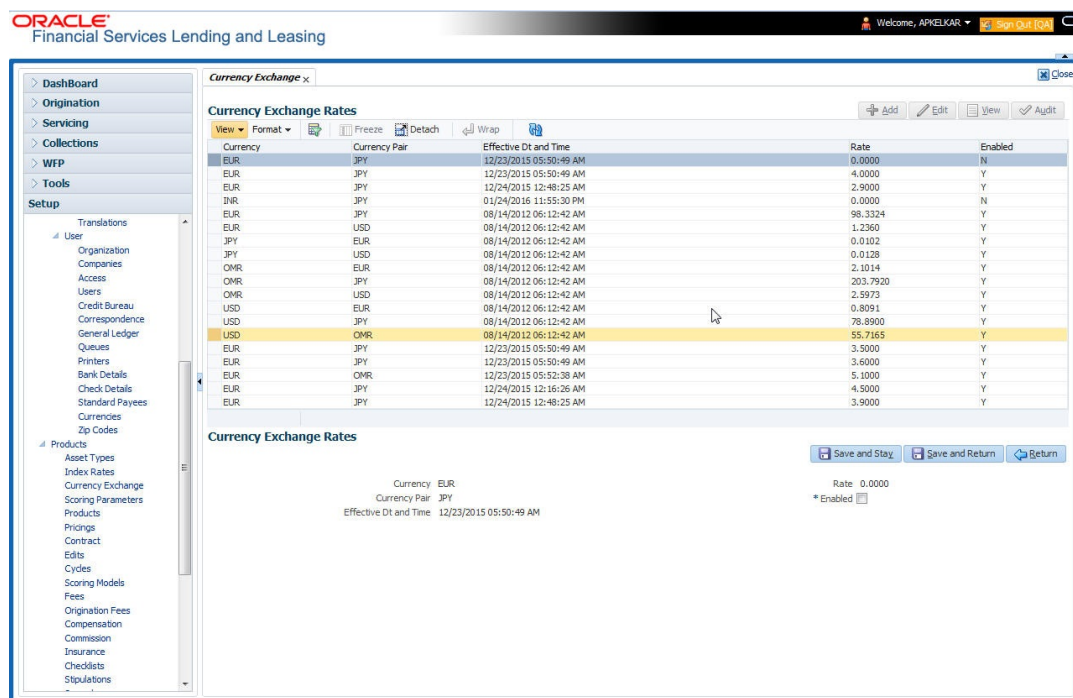

A brief description of the fields is given below:

Table 4-11 Currency Exchange Rates

Field	Do this
Currency	Select the currency being exchanged from the drop-down list.
Currency Pair	Select the currency to be paired with from the drop-down list.
Effective Date and Time	Specify date and time of the exchange rate. You can even select the date from the adjoining Calendar icon.
Rate	Specify the exchange rate (required).
Enabled	Check this box to activate the currency exchange rate.

3. Perform any of the [Basic Actions](#) mentioned in Navigation chapter.

4.4 Scoring Parameters

With the Scoring Parameters, you can define the scoring parameters of a company's credit scorecard and behavioral scoring.

The system's pricing scores apply to applications and are based on information recorded during origination.

Credit Scoring

Parameters define the factors that can be used when scoring an application during underwriting and generating an initial decision on whether you wish to fund an amount. The combination of the flexible definition of these parameters, along with the scoring set up on the Scoring Models screen, allows you to automate much of the initial decision process in underwriting accounts.

The Formula Definition section on the Scoring Parameters screen allows you to build a mathematical expression to express the scoring parameter, test its validity, and locate specific information with the resulting scoring parameters. The system calculates scoring parameters using application data, credit bureau information, and applicant details.

To set up the Scoring Parameters

You can either define new **Scoring Parameters** or specify a new name in the **New Parameter** field and click **Create Copy** to create a copy of selected parameter with details.

1. Click **Setup > Setup > Products > Scoring Parameters**.
2. In the **Parameters** section, perform any of the [Basic Operations](#) mentioned in Navigation chapter.

Figure 4-4 Parameters

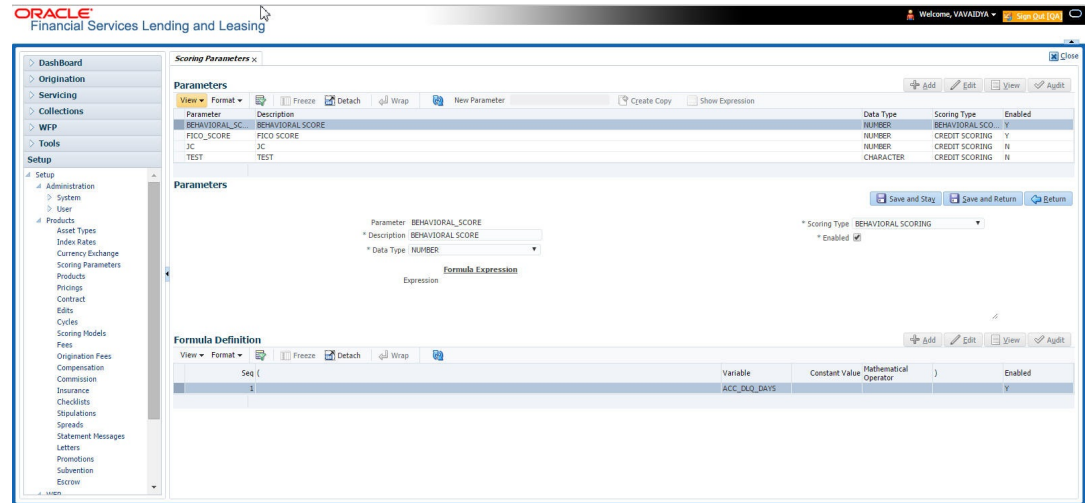

A brief description of the fields is given below:

Table 4-12 Parameters

Field	Do this
Parameter	Specify the name of the scoring parameter. The system recommends entering a name that in some way reflects how the parameter is used; for example, use FICO_SCORE instead of PARAMETER_1.
Description	Specify a description of the parameter. Again, Specify a name that reflects how the parameter is used; for example, use FICO SCORE and WEIGHTED FICO SCORE instead of FICO SCORE NUMBER 1 and FICO SCORE NUMBER 2.
Data Type	Select the data type of the scoring parameter being defined from the drop-down list. This determines how the system handles the values. (While DATE and CHARACTER are available data types, generally only NUMBER should be used when defining a scoring parameter.
Scoring Type	Select the scoring type from the drop-down list: CREDIT SCORING or BEHAVIORAL SCORING.
Enabled	Check this box to enable and indicate that the scoring parameter is available.

- Perform any of the [Basic Actions](#) mentioned in Navigation chapter. The **Formula Definition** section allows you to define a mathematical expression of the scoring parameter you want to define. The expression may consist of one or more sequenced entries. All arithmetic rules apply to the formula definition. If errors exist in the formula definition, the system displays an error message in this section when you choose Show Expression.
- In the **Formula Definition** section, perform any of the [Basic Operations](#) mentioned in Navigation chapter.
A brief description of the fields is given below:

Table 4-13 Formula Definition

Field	Do this
Seq	Specify the sequence number (the order in which the formula definition variable will be assembled and evaluated).
(Specify a left bracket, if you need to group part of your formula definition.
Variable	Select the variable from a validated field based on the user-defined table SCR_CRED_SUMMARY: SCORING PARAMETERS, from the drop-down list.
Constant Value	Specify the constant value (optional). You can specify varchar values which includes Numbers, Alphabets/ letters, special character/ symbols.
Mathematical Operator	Select the math operator to be used on the adjacent formula definition rows, from the drop-down list.
)	Specify a right bracket, if you are grouping part of your formula definition.
Enabled	Check this box to enable the formula and indicate that it is included when building a definition for the scoring parameter.

5. Perform any of the [Basic Actions](#) mentioned in Navigation chapter.
6. In the **Parameters** section, click **Show Expression**.
The mathematical expression appears in the Formula Expression section (in sequential order) in the Expression field.

4.5 Products

The Product screen defines the closed ended products your organization offers. This screen is enhanced to support Islamic along with the conventional.

A product is based on the following attributes:

- The collateral type and sub type
- The billing cycle
- Whether the amount is paid directly or indirectly to the customer

The Product Definition section records details about the product such as the description, start and end dates, collateral type and sub type, credit bureau reporting attributes, billing cycle, index and rate calculation attributes.

System supports **Biennial** (once every 2 years) and Triennial (once every 3 years) type of billing cycles. Based on the following lookups, the billing cycle **frequency** can be defined:

- BILL_CYCLE_CD
- LOC_BILL_CYCLE_CD - for Line of Credit accounts.

The Product Itemization section is used to define itemized entries for a product. This information is used on the Itemization sub screens of the Application Entry and Application screens.

The Rate Adjustments section is used to define the frequency of rate change allowed during interest rate calculations.

To set up the Product

You can either define new Product details or specify a new product code in the **New Product** field and click **Create Copy** to create a copy of selected product with details.

1. On the Oracle Financial Services Lending and Leasing home screen, **Setup > Setup > Administration > User > Products > Products > Line**.
2. In the **Product Definition** section, perform any of the [Basic Operations](#) mentioned in Navigation chapter.

Figure 4-5 Product Definition

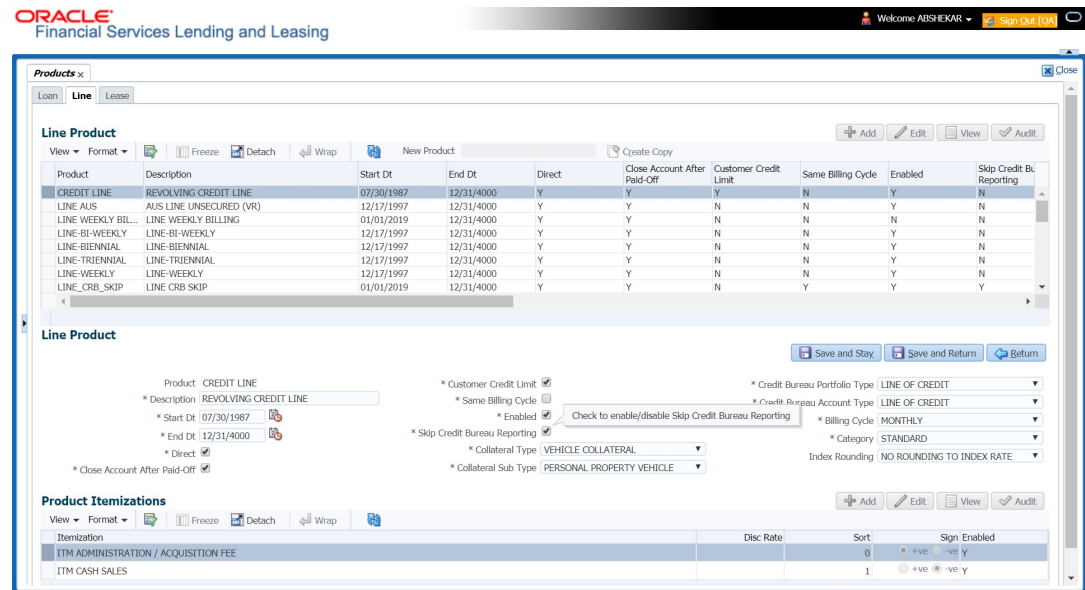

A brief description of the fields is given below:

Table 4-14 Product Definition

Field	Do this
Product	Specify the product code as defined by your organization (in other words, how you want to differentiate the products). For example, products can be differentiated according to asset. The product code, or name, is unique.
Description	Specify the description of the product. (This is the product description as it appears throughout the system).
Start Dt	Specify the start date for the product. You can even select the date from the adjoining Calendar icon.
End Dt	Specify the end date for the product. You can even select the date from the adjoining Calendar icon.

Table 4-14 (Cont.) Product Definition

Field	Do this
Direct	Check this box, if you need the product to be originated directly to customer. (In this case, the compliance state is the state listed in the customer's current mailing address.) If unchecked, the product is an indirect lending product; that is, payment is made to the producer. (In this case, the compliance state is the state listed in the producer's address.)
Close Account After Paid- Off	<p>Check this box to allow the account to be closed once the account is paid off i.e. system closes the account after the number of days specified in the system parameter has elapsed. This option is selected by default.</p> <p>If not selected, system ignores the system parameter and does not close the account even if the account is paid off i.e. system keeps the accounts active so that the equity can be traded with other accounts. For information on accounts trading, refer to Appendix - Trading of Accounts chapter.</p> <p>Note: If the business practice of a financial institution is not to close the accounts then this Indicator need to be unchecked. Mainly in the Vacation Ownership where a Timeshare product can be traded anytime even if the account is paid-off, this feature is used.</p>
Customer Credit Limit	<p>Check this box to enable Customer Credit Limit tab in Origination module. Using the Customer Credit Limit tab, an underwriter can define a specific credit limit for the customer while funding the first application and based on that credit limit, subsequent applications can be funded.</p> <p>For more information, refer to Customer Credit Limit details in User Guide.</p>
Same Billing Cycle	Check this box to set the same billing cycle (supported only billing cycles Monthly and Weekly) for all the future applications funded for an existing customer.
Enabled	<p>Check this box to activate the product.</p> <p>Note: You can check this box only when Rate adjustment schedule is maintained, i.e., All the products should be variable rate products.</p>

Table 4-14 (Cont.) Product Definition

Field	Do this
Skip Credit Bureau Reporting	<p>Check this box to skip credit bureau reporting of all Accounts funded with this product type - i.e. on funding an application, that particular account is enabled with this parameter and is excluded when the metro II batch job is run for credit bureau reporting.</p> <p>This option can also be enabled/disabled at individual account level in Servicing by posting Skip Credit Bureau Reporting Maintenance nonmonetary transaction.</p> <p>However note that existing behaviour of Stop Bureau Account condition would still be applicable.</p>
Collateral Type	Select the collateral type for the product, from the drop-down list. This field identifies what type of collateral is associated with the and assists the system in identifying the correct screen(s) to display.
Collateral Sub Type	Select the collateral sub type for the product, from the drop-down list.
Credit Bureau Portfolio Type*	Select the credit bureau portfolio type for the product, from the dropdown list.
Credit Bureau Account Type*	<p>Select the account type for the product, from the drop-down list.</p> <p>*Note: The Credit Bureau Portfolio Type and Credit Bureau Account Type fields determine how the portfolio is reported back to the credit bureaus.</p>
Billing Cycle	Select the billing cycle for the product, from the drop-down list.
Category	Select the category as Standard for the conventional product and Islamic for the Islamic product, from the drop-down list. This serves to group products for reporting purposes.
Index Rounding	<p>Select the index rate rounding factor for the product, from the drop-down list.</p> <p>Note: For more information, refer Appendix C: Rounding Amounts and Rate Attributes.</p>
Skip User Parameters Calculation	<p>Select this check box to exclude accounts from target parameter calculation.</p> <p>If unchecked, system picks-up the account during the processing of following batch jobs:</p> <ul style="list-style-type: none"> • CUPACC_BJ_111_01 (LOAN) • CUPACC_BJ_112_01 (LINE) • CUPACC_BJ_121_01 (LEASE)

3. Perform any of the [Basic Actions](#) mentioned in Navigation chapter.

This section consists of the following topics:

- [Product Itemizations](#)

4.5.1 Product Itemizations

1. Click **Setup > Setup > Administration > User > Products > Products > Line > Product Itemizations**.
2. In the Product Itemization sub screen, perform any of the [Basic Operations](#) mentioned in Navigation chapter.
A brief description of the fields is given below:

Table 4-15 Product Itemization

Field	Do this
Itemization	Select the itemization type for the product selected in product definition section, from the drop-down list.
Discount Rate	Specify the discount rate.
Sort	Specify the sort order.
Sign	Select +ve for a positive number and -ve for a negative number. Note: The +ve and -ve buttons determine whether the values will increase or decrease the itemization total for the product based on the selected product. Together the contents of the Product Itemization sub screen, positive and negative, add up to the amount.
Enabled	Check this box to indicate that this product itemization is currently available.

3. Perform any of the [Basic Actions](#) mentioned in Navigation chapter.

4.6 Pricings

The Pricing screen records pricing information related to your products. the system uses the information in the Pricing Definition section to identify the correct pricing for an application, depending upon the product and the specific application parameters. the system will always search for a unique match.

When you choose the **Select Pricing** while making a decision on the **Underwriting** window, the system displays the best match and completes the Pricing and Approved sections under Summary sub tab. The information in the Approved section cite the minimum amounts for the selected product, though the user can edit these figures.

The system determines the best match by looking at all enabled pricing strings on the Pricing screen that meet the following criteria:

- Exactly match the application values for the Promotion and Billing Cycle fields.
- Are less than or equal to the application values for the Term, Amount, Age, and Start Date fields.
- Match either the application value or ALL for all other criteria.

Exact matches for each field are given a higher weight than matches of ALL. The returned rows are then ranked based on the weighted values and the hierarchical position of the field (see above). They are then ranked by start date. The system recognizes the first row returned as the best match.

Note

- You should set up a default pricing for each billing cycle and pricing that the system can select to ensure error-free performance. Oracle Financial Services Software recommends creating a single version of each edit type, where ALL is the value in the selection criteria fields listed above. If the system cannot find a pricing match, it will display an error message.
- The system supports the bulk uploading of product pricing setup data. This allows you to upload multiple setup data, avoid re-entering setup data, and more importantly, reduce data entry mistakes. The system currently supports uploading using a fixed-length format only, where each data is at a pre-fixed position. You can run batch jobs with the Set Code SET-BLK to upload pricing and GL data.

System supports **Biennial** (once every 2 years) and **Triennial** (once every 3 years) type of billing cycles. Based on the following lookups, the billing cycle **frequency** can be defined:

- BILL_CYCLE_CD
- LOC_BILL_CYCLE_CD - for Line of Credit accounts

To set up the Pricing

1. On the Oracle Financial Services Lending and Leasing home screen, click **Setup > Setup > Administration > User > Products > Pricings > Line**.
2. In the Pricing Definition section, perform any of the [Basic Operations](#) mentioned in Navigation chapter.

Figure 4-6 Pricings

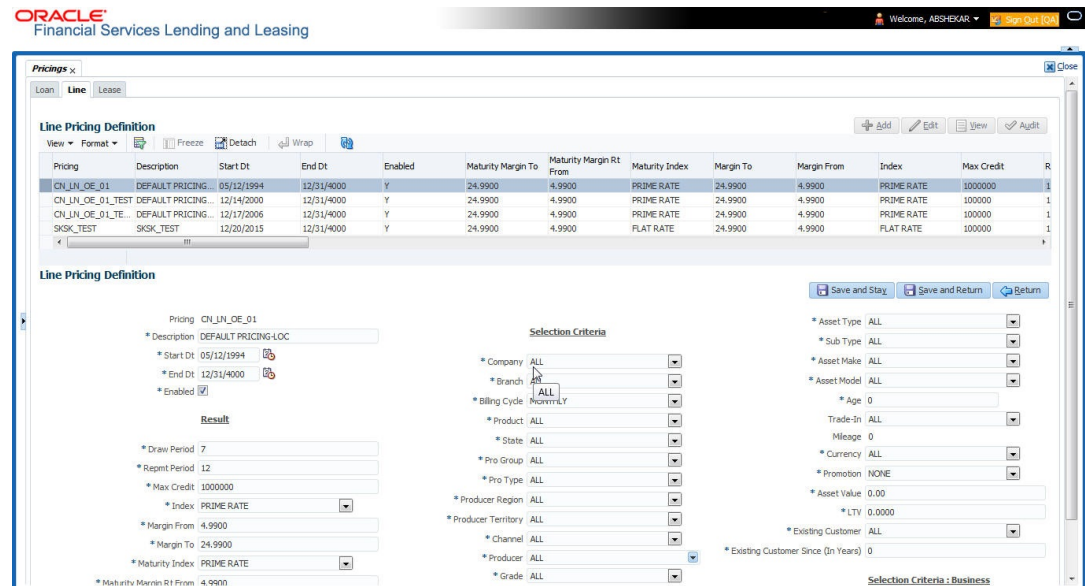

A brief description of the fields is given below:

Table 4-16 Pricing Definition

Field	Do this
Pricing*	Specify the code for the pricing.
Description*	Specify the description for the pricing.
* Together these two fields define the name of the pricing.	
Start Dt	Specify the start date for this pricing. You can even select the date from the adjoining Calendar icon.
End Dt	Specify the end date for this pricing. You can even select the date from the adjoining Calendar icon.
Enabled	Check this box to enable the pricing.
Result section	
Draw Period	Specify the draw term for which this pricing is valid.
Repmt Period	Specify the repayment term for which this pricing is valid.
Max Credit Index	Specify the maximum credit Limit for this pricing.
Margin From	Select the index type associated as FLAT/PRIME RATE from the drop-down list.
Margin To	Specify the minimum margin rate for the selected index type.
Maturity Index	Specify the maximum margin rate for the selected index type.
Maturity Margin Rt From	Select the maturity index type associated as FLAT/PRIME RATE from the drop-down list.
Maturity Margin To	Specify the minimum margin rate for the selected maturity index type.
Selection Criteria	
Company	Specify the maximum margin rate for the selected maturity index type.
Branch	Select the portfolio company for this pricing, from the drop-down list. This may be ALL or a specific company.
Billing Cycle	Select the portfolio branch for this pricing. This may be ALL or a specific branch. (This must be ALL if in the Company field you selected ALL), from the drop-down list.
Product	Select the billing cycle for this pricing, from the drop-down list.
State	Select the product for this pricing, from the drop-down list. This may be ALL or a specific product. The available values come from a validated field based on the selected billing cycle and the product setup.
Pro Group	Select the state for this pricing, from the drop-down list. This may be ALL or a specific state.
Pro Type	Select the producer group for this pricing, from the drop-down list. This may be ALL or a specific producer group.
	Select the producer type for this pricing, , from the drop-down list. This may be ALL or a specific producer type.

Table 4-16 (Cont.) Pricing Definition

Field	Do this
Producer Region	Select the region of the producer.
Producer Territory	Select the territory of the producer.
Producer	Select the producer from the drop-down list. This may be ALL or a specific producer. The available values come from a validated field based on the product group and product type.
Grade	Select the credit grade for this pricing, from the drop-down list. This may be ALL or a specific grade.
Credit Limit	Specify the minimum credit limit for which this pricing is valid.
Asset Class	Select the asset class from the drop-down list. This may be ALL or a specific asset class. The available values come from a validated field based on the collateral type. You may create additional user-defined lookup codes for these lookup types as needed.
Asset Type	Select the asset type from the drop-down list. This may be ALL or a specific asset type. The available values come from a validated field based your assets setup.
SubType	Select the asset sub type from the drop-down list. This may be ALL or a specific asset sub type. The available values come from a validated field based your assets setup, and is linked to the selected asset type.
Asset Make	Select the asset make from the drop-down list. The available values come from a validated field based your assets setup and is restricted based on the selected Asset Type and Asset Sub Type. For example, If ALL was selected for either Asset Type or Asset Sub Type, then ALL will be the only available selection for the asset make.
Asset Model	Select the asset model from the drop-down list. The available values come from a validated field based your assets setup, and is restricted based on the selected Asset Type and Asset Sub Type. If ALL was selected for either Asset Type or Asset Sub Type, then ALL will be the only available selection for the asset model.
Age	Specify the asset age (the minimum age for the selected pricing). Note: If your entry in this field is based on the number of years of age of the asset and not the actual year of make, you must update this entry annually to ensure that the proper pricing is available.
Trade-In	Specify if there is a trade in of an asset by selecting Yes/No.
Mileage	If there is a Trade-In of an existing asset, then specify its mileage in km.
Currency	Select the currency for this pricing, from the drop-down list.

Table 4-16 (Cont.) Pricing Definition

Field	Do this
Promotion	Select the promotion applicable to this pricing from the dropdown list. The available values come from a validated field based on the promotions setup.
Asset Value	Specify the asset value.
LTV	Specify the loan to value ratio.
Existing Customer	Select one of the following options from the drop-down list to define the applicability of the current pricing definition: ALL - Applicable to both existing and new customers YES - Applicable to existing customer only NO - Applicable to new customer only. Based on the selection criteria, system defaults the first pricing for applications with Existing customer flag = Y at primary applicant details.
Existing Customer Since (In Years)	Specify the duration from when customer account was created in the system up to the current date in years.
Selection Criteria : Business - allows you to indicate the age of business by evaluating the total number of years elapsed.	
Years In Business	Specify the total number of years in business.

3. Perform any of the [Basic Actions](#) mentioned in Navigation chapter.

4.7 Contract

The Contract screen allows you to define the instruments used within your system. A instrument is a contract used by a financial organization with specific rules tied to it. When processing an application, an instrument associated with the application informs the system of the type of contract being used for the approved product. This ensures that all parameters tied to the instrument are setup for the account as it is booked - without requiring you to do it.

Instruments can be setup at different levels:

- Company
- Branch
- Product
- Application state
- Currency

The following groups of parameters are setup at the instrument level (Each has its own section on the Contract screen):

- Selection Criteria
- Accrual
- Capitalization
- Scheduled Dues
- Billing

- Delinquency
- Extension
- Advance Details
- Rate Cap And Adjustments
- Other

Items defined in the contract are **locked in** when you choose Select Instrument on the Funding form's Contract link.

The Contract screen's Instrument and Description fields allow you to enter the financial instrument's name and description, .

System supports **Biennial** (once every 2 years) and **Triennial** (once every 3 years) type of billing cycles. Based on the following lookups, the billing cycle **frequency** can be defined:

- BILL_CYCLE_CD
- LOC_BILL_CYCLE_CD - for Line of Credit accounts

To set up the Contract

You can either define new Contract Definition details or specify a new name in the **New Instrument** field and click **Create Copy** to create a copy of selected contract with details.

1. On the Oracle Financial Services Lending and Leasing home screen, click **Setup > Setup > Administration > Products > Contract > Line**.
2. On the Contract Definition section, perform any of the [Basic Operations](#) mentioned in Navigation chapter.

Figure 4-7 Contract

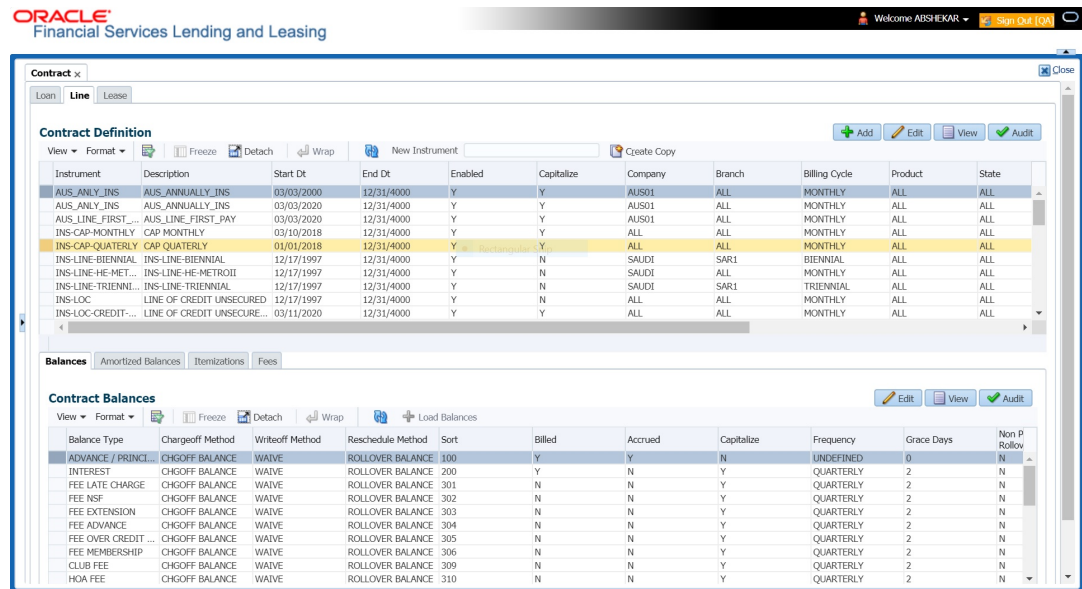

A brief description of the fields is given below:

Table 4-17 Contract Definition

Field	Do this
Instruments section	
Instrument	Specify the code identifying the instrument.
Description	Specify the description of the instrument being defined.
Start Dt	Specify the start date for the instrument. You can even select the date from the adjoining Calendar icon.
End Dt	Specify the end date for the instrument. You can even select the date from the adjoining Calendar icon.
Enabled	<p>If you check this box, the system will consider this contract definition when selecting a instrument for an application.</p> <p>Note: Once the field is enabled load balances button in balances sub tab will be disabled.</p>
Selection Criteria section	
Company	Select the company for the instrument from the drop-down list. This may be ALL or a specific company.
Branch	Select the branch within the company for the instrument from the drop-down list. This may be ALL or a specific branch. This must be ALL, if you have selected ALL in the Company field.
Billing Cycle	Select the billing cycle selected from the drop-down list.
Product	Select the product for the instrument from the drop-down list. This may be ALL or a specific product.
State	Select the state in which the instrument is used from the drop-down list. This may be ALL or a specific state.
Currency	<p>Select the currency for the instrument from the drop-down list.</p> <p>IMPORTANT: By selecting which type to use, the system searches for a best match using the following attributes:</p> <ol style="list-style-type: none"> a. Billing Cycle b. Start Date c. Company d. Branch e. Product f. State <p>Hence, Oracle Financial Services Software recommends creating one version of each type, where ALL is the value in these fields.</p>
Pricing	Select the pricing in which the instrument is used from the dropdown list. This may be ALL or a specific pricing.

Table 4-17 (Cont.) Contract Definition

Field	Do this
Accrual section	
Accrual Post Maturity	<p>Check this box to indicate that this is the post maturity default rate.</p> <p>Extensions allow you to extend the maturity of the contract by one or more terms by allowing the customer to skip one or more payments. The skipped terms are added to the end of the contract.</p>
Accrual Method	Select the accrual method used to calculate interest accrual for this instrument from the drop-down list.
Start Dt Basis	<p>Select to define the start date from when the interest accrual is to be calculated for this instrument from the drop-down list.</p> <p>Note:</p> <p>If you select the Effective Date, then the interest is calculated from the Contract date.</p> <p>If you select the Payment Date, then the interest is calculated based on (first payment date minus one billing cycle).</p>
Base Method	Select the base method used to calculate interest accrual for this instrument from the drop-down list.
Accrual Start Days	Specify the number of days for which the interest accrual is to be calculated.
Int Amortization Freq	<p>Select one of the following interest amortization frequency from the drop-down list:</p> <ul style="list-style-type: none"> • DAILY - if selected, the interest amortization (TAM) GL entries hand-over happens every day. • EVERY BILLING CYCLE MONTH END - if selected, the interest amortization (TAM) GL entries hand-over happens on month end of the account billing cycle. For example, if account billing cycle is quarterly, the GL handover happens on month end of the quarter. • EVERY MONTH END - if selected, the interest amortization (TAM) GL entries hand-over happens on month end of every calendar month. For example, even if the account billing cycle is quarterly, the GL handover happens on the calendar month.
Capitalization section	
<p>This section allows you to define capitalization parameters which helps to capitalize the corresponding account balances to the principal balance of the account based on specific frequency. For example, you can capitalize the accumulated Interest or Late Fees to principal balance of the account.</p> <p>You can either capitalize all the balances based on same frequency or define different frequency for each type of balance.</p> <p>Note: Capitalization parameters can also be updated by posting CAPITALIZATION MAINTENANCE monetary transaction.</p>	

Table 4-17 (Cont.) Contract Definition

Field	Do this
Capitalize	<p>Check this box to enable capitalization parameters for the contract. By default, this option is un-checked.</p> <p>The option is available only for Average daily balance Method Line of Credit.</p>
Frequency	<p>Select the required capitalization frequency from the drop-down list. The list contains the following types of frequency to either capitalize all the balances based on same frequency or define different frequency for each type of balance.</p> <ul style="list-style-type: none"> Based on specific intervals such as Monthly, Quarterly, Annual and so on. Based on contract Billing Frequency, Billing Date, or Due date. Specifically on every Month End. <p>-Or-</p> <ul style="list-style-type: none"> Based on Balance Frequency to define different capitalization frequency for each balance. This can further be defined in Balances sub tab.
Capitalization Start Basis	<p>Select the capitalization start date from the drop-down list as either Contract Date or First Payment Date to calculate the capitalization frequency accordingly.</p> <p>However, this field is not enabled for Billing date or Due Date type of capitalization frequency.</p>
Grace Days	<p>Specify the grace days allowed in the frequency (minimum 0, maximum 31) before capitalizing the balances to account. This is also the deciding factor for executing the capitalization batch job which is based on Capitalization Frequency + Grace Days.</p> <p>However, note that Grace Days are not accounted for Month End type of capitalization frequency and is ignored even if specified.</p>
Cap Tolerance Amt	<p>Specify the capitalization tolerance amount which is the minimum amount to qualify for capitalization. Any amount less than this is not considered for capitalization of balances.</p> <p>This helps to avoid capitalization of nominal or decimal amounts.</p> <p>Note: There is no specific accounting maintained for non-capitalized decimals with reference to setup.</p>
Scheduled Dues section	
Max Due Day Change Days	Specify the maximum number of days a due date can be moved.
Due Day Min	Specify the minimum value allowed for the due day for this instrument.

Table 4-17 (Cont.) Contract Definition

Field	Do this
Due Day Max	Specify the maximum value allowed for the due day for this instrument. Note: If billing cycle is selected as weekly, then Due Day Max field value cannot be greater than 7.
Max Due Day Change / Year	Specify the maximum number of due day changes allowed within a given year for this instrument.
Max Due Day Change / Life	Specify the maximum number of due day changes allowed over the life of a product funded with this instrument.
Billing section	
Pre Bill Days	Specify the prebill days. This is the number of days, before the first payment due, that accounts funded with this instrument will be billed for the first payment. Thereafter, the accounts will be billed on the same day every month. If an account has a first payment date of 10/ 25/2003 and Pre Bill Days is 21, then the account will bill on 10/04/ 2003, and then bill on the 4th of every month.
Billing Type	Select the billing type for accounts funded using this instrument from the drop-down list.
Draw Period Billing Method	Select the draw period billing method for accounts funded using this instrument from the drop-down list.
Repmt Billing Method	Select the billing method for the repayment period from the dropdown list.
Draw Billing %	Enter the payment percentage for the draw period.
Repmt Term Payment %	Enter the payment percentage for the repayment draw period.
Multiple Billing Asset Rate	Check this box to indicate if multiple asset rates are applicable for one billing period. System considers billing period from current due date to the next due date. Multiple rates are fetched only when rate end date (rate start date + rate frequency) ends one or more cycle(s) before the next due date i.e. current rate record does not cover the entire billing period.
Delinquency section	
Late Charge Grace Days	Specify the number of grace days allowed for the payment of a due date before a late charge is assessed on the account.

Table 4-17 (Cont.) Contract Definition

Field	Do this
Stop Accrual Days	<p>Specify the number of days a contract can be in delinquent state, after which the interest accrual must stop for an account.</p> <p>A Batch Job is run daily to select accounts in delinquent status for a pre-defined number of days and post No Accrual transaction for such accounts on current date. When the account recovers from Delinquency, the system will then post a Start Accrual Transaction on the date the account is recovered from delinquency.</p>
Delq Grace Days	<p>Specify the number of grace days allowed for the payment of a due date before an account is considered delinquent. This affects DELQ Queues, the system reporting, and the generation of collection letters.</p>
Time Bar Years	<p>Specify the total number of years allowed to contact the customer starting from the first payment date and beyond which the account is considered delinquent. You can specify any value between 0-999.</p>
Cure Letter Gen Days	<p>Specify the number of delinquency days to initiate cure letter generation.</p>
Cure Letter Valid Days	<p>Specify the number of days during which the issued cure letter is valid. Usually financial institutions will start the collection activities after the lapse of cure letter validity date.</p>
Delq Category Method	<p>Select the delinquency category method to determine how the system populates delinquency counters on the Customer Service form.</p> <p>Note: This value does not affect credit bureau reporting.</p>

Table 4-17 (Cont.) Contract Definition

Field	Do this
<p>Cycle Based Fees - This section allows to define the parameters for calculating cycle based fees at individual account level. Using the below parameters, system derives the Cycle Base Fees and updates the account balances on processing the following batch jobs - TXNCBC_BJ_100_01 (CYCLE BASED COLLECTION LATE FEE PROCESSING) and TXNCBL_BJ_100_01 (CYCLE BASED LATE FEE PROCESSING). For more information, refer to Fee Consolidation Maintenance section in Appendix chapter.</p>	
<p>System calculates the below type of fee in combination of associated and master account and is assessed only when total due crosses Threshold amount (that is defined in Setup > Products > Contract > Fees tab and Setup > Products > Fees screen):</p>	
<p>Fee Late Charge (FLC)</p> <ul style="list-style-type: none"> • Percentage of sum of payment due • Percentage of sum of standard payment • Percentage of sum of billed amount 	
<p>Cycle Based Collection Late Fee</p> <ul style="list-style-type: none"> • Flat amount • Percentage of sum of payment due • Percentage of sum of standard payment • Percentage of sum of billed amount • Percentage of payment due • Percentage of standard payment • Percentage of billed amount • Percentage of total due amount • Percentage of sum of total due amount 	
<p>Cycle Based Late Fee</p> <ul style="list-style-type: none"> • Flat amount • Percentage of sum of total due amount • Percentage of sum of payment due • Percentage of sum of standard payment • Percentage of sum of billed amount • Percentage of total due amount • Percentage of payment due • Percentage of standard payment • Percentage of billed amount 	
<p>Cycle Based Collection Late Fee</p>	<p>Check this box to enable cycle based collection late fee assessment on the account.</p> <p>If selected, the balance type CYCLE BASED COLLECTION LATE FEE is made available in the Balances tab which further allows to define how system should derive the balances when an account is booked and funded.</p> <p>If unchecked (default), system does not display the Cycle based Collection Late Fee balance in Contract > Balances tab on clicking Load Balances button.</p>

Table 4-17 (Cont.) Contract Definition

Field	Do this
Cycle Based Late Fee	<p>Check this box to enable cycle based late fee assessment on the account.</p> <p>If selected, the balance type CYCLE BASED LATE FEE is made available in the Balances tab which further allows to define how system should derive the balances when an account is booked and funded.</p> <p>If unchecked (default), system does not display the Cycle Based Late Fee balance in Contract >Balances tab on clicking Load Balances button.</p>
Cycle Based Collection Late Fee Grace Days	Specify the number of grace days allowed before cycle based collection late fee is assessed on the account. This field is enabled only if the Cycle Based Collection Late Fee option is checked above.
Cycle Based Late Fee Grace Days	Specify the number of grace days allowed before cycle based late fee is assessed on the account. This field is enabled only if the Cycle Based Late Fee option is checked above.
Fee Consolidation - If Cycle Based Late Fee is assessed based on above parameters, this section allows to enable/disable the option to consolidate the late fee at Master Account level.	
Late Charge at Master Account	Check this box to allow system to consolidate the late charge assessment at master account level.
Cycle Based Collection Late Fee at Master Account	<p>Check this box to allow system to consolidate the cycle based collection late fee assessment at master account level.</p> <p>Ensure that, the option Cycle Based Collection Late Fee is also checked for fee consolidation at Master Account level.</p>
Cycle Based Late Fee at Master Account	<p>Check this box to allow system to consolidate cycle based late fee assessment at master account level.</p> <p>Ensure that, the option Cycle Based Late Fee is also checked for fee consolidation at Master Account level.</p>
Extension section	
Max Extn Period / Year	Specify the maximum number of terms that the contract may be extended, within a given rolling calendar year.
Max Extn Period / Life	Specify the maximum number of terms that the contract may be extended, within the life of the line of credit.
Max # Extn / Year	Specify the maximum number of extensions that may be granted within a given rolling calendar year.
Max # of Extn / Life	Specify the maximum number of extensions that may be granted within the life of the line of credit.
Minimum # Payments	Specify the minimum number of payments that must be made before extension.

Table 4-17 (Cont.) Contract Definition

Field	Do this
Extension Gap in Months	Specify the gap between previous extension provided in the account and current one as specific number of months.
Advance Details section	
Min Initial Advance	Specify the minimum initial advance amount allowed. This is the smallest possible initial advance that can be disbursed to the borrower after funding.
Max Initial Advance	Specify the maximum initial advance amount allowed. This is the largest possible initial advance that can be disbursed to the borrower after funding.
Min Advance	Specify the minimum advance amount. This is the smallest advance amount that a borrower may subsequently request after the initial advance.
Max Advance	Specify the maximum advance amount. This is the largest advance amount that a borrower may subsequently request after the initial advance.
Rate Cap & Adjustments section	
Max Rate Increase / Year	Specify the maximum rate increase allowed in a year.
Max Rate Increase / Life	Specify the maximum rate increase allowed in the life of the line of credit.
Max Rate Decrease / Year	Specify the maximum rate decrease allowed in a year.
Max Rate Decrease / Life	Specify the maximum rate decrease allowed during the life of the line of credit.
Max # Adjustments / Year	Specify the maximum number of rate changes allowed in a year.
Max # Adjustments / Life	Specify the maximum number of rate changes allowed during the life of the line of credit.
Min Interest Rate (Floor)	Specify the minimum rate.
Max Interest Rate (Ceiling)	Specify the maximum rate.
Statement section	
<p>This section allows to define the preferences for Mock Statement generation at Master Account level. Generating a Mock Statement helps to mock the asset billing process with a future date and to get an upfront statement indicating future dues of Master and Associated Accounts. In Vacation Ownership industry, such statements are required to forecast future dues based on current Timeshare holdings.</p> <p>The selected preference here are propagated to Application > Contract screen when the instrument is loaded.</p>	
Mock Statement Req	<p>Select this check box to indicate if the account is to be include in Mock statement Generation.</p> <p>Note: Based on this selection, others fields related to Mock Statement below are enabled and becomes mandatory for providing details.</p>

Table 4-17 (Cont.) Contract Definition

Field	Do this
Mock Start Month	Select the start month of Mock Statements period from the dropdown list. Note: During the Mock Statement Next Run Date validation if next run date is less than Contract Date or GL Date, system moves the Mock Start Month to same month of next year. For more information, refer to Mock Statement Maintenance in Appendix - Non Monetary transactions sections.
Mock Statement Cycles	Select the total number of billings (between 1-12) that are to be generated post Mock Statement Start Date.
Mock Pre Statement Days	Specify the number of Pre bill days for Mock Statements generation.
Other section	
Refund Allowed	Check this box to indicate that refunding of customer over payments are allowed.
Refund Tolerance	Specify the refund tolerance amount. If the amount owed to the customer is greater than the refund tolerance, the over payment amount will be refunded if Refund Allowed box is selected.
WriteOff Tolerance Amt	Specify the write off tolerance amount. If the remaining outstanding receivables for accounts funded using this instrument is less or equal to the write off tolerance amount, the remaining balance on the account will be waived.
Pmt Tolerance Amt*	Specify the payment tolerance amount. This is the threshold amount that must be achieved before a due amount is considered PAID or DELINQUENT. If (Payment Received + Pmt Tolerance: \$Value) >= Standard Monthly Payment, the Due Date will be considered as satisfied in terms of delinquency. The amount unpaid is still owed.
Pmt Tolerance%*	Specify the payment tolerance percentage. This is the threshold percentage that must be achieved before a due amount is considered PAID or DELINQUENT. If Payment Received >= (Standard Monthly Payment * Pmt Tolerance% / 100), the due date will be considered satisfied in terms of delinquency. The amount unpaid is still owed. The system uses the greater of these two values.
Promise Tolerance Amt*	Specify the promise tolerance amount. This is the threshold amount that must be achieved before a due amount is considered KEPT or BROKEN. If (Payment Received + Promise Tolerance: \$Value) >= Promise Amount, the Due Date will be considered KEPT (satisfied).

Table 4-17 (Cont.) Contract Definition

Field	Do this
Promise Tolerance %*	Specify the promise tolerance percentage. This is the threshold percentage that must be achieved before a due amount is considered KEPT or BROKEN. If Payment Received >= (Promised Amt * Promise Tolerance%), the due date will be considered KEPT (satisfied). The system uses the greater of these two values.
Adv Tolerance	Enter the advance tolerance amount.
Adv Tolerance %	Enter the advance tolerance percentage
Default Pmt Spread	Select the default payment spread to be used when receiving payments for this account if one is not explicitly chosen, from the drop-down list.
Min Finance Charge	Enter the minimum finance charge amount.
Minimum Pmt	Enter the minimum billed amount.
Anniversary Period	Enter the anniversary term.
Repmt Currency	Select the currency from the drop-down list.
PDC Security Check	Check this box to indicate that post dated checks are the method of repayment for this contract.
ACH Fee Ind	Check this box to indicate that direct debit fee is included. Note: The ACH Fee/Direct Debit Fee balance will be displayed in Balances sub tab only when this checkbox is selected.

3. Perform any of the [Basic Actions](#) mentioned in Navigation chapter.

Extension of Terms

The system facilitates extension of terms, provided the following conditions are satisfied:

- Specified number or more payments made in the account
- Gap between the previous and current extension provided in the account must be a specific number of months that could be specified

If the above conditions are not satisfied, then the system displays an appropriate error message.

A new transaction Force Extension will be available. This transaction will be posted when you want the system to bypass the extension validations defined at the contract level.

When a backdated transaction with TXN Date exists before the transaction date of extension, all the transactions are reversed and posted again. If extension transaction is posted again, then the validation rules are not validated again.

This section consists of the following topics:

- [Balances](#)
- [Amortized Balances](#)
- [Itemizations](#)
- [Fees](#)

4.7.1 Balances

The Balances sub screen lists the balances that will be established when an account is booked and funded.

CAUTION: Please contact your Implementation Manager for changes to this section.

To set up the Balances

1. Click **Setup > Setup > Administration > User > Products > Contract > Line > Balances**.
2. On the Balances sub screen, perform any of the [Basic Operations](#) mentioned in Navigation chapter.

A brief description of the fields is given below:

Table 4-18 Balances

Field	Do this
Balance Type	Displays the balance type.
Displays the balance type.	Select the charge off method to determine how the outstanding amount of this balance type will be handled from the drop-down list, if the account becomes uncollectable and the product is charged off.
Writeoff Method	Select the write off method to determine how the outstanding amount of this balance type will be handled from the drop-down list, if the account is within the write off tolerance of being PAID.
Reschedule Method	Select the reschedule method to determine how the outstanding amount of this balance type will be handled from the drop-down list, if the account is rescheduled.
Sort	Specify the sort order of how account balances will appear on the Customer Service form's Balance screen.
Billed	Check this box to indicate that outstanding amounts for this balance type are considered a part of the billed amount. This also determines whether payments applied to this balance type are considered when satisfying outstanding amounts due.
Accrued	Check this box to indicate that outstanding amounts for this balance type will be included when interest is accrued against the account.
Non Performing Rollover	Check this box to indicate that non-performing is used as an intermediary status on your general ledger prior to charge off and want to create balances for non-performing accounts for this balance type. Note: (The Non-Performing Rollover box applies only to Balance Types of ADVANCE/PRINCIPAL and INTEREST. For all other Balance Types, this box would be cleared).

Table 4-18 (Cont.) Balances

Field	Do this
Non Performing Balance Type	Select the balance type you want to rollover from drop-down list, if you select the Non-Performing Rollover box (Advance/ Principal).
Enabled	Check this box to indicate that this balance type will be created when the account is booked and funded.
<p>This section is applicable if the capitalization frequency is selected as Balance Frequency for the contract and allows you to define capitalization parameters for a specific type of account balance such as Interest.</p> <p>Note: The value of parameters defined in this section supersedes the values defined in header section.</p>	
Capitalize	<p>Check this box to enable capitalization parameters for the selected balance type. By default, this option is un-checked.</p> <p>Note: The option is disabled for Advance / Principal type of Line contracts.</p>
Frequency	<p>Select the capitalization frequency from the drop-down list. Frequency can be selected using any of the following options:</p> <ul style="list-style-type: none"> Based on specific intervals such as Monthly, Quarterly, Annual and so on. Based on contract Billing Frequency, Billing Date, Due date. Specifically on every Month End.
Grace Days	<p>Specify the grace days allowed in the frequency (minimum 0, maximum 31) before capitalizing the balances to account. This is also the deciding factor for executing the capitalization batch job which is based on Capitalization Frequency + Grace Days.</p> <p>However, note that Grace Days are not accounted for Month End type of capitalization frequency and is ignored even if specified.</p>

3. Perform any of the [Basic Actions](#) mentioned in Navigation chapter. The system loads the currently defined balances for accounts.

If your organization maintains additional balances, contact your Implementation Manager for information regarding those balances.

4.7.2 Amortized Balances

With the Amortize Balances sub screen, user can select one or more balances to be amortized over the life of the Line of Credit. User can also define the amortization method.

To set up the Amortization Balances

1. On the **Setup**, click **Setup**. Under **Setup**, click **Administration**. Under **Administration**, click **User**.
2. Under **User**, click **Products**. Under **Products**, click **Contract**. Under **Contract**, click **Line**. Under **Line**, click **Amortized Balances**.

The **Amortized Balances** screen displays.

Figure 4-8 Amortization Balances

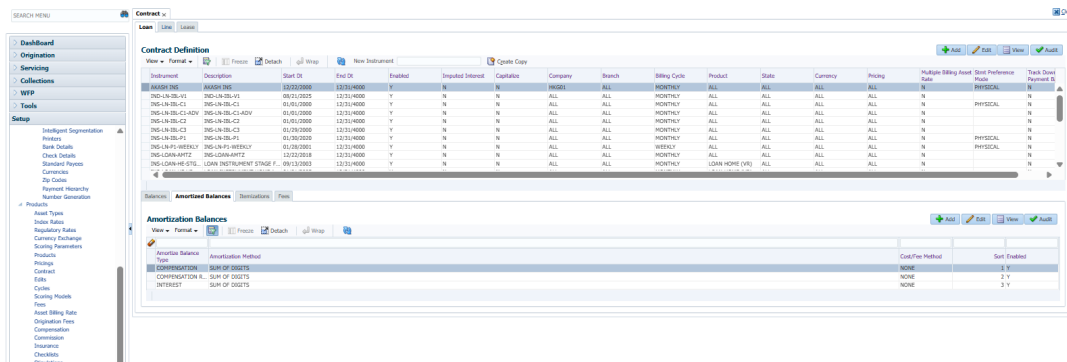

- In the Amortization Balances section, perform any of the [Basic Operations](#) mentioned in Navigation chapter.
A brief description of the fields is given below:

Table 4-19 Amortization Balances

Field	Description
Amortize Balance Type	Select the amortize transaction type from the drop-down list. The available options are: <ul style="list-style-type: none"> Prepaid Fees Producer Fees Interest Compensation Rent Depreciation Compensation Remaining Commission Insurance Commission Extended Service Contract Subvention
Amortization Method	Select the amortization method used to calculate the net amortization amount from the drop-down list.
Cost/Fee Method	Select the amortization cost/fee method.
Sort	Specify the sort sequence to define the order of the amortize balances.
Enabled	Check this box to enable the amortize balance to be created when the account is booked and funded.

- Perform any of the [Basic Actions](#) mentioned in Navigation chapter.

This section consists of the following topics:

4.7.3 Itemizations

On the Itemizations sub screen, you can define the itemized components for each type of contract, indicate if it is required, and determine whether it has a positive or negative bearing on the contract itemization math. You can establish the following groups of itemization transactions:

Advance	Total amount of the product that is not a part of financed fees; in other words, the total
---------	--

	amount the customer requested to be advanced.
Financed Fees	Fees rolled into the principal balance of the product. Financed fees are also considered to be a part of the finance charge.
Pre-Paid Fees	Fees that are paid by the consumer prior to the funding of the Line of Credit. These fees are not rolled into the balance of the product but are considered as part of the finance charge and are included in the calculation of the APR.
Producer	Fees that are paid to or by the producer of the Line of Credit; for example, a fee that is being charged to the producer. These transactions will affect proceeds.
Escrow	Allows you to connect the actual escrow itemization with the escrow type and the funding transaction.

To set up the Itemizations

1. Click **Setup > Setup > Administration > User > Products > Contract > Line > Itemizations**.
2. On the Itemization sub screen select the option button to indicate the type of itemization you are working with: Advance, Financed Fees, Pre-Paid Fees, Producer, or Escrow.
3. On the Itemization sub screen, perform any of the [Basic Operations](#) mentioned in Navigation chapter.
A brief description of the fields is given below:

Table 4-20 Itemizations

Field	Do this
Itemization	Select the itemization from the drop-down list.
Disbursement Type	Select the disbursement type from the drop-down list.
Transaction	Select the funding transaction type from the drop-down list.
Itemization Type	Select the itemization type from the drop-down list. Note: On selecting the Prefunding Txns as itemization type, it indicates that this particular itemization expects a payment from the customer prior to funding.
Sort	Specify the sort order to define the order of the itemization transactions.
Sign	If the itemized transaction increases the group balance, click +ve. -or- If the itemized transaction decreases the group balance, click -ve.

Table 4-20 (Cont.) Itemizations

Field	Do this
Enabled	Check this box to enable the itemization and indicate that this itemization transaction will be created when the account is booked and funded.
Amortize Balance	Select the amortize balance affected by this itemization transaction from the drop-down list. Note: Advance itemizations do not affect amortize balances.
Refund Calculation Method	Select the refund calculation method from the drop-down list.
Taxable	Check this box, if the itemization type is taxable. However, note that the taxable option defined in Setup > Administration > System > Sale Tax screen will supersede with this preference.
Seller Pmt	Check this box to enable seller payment.
Escrow	Select the escrow from the drop-down list.
Itemization Formula	Select the itemization formula description from the drop-down list.
Refund Calculation Method	Check this box to enable Refund calculation Method.
Escrow Required	If this is an escrow account, check this box to indicate that an escrow is required during the application process (though at that time the user can choose Opt Out to decline.)
Discount Rate	Specify the discount rate for the itemization.

4. Perform any of the [Basic Actions](#) mentioned in Navigation chapter.

4.7.4 Fees

Any fees that are defined in the contract are set up on the Fees sub screen. The system currently supports the following contract fees:

- Late charges
- Non sufficient funds
- Extensions
- Prepayment penalties
- Delay Fee
- ACH Fee

The Fees sub screen allows you to define those fees whose value and method of calculation are set at the time of the Line of Credit. As these amounts cannot be changed after the product is booked and funded, you should only set up fees here that will not change over the life of the Line of Credit. Individual contract fee types may be defined multiple times in order to create graduated fees.

Note

Certain fees, like late fees, can be set up at contract, as well as state level. In such cases, the contract fee, if present, is used first.

To set up the Fees

1. Click **Setup > Setup > Administration > User > Products > Contract > Line > Fees**.
2. In the Fees section, perform any of the [Basic Operations](#) mentioned in Navigation chapter. A brief description of the fields is given below:

Table 4-21 Contract Fees

Field	Do this
Type	Select the fee type from the drop-down list.
Txn Amt From	Specify the lowest transaction amount or balance amount against which this contract fee definition may be applied.
Credit Limit From	Specify the minimum value of credit limit for the pricing.
Method	Select the method of calculating the fee to be assessed from the dropdown list.
Frequency	Select the frequency of calculating the fee to be assessed from the drop-down list.
Threshold Amt	<p>This field is enabled only if the Contract Fee type is either CYCLE BASED COLLECTION LATE FEE or CYCLE BASED LATE FEE.</p> <p>Specify the threshold amount which is less than or equal to minimum fee amount to be assessed. Based on this amount, system calculates and posts the Cycle Based Collection Late Fee or Cycle Based Late Fee based on the account.</p> <p>If calculated fee amount is less than threshold amount, fee is posted with transaction amount = 0.</p> <p>If calculated fee amount is greater or equal to threshold amount, fee is posted based on existing min amt and max amt comparing logic.</p>
Min Amt	Specify the minimum fee amount to be assessed.
Max Amt	Specify the maximum fee amount to be assessed. If you selected FLAT in the Method field, then this field is not used and is normally populated as \$0.00.
Percent	Specify the fee percentage of the outstanding transaction amount to be assessed as a fee. This amount will be adjusted to fall within the Min Amount and the Max Amount.
Enabled	Check this box to create the selected contract fee when the account is booked and funded.

3. Perform any of the [Basic Actions](#) mentioned in Navigation chapter.

4.8 Edits

Edits ensure your organization's guidelines are properly followed and that all exceptions are sent to the appropriate personnel to review.

You can configure your system so that during the origination process, at each change to an application's status, the system will perform a set of edits on the Verification link's Edits screen (found on the Application Entry, Underwriting, and Funding windows).

Edits ensure your organization's guidelines are properly followed and that all exceptions are sent to the appropriate personnel to review. If the edits check fails, then the system will not allow the change of status, and the application will remain in its current status. This screen allows you to define the validations the system must perform on the Verification master tab, as the status of application changes.

Origination edits are used to validate applications entered through the standard Application Entry and Applications windows. The Edits screen contains two sections, the Edit Type Definition section and the Edit Sub Type Definition section.

To set up the Edits

You can either define new Edit Type Definition details or specify a new name in the **New Edit Type** field and click **Create Copy** to create a copy of selected edit type definition with details.

1. On the Oracle Financial Services Lending and Leasing home screen, click **Setup > Setup > Administration > User > Products > Edits > Line**.
2. On the Edits screen, choose Origination or Open Interface.
3. In the Edit Type Definition section, perform any of the [Basic Operations](#) mentioned in Navigation chapter.

Figure 4-9 Edits

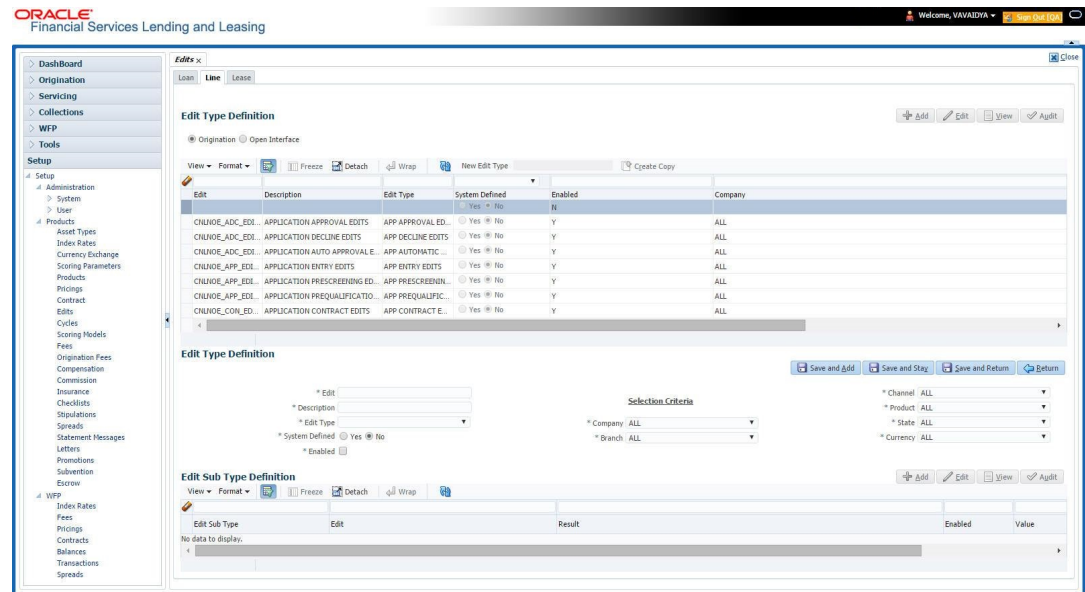

A brief description of the fields is given below:

Table 4-22 Edit Type Definition

Field	Do this
Edit	Specify the edit name.
Description	Specify the description for the edit.
Edit Type	Select the edit type code from the drop-down list.

Table 4-22 (Cont.) Edit Type Definition

Field	Do this
System Defined	Select Yes , if the entry is system defined. System defined entries cannot be modified. Select No , if the entry is not system defined and it can be modified.
Enabled	Check this box to enable the edit.
Company	Select the portfolio company associated with this edit, from the drop-down list. This may be ALL or a specific company.
Branch	Select the portfolio branch within the company associated with this edit, from the drop-down list. This may be ALL or a specific branch. This must be ALL if you selected ALL in the Company field.
Channel	Select the channel from the drop-down list, This can be ALL or a specific channel.
Product	Select the product associated with this edit, from the drop-down list. This may be ALL or a specific product.
State	Select the state with this edit from the drop-down list. This may be ALL or a specific product.
Currency	Select the currency associated with this edit, from the drop-down list. This may be ALL or a specific branch.

4. Perform any of the [Basic Actions](#) mentioned in Navigation chapter.
5. In the Edit Sub Type Definition section, perform any of the [Basic Operations](#) mentioned in Navigation chapter.
A brief description of the fields is given below:

Table 4-23 Edit Sub Type Definition

Field	Do this
Edit Sub Type	Select the edit sub type for the edit, from the drop-down list.
Edit	Select the description for the edit, from the drop-down list.
Result	Select the result type for the edit, from the drop-down list.
Enabled	Check this box to enable the edit.
Value	Specify the expected value for the first edit. The Value field records the threshold value for the edit. The actual function of the entered value is dependent on the edit category.
Override Responsibility	Select the responsibility that can override the edit, from the drop-down list, if the edit result is an override. Designates the user responsibility level required to continue processing applications that fail the edit based on the Value field. You may define the same edit multiple times with a Result = OVERRIDE and different Value and Override Responsibility combinations to encompass various results.

Table 4-23 (Cont.) Edit Sub Type Definition

Field	Do this
System Defined	Select Yes , if the entry is system defined. System defined entries cannot be modified. Select No , if the entry is not system defined and it can be modified.

6. Perform any of the [Basic Actions](#) mentioned in Navigation chapter. Using the **Edit Type** field of the **Edit Type Definition** section, you can define when you want the edits check to occur by selecting from the following list of edit types:

Table 4-24 Edit Type Definition

Edit type	Description
APP ENTRY EDITS	Edits that normally run on Application Entry form.
APP PRESCREENING EDITS	Edits that run between application entry and the pulling of a credit bureau. These edits determine whether the application should be reviewed further, and whether a credit bureau should be pulled.
PRE Qualify Edits	Edits that run to check whether the minimum details which are required to prequalify the application are satisfied or not.
APP AUTOMATIC APPROVAL EDITS	Edits that run after a credit bureau has been pulled and scored. These edits determine whether an application should be automatically approved or declined.
APP APPROVAL EDITS	Edits that run whenever an application is manually changed to a status/sub status that indicates the application (in its current state) should be approved.
APP DECLINE EDITS	Edits that run whenever an application is manually changed to a status/sub status that indicates the application (in its current state) should be declined.
APP CONTRACT EDITS	Edits that run whenever an APPROVED or CONDITIONEDAPPROVED application is about to be funded. These edits ensure the validity of the contract data.

Each entry in the Edit Sub Type field is grouped into the following categories:

Table 4-25 Edit Sub Type field

Origination edit sub types	Description
ORIGINATION APPLICANT EDITS	Edits that pertain to data entered for an applicant on an application.
ORIGINATION APPLICATION EDITS	Edits that pertain to data entered for the requested line of credit.
ORIGINATION ASSET EDITS	Edits that pertain to data entered for asset entered on the application.
ORIGINATION CONTRACT EDITS	Edits that pertain to data entered for the contract on the application.

Table 4-25 (Cont.) Edit Sub Type field

Origination edit sub types	Description
ORIGINATION CREDIT BUREAU EDITS	Edits that pertain to data gathered from the credit bureau reports for the applicants on the application.
ORIGINATION DECISION EDITS	Edits that pertain to data required to make a decision on the application.

Each entry in the Edit Sub Type field can be set up with more than one entry in the Description field. The purpose of specific edits fall into the following types:

Table 4-26 Description

Description starts with	(Edit Category) Description of Edit Category
CHD:	(RECORD POPULATION EDITS) Check for the existence of an entire data record.
DUPLICATE:	(DUPLICATION EDITS) Check for duplication of existing data.
RANGE:	(VALUE RANGE/TOLERANCE EDITS) Check to determine whether data entered for a specific data field is within the specific tolerance.
REQUIRED:	(REQUIRED FIELD EDITS) Check to determine whether a specific data field has been populated within a data record.
FLK:	(LOOKUP VALUE EDIT) Check API entered data against the existence of that value in the related lookup types lookup codes.
XVL:	(CROSS VALIDATION EDIT) Check to determine whether specific field, or set of fields, value corresponds to a value obtained by calculating them from another field or set of fields (for example, Total Payments = Terms * Standard payment amount).

An Edits check can produce one of three results: an ERROR, a WARNING, or an OVERRIDE.

Table 4-27 Edits check

Edit type	Results
ERROR	The system will prevent you from proceeding when an edits check fails. The only option is to change the source data. The application will revert to its previous status/sub status. The user will be directed to correct the specific error. Until the edits that return an ERROR value are addressed, the user cannot continue processing the application.

Table 4-27 (Cont.) Edits check

Edit type	Results
Warning	When an edits check fails in these cases, the system allows the process to continue. Warnings serve as informational messages and can be ignored. The user will be notified that an edit failed, but the failure need not stop the current processing of the application. The user can either ignore the error, or have the application revert to its previous status/sub status and address the error before processing the application further.
Override	The edit check has failed; however, the system allows users with the responsibility specified in the Override Responsibility field to continue. Multiple override levels can be setup depending upon the resulting value of the edit. If the user has override responsibility, the application will process as if the edit had not failed. If the user does not have override responsibility, the application will revert to its previous status/sub status and the sub status changes to OVERRIDE REQUIRED. The system will then direct the application to a user with the authority to process the application. (See the Queues chapter for more information).

Note

Do not set the Result field to Override for credit application edits.

This section consists of the following topic:

- [Interfacing OFSLL with Oracle Rule Author](#)

4.8.1 Interfacing OFSLL with Oracle Rule Author

Oracle Business Rules is a component of Oracle Application Server that enables applications to rapidly adapt to regulatory and competitive pressures. This increased agility is possible due to the adoption of Oracle Rule author wherein a lending Institution can create or change a business rule without having to indulge in coding and also without stopping the business process. Also, externalizing business rules allows to manage business rules directly, without involving programmers. It provides best of breed solutions that would help in configuring the rules very quickly by a business analyst or user with some insight on the database.

4.9 Cycles

The Cycles screen allows you to define the origination workflow process of your organization. As you delineate the steps in the origination process, you will also define:

- The user responsibilities that have access to perform the steps
- Any edits you want the system to perform between changes in status/sub status.

The following diagram displays the general concept of workflow:

Figure 4-10 Application Entry - Flowchart

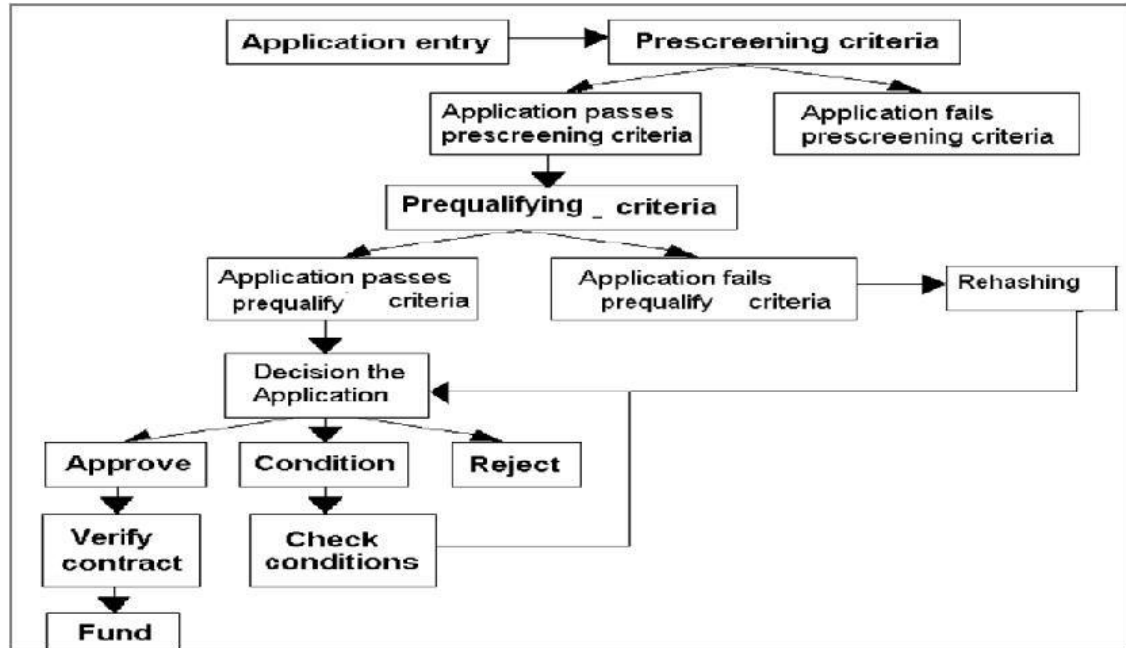

Cycle code definitions drive the application cycle. The following pairs of status/sub status define status/sub statuses that have system defined meanings and should be included in your origination workflow, if they are not already included.

After entering the basic details of the applicant, you can check whether the application prequalifies or not. If the pre-qualified edits are satisfied, the status is changed to **NEW-PREQUALIFY APPROVED** and you can modify or update any further details in the Application Entry screen. If the edits are not satisfied, the application will be pushed to the REJECTED APPLICATIONS queue with a status update to **REJECTED-PREQUALIFY REJECTED**, then you can also view the rejected pre-qualification in the Underwriting window.

Note

The system status and sub status lists are predefined and cannot be changed by the administrator. If you require additional sub status codes, please contact Oracle Financial Services Software to determine whether they can be added.

Table 4-28 Cycle code definitions

Status/Sub status	Description
NEW-BLANK	This is the status/sub status of applications during data entry. Applications remain NEW-BLANK until you choose the Next Application on the Application Entry form and the system successfully performs the application edits check.
NEW-PRESCREEN	The system processes the prescreen edits to determine whether a credit report should be pulled for this application or not.

Table 4-28 (Cont.) Cycle code definitions

Status/Sub status	Description
NEW-PRESCREEN APPROVED	Applications in this status/sub status have passed the prescreen edits. The system will now request a credit bureau pull.
NEW-PREQUALIFICATION	The system checks the applicant details whether it is qualified or not.
NEW-PREQUALIFY APPROVED	If the pre-qualified edits are satisfied, the status is changed to NEW-PREQUALIFY APPROVED and you can modify or update any further details in the Application Entry screen.
REJECTED-PREQUALIFY REJECTED	If the edits are not satisfied, the application will be pushed to the REJECTED APPLICATIONS queue with a status update to REJECTED-PREQUALIFY REJECTED.
REJECTED-PRESCREEN REJECTED	Applications in this status/sub status failed the prescreen edits. These applications will receive no further processing. The producer will be sent a decision fax and the consumer will receive an adverse action letter.
NEW-REVIEW REQUIRED	Either based on the scoring of the application's credit bureau(s) pull, or the fact that a credit bureau report was not successfully obtained, the application needs to be reviewed by an underwriter.
NEW-RECOMMEND APPROVAL	Based on the scoring of the application's credit bureau(s) pull, the application should be reviewed by an underwriter. However, based on the current setup, the system recommends approving this application.
NEW-RECOMMEND REJECTION	Based on the scoring of the application's credit bureau(s) pull, the application should be reviewed by an underwriter. However, based on the current setup, the system recommends rejecting this application.
APPROVED-AUTO APPROVED	Based on the scoring of the application's credit bureau(s) pull, the system automatically approves the application. The producer will be sent a decision fax, and the application will be passed to funding.
REJECTED-AUTO REJECTED	Based on the scoring of the application's credit bureau(s) pull, the system automatically rejects the application. The producer will be sent a decision fax and the consumer will receive an adverse action letter.

Table 4-28 (Cont.) Cycle code definitions

Status/Sub status	Description
APPROVED-BLANK	Application has been manually approved. Normally this occurs when an application is in the NEW-RECOMMEND APPROVAL, NEWRECOMMEND APPROVAL status/sub status, or less often in the NEW- RECOMMEND REJECTION status/sub status. Any cycle code definition with next values of APPROVED-BLANK should have a lookup value of APP APPROVAL EDITS to ensure that all of the required data has been gathered in making the decision to approve the application (unless the application is currently in a status/sub status that assures the APP APPROVAL EDITS have been run).
NEW-OVERRIDE REQUIRED	A user without sufficient override authority attempted to approve an application, which, based on setup, required a higher over-ride authority to approve.
APPROVED-VERIFYING	Contract has been received from the producer.
APPROVED-FINAL DOCUMENT CHECK	The contract has been reviewed and the data is correct. Normally this occurs when an application is in APPROVED-FINAL DOCUMENT CHECK OR CONDITIONED-FINAL DOCUMENT CHECK status/sub status. Any cycle code definition with next values of APPROVED-FINAL DOCUMENT CHECK or CONDITIONED-FINAL DOCUMENT CHECK should have a value of APP CONTRACT EDITS to ensure that all of the required data has been gathered in making the decision to approve the application, unless the application is currently in a status/ sub status that assures the APP CONTRACT EDITS have run.
APPROVED-VERIFIED	The application has been processed and is awaiting funding.
APPROVED-FUNDED	The application has been funded, and a check requisition has been created. If Customer Service form is being used, then an account is also created at this time.
REJECTED-BLANK	The application for whatever reason is being manually rejected regardless of its current status/sub status. Any cycle code definition with Next values of REJECTED-BLANK should have a lookup value of APP DECLINE EDITS to ensure that all of the required data has been gathered in making the decision to approve the application (unless the application is currently in a status/sub status that assures the APP DECLINE EDITS have run).
WITHDRAWN-BLANK	The applicants have indicated that they are no longer pursuing this line of credit.
CONDITIONED -<ANY>	These status/sub status pairs are analogous to the corresponding APPROVED-<ANY> pair and indicate that the application has had additional conditions placed on its approval.

Table 4-28 (Cont.) Cycle code definitions

Status/Sub status	Description
<ANY>-<ANY OVERRIDE>	Requires OVERRIDE approval. The meaning of the sub status is analogous to the corresponding OVERRIDE sub status, and may require that specific EDITS run before proceeding.
<ANY>-AGED APPLICATION	These applications have been decided but no contract has been received after a period of time determined by setup. If not acted on, these applications will become VOID.
<ANY>-AGED CONTRACT	Contracts have been received after a period of time determined by setup. If not acted on these applications will become VOID.
<ANY>-VOID	Indicate application previously had a sub status of AGED CONTRACT or AGED APPLICATION. These applications have not been completed and were made VOID after another period of time had passed.

Using these status and sub status, let us re-examine the early workflow diagram in this section.

Figure 4-11 Application Entry - Flowchart 2

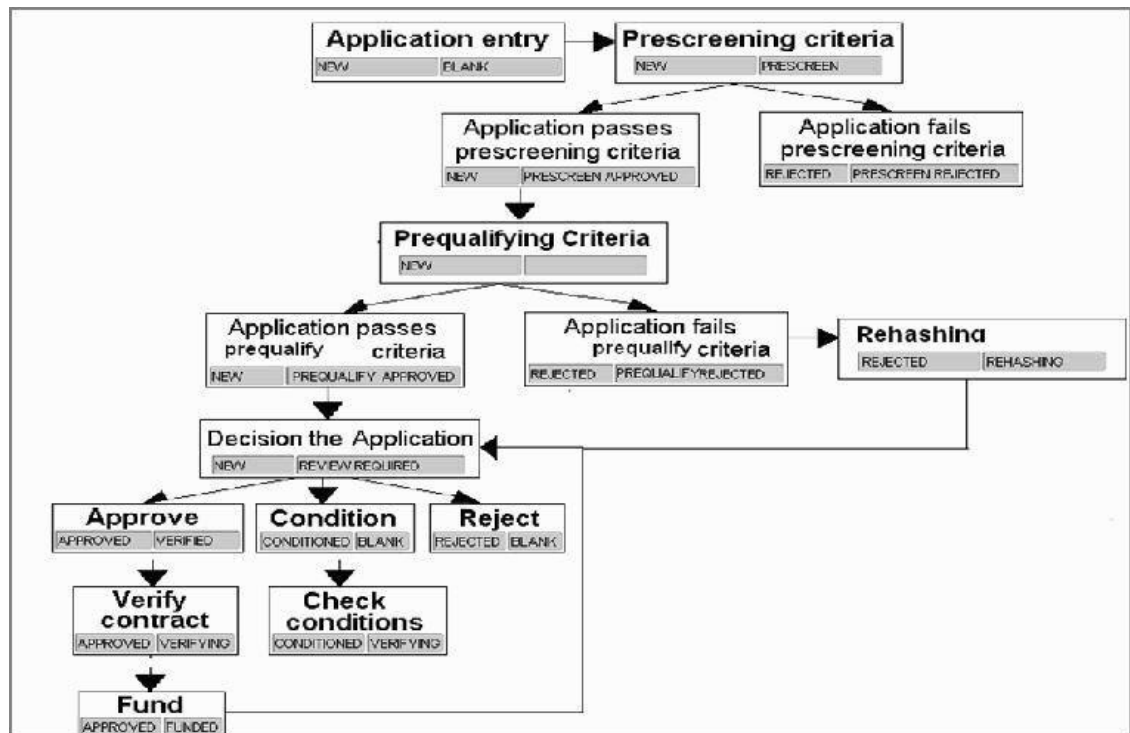

In the Cycles setup screen, you can also define how Status change of an application is to be permitted in the system i.e. you can configure the system to validate and allow a specific user / responsibility to perform the subsequent status change of the application.

It is like either same **User/Responsibility** is **Permitted** or **Not Permitted** to perform subsequent cycle changes of an application. This can be achieved in Cycle Code Definition section in **Validate Successive Change** field.

Note

It is extremely important that the APP CONTRACT EDITS run prior to an application being funded. All cycle code definitions should be reviewed to ensure that there are no paths through the origination cycle that bypass this EDIT type.

To set up the Cycles

1. On the Oracle Financial Services Lending and Leasing home screen, click **Setup > Setup > Administration > User > Products > Cycles > Line**.
2. In the **Cycle Definition** section, perform any of the [Basic Operations](#) mentioned in Navigation chapter.

Figure 4-12 Cycle Definition

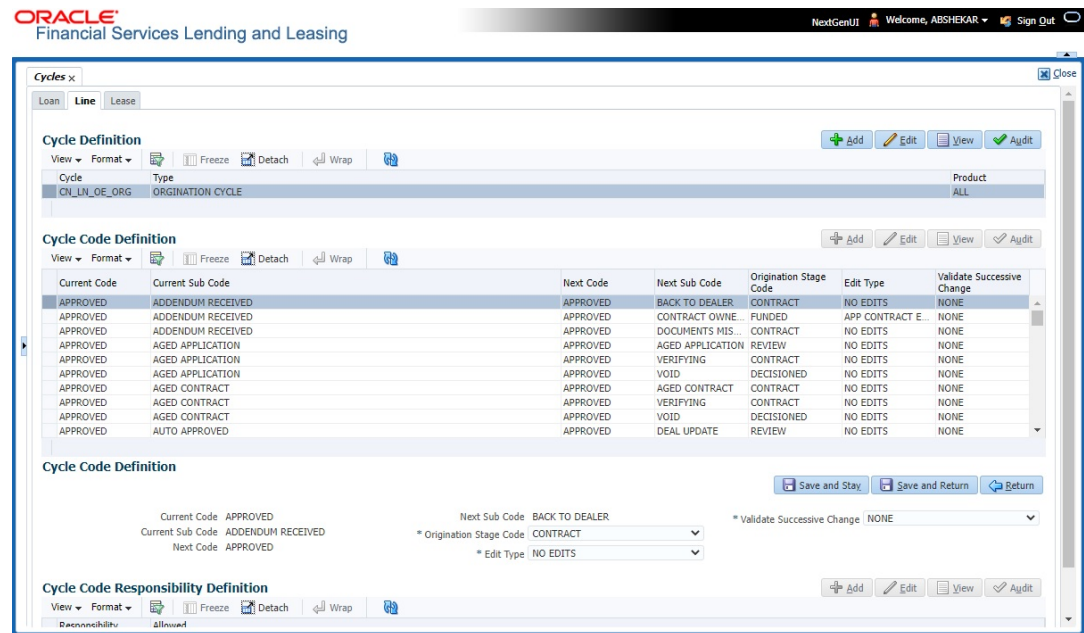

A brief description of the fields is given below:

Table 4-29 Cycle Definition

Field	Do this
Cycle	Specify the cycle code.
Type	Displays the cycle type.
Product	Select the product from the drop-down list.

3. In the **Cycle Code Definition** section, perform any of the [Basic Operations](#) mentioned in Navigation chapter.
A brief description of the fields is given below:

Table 4-30 Cycle Code Definition

Field	Do this
Current Code	Select the current code to transition FROM, from the drop-down list.
Current Sub Code	Select the current sub code to transition FROM, from the dropdown list.
Next Code	Select the current code to transition TO from the drop-down list.
Next Sub Code	Select the next sub code to transition TO, from the drop-down list.
Origination Stage Code	Select the origination stage code of the application from the adjoining drop-down list.
Edit Type	Select the edit type to associate to the cycles, from the drop-down list.
Validate Successive Change	<p>Select the type of user / responsibility who is permitted to perform application status change. The following options are available in the drop-down list as maintained in the Lookup Type STATUS_CHANGE_VALIDATION_CD.</p> <p>NONE: (Default option) Here system does not validate for User / Responsibility while making status change.</p> <p>USER - SAME: Here system validates for same User while making the status change.</p> <p>USER - DIFFERENT: Here system validate for different User while making the status change.</p> <p>RESPONSIBILITY - SAME: Here system validates for same Responsibility of the Current User while making the status change.</p> <p>RESPONSIBILITY - DIFFERENT: Here system validates for different Responsibility of the Current User while making the status change.</p> <p>Note that, the application status change is further controlled by Sub Code value defined in cycle setup for Lookup Type STATUS_CHANGE_VALIDATION_CD. For example, if Sub Code =2 for USER - SAME Lookup Code, then the previous 2 cycles of status change has to be performed by the same user.</p> <p>When a wrong user/responsibility is trying to change the status of the application, system validates with above selection and displays an error indicating User/Responsibility must be same or different between current and previous status change.</p> <p>During such cases, to know which User or Responsibility has performed the previous application status change, refer to appropriate columns in Underwriting / Funding > Verification tab > History sub tab.</p>

4. Perform any of the [Basic Actions](#) mentioned in Navigation chapter.
5. In the Cycle Code Responsibility Definition section, you can define the responsibilities that are authorized to change the code. If you have selected a specific user / responsibility in the **Validate Successive Change** field in the above section, it is recommended to define

the user responsibility in this section. Perform any of the [Basic Operations](#) mentioned in Navigation chapter.

A brief description of the fields is given below:

Table 4-31 Cycle Code Responsibility Definition

Field	Do this
Responsibility	Select the responsibility that will be capable of executing this transition, from the drop-down list.
Allowed	Select Yes to allow change to the status responsibility and No to disallow.

6. Perform any of the [Basic Actions](#) mentioned in Navigation chapter.

4.10 Scoring Models

The Scoring screen allows you to setup individual and multiple scoring models. You can define different scoring models by company, branch, currency and product. Scoring models are used to automate the decisioning process during underwriting and grade applications.

When you complete the Application Entry process, the system determines which scoring model to use by finding a best match. The system searches the Company, Branch, Currency and Product fields of all enabled scoring models that contain either the exact value on the application or ALL. (Exact matches for each field are given a higher weight than matches to ALL.) The system then ranks the returned matches in descending order, based on the weighted values and the hierarchical position of the field and then by Start Date. The system recognizes the first row returned as the best match. This scoring model information is then used to determine the next status and sub status of the application.

If you use a standard bureau score as a scoring model, you can set up the system to use the adverse action reasons provided by the standard bureau score on the Stipulations sub screen.

To set up the Scoring

On the Oracle Financial Services Lending and Leasing home screen, click **Setup > Setup > Administration > User > Products > Scoring Models > Line**. You can set the following categories of scoring models:

- [Credit Score Models](#)

4.10.1 Credit Score Models

You can either define new Credit Score Model or specify a new name in the **New Credit Model** field and click **Create Copy** to create a copy of selected score model with details.

1. Click **Setup > Setup > Administration > User > Products > Scoring Models > Line > Credit Score Models**.
 - In the **Score Models** section, perform any of the [Basic Operations](#) mentioned in Navigation chapter.

Figure 4-13 Score Models

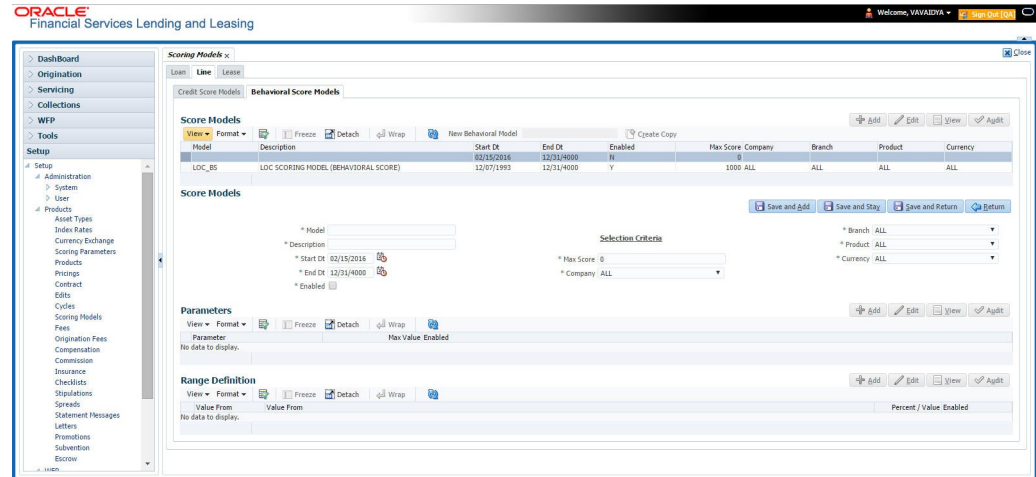

A brief description of the fields is given below:

Table 4-32 Score Models

Field	Do this
Model	Specify the code for the scoring model.
Description	Specify a description of the scoring model.
Start Dt	Specify the start date for the scoring model. You can even select the date from the adjoining Calendar icon.
End Dt	Specify the end date for the scoring model. You can even select the date from the adjoining Calendar icon.
Enabled	Check this box to enable the scoring model.
Results section	
Max Score	Specify the maximum score allowed. (This is normally the sum of the Max Value fields within the scoring parameters.).
Selection Criteria section	
Company	Select the company for the scoring model, from the drop-down list. This may be ALL or a specific company.
Branch	Select branch within the company for the scoring model, from the drop-down list. (This may be ALL or a specific branch. However, if you have selected ALL in Company field, then you must select ALL for this field).
Product	Select the product for the scoring model, from the drop-down list. This may be ALL or a specific product.
Currency	Select the currency for the scoring model, from the drop-down list. This may be ALL or a specific currency.

Table 4-32 (Cont.) Score Models

Field	Do this
Bureau Score Reasons	Check this box to use the score reasons supplied by the credit bureau. If unchecked, then automatically rejected applications scored using this scoring model display the Adverse Action Reasons from the Parameters sub screen.
Auto Decision	Check this box to assign an application, a status/sub status based on the grade associated with the score returned for this scoring model. If not selected, the system assigns applications scored using this scoring model a status/sub status of NEW-REVIEW REQUIRED.

2. Perform any of the [Basic Actions](#) mentioned in Navigation chapter.

Parameters

The Parameters records the parameters used to determine the score calculated by the scoring model. You can define multiple parameters and adverse action reason associated with each parameter in a scoring model. Each scoring parameter can have maximum values set. The score range is based upon the information in the Range Definition section on the Parameters sub tab.

The system calculates a final score by adding the score for each parameter in the scoring model. A parameter weighted value is used to find the four adverse action reasons, if bureau reasons are not used.

① Note

- A character parameter range definition should contain the exact value of the parameter.
- Each scoring parameter should have range definitions defined that encompass all of the values that might result.

1. Click **Setup > Setup > Administration > User > Products > Scoring Models > Line > Credit Score Models > Parameters**.
2. In the Parameters section, perform any of the [Basic Operations](#) mentioned in Navigation chapter.
A brief description of the fields is given below:

Table 4-33 Parameters

Field	Do this
Parameter	Select the parameter from the field, from the drop-down list.
Max Value	Specify the maximum value allowed for the selected parameter.

Table 4-33 (Cont.) Parameters

Field	Do this
Adverse Action Reason	Select the adverse action reason, from the drop-down list. (If, on the Scoring Models screen, the Bureau Screen check box is checked for the scoring model, you cannot update this field).
Weighted Value	Specify the adverse action weighted value. This indicates the priority of this parameter when determining which adverse action reasons to use on the application. The top ten adverse action reasons based on the weighted value of the parameter will be populated.
Enabled	Check this box to enable the parameter.

3. Perform any of the [Basic Actions](#) mentioned in Navigation chapter.
4. The Range Definition section allows you to translate the calculated value for a scoring parameter into the value to be used, depending on the returned value of the parameter.
5. In the Range Definition section, perform any of the [Basic Operations](#) mentioned in Navigation chapter.
A brief description of the fields is given below:

Table 4-34 Range Definition

Field	Do this
Value From	Specify the lowest calculated value to apply the specific translation. The ceiling of the range definition is based on the range definition with the next highest Value From or the Max Value of the scoring parameter (whichever is less).
Value From	Select the following options to determine how values for a scoring parameters are translated: % Max Value – If selected, then the calculated values within the range definition receives a value based on a percentage of the Max Value of the scoring parameter. % Param – If selected, then the calculated values within the range definition receives a value based on a percentage of the calculated value of the scoring parameter. Value – If selected, then the calculated values with in the range definition receives a specific value.
Percent / Value	Specify the percent or value to be used in the translation of the calculated value of the scoring parameter.
Enabled	Check this box to consider this range definition while translating values for this scoring parameter.

6. Perform any of the [Basic Actions](#) mentioned in Navigation chapter.

Grades

The Grades sub screen allows you to define how the system translates the scoring model scores into your organization's grade. The system uses these grades in the auto-decisioning

process. Each grade has a specific status/sub status that informs the system what to do with the application of a particular grade as it continues through the origination cycle.

Note

Each scoring model should have grade definitions defined that encompass all of the values that might result.

1. Click **Setup > Setup > Administration > User > Products > Scoring Models > Line > Credit Score Models > Grades**.
2. In the Grade Definition section, perform any of the [Basic Operations](#) mentioned in Navigation chapter.
A brief description of the fields is given below:

Table 4-35 Grade Definition

Field	Do this
Score	Specify the score the application receives.
Credit Grade	Select the grade to assign to an application, from the dropdown list.
Application Status	Select the status to assign to applications with a score starting with the value of this grade definition, from the drop-down list.
Sub Status	Select the sub status to assign to applications with a score starting with the value of this grade definition, from the dropdown list. Credit scoring allows you to select the following status/sub status pairs: APPROVED - AUTO APPROVED REJECTED - AUTO REJECTED NEW - REVIEW REQUIRED NEW - RECOMMEND APPROVAL NEW - RECOMMEND REJECTION.
Enabled	Check this box to indicate that this grade definition will be considered when grading an application using this scoring model.

3. Perform any of the [Basic Actions](#) mentioned in Navigation chapter.

4.11 Fees

The Fee screen allows you to define fees that may be automatically assessed by the system. The Fee Definition section records fees not defined within the Contract screen's Fees sub screen.

The following fee types are currently supported for automatic assessment:

- Late charge
- NSF
- Extension
- Advance

- Over Credit Limit
- Membership
- Prepayment penalty
- Phone Pay
- Payoff Quote
- Periodic Maintenance Fee
- Rental Fee
- ACH Fee
- Delay Fee
- Other Fee and Tax

Fees can be calculated as either a flat amount or a percentage of payment due based on fee type.

You can specify minimums and maximums for fee amounts in the Min Amt and Max Amt fields. Different fee rules can be setup at the company/branch level.

During the life cycle of a , it is required to post certain recurring charges or payments that occur at regular intervals, such as monthly, quarterly, or annually which is termed as periodic fees. System allows to post multiple Periodic fees to handle recurring auto-post fee definitions on account by the corresponding batch job. Accordingly you can configure multiple Periodic Fee definitions using Fee Type = FEE PERIODIC MAINTENANCE and FEE PERIODIC MAINTENANCE 1 up to 5 i.e. FPMF, FPMF1, FPMF2, FPMF3, FPMF4, and FPMF5.

When Fees are assessed, the system determines the best match using all enabled fee definitions that meet the following criteria:

- Exactly match the fee type being assessed.
- Have an effective date that is greater than or equal to the start date.
- Have a Txn Amt From that is greater than or equal to the outstanding amount related to the fee assessment.
- Match either the value or ALL for all other criteria (Exact matches for each field are given a higher weight than matches to ALL.)

The returned rows are then given a descending rank based on the weighted values and the hierarchical position of the following criteria:

1. Company
2. Branch
3. Product
4. Application state
5. Transaction amount
6. Start date
7. End date
8. Currency

On the ranked rows, the first row is returned as the best match.

Note

Certain fees, like late fees, can be set up at contract, as well as state level. In such cases, the contract fee, if present, is used first. Only if the contract fee is not present in the state fee used.

To set up the Fee

1. On the Oracle Financial Services Lending and Leasing home screen, click **Setup > Setup > Administration > User > Products > Fees > Line**.
2. In the Fee Definition section, perform any of the [Basic Operations](#) mentioned in Navigation chapter.

Figure 4-14 Fee Definition

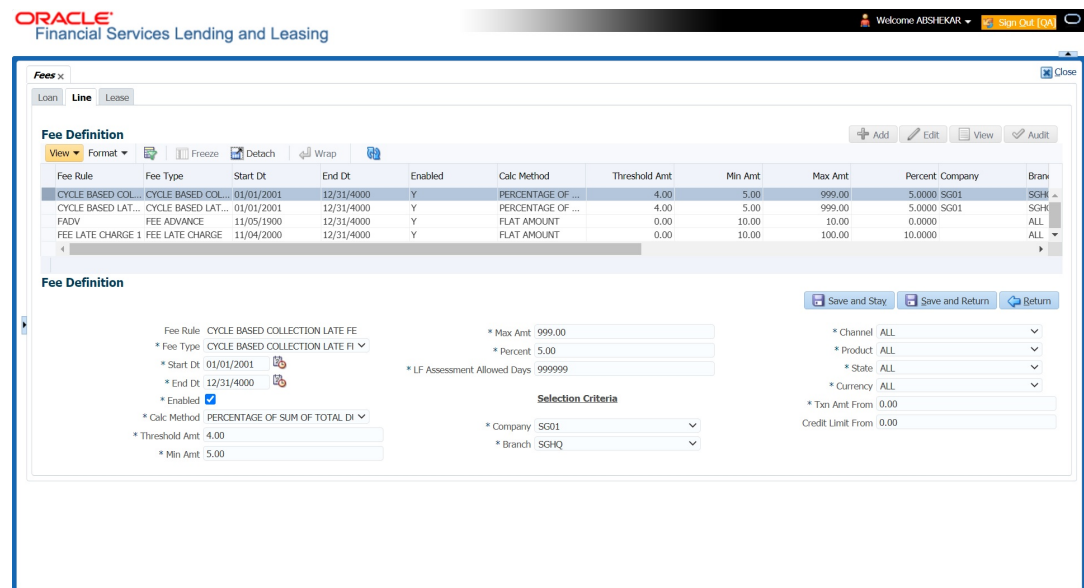

A brief description of the fields is given below:

Table 4-36 Fee Definition

Field	Do this
Fee Rule	Specify the fee rule used to identify the particular fee definition.
Fee Type	Select the fee type from the drop-down list. The system computes these drop-down values from the TXN_TYPE_CD Lookup, with FEE as the sub type.
Start Dt	Specify the start date. You can even select the date from the adjoining Calendar icon.
End Dt	Specify the end date. You can even select the date from the adjoining Calendar icon.
Enabled	Check this box to enable the fee.

Table 4-36 (Cont.) Fee Definition

Field	Do this
Calc Method	Select one of the following method of calculating the fee, from the drop-down list. If Flat Amount is selected, then minimum fee will be charged. If Percentage is selected, then the amount charged will be based on percentage defined subject to minimum and maximum amount (i.e. Txn Amt From).
Threshold Amt	This field is enabled only if the Contract Fee type is either CYCLE BASED COLLECTION LATE FEE or CYCLE BASED LATE FEE. Specify the threshold amount which is less than or equal to minimum fee amount to be assessed. Based on this amount, system calculates and posts the Cycle Based Collection Late Fee or Cycle Based Late Fee based on the account. If calculated fee amount is less than threshold amount, fee is posted with transaction amount = 0. If calculated fee amount is greater or equal to threshold amount, fee is posted based on existing min amt and max amt comparing logic.
Min Amt	Specify the minimum amount for the fee.
Max Amt	Specify the maximum amount for the fee. If you selected FLAT AMOUNT in the Calc Method field, then this field is not used and is normally populated as \$0.00.
Percent	Specify the percentage value of the outstanding transaction amount to be assessed as a fee. This amount will be adjusted to fall within the Min Amount and the Max Amount.
Selection Criteria section	
Company	Select the portfolio company from the drop-down list. This may be ALL or a specific company.
Branch	Select the portfolio branch from the drop-down list. This may be ALL or a specific branch. (This must be ALL, if you have selected ALL in the Company field).
Channel	Select the channel from the drop-down list, This can be ALL or a specific channel.
Product	Select the product from the drop-down list. This may be ALL or a specific product. The available values come from a validated field based on the selected Billing Cycle setup and the Product setup.
State	Select the state for this fee, from the drop-down list. This may be ALL or a specific state.
Currency	Select the currency for this fee, from the drop-down list. This may be ALL or a specific currency.

Table 4-36 (Cont.) Fee Definition

Field	Do this
Txn Amt From	<p>Specify the transaction or balance amount. The fee is calculated using the specifications of this record only if the transaction amount is greater than the value specified in this field (and less than this field in another record for the same fee).</p> <p>IMPORTANT:</p> <p>When you select the fee to use, the system searches for a best match using the following attributes:</p> <ul style="list-style-type: none"> a. Company b. Branch c. Product d. State e. Amount (Txn Amt From) f. Effective/start date (Start Dt) <p>Hence, Oracle Financial Services Software recommends creating a version of each fee, where ALL is the value in these fields.</p> <p>It is also recommended that you define a default printer for an Organization, Division and Department.</p>
Credit Limit From	Specify the minimum value of credit limit for the pricing.

3. Perform any of the [Basic Actions](#) mentioned in Navigation chapter.

4.12 Asset Billing Rate

In Asset Billing Rate screen you can setup the various parameters associated with **Home** collateral which serves as the input for **Asset Billing** batch job to process and post the dues on to respective accounts in the system.

This section consists of the following topics:

- [Asset Billing Rate Definition](#)
- [Asset Billing Rate Details](#)
- [Asset billing Calculations](#)
- [Asset Billing Rate Setup - File upload](#)
- [Asset Billing Batch Job](#)

4.12.1 Asset Billing Rate Definition

In the Asset Billing Rate Definition tab you can create and maintain **Timeshare** specific Home collateral and account details of an account which are used as a selection criteria.

To set up Asset Billing Rate Definition

1. On the Oracle Financial Services Lending and Leasing home screen, click Setup > Setup > Administration > User > Products > Asset Billing Rate.

Figure 4-15 Asset Billing Rate

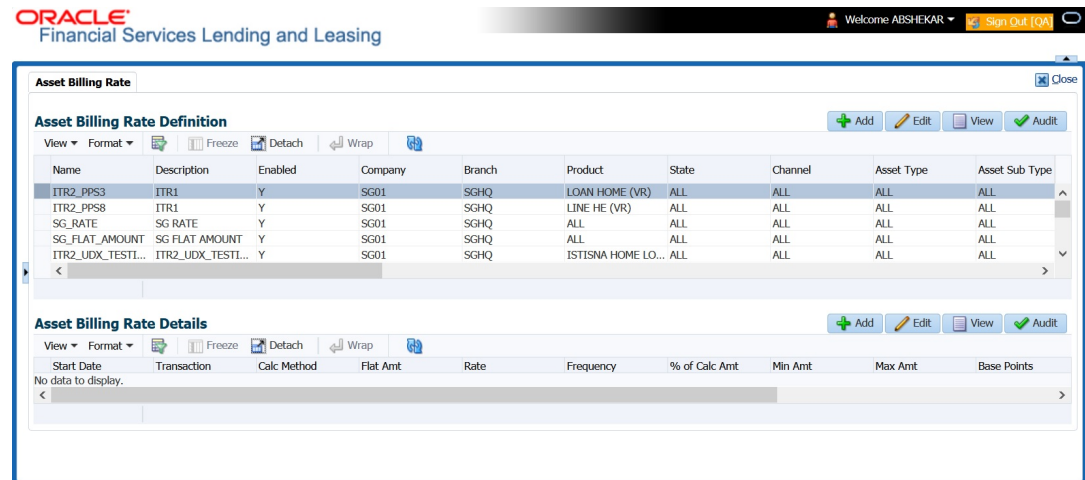

2. In the Asset Billing Rate Definition section, perform any of the [Basic Operations](#) mentioned in Navigation chapter. A brief description of fields are given below:

Table 4-37 Asset Billing Rate Definition

In this field	Do this
Name	Enter a unique name for Asset Billing Rate definition. This field is not editable after saving the record or during EDIT.
Description	Enter the description for Asset Billing Rate definition.
Enabled	Check this box to enable the record.
Selection Criteria	
Company	Select the portfolio company from the drop-down list. This list is populated based on Enabled Company definitions maintained in the system.
Branch	Select the portfolio branch from the drop-down list.
Product	Select the type of product associated with the collateral from the drop-down list.
State	Select the state to which the account operates from the drop-down list.
Channel	Select the channel from the drop-down list.
Asset Type	Select asset type from the drop-down list. The list is populated based on assets setup.
Asset Sub Type	Select the asset sub type from the drop-down list.
Club Name	Select the Club Name from the drop-down list.
Phase Number	Select the Phase Number from the drop-down list.
Site of Inventory	Select the Site of Inventory from the drop-down list.

Table 4-37 (Cont.) Asset Billing Rate Definition

In this field	Do this
Building	Select the Building from the drop-down list.
Unit	Select the Unit from the drop-down list.
Week	Select the Week from the drop-down list.
Room/Unit Type	Select the Room/Unit Type from the drop-down list.
Usage Type	Select the Usage Type from the drop-down list.
Resort Identifier	Select the Resort Identifier from the drop-down list.
Min Actual Points	Specify the minimum actual points for the asset billing definition.
Max Actual Points	Specify the maximum actual points for the asset billing definition.
Min Billing Points	Specify the minimum billing points which is used as the selection criterion in the Asset Billing Rate Definition. Billing points are used to derive the transaction amount that is to be charged to an asset linked to a product of the account.
Max Billing Points	Specify the maximum billing points which is used as the selection criterion in the Asset Billing Rate Definition. Billing points are used to derive the transaction amount that is to be charged to an asset linked to a product of the account.
Association Id	Select the Association Id from the drop-down list.
Club Indicator	Check this box to indicate Club Indicator.
Plus Membership Type	Check this box to indicate Plus Membership Type.
PR Marking	Check this box to indicate PR Marking.
Signature Grand Father	Check this box to indicate Signature Grand Father.
Additional Attributes - This section consists of additional 15 configurable fields as indicated below.	
5 check boxes - Membership 1-5 Opt	
5 drop-down lists - Other Attribute 1-5	
5 Calendar fields - Other Attribute 5-10	

3. Perform any of the [Basic Actions](#) mentioned in Navigation chapter.

4.12.2 Asset Billing Rate Details

In the Asset Billing Details sub tab, you can define Transactions, their Calculation Method, and other parameters which are posted by Billing Batch Job.

Note that once a record is created in this section, the same is available in Read-Only mode and you can only Enable or Disable the record in Edit mode.

To set up Asset Billing Rate Details

1. On the Oracle Financial Services Lending and Leasing home screen, click Setup > Setup > Administration > User > Products > Asset Billing Rate.

2. In the Asset Billing Rate Details section, perform any of the [Basic Operations](#) mentioned in Navigation chapter. A brief description of fields are given below:

Table 4-38 Asset Billing Rate Details

In this field	Do this
Start Date	Select the date of asset billing from adjoining calendar.
Transaction	Select the transaction from the drop-down list. This list is populated with transactions where the Transaction code = FOTH%.
Calc Method	Select one of the following calculation method from dropdown list. <ul style="list-style-type: none"> • Flat Amt • Rate • Flat Amt + Rate • Tiered Rate • Slab Formula For more information on above calculation methods, refer to Asset billing Calculations section.
Flat Amt	Specify the flat amount or fixed amount to be charged during asset billing calculation. This field is available if the Calc Method is Flat Amt, Flat Amt + Rate, and Slab based Formula.
Rate	Specify the rate for asset billing calculation. This field is available if the Calc Method is Rate and Flat Amt + Rate.
Frequency	Select the frequency of asset billing calculation from the drop-down list. The list is populated based on frequency maintained in lookup code.
% of Calc Amt	Specify the percentage of amount for calculation. By default, this is set to 100.
Base Points	Specify the base points for asset billing calculation. By default this is set to 1 since a value is required system does not allow to enter 0 . This field is available if the Calc Method is Rate, Flat Amt + Rate, Tiered Rate, and Slab Formula.
Slab Points	Specify the slab points for asset billing calculation. This field is available if the Calc Method is Slab Formula.
% Increase	Specify the percentage increase in each slab for asset billing calculation. This field is available if the Calc Method is Slab Formula.
Min Amt	Specify the base minimum amount to be configured for the resulted transaction amount. If the resulted Transaction Calculation Amount is less than the Min Amt defined here, system posts the transaction with Min Amt.
Max Amt	Specify the maximum amount to be configured for the resulted transaction amount.

Table 4-38 (Cont.) Asset Billing Rate Details

In this field	Do this
Billing Year	Specify the year in which the Rate is applicable. The Billing Year is stamped in billing amount transaction description only for FOTH% transactions.
Enabled	Check this box to enable the Asset Billing Rate.

3. Perform any of the [Basic Actions](#) mentioned in Navigation chapter.

This section consists of the following topics:

- [Tiered Rate Details sub tab](#)

4.12.2.1 Tiered Rate Details sub tab

The Tiered Rate Details sub tab you can define **points** specific tiers with different rates. This sub tab is enabled only if the transaction calculation method is selected as **Tiered Rate** in Asset Billing Rate Details section. For calculation details, refer to [Tiered Rate Calculation](#) section.

To set up Tiered Rate Details

1. On the Oracle Financial Services Lending and Leasing home screen, click Setup > Setup > Administration > User > Products > Asset Billing Rate.
2. In the Tiered Rate Details section, perform any of the [Basic Operations](#) mentioned in Navigation chapter. A brief description of fields are given below:

Table 4-39 Tiered Rate Details

In this field	Do this
From Points	Specify the points from where the respective rate is applicable.
Rate	Specify the rate for defined points range.
Enabled	Check this box to enable Tiered Rate detail.

3. Perform any of the [Basic Actions](#) mentioned in Navigation chapter.

4.12.3 Asset billing Calculations

This section explains the following calculation methods based on which the Asset Billing is processed in the system:

- [Flat Amount Calculation](#)
- [Rate Calculation](#)
- [Flat Amt + Rate Calculation](#)
- [Tiered Rate Calculation](#)
- [Slab Formula Calculation](#)

4.12.3.1 Flat Amount Calculation

In **Flat Amount** calculation, system calculates the Transaction Amount using below formula:

Table 4-40 Flat Amount Calculation

Frequency	Billing Cycle	Transaction Amount Calculation
Annual	Monthly	(Flat Amt/12)
Monthly	Annual	(Flat Amt*12)
Annual	Quarterly	(Flat Amt/4)
Quarterly	Annual	(Flat Amt*4)
Annual	Semi Annual	(Flat Amt/2)
Semi Annual	Annual	(Flat Amt*2)
Annual	Annual	(Flat Amt /1)

Consider the above calculation as reference for other combinations of Rate Frequency and Billing cycle.

4.12.3.2 Rate Calculation

In **Rate** calculation, system calculates the Transaction Amount using below formula:

Table 4-41 Rate Calculation

Frequency	Billing Cycle	Transaction Amount Calculation
Annual	Monthly	(Rate/12)*(Billing Points at collateral / Base Points)
Monthly	Annual	(Rate*12)*(Billing Points at collateral / Base Points)
Annual	Quarterly	(Rate/4)*(Billing Points at collateral / Base Points)
Quarterly	Annual	(Rate*4)*(Billing Points at collateral / Base Points)
Annual	Semi Annual	(Rate/2)*(Billing Points at collateral / Base Points)
Semi Annual	Annual	(Rate*2)*(Billing Points at collateral / Base Points)
Annual	Annual	(Rate/1)*(Billing Points at collateral / Base Points)

Consider the above calculation as reference for other combinations of Rate Frequency and Billing cycle.

4.12.3.3 Flat Amt + Rate Calculation

In **Flat Amt + Rate** calculation, system calculates the Transaction Amount using below formula.

$$\text{Transaction Amount} = \text{Flat Amt} + \text{Rate} * (\text{Billing Points at Collateral/Base Points})$$

Note

The Rate and Flat amount are adjusted based on Frequency and Billing Cycle.

4.12.3.4 Tiered Rate Calculation

In **Tiered Rate** calculation, system selects the **Asset Billing Rate Details** using the Billing Points at Asset and other asset parameters and calculates the transaction amount by deriving the rate from Tiered Rate table.

Transaction Amount = (Tiered Rate) * (Tiered Points / Base Points)

For example, if an Asset has 1.5 million points and the range is maintained as - for first million points rate=0.66 with Base Points =1000 and for remaining points rate=0.60 with Base Points = 1000, the Transaction Amount = 1million * (0.66/1000) + 0.5 million * (0.6/1000) = 660 + 300 = 960.

Note the following:

- If the range for specific points are not maintained correctly, the same is considered as **0** rate and in-turn the Transaction Amount derived also becomes **0**.
For example, if Billing Points are 8000 but if range maintained points is from 10000 with Rate = 0.55 and Base Points = 1, the transaction amount results as (0*(8000/1) =0).
- Rate is adjusted based on Frequency and Billing Cycle as mention in **Rate Method**.

4.12.3.5 Slab Formula Calculation

In **Slab Formula** calculation, system calculates the Transaction Amount using below formula.

Transaction Amount = [Flat Amt] + Ceil[$\frac{\text{Billing Points} - \text{Base Points}}{\text{Slab Points}} * \{\% \text{Increase} / 100\} * \text{Flat Amt}$]]

The resultant amount will always be rounded-down.

For example,

Transaction Amount = $[491.32 + \{ \frac{(61000 - 5000)}{2500} * \{ (30.4 / 100) * 491.32 \} \}]$

= $[491.32 + \text{Round-down } \{22.4\} * \{149.36\}]$

= $[491.32 + 3435.28]$

Transaction Amount = 3926.6

Note

The Rate and Flat amount are adjusted based on Frequency and Billing Cycle.

4.12.4 Asset Billing Rate Setup - File upload

The data in Asset Billing Rate screen can also be created and updated from an external file through SET-IFP input file upload process. While doing so, ensure that the file format of Header and Details record are maintained in required order and the input file is placed in upload area.

During the scheduled batch job run, the asset billing batch job picks-up the data in input file and loads on to the system to create Asset Billing Rate setup records.

However, before processing the details, system performs the following validations:

- If Name of the record is unique and duplicate record is not being updated.
- For Tiered Rate, the details are added only if the Calc Method = Tiered Rate. If not, system displays an error indicating **Tiered Rate Details are not required for <Calc Method>** and the record is added in bad file.
- For update to existing record details, only Enable/Disable option is supported. If there is a mismatch in the name of the record, batch job errors out with message **Record not found** and the record is added in bad file.
- For new records, all the fields are mandatory and default values are applicable.
- Values provided in fields which are of lookup type are validated with lookup code. In case of mismatch, batch job errors out with message **Lookup value not matching** and the record is added in bad file.
- Negative values is not added for number fields.
- Base Point's field does not contain negative, **0**, or decimal values.

4.12.5 Asset Billing Batch Job

The billing batch job TXNDDT_BJ_100_01 (BILLING/DUE DATES PROCESSING) facilitates to process the asset billing dues on account for **Home** collateral and posts the corresponding transactions.

Listed below is the sequence of processing steps:

1. Billing batch job picks-up the Vacation Ownership (VO) parameters from Servicing > Account > Collateral (Home) > Vacation Ownership tab.
 - The required accounts for Asset billing batch job processing is selected based on the type of account selected in **Due Amt Account Type** field. I.e. in **Vacation Ownership Details** section if the **Billing** option is checked and the Due Amt Account Type is selected as Current or Linked or Master Account, then the billing batch job posts the transactions based on Asset Billing Rate setup in Current account or Linked Account of current Account or Master Account of current Account respectively.
 - In addition, system includes the asset billing points of Linked Account/Associated Account only if the status of those accounts are in any of the status defined in lookup code **ACC_STATUS_BILLING_CD** (ACCOUNT STATUS FOR ASSET BILLING CODES). Account statuses which are not maintained in the lookup code are excluded for asset billing calculation. However, If no statuses are maintained in the lookup, then system will consider all statuses for consolidation.
 - If billing flag is checked and Due Amt Account Type = Current Account, billing batch job posts the transactions based on Asset Billing Rate setup in **Current** account.
 - If billing flag is checked and Due Amt Account Type = Linked Account, billing batch job post the transactions based on Asset Billing Rate setup in **Linked Account of current Account**.
 - If billing flag is checked and Due Amt Account Type = Master Account, billing batch job post the transactions based on Asset Billing Rate setup in **Master Account of current Account**.

Before the due calculation, batch job validates VO parameters with the following:

- If the selected Usage Type sub code is **FULL**, system considers Full points for rate derivation and **Billing points** is considered for Transaction Amount calculation.
 - If the selected Usage Type sub code is **HALF**, system considers **Billing Points** for Transaction Amount calculation but rate is derived using full points.
 - If the **First Year Proration** check box is selected, then the rate is derived using full points and the Transaction Amount is calculated based on prorated points (not on full points).
 - The prorated points are calculated based on Asset **Usage Start Date**.
 - If the usage start date year is equal to first due year, then system prorates the points as indicated in example below:
 If First Due Date = 01/01/2018, Usage Start Date = 01/10/2018,
 Prorated Points = Billing Points * (13-1)/12= Billing Points *1
 If First Due Date = 01/01/2018, Usage Start Date = 03/10/2018
 Prorated Points = Billing Points * (13-3)/12= Billing Points*10/12
Note: Number **13** here is used as constant.
 - If the usage start date year is before the due date year, system considers the full points for calculating the Transaction Amount and no proration is required here.
2. Batch job looks of best matching Asset Rate details and Asset Billing definition in Setup.
 3. Batch job checks for status (Y/N) of **Multiple Billing Asset Rate** indicator at Account Details > Contract > Billing level to decide if multiple asset rates are applicable for one billing period or not.
 - If **N**, system picks the latest rate which is less than or equal to DUE DATE. In this case only one best match record is fetched to derive Transaction Amount and no multiple asset rates are applicable for one billing period.
 - If **Y**, system fetches multiple rates only when rate End Date (i.e. rate start date + rate frequency) ends with one or more cycle(s) before the next due date. This implies that current rate record does not cover the entire billing period.
 - However, if **Multiple Billing Asset Rate** is set to **Y** but there is no **Rate** available for Due period beyond the Rate End date, system applies the same rate that is picked for Due Period which is Less than or Equal to Due End Date.
 4. Batch job posts the matched transactions at account level based on calculation method. The following Asset Billing Rate Details are stamped on the transaction posted:
 - Asset Id (Assets)
 - Asset Rate Id (Asset Billing Rate Definition)
 - Asset Rate Details Id (Asset Billing Rate Details)
 - Rate Start Date (Asset Billing Rate Details)
 - Rate Frequency (Asset Billing Rate Details)
 - Calculation Method (Asset Billing Rate Details)
 - Rate (Asset Billing Rate Details)
 - In case of Tiered Rate, Effective Rate is stamped
 - Base Points (Asset Billing Rate Details)
 - Slab Points (Asset Billing Rate Details)
 - % Increase (Asset Billing Rate Details)

- Billing Year (Asset Billing Rate Details)

On posting the transactions, following validations and outcome are handled:

- If the respective balance for transaction is missing, batch job fails with an error message indicating **Account #: Transaction posting failed Balance not available** in Batch > Request Results block and does not process the account due amount calculation.
 - This can be rectified by posting **Add balance to Account** non-monetary transaction. For more information, refer to Appendix - Non-Monetary transactions section in Servicing User Guides.
- If the transaction posting failed due to an issue in Access grid configuration or Product configuration at transaction codes, batch job displays error indicating **Account #: Transaction posting failed <Reason>** and does not process the account due amount calculation.
- If the Resulted transaction amount is less than Min Amount defined, batch job considers the Min amount and posts the transaction.
- If the Resulted transaction amount is greater than Max Amount defined, batch job considers the Max amount and posts the transaction.

4.13 Origination Fees

The system supports the auto computation of origination itemized fees. System administrators can define and maintain the itemization formula on the Origination Fees screen.

An itemization formula can be set up as a computation of other itemizations (such as adding or subtracting one itemization from another) and can consist of multiple itemizations. An itemization formula will have a minimum and maximum value. You can set up a formula value range to be used as the final value.

Itemizations are linked to a product with the Products screen's Product Itemizations subtab.

One itemization can be based on one formula, while the same formula can be attached to multiple itemizations. If a formula is attached to a contract itemization and that formula requires an itemization not present in Formula Definitions screen, then the system displays an error message.

The system will search for any **circular dependency** at the time the contract is enabled. An example of a circular dependency is when Itemization1 has Formula1 attached requiring Itemization2 for computation and Itemization2 has Formula2 attached requiring Itemization1 for computation.

To set up the Origination Fees

1. On the Oracle Financial Services Lending and Leasing home screen, click **Setup > Setup > Administration > User > Products > Origination Fees > Line**.
2. In the **Formula Definitions** section, perform any of the [Basic Operations](#) mentioned in Navigation chapter.

Figure 4-16 Origination Fees

3. A brief description of the fields is given below:

Table 4-42 Formula Definitions

Field	Do this
Formula	Specify the formula code to define computation.
Description	Specify the description for the formula.
Min Amt	Specify the minimum value that should be considered to compute the final value of formula.
Max Amt	Specify the maximum value that should be considered to compute the final value of formula.
Enabled	Check this box to allow the origination fees.

4. Perform any of the [Basic Actions](#) mentioned in Navigation chapter.
5. In the Formula Details section of **Setup > Setup > Administration > User > Products > Origination Fees > Line > Detail**, perform any of the [Basic Operations](#) mentioned in Navigation chapter.

A brief description of the fields is given below:

Table 4-43 Formula Details

Field	Do this
Itemization	Select the itemization based on which the itemization formula will derive its computed value, from the drop-down list.
Percentage	Specify the percentage value that should be considered while computing value for itemization formula.
Sort	Specify the sort sequence for the itemization to be considered while computing the value of the itemization formula.
Sign	Select the +ve or -ve sign that needs to be considered between two itemizations for computing the value of the itemization formula.

Table 4-43 (Cont.) Formula Details

Field	Do this
Enabled	Check this box to allow the itemization details to be used by the system.

- Perform any of the [Basic Actions](#) mentioned in Navigation chapter.
- In the Range Details section of **Setup > Setup > Administration > User > Products > Origination Fees > Line**, perform any of the [Basic Operations](#) mentioned in Navigation chapter.
A brief description of the fields is given below:

Table 4-44 Range Details

Field	Do this
Amt From	Specify the value up to which the percentage of final value of the itemization formula to be considered for the final value of itemization formula.
Percent	Specify the percentage value that should be considered while computing the value for the final value of the itemization formula.
Enabled	Check this box to allow the range details to be used by the system.

- Perform any of the [Basic Actions](#) mentioned in Navigation chapter.

4.14 Insurance

Most financial institutes offer financing for insurance to the borrowers; examples include credit life, credit disability, and GAP. The insurance product offer permits the customer to cancel the insurance in mid term or automatically end when the product matures or is paid-off. The system supports financing of insurance products during origination and automatically end the insurance when the product is paid-off. The system also can compute the rebate premium based on **Rule of 78** or **Actuarial** method. As the customer might cancel the insurance in mid term of the line, the system computes the premium rebate on a prorated basis. This also applies to additional insurance purchase during the life of the line. Normally, mid term insurance cancellations have associated fees and grace period. In such cases, the customer may cancel the insurance during the grace period without accruing any fees. However, when a customer cancels after the grace period, the result is a predefined fees which the system deducts from the computed rebate.

The system supports mid term insurance cancellation with and without grace period and cancellation fees. With this enhancement of insurance processing, you can define the premium rebate computation with a prorated basis.

You can define financed insurance related itemizations in the Origination Fees screen, as you have in previous releases with the Insurance screen. You can also set the refund method to **Pro Rate Basis** in the Refund Method field in the Contract Itemization section on the Itemization sub screen during setup with the on the Contracts screen.

To set up the Insurances

You can either define new Insurance details or specify a new code in the **New Insurance** field and click **Create Copy** to create a copy of selected insurance with details.

1. On the Oracle Financial Services Lending and Leasing home screen, click **Setup > Setup > Products > Insurance > Line**.
2. In the Insurance Definition section, perform any of the [Basic Operations](#) mentioned in Navigation chapter.

Figure 4-17 Insurance

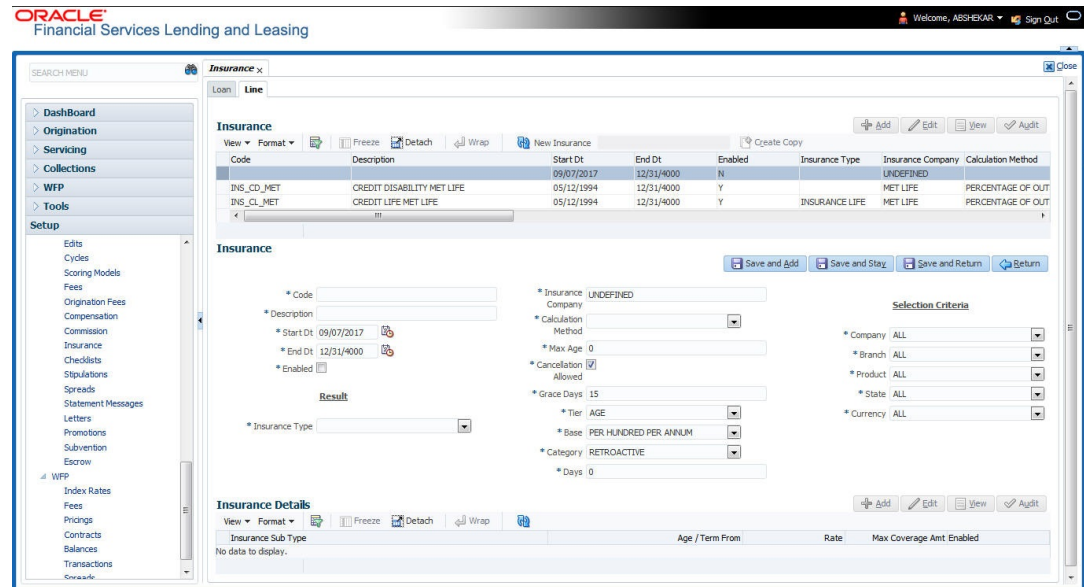

A brief description of the fields is given below:

Table 4-45 Insurance Definition

Field	Do this
Code	Specify the code associated with the insurance product.
Description	Specify a brief description of the insurance product.
Start Dt	Specify the date from which you can start offering the product to customers. You can even select the date from the adjoining Calendar icon.
End Dt	Specify the date from which to stop offering the product to customers. You can even select the date from the adjoining Calendar icon.
Enabled	Check this box to allow the offering of this insurance product.
Result section	
Insurance Type	Select the insurance types available for financing, from the drop-down list.
Insurance Company	Specify the name of the company through which the insurance product is offered.
Calculation Method	Select the insurance calculation method from the drop down list.

Table 4-45 (Cont.) Insurance Definition

Field	Do this
Max Age	Enter the maximum age allowed by the insurance.
Cancellation /Refund Allowed	Check this box to allow the insurance rebate or refund for cancellation or paid-off.
Grace Days	Specify the number of grace days allowed for cancellation without charging a cancellation fee.
Tier	Select the tier from the drop-down list.
Base	Select the base from the drop-down list.
Category	Select the category from the drop-down list.
Days	Enter the number of category days.
Selection Criteria Section	
Company	Select the portfolio company that can offer the insurance product, from the drop-down list. Select ALL if offered by all companies.
Branch	Select the branch of the specified portfolio company that can offer the insurance product, from the drop-down list. Select ALL if offered by all the branches of the specified portfolio company.
Product	Select the product for which you can offer the insurance product, from the drop-down list. Select ALL if offered for all the products.
State	Select the state for which you can offer the insurance product, from the drop-down list. Select ALL if this is offered for all the states.
Currency	Select the currency for which you can offer the insurance product, from the drop-down list. Select ALL if this is offered for all the states.

3. Perform any of the [Basic Actions](#) mentioned in Navigation chapter.
4. Click **Create Copy** button in the Insurance Definition section to create copy of selected record with details.
5. In the Insurance Details section, perform any of the [Basic Operations](#) mentioned in Navigation chapter.
A brief description of the fields is given below:

Table 4-46 Insurance Details

Field	Do this
Insurance Sub Type	Select the insurance sub type you want to define for the entry in the Insurance section, from the drop-down list. For example SINGLE.
Term From	Specify the minimum term for the insurance sub type.
Rate	Specify the rate for premium calculation per \$1,000.00 for the insurance sub type.
Max Coverage Amt	Specify the maximum coverage amount covered by the insurance sub type.
Enabled	Check this box to enable the insurance.

- Perform any of the [Basic Actions](#) mentioned in Navigation chapter.

4.15 Checklists

A checklist is an optional set of steps to follow when completing a task in the system, such as the underwriting and funding processes.

Checklists can be used as guidelines to help ensure that the system users follow your business's standard operating procedures and enter all required data. Some checklists are optional, but others such as those related to application decisions or contract verification, may be required depending on the edit sets defined in your system. The Checklists screen allows you to specify the contents of the checklist.

You can define additional checklists for your organization. You can set up multiple checklists for a single type of checklist. These checklists can be differentiated by:

- Company
- Branch
- Product
- Account state

To set up the Checklists

You can either define new Checklist Type Definition details or specify a new code in the **New Checklist** field and click **Create Copy** to create a copy of selected checklist type definition with details.

- On the Oracle Financial Services Lending and Leasing home screen, click **Setup > Setup > Administration > User > Products > Checklists > Line**.
- In the Checklist Type Definition section, perform any of the [Basic Operations](#) mentioned in Navigation chapter.

Figure 4-18 Checklists

The screenshot shows the Oracle Financial Services Lending and Leasing interface. The left sidebar contains a navigation menu with 'Setup' selected. The main content area is titled 'Checklists' and shows a 'Checklist Type Definition' table. The table has the following data:

Checklist Code	Description	Checklist Type	Company	Branch	Channel
CNLNOE-COV-01	CONTRACT VERIFICATION CHECKLIST FOR LINE OF CREDIT	CONTRACT VERIFICATION CHECKLIST	ALL	ALL	ALL
CNLNOE-DEC-1	DECISION CHECKLIST FOR LINE OF CREDIT	DECISION VERIFICATION CHECKLIST	ALL	ALL	ALL
TEST_CHK_LINE_1	TEST_CHK_LINE_1	APPLICATION ENTRY VERIFICATION CHECKLIST	ALL	ALL	PHONE
TEST_CHK_LINE_2	TEST_CHK_LINE_2	APPLICATION ENTRY VERIFICATION CHECKLIST	ALL	ALL	ALL

Below the table, the 'Checklist Type Definition' section shows details for 'CNLNOE-COV-01'. The 'Selection Criteria' section includes dropdown menus for Company (ALL), Branch (ALL), Product (ALL), State (ALL), and Currency (ALL). The 'Checklist Action Definition - Regular' section is currently empty, showing 'No data to display.'

3. A brief description of the fields is given below:

Table 4-47 Checklist Type Definition

Field	Do this
Checklist Code	Specify the checklist code that identifies checklist being defined.
Description	Specify the description for the checklist.
Checklist Type	Select the checklist type from the drop-down list, to define where the specific checklist will be available in the system.
Company	Select the portfolio company associated with the checklist from the drop-down list. This may be ALL or a specific company.
Branch	Select the portfolio branch associated with the checklist from the drop-down list. This may be ALL or a specific branch. This must be ALL if in the Company field you selected ALL).
Channel	Select the channel from the drop-down list, This can be ALL or a specific channel.
Product	Select the product associated with the checklist from the drop-down list. This may be ALL or a specific product. The available values come from a validated list based on the selected Billing Cycle setup and the Product setup.
State	Select the state associated with the checklist type from the drop-down list. This may be ALL or a specific state. IMPORTANT: By selecting which edits type to use, the system searches for a best match using the following attributes: 1 Company 2 Branch 3 Product 4 State Hence, Oracle Financial Services Software recommends creating one version of each checklist type where ALL is the value in these fields.
Currency	Select the currency associated with the checklist from the drop-down list. This may be ALL or a specific currency.
Enabled	Check this box to enable the checklist.

4. Perform any of the [Basic Actions](#) mentioned in Navigation chapter. Checklist actions are steps (a set of one or more tasks) related to the checklist you are creating. They are loaded on the Checklist Action Definition section.
5. In the Checklist Action Definition - **Regular** section, perform any of the [Basic Operations](#) mentioned in Navigation chapter
A brief description of the fields is given below:

Table 4-48 Checklist Action Definition

Field	Do this
Action Code	Specify the action code for the checklist.
Description	Specify the description for the action type.
Sort	Specify the sort order to define the placement of the action type on the Checklist sub screen.
Enabled	Check this box to include this action in the checklist.

6. Perform any of the [Basic Actions](#) mentioned in Navigation chapter.
7. In the Checklist Action Definition - **Document** section, perform any of the [Basic Operations](#) mentioned in Navigation chapter.
A brief description of the fields is given below:

Table 4-49 Checklist Action Definition

Field	Do this
Action Code	Specify the action code for the checklist.
Description	Specify the description for the action type.
Document Type	Select the document type from the drop-down list.
Document Sub Type	Select the document sub type from the drop-down list.
Document Mandatory	Check this box to indicate that the document is mandatory.
Sort	Specify the sort order to define the placement of the action type on the Checklist sub screen.
Enabled	Check this box to include this action in the checklist.

8. Perform any of the [Basic Actions](#) mentioned in Navigation chapter.

4.16 Stipulations

The system supports the automatic generation of default stipulations for line of credit during origination on the Underwriting window's **Stipulation** sub screen (Decision link). The default stipulations can be maintained by company, branch, product, state, application status and application sub-status on the Stipulations screen.

To set up the Stipulations

1. On the Oracle Financial Services Lending and Leasing home screen, click **Setup > Setup > Administration > User > Products > Stipulations > Line**.
2. In the Stipulation Setup section, perform any of the [Basic Operations](#) mentioned in Navigation chapter.

Figure 4-19 Stipulations

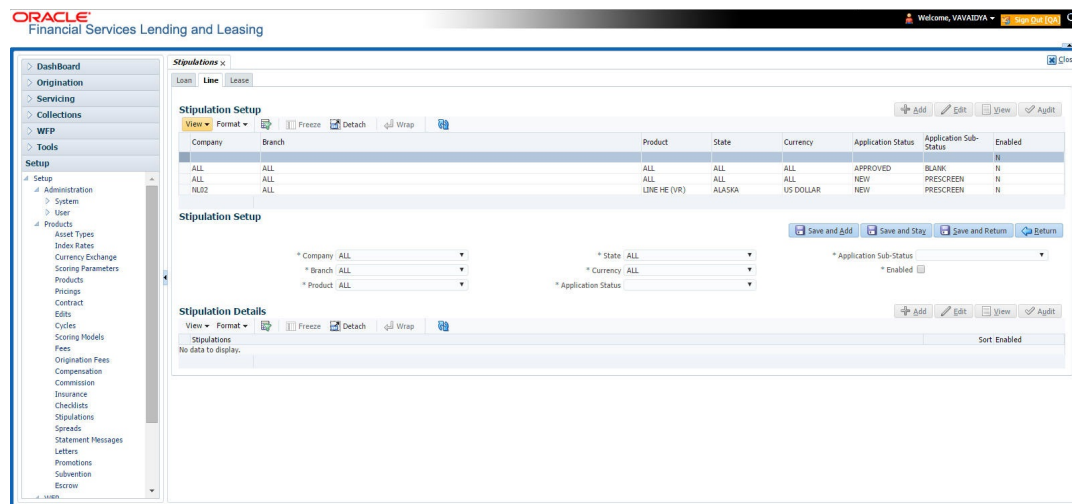

A brief description of the fields is given below:

Table 4-50 Stipulation Setup

Field	Do this
Company	Select the portfolio company associated with the default stipulations, from the drop-down list.
Branch	Select the portfolio branch associated with the default stipulations, from the drop-down list.
Product	Select the product associated with the default stipulations, from the drop-down list.
State	Select the state associated with the default stipulations, from the drop-down list.
Currency	Select the currency associated with the default stipulations, from the drop-down list.
Application Status	Select the application status associated with the default stipulations, from the drop-down list.
Application Sub-Status	Select the application sub status associated with the default stipulations, from the drop-down list.
Enabled	Check this box to allow the default stipulations to be used.

3. Perform any of the [Basic Actions](#) mentioned in Navigation chapter.
4. In the Stipulation Details section, perform any of the [Basic Operations](#) mentioned in Navigation chapter.

A brief description of the fields is given below:

Table 4-51 Stipulation Details

Field	Do this
Stipulations	Select the stipulation from the drop-down list.
Sort	Specify the sort sequence for the stipulation.

Table 4-51 (Cont.) Stipulation Details

Field	Do this
Enabled	Check this box to allow the stipulations details to be used by the system.

5. Perform any of the [Basic Actions](#) mentioned in Navigation chapter.

4.17 Letters

The Letters screen allows you to define letters that the system automatically generates when the application or the account for a products meets certain conditions, or **trigger events**. Each letter has its own trigger event. For example, you can configure the system to automatically send a welcome letter when an application becomes an account or send a collection letters when an account becomes delinquent.

The system supports the following types of letters:

Table 4-52 Types of letters

Type of letter	Definition
ACCOUNT STATEMENT	Generated when account is to receive a billing statement (this time is defined in contract setup). Letter is sent to customer.
ADVERSE Action letter	Generated in nightly batch jobs for applications that were declined. This letter is sent to the consumer to indicate the reasons why the application was declined.
CONDITIONAL ADVERSE	Generated in nightly batch jobs for applications that were declined.
ACTION LETTER	This letter is sent to the consumer to indicate the reasons why the application was declined. This letter also indicates steps that the consumer may take to gain approval of the application.
COLLECTION LETTER 1	Generated when an account becomes delinquent. This is the first dunning letter sent to the customer.
COLLECTION LETTER 2	Generated when an account remains in delinquency for an extended period. This is the second dunning letter sent to the customer.
COLLECTION LETTER 3	Generated when an account remains in delinquency for an extended period, even after having received previous notices. This is the final dunning letter sent to the customer.
CONTRACT FUNDING fax/ email	Generated when an application is APPROVED: FUNDED or CONDITIONED: FUNDED. This letter is sent to the producer.
DECISION FAX/ EMAIL	Generated when an application is APPROVED, CONDITIONED, or REJECTED. This letter is sent to the consumer or producer, depending on the product.
PAID IN FULL LETTER	Generated in nightly batch jobs when the account pays off. This letter is sent to the customer.
PAYOFF QUOTE LETTER	Generated when a payoff quote is created for an account. This letter is sent to the customer.

Table 4-52 (Cont.) Types of letters

Type of letter	Definition
WELCOME LETTER	Generated when an application is APPROVED: FUNDED. This letter is sent to the consumer. STATEMENT PAST MATURITY Generated when an accounts are matured but unpaid. This letter is sent to the account holders as a reminder to make their payments.

When the system generates letters, it searches the Letters screen for letter definitions that meet the following criteria:

- Definition is enabled.
- Definition is an exact match of the letter code being generated.
- Definition is a match of either the application/account value or ALL for all other criteria.

Exact matches for each field are given a higher weight than matches to ALL.

The returned rows are then given a descending rank based on the weighted values and the hierarchical position of these fields:

1. Company
2. Branch
3. Product
4. State
5. Currency

On the ranked rows, the first row is returned as the best match.

To set up the Letters

1. On the Oracle Financial Services Lending and Leasing home screen, click **Setup > Setup > Administration > User > Products > Letters > Line**.
2. In the Letter Definition section, perform any of the [Basic Operations](#) mentioned in Navigation chapter.

Figure 4-20 Letters

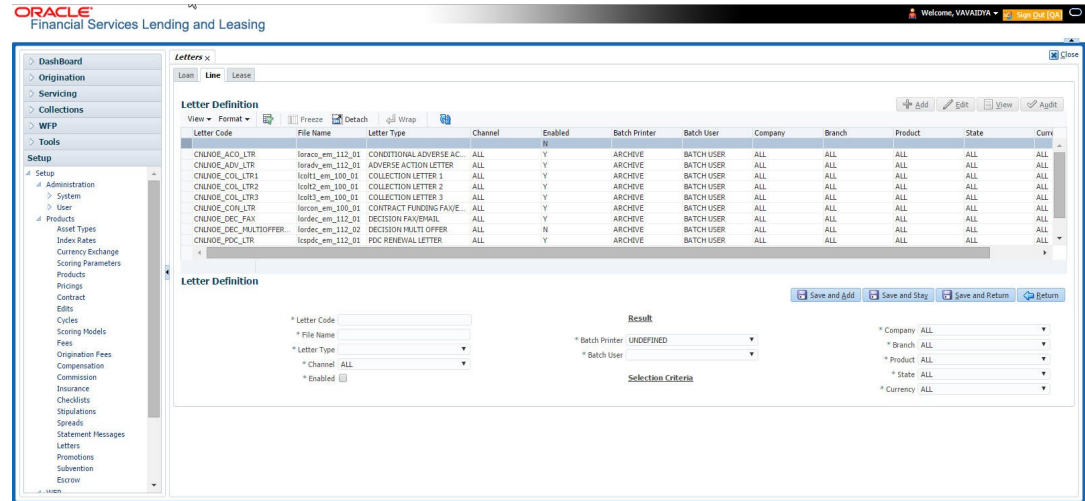

A brief description of the fields is given below:

Table 4-53 Letter Definition

Field	Do this
Letter Code	Specify the code for the letter.
File Name	Specify the file name of the Oracle report used to generate the letter. The file should be named <File Name>.rep on your server.
Letter Type	Select the type of letter you want to generate from the drop-down list.
Channel	Select the application source (channel) for the letter from the drop-down list. This may be ALL or a specific channel.
Enabled	Check this box to enable this letter definition.
Result section	
Batch Printer	Select the batch printer being used to generate the letter from the drop-down list.
Batch User	Select the user who will submit this letter from the drop-down list. This will normally be set to BATCH.
Selection Criteria section	
Company	Select the portfolio company for which this letter will be used from the drop-down list. This may be ALL or a specific company.
Branch	Select the portfolio branch for which this letter will be used from the drop-down list. This may be ALL or a specific branch. This must be ALL if in the Company field you selected ALL).
Product	Select the product for which this letter will be used from the drop-down list. This may be ALL or a specific product.

Table 4-53 (Cont.) Letter Definition

Field	Do this
State	Select the state for which this letter will be used from the drop-down list. This may be ALL or a specific state.
Currency	Select the currency for which this letter will be used from the drop-down list. This may be ALL or a specific currency.

3. Perform any of the [Basic Actions](#) mentioned in Navigation chapter.

4.18 Promotions

The Introductory tab of Promotions screen allows you to set up the promotions that a financial institution can offer its customers. Promotion details defined here can be selected during Application Entry and Application processing.

You can define multiple promotions for a product, then select the appropriate promotion at the time the application is processed. Promotions also serve as a selection criteria on the Pricing screen.

CAUTION: The system supports promotions selected only when a product is funded.

Same as Cash promotions

In the case of the same as cash promotion:

- If the outstanding amount at the end of the promotional period is within the tolerance amount, then the customer receives the full benefit of the promotion and the system will not charge any interest on the borrowers' account.
- If the outstanding amount is higher than the authorized tolerance amount, then the customer loses the benefit of the promotion and the system computes and charges the borrower interest from the date the product was funded.

Interest & Payments

Interest still continues to accrue for a account that is funded using the SAME AS CASH promotion. However, the interest accrued during the promotion period is not charged or collected on the account until the end of the promotion period.

Any repayment made by the customer during the promotion period is applied towards the line receivables amount. The system then calculates the interest accrual using the reduced line receivables amount, if applicable.

If the product remains unpaid after the end of the promotion period and the line receivables balance is above any stated tolerance amount, then the system starts collecting interest earned and accrued during the promotion period.

Reduced Rate Introductory Promotions

Oracle Financial Services Lending and Leasing's promotion method PROMOTIONAL RATE allows you to create and specify promotions where customers can be charged lower interest rates during a specific promotional period of time. You may define the length of the promotion in either terms or days. Also, you will be able to set the specific interest rate you want to attach to the promotion. During the promotional period, interest on an account is accrued at the promotional rate. When the promotional period expires, the system changes the interest rate of the product to the contractual interest rate to accrue interest. The promotion expires on the

promotion end date defined by the length of the promotion. However, the system allows you to set a grace period for extending the automatic cancellation of the promotion due to delinquency, similar to the grace period associated with a payment date.

To set up the Line Introductory

1. On the Oracle Financial Services Lending and Leasing home screen, click **Setup > Setup > Administration > User > Products > Promotions > Line Introductory**.
2. In the Promotion Definitions section, perform any of the [Basic Operations](#) mentioned in Navigation chapter.
A brief description of the fields is given below:

Table 4-54 Promotion Definitions

Field	Do this
Code	Specify the code identifying the promotion.
Description	Specify a description of the promotion being offered.
Type	Select the promotion type from the drop-down list. Oracle Financial Services Lending and Leasing supports the following promotion types for lines of credit: NO PAYMENT DUE ANY INTEREST DUE (No payments are required and no interest is accrued on the outstanding accrual balances for x terms).
Term	Select the promotion term from the drop-down list.
Index	Select the promotion index from the drop-down list.
Margin	Specify the promotion margin rate.
Cancel Delq Days	Specify the promotion cancellation delinquency days.
Cancel Overlimit%	Specify the promotion cancellation over limit percentage.
Enabled	Check this box to enable the promotion.

3. Perform any of the [Basic Actions](#) mentioned in Navigation chapter.
4. On the Oracle Financial Services Lending and Leasing home screen, click **Setup > Setup > Administration > User > Products > Promotions > Line Incentive**.
5. In the Promotion Definitions section, perform any of the [Basic Operations](#) mentioned in Navigation chapter.

Figure 4-21 Promotions-Line Incentive

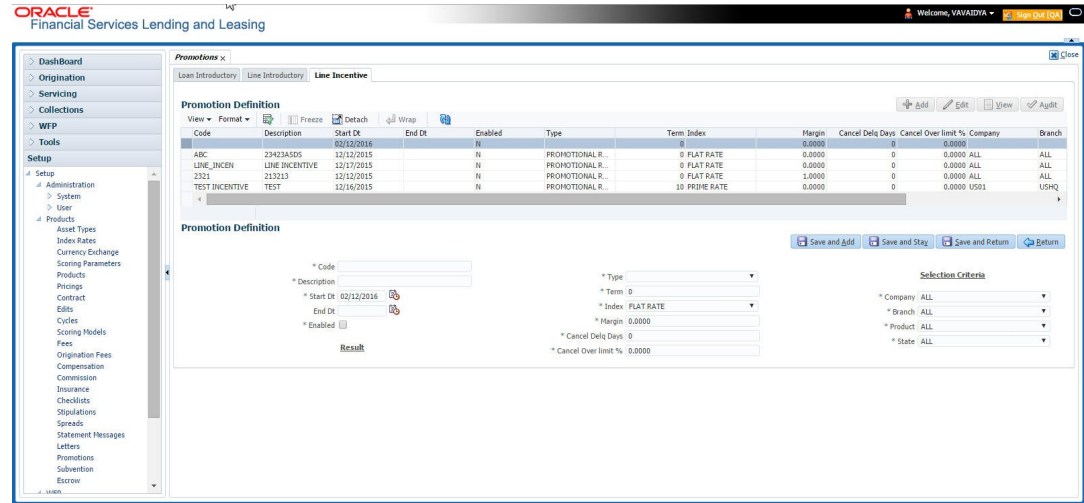

- 6. A brief description of the fields is given below.

Table 4-55 Promotion Definitions

Field	Do this
Code	Specify the code identifying the promotion.
Description	Specify a description of the promotion being offered.
Start Date	Select the start date from the drop-down list.
End Date	Select the end date from the drop-down list.
Enabled	Check this box to enable the promotion.
Result section	
Type	Select the promotion type from the drop-down list.
Term	Specify the promotion term.
Index	Select the promotion index from the drop-down list.
Margin	Specify the promotion margin rate.
Cancel Delq Days	Specify the promotion cancellation delinquency days.
Cancel Overlimit%	Specify the promotion cancellation over limit percentage.
Selection Criteria section	
Company	Select the portfolio company from the drop-down list.
Branch	Select the portfolio branch from the drop-down list.
Product	Select the product from the drop-down list.
State	Select the state from the drop-down list.

- 7. Perform any of the [Basic Actions](#) mentioned in Navigation chapter.

A

Appendix : Summary of the Application Credit Scoring Parameters

This section consists of the following topics:

- [Glossary](#)
- [Credit Scoring Parameters by Category](#)

A.1 Glossary

Table A-1 Glossary

Term	Description
DEROG / DEROGATORY	Account has had chargeoffs, collections, bankruptcy, or repossession.
MINOR DELINQUENCY	Less than or equal to 60 days delinquent.
MAJOR DELINQUENCY	Greater than 60 days delinquent.
DEBT RATIO	Debt / Available credit.
DEBT TO INCOME RATIO	Debt / Income.
APPLICANT STATED	Parameter is pulling information stated or in any other way provided by the applicant on the application on the Application Entry form in the system.
APPLICANT CREDIT BUREAU	Parameter is pulling information from the credit bureau, as opposed to another source, such as the Application Entry form.
FINANCE	Refers to companies that provide the finance but are not selling the actual object financed, if any. Example: An independent auto finance company.
SALES FINANCE	Refers to companies that provide the object being financed in addition to the financing. Example: Marshall Fields card.

A.2 Credit Scoring Parameters by Category

This section consists of the following topics:

- [Applicant Details / Debt Ratios](#)
- [Line of Credit Details](#)
- [Auto Trades / Inquiries](#)
- [Bank Trades / Inquiries](#)
- [Card Trades / Inquiries](#)
- [Installment Trades / Inquiries](#)

- [Line of Credit Finance Trades / Inquiries](#)
- [Mortgage Trades / Inquiries](#)
- [Retail Trades / Inquiries](#)
- [Revolving Trades](#)
- [Sales Finance Trades / Inquiries](#)
- [Other Trades](#)
- [Bankruptcy Information](#)
- [Delinquency Information](#)
- [Derogatory Trade Information](#)

A.2.1 Applicant Details / Debt Ratios

Applicant Credit Bureau Auto Debt Ratio

This is the sum of all automobile type line of credit balances and the sum of all automobile type credit limits. For installment line of credit, the credit limit is normally equal to the original line of credit amount. This applies to open tradelines only.

Applicant Credit Bureau Bank Debt Ratio

This is the sum of all bank type line of credit balances and the sum of all bank type credit limits. For installment line of credit, the credit limit is normally equal to the original line of credit amount. This applies to open tradelines only.

Applicant Credit Bureau Card Debt Ratio

This is the sum of all travel card type line of credit balances and the sum of all travel card type credit limits. This applies to open tradelines only.

Applicant Credit Bureau Debt Ratio

This parameter provides a value for all debt divided by all available credit as shown on the bureau.

Applicant Credit Bureau FICO Score

This is the FICO score provided for the applicant in the bureau pull. There are usually several different types of FICO scores available at the bureau. The different score models are set up to give certain attributes different, weighting based on if the person is buying a car, or a house, and so on. The type of FICO score pulled is based on credit bureau setup.

Applicant Credit Bureau Inst Debt Ratio

This is the sum of all installment line of credit balances and the sum of all installment line of credit credit limits. For installment line of credit, the credit limit is equal to the original line of credit amount. This applies to open tradelines only.

Applicant Credit Bureau Line of credit Fin Debt Ratio

This is the sum of all line of credit finance type balances and the sum of all line of credit finance type credit limits. For installment line of credit amount, the credit limit is normally equal to the original line of credit amount. This applies to open tradelines only.

Applicant Credit Bureau Mortgage Debt Ratio

This is the sum of all mortgage type line of credit balances and the sum of all mortgage type credit limits. For installment line of credit, the credit limit is normally equal to the original line of credit amount. This applies to open tradelines only.

Applicant Credit Bureau Open Public Records

This parameter indicates if there are any open public records in the credit bureau associated with the applicant. This is a numeric counter covering the full period of time available in the bureau.

Applicant Credit Bureau Public Records

This parameter indicates, if there are any public records, open or closed, in the credit bureau associated with the applicant. This is a numeric counter covering the full period of time available in the bureau.

Applicant Credit Bureau Retail Debt Ratio

This is the sum of all retail type line of credit balances divided by the sum of all retail type credit limits. For installment line of credit, the credit limit is normally equal to the original line of credit amount. This applies to open tradelines only. This is expressed as a percent: 50% shows as 50.

Applicant Credit Bureau Rev Debt Ratio

This is the sum of all revolving type line of credit balances and the sum of all revolving type credit limits. This applies to open tradelines only. This is expressed as a percent: 50% shows as 50.

Applicant Credit Bureau Sales Fin Debt Ratio

This is the sum of all sales finance type line of credit balances and the sum of all sales finance type credit limits. For installment line of credit, the credit limit is normally equal to the original line of credit amount. This applies to open tradelines only. This is expressed as a percent: 50% shows as 50.

Applicant Debt Ratio Stated After Requested Line of credit Amount

This is the debt divided by available credit based on the values stated by the applicant after factoring in the requested line of credit amount - this information is not taken from the bureau. This is expressed as a percent: 50% shows as 50.

Applicant Debt Ratio Stated Before Requested Line of credit Amount

This is the debt divided by available credit based on the values stated by the applicant before factoring in the requested line of credit amount - this information is not taken from the bureau. This is expressed as a percent: 50% shows as 50.

Applicant Debt To Income Ratio Stated After Requested Line of credit Amount

This is the debt divided by income based on the values stated by the applicant after factoring in the requested line of credit amount - this information is not taken from the bureau. This is expressed as a percent: 50% shows as 50.

Applicant Debt To Income Ratio Stated Before Requested Line of credit Amount

This is the debt divided by income based on the values stated by the applicant before factoring in the requested line of credit amount - this information is not taken from the bureau. This is expressed as a percent: 50% shows as 50.

Applicant Payment To Income Ratio Stated

This is the total amount of all monthly payments divided by monthly income. These values are stated by the applicant and not taken from the bureau. This is expressed as a percent: 50% shows as 50.

Applicant Prior Customer

This parameter indicates whether the applicant is a prior customer. It is populated when the application is passed to Underwriting for a decision. If the SSN given by the applicant already exists then the applicant is marked as a prior customer and the parameter value is Y (Yes).

Applicant Revolving Debt Ratio Stated

This is the sum of all revolving type line of credit amount balances / sum of all revolving type credit limits. This applies to open tradelines only. This is expressed as a percent: 50% shows as 50.

Applicant Stated Employment Period (In Months)

This parameter looks at the number of months of stated employment for the most recently entered current employment.

For example, the applicant states that she has been working at her current place of employment for 3 years and 5 months. This parameter would be populated with (3years * 12 months/year) + 5 months which calculates to 41 stated months. If the applicant enters another current employment and enters 1 year and 2 months then this parameter will be populated with 14 months, even though the other employment is still current.

Applicant Stated Monthly Income

This is the monthly income stated by the applicant on the application. It combines the income for all employment marked as **current** in the system. If the income is stated as anything other than monthly, the income will be converted to monthly for this parameter.

For example, the applicant states that he is paid \$50,000 with a frequency of ANNUALLY. This parameter is populated with \$50,000/12, which calculates to \$4166.67 stated monthly income.

Applicant Stated Monthly Liability

This is the stated monthly liability as provided by the applicant on the Application Entry screen.

Applicant Stated Residence Period (In Months)

This parameter looks at the stated residence period for the most recent current address.

A.2.2 Line of Credit Details

Approximate Cash Price

This is the Approximate Cash price taken from the **Approx Price** field on the Application Entry form's Line of Credit screen in the system.

Requested Advance Amount

This is the Requested Advance Amount value taken from the Application Entry form's Line of Credit screen in the system.

A.2.3 Auto Trades / Inquiries

Applicant Credit Bureau 6month Auto Trades

This is the number of auto trades that have been opened in the last 6 months. Note that these trades may now be open or closed, paid as agreed, delinquent, or derogatory, and so on.

Applicant Credit Bureau 12month Auto Trades

This is the number of auto trades that have been opened in the last 12 months. Note that these trades may now be open or closed, paid as agreed, delinquent, or derogatory, and so on.

Applicant Credit Bureau 24month Auto Trades

This is the number of auto trades that have been opened in the last 24 months. Note that these trades may now be open or closed, paid as agreed, delinquent, or derogatory, and so on.

Applicant Credit Bureau Auto Inquiries

This is the number of automobile-related credit inquiries the have been made to the bureau.

Applicant Credit Bureau Auto Trades

This is the number of auto trades, both open and closed. Note that these trades may be paid as agreed, delinquent, derogatory, and so on. The parameter makes no distinction.

Applicant Credit Bureau Current Auto Trades

Total number of auto trades that are paid on time right now. These trades may or may not have been delinquent in the past.

Applicant Credit Bureau Open Auto Trades

This is the number of open auto trades on the account. Note that these trades may be paid as agreed, delinquent, derogatory, and so on. The parameter makes no distinction.

Applicant Credit Bureau Satisfactory Auto

Total number of auto trades paid as agreed (no delinquencies) for the entire life of the trade. This could be a few months or several years- the parameter makes no distinction.

Applicant Credit Bureau Worst Auto Trade

The rating code used for this parameter is the same rating code system displayed for the tradelines. The different bureaus use different systems so Oracle Financial Services Lending and Leasing changes them to a common format that is used in the scoring:

- 1 = current
- 2 = 30-59 days late
- 3 = 60-89 days late
- 4 = 90-119 days late
- 5 = 120-149 days late
- 6 = 150- days late
- 7 = involved in a bankruptcy
- 8 = repossession, foreclosure
- 9 = charge-off

A.2.4 Bank Trades / Inquiries

Applicant Credit Bureau 12month Bank Trades

This is the number of bank trades that have been opened in the last 12 months. Note that these trades may now be open or closed, paid as agreed, delinquent, or derogatory, and so on.

Applicant Credit Bureau 24month Bank Trades

This is the number of bank trades that have been opened in the last 24 months. Note that these trades may now be open or closed, paid as agreed, delinquent, or derogatory, and so on.

Applicant Credit Bureau 6month Bank Trades

This is the number of bank trades that have been opened in the last 6 months. Note that these trades may now be open or closed, paid as agreed, delinquent, or derogatory, and so on.

Applicant Credit Bureau Bank Inquiries

This is the number of bank inquiries against the bureau in the applicant's recorded bureau history.

Applicant Credit Bureau Bank Trades

This is the number of open bank trades on the account. Note that bank trades can be considered a sub type to installment, mortgage, and / or revolving Line of Credit.

Applicant Credit Bureau Bank Trades

Total number of bank trades that are paid on time right now. These trades may or may not have been delinquent in the past.

Applicant Credit Bureau Bank Trades

This is the number of bank trades that are open right now. Note that these trades may now be open or closed, paid as agreed, delinquent, or derogatory, and so on.

Applicant Credit Bureau Bank Trades

This parameter shows the **current** revolving bank balance. If the revolving credit is owned by a bank, then it will show up here.

Applicant Credit Bureau Bank Trades

This parameter shows the highest cumulative balance among all revolving bank credit over the bureau history.

Note

If the applicant had \$5,000 on one account 2 years ago and \$10,000 on another account 4 years ago, this parameter would return \$15,000. The parameter is of questionable utility in many situations.

Applicant Credit Bureau Bank Trades

Total number of bank trades paid as agreed (no delinquencies) for the entire life of the trade. This could be a few months or several years- the parameter makes no distinction.

Applicant Credit Bureau Bank Trades

The rating code used for this parameter is the same rating code system displayed for the tradelines. The different bureaus use different systems so Oracle Financial Services Lending and Leasing changes them to a common format that is used in the scoring:

1 = current

- 2 = 30-59 days late
- 3 = 60-89 days late
- 4 = 90-119 days late
- 5 = 120-149 days late
- 6 = 150- days late
- 7 = involved in a bankruptcy
- 8 = repossession, foreclosure
- 9 = charge-off

A.2.5 Card Trades / Inquiries

Applicant Credit Bureau Bank Trades

This is the number of card trades that have been opened in the last 12 months. Note that these trades may now be open or closed, paid as agreed, delinquent, or derogatory, and so on.

Applicant Credit Bureau Bank Trades

This is the number of card trades that have been opened in the last 24 months. Note that these trades may now be open or closed, paid as agreed, delinquent, or derogatory, and so on.

Applicant Credit Bureau Bank Trades

This is the number of card trades that have been opened in the last 6 months. Note that these trades may now be open or closed, paid as agreed, delinquent, or derogatory, and so on.

Applicant Credit Bureau Bank Trades

This is the number of card inquiries that have been made against the bureau for the applicant in the bureau's recorded history.

Applicant Credit Bureau Card Trades

This is the number of card trades, both open and closed, in the bureau history. Note that these trades may be paid as agreed, delinquent, derogatory, and so on. The parameter makes no distinction.

Applicant Credit Bureau Current Card Trades

Total number of card trades that are paid on time right now. These trades may or may not have been delinquent in the past.

Applicant Credit Bureau Open Card Trades

This is the number of open card trades on the account. Note that these trades may be paid as agreed, delinquent, derogatory, and so on. The parameter makes no distinction.

Applicant Credit Bureau Satisfactory Card

Total number of card trades paid as agreed (no delinquencies) for the entire life of the trade. This could be a few months or several years- the parameter makes no distinction.

Applicant Credit Bureau Worst Card Trade

The rating code used for this parameter is the same rating code system displayed for the tradelines. The different bureaus use different systems so Oracle Financial Services Lending and Leasing changes them to a common format that is used in the scoring:

- 1 = current
- 2 = 30-59 days late
- 3 = 60-89 days late
- 4 = 90-119 days late
- 5 = 120-149 days late
- 6 = 150- days late
- 7 = involved in a bankruptcy
- 8 = repossession, foreclosure
- 9 = charge-off

A.2.6 Installment Trades / Inquiries

Applicant Credit Bureau 12month Inst Trades

This is the number of installment trades that have been opened in the last 12 months. Note that these trades may now be open or closed, paid as agreed, delinquent, or derogatory, and so on.

Applicant Credit Bureau 24month Inst Trades

This is the number of installment trades that have been opened in the last 24 months. Note that these trades may now be open or closed, paid as agreed, delinquent, or derogatory, and so on.

Applicant Credit Bureau 6month Inst Trades

This is the number of installment trades that have been opened in the last 6 months. Note that these trades may now be open or closed, paid as agreed, delinquent, or derogatory, and so on.

Applicant Credit Bureau Current Inst Trades

Total number of installment trades that are paid on time right now. These trades may or may not have been delinquent in the past.

Applicant Credit Bureau Inst Trades

This is the number of installment trades, both open and closed. Note that these trades may be paid as agreed, delinquent, derogatory, and so on. The parameter makes no distinction.

Applicant Credit Bureau Open Inst Trades

This is the number of open installment trades on the account. Note that these trades may be paid as agreed, delinquent, derogatory, and so on. The parameter makes no distinction.

Applicant Credit Bureau Satisfactory Inst Trades

Total number of installment trades paid as agreed (no delinquencies) for the entire life of the trade. This could be a few months or several years- the parameter makes no distinction.

Applicant Credit Bureau Worst Inst Trade

The rating code used for this parameter is the same rating code system displayed for the tradelines. The different bureaus use different systems so Oracle Financial Services Lending and Leasing changes them to a common format that is used in the scoring:

- 1 = current

- 2 = 30-59 days late
- 3 = 60-89 days late
- 4 = 90-119 days late
- 5 = 120-149 days late
- 6 = 150- days late
- 7 = involved in a bankruptcy
- 8 = repossession, foreclosure
- 9 = charge-off

A.2.7 Line of Credit Finance Trades / Inquiries

Applicant Credit Bureau 12month Line of Credit Fin Trades

This is the number of Line of Credit finance trades that have been opened in the last 12 months. Note that these trades may now be open or closed, paid as agreed, delinquent, or derogatory, and so on.

Applicant Credit Bureau 24month Line of Credit Fin Trades

This is the number of Line of Credit finance trades that have been opened in the last 24 months. Note that these trades may now be open or closed, paid as agreed, delinquent, or derogatory, and so on.

Applicant Credit Bureau 6month Line of Credit Fin Trades

This is the number of Line of Credit finance trades that have been opened in the last 6 months. Note that these trades may now be open or closed, paid as agreed, delinquent, or derogatory, and so on.

Applicant Credit Bureau Current Line of Credit Fin Trades

Total number of Line of Credit finance trades that are paid on time right now. These trades may or may not have been delinquent in the past.

Applicant Credit Bureau Line of Credit Fin Trades

This is the number of Line of Credit finance trades, both open and closed. Note that these trades may be paid as agreed, delinquent, derogatory, and so on. The parameter makes no distinction.

Applicant Credit Bureau Line of Credit Finance Inquiries

This is the number of Line of Credit finance inquiries listed on the credit report. The bureaus have their own limits as to how long they keep an inquiry on the credit report, but this parameter will show whatever total is shown for that bureau.

Applicant Credit Bureau Open Line of Credit Finance Trades

This is the number of open Line of Credit finance trades on the account. Note that these trades may be paid as agreed, delinquent, derogatory, and so on. The parameter makes no distinction.

Applicant Credit Bureau Satisfactory Line of Credit Fin

Total number of Line of Credit finance trades paid as agreed (no delinquencies) for the entire life of the trade. This could be a few months or several years- the parameter makes no distinction.

Applicant Credit Bureau Worst Line of Credit Fin Trade

The rating code used for this parameter is the same rating code system displayed for the tradelines. The different bureaus use different systems so Oracle Financial Services Lending and Leasing changes them to a common format that is used in the scoring:

- 1 = current
- 2 = 30-59 days late
- 3 = 60-89 days late
- 4 = 90-119 days late
- 5 = 120-149 days late
- 6 = 150- days late
- 7 = involved in a bankruptcy
- 8 = repossession, foreclosure
- 9 = charge-off

A.2.8 Mortgage Trades / Inquiries

Applicant Credit Bureau 12month Mortgage Trades

This is the number of mortgage trades that have been opened in the last 12 months. Note that these trades may now be open or closed, paid as agreed, delinquent, or derogatory, and so on.

Applicant Credit Bureau 24month Mortgage Trades

This is the number of mortgage trades that have been opened in the last 24 months. Note that these trades may now be open or closed, paid as agreed, delinquent, or derogatory, and so on.

Applicant Credit Bureau 6month Mortgage Trades

This is the number of mortgage trades that have been opened in the last 6 months. Note that these trades may now be open or closed, paid as agreed, delinquent, or derogatory, and so on.

Applicant Credit Bureau Current Mortgage Trades

Total number of mortgage trades that are paid on time right now. These trades may or may not have been delinquent in the past.

Applicant Credit Bureau Mortgage Trades

This is the total number of mortgage trades, both open and closed. Note that these trades may be paid as agreed, delinquent, derogatory, and so on. The parameter makes no distinction.

Applicant Credit Bureau Open Mortgage Trades

This is the number of open mortgage trades on the account. Note that these trades may be paid as agreed, delinquent, derogatory, and so on. The parameter makes no distinction.

Applicant Credit Bureau Satisfactory Mortgage

Total number of mortgage trades paid as agreed (no delinquencies) for the entire life of the trade. This could be a few months or several years- the parameter makes no distinction.

Applicant Credit Bureau Worst Mortgage Trade

The rating code used for this parameter is the same rating code system displayed for the tradelines. The different bureaus use different systems so Oracle Financial Services Lending and Leasing changes them to a common format that is used in the scoring:

- 1 = current
- 2 = 30-59 days late
- 3 = 60-89 days late
- 4 = 90-119 days late
- 5 = 120-149 days late
- 6 = 150- days late
- 7 = involved in a bankruptcy
- 8 = repossession, foreclosure
- 9 = charge-off

A.2.9 Retail Trades / Inquiries

Applicant Credit Bureau 12month Retail Trades

This is the number of retail trades that have been opened in the last 12 months. Note that these trades may now be open or closed, paid as agreed, delinquent, or derogatory, and so on.

Applicant Credit Bureau 24month Retail Trades

This is the number of retail trades that have been opened in the last 24 months. Note that these trades may now be open or closed, paid as agreed, delinquent, or derogatory, and so on.

Applicant Credit Bureau 6month Retail Trades

This is the number of retail trades that have been opened in the last 6 months. Note that these trades may now be open or closed, paid as agreed, delinquent, or derogatory, and so on.

Applicant Credit Bureau Current Retail Trades

Total number of retail trades that are paid on time right now. These trades may or may not have been delinquent in the past.

Applicant Credit Bureau Open Retail Trades

This is the number of open retail trades on the account. Note that these trades may be paid as agreed, delinquent, derogatory, and so on. The parameter makes no distinction.

Applicant Credit Bureau Retail Inquiries

This is the number of retail inquiries listed on the credit report. The bureaus have their own limits as to how long they keep an inquiry on the credit report, but this parameter will show whatever total is shown for that bureau.

Applicant Credit Bureau Retail Trades

This is the number of retail trades, both open and closed. Note that these trades may be paid as agreed, delinquent, derogatory, and so on. The parameter makes no distinction.

Applicant Credit Bureau Satisfactory Retail

Total number of retail trades paid as agreed (no delinquencies) for the entire life of the trade. This could be a few months or several years- the parameter makes no distinction.

Applicant Credit Bureau Worst Retail Trade

The rating code used for this parameter is the same rating code system displayed for the tradelines. The different bureaus use different systems so Oracle Financial Services Lending and Leasing changes them to a common format that is used in the scoring:

- 1 = current
- 2 = 30-59 days late
- 3 = 60-89 days late
- 4 = 90-119 days late
- 5 = 120-149 days late
- 6 = 150- days late
- 7 = involved in a bankruptcy
- 8 = repossession, foreclosure
- 9 = charge-off

A.2.10 Revolving Trades

Applicant Credit Bureau 12month Rev Trades

This is the number of revolving trades that have been opened in the last 12 months. Note that these trades may now be open or closed, paid as agreed, delinquent, or derogatory, and so on.

Applicant Credit Bureau 24month Rev Trades

This is the number of revolving trades that have been opened in the last 24 months. Note that these trades may now be open or closed, paid as agreed, delinquent, or derogatory, and so on.

Applicant Credit Bureau 6month Rev Trades

This is the number of revolving trades that have been opened in the last 6 months. Note that these trades may now be open or closed, paid as agreed, delinquent, or derogatory, and so on.

Applicant Credit Bureau Current Rev Trades

Total number of revolving trades that are paid on time right now. These trades may or may not have been delinquent in the past.

Applicant Credit Bureau Open Rev Trades

This is the number of open revolving trades on the account. Note that these trades may be paid as agreed, delinquent, derogatory, and so on. The parameter makes no distinction.

Applicant Credit Bureau Rev Balance

This is the total revolving credit balance shown on the applicant's credit bureau. This applies to all open revolving trades.

Applicant Credit Bureau Rev High Balance

This parameter shows the highest cumulative balance among all revolving credit over the bureau history.

Note

If the applicant had \$5,000 on one account 2 years ago and \$10,000 on another account 4 years ago, this parameter would return \$15,000. The parameter is of questionable utility in many situations.

Applicant Credit Bureau Rev Retail Balance

This is the current revolving retail trade balance shown on the applicant's credit bureau. This applies to all open retail trades. It shows current, not historical, information.

Applicant Credit Bureau Rev Retail High Balance

This parameter shows the highest cumulative balance among all revolving retail credit over the bureau history.

Note

If the applicant had \$5,000 on one account 2 years ago and \$10,000 on another account 4 years ago, this parameter would return \$15,000. The parameter is of questionable utility in many situations.

Applicant Credit Bureau Rev Trades

This is the number of revolving trades, both open and closed. Note that these trades may be paid as agreed, delinquent, derogatory, and so on. The parameter makes no distinction.

Applicant Credit Bureau Satisfactory Rev Trades

Total number of revolving trades paid as agreed (no delinquencies) for the entire life of the trade. This could be a few months or several years- the parameter makes no distinction.

Applicant Credit Bureau Worst Rev Trade

The rating code used for this parameter is the same rating code system displayed for the tradelines. The different bureaus use different systems so Oracle Financial Services Lending and Leasing changes them to a common format that is used in the scoring:

- 1 = current
- 2 = 30-59 days late
- 3 = 60-89 days late
- 4 = 90-119 days late
- 5 = 120-149 days late
- 6 = 150- days late
- 7 = involved in a bankruptcy
- 8 = repossession, foreclosure
- 9 = charge-off

A.2.11 Sales Finance Trades / Inquiries

Applicant Credit Bureau 12month Sales Fin Trades

This is the number of sales finance trades that have been opened in the last 12 months. Note that these trades may now be open or closed, paid as agreed, delinquent, or derogatory, and so on.

Applicant Credit Bureau 24month Sales Fin Trades

This is the number of sales finance trades that have been opened in the last 24 months. Note that these trades may now be open or closed, paid as agreed, delinquent, or derogatory, and so on.

Applicant Credit Bureau 6month Sales Fin Trades

This is the number of sales finance trades that have been opened in the last 6 months. Note that these trades may now be open or closed, paid as agreed, delinquent, or derogatory, and so on.

Applicant Credit Bureau Current Sales Fin Trades

Total number of sales finance trades that are paid on time right now. These trades may or may not have been delinquent in the past.

Applicant Credit Bureau Open Sales Finance Trades

This is the number of open sales finance trades on the account. Note that these trades may be paid as agreed, delinquent, derogatory, and so on. The parameter makes no distinction.

Applicant Credit Bureau Sales Fin Trades

This is the number of sales finance trades, both open and closed. Note that these trades may be paid as agreed, delinquent, derogatory, and so on. The parameter makes no distinction.

Applicant Credit Bureau Sales Finance Inquiries

This is a count of the number of sales finance inquiries that have been made against the Applicant's bureau information in the bureau history.

Applicant Credit Bureau Satisfactory Sales Fin

Total number of sales finance trades paid as agreed (no delinquencies) for the entire life of the trade. This could be a few months or several years- the parameter makes no distinction.

Applicant Credit Bureau Worst Sales Fin Trade

The rating code used for this parameter is the same rating code system displayed for the tradelines. The different bureaus use different systems so Oracle Financial Services Lending and Leasing changes them to a common format that is used in the scoring:

1 = current

2 = 30-59 days late

3 = 60-89 days late

4 = 90-119 days late

5 = 120-149 days late

6 = 150- days late

- 7 = involved in a bankruptcy
- 8 = repossession, foreclosure
- 9 = charge-off

A.2.12 Other Trades

Applicant Credit Bureau 12month Trades

This is the number of all trades that have been opened in the last 12 months. Note that these trades may now be open or closed, paid as agreed, delinquent, or derogatory, and so on.

Applicant Credit Bureau 24month Trades

This is the number of all trades that have been opened in the last 24 months. Note that these trades may now be open or closed, paid as agreed, delinquent, or derogatory, and so on.

Applicant Credit Bureau 6month Trades

This is the number of all trades that have been opened in the last 6 months. Note that these trades may now be open or closed, paid as agreed, delinquent, or derogatory, and so on.

Applicant Credit Bureau Avg Open Trade Age

This is the average trade age in months as calculated using all open trades in the bureau. This is based on taking all of the open tradelines, then dividing by the age.

Applicant Credit Bureau Avg Trade Age

This is the average trade age in months as calculated using all trades, open and closed, in the bureau.

Applicant Credit Bureau Chargeoff Trades

This parameter is a count of the total number of charged off trades for that applicant in the bureau.

Applicant Credit Bureau Collections

This is the total number of trades in collections for that applicant in the credit bureau. This refers to accounts assigned to collections agencies.

Applicant Credit Bureau Current Trades

This is the total number of trades that are paid on time right now. These trades may or may not have been delinquent in the past.

Applicant Credit Bureau Inquiries

This is the number of inquiries listed on the credit report. The bureaus have their own limits as to how long they keep an inquiry on the credit report, but this parameter will show whatever total is shown for that bureau.

Applicant Credit Bureau Inquiries 12m

This is the total number of inquiries that have been made against the credit bureau for that applicant in the last 12 months.

Applicant Credit Bureau Inquiries 24m

This is the total number of inquiries that have been made against the credit bureau for that applicant in the last 24 months.

Applicant Credit Bureau Inquiries 6m

This is the total number of inquiries that have been made against the credit bureau for that applicant in the last 6 months.

Applicant Credit Bureau Judgments

This is a count of the number of judgments against the applicant in the credit bureau.

Applicant Credit Bureau Liens

This is the total number of liens shown for the applicant in the credit bureau for that applicant.

Applicant Credit Bureau Newest Inquiry

This is the number of months since the most recent inquiry in the credit bureau for that applicant. This of course excludes the pull from the immediate past used to do the scoring in this particular situation in the system.

Applicant Credit Bureau Newest Trade

This is the number of months between now and the newest trade in the bureau for that applicant.

Applicant Credit Bureau Oldest Inquiry

This is the number of months between now and the oldest inquiry in the bureau for that applicant.

Applicant Credit Bureau Oldest Trade

This is the number of months between now and the oldest trade in the bureau for that applicant. Oldest is determined by looking at the oldest date on any tradeline, and then showing that.

Applicant Credit Bureau Open Collection Trades

This is the number of open trades in collections shown in the bureau for that applicant. This refers to any accounts assigned to in-house collections departments (as compared to 5.12.7).

Applicant Credit Bureau Open Collections

This is the number of open collections in the bureau for that applicant.

Applicant Credit Bureau Open Judgments

This is the total number of open (unsatisfied) judgments against the applicant as indicated in the bureau for that applicant.

Applicant Credit Bureau Open Liens

This is the total number of open liens against the applicant as indicated in the bureau for that applicant.

Applicant Credit Bureau Open Trades

This is the number of all open auto trades on the account. Note that these trades may be paid as agreed, delinquent, derogatory, and so on. The parameter makes no distinction.

Applicant Credit Bureau Past Due 30

This is the number of trades that have been 30 or more days past due at some point in the recorded history of the bureau. Note that these trades may be delinquent, derogatory, and so on. The parameter makes no distinction.

Applicant Credit Bureau Past Due 30 12m

This is the number of trades that have been more than 30 days past due in the last 12 months. The past dues could be for the same or different trades. If one trade has been late 3 times, this parameter would show 1 if there are no other trades.

Applicant Credit Bureau Past Due 30 24m

This is the number of times the applicant has been more than 30 days past due in the last 24 months. The past dues could be for the same or different trades. If one trade has been late 3 times, this parameter would show 1 if there are no other trades.

Applicant Credit Bureau Past Due 60

This is the number of times the applicant has been more than 60 days past due in the recorded history of the bureau. The past dues could be for the same or different trades. If one trade has been late 3 times, this parameter would show 1 if there are no other trades.

Applicant Credit Bureau Past Due 60 12m

This is the number of times the applicant has been more than 60 days past due in the last 12 months. The past dues could be for the same or different trades. If one trade has been late 3 times, this parameter would show 1 if there are no other trades.

Applicant Credit Bureau Past Due 60 24m

This is the number of times the applicant has been more than 60 days past due in the last 24 months. The past dues could be for the same or different trades. If one trade has been late 3 times, this parameter would show 1 if there are no other trades.

Applicant Credit Bureau Past Due 90

This is the number of trades that are 90 or more days past due in the recorded history of the bureau. Note that these trades may be delinquent, derogatory, and so on. The parameter makes no distinction that one trade has been late 3 times; this parameter would show 1 if there are no other trades. If one trade has been late 3 times, this parameter would show 1 if there are no other trades.

Applicant Credit Bureau Past Due 90 12m

This is the number of times the applicant has been more than 90 days past due in the last 12 months. The past dues could be for the same or different trades. If one trade has been late 3 times, this parameter would show 1 if there are no other trades.

Applicant Credit Bureau Past Due 90 24m

This is the number of times the applicant has been more than 90 days past due in the last 24 months. The past dues could be for the same or different trades. If one trade has been late 3 times, this parameter would show 1 if there are no other trades.

Applicant Credit Bureau Past Due Now

This is the number of trades on which the applicant is currently past due, according to the bureau.

Applicant Credit Bureau Repossessions

This is the number of repossessions shown on the bureau for the applicant in the history of the bureau.

Applicant Credit Bureau Satisfactory Trades

This is the total number of trades of all types, paid as agreed (no delinquencies) for the entire life of the trade. This could be a few months or several years- the parameter makes no distinction.

Applicant Credit Bureau Too New Trades

This shows the number of trades that have been reported where a lender is reporting a brand new account, but has not even billed the applicant yet.

Applicant Credit Bureau Trade Collections

This is the number of trades in collections assigned to collections agencies shown on the bureau for the applicant in the history of the bureau.

Applicant Credit Bureau Trades

This is the number of trades in the history of the credit bureau for that applicant. Note that different bureaus store information for varying amounts of time.

Applicant Credit Bureau Worst Trades

The rating code used for this parameter is the same rating code system displayed for the tradelines. The different bureaus use different systems so Oracle Financial Services Lending and Leasing changes them to a common format that is used in the scoring:

- 1 = current
- 2 = 30-59 days late
- 3 = 60-89 days late
- 4 = 90-119 days late
- 5 = 120-149 days late
- 6 = 150- days late
- 7 = involved in a bankruptcy
- 8 = repossession, foreclosure
- 9 = charge-off

A.2.13 Bankruptcy Information

Applicant Credit Bureau 11 Bankruptcies

This parameter provides a count of the number of Chapter 11 Bankruptcies the applicant has filed in the stored history of the bureau.

Applicant Credit Bureau 13 Bankruptcies

This parameter provides a count of the number of Chapter 13 Bankruptcies the applicant has filed in the stored history of the bureau.

Applicant Credit Bureau 7 Bankruptcies

This parameter provides a count of the number of Chapter 7 Bankruptcies the applicant has filed in the stored history of the bureau.

Applicant Credit Bureau Bankruptcies

This parameter provides a count of the number of bankruptcies of any type the applicant has filed in the stored history of the bureau.

Applicant Credit Bureau Bkrp Score

The bureaus offer two basic types of scores, a FICO type, and a bankruptcy type. The term FICO score is sometimes used as a generic term for a credit score, but it is supposed to mean that the score is based on an algorithm purchased or licensed from Fair Isaac Corp. In the system, if a score is listed as a FICO score, it is based on a Fair Isaac model. A bankruptcy score is a score that is used to predict the likelihood of a consumer to file bankruptcy. It is provided much like a FICO score.

Applicant Credit Bureau Open 11 Bankruptcies

This parameter provides a count of the number of open Chapter 11 Bankruptcies associated with the applicant in the bureau.

Applicant Credit Bureau Open 13 Bankruptcies

This parameter provides a count of the number of open Chapter 13 Bankruptcies associated with the applicant in the bureau.

Applicant Credit Bureau Open 7 Bankruptcies

This parameter provides a count of the number of open Chapter 7 Bankruptcies associated with the applicant in the bureau.

Applicant Credit Bureau Open Bankruptcies

This parameter provides a count of the number of bankruptcies of any type the applicant X has open currently.

Applicant Credit Bureau Recent 11 Bankruptcy

For this parameter, **Recent** refers to the number of months since the subject's most recent bankruptcy filing. One would use this parameter to determine if the subject has filed for Chapter 11 bankruptcy in the last X months.

Applicant Credit Bureau Recent 13 Bankruptcy

For this parameter, **Recent** refers to the number of months since the subject's most recent bankruptcy filing. One would use this parameter to determine if the subject has filed for Chapter 13 bankruptcy in the last X months.

Applicant Credit Bureau Recent 7 Bankruptcy

For this parameter, **Recent** refers to the number of months since the subject's most recent bankruptcy filing. One would use this parameter to determine if the subject has filed for Chapter 7 bankruptcy in the last X months.

Applicant Credit Bureau Recent Bankruptcy

For this parameter, **Recent** refers to the number of months since the subject's most recent bankruptcy filing. One would use this parameter to determine if the subject has filed for any kind of bankruptcy in the last X months.

Applicant Has A Prior Bankruptcy

This parameter tracks whether the applicant has indicated a prior bankruptcy based on the checkbox in the system's Origination module. The prior bankruptcy is set to **Y** if the checkbox is checked otherwise it has a value of **N**.

A.2.14 Delinquency Information

Applicant Credit Bureau Longest Since Major

This parameter reflects the longest period (in months) a tradeline has been open since the last derog.

Applicant Credit Bureau Longest Since Minor

This parameter reflects the longest period (in months) a tradeline has been open since the last minor delinquency.

Applicant Credit Bureau Open Longest Since Major

This parameter considers the greatest amount of time (in months) between now and the corresponding major delinquency for all of the open parameters with major delinquencies, and reflects the greatest value returned.

Applicant Credit Bureau Open Longest Since Minor

This parameter considers the greatest amount of time (in months) between now and the corresponding minor delinquency for all of the open parameters with minor delinquencies, and reflects the greatest value returned.

Applicant Credit Bureau Open Shortest Since Major

This parameter considers the least amount of time (in months) between now and the corresponding major delinquency for all of the open parameters with major delinquencies, and reflects the least value returned.

Applicant Credit Bureau Open Shortest Since Minor

This parameter considers the least amount of time (in months) between now and the corresponding minor delinquency for all of the open parameters with minor delinquencies, and reflects the least value returned.

Applicant Credit Bureau Shortest Since Major

This parameter considers the least amount of time (in months) between now and the corresponding major delinquency for all of the parameters (open and closed) with major delinquencies, and reflects the least value returned.

Applicant Credit Bureau Shortest Since Minor

This parameter considers the least amount of time (in months) between now and the corresponding minor delinquency for all of the parameters (open and closed) with minor delinquencies, and reflects the least value returned.

A.2.15 Derogatory Trade Information

Applicant Credit Bureau Derog 12m Trades

Provides the number of trades that were derogatory in the last 12 months. This includes open and closed trades. These trades may or may not be derogatory now.

Applicant Credit Bureau Derog 24m Trades

Provides the number of trades that were derogatory in the last 24 months. This includes open and closed trades. These trades may or may not be derogatory now.

Applicant Credit Bureau Derog Now Trades

Provides the number of trades that are derogatory right now. Does this include closed trades?

Applicant Credit Bureau Derog Trades

This parameter addresses the number of derogatory trades associated with the applicant. This includes open and closed trades.

Applicant Credit Bureau Longest Since Derog

This parameter covers the longest period (in months) since last derog.

Applicant Credit Bureau Open Longest Since Derog

This parameter covers the longest period (in months) a tradeline has been open since the last derog.

Applicant Credit Bureau Open Shortest Since Derog

This parameter considers the least amount of time (in months) between now and the corresponding derog for all of the open parameters with derogs, and reflects the least value returned.

Applicant Credit Bureau Shortest Since Derog

This parameter considers the least amount of time (in months) between now and the corresponding derog for all of the parameters (open and closed) with derogs, and reflects the least value returned.

B

Appendix : Rounding Amounts and Rate Attributes

This topic provides the information about the rounding rules applied to amounts and rate-related attributes to ensure accuracy and consistency within the system.

Rounding Amounts

Generally in the lending industry, computed amounts (interest, fees, costs and so on) are rounded to the second decimal place. However, there are occasions where the rounding of the computed amounts has to be carried out using different methods. Oracle Financial Services Lending and Leasing supports the rounding, raising of or cutting off calculated amount.

- **Rounding** will increase the resulting amount to next number up to the second decimal, based on values of third decimal.
- **Raising** will always increase the resulting amount to next number up to the second decimal.
- **Cutting off** will always cut the number after the second decimal.

Note

The system rounds only calculated amounts (calculated fees, calculated payment, and so on) and not user-entered amounts.

User can choose the rounding method user want to use by setting the parameter value for system parameter CMN_AMOUNT_ROUND_METHOD on the Administration form (**Setup**, click **Administration**. Under **Administration**, click **System**. Under **System**, click **System Parameters**. Under **System Parameters**, click **System** tab).

User can choose the rounding factor user want to use by setting the parameter value for system parameter CMN_AMOUNT_ROUND_FACTOR on the Administration form. Currently, Oracle Financial Services Lending and Leasing supports rounding up to two decimals only.

Examples of how resulting amounts differ by RAISE, ROUND, and CUTOFF:

Table B-1 Example 1: Amount: 234.136

Method	Result
Round	234.14
Raise	234.14
Cut off	234.13

Table B-2 Example 2: Amount: 234.134

Method	Result
Round	234.13

Table B-2 (Cont.) Example 2: Amount: 234.134

Method	Result
Raise	234.14
Cut off	234.13

Table B-3 Example 3: Amount: 234.1319999

Method	Result
Round	234.13
Raise	234.14
Cut off	234.13

Rate Attributes

The system supports rounding of index rate to keep the rate calculation as simple as possible for the customers. The general practice is to round the rate to nearest eighth (1/8th) (to keep index rate in the multiple of 125) or fourth (1/4th) (to keep index rate in the multiple of 25). The system rounds only index rate and not the margin or final rate. User can define the index rounding method on the Product tab's Product Definition screen for variable rate product.

The system currently supports the following rounding of methods.

1. NO ROUNDING TO INDEX RATE
2. INDEX RATE ROUNDED TO NEAREST.25
3. INDEX RATE ROUNDED TO NEAREST.125

NO ROUNDING TO INDEX RATE:

Select this method for no rounding.

INDEX RATE ROUNDED TO NEAREST 0.25:

Select this method to round up to 1/4th (to keep the index rate in the multiple of 0.25).

Examples:**Table B-4 Example 1**

Type	Value
Current rate:	5.125
Round of rate:	5.25

Table B-5 Example 2

Type	Value
Current rate:	5.124
Round of rate:	5.00

INDEX RATE ROUNDED TO NEAREST 0.125:

Select this method to round up to 1/8th (to keep the index rate in the multiple of 0.125).

Examples:**Table B-6 Example 1**

Type	Value
Current rate:	5.325
Rate rounded to:	5.375

Table B-7 Example 2

Type	Value
Current rate:	5.312
Rate rounded to:	5.250

C

Appendix : System Parameters

This topic consists of the following sections:

- [Introduction](#)
- [System Parameters](#)
- [Organization Parameters](#)
- [Company Parameters](#)
- [Other Parameters](#)

C.1 Introduction

System defined parameters help in configuring system specific data, User-access, location of system files; reports related URLs and other administration controlled data. These are essential to be configured during installation and some of them by nature of application will have to be reviewed and maintained in a regular and periodic manner.

Following are the types of parameters are used in OFSLL system depending on the areas of the system that these would apply and impact:

- [System Parameters](#)
- [Organization Parameters](#)
- [Company Parameters](#)
- [Other Parameters](#)

Note

All the above parameters can be controlled (enabled/disabled) only by System Administrators, and users with Admin/Super User privileges who would be involved in setting-up OFSLL system.

C.2 System Parameters

System parameters apply to the entire system. They relate to the overall processing of the system like application server file locations, data purging configurations and so on.

Table below details the list of system parameters with their description and pre-defined values.

Table C-1 System Parameters

Parameter	Description
ACA_DLQ_AMT_EXCLUDED	This parameter is used to exclude delinquency amount for account ACH

Table C-1 (Cont.) System Parameters

Parameter	Description
ACA_PAYMENT_AUTO_LOAD	This parameter is used to control posting directly from the ACH file that has been created for customer payments. Input parameter value is Boolean (Yes/No). If the parameter is set to Y , the system automatically creates payment batches for the payments in the ACH file and posts them on the day of payment.
ACA_PRENOTE_DAYS	This parameter is used to define the number of days the prenote should be initiated for customer ACH (Automated Clearing House) accounts. Input parameter value is numeric.
ACA_PRE_PROCESS_DAYS	This parameter is used to specify the number of days before draft day for Account ACH process. Input parameter value is numeric.
ACH_PAYEE_PRENOTE_DAYS	This parameter is used to define the number of days for prenote to occur for Producer or Vendor ACH accounts. Input parameter value is numeric.
ADMIN_SERVER_URL	This parameter is used to define the admin server URL.
ADR_DIRECTORY	This parameter is used to define the Oracle Directory Object Name for ADR file location.
ADR_PROCESSED_DIRECTORY	This parameter is used to define the Oracle Directory Object Name for ADR file location.
AGE_APPROVED_CONDITIONED_DAYS	This parameter is used to specify the number of days by which an application in Approved or Conditioned status is treated as Aged Application. Input parameter value is numeric with no upper limit.
AGE_CONTRACT_DAYS	This parameter is used to specify the number of days by which a contract is treated as Aged Contract. Input parameter value is numeric with no upper limit.
ASC_COL_SER_ENABLED_IND	This parameter is used as the Collection Servicing Enabled Indicator.
CAC_DIRECTORY	This parameter is used to define the Oracle Directory Object Name for CAC file location.
CAC_PROCESSED_DIRECTORY	This parameter is used to define the Oracle Directory Object Name for CAC file location.
CHECK_PRINT_PREVIEW	Using this parameter we can allow preview of application in pdf form before printing. Input parameter value is Boolean (Yes/No).
CMN_AMOUNT_ROUND_FACTOR	This parameter is used to define the rounding factor for applicable fields (in this case calculated amounts). Input parameter value is ROUND AMOUNT TO 2 DECIMALS . Currently system supports rounding factor 2 only.

Table C-1 (Cont.) System Parameters

Parameter	Description
CMN_AMOUNT_ROUND_METHOD	<p>This parameter is used to define the amount round method during system set-up and would be applicable for all calculated amounts (calculated fees, payment etc.) across the application. Input values are ROUND, RAISE and CUTOFF:</p> <p>ROUND: Rounded to nearest number higher or lower</p> <p>RAISE: Rounded to the nearest higher number</p> <p>CUTOFF: Truncate the digits without rounding or raising</p>
CMN_APP_ACC_TITLE_FN_LN	<p>This parameter is used to set the Application or Account title in one of the formats – First/Last Name or Last/First Name. Input parameter value is Boolean (Yes/No). If Yes is chosen, title would be in the format – First/Last Name, else the other option.</p>
CMN_APP_SERVER_HOME	<p>This parameter is used to set the Application Server Home Directory. Input parameter value is user defined.</p>
CMN_CURRENT_MODEL_YEAR	<p>This parameter is used to default the Current Model Year.</p>
CMN_DEBUG_LEVEL	<p>This is the Common Debug Level</p>
CMN_DEBUG_METHOD	<p>This parameter allows to define the location to which generic debug logs (other than Alert/Warning and GRI) are to be written. If set to ADVANCE_QUEUE, system writes the logs in Logs table and if set to UTL_FILE, system generates the alert log file.</p>
CMN_FILE_PROCESS_TO_LOB	<p>This parameter allows to define the location from where the incoming or outgoing files/documents are to be processed. If set to Y, system processes the data to/from LOB and if set to N, system processes the data to/from FILE.</p> <p>The same is used by the batch jobs available in SET-IFP (input file processing) Batch Job Set.</p>
CMN_GL_POST_DT	<p>This parameter is used to specify the General Ledger Posting date. If scheduler is enabled, it automatically updates this to current system date. Else Admin User would need to set this date manually to ensure correct posting dates in GL.</p>
CMN_HTTP_PROXY_PORT	<p>This parameter is enabled to specify the port to be used for outgoing HTTP connections. Input parameter value is user defined.</p>
CMN_HTTP_PROXY_SERVER	<p>This parameter is enabled to specify the proxy server to be used for outgoing HTTP connections. Input parameter value is user defined. There exists an interdependency of this parameter with CMN_HTTP_PROXY_PORT mentioned above.</p>

Table C-1 (Cont.) System Parameters

Parameter	Description
CMN_INT_360_ACCRUAL_DAYS_MTHD	This parameter is used to specify the interest accrual method for 360 days, to be used by the System for all calculations with interest. Currently two methods are supported. Input parameter value is US or EU representing American and European method of interest accrual for 360 days.
CMN_TEST_TOOL_LOGGING	This parameter is used to set testing tool logging parameter
CMN_SCHEMA_ID	This is used to specify the schema identifier for all users.
CMN_SCHEMA_NAME	This is used to specify the Oracle User Name for a specific schema. Input parameter value is user defined.
CMN_SCHEMA_PASSWORD	This captures the password for Oracle, for the specific schema. Input parameter value is user defined. This parameter need not be enabled when in Oracle Network.
CMN_SERVER_HOME	This parameter captures the Server Home Directory. Input parameter value is user defined.
CMN_SERVER_TEMP_DIR	This parameter is used to specify the temporary directory on the server along with the path. Input parameter value is user defined.
CMN_SER_ENVIRONMENT_FILE	This parameter captures the environment file (and its path) for running the Operating System commands from Job Service. Input parameter value is user defined.
CMN_WALLET_PASSWORD	This parameter is used to specify the common wallet password. Input parameter value is user defined.
CMN_WALLET_PATH	This parameter is used to specify the common wallet path for oracle database. Input parameter value is user defined.
CPP_NO_OF_PROMISES	This parameter is used to define the maximum number of promises/chances allowed for a customer who is delinquent and promises to pay. Input parameter value is numeric with no upper limit.
CPP_PROMISE_HELD_DAYS	This parameter is used to define the maximum number of days after the promises made by the customer to pay are broken to initiate further actions. Input parameter value is numeric with no upper limit.
CRD_CHS_BIN	This parameter holds the value of the credit card BIN (Bank Identification Number for Credit Cards), for CHASE interface. Input parameter value is user defined. (P.S: OFSLL supports CHASE interface for credit card payments processing)
CRD_CHS_CUR_CODE	This parameter is used to specify the currency code of the transacting currency for CHASE interface. Input parameter value is user defined.

Table C-1 (Cont.) System Parameters

Parameter	Description
CRD_CHS_DIR_PATH	This parameter is used to specify the directory path for CHASE payment interface for Credit Cards. Input parameter value is user defined.
CRD_CHS_IND_TYPE	This is used to specify the industry type for CHASE payment interface for Credit Cards. Input parameter value is user defined.
CRD_CHS_MERCHANT_ID	This captures the merchant ID number for CHASE payment interface for Credit Cards. Input parameter value is user defined.
CRD_CHS_REMOTE_HOST_NAME	This captures the remote host name for seeking approvals for CHASE payment interface. Input parameter value is user defined.
CRD_CHS_SEC_REMOTE_HOST_NAME	Similar to the previous parameter this captures the secondary remote host name of CHASE interface for seeking approvals for credit card payments. Input parameter value is user defined.
CRD_CHS_TIMEOUT	This parameter is used to define the timeout limit when polling the interface for processing credit card payments. Input parameter value is numeric.
CRD_CHS_USR_ID	This parameter captures the user id for CHASE interface which is required whenever the System needs to access/ seek authorizations/process payments for credit cards etc. Input parameter value is user defined.
CRD_PTB_REMOTE_HOST_NAME	This is the Protobase Remote Host Name
CRD_PTB_REMOTE_HOST_PORT	This is the Protobase Remote Host Port
CRD_PTB_TIMEOUT	This is the Protobase Timeout Value
CRD_SOURCE_TYPE_CD	This is the Source Type Code
DDT_CREATE_DUE_DATE_HISTORY	This parameter must be enabled to create a due date history for any account. Due date history sub tab under Transaction history displays the delinquency history of an account in a tabular format detailing Due date, Due Amount, Last Payment date, Payment Amount, Balance Amount, Days past due and Payment received flag. The input parameter value for this parameter is Boolean (Yes/ No).
DECISION_BUY_RATE_TOLERANCE	This parameter is used to define the variance in buy rate
EDF_DIALER_ACCT_TYPE	This parameter is used to set up the account number reference for the dialer file to pick-up records for Auto dialer interface. Input parameter value is account number.
FLL_BPEL_PROCESS	This parameter is set to use BPEL process in OFSLL. Input parameter value is Boolean (Yes/No).
ICA_INPUT_FILE_FORMAT	This parameter is used to define the input call activity file format
IFD_DIRECTORY	This parameter is used to define the Oracle directory object name for IFD file location
IFD_PROCESSED_DIRECTORY	This parameter is used to define the Oracle directory object name for IFD file location

Table C-1 (Cont.) System Parameters

Parameter	Description
INCOMING_LOB_PURGE_DAYS	This parameter is used to define the incoming process file table purge days
INPUT_DIRECTORY	This parameter is used to define the Oracle directory object name for INPUT file location
ITU_DIRECTORY	This parameter is used to define the Oracle directory object name for ITU file location
ITU_PROCESSED_DIRECTORY	This parameter is used to define the Oracle directory object name for ITU file location
IVR_DIRECTORY	This parameter is used to define the Oracle directory object name for IVR file location
IVR_PROCESSED_DIRECTORY	This parameter is used to define the Oracle directory object name for IVR file location
JSC_TIMEOUT	This parameter is used to set the polling interval for job scheduler. Input parameter value is numeric. To check whether it represents minutes/seconds.
JSV_ARCHIVE_SERVER_CONFIG	This parameter is used to set the configuration file for reports archive server. Input parameter value is user defined.
JSV_ARCHIVE_SERVER_URL	This parameter is used to specify the archive server url. Input parameter value is user defined.
JSV_BI_PASSWORD	This parameter is used to define the BI Publisher Password
JSV_BI_USER	This parameter is used to define the BI Publisher User ID
JSV_TEMPORARY_DIRECTORY	This parameter is used to define Oracle directory object name for Job Service Temp file location
JSV_BI_PASSWORDJSV_REPORTS_RUNTIME	This parameter is to specify the reports runtime program. Input parameter value is user defined.
JSV_REPORTS_RUNTIME_CMDFILE	This parameter is used to specify the reports runtime command file. Input parameter value is user defined.
JSV_REPORTS_SERVER_CONFIG	This parameter is used to specify the configuration file for reports server. Input parameter value is user defined.
JSV_REPORTS_SERVER_URL	This is used to specify the URL for the reports server. Input parameter value is user defined.
JSV_REPORT_ARCHIVE_DIRECTORY	This is used to specify the path and directory of Reports archive, input parameter value being numeric.
JSV_SMTP_SERVER	This parameter specifies the SMTP server used by job service for sending email messages. Input parameter value is user defined.
JSV_TIMEOUT	This is to specify the polling interval for the job service during time out. Input parameter value is numeric. To check whether it represents minutes/seconds.
JSV_USE_BI_PUBLISHER	This parameter defines whether BI publisher should be used to process reports are not. Input parameter value is Boolean (Yes/No).

Table C-1 (Cont.) System Parameters

Parameter	Description
JSV_USE_REPORTS_SERVER	This parameter is used to specify whether reports server from job service should be used or not. Input parameter value is Boolean (Yes/No).
LBX_TXN_GROUPING_CNT	This parameter is used to specify the no. of records per batch for payment transactions and lock box batch records. Input parameter value is numeric.
LCO_COL_LETTER1_GEN_DAYS	This parameter specifies the number of days post which first collection letter should be generated for accounts with dues unpaid. Input parameter value is numeric.
LCO_COL_LETTER2_GEN_DAYS	This parameter specifies the number of days post which second collection letter should be generated for accounts with dues unpaid. Input parameter value is numeric.
LCO_COL_LETTER3_GEN_DAYS	This parameter specifies the number of days post which third collection letter should be generated for accounts with dues unpaid. Input parameter value is numeric.
LIEN_RELEASE_DAYS	This parameter is used to define the Lien Release Days
LOCKBOX_DIRECTORY	This parameter is used to define the Oracle directory object name for Lockbox file location
LOCKBOX_PROCESSED_DIRECTORY	This parameter is used to define the Oracle directory object name for processed Lockbox file location
LOR_ADVERSE_ACTION_GEN_DAYS	This parameter is used to specify the number of days after the third collection letter post which the adverse action letter is to be generated. Input parameter value is numeric.
LOG_LOB_PURGE_DAYS	This parameter is used to log files header table purge days
MAX_AGED_TXN_AUTHORIZE_DAYS	This parameter is used to specify the maximum number of days within which a transaction should be authorized. Input parameter value is numeric and represents the number of days.
MAX_VOID_TXN_AUTHORIZE_DAYS	This parameter is used to set the maximum days to authorize transaction
OCP_CUSTOMER_PMT_SITE_ID	This parameter is used to set the customer payment extract file site id
OCP_INCLUDE_ACH_ACC	This parameter is used to set the customer payment extract including ach accounts
OUTGOING_LOB_PURGE_DAYS	This parameter is used to define the outgoing process file table purge days
OUTPUT_DIRECTORY	This parameter is used to define Oracle directory object name for OUTPUT file location
PAC_ARCHIVE_DAYS	This parameter is used to define number of days for periodic archiving of account. Input parameter value is numeric.
PAC_OARCHIVE_DAYS	This parameter is used to define the number of days for archiving accounts from O tables i.e. old tables. Input parameter value is numeric

Table C-1 (Cont.) System Parameters

Parameter	Description
PAP_ARCHIVE_DAYS	This parameter is used to define the number of days for archiving applications on a periodic basis. Input parameter value is numeric.
PAP_OARCHIVE_DAYS	This parameter is used to define the number of days for archiving applications from O tables. Input parameter value is numeric.
PCU_CHECK_REFUND_DAYS	This parameter is used to specify the maximum number of days within which an overpayment from the customer can be refunded. Input parameter value is numeric.
PDC_PRE_PROCESS_DAYS	This parameter value will define the number of days prior to the due day, regular account PDC process should be initiated. Input parameter value is numeric.
PENDING_PDC_DAYS	This parameter value will define the number of days before the initiation day for pending PDC accounts.
PGL_ARCHIVE_DAYS	This parameter defines the number of days, post which the transactions in GL would be archived. Input parameter value is numeric.
PGL_OARCHIVE_DAYS	This parameter is used to define the number of days, post which the transactions in GL will be moved to the O tables. Input parameter value is numeric.
PJR_PURGE_DAYS	This parameter is used to specify the days post which the job requests are to be purged. Input parameter value is numeric.
POD_PURGE_DAYS	This parameter is used to define the number of days after which the Output data file headers are to be purged. Input parameter value is numeric.
PPA_ARCHIVE_DAYS	This parameter is used to specify number of days after which pools and its transactions archiving is to be done to O tables. Input parameter value is numeric.
PPA_OARCHIVE_DAYS	This parameter is used to specify number of days after which pools and its transactions archiving is to be done to OO tables. Input parameter value is numeric
PPR_ARCHIVE_DAYS	This is used to specify the days for archival of producers details on a regular basis. Input parameter value is numeric.
PPR_OARCHIVE_DAYS	This is used to specify the days after which the producers details from O tables need to be archived. Input parameter value is numeric.
PPX_ARCHIVE_DAYS	This is used to specify the days after which producer transactions are to be archived. Input parameter value is numeric.
PPX_OARCHIVE_DAYS	This is used to specify the days after which the producer transactions are to be moved from O tables. Input parameter value is numeric.
PJR_COPY_PURGED_DATA	This parameter is used to copy data into purge tables.

Table C-1 (Cont.) System Parameters

Parameter	Description
PST_ARCHIVE_DAYS	This parameter specifies the number of days for which the statements are to be archived. Input parameter value is numeric.
PST_OARCHIVE_DAYS	This parameter specifies the number of days for which the statements are to be archived in the O tables. Input parameter value is numeric.
PTT_PURGE_DAYS	This is used to specify the number of days after which the PTT table is to be purged. Input parameter value is numeric.
PTX_ARCHIVE_DAYS	This parameter is used to specify the number of days the transactions are to be archived. Input parameter value is numeric.
PTX_OARCHIVE_DAYS	This parameter is used to specify the number of days after which the archived transactions from O tables are to be moved. Input parameter value is numeric.
PUL_PURGE_DAYS	This parameter is used to specify the number of days post which the User login details are to be purged. Input parameter value is numeric.
PVA_ARCHIVE_DAYS	This parameter stores the number of days for archival of regular vendor assignments. Input parameter value is numeric.
PUP_ARCHIVE_DAYS	This parameter stores the number of days for archival of transaction upload. Input parameter value is numeric.
PUP_OARCHIVE_DAYS	This parameter is used to specify the number of days after which the archived transactions from O tables are to be moved. Input parameter value is numeric.
PVA_OARCHIVE_DAYS	This parameter value specifies the number of days for archival of vendor assignments from O tables to OO tables. Input parameter value is numeric.
PVI_ARCHIVE_DAYS	This parameter is used to specify the number of days for which the regular vendor invoices are to be archived. Input parameter value is numeric.
PVI_OARCHIVE_DAYS	This parameter is used to specify the number of days post which the regular vendor invoices are to be moved from O tables to OO tables. Input parameter value is numeric.
RAC_LOAD_FREQUENCY	This parameter is used to specify Accounts RDH Load Frequency
RAP_LOAD_FREQUENCY	This parameter is used to specify Applications RDH Load Frequency
RAT_LOAD_FREQUENCY	This parameter is used to specify Asset Tracking RDH Load Frequency
RBK_LOAD_FREQUENCY	This parameter is used to specify Bankruptcy Details RDH Load Frequency
RCA_LOAD_FREQUENCY	This parameter is used to specify Call Activities RDH Load Frequency
RCH_LOAD_FREQUENCY	This parameter is used to specify Deficiency Details RDH Load Frequency

Table C-1 (Cont.) System Parameters

Parameter	Description
RCO_LOAD_FREQUENCY	This parameter is used to specify Contracts RDH Load Frequency
RFO_LOAD_FREQUENCY	This parameter is used to specify Repo-Foreclosure RDH Load Frequency
RPR_LOAD_FREQUENCY	This parameter is used to specify Producers Rdh Load Frequency
RST_LOAD_FREQUENCY	This parameter is used to specify Setup Data RDH Load Frequency
RTX_LOAD_FREQUENCY	This parameter is used to specify Txns RDH Load Frequency
SALESAGENT_MAIL_SEND_IND	This parameter is used to specify whether decision fax needs to be sent to sales agent (yes/no)
SCORING_PARAMETER_ALERT	This parameter is used to set the scoring parameter alert
SQL_DIRECTORY	This parameter is used to set the Oracle directory object name for SQL file location
TES_ANA_PRE_PROCESS_CYCLES	This parameter is used to specify the pre-process cycles required for Escrow analysis. Input parameter value is numeric.
TES_DSB_ANALYSIS_PERCENT	This parameter is used to specify the percentage for escrow disbursements. Input parameter value is numeric.
TES_DSB_PRE_PROCESS_DAYS	This is used to specify the number of days for pre-process for escrow disbursements. Input parameter value is numeric.
TPE_AMORTIZE_ACCRUED_INT_ONLY	This parameter is used to specify that system has to amortize accrued interest at month end
TPE_APPLY_LTC_FROM_CURR_DUE_DT	This parameter is used for pyramid law fee method to apply late charge from current due date
TPE_ESC_ANALYSIS_DELQ_AMT	Parameter considers billed but uncollected amount for escrow analysis
TPE_EXCESS_PAYMENT_TO_MEMO	Excess payment on the account will be moved to memo payment.
TPE_EXCLUDE_ESC_LTC	This parameter defines whether escrow should be included or excluded while calculating late charge. Input parameter value is Boolean (Yes/No).
TPE_EXT_CYCLES_BACKDATED	This parameter is used to define the maximum extension cycles allowed for back dating. Input parameter value is numeric with no upper limit
TPE_FUTURE_PAYOFF_DAYS	The value specified in this parameter validates the Valid Up to Date with Payoff quote during monetary transactions posting.
TPE_GL_REFUND_HOLD_DAYS	This parameter is used to define the number of days the non-refunded amount can be held in GL. Input parameter value is numeric.

Table C-1 (Cont.) System Parameters

Parameter	Description
TPE_MAX_CYCLES_BACKDATED	This parameter is used to define the maximum cycles that are allowed for backdating an account in OFSLL. Only when a status change transaction is reversed, account backdate field is set based on this parameter. The input parameter value is numeric.
TPE_MIN_1098_INT_AMT_PAID	This parameter is used to specify the lower limit or minimum interest amount paid for 1098 i.e. Mortgage Interest Statement. In the US, FIs need to report mortgage interest of \$600 or more received from individuals, during the course of their business. Input parameter value is 600, the minimum value above which reporting by FI is required in form 1098 for each mortgage account.
TPE_OLDEST_DUE_DT_NEW_MTHD	This parameter is enabled to specify whether new method for calculation of oldest due date based on given data should be used or not. Input parameter value is Boolean (Yes/No).
TPE_PAID_TO_CLOSE_DAYS	This parameter is used to specify the number of days allowed post which a paid account would be closed. Input parameter value is numeric.
TPE_PAYMENT_TO_MULTI_ACCOUNTS	This parameter is enabled to allow one payment for dues in multiple accounts. Input parameter value is Boolean (Yes/ No).
TPE_PAYOFF_VALID_THRU_DAYS	This parameter is used to specify the number days the pay-off quote is valid by default. i.e. if the parameter is set as 7, the payoff quote is valid for 7 days and customer can pay the quoted amount as final closure amount within those days. Input parameter value is numeric.
TPE_PMT_POST_EOD	This parameter is used to allow payments when the batch process for End of Day is running. Input parameter value is Boolean (Yes/No). If this is set to Y, payments can be allowed during EOD.
TPE_SCHGOFF_DLQ_DAYS	This parameter is used to define the number of delinquent days to treat an account for SCHGOFF (charge – off). Input parameter value is numeric. (To verify)
TPE_SCHGOFF_REVIEW_DAYS	This parameter is used to define the number of days allowed for review of SCHGOFF accounts. Input parameter value is numeric.
TPE_SCRA_DEFAULT_INTEREST_RATE	This parameter is used to define the default interest rate that is to be applied for customers who are in military duty. OFSLL will apply the lower of the prevailing interest rate or SCRA default interest rate specified through this parameter. Input parameter value is numeric (in this case 6, which is interest rate to be applied for SCRA accounts.
TPE_SHOW_BACKDATE_WARNING	This parameter is used to define whether a warning message is to be shown if monetary transaction is backdated.

Table C-1 (Cont.) System Parameters

Parameter	Description
TPE_STM_INC_ALL_TXNS	This parameter is enabled to define whether all transactions should be included in the statements or otherwise. Input parameter value is Boolean (Yes/No).
TPE_STOP_COMP_DELQ_DAYS	This parameter is used to stop computation when delq days > 60
TPE_TXN_POST_DEFAULT_GLDATE	This parameter is used to default GL date in date type parameters during txn posting (y/n)
TPE_VOID_TO_CLOSE_DAYS	This parameter is used to define the number of days allowed for closing Void accounts. Input parameter value is numeric.
UIX_DEFAULT_IMAGE_PATH	This parameter is used to define the default image directory maintained for the purpose of online attachment of document images to an application using documents maintenance section under Account documentation. Input parameter value is user defined.
UIX_INCOMING_FILE_PATH	This parameter is used to specify incoming file path of app server
UIX_LOCAL_COUNTRY_CD	Through this parameter we can set the local country where an FI has multiple branches across different geographies. Input parameter value is user defined.
UIX_LOCK_UNLOCK_AND_COPY	This parameter is used to enable the user interface lock / unlock and copy features. Input parameter value is Boolean (Yes/No).
UIX_MAX_ACC_SEARCH_ROWS	This parameter is used to specify the maximum number of account rows to be returned for search functionality. Input parameter value is numeric.
UIX_MAX_APP_SEARCH_ROWS	This parameter is used to specify the maximum number of application rows to be returned for search functionality. Input parameter value is numeric.
UIX_OUTGOING_FILE_PATH	This parameter is used to specify outgoing file path of app server
UIX_REPORTS_SERVER_CONFIG	This parameter can be used to specify the user interface reports server configuration file. This is not required for OFSLL.
UIX_REPORTS_SERVER_URL	This parameter sets the URL for Reports server. Input parameter value is user defined.
UIX_UTILITIES_SERVLET_URL	This parameter can be used to specify the User Interface utilities servlets URL. This is not required for OFSLL.
UPR_PRO_NBR_SYS_GENERATED	This parameter can be used to specify whether producer number should be system generated or seek input from user. Input parameter value is Boolean (Yes/No). Generally this is set to yes for system generation.
VEV_NADA_TOKEN_URL	This parameter is used to set the token URL for vehicle evaluation interface NADA. Input parameter value is user defined.

Table C-1 (Cont.) System Parameters

Parameter	Description
VEV_NADA_UPDATE_DAY	This parameter is used to specify the day of the month to update the vehicle evaluations every month. Input parameter value is numeric.
VEV_NADA_URL	This parameter is used to set the URL for vehicle evaluation interface NADA. Input parameter value is user defined.
VEV_NADA_USER_ID	This parameter is used to specify the User id for login to the NADA interface. Input parameter value is user defined.
VEV_NADA_USER_PASSWORD	This parameter is used to specify the password for login to the NADA interface. Input parameter value is user defined.
VEV_VALUATION_REGION	This parameter is used to define the default region for vehicle evaluation. Input parameter value is the region name, and is user defined.
VEV_VALUATION_SOURCE_CD	<p>This parameter is used to specify the default vehicle evaluation source code. Input parameter value is user defined. A number of parameters are possible in OFSLL as below:</p> <ol style="list-style-type: none"> 1. Appraisal Company 2. Broker 3. BUC GUIDE 4. DATA QUICK 5. NAMS/SAMS SURVEY – USED 6. REALTOR 7. NADA INTERFACE USED CARS 8. BLACKBOOK INTERFACE USED CARS 9. KELLY INTERFACE 10. NADA – NEW 11. NADA – USED 12. KELLY NEW BLUE BOOK 13. KELLY USED BLUE BOOK 14. INVOICE 15. BLACK BOOK 16. NADA INTERFACE COMMERCIAL TRUCKS 17. COMPANY INVOICE 18. GOLD BOOK 19. GALVS 20. OTHER 21. ALG

Table C-1 (Cont.) System Parameters

Parameter	Description
WFP_DIRECTORY	This parameter is used to specify the Oracle directory object name for WFP file location.
WFP_MAX_CYCLES_BACKDT	This parameter is used to specify the back dated cycles date for WFP.
WFP_PROCESSED_DIRECTORY	This parameter is used to define oracle directory object name for wfp file location.
WFP_REVERSE_TXN_IND	This parameter is enabled to define the WFP reversal indicator. Input parameter value is Boolean (Yes/No).
XAE_DEALUPD_MAX_ALLOWED_DAYS	This parameter is used to define the max allowed days for Deal Update.
XAE_DEALUPD_ALLOWED_IND	This parameter is used to indicate whether deal update is allowed or not.
OUTBOUND_CALL_Q	This parameter is used to generate reports (including emailing statements/letters) using Application Server instead of Database server.
ACA_PRE_PROCESS_DAYS_FIRST	This parameter is used to configure the number of days before the debit day for ACH process in first time/ one-time case.
IPR_PROCESSED_DIRECTORY	This parameter is used to define the Oracle directory object name for processed IPR file location
IPR_DIRECTORY	This parameter is used to define the Oracle directory object name for IPR file location
UIX_PWD_MGMT_EXTERNAL_URL	This parameter is used to set external password management url, if applicable.
UIX_PWD_MGMT_EXTERNAL	This parameter is used to define the parameter if password management is external. (SET Y IF PASSWORD MANAGEMENT IS EXTERNAL (Y/N)).
ICU_PROCESSED_DIRECTORY	This parameter is used to define the Oracle directory object name for processed ICU file location
ICU_DIRECTORY	This parameter is used to define the Oracle directory object name for ICU file location
UIX_BILL_CYCLE_ALLOWED_IND	This parameter is used to indicate whether Billing cycle is allowed at the application level
CMN_EOD_SLEEP_MINS	This parameter is used to set in minutes the EOD sleep time
CMN_CORE_BANK_TXN_CD	This parameter is used to set code for OFSLL and Core Banking integration
ICC_DLQ_AMT_EXCLUDED	This parameter enabling will exclude delinquency amount for CASA account
CMN_CORE_BANK_IND	This parameter is used to set whether OFSLL can integrate with Core Banking.
BKRP_FILE_REC_LIMIT	This parameter is used to set the limit of total number of records allowed to be added in the Input Data File shared from external interface. Note: If the number of records exceeds the set limit, multiple Input Data Files are to be created.

Table C-1 (Cont.) System Parameters

Parameter	Description
UVN_VEN_NBR_SYS_GENERATED	This parameter is used to validate if Vendor Number has to be auto generated (if set to Y) or to be specified manually in the Vendor details screen.
METRO_WITHOUT_COLL_IND	This parameter indicates whether Metro II reporting is handled without OFSLL Collections module being used. If the parameter value is set as Y i.e. collection module is not used, system updates the collateral status directly as part of REPO call activity. However when Collections module is being used, the Collateral status is tracked with the repossession details updated in Repo/Foreclosure screen of Collections module.
METROII_FIRST_DELQ_DT_ADD_DAY	This parameter is used to calculate the first delinquency date that needs to be reported in the Metro II reporting file. By default the parameter is disabled indicating that the initial delinquency date calculated by the system is used for Metro II reporting. The same needs to be enabled to add the parametrized number of days to the system calculated first delinquency date for the Metro II reporting purpose.
DAYS_TO_PULL_CRB_REPORT	This parameter is used to configure the number of days permitted to pull a Bureau report from the same company and for the same customer.
XWS_ACS_RESP_MULTI_RECORD_IND	This parameter is used to indicate if multiple records exist in the response file received for account search. Accordingly, when there are multiple records found and this parameter is enabled and set to No (default), system displays an error message Too Many Records Found. Please Refine Search by Adding One More Parameter . However, when this parameter is set to Yes , system only indicates that there are multiple records/rows in response file.
GRI_DLQ_DAYS_AUTO_STATUS_CHG	This parameter is used to define the delinquency days which inturn is used to automatically update the status of a work order to PENDING ON HOLD status.
TPE_PMT_POSTING_CLS_ACCOUNT	This parameter is used to define the payment posting criteria for Closed - Paid Off/ Charged-off accounts. Accordingly, OFSLL accepts payment posting on closed accounts only when the parameter is set to Y and all the payments received through Payment Entry screen or Payment Upload file are posted to a Suspense account.

Table C-1 (Cont.) System Parameters

Parameter	Description
TPE_BACKDT_PMT_POSTING	<p>This parameter is used to define the payment posting criteria for backdated payments for the following type of account conditions:</p> <ul style="list-style-type: none"> • Paid off • Charged-off • Account under activation • Account under conversion • Non-performing Account • PC2 SI (Pre-computed to Simple Interest) Reschedule <p>Accordingly, OFSLL accepts backdated payment posting only when the parameter is set to Y and all the payments received through Payment Entry screen or Payment Upload file are posted to a Suspense account.</p>
EXP_PA_SOFT_PULL_IND	<p>This parameter when enabled allows Soft Pull Credit Bureau request, specifically for Experian Premier Attribute Consumer Report without impacting the consumer FICO score.</p>
PMT_BATCH_POSTING	<p>This parameter (PAYMENT BATCH POSTING PREFERENCE) is used to define the status of payment transactions which are uploaded in bulk through a batch process.</p>
POOL_ACTIVE_ACCOUNTS_ONLY	<p>This parameter controls the type of accounts that can be added to a Securitization Pool and allows adding only Active status accounts since the same is enabled (value set to Y) by default. To add accounts with other status such as Active, Paid Off, Charged Off, Void, Terminate. and so on, set the value of system parameter to N.</p>
AUTO_GEN_ACC_NBR_CONV	<p>This parameter is used for conversion accounts to decide option of account number generation. If the value of parameter is set to Y the account number is automatically generated in OFSLL during conversion and if the value is N, then external reference number (generated in third party system) itself is appended as the account number.</p>
OUTBOUND_DLR_TRACK_Q	<p>This parameter defines the settings for batch job SET_XPR to either use MDB (Message Driven Bean) flow (if value set to Y) or existing work flow (if value set to N) to dump producer details maintained in the system into Dealer Track.</p> <p>MDB flow generates outbound JMS message though the configured MDB interface and can avoid current database outbound calls and session timeout.</p> <p>In the existing workflow, the database makes synchronous outbound calls to producer data dump web service, to dump the data and acknowledge the database with the status (success or failure).</p>

Table C-1 (Cont.) System Parameters

Parameter	Description
OUTBOUND_ROUTEONE_Q	<p>This parameter defines the settings for batch job SET_XPR to either use MDB (Message Driven Bean) flow (if value set to Y) or existing work flow (if value set to N) to dump producer details maintained in the system into ROUTEONE.</p> <p>MDB flow generates outbound JMS message through the configured MDB interface and can avoid current database outbound calls and session timeout.</p> <p>In the existing workflow, the database makes synchronous outbound calls to producer data dump web service, to dump the data and acknowledge the database with the status (success or failure).</p>
GRI_WEBSERVICE_LOG_IND	<p>This parameter is used to decide on logging GRI (Generic Recovery Interface) communications. If enabled, system logs all the GRI related web service communications between OFSLL and external interfaced system.</p> <p>The recorded logs can be viewed in Dashboard > System Monitor > Database Server Log Files tab by selecting Interfaces view option.</p>
PVE_ARCHIVE_DAYS	<p>This parameter stores the number of days for archival of regular vendors. Input parameter value is numeric.</p>
PVE_OARCHIVE_DAYS	<p>This parameter is used to specify the number of days post which the regular vendors are to be moved from O tables to OO tables. Input parameter value is numeric.</p>
LBX_DR_CR_VALIDATE_AMT_IND	<p>This parameter (VALIDATE LOCKBOX DR/CR BATCH TOTALS) is used to facilitate NACHA file validation. Based on the status of the parameter, system is either allowed to validate the file or process without validation.</p>
PAP_PURGE_DAYS	<p>This parameter allows to define the number of days after which the application data from archival folders are to be deleted permanently. Purging happens based on elapsed number of days i.e. if value is set to 60 days, only those records which are older by 60 days in archival folder are deleted.</p>
PAC_PURGE_DAYS	<p>This parameter allows to define the number of days after which the accounts data from archival folders are to be deleted permanently. Purging happens based on elapsed number of days i.e. if value is set to 60 days, only those records which are older by 60 days in archival folder are deleted.</p>
CMN_SED_FILE_PROCESS_TO_LOB	<p>This parameter allows to define the location from where the incoming or outgoing seed data is to be processed. If set to Y, system processes the data to/from LOB and if set to N, system processes the data to/from FILE.</p>

Table C-1 (Cont.) System Parameters

Parameter	Description
CMN_EDF_FILE_PROCESS_TO_LOB	<p>This parameter allows to define the location from where the incoming or outgoing data from Dialer Interface is to be processed. If set to Y, system processes the data to/from LOB and if set to N, system processes the data to/from FILE.</p> <p>The same is used by the batch jobs EDFADR_BJ_100_01 and EDFIVR_BJ_100_01 which are available in SET-EDF Batch Job Set.</p>
CMN_FAX_FILE_PROCESS_TO_LOB	<p>This parameter allows to define the location from where the incoming or outgoing Fax data is to be processed. If set to Y, system processes the data to/from LOB and if set to N, system processes the data to/from FILE.</p>
CMN_RED_FILE_PROCESS_TO_LOB	<p>This parameter allows to define the location from where the outgoing details of Data Masking Policy (i.e. Redaction policy output file) is to be processed. If set to Y, system processes the data from LOB and if set to N, system processes the data from FILE.</p>
CMN_WFP_FILE_PROCESS_TO_LOB	<p>This parameter allows to define the location from where the incoming or outgoing WFP Unit details are to be processed. If set to Y, system processes the data to/from LOB and if set to N, system processes the data to/from FILE.</p> <p>The same is used by the batch job WUPPRC_BJ_132_01 available in SET-WFP Batch Job Set.</p>
CMN_AUD_FILE_PROCESS_TO_LOB	<p>This parameter allows to define the location from where the outgoing Audit scripts are to be processed. If set to Y, system processes the data from LOB and if set to N, system processes the data from FILE.</p>
CMN_LBT_FILE_PROCESS_TO_LOB	<p>This parameter allows to define the location from where the incoming or outgoing Lockbox files are to be processed. If set to Y, system processes the data to/from LOB and if set to N, system processes the data to/from FILE.</p> <p>The same is used by the batch jobs LBXPRC_BJ_100_01 and LBXSEP_BJ_100_01 available in SET-LBT Batch Job Set.</p>
CMN_ODD_FILE_PROCESS_TO_LOB	<p>This parameter allows to define the location from where the outgoing ODD or Output Data Dump files are to be processed. If set to Y, system processes the data from LOB and if set to N, system processes the data from FILE.</p> <p>The same is used by the batch job ODDPRC_BJ_000_01 available in SET-ODD3 Batch Job Set.</p>

Table C-1 (Cont.) System Parameters

Parameter	Description
CMN_ALERT_DEBUG_METHOD	This parameter allows to define the location to which Alert and Warning logs are to be written. If set to ADVANCE_QUEUE , system writes the logs in Logs table and if set to UTL_FILE , system generates the alert log file.
CMN_GRI_WS_DEBUG_METHOD	This parameter allows to define the location to which GRI (Generic Recovery Interface) web service logs are to be written. If set to ADVANCE_QUEUE , system writes the logs in Logs table and if set to UTL_FILE , system generates the log file.
UIX_CUSTOMER_BASED_PMT_IND	If this parameter is set to Y and is Enabled , system accepts posting direct payment to an account and also accepts customer based payments to all linked accounts. To facilitate customer based payments, Customer/Business # and Payment Hierarchy fields along with Populate Accounts button are enabled in Payment Entry screen to specify required values.
PMT_HIERARCHY_CODE	In this parameter, you can specify a payment hierarchy which is populated by default in Customer Details and Business Details (if applicable) screen after account activation. However, the specified value is selected by default only if there is a matching hierarchy definition enabled record maintained in Setup > Administration > User > Payment Hierarchy screen. Else, Equal Amount value is selected which in-turn adjusts the payment equally to all customer/business linked accounts. Note: System does not consider this parameter value while creating account using existing customer/business details since the default selection is done during the creation of existing customer / business account.
EVI_MAX_RETRY_COUNT	This parameter records and controls the maximum attempts to re-trigger FAILED Webhook requests which cannot exceed more than 5 times. However, this parameter can be modified if the maximum re-trigger attempts is to be less than 5 times.
UIX_CUSTOM_LABEL_ENABLED_IND	This parameter indicates if the field label customizations are allowed i.e. ability to change label and provide access to fields in Label Configuration and Security User Access Definition Details screens. If set to Y , system refers data from database If set to N , system refers data from XLIB file.

Table C-1 (Cont.) System Parameters

Parameter	Description
UIX_MASTER_ACC_BASED_PMT_IND	If this parameter is set to Y and is Enabled , system accepts posting direct payment to a master account and also accepts master account based payments to all linked accounts. To facilitate master account based payments, Master Account # field is enabled in Payment Entry screen.
TPE_PMT_REFUND_CURRENCY_SRC_CD	This parameter indicates the currency in which payment refund has to be processed in the system as either Payment Currency or Account Currency . The same is considered during payment refund operation in Payment Maintenance screen.
AUTO_GEN_ACTIVE_TXN_CONV	This parameter if enabled, auto posts a dummy ACTIVE transaction on all migrated accounts during the schedule batch job run. This in-turn allows to post RESCISSION / VOID transaction specifically for migrated accounts by selecting the dummy transaction from Customer Service > Maintenance screen or Transaction History transactions tab, For more information, refer Voiding an Account section Servicing user guides.
FLL_CMN_JET_JWT_ENABLED_IND (JET JWT TOKEN ENABLE INDICATOR)	This parameter if set to Y , enables the Account Dashboard screen in Servicing LHS menu. This screen is based on Oracle JET framework and facilitates to view Account summary details maintained in the system. For information on screen functionality, refer to Servicing User Manuals and for details on deployment and configuration, refer to Installation Manuals.
FLL_CMN_JET_JWT_TOKEN_URL (JET JWT TOKEN GENERATION URL)	Define the value of the O-JET URL (app-shell application URL) in the format https://<hostname>:<port no>/ofsl-appshell/< token>
FLL_SER_JET_ACC_CREATE_URL (JET SIMPLE ACCOUNT CREATE URL)	Define the value of the O-JET URL (app-shell application URL) in the format https://<hostname>:<port no>/ofsl-appshell?root=accountonboarding
FLL_SER_JET_ACC_DASHBOARD_URL (JET ACCOUNT DASHBOARD URL)	Define the value of the O-JET URL (app-shell application URL) in the format https://<hostname>:<port no>/ofsl-appshell?root=accountdetailsdashboard
FLL_SET_JET_INTELLIGENTSEG_URL (JET INTELLIGENT SEGMENTATION URL)	Define the value of the O-JET URL (app-shell application URL) in the format https://<hostname>:<port no>/ofsl-appshell?root=queuecreation

Table C-1 (Cont.) System Parameters

Parameter	Description
ACCOUNT_PROCESSING_THRESHOLD (ACCOUNT ON-BOARDING ASYNCHRONOUS PROCESSING THRESHOLD)	<p>This parameter allows to restrict the number of accounts that can be created synchronously using Account onboarding WebService.</p> <p>However, creating accounts asynchronously in the system is further processed by the below batch jobs based on valued defined in this parameter.</p> <p>SET-API2 (ASYNCHRONOUS ACCOUNT CREATION)</p> <ul style="list-style-type: none"> ACXVAL_BJ_100_01 (VALIDATE IAPP TABS) ACXAAI_BJ_100_01 (ASYNCHRONOUS ACCOUNT CREATION)
VTX_OUTBOUND_URL (OUTBOUND CALL URL FOR VERTEX)	This parameter defines the URL of the external adapter (Vertex) that is used to integrate with OFSLL.
VTX_VERSION (VERTEX VERSION)	This parameter defines the version of Vertex adapter that is required to be configured by the system.
AUTO_GEN_AGREEMENT_NBR (AUTO GENERATE AGREEMENT NUMBER FOR ACCOUNT ONBOARDING)	<p>This parameter defines the mode by which agreement number is generated to an account. If set to Y, system generates the agreement number. If set to N, system accepts the external agreement number provided in Account on-boarding payload.</p> <p>Note: When system parameter is set to Y, the agreement number is also used as an identifier to validate the contract details and decide on which accounts should get same Agreement number.</p>

C.3 Organization Parameters

Organization parameters control the functions related to User login, password expirations, responsibilities and accessibility limits in the OFSLL system. Individual parameters can be created with different values for uniquely defined organizations, divisions, and responsibility combinations.

There are three more dimensions other than parameter name, description and enabling (similar to system parameters) as indicated below:

1. Organization
2. Division
3. Responsibility

These dimensions help to define the applicability of the responsibility for specific User in an Organization across selected Divisions/departments.

When determining which parameter to use, OFSLL system selects the best match based on a hierarchical sort by the Organization, Division, and Responsibility fields, with values of **ALL** being a lower order match than an exact match.

While the system allows for Organization parameters to be defined at all three hierarchical levels (organization, division, and responsibility), not all will be applicable to each parameter.

Table C-2 Organization Parameters

Parameter	Description
MAX_PASSWORD_HISTORY_CHECK	This is used to set limit for number of times a password has been repeated during password change. This can be set for specific branches of the Organization, Divisions and Users based on responsibilities. Numeric value to be input to specify the limit.
UCS_GROUP_FOLLOWUP_DAYS	This parameter is used to set up the number of days range for Group follow-up field in customer service screen which displays the set of accounts that share same account condition as the selected account and bear the same customer ID. The pre-requisite for this is Group Follow-up indicator should be enabled in queue setup. Input value is numeric.
UCS_REVIEW_QUEUE_ALLOWED	This is used to specify whether review can be done by the specific responsibility (user group) without entering details in call activities/activities. Parameter value to be input is Boolean (Yes/No).
UIX_APP_VIEW_ALL_APPS	The system uses this parameter to determine which users have the ability to view all applications. The system selects the best match based on a hierarchical sort by Organization, Division and Responsibility fields, with values of ALL being a lower order match than an exact match. Input parameter value is Boolean (Yes/No).
UIX_HIDE_RESTRICTED_DATA	This is used to hide sensitive data relating to the Contract / Applicant to a specific group/responsibility etc. Suppose there is a need to hide data relating to SSN, Bank account details etc. to a specific user responsibility who will not need such data, this parameter can be enabled with input value Boolean (Yes/No). If this parameter is set to Y , the details appear in a masked format (for e.g. SSN – XXXXX- 456)
UIX_SMTP_SERVER	This parameter is used to set up the email server for user interface. The input value would be SETME and check the Enable flag.
UIX_VIEW_SECURED_ACCOUNTS	This is used to specify whether an account can be viewed by a specific responsibility (users). Parameter value is Boolean (Yes/No) and when flagged as Yes, such accounts would be viewable only by users defined in the Organization, Division hierarchy with the specified responsibilities. For example, all employee accounts may not be viewable by all users and should be made available only to the HR department with specific responsibility levels. Note: While creating application, selecting appropriate applicant's classification would be essential for this parameter to be effective.

Table C-2 (Cont.) Organization Parameters

Parameter	Description
UIX_VIEW_SECURED_APPLICATION	This is used to specify whether an application can be viewed by a specific responsibility (users). Parameter value is Boolean (Yes/No) and when flagged as Yes , such applications would be viewable only by users defined in the Organization, Division hierarchy with the specified responsibilities. For example, all employee accounts may not be viewable by all users and should be made available only to the HR department with specific responsibility levels. Note: While creating application, selecting appropriate applicant's classification would be essential for this parameter to be effective.
ULG_DAY_END	This is used to specify the upper limit time in day for a user to be able to work in the System. Parameter value is numeric and range is 1-24, else system will throw error.
ULG_DAY_START	This is used to specify the lower limit time in day for a user to be able to work in the System. Parameter value is numeric and range is 0-24, else system will throw error.
ULG_FAILED_LOGIN_TRIALS_MAX	This parameter is used to specify the maximum number of login trials allowed before disabling the User ID due to security reasons. Input parameter value is numeric with upper limit of 999999999999.
ULG_INACTIVITY_DAYS_MAX	This parameter is used to specify the maximum number of days the User ID can be without utilization before disabling the User ID due to security reasons. Within the specified number of days the User Id must be utilized for sign in at least once. Input parameter value is numeric with upper limit of 999999999999.
ULG_PWD_CASE_SENSITIVE_REQ	This is used to allow all passwords to be case sensitive or otherwise. Input parameter value is Boolean (Yes/No). When this parameter is set as NO , password would be stored in Upper case. If this parameter is set to N then the ULG_PWD_LOWER_CHAR_REQ parameter should also be set to N .
ULG_PWD_CHANGE_DAYS_ACTUAL	This is used to set the maximum number of days after which system will force a password change, in cases where the User has not changed the password. Input parameter value is numeric with upper limit of 999999999999.
ULG_PWD_CHANGE_DAYS_PROMPT	This is used to set the maximum number of days after which system will prompt the User for password change, in cases where password has not been changed within the set period. Input parameter value is numeric.
ULG_PWD_LENGTH_MIN	This is used to set the minimum length of password string that is required. If this criterion is not met, system would throw an alert specifying minimum character length required to be input.

Table C-2 (Cont.) Organization Parameters

Parameter	Description
ULG_PWD_LOWER_CHAR_REQ	This is used to allow at least one lower case character in password strings. Input value is Boolean (Yes/No). Setting this as NO would mean passwords would be allowed in uppercase only.
ULG_PWD_NBR_REQ	This parameter allows setting password with at least one numeric character. Input value is Boolean (Yes/No) and setting this as YES would require passwords to have at least one numeric character.
ULG_PWD_SPECIAL_CHAR_REQ	This parameter is used to allow special characters like '\$', '#', '@', in passwords. Input value is Boolean (Yes/No) and setting this as YES would require passwords to have at least one special character.
ULG_PWD_UPPER_CHAR_REQ	This is used to allow at least one upper case character in password strings. Input value is Boolean (Yes/No). Setting this as NO would mean passwords would be allowed in lowercase only.
ULG_WEEK_END	This parameter enables to set the last day of the week when a user can have access to the system. Input parameter value is numeric ranging from 1 to 7. This is useful in business requirements where the Organization does not need a specific set of responsibilities (users) to not access the system on a weekend / week-off day etc.
ULG_WEEK_START	This parameter is used to set the start day of the week when a user is allowed to access the system. Input parameter value is numeric.
CRB_ERROR_VALIDATION_IND	<p>This parameter is used to validate the Credit Bureau report generation request depending on the number of days permitted to pull a Bureau report from the same company and for the same customer and report as either warning/error.</p> <p>When the number of days is less than or equal to the permitted days (as defined in parameter DAYS_TO_PULL_CRB_REPORT), system displays an Error message stating Bureau Report exists for the same Customer from the same Bureau for Account# XYZ along with list of account number(s) and/or application number(s). If not, a Warning message is display and request is accepted for processing.</p> <p>Note: Both CRB_ERROR_VALIDATION_IND and DAYS_TO_PULL_CRB_REPORT are to be enabled for Credit Bureau report processing.</p>
OCP_CUST_PMT_PREF	This parameter MASTER ACCOUNT ROLLUP FOR PMT EXTRACT FILE is used to decide the basis of dues consolidation at master account level based on the parameter values selected. For more information, refer to Outbound Customer Extracts To Payment Agencies Batch section.

C.4 Company Parameters

Company parameters control the processes associated with functions that vary for different companies and branches. These parameters address credit scoring, credit bureau interfaces, fax services, and fax generation.

Individual parameters may be set up with different values for uniquely defined company and branch combinations (i.e. these can be defined to the level of branches in each company or a group of companies in terms of applicability).

Table C-3 Company Parameters

Parameter	Description
AUD_ADV_REASON_MODEL	This parameter is used to set-up default adverse action reasons for scoring models during set-up in the Parameters sub page. Whenever the flag Bureau Score Reasons is unchecked during credit bureau scoring model set-up, then automatically rejected applications scored using this scoring model picks up the Adverse Action Reasons from the Parameters sub page.
AUD_SCORING_METHOD	This parameter is used to set when/where the application scoring method has to be applied within the company. So when the parameter value is chosen as primary applicant only , the system will perform the application scoring for the primary applicant only and according to other applicable parameters specified. Other parameter input values are Minimum Score, Maximum Score, Minimum Tier (Grade), Maximum Tier (Grade).
AUD_SCORING_METHOD_IN_BUREAU	This parameter is used to define what value to be picked up for application scoring from the scores returned from the various bureaus. The input parameter values are Maximum Score and Minimum Score. If Maximum score is setup in company parameters, then for all applications where a bureau report is pulled, the system will pick-up the Maximum score from the different bureaus.
CBU_DATA_SET_SIZE	Parameter to define the metro 2 file data selection criteria, option values are monthly, Daily, weekly, semi monthly.
CBU_FILE_FORMAT	Metro 2 file format definition, user need to select from the parameter value drop down.
CMN_ASE_VALIDATE_MAKE_MODEL	This parameter is set up to specify to the system whether it needs to validate the asset make and model at the time of data entry. In parameter value is Boolean (Yes/No).
CMN_CMB_DEFAULT_PRINTER	This is used to define the default printer for printing. The input parameter value is the printer name. There is no LOV for this field. If no default printer is defined and the parameter enabled, the system would display Undefined .

Table C-3 (Cont.) Company Parameters

Parameter	Description
CMN_WEEKLY_NONBUSINESS_DAYS	This parameter is used to set-up the weekly holidays at the company level. The input parameter value is character string; if no details specified and parameter is enabled, system would display UNDEFINED .
COR_STORAGE_DIRECTORY	This parameter is used to specify the path/location for Oracle directory object template for correspondence documents. Input parameter value is SETME ; if none is specified and parameter enabled, UNDEFINED .
DBR_JOINT_INC_DEBT_WITH_2NDRY	This parameter defines whether system should consider income and debt details of the Spouse and Secondary Applicant along with that Primary Applicant. Input parameter value is Boolean (Yes/No).
DBR_JOINT_INC_DEBT_WITH_SPOUSE	This parameter is used to define whether system should consider the income and debt details of Spouse alone along with that of Primary applicant details. Input parameter value is Boolean (Yes/No).
DDP_CRB_EXPIRATION_DAYS	This parameter is used to define the credit bureau report expiration days. So if this is set as 30, system will use all available credit bureau reports pulled which are not older than 30 days from current day, during de-dupe. Input value is numeric with no upper limit.
DDP_DEDUP_DEBT_WITH_2NDRY	This parameter defines whether the system should dedupe credit bureau liabilities for Spouse and Secondary Applicants, in addition to de-duping Primary applicant's liabilities. Input parameter value is Boolean (Yes/No).
DDP_DEDUP_DEBT_WITH_SPOUSE	This parameter defines whether the system should dedupe credit bureau liabilities for Spouse, in addition to deduping Primary applicant's liabilities. Input parameter value is Boolean (Yes/No).
DOT_STORAGE_DIRECTORY	This parameter is used to define the location/path of the Oracle Directory Object name for Account Document Loading. Input parameter value is SETME .
ECB_EDIT_FAIL_ANY_APL	This parameter is used to set the credit bureau edit to fail in case the bureau report for any of the applicant fails. Input parameter value is Boolean (Yes/No). So if this parameter is set to YES , the edit will fail even if one of the applicant's bureau score fails to qualify.
ECB_USE_APL_CURRENT_SCORE_CRH	This parameter is used to define whether the system should run the credit bureau edits only on the current scored applicant bureau. Input parameter value is Boolean (Yes/No).

Table C-3 (Cont.) Company Parameters

Parameter	Description
LOR_AUTOMATIC_CON_FUND_FAX	This is used to define the decision fax generation when an application is funded. The input parameter value is Boolean (Yes/No), and when this is set as YES , system automatically generates the fax approval in the predefined template whenever an application is approved.
LOG_STORAGE_DIRECTORY	This parameter is used to define the Oracle storage directory. Input parameter value is user (System Administrator) defined.
LOR_AUTOMATIC_APPROVAL_FAX	This is used to define the decision fax generation when an application is approved. The input parameter value is Boolean (Yes/No), and when this is set as YES , system automatically generates the fax approval in the predefined template whenever an application is approved.
LOR_AUTOMATIC_REJECTION_FAX	This is used to define the decision fax generation when an application is rejected. The input parameter value is Boolean (Yes/No), and when this is set as YES , system automatically generates the rejection fax in the pre-defined template whenever an application is declined.
MAX_LEAD_DAY_AGE	This parameter is used to define the maximum no. of days, post which the sales lead would be considered cold. Input parameter value is numeric with no upper limit.
MULTI_OFFER	Through this parameter the multiple offers (sub-tab) in pricing can be enabled or disabled for a Company/Branch. Input parameter value is Boolean (Yes/No). If the flag is set as Y , the underwriter can view multiple offers and select one of them to be applied for the specific application.
MULTI_OFFER_MAX_NUMBER	This parameter is used to specify the maximum number of multiple offers that can be permitted for an application. Input parameter value is numeric with no upper limit. If MULTI_OFFER company parameter is set as N , this parameter can be ignored as there is no use specifying a value.
MULTI_OFFER_MAX_TERM	This company parameter sets the maximum term (as in no. of instalments, whichever billing cycle is selected) for which multiple offers are calculated and displayed during pricing. Input parameter value is numeric.
MULTI_OFFER_MIN_TERM	This company parameter sets the minimum term (as in no. of instalments, whichever billing cycle is selected) for which multiple offers are calculated and displayed during pricing. Input parameter value is numeric.
MULTI_OFFER_PMT_TOLERANCE	For Multi offer variance in payment is defined in this parameter.
MULTI_OFFER_TERM_VAR	For multi offer Term variance will be defined in the parameter.
PRESENT_VALUE_COMPUTE_RATE	This parameter will perform Present Value Computation Rate (Inflation/Discounting Rate).

Table C-3 (Cont.) Company Parameters

Parameter	Description
RATE_CHG_LTR_PRE_PROCESS_DAYS	This parameter is used to set up the number of days prior to rate change effective date to generate rate change letters in order to provide advance intimation to customers. Input parameter value is numeric with no upper limit.
STM_GEN_AFTER_MATURITY_IND	This parameter is used to enable the statement generation for an account after the maturity date but Account remains unpaid. Input parameter value is Boolean (Yes/No). If this is set to Y, statements will get generated for accounts that remain unpaid even after maturity.
UIX_RUN_AAI_ACT	This parameter is used by the system to determine whether to create and activate an account online. Input parameter value is Boolean (Yes/No).
UIX_UCS_CAC_MAX_FOLLOWUP_DAYS	This parameter is used to set up the maximum number of days for follow up when the account is in delinquent state. Input parameter value is numeric with no upper limit.
UIX_UCS_CAC_MAX_PROMISE_DAYS	This parameter is used to set up the maximum number of days allowed for customers who promise to pay when following up for delinquent accounts. Input parameter value is numeric.
AUD_QUEUE_INITIAL_CRB_FAILED	This parameter enabling will Queue the application if any bureau failed.
UIX_UCS_CUA_MAX_FOLLOWUP_DAYS	This parameter will allow the user to maintain the Collections maximum follow-up days that are allowed in the system.
XSL_TAX_INTERFACE	This parameter is used to specify the sales tax interface in OFSLL. Input parameter value is user defined. In this case it is held as Manual .
CMN_SYSTEM_UNDER_MAINTENANCE	This parameter specifies whether the system is under maintenance or not. Input parameter value is Boolean (Yes/No).
CMN_GL_POST_DT	This parameter is used to define the GL Post Date of Company in MM/DD/YYYY format. The same is also updated by Scheduler if ENABLED.
PTX_TXN_LAST_PURGE_DT	This parameter stores the date when transactions were purged last in the OFSLL system. Input parameter value is date.
PUP_TUP_LAST_PURGE_DT	This parameter stores the date when transactions upload were purged last in the OFSLL system. Input parameter value is date.
JSC_START_OF_BUSINESS_TIME	This parameter is used to set the start of business time. Input parameter value is time in 24 hour format.

Table C-3 (Cont.) Company Parameters

Parameter	Description
CMN_PROMISE_FUTURE_MTHD	<p>This parameter helps to define the future promise handling method in the system.</p> <p>When multiple Promise to Pay records are defined on an account and if any one of the promise is not satisfied i.e. if there is no credit / Payment transaction of the corresponding amount on the promise date, then system uses any of the following method defined in this parameter to update the future promises.</p> <ul style="list-style-type: none"> • No Action on future promises (default) • Mark current and future promises as broken • Mark current as broken but future promise as cancelled

C.5 Other Parameters

The following additional set of parameters are also available to control system specific data and other administration process.

Table C-4 Other Parameters

Parameter	Description
CRB_MAX_BUREAU_PULL	This parameter is used to determine the number of credit reports automatically per applicant. Input parameter value is numeric.
CRB_ALL_APL_BUREAU_PULL	This parameter is used to set up whether credit bureau reports should be pulled for the primary applicant only or to all other applicants also (for joint applications), regardless of their relationship with the primary applicant. Input parameter value is Boolean (Y/N).
CBU_FILE_FREQUENCY	This parameter is used to set the Metro II File Frequency and determine whether output file is to be generated daily or monthly. If this is monthly, then output file is written with daily data but generated monthly.
JOINT_DEDUP_SPOUSE_LIABILITIES	This parameter is used to determine duplicate liabilities in the Spouse's liabilities in de-duping logic. Input parameter value is Boolean (Yes/No).
JOINT_DEDUP_ALLAPL_LIABILITIES	This parameter is used to determine duplicate liabilities of all applicants' liabilities in de-duping logic, irrespective of whether they are related to each other. Input parameter value is Boolean (Yes/No).
ASC_COL_SER_ENABLED_IND	This parameter is used for enabling the Collection Servicing Indicator. Input parameter value is Boolean (Y/N).
CMN_TEST_TOOL_LOGGING	This parameter is used to set the testing tool logging to enable or disable testing tool log in. Input parameter value is Boolean (Yes/No).

Table C-4 (Cont.) Other Parameters

Parameter	Description
ICA_INPUT_FILE_FORMAT	This parameter is used to specify the Input format for call activity file. Two Parameter values are possible – US format and OFSLL format.
JSV_BI_USER	This parameter is used to define the BI publisher User ID. Input parameter value is user defined (Admin user).
JSV_BI_PASSWORD	This parameter is used to define the BI publisher User password. Input parameter value is user defined (Admin user).
PJR_COPY_PURGED_DATA	This parameter is used to specify whether data should be copied into the purge tables or not. Input parameter value is Boolean (Yes/No).
PUP_ARCHIVE_DAYS	This parameter is used to specify the number of days after which the transactions upload details are to be archived. Input parameter value is numeric.
PUP_OARCHIVE_DAYS	This parameter is used to specify the number of days after which the transactions upload details are to be moved from O tables. Input parameter value is numeric.
TPE_APPLY_LTC_FROM_CURR_DUE_DT	This parameter is used to specify whether late charge should be applied from current due date for Pyramid Law fee method. Input parameter value is Boolean (Yes/No).
TPE_EXCESS_PAYMENT_TO_MEMO	This parameter will make excess payment to the memo payment by marking this Parameter as YES.
TPE_STOP_COMP_DELQ_DAYS	This parameter is enabled to stop computation if the account is delinquent for more than 60 days.

D

Appendix : Configuration at Company Level

This section consists of the following topics:

- [Introduction](#)
- [Existing Configuration](#)
- [Configuration at Company Level](#)
- [Setup Company Definition](#)
- [Setup Multiple Companies in Same/Different Time Zone](#)
- [Impact on Defining Configuration at Company Level](#)

D.1 Introduction

OFSLL supports defining multiple Portfolio Companies in an Organization and facilitates to configure these Portfolio Companies to operate in different time zones. The nightly batch jobs for processing can also be configured to run as per the operating hours of the Portfolio Companies.

Using this, system can be configured in Setup to either process at Organization level or at Company level. To process at Organization level, no specific change is required since it is the default setup.

The below details in this section is intended to give an overview of the changes required to setup the system to process at Company level.

D.2 Existing Configuration

In the default setup, there is no definition of GL date at company level and this implies that organization can define the independent companies to which accounts belongs. But the EOD scheduling and job run happens at organization level and 'not' at each company level. Also the GL date is defined at **System Parameters** Level.

Figure D-1 Existing Configuration

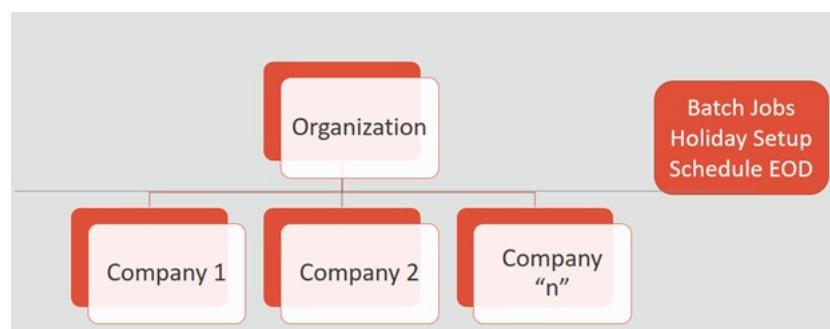

D.3 Configuration at Company Level

In the configuration at Company level (not Branch level), the following options are supported:

- To configure only one EOD schedule for one or all companies - Configure batch jobs at ALL level with or without having multiple company definitions. If OFSLL is upgraded from earlier to current release version, this helps to continue with existing ALL company level scheduling of batch job run.
- To configure EOD for each company independently - Define GL date at each Company level to schedule and run batch jobs at each company level. The scheduler changes the GL date of specific company, after successful completion of batch job run.

However in this setup, note that:

- It is advised to **Enable** flag at ALL GL date level, but disable batch jobs at ALL level so that scheduler does the rollover of date but does not pick-up batch jobs for EOD run.
- After EOD run, system rollovers the GL date or ALL company entry, after completion of run of other specific company GL date rollover.
- Ensure the Company parameter **System Under Maintenance** is also set to **Y** for corresponding company during EOD run of same company.
- Company Start of Business Time can be configured at company level. If the parameter value is set to **0500**, it implies that scheduler rollovers the GL date based on this time.
- System refers the **Company Time Zone** (new field at company definition page) to identify the time zone in company parameter.

Figure D-2 Configuration at Company Level

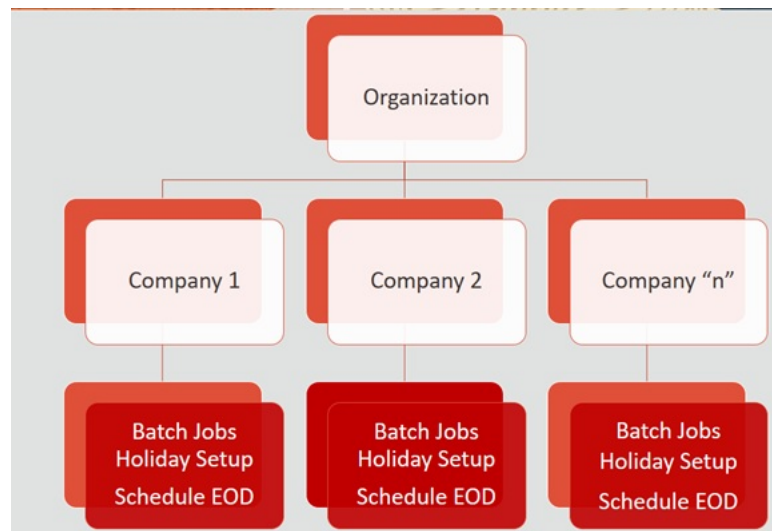

D.4 Setup Company Definition

In this setup, define the company and company parameters.

1. Define Company and date format

- Define the company in **Companies Definition** screen and ensure to maintain **Company Time Zone**.
- Define company code with **Alphanumeric** characters only.
- Ensure to define the **Display Format** organization Definition **Division Definition** Display Formats.

Note

Fixed simple date format definition is one time setup for each company and Admin user is not expected to change it again in life time. Currently it is allowed to select only MM/DD/YYYY format.

2. Define the following company parameters:

The default shipped seed data of Company level GL date is set to All.

- GL POST DATE - COMPANY IN MM/DD/YYYY FORMAT (UPDATED BY SCHEDULER IF ENABLED)
- CMN_SYSTEM_UNDER_MAINTENANCE - SYSTEM UNDER MAINTENANCE
- JSC_START_OF_BUSINESS_TIME (COMPANY START OF BUSINESS TIME (24HR FORMAT))
- PTX_TXN_LAST_PURGE_DT - LAST PURGE DATE OF TXNS
- PUP_TUP_LAST_PURGE_DT - LAST PURGE DATE OF TXNS UPLOAD

Example: The following is an illustration on how 3 companies are defined with 3 different time Zones in USA, UK and Australia.

Figure D-3 Setup Company Definition

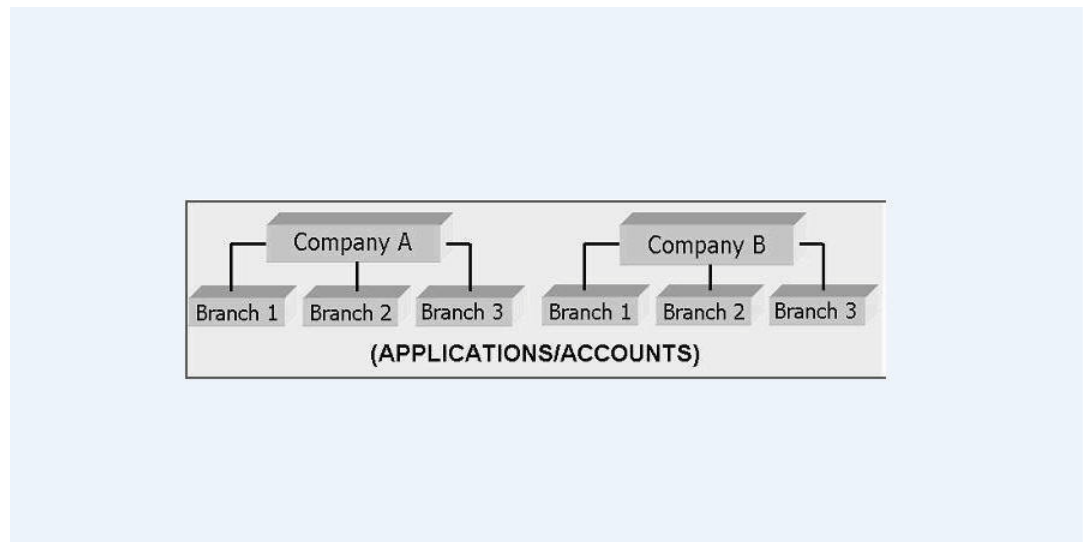

Table D-1 Company Parameters

Parameter	USA	UK	AUS
GL Post Date	31 Dec 2019	02 Jan 2020	02 Jan 2020

Table D-1 (Cont.) Company Parameters

Parameter	USA	UK	AUS
CMN_SYSTEM_UNDER_Y _MAINTENANCE		N	N
JSC_START_OF_BUSIN ESS_TIME	0500	0500	0500
PTX_TXN_LAST_PURG E_DT	01/01/2019	01/01/2019	01/01/2019
PUP_TUP_LAST_PURG E_DT	01/01/2019	01/01/2019	01/01/2019

This section consists of the following topics:

- [Holiday Setup and Processing](#)
- [Batch Jobs Processing](#)

D.4.1 Holiday Setup and Processing

The holiday defined in setup is processed as indicated below:

- Scheduler picks up the jobs for EOD run based on **Next Date and time**' set at each batch job level.
- After successful completion of job run for the individual company, system rollovers the date for respective company.
- Once the EOD run and date rollover is completed for individual company, system verifies the **Enabled** indicator for **All** company. If none of batch jobs are enabled - rollovers the ALL GL date.
- If **01 Jan 2020** is recorded as holiday in setup, scheduler will/will not execute the batch jobs based on the Batch job holiday maintenance and subsequently rollovers the next date to 02 Jan 2020, at proper start of business time for the company.

D.4.2 Batch Jobs Processing

The default shipped seed data of Batch Jobs is set to All. Define the company and copy the batch jobs. Note that the **Copy** option copies all the batch jobs at one go.

D.5 Setup Multiple Companies in Same/Different Time Zone

- Define company level time zone using the field **Company Time Zone** at Companies Definition screen.
- This parameter is used to consider the Company level and Start of Business Time. The same can be configured to the same time zone or different time zone for scheduler to process EOD / BOD.
- Company wise file upload facility is supported as follows:
As part of creating company, following are automated:
 - Directory objects in db is created
 - System parameter is created for directories

- External table is created for selected uploads - collateral and txn upload automatically
- Physical directories are not created
- Directory permissions is to be defined manual
- If Company specific file upload jobs are used, the file upload process happens from company specific folders.

This section consists of the following topics:

- [Setup for New Company Added Subsequently](#)

D.5.1 Setup for New Company Added Subsequently

For New Company Added Subsequently (not on Day zero), follow the same steps to be followed on Day zero setup. Raise SR to execute script of directory creation of new company for file upload.

D.6 Impact on Defining Configuration at Company Level

System displays the following details at each configured Company level.

- [Company Level Configuration Settings](#)
- [Scheduler](#)
- [Debug Logs](#)
- [Setup Screens](#)
- [File Uploads](#)
- [Transactions](#)
- [Web Services](#)
- [Letters, Correspondence](#)
- [Reports](#)
- [Credit Bureau & Metro II](#)
- [GL](#)
- [ODD1, ODD2, ODD3](#)
- [Migration](#)
- [Conversion](#)
- [Archive](#)
- [Purge](#)
- [Standard Payees](#)
- [Data Masking](#)
- [WFP Module](#)
- [Batch Jobs and File uploads](#)
- [Assumptions](#)

D.6.1 Company Level Configuration Settings

Company level LOV selection is available at following screens to configure:

- System Monitor > Batch Jobs
- System Monitor > Jobs > Batch
- System Monitor > Jobs > Background
- System Monitor > Jobs > Credit Request
- System Monitor > JMS Queues > Messages
- System Monitor > Events
- Data Files > Input folder

D.6.2 Scheduler

Once the batch jobs are completed for that specific company, scheduler picks-up the company specific scheduled batch jobs and updates the GL Post Date of that specific company.

Note

- No two companies should be configured to run jobs by scheduler at the same time.
- Ensure to setup the Parent and child batch jobs with marginal difference in time setup to get picked-up by the scheduler.

D.6.3 Debug Logs

- Batch level Debug logs are maintained at system parameter level and allowed to enable / disable debug batch job logging at system parameter level only.
- System allows to enable batch job level debug jobs by enabling in User Defined Table.
- The debug log file generated is appended with **Company Name**.
- The date format in debug logs is MM/DD/YYYY - standard format only, irrespective of logs generated for any company.

D.6.4 Setup Screens

All setup screens refers to system date for validation. Example: Start and End Date.

D.6.5 File Uploads

If only ALL Company Definition is used, the file upload process continues to use the existing folder and infrastructure.

- As part of creating company, following are automated:
 - Directory objects in db is created
 - System parameter is created for directories

- External table is created for selected uploads - collateral and txn upload automatically
- Physical directories are not created
- Directory permissions is to be defined manual
- If Company specific file upload jobs are used, the file upload process happens from company specific folders.

This section consists of the following topics:

- [Input File](#)
- [Output File](#)

D.6.5.1 Input File

The Input File is processed based on the following conditions:

- Changes are accepted in same file structure and input file has to be placed under input/directory/company specific folder.
- In case certain file does not have company definition like **Asset Upload**, the same can be placed in any company folder to process and upload records.
- Some input files are not programmed to refer Data Files > Input file definitions and hence any date in the file will follow MM/DD/YYYY format. For example, Call activity posting, promise date are to be given in the same format.
- Some input files are programmed to refer Data Files > Input file definitions and hence system expects the date in the file as defined as date format in definition.

D.6.5.2 Output File

Output file name is appended with **Company Name** and is generated in one folder.

Note

A script **crt_company_directories.sh** is provided with installer in the path `core_db\ofslldb.zip\dba_utils\` to create directories and to create folders for each defined Company. The same is to be run during installation. Also, the CLOB indicator is retained at system parameter level.

D.6.6 Transactions

- Monetary transaction refers to the company specific GL date.
- Non-Monetary transactions refers to system date.
- Transactions data in the account continues to show the dates with reference to **Fixed simple date format** maintained at company level.

D.6.7 Web Services

- GL date of service refers to company level GL date.
- **Company** has to be passed for certain web services to take reference of corresponding company GL date.

D.6.8 Letters, Correspondence

- Letters are generated based on company level batch job run.
- Date format in letter is not controlled by company level display format and refers to the letter template.

D.6.9 Reports

- Changes are done to report template and reports are generated with **Company Name** appended to file and generated data for specific company, where the job is run.
- Date format in report is not controlled by company level display format and refers to the report template.

D.6.10 Credit Bureau & Metro II

- Bureau pull does not have any impact to handle because user has to select the specific company and then bureau triggers the pull from UI.
- Metro II - No impact. System generates file for all companies; but based on product level flag and with configured setup.

D.6.11 GL

Current GL Setup (Attributes, Translations and Transaction Links and so on) is at Company level and hence there is no impact.

D.6.12 ODD1, ODD2, ODD3

If job is run at company level,

- ODD1 (Producer ACH, Adverse Action letters, Adverse Action Condition Letter file) job generates the data at company level.
- ODD2 (Account ACH, Vendor ACH, Statement, Letter File and so on) job generates the data at company level.
- ODD3 job generates the data at company level.

D.6.13 Migration

For all screens where company has been added, the default value ALL is provided and user is expected to enable this in seed data screen.

D.6.14 Conversion

No specific impact since API tables have definition of company. User can upload the conversion files based on company.

D.6.15 Archive

Parameter to specify the archive days are defined at system level but user can run the Archive batch jobs at each company level and the same archives data for that specific company.

D.6.16 Purge

Parameter to specify the purge days and following parameters are moved to company level.

- PTX_TXN_LAST_PURGE_DT - LAST PURGE DATE OF TXNS
- PUP_TUP_LAST_PURGE_DT - LAST PURGE DATE OF TXNS UPLOAD

D.6.17 Standard Payees

- User would be able to define payee bank account for each company / branch combination.
- AP Requisition batch job generates the requisition considering the account number defined at company level.

D.6.18 Data Masking

Not handled and hence data masking can be configured at organization level only.

D.6.19 WFP Module

Not handled.

D.6.20 Batch Jobs and File uploads

For list of batch jobs and File uploads handled to run at company level, refer to product release notes.

D.6.21 Assumptions

System considers the criteria defined for company in Queues > Criteria Based Condition screen and ignores the branch level differentiation across application. Hence, even if user defines multiple records (as indicated below), system considers the combination as same and executes records are company level.

Company = AUS and Branch = ALL

Company = AUS and Branch = Sydney

Figure D-4 Criteria Based Condition

ORACLE
Financial Services Lending and Leasing

NextGenUI Welcome, ABSHEKAR Sign Out [PROD]

Queues x Close

Origination **Criteria Based Condition** Customer Service Call Action Results Activity Tracking User Groups

Criteria Definition + Add Edit View Audit

View Format Freeze Detach Wrap Check Criteria New Criteria Create Copy

Criteria Name	Criteria Desc	Start Dt	End Dt	Seq	Company	Branch
TEST-ABHI	TEST-PAVAN	03/21/2000	12/31/4000	0	SA03	ALL
TESTABHI232	TEST-PAVAN	03/21/2000	12/31/4000	0	SA03	ALL
TESTABHI23	TEST-PAVAN	03/21/2000	12/31/4000	0	SA03	ALL
TEST-PAVAN	TEST-PAVAN	03/21/2000	12/31/4000	0	SA03	ALL
TEST-01	TEST-PAVAN	03/21/2000	12/31/4000	0	SA03	ALL
TEST26	DEMO	03/21/2000	12/31/4000	1	ALL	ALL
DEMO	DEMO	03/21/2000	12/31/4000	1	ALL	ALL
NAVEEN1	DEMO	03/21/2000	12/31/4000	2	ALL	ALL

Criteria Details Conditions

Criteria + Add Edit View Audit

View Format Freeze Detach Wrap

Seq (Parameter	Comparison Operator	Criteria Value)	Logical Operator	Enabled
0	DELINQUENCY DAYS	GREATER THAN	40		AND	Y
1	PRODUCT CODE	LIKE	NAVEEN VEHICLE			Y