

Oracle® Retail Integration Cloud Service

Integration Overview Guide



Release 23.1.201.0

F80864-02

May 2023

The Oracle logo, consisting of a solid red square with the word "ORACLE" in white, uppercase, sans-serif font centered within it.

ORACLE®

Copyright © 2023, Oracle and/or its affiliates.

Primary Author:

This software and related documentation are provided under a license agreement containing restrictions on use and disclosure and are protected by intellectual property laws. Except as expressly permitted in your license agreement or allowed by law, you may not use, copy, reproduce, translate, broadcast, modify, license, transmit, distribute, exhibit, perform, publish, or display any part, in any form, or by any means. Reverse engineering, disassembly, or decompilation of this software, unless required by law for interoperability, is prohibited.

The information contained herein is subject to change without notice and is not warranted to be error-free. If you find any errors, please report them to us in writing.

If this is software, software documentation, data (as defined in the Federal Acquisition Regulation), or related documentation that is delivered to the U.S. Government or anyone licensing it on behalf of the U.S. Government, then the following notice is applicable:

U.S. GOVERNMENT END USERS: Oracle programs (including any operating system, integrated software, any programs embedded, installed, or activated on delivered hardware, and modifications of such programs) and Oracle computer documentation or other Oracle data delivered to or accessed by U.S. Government end users are "commercial computer software," "commercial computer software documentation," or "limited rights data" pursuant to the applicable Federal Acquisition Regulation and agency-specific supplemental regulations. As such, the use, reproduction, duplication, release, display, disclosure, modification, preparation of derivative works, and/or adaptation of i) Oracle programs (including any operating system, integrated software, any programs embedded, installed, or activated on delivered hardware, and modifications of such programs), ii) Oracle computer documentation and/or iii) other Oracle data, is subject to the rights and limitations specified in the license contained in the applicable contract. The terms governing the U.S. Government's use of Oracle cloud services are defined by the applicable contract for such services. No other rights are granted to the U.S. Government.

This software or hardware is developed for general use in a variety of information management applications. It is not developed or intended for use in any inherently dangerous applications, including applications that may create a risk of personal injury. If you use this software or hardware in dangerous applications, then you shall be responsible to take all appropriate fail-safe, backup, redundancy, and other measures to ensure its safe use. Oracle Corporation and its affiliates disclaim any liability for any damages caused by use of this software or hardware in dangerous applications.

Oracle®, Java, and MySQL are registered trademarks of Oracle and/or its affiliates. Other names may be trademarks of their respective owners.

Intel and Intel Inside are trademarks or registered trademarks of Intel Corporation. All SPARC trademarks are used under license and are trademarks or registered trademarks of SPARC International, Inc. AMD, Epyc, and the AMD logo are trademarks or registered trademarks of Advanced Micro Devices. UNIX is a registered trademark of The Open Group.

This software or hardware and documentation may provide access to or information about content, products, and services from third parties. Oracle Corporation and its affiliates are not responsible for and expressly disclaim all warranties of any kind with respect to third-party content, products, and services unless otherwise set forth in an applicable agreement between you and Oracle. Oracle Corporation and its affiliates will not be responsible for any loss, costs, or damages incurred due to your access to or use of third-party content, products, or services, except as set forth in an applicable agreement between you and Oracle.

Contents

Send Us Your Comments

Preface

Audience	viii
Customer Support	viii
Improved Process for Oracle Retail Documentation Corrections	viii
Oracle Retail Documentation on the Oracle Technology Network	ix
Conventions	ix

1 Introduction and Executive Summary

Oracle Retail Integration Cloud Service Strategic Goals	1-2
Enterprise Integration Frameworks and Products	1-2
Third Party and Legacy Integration	1-3

2 Introduction To Oracle Retail Integration Cloud Service (RICS)

The Retail Integration Suite of Products	2-1
Retail Integration Cloud Service (RICS)	2-1
Key Benefits	2-2
Retail Integration Cloud Services Architecture	2-3

3 Retail Integration Cloud Service Components

Retail Integration Bus (RIB)	3-1
RIB Responsibilities with Retail Applications and Third Party Integrations	3-1
RIB Third Party and Legacy Integration	3-2
Oracle Retail Bulk Data Infrastructure (BDI)	3-3
BDI Functional Architecture	3-3
BDI Responsibilities with Retail Applications	3-3
Third Party Integrations	3-4
Retail Financial Integration (RFI)	3-5

Retail Financial Integration (RFI) Products	3-5
Key Benefits of RFI	3-5
RFI Processes	3-6
RFI for Oracle Cloud Financials	3-7
Universal Service Mapper (USM)	3-7
USM Architecture	3-9
Event Listener	3-9
Service Mapper Orchestration	3-9
Service Provider and External Services	3-10
Use Case: Oracle Warehouse Management CS (Logfire) Integration	3-10
RICS Integration Flows	3-11

4 RICS Operations Support, Management, and Monitoring

Customer Access to RICS Operation	4-1
Retail Integration Console (RIC) Overview	4-1
JMS Console	4-2
JMS Admin – Live Monitoring	4-4
JMS Browse	4-4
JMS Manage	4-5
RIB Hospital Administrator (RIHA)	4-5
RIBForXXX Administrator User Interface	4-6

5 Resources

List of Figures

1-1	Integration Styles and Integration Frameworks with Governance	1-2
2-1	Retail Integration Cloud Services Hybrid Integration	2-2
2-2	RICS Architecture	2-3
3-1	RIB Integration Responsibilities	3-2
3-2	BDI Functional Architecture	3-3
3-3	BDI enterprise Infrastructure Topology	3-4
3-4	BDI Job Execution Perspective	3-5
3-5	RFI for Oracle Cloud Financials	3-7
3-6	USM Process Flow	3-8
3-7	USM Architecture	3-9
3-8	WMS-RICS Mappings	3-10
3-9	Retail to LogFire Integration Overview	3-11
4-1	Customer Access to RICS Operation	4-1
4-2	Retail Integration Console	4-2
4-3	JMS Console Workflow	4-3
4-4	JMS Console	4-4
4-5	RIB Hospital Administrator	4-5
4-6	RIBForXXX Administrator User Interface	4-6

List of Tables

2-1

2-2

Send Us Your Comments

Oracle Retail Integration Cloud Service Overview Guide

Oracle welcomes customers' comments and suggestions on the quality and usefulness of this document.

Your feedback is important, and helps us to best meet your needs as a user of our products. For example:

- Are the implementation steps correct and complete?
- Did you understand the context of the procedures?
- Did you find any errors in the information?
- Does the structure of the information help you with your tasks?
- Do you need different information or graphics? If so, where, and in what format?
- Are the examples correct? Do you need more examples?

If you find any errors or have any other suggestions for improvement, then please tell us your name, the name of the company who has licensed our products, the title and part number of the documentation and the chapter, section, and page number (if available).



Note:

Before sending us your comments, you might like to check that you have the latest version of the document and if any concerns are already addressed. To do this, access the Online Documentation available on the Oracle Technology Network Web site. It contains the most current Documentation Library plus all documents revised or released recently.

Send your comments to us using the electronic mail address: retail-doc_us@oracle.com

Please give your name, address, electronic mail address, and telephone number (optional).

If you need assistance with Oracle software, then please contact your support representative or Oracle Support Services.

If you require training or instruction in using Oracle software, then please contact your Oracle local office and inquire about our Oracle University offerings. A list of Oracle offices is available on our Web site at <http://www.oracle.com>.

Preface

This guide provides an overview of the Oracle Retail Enterprise integration with Oracle Retail Integration Cloud Service.

Audience

This guide is intended for administrators.

This guide describes the administration tasks for Oracle Retail Integration Cloud Services.

Customer Support

To contact Oracle Customer Support, access My Oracle Support at the following URL:

<https://support.oracle.com>

When contacting Customer Support, please provide the following:

- Product version and program/module name
- Functional and technical description of the problem (include business impact)
- Detailed step-by-step instructions to re-create
- Exact error message received
- Screen shots of each step you take

Improved Process for Oracle Retail Documentation Corrections

To more quickly address critical corrections to Oracle Retail documentation content, Oracle Retail documentation may be republished whenever a critical correction is needed. For critical corrections, the republication of an Oracle Retail document may at times not be attached to a numbered software release; instead, the Oracle Retail document will simply be replaced on the Oracle Technology Network Web site, or, in the case of Data Models, to the applicable My Oracle Support Documentation container where they reside.

Oracle Retail documentation is available on the Oracle Technology Network at the following URL:

<http://www.oracle.com/technetwork/documentation/oracle-retail-100266.html>

An updated version of the applicable Oracle Retail document is indicated by Oracle part number, as well as print date (month and year). An updated version uses the

same part number, with a higher-numbered suffix. For example, part number E123456-02 is an updated version of a document with part number E123456-01.

If a more recent version of a document is available, that version supersedes all previous versions.

Oracle Retail Documentation on the Oracle Technology Network

Oracle Retail product documentation is available on the following web site:

<http://www.oracle.com/technetwork/documentation/oracle-retail-100266.html>

(Data Model documents are not available through Oracle Technology Network. You can obtain these documents through My Oracle Support.)

Conventions

The following text conventions are used in this document:

Convention	Meaning
boldface	Boldface type indicates graphical user interface elements associated with an action, or terms defined in text or the glossary.
<i>italic</i>	Italic type indicates book titles, emphasis, or placeholder variables for which you supply particular values.
monospace	Monospace type indicates commands within a paragraph, URLs, code in examples, text that appears on the screen, or text that you enter.

1

Introduction and Executive Summary

Enterprise application integration is the process of linking applications within a single organization together in order to simplify and automate business processes to the greatest extent possible, while at the same time avoiding having to make sweeping changes to the existing applications or data structures.

There is no one integration approach that addresses all criteria equally well. There are multiple approaches for integrating applications that have evolved over time. Oracle Retail has focused on three main integration styles.

- Asynchronous
- Request/Response
- Bulk Data

Oracle Retail Enterprise Integration products provide the architecture and frameworks so the applications can choose the best style for a particular integration opportunity. Each style has its advantages and disadvantages. Applications or solutions may integrate using multiple styles so that each point of integration takes advantage of the style that suits it best.

- Asynchronous integration style (RIB)
 - Provides JMS based messaging.
 - Provides subscription style of integration.
 - Uses message queuing technology to integrate application asynchronously using either a pub-sub model or send-receive model.
 - Provides guaranteed delivery quality of service so even though messages are sent asynchronously there is assurance that messages will not get lost in transit.
- Web Service integration style (RSB)
 - Uses Web Services to integrate applications.
 - Use synchronous request-response calls using SOAP technology and can be used for real time transfer of information between remote applications.
- Bulk Integration style (BDI)
 - Uses batch jobs to move high volume of data from source to destination database.
 - BDI leverages the Oracle WebLogic Server provides robust infrastructure for scheduling and running batch jobs to move data.

This document is written to provide the assumptions and guiding principles for Enterprise Integration using the Oracle Retail Integration Cloud Service products provided by the SaaS Suite of Integration Cloud Services (RICS) and the customer applications and service that they serve.

With each style Oracle Retail has defined architectural patterns, best practices and built infrastructure products and supporting tools for the full life-cycle management of standardized, contract driven integrations. Because all integrations are contract driven, enterprise level governance is in-place to ensure consistent contracts written to published standards are followed.

Figure 1-1 Integration Styles and Integration Frameworks with Governance

MESSAGE EXCHANGE	WEB SERVICES	BULK TRANSFER
<ul style="list-style-type: none"> • JMS Publish-Subscribe • Guaranteed Delivery • Failed Message Recovery • Fire-and-Forget • XSD Schema 	<ul style="list-style-type: none"> • Request-Response • Remote Invocation • XSLT, WSDL • Security • Services Repository 	<ul style="list-style-type: none"> • Synchronize systems with large data batches • Scheduled or triggered • Extract, Transform, Load • Hybrid Cloud data move
RIB (WLS, AQ JMS)	RSB (WLS, OSB)	BDI (WLS)
Canonical Business Objects (XSD, OO, SQL, Beans)		Canonical BDI Objects
Common Tooling - Retail SOA Enabler, JOS, Integration Console (RIC)		
Common Governance for Canonical Objects – Integration Change Board (ICB)		
Retail Reference Architecture (RRA) and Enterprise Integration Guide (IG)		

Oracle Retail Integration Cloud Service Strategic Goals

- Develop products to enable existing application integration APIs to work without modification for Cloud, Hybrid-Cloud and On-Premise deployment topologies.
- Provide infrastructure products and tooling to decrease:
 - Time to release
 - Test timelines
 - Support costs
- Provide the right methods and tools to support the business requirements & SLAs RGPU applications and customers require.
- Enable partner/customer success by providing a consistent integration experience & tooling.
- Decrease Oracle mandated security (OSSA) burden on application teams by securing frameworks & tooling.

Enterprise Integration Frameworks and Products

Common Enterprise Integration Infrastructure products provide standards and guidance and remove the complexity from the business applications and provide an accepted solutions to recurring problems within a given integration context. Around these styles and patterns, Oracle Retail has developed a set of Enterprise Integration Infrastructure products and supporting tools.

These products expose hundreds of Oracle Retail Application API's as contract driven integration points exposed for integrations between Oracle Retail applications and customer 3rd Party and Legacy applications.

- Retail Integration Bus (RIB) – Asynchronous JMS Messaging
- Retail Service Backbone (RSB) – Request/Response Web Services.
- Bulk Data Integration (BDI) – Bulk Data Movement
- Retail Financial Integration (RFI) – Integration to Oracle Financial Products (EBS, People Soft Financials, Oracle Cloud Financials)
- Oracle Warehouse Management Cloud Service integration using the Universal Service Mapper product (USM) - allows the definition, mapping, and configurations needed to support the integration between two heterogeneous applications.



Note:

All Integration Infrastructure products are fully cloud enabled and will be deployable as the Oracle Retail Integration Cloud Services and existing integration APIs work without modification for Cloud, Hybrid-Cloud and On-Premise installations.

Third Party and Legacy Integration

As used in this document; RICS, third party integrations is the common term used generically for any customer's custom legacy systems and/or customer purchased third party applications.

The list of these are as great as the customer list and RICS integration applications have evolved to make those integrations easier and to follow our contracts and integration styles by providing defined endpoints, guidelines, best practices, and support tooling.

2

Introduction To Oracle Retail Integration Cloud Service (RICS)

The Retail Integration Suite of Products

The Suite is a set of integration infrastructures that are specifically designed to solve retail enterprise integration use cases.

The Suite is made up of hundreds of Pre-built Business Processes that work out of the box for retailers. The process is made up of hundreds of Pre-built Business Objects that are fully tested and supported in end-to-end integration flows for specific to the retail industry.

Retail Integration Cloud Service (RICS)

The Retail Integration Cloud Service (RICS) is a SaaS Cloud deployment of the full Retail Technology's Enterprise Integration Product Suite and the out-of-box GA application integration flows.

- RICS assumes and supports hybrid cloud topologies; cloud-to-cloud, cloud-to-premise and premise-to-cloud.
- RICS has been in production since January 2017 along with Merchandise Foundation Cloud Service.

All of the integration styles and products and the applications supported by RICS are all integrated via web services.

- Built using standard Oracle technologies
- Fully web services-based API's to all integration products
- Provides third party integration API's to all integration products

Figure 2-1 Retail Integration Cloud Services Hybrid Integration

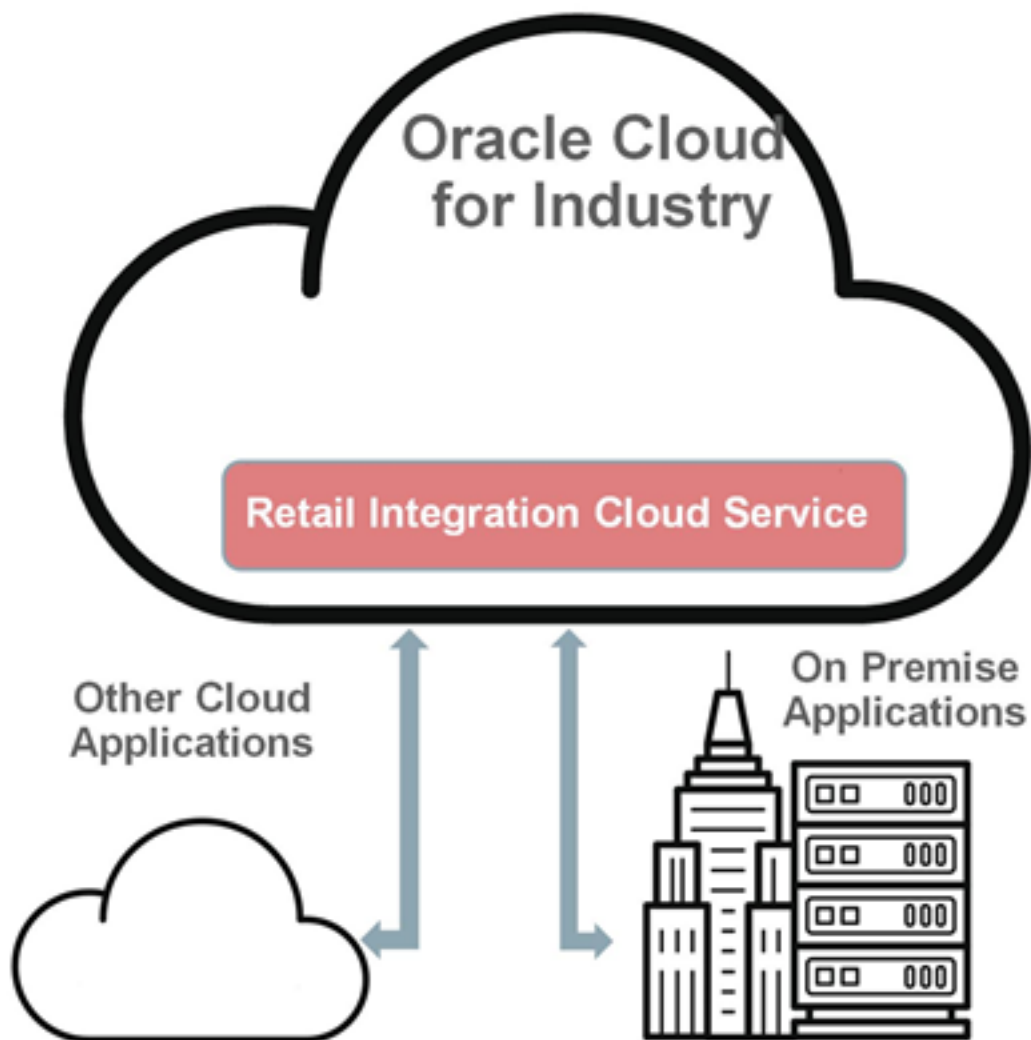

Key Benefits

- Designed using latest industry best practices
- Canonical objects for retail domain that have been built from integration experience with hundreds of customer use cases

Table 2-1

	RIB	RSB	BDI
Business Entities	67	92	49
Business Objects	641	302	51
Integration Flows	69	87	159
Connected Apps	13	24	13

- Intended to work out of the box for customers without needing development effort between supported products
- Only one instance of RICS is required for a customer instance
- Mature Robust Software - running at hundreds of retailers
- Backward and forward compatible Integration APIs - Upgrade Ready
- Mixed version integration capable, tools provided
- Third-party integration ready with build in extension/customization hooks
- Security, monitoring, alerts, logs and so on.
- Strong focus on customer self-service

Retail Integration Cloud Services Architecture

Figure 2-2 RICS Architecture

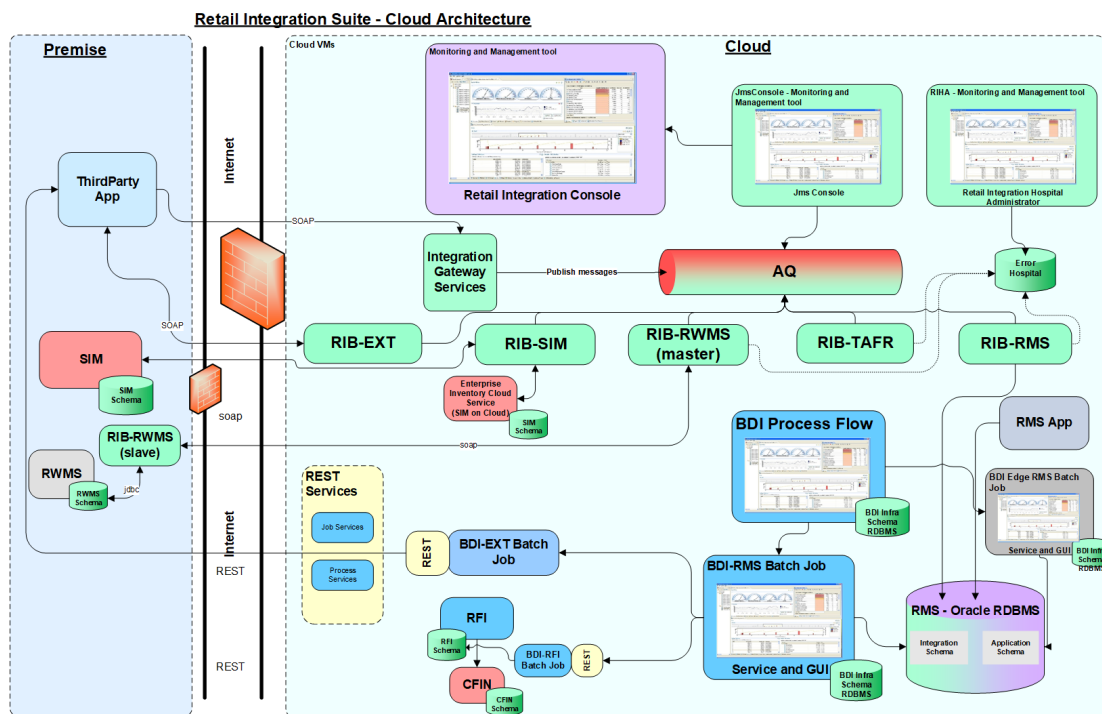

3

Retail Integration Cloud Service Components

Retail Integration Bus (RIB)

The Retail Integration Bus (RIB) is a fire-and-forget, asynchronous messaging backbone and designed as a "Pub/Sub" JMS messaging architecture, with additional application functionality added such as intelligent transformation, routing and error handling.

The RIB acts as a shared communication layer for connecting various Oracle Retail applications and external applications throughout an asynchronous enterprise computing infrastructure. The RIB supplements the core asynchronous messaging backbone with additional application functionality such as intelligent transformation, routing and error handling.

Communication across the RIB is via xml messages (payloads). These payloads describe the retail business objects (such as items, purchase orders, suppliers, and so on) in a standard way and are governed by RIB on behalf of the Oracle Retail applications.

RIB architecture is based on standard Java EE components and the Java Message Service (JMS). JMS is an integral part of the Java EE (Java Enterprise Edition) Technology stack.

The RIB has been designed, and proven to handle retail volumes of messages, typically millions during a Tier 1 -Tier 1+ retailer's business day.

The design and architecture of the RIB infrastructure and the Oracle Retail Applications API's are based on two key requirements driven by the Oracle Retail Application's Business process models.

- *Preservation of Publication Sequence.* The business event (message) must be delivered to all the subscribing applications in the order (FIFO) the business event (messages) was published by the publishing application.
- *Guaranteed Once-and-only-once Successful Delivery.* The RIB must preserve and persist all business events (messages) until all applications (Subscribers) have looked at the message and have successfully consumed it or decided they do not care about that event (message).

RIB Responsibilities with Retail Applications and Third Party Integrations

The RIB is designed as an asynchronous publication and subscription messaging integration architecture. This allows the decoupling of applications and their systems. For example, a publishing application need not know about the subscribing applications, other than the requirement that at least one durable subscriber must exist. It decouples the application systems operationally. Once a subscriber is registered on the JMS, the RIB persists all published messages until all subscribers have seen them.

The publishing adapter does not know, or care, how many subscribers are waiting for the message, what types of adapters the subscribers are, what the subscribers' current states are (running or stopped), or where the subscribers are located. Delivering the message to all

subscribing adapters is the responsibility of the RIB with the help of the underlying JMS server.

Physically, the message persisted so that it is available until all subscribers have processed it. The RIB uses the JMS specification for its messaging infrastructure. The JMS accepts the message from the publisher and saves it to stable storage, a JMS topic, until it is ready to be picked up by a subscriber. In all cases, message information must be kept on the JMS until all subscribers have read and processed it.

The RIB interfaces are organized by message family. Each message family contains information specific to a related set of operations on a business entity or related business entities. The publisher is responsible for publishing messages in response to actions performed on these business entities in the same sequence as they occur.

Each message family has specific message payloads based on agreed upon business elements between the Oracle Retail applications.

Figure 3-1 RIB Integration Responsibilities

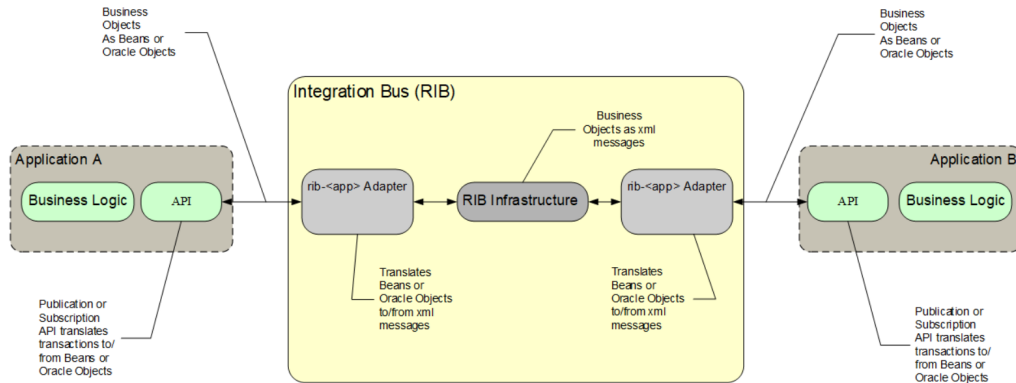

RIB Third Party and Legacy Integration

Third Party and Legacy Integration has been the corner stone of the Enterprise Integration components. To that end there are new cloud focused enhancements to RIB and BDI; RIB-EXT and BDI-EXT are among them.

A lot of effort has been put into continuing that focus into the Cloud by service enabling all of the RICS integration components. To do this, several new components have been added to the RICS suite of products.

RIBforEXT

RIBforEXT is a deployment time configurable component that supports pub/sub to/from the RIB and an external application by exposing the RIB as ReST services to Retail Applications and third party deployed on-premises or in other cloud deployments.

- RIBforEXT has all of the RIB flows available for the deployment time configuration based on the customer use cases.
- RIBforEXT configuration is performed based on the customers use cases for data to and from the RIB.

Oracle Retail Bulk Data Infrastructure (BDI)

Batch (Bulk) data is still a predominant integration style within Oracle Retail and its customers.

The movement of bulk data remains important because some work is best suited to being performed in bulk. Batch processing was there in the early days; it is still here today; and it will still be here tomorrow. What has changed is the approach to batch processing.

Batch processing is typified by bulk-oriented, non-interactive, background execution. Frequently long running, it may be data or computationally intensive, executed sequentially or in parallel, and may be initiated through various invocation models, including ad hoc, scheduled, and on-demand.

Batch applications have common requirements including logging, checkpoint, and parallelization. Batch workloads have common requirements such as operational control, which allow for initiation of, and interaction with, batch instances; such interactions include stop and restart.

BDI productizes the Oracle Retail bulk data flows for delivery to customers and provides the tooling that is required to automate the creation and packaging of the configurations and to manage the full life cycle.

BDI Functional Architecture

Figure 3-2 BDI Functional Architecture

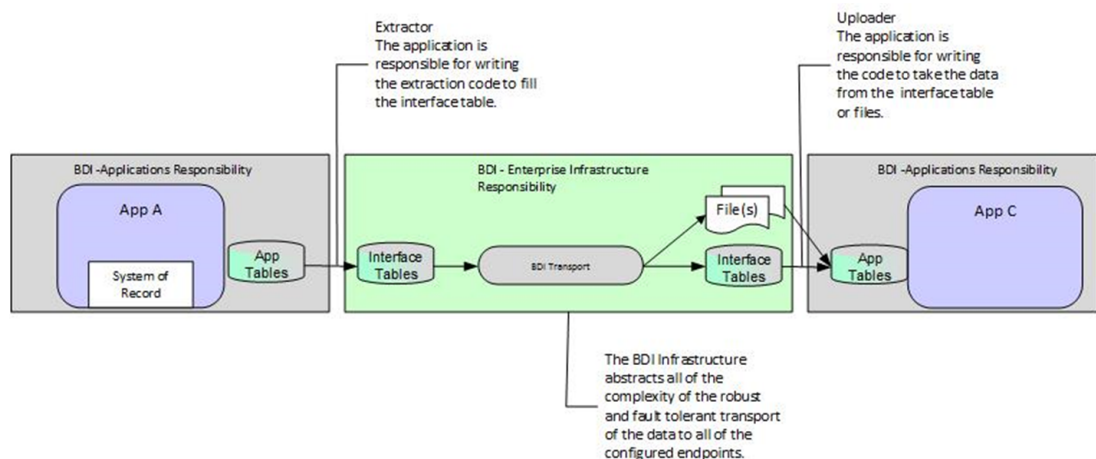

BDI Responsibilities with Retail Applications

The goal of BDI is to provide an infrastructure to support the movement of bulk data between Oracle Retail applications using an agreed upon standard for the shape of the data produced from an application and delivered to an application.

The agreed upon standard is the shape of the data in the interface table structure and the file format. The standard of truth for both is the same and is described in an XML file that is a governable artifact that is part of the ICB process.

The producer of the data agrees to deliver to the BDI infrastructure Interface Tables the data that is shaped accordingly. The consumers understand that the BDI infrastructure will deliver to the BDI infrastructure interface tables or files that are shaped accordingly.

The core responsibility is taking the data published by the sender application and delivering it to all of the receiving applications, regardless if they are deployed on-premise or cloud and to do it in scalable, parallel execution threads with built in failure recoverability and granular job processing.

Figure 3-3 BDI enterprise Infrastructure Topology

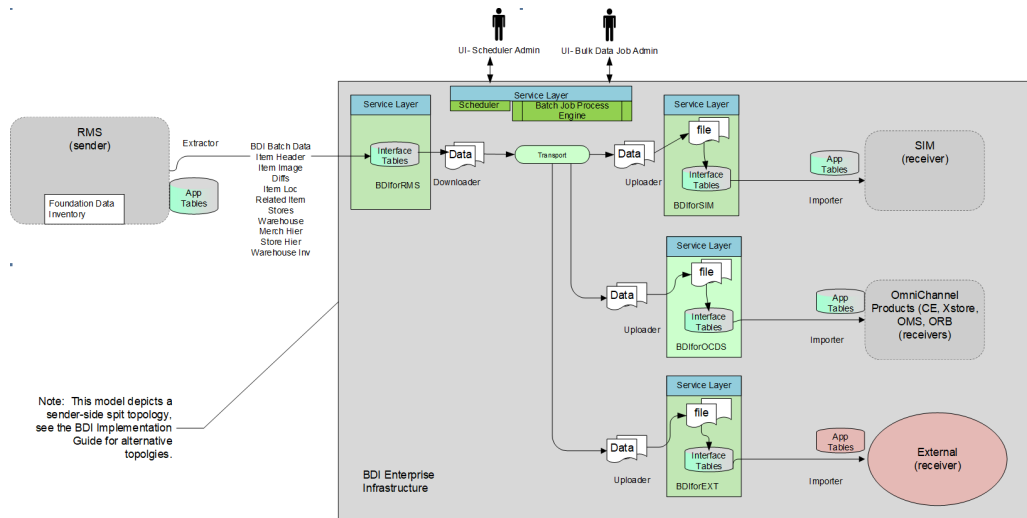

Third Party Integrations

The technology used by the sender application and the receiver application to extract and fill the interface tables and to upload the data from the interface tables is a decision made by each of the applications. There are templates and hooks provided to the application's teams to assist in development.

The BDI Infrastructure for each application is an application (BDIforApp) that is built and supplied by the integration team. There is one dedicated to each application and it is responsible for transforming the data to and from the BDI Transport to the integration interface tables or files that are transported to each of the configured receivers.

All BDI Infrastructure components are service enabled.

Figure 3-4 BDI Job Execution Perspective

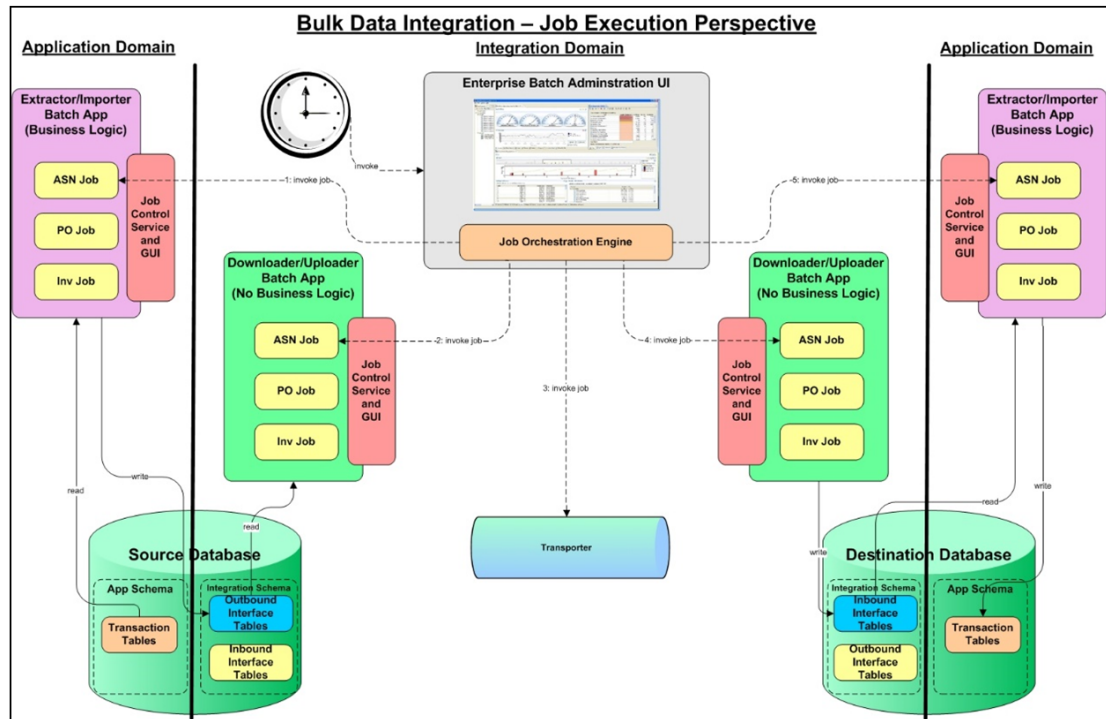

Retail Financial Integration (RFI)

The Oracle Retail Financial Integration (RFI) for E-Business Suite (EBS) / PeopleSoft Financials / CFIN provides integration to a robust enterprise financial system to complement the Oracle Retail Merchandising system in a retail customer environment.

Retail Financial Integration (RFI) Products

On-Premise Merchandising to On-Premise Financial Applications

- RFI for PeopleSoft (On-premise)
- RFI for EBS (On-premise)

Merchandise Foundation Cloud Service (MFCS) to Financial Applications

- RFI for MFCS to On-Premise EBS
- RFI for MFCS to Oracle Cloud Financials

Key Benefits of RFI

- This integration is not a point-to-point integration between the Financial System (EBS or PeopleSoft or ERP Cloud) and Oracle Retail applications. This RFI implementation is independent of the version of integrated applications. A Oracle Retail Financial

Integration (RFI) layer serves as an intermediate thin layer of application between Financial application (EBS or PeopleSoft or ERP Cloud) and Oracle Retail. This integration remains synchronized with the new releases of the edge applications.

- Audited transaction data is exported to the Financial applications days before the traditional audit process permits. The Financials applications can use this timely data in a proactive manner, which results in increased productivity and operational efficiencies.
- Total cost of ownership for Oracle and its customers is reduced.

RFI Processes

- Life Cycle Data Management - This process provides data synchronization for the initial load prior to implementation and incremental data creation and maintenance after implementation.
- Inventory Valuation (Retail stock ledger) - This process enables the posting of accounting entries generated from transactions that change the value of sellable products at a retailer's inventory locations (stores and warehouses) to the appropriate ledgers from Oracle Retail Merchandising - stock ledger to Oracle General Ledger (Oracle GL).
- Retail Revenue Recognition - This process enables posting of accounting entries generated from sales and returns transactions from the retailer's stores for revenue and cash reconciliation to the appropriate ledgers. In this process, the data flows from Oracle Retail Sales Audit (ReSA) to Oracle GL.
- Retail Merchandising Procure to Pay - This process begins with the Oracle Retail Invoice Matching (ReIM) application. Invoices from suppliers for retail merchandise are matched to the original purchase order (PO) for the merchandise and the receipt of the merchandise by the retailer.

RFI for Oracle Cloud Financials

Figure 3-5 RFI for Oracle Cloud Financials

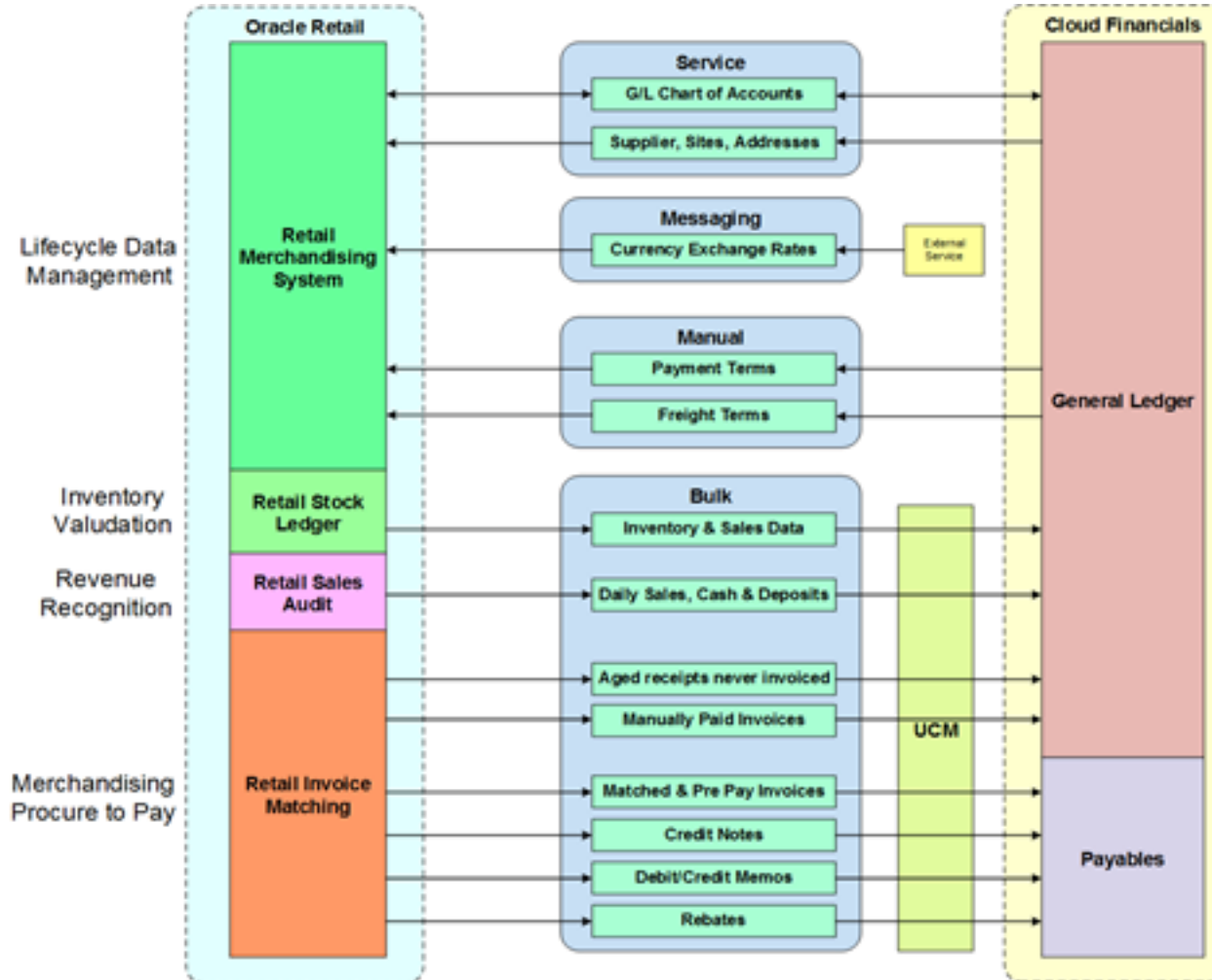

Universal Service Mapper (USM)

The Universal Service Mapper (USM) is an application component of Retail Integration Cloud Service (RICS) that allows the definition, mapping, and configurations needed to support the integration between two heterogeneous applications. Typically this would be an Oracle Retail Application such as RMS, found in the Merchandise Foundation Cloud Service, and an application external to Oracle Retail such as Oracle Warehouse Management CS.

RICS USM supports two of the styles of integration used within Oracle Retail; message-based and service-based as inputs. Within the RGPU applications the message-based flows are across the RIB. It is typical that external applications are predominately service-based so the output of USM is a call is to an external service.

Service calls from an external service are transformed to the correct style and format of the internal application.

The functional requirement for the USM is to act as the place to transform the Oracle Retail application data style and the data format into the data format expected by the external application, and then to perform the transformations of the external application's response

Figure 3-6 USM Process Flow

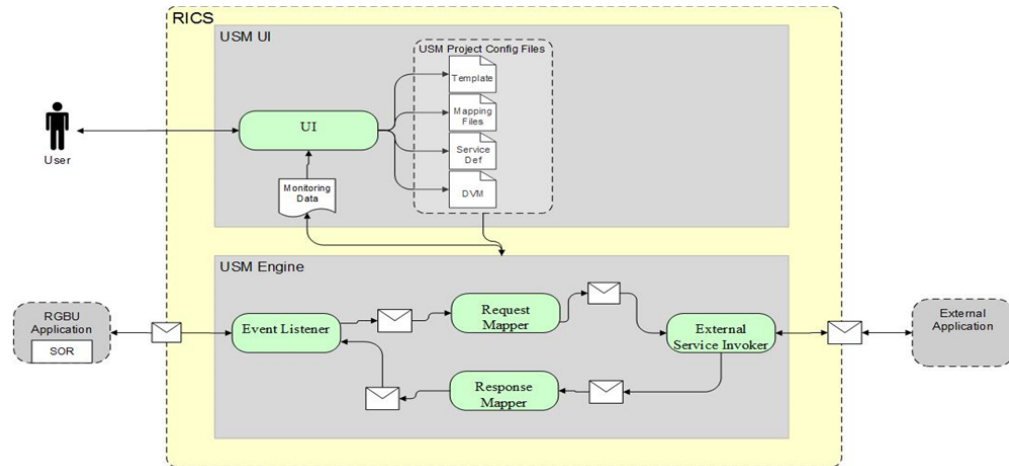

The USM User Interface provides the ability to create and manage Projects in USM and to view app statistics, metrics about the message flow and the system Logs

The USM Engine is the logic part of the system where the data is received from one application, mapped to other data and the mapped data is sent to other applications. Data is communicated through service calls.

- USM hosts all the necessary web-services that are required by both the participating sender and the receiver applications.
- USM has a configuration file of the service URLs to the participating applications.
- USM has templates that contains the mapping information, the code that does the mapping and other configuration files to make the application work.

USM Architecture

Figure 3-7 USM Architecture

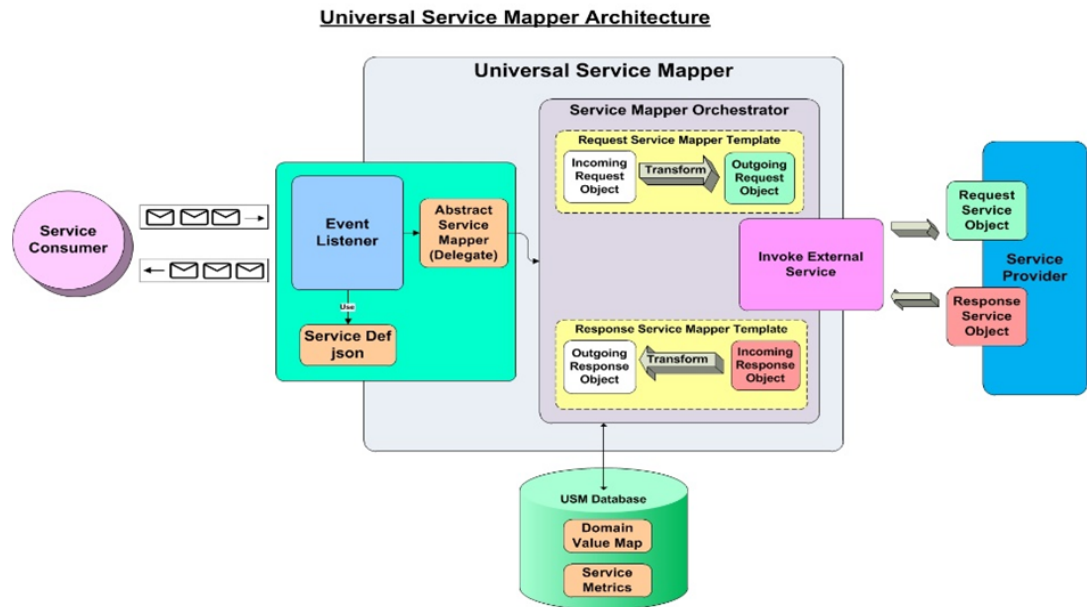

Universal Service Mapper has three major components:

- Event Listener [Abstract Service Mapper, Service Def JSON]
- Service Mapper Orchestration [Orchestrator, Template and DVM]
- External Service Invocation and Service Provider

Event Listener

The Event listener is a service hosted by the USM application which is open to receiving data from any application that is connected to it. The application here is either RIB-LGF or WMS Cloud. The applications have the following URL pattern set in their target for USM.

`http://<host>:<port>`

When application sends data, the event listener internally calls the abstract service mapper which determines family, message type and the operation(s) from the message received by referring to the Service Def JSON file.

Service Mapper Orchestration

The abstract service mapper in turn now calls the Service mapper orchestrator which decides which what data is to be populated in the mapper templates. The orchestrator does the mapping, field by field, from the source application to destination application. Certain key-value pairs in the DVM in order to maintain context between the applications.

Service Provider and External Services

The Service Mapper Orchestrator calls the services hosted by the service providers after the mapping operations are completed. The service providers here are either RIB-LGF or WMS Cloud, which consume these services via USM. The calls are REST calls. USM holds the information necessary for it to call these services in a file with the prefix "external_env_json" for the respective application. These are stored as key-value pairs in JSON file

Use Case: Oracle Warehouse Management CS (Logfire) Integration

Retail Integration Cloud Service (RICS) is used to integrate MFCS to Oracle Warehouse Management Cloud (WMS - LogFire).

RICS uses Universal Service Mapper (USM) to perform the mappings required to connect RICS payloads/services to LogFire interfaces. USM is used to transform and manage the integration flows in both directions.

Figure 3-8 WMS-RICS Mappings

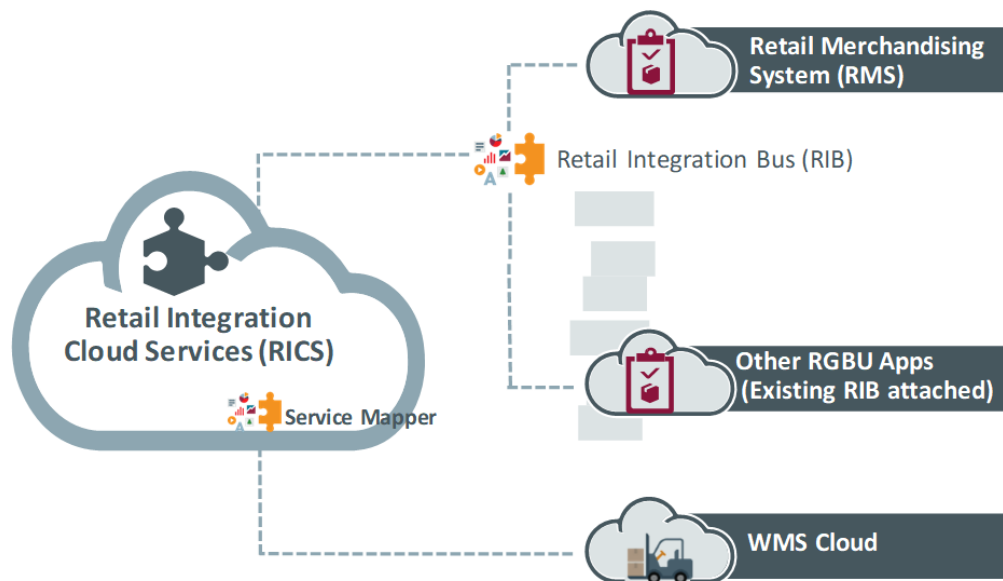

RICS Integration Flows

Figure 3-9 Retail to LogFire Integration Overview

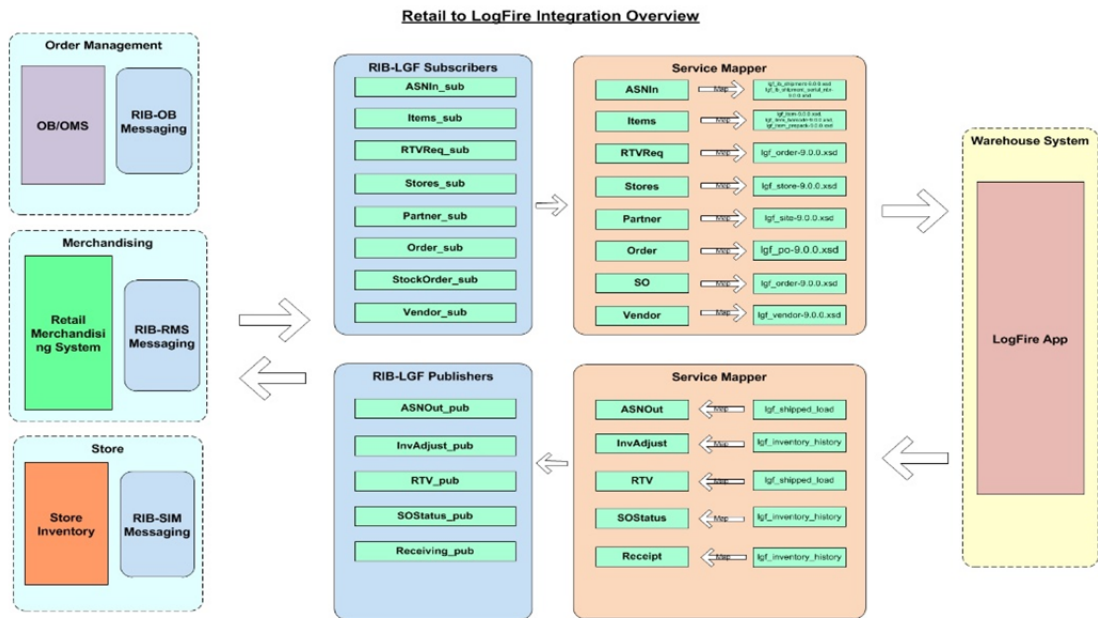

Pre-defined flows between Oracle WMS Cloud and Oracle Retail Applications.

4

RICS Operations Support, Management, and Monitoring

RICS exposes UI's for the customer and for the Oracle Support Team that provide configuration and run time information as well as logs for operational insights and troubleshooting. This section introduces the primary tools.

This is not an exhaustive list. Please see the Resources Section.

Customer Access to RICS Operation

RICS is fully instrumented and exposes metrics via UI's for full operational visibility.

Figure 4-1 Customer Access to RICS Operation

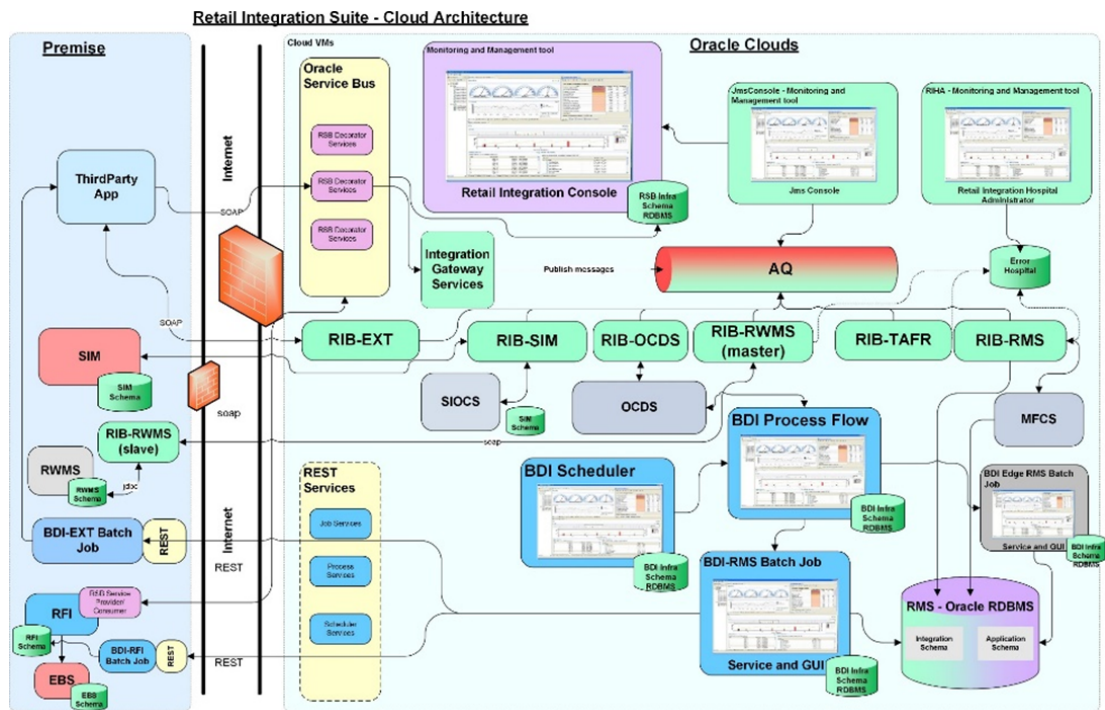

Retail Integration Console (RIC) Overview

RIC is the consolidated Enterprise Integration Monitoring tool and provides full visibility to the Oracle Retail Integration System in a unified view. The audiences for the tool are business analysts, operations people, and integration administrators.

Data is presented in graphical and tabular forms along with business context, so it is more easily understood by business analysts and technical personnel.

RIC directly integrates with the Integration Guide via contextual hyperlinks.

Figure 4-2 Retail Integration Console



JMS Console

The JMS Console is an administration tool to monitor and manage the RIB's JMS Servers.

Figure 4-3 JMS Console Workflow

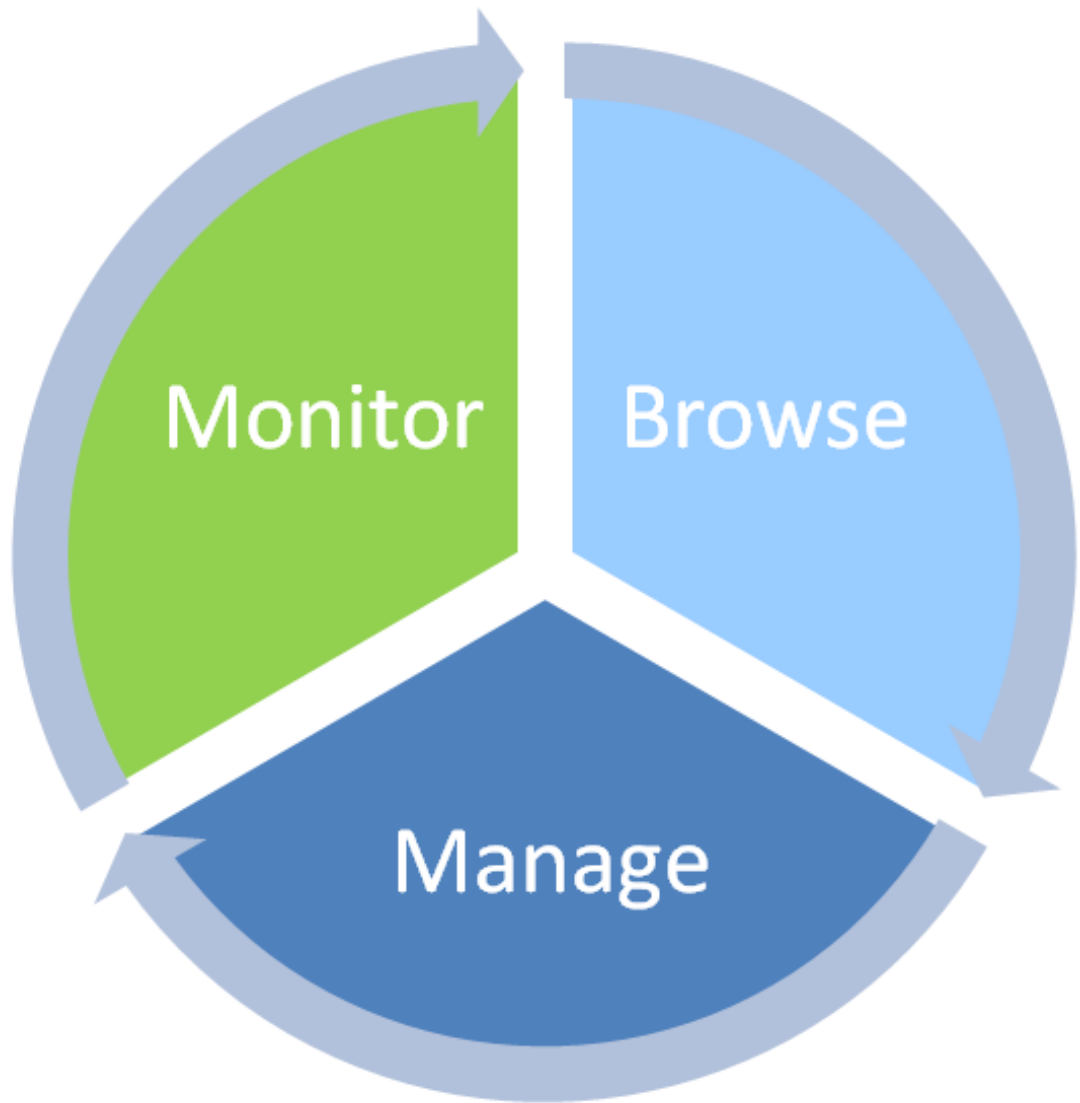

The JMS Admin provides an operational view point of RIB's JMS server.

- **Monitor** - Unattended view of the JMS system.
- **Browse** - Discover and Drill down into various aspects of the JMS Server.
- **Manage** - Provide JMS Server operation management functionality.

JMS Admin – Live Monitoring

Figure 4-4 JMS Console

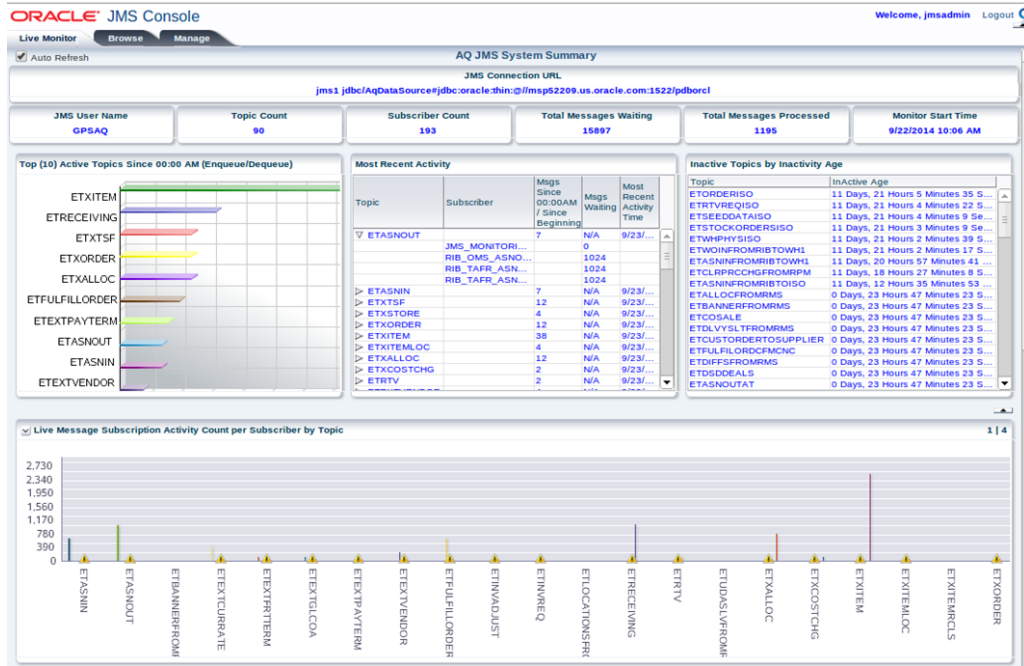

The Live Monitor tab is the landing page of the JMS Console Application. It provides an unattended high-level view of the JMS Server.

Live Monitoring also provides

- Current message volume information.
- Provides most recent activity details.
- Identify problematic JMS topics and bring to user notice.
- Display a full view of all message activities on all topics.
- Generate alerts based on set thresholds.
- Show visual clues on problematic topics.
- Gives an aggregated view of the system.

The Browse and Manage Tabs provide more specific data metrics and ability to manage messages on the JMS topics.

JMS Browse

The Browse Tab allows you to discover and drill into the internals of JMS Servers.

- Discover all topics and get a listing of them from the server.
- Drill into each topic and discover all subscribers.

- Drill into each subscriber and get message count information.
- Browse message content inside JMS server
- Browse message headers inside JMS server

JMS Manage

The Manage tab allows you to interact with the JMS server with some core messaging system functionality.

- Publish messages to JMS topics easily
- Dump messages to files from topics
- Drain messages from topics
- Configure preference for threshold and alerts

RIB Hospital Administrator (RIHA)

Figure 4-5 RIB Hospital Administrator

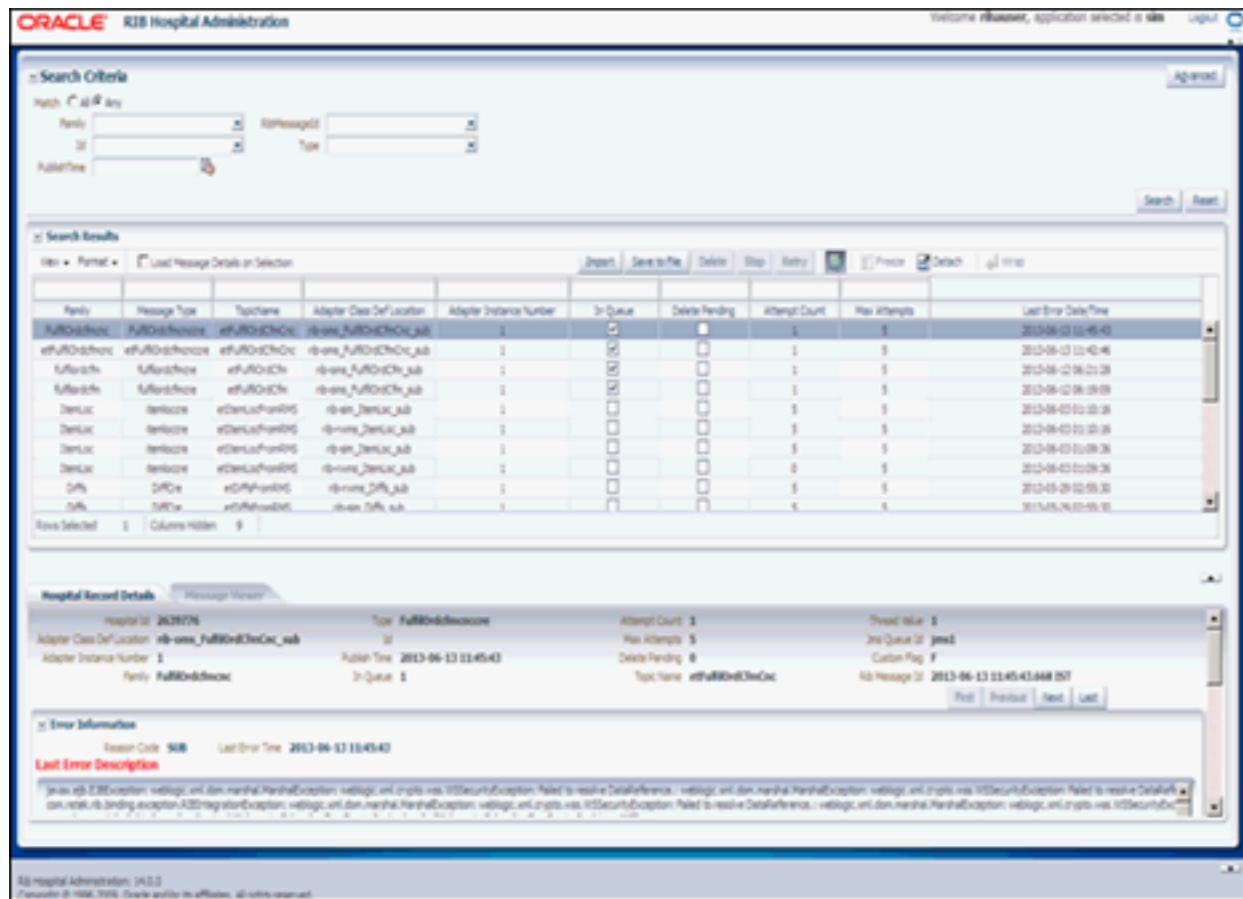

Oracle Retail Integration Bus Hospital Administration or RIB Hospital Administration (RIHA) is a tool to manage RIB messages in the RIB hospital error tables.

RIHA can search for hospital records, stop a message from being retried, retry a message for which maximum system-set retries have been tried, and delete a message from the tables. RIHA can insert new records into Hospital tables. You can also update existing Hospital records and message payloads.

Using RIHA is the recommended way to perform all RIB Hospital error table operations.

RIHA Operations

- Delete a Message
- Stop a Message
- Retry a Message
- View and Edit a Message
- Save a Message Locally
- Import a New Hospital Record to Hospital Tables
- Update an Existing Hospital Record

RIBForXXX Administrator User Interface

Each of the RIB components (RIB-RMS, RIB-LGF, and so on) has its own UI that exposes run-time and configuration details. The Administrator UI provides operations to turn on or off RIB adapters, control logging levels and to see logs.

Figure 4-6 RIBForXXX Administrator User Interface

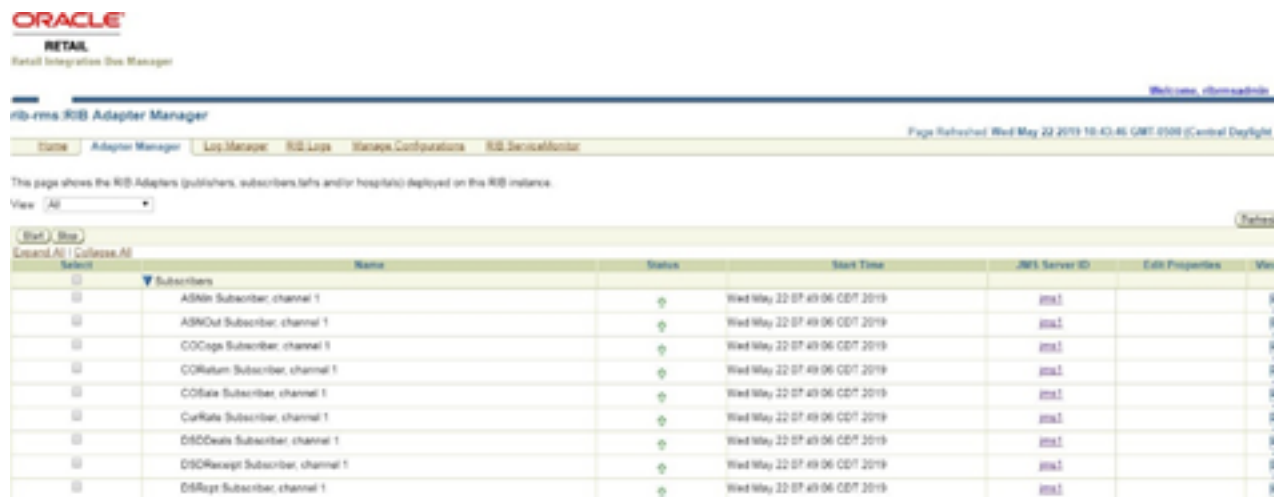

5

Resources

RICS Documentation (version 22.1.201.0)

<https://docs.oracle.com/en/industries/retail/retail-integration-cloud/22.0>