

Oracle® Retail Predictive Application Server Cloud Edition Administration Guide



Release 24.1.201.0

F96183-02

April 2024

The Oracle logo, consisting of a solid red square with the word "ORACLE" in white, uppercase, sans-serif font centered within it.

ORACLE®

Copyright © 2024, Oracle and/or its affiliates.

Primary Authors: Judith Meskill, Mark Huang

This software and related documentation are provided under a license agreement containing restrictions on use and disclosure and are protected by intellectual property laws. Except as expressly permitted in your license agreement or allowed by law, you may not use, copy, reproduce, translate, broadcast, modify, license, transmit, distribute, exhibit, perform, publish, or display any part, in any form, or by any means. Reverse engineering, disassembly, or decompilation of this software, unless required by law for interoperability, is prohibited.

The information contained herein is subject to change without notice and is not warranted to be error-free. If you find any errors, please report them to us in writing.

If this is software, software documentation, data (as defined in the Federal Acquisition Regulation), or related documentation that is delivered to the U.S. Government or anyone licensing it on behalf of the U.S. Government, then the following notice is applicable:

U.S. GOVERNMENT END USERS: Oracle programs (including any operating system, integrated software, any programs embedded, installed, or activated on delivered hardware, and modifications of such programs) and Oracle computer documentation or other Oracle data delivered to or accessed by U.S. Government end users are "commercial computer software," "commercial computer software documentation," or "limited rights data" pursuant to the applicable Federal Acquisition Regulation and agency-specific supplemental regulations. As such, the use, reproduction, duplication, release, display, disclosure, modification, preparation of derivative works, and/or adaptation of i) Oracle programs (including any operating system, integrated software, any programs embedded, installed, or activated on delivered hardware, and modifications of such programs), ii) Oracle computer documentation and/or iii) other Oracle data, is subject to the rights and limitations specified in the license contained in the applicable contract. The terms governing the U.S. Government's use of Oracle cloud services are defined by the applicable contract for such services. No other rights are granted to the U.S. Government.

This software or hardware is developed for general use in a variety of information management applications. It is not developed or intended for use in any inherently dangerous applications, including applications that may create a risk of personal injury. If you use this software or hardware in dangerous applications, then you shall be responsible to take all appropriate fail-safe, backup, redundancy, and other measures to ensure its safe use. Oracle Corporation and its affiliates disclaim any liability for any damages caused by use of this software or hardware in dangerous applications.

Oracle®, Java, MySQL and NetSuite are registered trademarks of Oracle and/or its affiliates. Other names may be trademarks of their respective owners.

Intel and Intel Inside are trademarks or registered trademarks of Intel Corporation. All SPARC trademarks are used under license and are trademarks or registered trademarks of SPARC International, Inc. AMD, Epyc, and the AMD logo are trademarks or registered trademarks of Advanced Micro Devices. UNIX is a registered trademark of The Open Group.

This software or hardware and documentation may provide access to or information about content, products, and services from third parties. Oracle Corporation and its affiliates are not responsible for and expressly disclaim all warranties of any kind with respect to third-party content, products, and services unless otherwise set forth in an applicable agreement between you and Oracle. Oracle Corporation and its affiliates will not be responsible for any loss, costs, or damages incurred due to your access to or use of third-party content, products, or services, except as set forth in an applicable agreement between you and Oracle.

Contents

Send Us Your Comments

Preface

Audience	xvi
Documentation Accessibility	xvi
Related Documents	xvi
Customer Support	xvii
Improved Process for Oracle Retail Documentation Corrections	xvii
Oracle Retail Documentation on the Oracle Technology Network	xvii
Conventions	xvii

1 Introduction

Basic RPASCE Concepts	1-1
Multidimensionality	1-1
Dimensions	1-2
Measures	1-2
Segments and Workspaces	1-2
RPASCE Client	1-3
Administrative Workspaces and Wizards	1-3
Online Administration Tools	1-3
Dashboard Settings	1-3

2 User Administration

Atomic User Management	2-1
Setting Up Users and Groups	2-2
AUM Utilities	2-3
OCI IAM Migration Tool	2-3
Synchronize Users from OCI IAM	2-4
Managing Users and Groups	2-6

3 Planning Data Schema Administration

Introduction	3-1
Configuration	3-3
Partitioning	3-3
Building PDS	3-4
Patch PDS	3-6
Patch Dry Run Report Generation	3-8
Post Build Steps	3-10
Check PDS	3-11
List PDS Status	3-15
Create Reporting Views in PDS	3-16
Load Dimension Data	3-18
Loading Dimension Data	3-18
Load Fact Data	3-20
PDS Manager	3-23
Planning Data Schema Default Web Services (through ORDS)	3-24
Apex User Creation	3-24
Default Web Services	3-25
Web Services URL	3-25
OCI IAM Authorized Access to PDS Web Services in Apex/ORDS	3-28
Requirements	3-28
Get Bearer Token	3-28
Perform the ORDS Rest API Calls	3-31
Invoke Read PDS Web Service - Read all Measures	3-32
Write PDS Web Service for Facts	3-33
Invoke Read PDS Web Service - Retrieve Data from a Fact	3-34
PDS Concurrency	3-36

4 System Administration

Hierarchy Maintenance Workbook	4-1
Hierarchy Maintenance Example	4-2
Hierarchy Maintenance Wizard	4-2
Hierarchy Maintenance View	4-7
Maintaining a User-Defined Dimension Within a Hierarchy	4-11
Security Administration	4-12
Security Overview	4-12
User and Group Security	4-12
Position Level Security	4-12
Workbook Security	4-14
Security Administration Workbook	4-15

Workbook Template Rights View	4-15
Dimension Modification Rights View	4-16
Position Level Security Views	4-16
Workbook Template Limits Views	4-16
Max Domain Session Limit View	4-17
Max User Session Limit View	4-17
Group Workbook Template Default Rights View	4-17
Using the Security Administration Workbook	4-17
Accessing Security Administration	4-17
Setting or Modifying Users' Access to Workbook Templates	4-19
Changing a User's Ability to Modify Dimensions	4-19
Setting or Modifying Access to Positions (if Position Level Security has been Enabled)	4-19
Limiting the Number of Workbooks that a User Can Save	4-20
Limiting the Number of Workbooks Per Template	4-20
Limiting the Number of Workbooks that a Group Can Save	4-21
Withdrawing Administrative Privileges or User Access Rights	4-21
Security Administration Workbook Withdrawal Scenario	4-21
Workbook Template	4-21
Measure Analysis Workbook	4-22
Measure Analysis View	4-22
Accessing Measure Analysis	4-23
Reviewing and Editing Sales or Other Registered Measure Data	4-27
XML Schema for Importing Users and Groups	4-28
List Logged-In Users	4-29
Schedule Dashboard Build	4-29

5 Online Administration Tools

Online Administration Tools Templates	5-1
Copy from an Existing Admin Task	5-2
Delete a Scheduled Admin Task	5-2
Modify a Scheduled Admin Task	5-2
Submit a New Admin Task	5-2
General Submission Workflow	5-3
Select a Task Group	5-3
Select a Task	5-3
Setting Parameters	5-4
Setting the Schedule	5-14
Confirmation	5-15
Task Status Dashboard	5-16
Email Notification for OAT Tasks	5-18

System Administration Tasks	5-23
Manage DimensionsTask	5-25
Dimension Attribute Manager Task	5-26
Load Alternate Rollup Data Task	5-27
Oracle Support Administration	5-30
List/Set/Unset PDS Integration Variables	5-31
Load Interface Mappings	5-32
Export Hierarchy Data Task	5-33
Export Measure Data Task	5-34
Manage Hierarchies Task	5-37
Expressions, Rules, and Rule Groups Information Task	5-39
Manage Informal Positions Task	5-40
Create Informal Positions in Bulk	5-41
Data Slice Copying	5-42
Measure Information Task	5-44
Purge Tasks from Task Status Dashboard Task	5-45
Rename Positions Task	5-45
Segment/Workspace Batch Operation Task	5-46
Enable/Disable Toggleable Features Task	5-48
Manage Workspaces Task	5-48
Formats Users Security Export Task	5-50
Formats Users Security Import Task	5-51
Service Request Administration Tasks	5-53
Package Logs Task	5-53
Bootstrap Administration Tasks	5-56
Build Application Task	5-57
Template Status Task	5-59
Unregister Application	5-60
Retail Home Seeding	5-61
Retail Home Configuration	5-61
Updating Retail Home	5-61
Application Administration Tasks	5-62
Task Status Dashboard	5-62
Dashboard Columns	5-63
Active Users	5-70
Other Active User Options	5-70

6 Data Administration

CSV File Format	6-1
Hierarchy Management	6-1

Modifying Hierarchies	6-2
Managing Dimension Data	6-5
Reclassification	6-6
Managing Informal Positions	6-6
Exporting Hierarchy Data	6-6
Loading Measure/Fact Data	6-6
Exporting Measure Data	6-7
Placeholder Web Service	6-7

7 Batch Administration

Application-Specific Batch Tasks	7-1
Run Batch Task Group	7-1
Run Batch Measure Load Group	7-2
Run Batch Measure Export Group	7-2
Run Batch Calc Group	7-2
Uploading and Downloading Data Files	7-2

8 RPASCE Batch Schedule with POM

RPASCE Batch Schedule	8-1
Batch Schedules for Additional Instances of RPASCE Applications	8-16
POM Batch Monitoring	8-21
POM System Administration	8-22
POM Batch Administration	8-24
Controlling POM Batch Execution Using Retail Home Customer Module Management	8-27
POM Batch Scheduling	8-28
Batch Integration through Restful Endpoints	8-30
Custom Batch Schedule	8-33

9 Internationalization

Translation in RPASCE	9-1
Browser Setup	9-3
Translation Administration Workspaces	9-4
Translation Administration Workspace	9-5
Dimension	9-6
Hierarchy	9-6
Measure	9-6
Message	9-6
Rule Group	9-7
Template	9-7

Template Group	9-7
User Group	9-7
Position Translation Administration Workspace	9-7
Building a Position Translation Administration Workspace	9-7
Loading Internal Translation Measures	9-9
Position Translation	9-10
Template-Based Override for Measures	9-11
Translation Tasks	9-11
Upload Custom Translations Task	9-11
Remove Custom Translations Task	9-12
Other Translation Tasks	9-12
Supported Translation Measures	9-13
Miscellaneous	9-13
Taskflow Components Translation	9-14

10 Resource Bundle Customization

Editing Resource Strings	10-1
Roles	10-1
Editing Process	10-1
Application	10-2
Bundles	10-2
Languages	10-2
Resource	10-3
Text	10-3
Add or Edit	10-4
Remove Customization	10-5
Settings for the RPASCE UI	10-5
Settings for Retail Home	10-5
Resource Keywords	10-6

11 Informational Utilities

Printing Measure Information	11-1
Submitting a Measure Information Task	11-1

12 Operational Utilities

Setting Miscellaneous PDS Properties	12-1
Submit Online Admin Task for the PDS Property Service	12-1
Display the Current Value of the Named PDS Property	12-4
Update PDS Property to Value Provided (name=value)	12-7

Setting Date and Time Variables	12-10
Accessing the Calculation Engine Using mace	12-14
Submit Online Admin Task for Mace Service	12-14
Search for a Specific String	12-16
Print the Specified Rule	12-19
Print the Specified Rule Group	12-22
Print All the Rules and Rule Groups	12-24
Managing Segments Using wbbatch	12-27
Managing Workbooks Using wbmgr	12-63

13 Planning Data Schema Diagnostic Tool (PDS Explorer)

Interface	13-1
Registered Applications	13-1
Facts	13-2
Fact Data	13-2
Dimensions	13-5
Levels	13-5
Batch Control Tags	13-6
Downloads	13-6

14 RPASCE Test Automation

Introduction	14-1
RPAC in Batch Framework	14-1
Writing Test Cases	14-3
Example	14-4
Output	14-6
Schema	14-7
RPAC Attributes, Values, and Variables	14-7
1. RPAC Structure Tag	14-8
1.1 testscript	14-8
1.2 testsuite	14-8
1.3 testcase	14-8
1.4 once	14-9
1.5 finalize	14-9
1.6 setup	14-10
1.7 teardown	14-10
2. Application Measure Tags	14-10
2.1 assert-application-measure-exists	14-10
2.2 assert-application-measure-intx	14-11

2.3	assert-application-measure-value-eq	14-11
2.4	assert-application-measure-value-ge	14-11
2.5	assert-application-measure-value-gt	14-12
2.6	assert-application-measure-value-le	14-13
2.7	assert-application-measure-value-lt	14-13
2.8	assert-application-measure-value-ne	14-14
2.9	assert-application-measures-match	14-14
2.10	assert-application-popcount-value-eq	14-15
2.11	assert-application-popcount-value-ge	14-15
2.12	assert-application-popcount-value-gt	14-15
2.13	assert-application-popcount-value-le	14-16
2.14	assert-application-popcount-value-lt	14-16
2.15	assert-application-popcount-value-ne	14-17
2.16	set-application-measure	14-17
2.17	register-measure	14-18
2.18	unregister-measure	14-19
2.19	unregister-measures	14-19
2.20	get-measure-property	14-19
2.21	clear-application-measure-list	14-20
2.22	clear-application-measure	14-20
2.23	backup-appl-measure	14-21
2.24	dump-appl-measure	14-21
2.25	load-appl-measure	14-21
2.26	restore-all-appl-measure	14-22
3.	Dimension Tags	14-22
3.1	assert-hier-exists	14-22
3.2	assert-dimension-contain	14-23
3.3	assert-dimension-exists	14-23
3.4	assert-dimension-size	14-23
4.	Directory and File Tags	14-24
4.1	assert-directory-does-not-exists	14-24
4.2	assert-directory-exists	14-24
4.3	assert-directory-is-empty	14-25
4.4	assert-directory-structure	14-25
4.5	assert-file-contains	14-25
4.6	assert-file-does-not-exists	14-26
4.7	assert-file-exists	14-27
4.8	assert-file-is-empty	14-27
4.9	assert-file-is-read-lock	14-28
4.10	assert-file-is-write-lock	14-28
4.11	compare-file-content	14-29

4.12 compare-files	14-29
4.13 copy-directory	14-30
4.14 copy-file	14-30
4.15 create-directory	14-30
4.16 create-file	14-31
4.17 erase-file	14-31
4.18 rename-file	14-32
4.19 remove-directory	14-32
4.20 read-lock-file	14-33
4.21 write-lock-file	14-33
4.22 unlock-file	14-33
4.23 assert-file-size-eq	14-34
4.24 assert-file-size-ge	14-34
4.25 assert-file-size-gt	14-35
4.26 assert-file-size-le	14-35
4.27 assert-file-size-lt	14-36
4.28 assert-file-size-ne	14-36
5. Sql Query Tags	14-37
5.1 assert-sql-query-eq	14-37
5.2 assert-sql-query-ge	14-38
5.3 assert-sql-query-gt	14-38
5.4 assert-sql-query-le	14-39
5.5 assert-sql-query-lt	14-40
5.6 assert-sql-query-ne	14-40
5.7 call-rule-group	14-41
5.8 call-special-expression	14-41
5.9 dump-database-tables	14-41
5.10 execute-bdi-extractor	14-42
5.11 execute-bdi-importer	14-42
5.12 execute-sql-query	14-43
5.13 load-database-tables	14-43
5.14 set-database-role	14-44
5.15 sql-start-trace	14-44
5.16 sql-stop-trace	14-44
5.17 truncate-database-tables	14-44
6. Workbook Measures Tags	14-45
6.1 assert-workbook-measure-exists	14-45
6.2 assert-workbook-measure-intx	14-45
6.3 assert-workbook-measure-value-eq	14-45
6.4 assert-workbook-measure-value-ge	14-46
6.5 assert-workbook-measure-value-gt	14-47

6.6	assert-workbook-measure-value-le	14-48
6.7	assert-workbook-measure-value-lt	14-48
6.8	assert-workbook-measure-value-ne	14-49
6.9	assert-workbook-measures-match	14-50
6.10	assert-workbook-popcount-value-eq	14-51
6.11	assert-workbook-popcount-value-ge	14-51
6.12	assert-workbook-popcount-value-gt	14-51
6.13	assert-workbook-popcount-value-le	14-52
6.14	assert-workbook-popcount-value-lt	14-52
6.15	assert-workbook-popcount-value-ne	14-52
6.16	set-workbook-measure	14-53
6.17	edit-workbook-measure	14-54
6.18	clear-workbook-measure-list	14-55
6.19	clear-workbook-measure	14-55
6.20	assert-measure-is-not-protected	14-55
6.21	assert-measure-is-protected	14-56
7.	Workbook Operations Tags	14-57
7.1	assert-window-contain-measure	14-57
7.2	assert-window-exists	14-57
7.3	assert-window-intersection	14-57
7.4	assert-window-not-exists	14-58
7.5	build	14-58
7.6	calc	14-59
7.7	close	14-59
7.8	commit	14-60
7.9	custom-menu	14-60
7.10	set-hier-selection	14-61
7.11	set-selected	14-61
7.12	set-selection	14-61
7.13	set-selections	14-62
7.14	set-text	14-62
7.15	set-tree-selections	14-63
7.16	wizard-page-settings	14-63
7.17	workbook-operations	14-64
7.18	open	14-64
7.19	rebuild	14-65
7.20	refresh	14-65
7.21	delete-informal-position	14-66
7.22	update-dpm	14-66
7.23	update-informal-positions	14-66
7.24	dpmposentry	14-67

7.25 dpmposinfo	14-67
8. Workbook Execute Expression Tag	14-68
8.1 workbook-execute-expression	14-68
8.2 rule-debug-log	14-68
8.3 rule-debug-start	14-69
8.4 rule-debug-stop	14-70
9. Processes, Tasks, Environment Variables, and DateTime Tags	14-70
9.1 task-log	14-70
9.2 task-start	14-71
9.3 task-wait	14-72
9.4 sleep	14-72
9.5 shell	14-72
9.6 set-date-format	14-73
9.7 set-environment-variable	14-73
9.8 rpass-today	14-74
9.9 process-stop	14-74
9.10 process-wait	14-75
9.11 get-unique-file-path	14-75
9.12 assert-numeric-value-eq	14-76
9.13 assert-numeric-value-ge	14-76
9.14 assert-numeric-value-gt	14-77
9.15 assert-numeric-value-le	14-78
9.16 assert-numeric-value-lt	14-78
9.17 assert-numeric-value-ne	14-79
9.18 assert-string-value-contains	14-80
9.19 assert-string-value-does-not-contain	14-80
9.20 assert-string-value-equal	14-81
9.21 assert-string-value-not-equal	14-81
9.22 if-numeric-value-eq-then-set	14-82
9.23 if-numeric-value-ge-then-set	14-83
9.24 if-numeric-value-gt-then-set	14-84
9.25 if-numeric-value-le-then-set	14-85
9.26 if-numeric-value-lt-then-set	14-86
9.27 if-numeric-value-ne-then-set	14-87
9.28 if-string-value-contains-then-set	14-87
9.29 if-string-value-does-not-contain-then-set	14-88
9.30 if-string-value-equal-then-set	14-89
9.30 if-string-value-not-equal-then-set	14-90
10. Misc Tags	14-91
10.1 clear-all-measures	14-91
10.2 fail	14-91

10.3 log	14-92
10.4 reset-seq-generator	14-92

15 Performance Diagnostic Tool

Overview	15-1
Collecting and Managing Performance Metrics	15-1
Analyzing Workbook Performance	15-1

16 Service Administration

System Configuration	16-1
----------------------	------

17 RPASCE Health Check and System Tasks

18 Maintenance Tasks

19 Logging Framework

Log File and Format	19-1
Access to Logs	19-2
logAggregator Utility	19-3
Json Log Format	19-4

20 Best Practices

Measure to Fact Mapping and Optimal Fact Grouping	20-1
Measure to Fact Mapping	20-1
Optimal Fact Grouping	20-1
Data Loading	20-1
Free Expressions in Batch Control File	20-1

A Appendix: Troubleshooting

Send Us Your Comments

Oracle Retail Predictive Application Server Cloud Edition Administration Guide Release 24.1.201.0.

Oracle welcomes customers' comments and suggestions on the quality and usefulness of this document.

Your feedback is important, and helps us to best meet your needs as a user of our products. For example:

- Are the implementation steps correct and complete?
- Did you understand the context of the procedures?
- Did you find any errors in the information?
- Does the structure of the information help you with your tasks?
- Do you need different information or graphics? If so, where, and in what format?
- Are the examples correct? Do you need more examples?

If you find any errors or have any other suggestions for improvement, then please tell us your name, the name of the company who has licensed our products, the title and part number of the documentation and the chapter, section, and page number (if available).



Note:

Before sending us your comments, you might like to check that you have the latest version of the document and if any concerns are already addressed. To do this, access the Online Documentation available on the Oracle Technology Network Web site. It contains the most current Documentation Library plus all documents revised or released recently.

Send your comments to us using the electronic mail address: retail-doc_us@oracle.com

Please give your name, address, electronic mail address, and telephone number (optional).

If you need assistance with Oracle software, then please contact your support representative or Oracle Support Services.

If you require training or instruction in using Oracle software, then please contact your Oracle local office and inquire about our Oracle University offerings. A list of Oracle offices is available on our Web site at <http://www.oracle.com>.

Preface

Oracle Retail Administration Guides are designed so that you can view and understand the application's behind-the-scenes processing, including such information as the following:

- Key system administration configuration settings
- Technical architecture
- Functional integration dataflow across the enterprise
- Batch processing

Audience

This document is intended for the users and administrators of Oracle Retail Predictive Application Server Cloud Edition. This may include merchandisers, buyers, and business analysts.

Documentation Accessibility

For information about Oracle's commitment to accessibility, visit the Oracle Accessibility Program website at <http://www.oracle.com/pls/topic/lookup?ctx=acc&id=docacc>.

Access to Oracle Support

Oracle customers that have purchased support have access to electronic support through My Oracle Support. For information, visit <http://www.oracle.com/pls/topic/lookup?ctx=acc&id=info> or visit <http://www.oracle.com/pls/topic/lookup?ctx=acc&id=trs> if you are hearing impaired.

Related Documents

For more information, see the following documents in the Oracle Retail Predictive Application Server Cloud Edition documentation set:

- *Oracle Retail Predictive Application Server Cloud Edition Configuration Tools User Guide*
- *Oracle Retail Predictive Application Server Cloud Edition Implementation Guide*
- *Oracle Retail Predictive Application Server Cloud Edition Release Notes*
- *Oracle Retail Predictive Application Server Cloud Edition Security Guide*
- *Oracle Retail Predictive Application Server Cloud Edition User Guide*

Customer Support

To contact Oracle Customer Support, access My Oracle Support at the following URL:

<https://support.oracle.com>

When contacting Customer Support, please provide the following:

- Product version and program/module name
- Functional and technical description of the problem (include business impact)
- Detailed step-by-step instructions to re-create
- Exact error message received
- Screen shots of each step you take

Improved Process for Oracle Retail Documentation Corrections

To more quickly address critical corrections to Oracle Retail documentation content, Oracle Retail documentation may be republished whenever a critical correction is needed. For critical corrections, the republication of an Oracle Retail document may at times not be attached to a numbered software release; instead, the Oracle Retail document will simply be replaced on the Oracle Technology Network Web site, or, in the case of Data Models, to the applicable My Oracle Support Documentation container where they reside.

This process will prevent delays in making critical corrections available to customers. For the customer, it means that before you begin installation, you must verify that you have the most recent version of the Oracle Retail documentation set. Oracle Retail documentation is available on the Oracle Technology Network at the following URL:

<http://www.oracle.com/technetwork/documentation/oracle-retail-100266.html>

An updated version of the applicable Oracle Retail document is indicated by Oracle part number, as well as print date (month and year). An updated version uses the same part number, with a higher-numbered suffix. For example, part number E123456-02 is an updated version of a document with part number E123456-01.

If a more recent version of a document is available, that version supersedes all previous versions.

Oracle Retail Documentation on the Oracle Technology Network

Oracle Retail product documentation is available on the following web site:

<http://www.oracle.com/technetwork/documentation/oracle-retail-100266.html>

(Data Model documents are not available through Oracle Technology Network. You can obtain them through My Oracle Support.)

Conventions

The following text conventions are used in this document:

Convention	Meaning
boldface	Boldface type indicates graphical user interface elements associated with an action, or terms defined in text or the glossary.
<i>italic</i>	Italic type indicates book titles, emphasis, or placeholder variables for which you supply particular values.
monospace	Monospace type indicates commands within a paragraph, URLs, code in examples, text that appears on the screen, or text that you enter.

1

Introduction

After the RPAS Cloud Edition (RPASCE) Server and Client have been installed and set up, you must complete several online administration activities before users can begin using RPASCE and RPASCE applications. The following are the primary activities for online administration.

- User Maintenance
- System Administration
- Translation Administration
- Online Administration Tools
 - Informational Utilities
 - Data Management
 - Operational Utilities

Before you start any of these activities, you should understand the basics of RPASCE: segments, workspaces, views, dimensions, and measures.

Basic RPASCE Concepts

RPASCE is a configurable platform with proven scalability for developing multidimensional forecasting-based and planning-based solutions. This platform provides capabilities such as a multidimensional database structure, batch and online processing, a configurable slice-and-dice user interface, a sophisticated configurable calculation engine, user security, and utility functions such as importing and exporting, all on a highly scalable technical environment.

This section introduces you to the following RPASCE concepts:

- [Multidimensionality](#)
- [Dimensions](#)
- [Measures](#)
- [Segments and Workspaces](#)

Multidimensionality

In RPASCE, information is stored and represented based on the multidimensional framework. In a multidimensional database system, data is presented as a multidimensional array, where each data value is contained within a cell accessible by multiple indexes.

Multidimensional database systems are a complementary technology to entity relational systems and achieve performance levels above the relational database systems. Applications that run on RPASCE identify data through dimensional relationships. Dimensions are qualities of an item (such as a product, location, or time) or components of a dimension that define the structure and roll up within the dimension.

Dimensions

Dimensions describe the top-to-bottom relationship between different levels in RPASCE. They reflect the dimensions that are set up for your business and used by the merchandising solutions. Dimensions contain levels and levels contain positions. For example, product is a dimension and SKU is a level in the dimension product.

RPASCE supports many alternative dimensions that provide different roll ups and help analyze the data from a different perspective.

Note that, in some parts of this document, dimensions may be referred to as hierarchies and levels as dimensions (which is the old terminology).

Measures

Measures represent the events or measurements that are recorded, while the positions in the dimensions provide a context for the measurement. Measures are defined based on the business rules set in the application. The dimensionality of a measure is configured through the definition of its base intersection, which is the collection of levels (one per appropriate dimension) defining the lowest level at which the information is stored for the measure.

Measure names are completely configurable and typically named using a convention that identifies each component and the meaning of the measure.

Segments and Workspaces

RPASCE stores information in a persistent multidimensional data cache that is optimized for large volumes and dimensional or time series data access requirements, typically required by multidimensional solutions. This central repository is called a PDS (Planning Data Schema). The PDS also includes central definitions of metadata for the solution and provides a single update point.

When you use an RPASCE solution, you interact with the solution through a personal data repository called a workbook or workspace. A workspace contains the subset of the data from the PDS, and its scope is constrained by the access rights available to a user. Workspaces can be built from the RPASCE client or scheduled to be built in a batch process automatically. Workspaces are made up of one or more views. These views display the dimension and measure data of the PDS.

Each workspace is built from a segment, which is a collection of position selections from multiple dimensions. A segment defines the dimensionality and range of a workspace and is created by the planner through a step-by-step wizard process. Each segment can have only one main workspace. The workspace can be rebuilt from a segment in order to synch with the hierarchical changes in the PDS. The format of the workspace is saved with its corresponding segment so that it can be preserved when the workspace associated with the segment is deleted or rebuilt.

Although the data and metadata in the workspace are copied from the PDS, the data remains independent of the data in the PDS.

RPASCE Client

The RPASCE Client is the web-based client for the RPASCE platform, developed using the latest Oracle JavaScript Extension Toolkit (Oracle JET). It delivers an enhanced user experience for the RPASCE platform.

Planning is one of the most important and complex processes in a retail business. It typically involves a set of activities that must be followed as part of a workflow. The RPASCE Client includes an Activity Task Flow feature that provides a robust workflow that makes each planning activity easier to track and maintain.

Administrative Workspaces and Wizards

Using the administration workspaces, designated employees manage other employees' use of RPASCE. System administrators use the administration workspaces to perform the following tasks:

- Set up and maintain users and user groups. The users must be created in the Oracle Cloud Infrastructure Identity and Access Management (OCI IAM) and in the external authentication system must exist in RPASCE so that user access can be managed.
- Manage user access to specific workspace templates and template groups.
- Edit the contents of translation tables to support multiple-language use of the application.
- Set up batch jobs to run on a schedule.

Online Administration Tools

RPASCE Online Administration Tools (OAT) allow the application administrator to manage back-end operations on a application from the RPASCE Client. OAT consists of two parts. The first part is a set of activities in the task flow (which is part of the UI) that allows authorized users to launch and manage back-end processes from the client. The second part is a task status dashboard for an administrator to monitor the status of all the administration tasks after they have been submitted.

Dashboard Settings

The Dashboard Settings functionality is used by an administrator to assign user groups to dashboard profiles. This restricts non-administrative users that are not assigned to the user group from seeing the profile on their dashboard.

2

User Administration

This chapter addresses user administration tasks.

Atomic User Management

Atomic User Management (AUM) simplifies the user management process for RPASCE and allows the customer to maintain RPASCE application users and groups in one place only, namely, OCI IAM. This is outside the application and probably shared by multiple applications belonging to same customer. This feature enables the customer to manage RPASCE application access control in the way customary to most web applications, and in a less error-prone manner.

AUM feature highlights include:

- The customer can create or delete users only in the OCI IAM. There is no need to administer users in the application separately.
- The customer can assign access rights to the users through OCI IAM groups that have matching counterparts in the application.
- The users inherit the access rights from its groups in real time. That is, if a user is moved between groups in OCI IAM, the access rights of the user will change immediately upon the next login.
- The RPASCE administrative users in the application are mapped to a designated group in the OCI IAM. Any user in that OCI IAM group will automatically become an RPASCE administrator when that user logs in. The name convention for this group is {APPCODE}_ADMIN_{ENV}. For example, MFPRCS_ADMIN_PROD is used for the administrative users in the MFPRCS application in production environment.
- When a user logs in, if the user does not exist in the application, the user is automatically created in the application by AUM, with matching group assignments to that in the OCI IAM. If the user's group assignments have changed in the OCI IAM, when the user logs in the next time, the group assignments in the application will be changed to match that in the OCI IAM. If a user's assignment to the designated admin group (that is, {APPCODE}_ADMIN_{ENV}) has changed, its administration user status is also changed accordingly when the user logs in the next time.

The default group for new administration users is set to admin (Administrators), and the default group for other new users is set to the first group of that user in OCI IAM. The default group for the existing user will not change unless the user no longer belongs to it. In this case, it will be set in the same way as for a new user, that is, the first group in OCI IAM.

- The migration tool Migrate User Groups to IDCS is provided via Online Administration Tools (OAT) to assist in migrating the groups and their memberships in the application to the OCI IAM.
- A user maintenance tool Sync Users from IDCS is provided via Online Administration Tools (OAT) to synchronize to the application any authorized users for this application in the OCI IAM.

- The User Manager OAT task Manage User can be used to purge these disabled users.

Note that the access rights of workbook templates and measures are still managed as before in the application through the Security Administration Workbook. It is highly recommended that the customer assign access rights to the groups, not the users, in the application. When a user is assigned to the proper groups in the OCI IAM, that user will automatically inherit the access rights from the groups in the application.

Position security is managed through the Security Administration Workbook in RPASCE, and a user's position security is not inherited from its groups. When a new user logs in for the first time, a message is displayed to indicate that additional security configuration is required.

Deactivation of a user is done only in OCI IAM. When a user is deactivated, that user will no longer be able to log into the RPASCE application. The user can be re-activated in OCI IAM and then will again have the permission to log in.

Setting Up Users and Groups

While the user accounts are managed in OCI IAM, groups are set up in both the application and OCI IAM. Some of these groups must be kept in sync and some are only in OCI IAM or the application.

OCI IAM-Only Groups

There are two groups that must only exist in OCI IAM. One is the application authorized group, which is typically named using the naming convention of {APPCODE}_AUTH_{ENV}. For example, MFPRCS_AUTH_PROD for the authorized group of MFPRCS application in the production environment. A user must be in the group in order to be able to log into the application. The other OCI IAM-only group is the RPAS administration group named using the naming convention of {APPCODE}_ADMIN_{ENV}. For example, MFPRCS_ADMIN_STAGE for the RPASCE administration group in the staging environment of the MFPRCS application. Any users in this group will become RPASCE administrative users in the application when they log into the application. When the application is initially provisioned, a default system user is created and assigned to both groups.

Application-Only Groups

There are two default groups in the application that do not exist in the OCI IAM. One is the default user (Default) group, which is a placeholder group for any logged users who have not been assigned an application group in OCI IAM. The other is the built-in administration group admin (Administration) for any RPASCE administrative users.

Migrate Application User Groups to OCI IAM

When the application PDS is built, a post-install script creates pre-defined application user groups automatically, such as MFPRCS_PLANNERS and MFPRCS_APPROVERS. Instead of manually creating these groups in OCI IAM, the default system user can log into the application and run the Migrate User Groups to IDCS OAT task to create these application user groups in OCI IAM, where they can be assigned to the users for this application.

AUM Utilities

This section describes the AUM utilities.

OCI IAM Migration Tool

The OAT task Migrate User Groups to IDCS can be used to migrate the user groups in the RPASCE application to OCI IAM. It provides the flexibility to perform a dry run before the actual migration of users to OCI IAM. If the Commit Changes option is unchecked, the task will generate a dry run execution report. It is recommended that you generate a report first to detect any potential issues before committing the changes. This OAT task is designed to be able to run multiple times without adverse effects.

⚠ Caution:

This utility should only be run in the initial setup of the application and OCI IAM. The group memberships in the application will overwrite what is in the OCI IAM.

This OAT task is launched from the System Admin Tasks group.

Figure 2-1 Migrate User Groups to OCI IAM Task

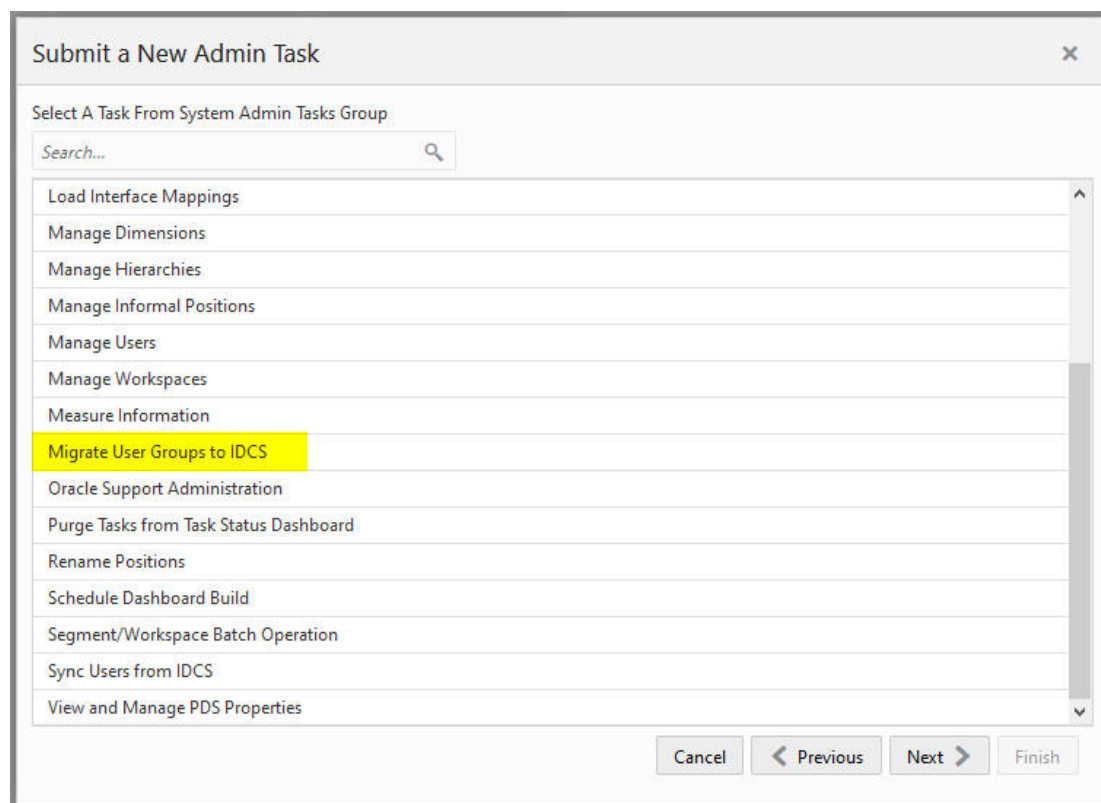
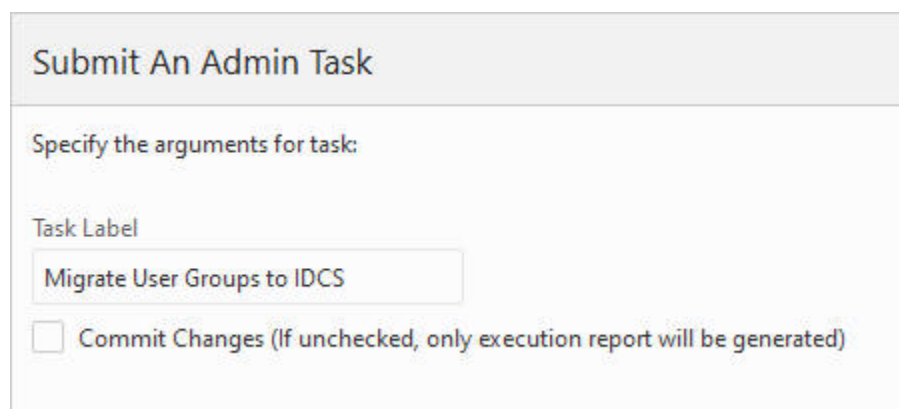

Figure 2-2 Commit Changes for OCI IAM

Submit An Admin Task

Specify the arguments for task:

Task Label

Migrate User Groups to IDCS

Commit Changes (If unchecked, only execution report will be generated)

The following actions are taken using the Migrate User Groups to OCI IAM task.

1. If an RPASCE group does not exist in OCI IAM, create it in OCI IAM with the identical name and label. The name will be in uppercase.
2. If an RPASCE user does not exist in OCI IAM, a warning message will be logged highlighting any users who must be created in OCI IAM to bring RPASCE and OCI IAM in sync.
3. Compare the group memberships of the application and the OCI IAM and take the following actions:
 - a. If a user is in a application group but not in the corresponding OCI IAM group, it will be added to the OCI IAM group.
 - b. If a user belongs to a group in OCI IAM, but not to the corresponding group in the application, it will be removed from the group in OCI IAM.
4. For RPASCE administrative users, assign them to the RPASCE administration group in OCI IAM that is designated by an environment variable. (The naming convention of such group is {APPCODE}_ADMIN_{ENV}, for example, MFPRCS_ADMIN_PROD.) Any non-admin user in the application will be removed from that OCI IAM admin group. This OCI IAM admin group must not exist in the application. For more details about the environment variable, refer to the Implementation Guide of the relevant RPASCE application.
5. For all RPASCE users in OCI IAM, assign them to the application-authorized group in OCI IAM that is passed by an environment variable. (The naming convention of such group is {APPCODE}_AUTH_{ENV}, for example, MFPRCS_AUTH_PROD.) This application authorized group must be an OCI IAM-only group and must not be in the application. For more details about the environment variable, refer to the Implementation Guide of the relevant RPASCE application.

Synchronize Users from OCI IAM

A new user can be added to OCI IAM and authorized to access the application. Existing authorized users can be modified. An RPASCE user can be deleted from OCI IAM if the user leaves the organization or the team. The OAT task Sync Users from IDCS is provided to synchronize users from OCI IAM to the application. This task can

be scheduled to run periodically (such as daily or weekly) to keep the obsolete users in check.

This OAT task synchronizes any authorized users in the OCI IAM to the application and takes the following actions:

1. New users created in OCI IAM are added to the application with the same attributes.
 - User name
 - Label
 - Administration status of the user that is determined by the OCI IAM group for RPASCE administration (for example, MFPRCS_ADMIN_PROD).
 - Group memberships for existing application groups.
 - The default group for new administration users is set to admin (Administrators), and the default group for other new users is the set to the first group of that user in OCI IAM.
2. Existing users are modified if they have been changed in OCI IAM. Possible changes include:
 - Label
 - Administration status
 - Group memberships
 - The default group for existing users will not change unless the user is removed from that group in OCI IAM. In this case, it will be changed to the default admin group for the administration user and the first group in OCI IAM for the non-admin user.
3. Application users who are no longer in the OCI IAM authorized group will be marked for deletion.
4. Application users who have been marked for deletion will be restored if they again become members of the OCI IAM authorized group

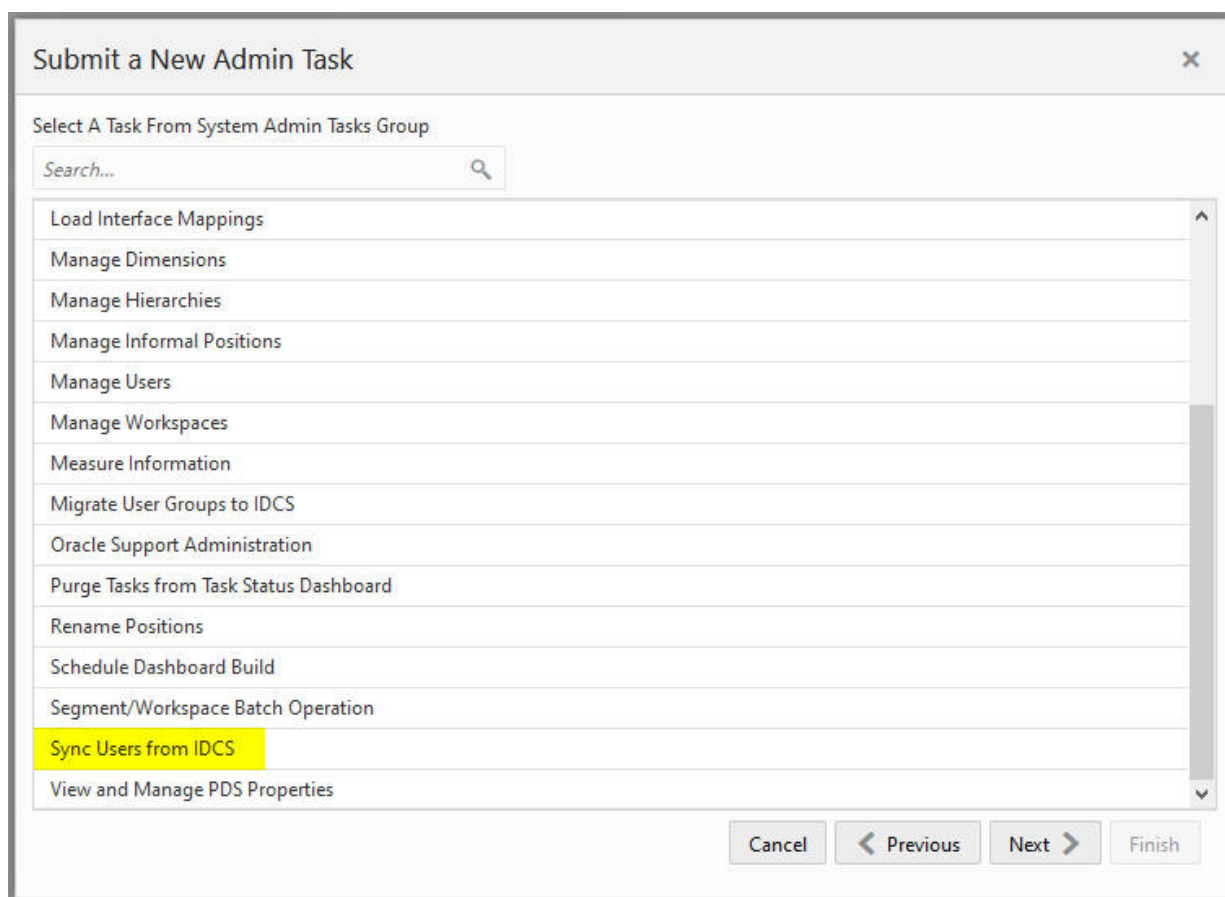
Figure 2-3 Sync Users from OCI IAM Task

Note that this task disables the access of users to the application if they are deleted in OCI IAM or removed from the authorized group for the application in OCI IAM. The task does not remove a user from the application, but only marks the user for deletion. This feature is provided so that the administrator is able to add the user back to OCI IAM and restore the user in the application if the user is accidentally deleted or unauthorized in OCI IAM. The user can be restored in the application by simply logging in again or by running this sync tool again.

For a new user setup, it is recommended that the administrator run this task to create the new users in the application after they are added and/or authorized in OCI IAM. After this, the position security and dashboard can be configured for those new users before their first login.

Managing Users and Groups

The Manage Users OAT Task is used to manage users and groups inside the PDS.

Figure 2-4 Manage Users Task

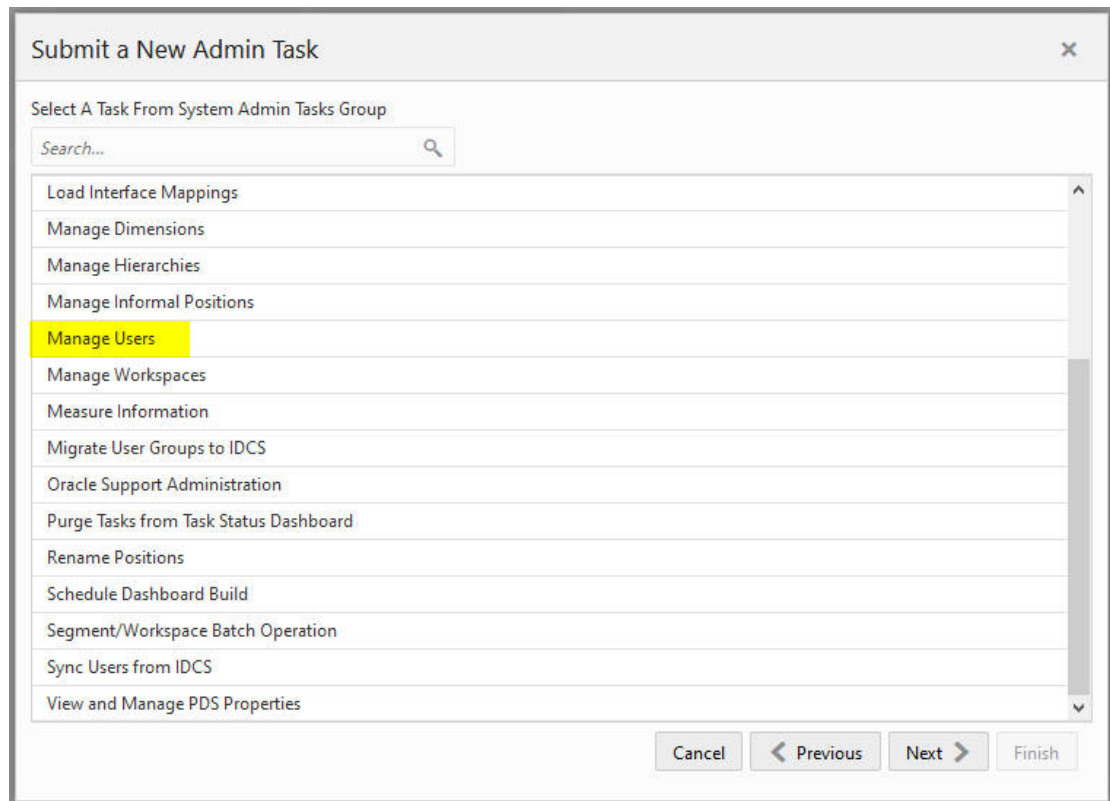

Figure 2-5 Manage User Options

Submit An Admin Task

Specify the arguments for task:

Task Label
Manage Users

Log level
▼

Operations

- List all user groups and users
- Enable/Disable group workbook template rights inheritance for users
- Set default group for a user
- Add a user group
- Remove a user group
- Print detailed info about a user
- Print detailed info about a group
- Purge users marked for deletion

Cancel < Previous Next > Finish

This task provides the following options:

- **List all user groups and users.** This operation lists all groups and users in PDS, including the group rights inheritance status of the users.
- **Enable/Disable group workbook template rights inheritance for users.** By default, a user account inherits the workbook template rights from all the groups to which it belongs, in addition to its own rights. If this behavior is not desirable, it can be disabled or re-enabled on the user level by this operation. When inheritance is disabled, a user account will only use its own workbook template rights.

Figure 2-6 Enable/Disable Group Workbook Template Rights Inheritance for Users

Submit a New Admin Task [X]

Specify the arguments for task:
 Task Label: Manage Users
 Operations: Enable/Disable group workbook template rights inheritance for users
 Select one or more users

Search... [Q]

No selections

- adm(Administrator)
- adm1(Administrator 1)
- adm10(Administrator 10)
- adm2(Administrator 2)
- adm4(Administrator 4)
- adm7(Administrator 7)
- nonadm1(Non-Admin User 1)
- nonadm2(Non-Admin User 2)
- oci.admin(OCI Administrator)
- oracleintuser(Oracle Internal User)

For selected users

- Enable group workbook template rights inheritance
- Disable group workbook template rights inheritance

Cancel < Previous Next > Finish

- **Set default group for a user.** This operation can change the default group of a user. A default group (also known as a primary group) is used for workbook format inheritance. Users can save the workbook format to any of the groups they are members of; they can only pick up formats from their default group.

 **Note:**

The user must belong to the selected group in OCI IAM for this operation. Otherwise, the default group will be reset to the first group in OCI IAM that the user belongs to when the user logs in or when the Sync Users from IDCS OAT task is run.

- **Add a user group.** This operation creates a new user group in PDS. A corresponding group with the same name must also exist in OCI IAM in order to support AUM.
- **Remove a user group.** This operation deletes a selected user group from PDS. Note that only groups without any members designating them as a default group can be removed.
- **Print detailed info about a user.** This operation prints out detailed information for a selected user.

- **Purge users marked for deletion.** All users deleted or unauthorized from OCI IAM will be marked for deletion after the Sync Users from IDCS task is run. In order to permanently purge the users marked for deletion from the application along with their workbooks for security compliance or to reclaim space, the operation must be used. A purge age in days parameter is available to control the purging of earlier-deleted users. The purge age refers to the time since the user was marked for deletion by the Sync Users from IDCS OAT task. Note that a user cannot be purged if any of the user's workspaces is shared. In such cases, their shared workspaces must be taken care of before the user is purged.

Figure 2-7 Purge Age in Days

The screenshot shows a web interface for submitting an admin task. At the top, there is a header "Submit An Admin Task". Below this, the text "Specify the arguments for task:" is displayed. The task is identified as "Task Label: Manage Users" and the operation is "Operations: Purge users marked for deletion". A parameter "Purge age in days" is shown with a text input field containing the value "30".

3

Planning Data Schema Administration

This chapter describes the administration tasks for the Planning Data Schema (PDS).

Introduction

The Planning Data Schema (PDS) consists of multiple database schemas residing on an Oracle Database server: a main schema (internally called a data mart schema) and multiple access schemas. The data mart schema contains all the dimension and fact tables that store all application data. The data mart schema also contains metadata tables, PL/SQL packages, procedures and functions, as well as other database objects. Access schemas are user schemas that are granted necessary privileges to access database objects in the data mart schema.

From RPASCE Version 19 to Version 21, the Planning Data Schema (PDS) has evolved from an optional data integration component into a powerful integration/calculation engine that can support multiple applications such as MFP, IPOCS-Demand Forecasting, and ASCS. [Figure 3-1](#) provides a high level graphical description of the system architecture.

Figure 3-1 PDS System Architecture

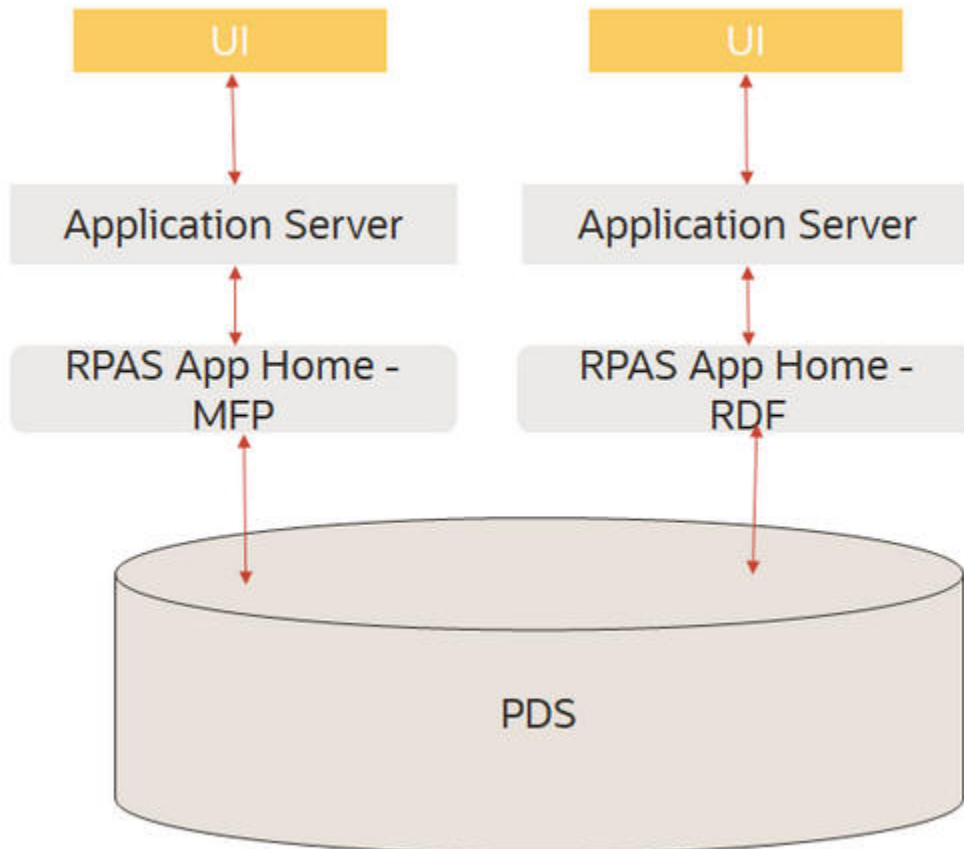

The diagram shows two RPASCE applications, MFP and IPOCS-Demand Forecasting, accessing a shared data mart schema. All RPASCE internal processes (except workbook calculations) communicate with PDS to perform their operations. For example, workbooks are built from and committed to PDS, batch calculations run inside PDS, and so on.

The data of retail business is multi-dimensional by nature, with typical dimensions including Product, Location, Calendar, Supplier, and so on. In the data mart schema, we use the data model called a de-normalized snowflake schema, which is built from the applications' configuration. Figure 3-2 shows a sample Entity Relationship Diagram (ERD) of the data model.

Figure 3-2 PDS Entity Relationship Diagram

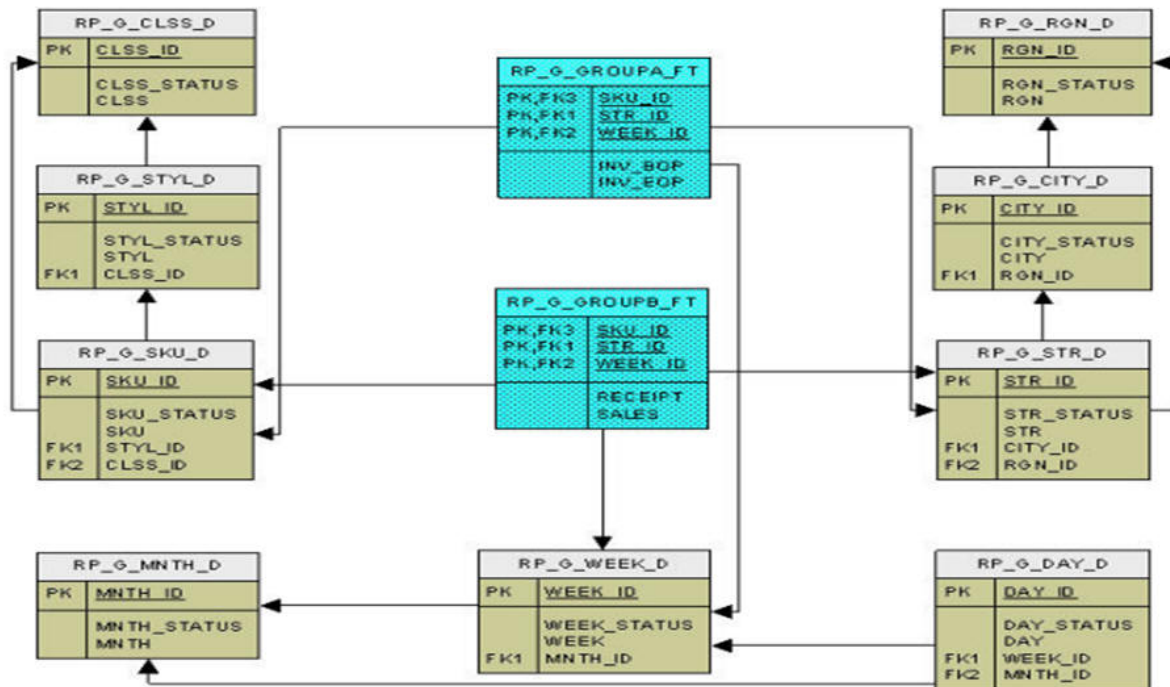

The ERD shows two fact tables and their parent dimension tables (including all the roll-up dimension tables). The data model is a snowflake (as opposed to star) because there is a dimension table for each dimension level. It is de-normalized because each dimension table contains all the higher levels (not just the immediate parent). The data mart schema may contain hundreds of such snowflakes.

Because of the highly configurable nature of RPASCE applications (dimensions, measures, rules, workbook templates, and so on, are configured), the data mart schema is dynamically created, that is, dimension tables and fact tables are dynamically created from the application configuration. The data mart schema also contains a fixed set of metadata tables whose content is dynamically populated with application metadata. Batch calculation rules are dynamically translated into PL/SQL blocks and stored in PDS for IN-DB calculations.

Configuration

In RPASCE Version 21, PDS is built from application configurations. Unlike V19, there is no separate PDS configuration. The users only need to work on application configurations. For details, see *Oracle Retail Predictive Application Server Cloud Edition Configuration Tools User Guide*. The deployment process internally generates the PDS schema configuration from the application configurations that specify all application dimensions, facts (and mapping between the application measures and facts), and all the necessary metadata required to create all tables, and populates the metadata tables with the application configuration information.

Once an application is deployed, the PDS contains complete information about the application. Unlike V19, the traditional RPASCE application is not required and is no longer built.

When there are changes to the configuration after the application is deployed, the application can be patched. (See details in "[Patch PDS](#)".)

Partitioning

In the Planning Data Schema (PDS), fact tables are partitioned. Proper partitioning is crucial for optimal performance. The concept of partitioning PDS is inherited from the previous versions of RPASCE, but in Version 22, it is easier for the administrators. Now, the level DEPT of dimension PROD is the partitioning level. All fact tables with PROD dimension level at or below DEPT are automatically partitioned, with one DEPT in each database partition. With the automatic partitioning, the administrators are not involved in partitioning configuration at all.

A sample `partitioninfo.xml` is as follows:

```
<?xml version="1.0" encoding="utf-8"?>
<rpas>
  <partitiondim>pgrp</partitiondim>
  <rdm-partitions>
    <partition id="1">9,10</partition>
    <partition id="2">11</partition>
    <partition id="3">12</partition>
    <partition id="4">13</partition>
    <partition id="5">14</partition>
    <partition id="6">15</partition>
    <partition id="6">16</partition>
  </rdm-partitions>
</rpas>
```

All tags are required. The tag `<partitiondim>` defines the partitioning level; `<partition>` defines each partition, with the required `id` attribute that identifies the partition and a comma-separated list of positions in each partition. The above sample file defines six partitions. New partitions are automatically added when new positions that are not in `partitioninfo.xml` are loaded, with one partition per new position.

General guidelines for partitioning configuration are as follows:

- Choose the partitioning dimension level to minimize (or eliminate) aggregation across the partitioning level for batch calculations. This is a limit on how low the partitioning level can be. For example, level CLSS may not be a good choice for MFP because the batch calculations aggregate from below to above CLSS).

- Try to make the size of partitions as even as possible. The configurator is expected to have some knowledge about the application data volume.

Building PDS

To build PDS for an application, users must have the application configuration and `partitioninfo.xml` uploaded to the Object Storage. In addition, the input files for dimensions and facts should optionally be loaded. For details, see *Oracle Retail Predictive Application Server Cloud Service Implementation Guide*.

PDS can be built from the UI by completing the following steps:

1. From Online Admin Tools > Submit a New Admin Task, select Bootstrap Tasks, as shown in [Figure 3-3](#).

Figure 3-3 Bootstrap Tasks

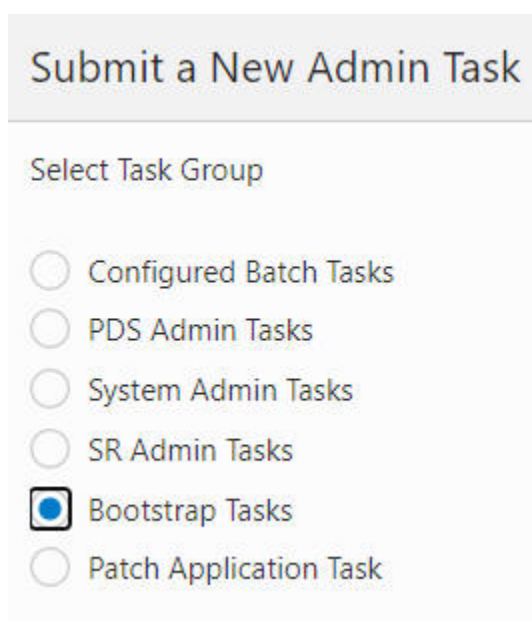

Submit a New Admin Task

Select Task Group

- Configured Batch Tasks
- PDS Admin Tasks
- System Admin Tasks
- SR Admin Tasks
- Bootstrap Tasks
- Patch Application Task

2. Select Build Application, as shown in [Figure 3-4](#), and click **Next**.

Figure 3-4 Build Application

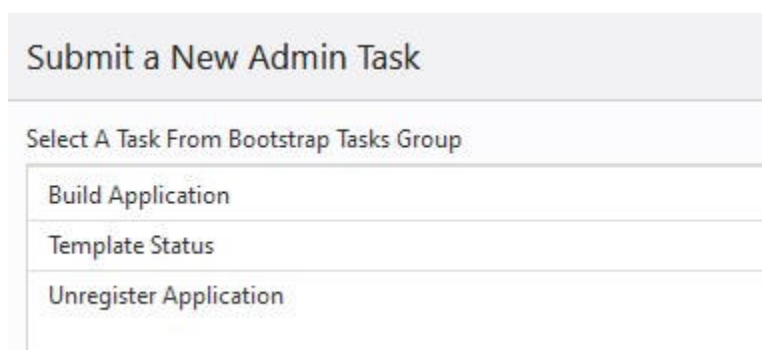

Submit a New Admin Task

Select A Task From Bootstrap Tasks Group

Build Application
Template Status
Unregister Application

3. Provide the parameter values, as shown in [Figure 3-5](#), and click **Next** to schedule or run the task.

Figure 3-5 Build Application Parameters

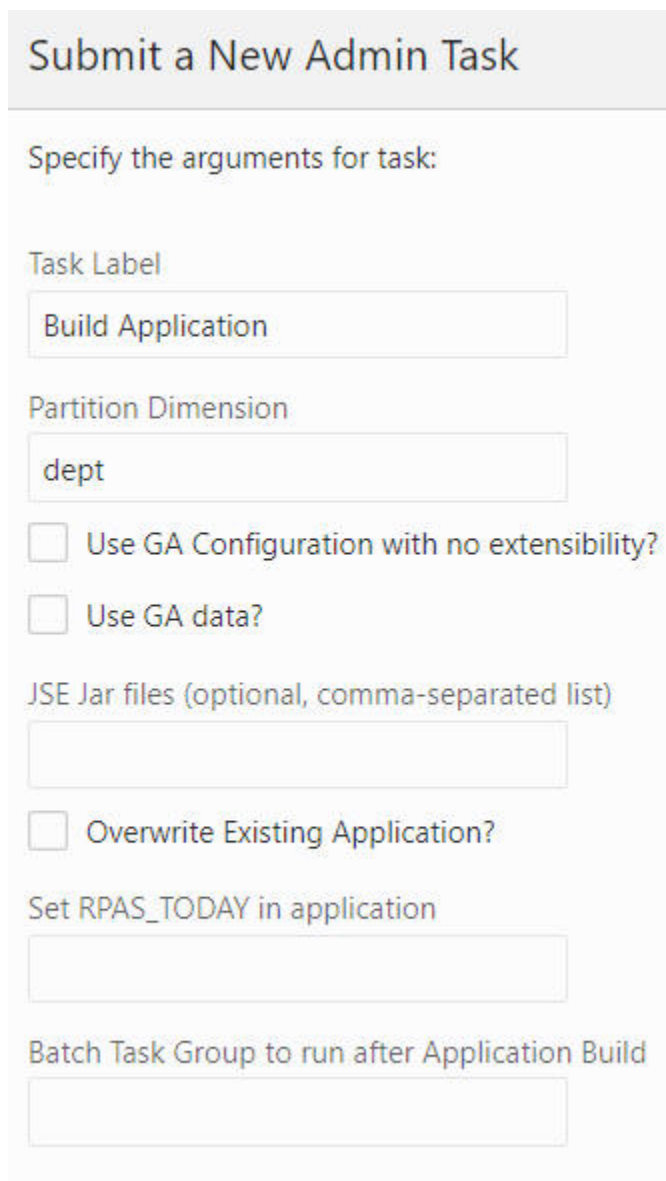

The screenshot shows a web form titled "Submit a New Admin Task". Below the title, it says "Specify the arguments for task:". The form contains several input fields and checkboxes:

- Task Label:** A text input field containing "Build Application".
- Partition Dimension:** A text input field containing "dept".
- Use GA Configuration with no extensibility?
- Use GA data?
- JSE Jar files (optional, comma-separated list):** An empty text input field.
- Overwrite Existing Application?
- Set RPAS_TODAY in application:** An empty text input field.
- Batch Task Group to run after Application Build:** An empty text input field.

4. Select Run ASAP or Run on Schedule and enter the appropriate parameters, as shown in [Figure 3-6](#).

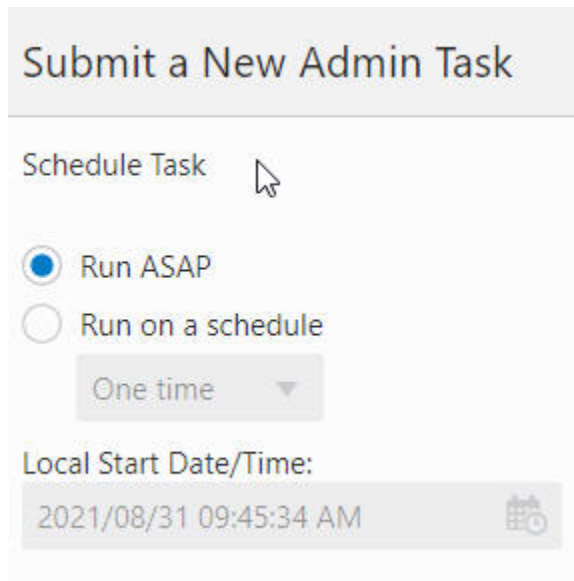
Figure 3-6 Build Application Schedule Parameters

Submit a New Admin Task

Schedule Task 

Run ASAP

Run on a schedule

One time ▼

Local Start Date/Time:

2021/08/31 09:45:34 AM 

Patch PDS

When changes occur in the application configuration, the already-deployed application can be patched. The Patch Application task is designed for this purpose.

To run the Patch Application task, first upload the application configuration <appName>_config.zip, interface.cfg and batch control files to the config folder in the Object Storage.

Then, complete the following steps.

1. From Online Admin Tools > Submit a New Task, select Patch Application Task, as shown in [Figure 3-7](#), and click **Next**.

Figure 3-7 Patch Application Task

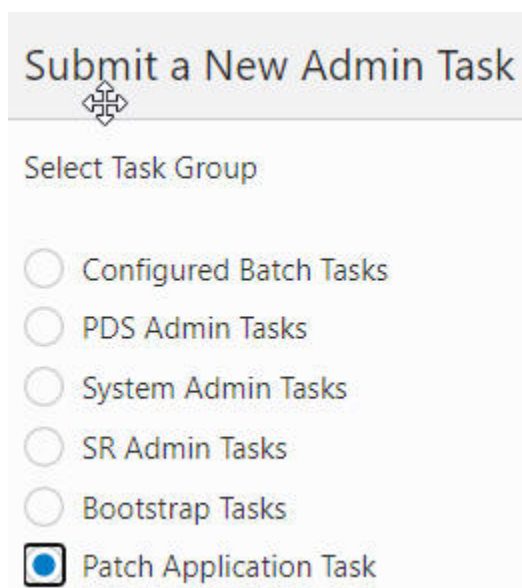

2. Select Patch Application, as shown in [Figure 3-8](#), and click **Next**.

Figure 3-8 Patch Application

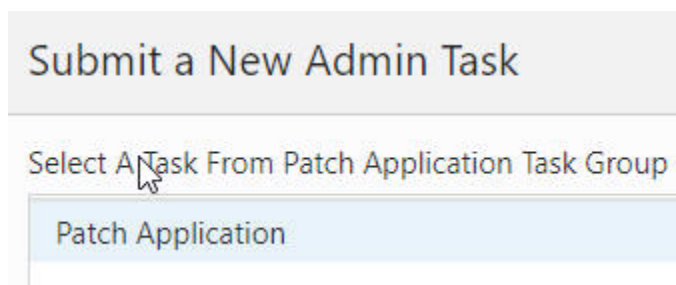

3. Complete the Patch Application parameters, as shown in [Figure 3-9](#), and click **Next** to schedule or run the task.

Figure 3-9 Patch Application Parameters

Submit a New Admin Task

Specify the arguments for task:

Task Label

Offline Mode Message

Log level

Rerun plugins for all template applications (only check if told by support)

Patch with incoming files for all applications (when changes must be applied to multiple applications simultaneously)

Note:

In a multi-application environment, users have the option of selecting the check box Patch with incoming files for all applications (when changes must be applied to multiple applications simultaneously). When this box is checked, the PDS patching process will check for incoming config.zip, interface.cfg, or batch control files, for *all* registered applications, and will use any that are found as part of a simultaneous multi-application patch. This supports multiple possible use-cases where a configuration or interface.cfg change must be applied to multiple application configurations in the same operation to avoid conflicting fact intersection or interfaces, for example. When this check box is unselected, only the current application is patched with its new incoming files.

Patch Dry Run Report Generation

Patch operation can be time consuming and can block a customer environment for an extensive length of time. In some cases, the change of the configuration is not intentional. Therefore, providing a diff report on various stage of the patch before the actual patch operation can help customer to gauge how much time it will take for the operation and help development to identify a problem if it occurs.

The task will generate following report items:

Type	Detail	Scope
Configuration change report	Compares the current configuration stored in PDS vs the incoming configuration. A report is provided for each application in multi-application environment. The purpose is to capture any configuration differences either by customer, by code update, or by plug-in update.	Per app

Type	Detail	Scope
interface.cfg diff report	Difference between the interface.cfg stored in PDS vs the incoming interface.cfg. Since an interface change can affect a fact grouping decision, it is important to capture any change.	Per app
Batch control calc diff report	Difference between the batch_calc_list.txt stored in PDS vs the incoming batch_calc_list.txt. Since a batch rule change can affect a fact grouping decision, it is important to capture any change.	Per app
Create integration config	This is a log of the operation that generates the integration configuration from all applications. If an error occurs in the configuration, it will produce an error at this step.	Global
Fact grouping report	This is a report on how the facts are grouped. This report is originally generated by the above step and is exposed as an individual item from the task tree.	Global
Sandbox verification	A small process to validate the configuration to ensure the application can be built.	Per app
Patch PDS dry run report	Lists the operations to convert the current PDS structure to the expecting structure.	Global

To submit the Patch Application Dry Run Report task, complete the following steps:

1. From Online Admin Tools > Submit a New Task, select **Patch Application Task**, as shown in figure below, and click **Next**.

Figure 3-10 Patch Application Task

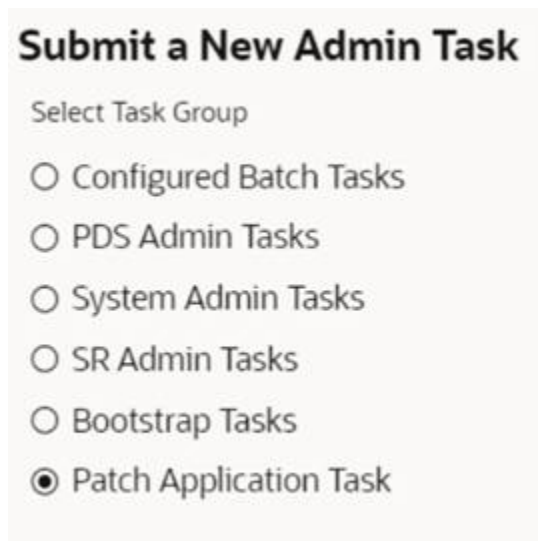

2. Select the Generate Patch Application DryRun Report Task, as shown in the figure below, and click **Next** to submit the task.

Figure 3-11 General Patch Application Dry Run Report

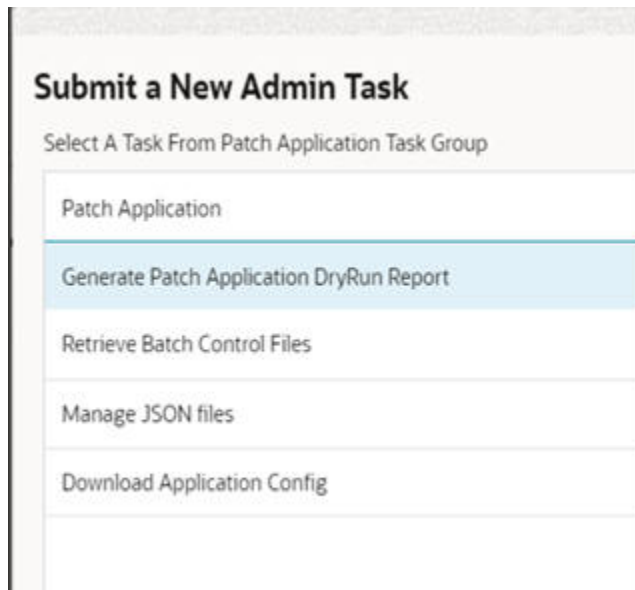

3. The following sub-tasks can be seen within the Generate Patch Application DryRun Report Task.

Figure 3-12 Task Status

Task Status > Generate Patch Application DryRun Report

Actions View Refresh Detach Auto-Refresh Download Log Watch Live Log Download Rejected Records

Application	Description	Status	Task Type
Merchandise Financial Planning (mfpscs)	Patch PDS dry run report	Success	PatchPdsReport
Merchandise Financial Planning (mfpscs)	Sandbox verification for mfpscs	Success	RpasInstall
Merchandise Financial Planning (mfpscs)	Fact group report	Success	FactGroupReport
Merchandise Financial Planning (mfpscs)	Create Integration Config	Success	RpasInstall
Merchandise Financial Planning (mfpscs)	mfpscs interface cfg diff report	Success	IntfDiffReport
Merchandise Financial Planning (mfpscs)	mfpscs batch calc diff report	Success	CalcDiffReport
Merchandise Financial Planning (mfpscs)	Validate configuration for /rpsce/customer/mfpsc	Success	Validate Configuration
Merchandise Financial Planning (mfpscs)	Generate configuration for mfpscs	Success	Auto-Generate Configuration

Post Build Steps

This section describes the following tasks:

- Check PDS
- List PDS Status
- Create Reporting Views in PDS
- Load Dimension Data
- Load Fact Data
- PDS Manager

Check PDS

Use the Check PDS task to obtain diagnostic information from PDS. The user can select one of the following operations to perform.

Run validation checks on a specified hierarchy

The user must provide the hierarchy for the validation to be conducted. As shown in [Figure 3-13](#) and [Figure 3-14](#), the user can provide the dimension level to further limit the validation. If the value is left blank, the operation will perform the validation on all dimensions of the hierarchy.

Figure 3-13 Validation Checks on Specified Hierarchy

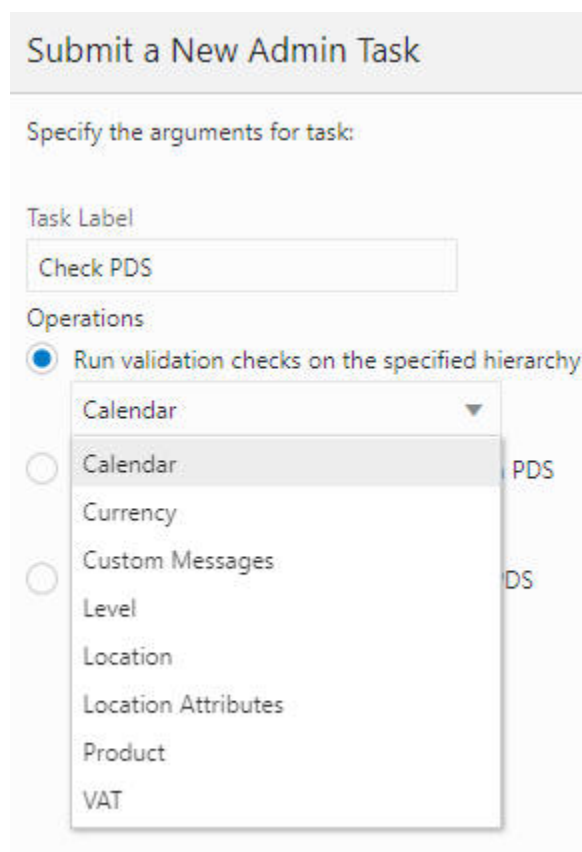

The screenshot shows a web form titled "Submit a New Admin Task". Below the title, it says "Specify the arguments for task:". There is a "Task Label" field containing "Check PDS". Underneath, there is an "Operations" section with a radio button selected for "Run validation checks on the specified hierarchy". A dropdown menu is open, showing a list of hierarchy levels: Calendar, Calendar, Currency, Custom Messages, Level, Location, Location Attributes, Product, and VAT. To the right of the dropdown, the text "PDS" and "DS" are visible, likely indicating the context or scope of the validation.

Figure 3-14 Calendar Arguments for Specified Hierarchy

The screenshot shows a web form titled "Submit a New Admin Task". Below the title, it says "Specify the arguments for task:". The form contains the following text: "Task Label: Check PDS" and "Operations: Run validation checks on the specified hierarchy; Calendar". Below this is a section labeled "Dimension Name" with a dropdown menu. The dropdown menu is open, showing a list of options: Day, Event, Half, Holiday, Month, Quarter, STD/BTA, and Week. The "Day" option is currently selected.

Print the dimension tree of a hierarchy in PDS

This operation prints the dimension tree using the PDS hierarchy information. The user is required to select the hierarchy to be printed, as shown in [Figure 3-15](#).

Figure 3-15 Print Dimension Tree

The screenshot shows a web form titled "Submit a New Admin Task". Below the title, it says "Specify the arguments for task:". There is a text input field for "Task Label" containing "Check PDS". Under "Operations", there are two radio button options. The first is "Run validation checks on the specified hierarchy" with a dropdown menu showing "Calendar". The second is "Print the dimension tree of a hierarchy in PDS", which is selected with a blue dot. Below this selected option is a larger dropdown menu with a scroll bar, listing "Calendar", "Currency", "Custom Messages", "Language", "Level", "Location", "Location Attributes", and "Product".

Check the rollups of all the positions in PDS

This operation is used to detect rollup corruption at dimension/level. As shown in [Figure 3-16](#) and [Figure 3-17](#), the user must first provide the hierarchy name and select the dimension for the validation. If the Check All option is enabled, the operation will perform the same rollup validation for all the dimensions that are rollups from the selected dimension. For example, if Day is selected and Check All is enabled, then, in addition to the Day dimension, Month, Quarter, Half, and so on, will also be validated.

Figure 3-16 Check PDS Rollup

The screenshot shows a web form titled "Submit a New Admin Task". Below the title, it says "Specify the arguments for task:". There are three sections:

- Task Label:** A text input field containing "Check PDS".
- Operations:** Three radio button options:
 - Run validation checks on the specified hierarchy (with a "Calendar" dropdown menu).
 - Print the dimension tree of a hierarchy in PDS (with a "Calendar" dropdown menu).
 - Check the rollups of all the positions in PDS (with a dropdown menu showing a list of categories: Calendar, Currency, Custom Messages, Language, Level, Location, Location Attributes, and Product).

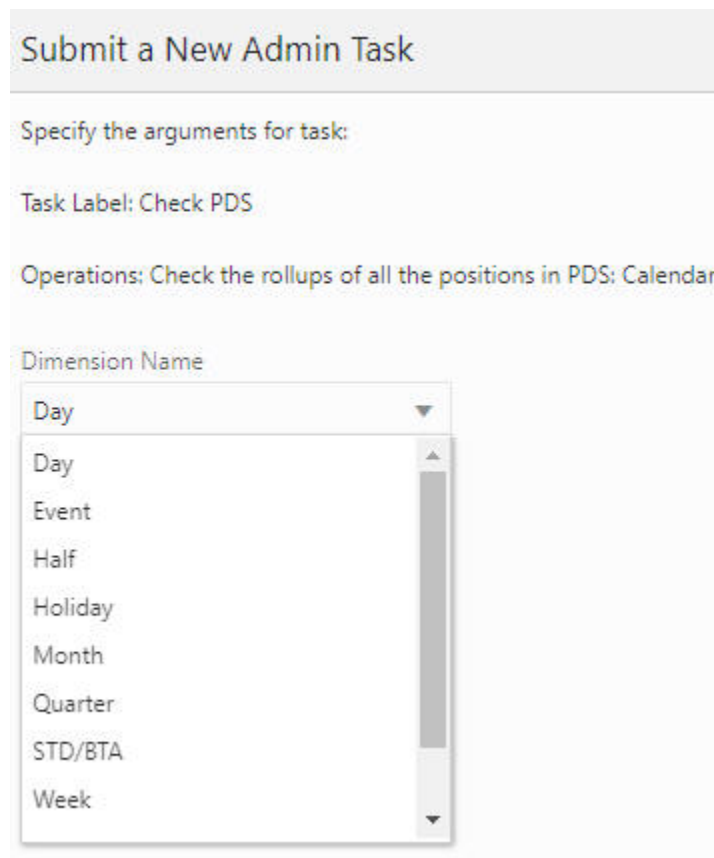
Figure 3-17 PDS Rollups for Calendar

Submit a New Admin Task

Specify the arguments for task:

Task Label: Check PDS

Operations: Check the rollups of all the positions in PDS: Calendar

Dimension Name

- Day
- Day
- Event
- Half
- Holiday
- Month
- Quarter
- STD/BTA
- Week

List PDS Status

The List PDS Status task, shown in [Figure 3-18](#), does not have any additional parameters. It provides the current state of PDS regarding operation and application consistency.

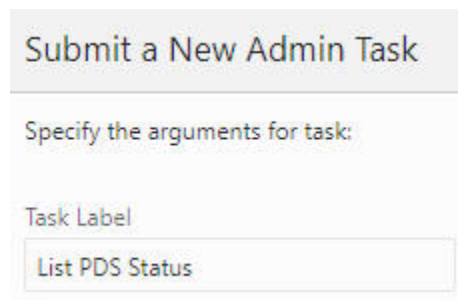
Figure 3-18 List PDS Status

Submit a New Admin Task

Specify the arguments for task:

Task Label

List PDS Status

It has following status codes:

- 1001 - Hierarchy load in one of the applications is in progress.

- 1002 - PDS dimension loading is in progress.
- 1004 - PDS re-partition is in progress.
- 1005 - PDS fact data loading is in progress.
- 1006 - Data is being transfer from one of the applications to PDS. (Obsolete)
- 1007 - Translation loading is in progress.
- 1008 - One of the application registrations is in progress.
- 1009 - One of the application un-registrations is in progress.
- 2001 - There are mismatch positions between one of the applications and the PDS.
- 2002 - PDS repartition is required.

Create Reporting Views in PDS

This operation is used to create database views for facts that can be selected. The views are used by Oracle Analytic Server (OAS) for data visualization/reporting. The facts, as shown in the OAT task [Figure 3-19](#), are configured with Report Categories. (See *Oracle Retail Predictive Application Server Cloud Edition Configuration Tools User Guide* for details.) Note that the facts in the drop-down list are shown by their labels, which are created at configuration time. Navigation through various metrics is controlled using the Page numbering or Page Navigation options that are available in the bottom left corner of the screen.

There are two types of fact views that can be created using this OAT task.

The first type is for regular facts such as sales or inventory facts. These views have the naming convention `fact_<reportCategory>_v`. They contain the dimension levels from the facts' base intersection and all rollup levels.

The second type is for attribute measures/facts. They have the naming convention of `attr_<reportCategory>_v`. In RPASCE, the attribute measures/facts can be one-dimensional or two-dimensional. Unlike the views for regular facts, the attribute views only contain the base dimension level of the attribute measures. In OAS, the attribute views are meant to be joined with regular fact views so that the report designers can do grouping/aggregation by various attributes (for example, product size, color).

Figure 3-19 Create Reporting Views in PDS

Submit a New Admin Task

Specify the arguments for task:

Task Label
Create Reporting Views in PDS

Select the metrics you want to report

Search...

<input type="checkbox"/>		1 selected	Show Selected
<input checked="" type="checkbox"/>	AD_DV_Mapping : Lag Ly		
<input type="checkbox"/>	AD_DV_Mapping : Lag Ly		
<input type="checkbox"/>	LP_AP_Inventory : Ap BOP C		
<input type="checkbox"/>	LP_AP_Inventory : Ap BOP R		
<input type="checkbox"/>	LP_AP_Inventory : Ap BOP U		
<input type="checkbox"/>	LP_AP_Inventory : Ap EOP C		
<input type="checkbox"/>	LP_AP_Inventory : Ap EOP R		
<input type="checkbox"/>	LP_AP_Inventory : Ap EOP U		

Page 1 of 11 | K < > X

The same fact labels are used as column names in the OAS UI fact views, as shown in [Figure 3-20](#). The fact labels are used as column names in OAS UI with the following restrictions:

- If the label length is greater than 128 bytes, it will be truncated to 128 bytes (because of column length limit in Oracle DB).
- Double quotes (") will be replaced with a white space, as they are not allowed in column names.
- Duplicate labels are not allowed within a fact view. When a duplicate is encountered, it is truncated to 125 bytes, then a unique sequence number (up to three digits) is appended, in order to make the column name unique.

Figure 3-20 OAS UI Fact View

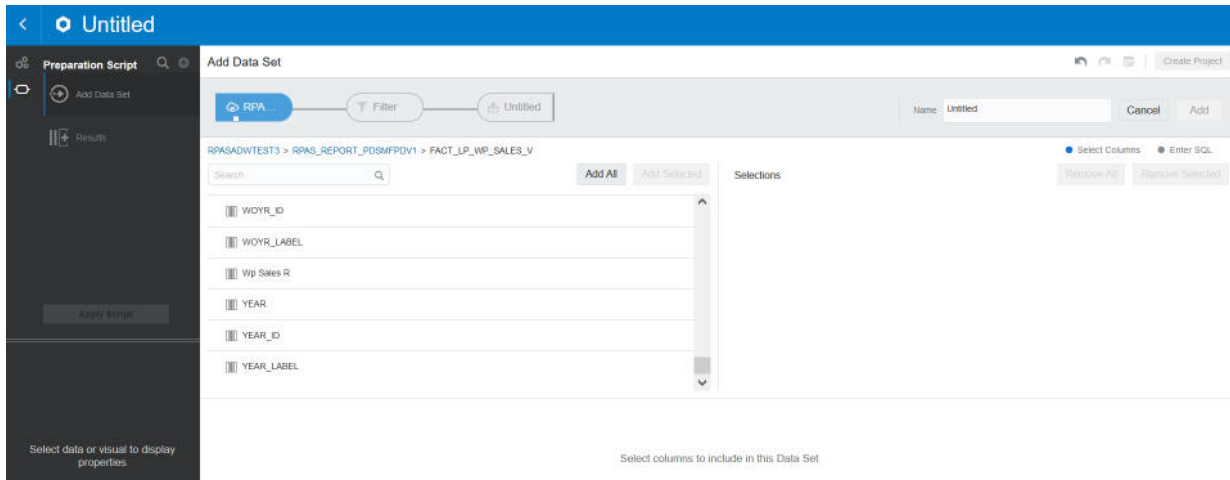

Note:

The columns of the attribute view tables are named after the attribute labels for which those columns contain data. However, the column names must be altered to the following extent: Oracle does not allow a column name that is identical to a keyword in SQL. As an example, the attribute label Size cannot be used as a column name because Size is an SQL keyword. In cases where an attribute label happens to be identical to a SQL keyword, the underscore character '_' will be added to the end of the column name. For our example attribute Size, the column users of OAS will instead see SIZE_.

Due to the way OAS generates SQL queries on the Oracle Database, in order to pull data for reports, the column names will all be forced to upper case. While this is an inconvenience for users of OAS, it avoids a issue in which the use of mixed case can result in OAS generating bad queries that cause errors when attempting to pull data from the Planning Data Store. For example, the attribute name Color will appear as a column in OAS as COLOR.

Load Dimension Data

After the PDS is built, the user must load the dimension data and/or fact data to make PDS fully operational. Dimension data can be loaded from flat files.

Loading Dimension Data

Prepare the flat files and place them in the Object Storage under "<SubNamespace>/planning/incoming/input. See *Oracle Retail Predictive Application Server Cloud Service Implementation Guide* for details regarding uploading and downloading batch files to the Object Storage.

Load Dimension Data, shown in [Figure 3-21](#), is used to load hierarchy information into the PDS from one or more flat files.

Figure 3-21 Load Dimension Data

The screenshot shows a web form titled "Submit a New Admin Task". Below the title, it says "Specify the arguments for task:". The form contains several fields and options:

- Task Label:** A text input field containing "Load Dimension Data".
- Enforce new hierarchy roll-up changes:** An unchecked checkbox.
- Language for the labels:** A dropdown menu.
- Specify the purge age in days:** A dropdown menu.
- Operations:** Two radio button options:
 - Loads and refreshes the specified dimension. Below this is a dropdown menu with "Calendar" selected.
 - Loads all dimensions.

Options

- **Language for the labels.** Sets the language for the labels provided in the flat file. The default is English.
- **Enforce new hierarchy roll-up changes.** When an incoming flat file contains only partial hierarchy data, it is possible that the data has different rollup positions than the records in PDS. Use this option to enforce the rollup from the flat file and apply it to all instances in PDS. If this option is not checked, the task will fail if it detects different rollups in the incoming file and in the records in PDS.
- **Specify the purge age in days.** Use to auto purge records that have not been seen from the load file by the number of days specified in this field. If a value is not specified, the purge age defined by the configuration will be used.
- **Operations.** Choose between loading a particular dimension (the dimension file must exist) and loading all dimensions. This allows the system to load the dimensions if the corresponded data files have been uploaded.

 **Note:**

When the Load Dimension Data Task is called in dimension/hierarchy load mode, it will look for unarchived data files with the following names in the following order: <dim>.csv.dat.*, <dim>.hdr.csv.dat.*. But if the ALL dimensions option is selected, it will look for an archive with name planning/incoming/input/dimdata.zip from the Object Storage. If it exists, it will be extracted and all files that match the mentioned pattern will be loaded to the designated dimension.

 **Note:**

Virtual dimension/hierarchy cannot be explicitly loaded using the Load Dimension Data task.

 **Note:**

Position names are case insensitive. For example, SKU's AB1234GH and ab1234gh are considered as the same SKU.

 **Note:**

Records can be rejected from the data source file for various reasons. Some are just warnings, such as invalid position name, missing fields, duplicate records, and so on, and will not stop the loading process. However, if the records are causing rollup conflicts, then the process will stop and the problem records will be reported as rejected records. These rejected records will be available for download on the OAT dashboard. See Appendix A "Troubleshooting".

Load Fact Data

Use this task, shown in [Figure 3-22](#), to load measure data into the PDS from flat files. Once present in the PDS, this data is available to any application that shares that measure throughout PDS. Prepare the flat files and place them in the Object Storage under "<SubNamespace>/planning/incoming/input. See *Oracle Retail Predictive Application Server Cloud Service Implementation Guide* for details regarding uploading and downloading batch files to the Object Storage.

The format of the data file must be CSV with a header line.

Multiple facts in the same fact base intersection, regardless of whether they are shared or non-shared measures, can exist in one data file.

The header line must contain the names of the fact base dimension, and the names of facts. The dimension names are listed in the order of their hierarchies. The non-shared measures must have their names prefixed with the fact prefix override.

For example, the input file of dh10wd2x.csv.rpl contains loading data for facts ut_dh10wd21n, ut_dh10wd21l, ut_dh10wd31n, and shared fact dh10wd31l.

```
sku,str,ut_dh10wd22n,ut_dh10wd22l,ut_dh10wd21n,ut_dh10wd21l,ut_dh10wd31n,ut_dh10wd31l
sku_22200001,str1000,A01_B01,A01_B01,SK_ST1000,SK_ST1000,WORLD,WORLD
sku_22200001,str0959,A03_B03,A03_B03,SK_ST0959,SK_ST0959,INDIA,INDIA
sku_22200003,str1000,A01_B01,A01_B01,SK_ST1000,SK_ST1000,WORLD,WORLD
```

Administrators must pay close attention to the extension of the input file. RPASCE supports the following types of loads (identified by file name extension):

- .ovr (Overlay): Existing values in the measure are overlaid with the values in the input file. Any values not included in the input file are not changed.

 **Note:**

For string type measures, an empty cell in the .ovr file is treated as a valid string; as a result, the Load Fact Data task overwrites the previously loaded string with an empty string. For other measure types, an empty cell in the .ovr file is treated as invalid data. It is discarded and the previously loaded value is retained.

- .rpl (Replace): The existing data for the facts specified in the data file is cleared, and the values in the input file are taken as the new values for the facts. Existing values for cells that do not exist in the load file are switched to NA. In other words, all data at the base intersection for the facts are removed before cells are populated with the data from the incoming file.
- .inc (Increment): Increment mode must only be used with numeric measures/facts in which the load file contains incremental values. Therefore, if a cell had a value of 2 and the .inc file provided a value of 3 for the cell, then the new value for the cell is 5 (2 incremented with 3).

The Load Fact Data task allows multiple facts to be loaded from a single file. The multiple facts must have the same base intersection. If the data file contains multiple facts and the option Specify the files to load, all facts (specified in the header line) within the selected data file will be loaded. If a fact is in the header line but does not exist in the application, the corresponding column will be ignored and other facts will be loaded.

If this task skips records for any reason, a warning will be printed out to the log file that can be obtained from the OAT dashboard. The maximum number of skipped records that can be output to the log is 1000. After that, any further reject records will be skipped silently.

Figure 3-22 Load Fact Data

The screenshot shows a web-based form titled "Submit a New Admin Task". Below the title, it says "Specify the arguments for task:". There is a text input field labeled "Task Label" containing the text "Load Fact Data". Below this are two unchecked checkboxes: "Run in Trickle Feed mode" and "Do not clean input files used after load". Under the heading "Operations", there are two radio buttons: "Select the facts to load" (which is selected) and "Specify the files to load".

Options

- Run in Trickle Feed mode. When this mode is enabled, loadFactData will use a transactional type of query for inserting and committing. Data will either be all loaded to the PDS or not loaded at all; a partial load is not permitted. This is intended for small data feeds only.
- Do not clean input files used after the load. By default, data files are removed from the source location. Enable this option to have the file(s) remain at the original location after the load.
- Operations
 - Select the facts. Select the list of facts to load.

Figure 3-23 Facts to Load

Submit a New Admin Task

Specify the arguments for task:

Task Label: Load Fact Data

Operations: Select the facts to load

Select the facts to load

Search...

<input type="checkbox"/>	No selections
<input type="checkbox"/>	Absolute Receipts
<input type="checkbox"/>	Absolute Receipts
<input type="checkbox"/>	Absolute Receipts
<input type="checkbox"/>	Alert GM Max Count
<input type="checkbox"/>	Alert GM Max Count
<input type="checkbox"/>	Alert GM Max Count
<input type="checkbox"/>	Alert GM Min Count
<input type="checkbox"/>	Alert GM Min Count

Page 1 of 53

- Specify the files to load. Select which file to load.

Figure 3-24 Files to Load

Submit a New Admin Task

Specify the arguments for task:

Task Label: Load Fact Data

Operations: Specify the files to load

Select the files

<input type="checkbox"/>	No selections
<input type="checkbox"/>	inv.csv.ovr
<input type="checkbox"/>	meas.csv.ovr
<input type="checkbox"/>	tran.csv.ovr

PDS Manager

Use PDS Manager, shown in [Figure 3-25](#) to perform various PDS operations.

- List the PDS properties. Print the list of properties for PDS.
- List the PDS schema and repository history. Print the history and the schema.
- Physically purge all dimension data. Purge all deleted dimension data and associated fact data from the PDS.

Figure 3-25 PDS Manager

Submit a New Admin Task

Specify the arguments for task:

Task Label

PDS Manager

Operations

- List the PDS properties
- List the PDS schema and repository history
- Physically purge all dimension data that is marked for deletion

Planning Data Schema Default Web Services (through ORDS)

PDS is a common database platform shared by multiple applications. PDS is built with pre-created web services for measure metadata and measure data. The default web services are automatically available after PDS is built. Web services map to the PDS read-only schema in the database and uses Oracle Restful Services.

Apex User Creation

The types of users in Apex are:

- **Workspace Admin** - Responsible for creating workspaces and additional users. This access is only provided to the Oracle/AMS team.
- **RPAS_READ_ONLY_WORKSPACE** - Provides viewer access to the workspaces. This user cannot create additional users. These users can access the default web services. If the customer requires a user to be a rest API developer who can log into and build restful services on the PDS read-only schema, the customer must send email to the Oracle/AMS team.

The Oracle/AMS team shares the base url for the web service during provisioning to the customer. This can be accessed by a user in the OCI IAM with the following group association: **RPAS_ORDS_GROUP** (for example, <https://---wts.oracleindustry.com:443/ords>).

Any users who are not part of the above group will not be able to access the web service. For more fine-grained control, it is possible to create multiple groups and map groups to specific rest urls.



Note:

In order to control access to the restful services to specific groups in OCI IAM, contact your Oracle/AMS Workspace Admin.

Default Web Services

The default web services includes the following data:

- The metadata web service exposes the following metadata for all measures in PDS: application, measure, (mapped) fact, base intersection, and description.
- The web services for fact data provide one web service for each fact in PDS. The fact data is retrieved at the fact's base intersection with position names.

Figure 3-26 shows a high level architectural diagram of PDS (Oracle Database) with ORDS. Web services are accessible from any web service client (a web browser is an example of web client) through an ORDS Listener, which is deployed on a Tomcat server. Within the database, an ORDS enabled read-only schema provides access to the necessary database objects.

Figure 3-26 PDS - ORDS Architecture

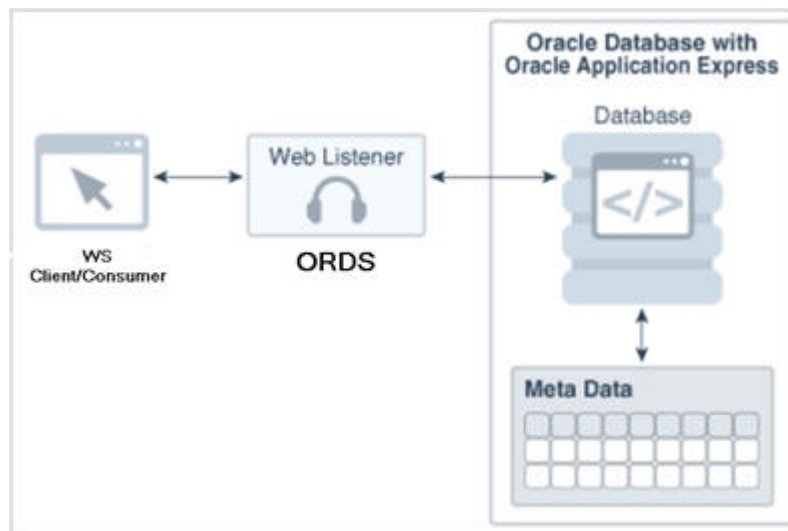

Web Services URL

All web services are available under the base path: <ords_path>/<schema_alias>, where <ords_path> is determined by the ORDS installation/configuration. In production, this value is https://<cust>-<env>-<app>-wts.oracleindustry.com:443/ords and <schema_alias> is pds.

Get Services

Table 3-1 describes the Web Services URL.

Table 3-1 Web Services URL

SI Number	Web Service	Example URL	Description
1	Metadata	<code>https://<cust>-<env>-<app>-wts.oracleindustry.com:443/ords/pds/measures/all/</code>	Web service exposes the following metadata for all measures in PDS: application, measure, (mapped) fact, base intersection, and description.
2	Measure	<code>https://<cust>-<env>-<app>-wts.oracleindustry.com:443/ords/pds/measuredata/<fact_name>/</code>	One web service for each measure in PDS. Measure data is retrieved at the measure's base intersection with position names.

Example Output:

URL for metadata:

`https://cust1-prod3-rpasee-wts.oracleindustry.com:443/ords/pds/measures/all`

URL for fact data:

`https://cust1-prod3-rpasee-wts.oracleindustry.com:443/ords/pds/measuredata/drtynslsregr/`

Filtering

Filtering in the web services is supported through ORDS. To add a filter to a web service, append the parameter `q=FilterObject`, where `FilterObject` is a JSON object that represents the custom selection and sorting.

For the `FilterObject` syntax in ORDS version 19.1, see:

<https://docs.oracle.com/en/database/oracle/oracle-rest-data-services/19.1/aelig/developing-REST-applications.html#GUID-6FDB9F47-EAB9-409B-9CB1-79D79B46AC28>

Table 3-2 provides examples of the `FilterObject`.

Table 3-2 Example URLs

Description	Web Service URL
To select measure metadata for mfp or rdf deployment only.	<code>https://<cust>-<env>-<app>-wts.oracleindustry.com:443/ords/pds/measures/all?q={"deploy_id":{"\$or":{"\$seq":"asc"},"\$seq":"rdf"}}</code>
To select metadata for deployment ID in ("rdf", "mfprcs") and measure name in ("drtyeop1r", "rsal"	<code>https://<cust>-<env>-<app>-wts.oracleindustry.com:443/ords/pds/measures/all?q={"deploy_id":{"\$or":{"\$seq":"rdf"},"\$seq":"mfprcs"}}, "measure":{"\$or":{"\$seq":"drtyeop1r"},"\$seq":"rsal"}}</code>
To retrieve measure data for a given week and sku.	<code>https://<cust>-<env>-<app>-wts.oracleindustry.com:443/ords/pds/measuredata/drtyeop1r?q={"week":"w01_2017","sku":"1000466"}</code>

Pagination

Data is returned in pages, with a page size of 100. This means that each web service call returns 100 rows. To retrieve additional data, append ? offset parameter.

For example, the url for the first page (first 100 rows) of rsal data is

<https://cust1-prod3-rpasee-wts.oracleindustry.com:443/ords/pds/measuredata/rsal>

and the url for the second page is

<https://cust1-prod3-rpasee-wts.oracleindustry.com:443/ords/pds/measuredata/rsal/?offset=100>

PUT Services

RPASCE also offers the PUT (write) web service that allows customers to write/update source facts in PDS. *Source facts* are the facts that are usually loaded (not calculated) whose mapping measures are flagged in the application configuration.

See the last column on the right in [Figure 3-27](#) for source facts.

Figure 3-27 Integration Configuration

Measure Name	Load Intersection	Clear Intersection	File Name	Start Position	Column Width	Load Aggregate	Shared Fact Name	Shared Fact Base	Source Fact
DRWHOOU	#Merch_Pln#		wh_oo	54	8		DRWHOOU	#Merch_Pln#	true
DRTYWFSbC	#Act_Load_Int#		wfms	54	20		DRTYWFSbC	#Act_Load_Int#	true
DRTYMS2R	#Act_Load_Int#		frfil_x	54	20	total	DRTYMS2R	#Act_Load_Int#	true
DRTYBOS1U	#BOS_Intx_Int#		bos	46	20	total	DRTYBOS1U	#BOS_Intx_Int#	true
DRTYRmRegR	#Act_Load_Int#		rtm	74	20	total	DRTYRmRegR	#Act_Load_Int#	true
DRTYMTD2R	#Act_Load_Int#		frfil_x	54	20	total	DRTYMTD2R	#Act_Load_Int#	true
DRTYTranOutC	#Act_Load_Int#		trans	254	20	total	DRTYTranOutC	#Act_Load_Int#	true
MPCPRm1U	#Merch_Pln#		mpcpet1u	54	20		MPCPRm1U	#Merch_Pln#	true
ADDVLocAnT	stor_satt		addvlocatt	41	8		ADDVLocAnT	stor_satt	true
DRWHEOP1C	#Merch_Pln#		wh_eop	54	8		DRWHEOP1C	#Merch_Pln#	true
DRTYTranOutU	#Act_Load_Int#		trans	234	20	total	DRTYTranOutU	#Act_Load_Int#	true
DRTYSTC2U	#Act_Load_Int#		frfil_x	54	20	total	DRTYSTC2U	#Act_Load_Int#	true
MPCPSb1U	#Merch_Pln#		mpcpsb1u	54	20		MPCPSb1U	#Merch_Pln#	
DRTYMS2U	#Act_Load_Int#		frfil_x	54	20	total	DRTYMS2U	#Act_Load_Int#	
MPCPSb1R	#Merch_Pln#		mpcpsb1r	54	20		MPCPSb1R	#Merch_Pln#	
MPCDct131T	#Merch_Pln#		mpcdct131t	54	20		MPCDct131T	#Merch_Pln#	

Example URL for PUT service below.

<https://<cust>-<env>-<app>-wts.oracleindustry.com:443/ords/pds/putfact/data/>

The payload of the web service will be in a JSON format that can support input data for a fact at any intersection.

Here is a sample JSON file.

```
{
  "fact_names": ["DRTYEOP1C"]
  "intersection": ["week", "stor", "sku"]
  "data_rows": [
    ["w01_2017", "900002", "1005", 1],
    ["w01_2017", "900002", "1008", 1]
  ]
}
```

```
}  
    ]
```

OCI IAM Authorized Access to PDS Web Services in Apex/ORDS

This section provides details about using the REST API call to Oracle Identity Cloud Service to interact with APEX/ORDS to access planning data schema web services. The example shows how the REST API calls are typically executed in Oracle Identity Cloud Service.

The REST APIs provide a way to integrate Oracle Identity Cloud Service with custom applications and clients that support REST, such as Java, C#, Go, Python, or Ruby apps.

Requirements

This tutorial uses Oracle Linux 7.2. It can be executed on other operating systems with a bash terminal (such as Red Hat, Ubuntu, or OSX), or in Windows (using a bash emulator such as git bash). The commands may have small variations on different operating systems. It is recommended that you are familiar with the REST architecture style.

- Access to Oracle Identity Cloud Service with authorization to manage Applications (Identity Domain Administrator, Security Administrator, or Application Administrator).
- A Linux machine with cURL utility available.
- Credentials - Contact an Oracle cloud administrators if you do not have access to the following credentials.
 - IDCS-client-id
 - IDCS-client-secret
 - IDCS-tenant-id
 - IDCS_URL
 - Userid
 - Password

Get Bearer Token

The `access_token` (Bearer) identifies your client access in Oracle Identity Cloud Service and will be used for subsequent REST API calls. This token is encoded following the JSON Web Token (JWT) standard. Replace the following credentials with the correct values for your environment.

```
curl -i -u "<IDCS-client-id>":<IDCS-client-secret>" \  
https://<idcs-tenant-id>.<IDCS_URL> \  
-H 'Content-Type: application/x-www-form-urlencoded' \  
-H 'Host: <idcs-tenant-id>.<IDCS_URL>' \  

```

```
-d 'grant_type=client_credentials' -d 'scope=urn:opc:idm:__myscopes__'
```

Example Bearer Token Rest Call

```
curl -i -u "a3399f80531e4eff82637f0ba5c7d49d":"d3e376c2-d5fb-4d3b-b2d0-3bd52df6f5eb" \
https://idcs-148d8548c42947c983343db9b2e378ec.identity.c9dev2.oc9qadev.com/oauth2/v1/
token \
-H 'Accept: application/json' \
-H 'Accept-Language: en' \
-H 'Accept-Version: 1.3.0' \
-H 'Content-Type: application/x-www-form-urlencoded' \
-H 'Host: idcs-148d8548c42947c983343db9b2e378ec.identity.c9dev2.oc9qadev.com' \
-d
'username=oci.admin&password=OracleRetail1&grant_type=password&scope=urn%3Aopc%3Aidm%3A
__myscopes__%20offline_access' --tlsv1.2
```

You will see output that contains the following:

- The Access Token request output in JSON format. The return contains the attributes `access_token`, `token_type`, and `expires_in`.
- The `access_token` (Bearer) identifies your client access in Oracle Identity Cloud Service and will be used for subsequent REST API calls. This token is encoded following the JSON Web Token (JWT) standard.

To check the JWT token, you can copy the `access_token` and verify its value using:
<https://jwt.io/#debugger-io>

- The `token_type` identifies the Access Token as a Bearer token type. In future requests, you will use this token type to identify your token in the Authorization header of your request.
- The `expires_in` identifies the validity period of the Access Token.

Caution:

These bearer tokens may expire and may have to be regenerated in case a 401 Authorization Required error occurs.

Token

HTTP/1.1 200 OK

Cache-Control: no-store

Content-Length: 4667

Content-Type: application/json;charset=UTF-8

Date: Fri, 08 Jan 2021 20:46:40 GMT

Pragma: no-cache

Server: Oracle Identity Cloud Service

Strict-Transport-Security: max-age=315360000; includeSubDomains

Vary: Accept-Encoding

Via: 1.1 net-idcs-config

Perform the ORDS Rest API Calls

In this task, you perform your REST API call to Oracle Identity Cloud Service. The objective is to show you how the REST API calls are typically executed in Oracle Identity Cloud Service. To learn more about the application API, refer to the Oracle Identity Cloud Service REST API documentation.

In this example, it is assumed that a publicly accessible ORDS url has been provided to the customer.

Example: `http://<hostname>:<port>/ords`

RestAPI example url: `http://<hostname>:<port>/ords/pds`

Replace the bearer token with the value received from [Get Bearer Token](#). Note that these bearer tokens may expire and may have to be regenerated if a "401 Authorization Required" error occurs.

Figure 3-30 All Measures Output

```
{
  "items": [
    {
      "domain": "mfprcs",
      "measure": "drtynslsreg",
      "fact": "drtynslsreg",
      "fact_group": "nsls",
      "base_intx": "weeksku_stor",
      "description": "This Year Net Sales Reg Retail"
    },
    {
      "domain": "mfprcs",
      "measure": "drtynslsreg",
      "fact": "drtynslsreg",
      "fact_group": "nsls",
      "base_intx": "weeksku_stor",
      "description": "This Year Net Sales Reg Unit"
    },
    {
      "domain": "mfprcs",
      "measure": "drtynslspror",
      "fact": "drtynslspror",
      "fact_group": "nsls",
      "base_intx": "weeksku_stor",
      "description": "This Year Net Sales Promo Retail"
    },
    {
      "domain": "mfprcs",
      "measure": "drtynslspror",
      "fact": "drtynslspror",
      "fact_group": "nsls",
      "base_intx": "weeksku_stor",
      "description": "This Year Net Sales Promo Unit"
    },
    {
      "domain": "mfprcs",
      "measure": "drtynslsclrr",
      "fact": "drtynslsclrr",
      "fact_group": "nsls",
      "base_intx": "weeksku_stor",
      "description": "This Year Net Sales Clr Retail"
    },
    {
      "domain": "mfprcs",
      "measure": "drtynslsclrr",
      "fact": "drtynslsclrr",
      "fact_group": "nsls",
      "base_intx": "weeksku_stor",
      "description": "This Year Net Sales Clr Unit"
    },
    {
      "domain": "mfprcs",
      "measure": "drtyrtnreg",
      "fact": "drtyrtnreg",
      "fact_group": "rtn",
      "base_intx": "weeksku_stor",
      "description": "This Year Returns Reg Retail"
    },
    {
      "domain": "mfprcs",
      "measure": "drtyrtnreg",
      "fact": "drtyrtnreg",
      "fact_group": "rtn",
      "base_intx": "weeksku_stor",
      "description": "This Year Returns Reg Unit"
    },
    {
      "domain": "mfprcs",
      "measure": "drtyrtnpror",
      "fact": "drtyrtnpror",
      "fact_group": "rtn",
      "base_intx": "weeksku_stor",
      "description": "This Year Returns Promo Retail"
    },
    {
      "domain": "mfprcs",
      "measure": "drtyrtnpror",
      "fact": "drtyrtnpror",
      "fact_group": "rtn",
      "base_intx": "weeksku_stor",
      "description": "This Year Returns Promo Unit"
    },
    {
      "domain": "mfprcs",
      "measure": "drtyrtnclrr",
      "fact": "drtyrtnclrr",
      "fact_group": "rtn",
      "base_intx": "weeksku_stor",
      "description": "This Year Returns Clr Retail"
    },
    {
      "domain": "mfprcs",
      "measure": "drtyrtnclrr",
      "fact": "drtyrtnclrr",
      "fact_group": "rtn",
      "base_intx": "weeksku_stor",
      "description": "This Year Returns Clr Unit"
    },
    {
      "domain": "mfprcs",
      "measure": "drtyeopl",
      "fact": "drtyeopl",
      "fact_group": "eopx",
      "base_intx": "weeksku_stor",
      "description": "This Year RegtPromo End of Period Inventory Cost"
    },
    {
      "domain": "mfprcs",
      "measure": "drtyeopl",
      "fact": "drtyeopl",
      "fact_group": "eopx",
      "base_intx": "weeksku_stor",
      "description": "This Year RegtPromo End of Period Inventory Retail"
    },
    {
      "domain": "mfprcs",
      "measure": "drtyeopl",
      "fact": "drtyeopl",
      "fact_group": "eopx",
      "base_intx": "weeksku_stor",
      "description": "This Year RegtPromo End of Period Inventory"
    },
    {
      "domain": "mfprcs",
      "measure": "drtyeop2c",
      "fact": "drtyeop2c",
      "fact_group": "eopx",
      "base_intx": "weeksku_stor",
      "description": "This Year Clearance End of Period Inventory Cost"
    },
    {
      "domain": "mfprcs",
      "measure": "drtyeop2r",
      "fact": "drtyeop2r",
      "fact_group": "eopx",
      "base_intx": "weeksku_stor",
      "description": "This Year Clearance End of Period Inventory Retail"
    },
    {
      "domain": "mfprcs",
      "measure": "drtyeop2u",
      "fact": "drtyeop2u",
      "fact_group": "eopx",
      "base_intx": "weeksku_stor",
      "description": "This Year Clearance End of Period Inventory"
    },
    {
      "domain": "mfprcs",
      "measure": "drtyrinval",
      "fact": "drtyrinval",
      "fact_group": "tran",
      "base_intx": "weeksku_stor",
      "description": "This Year RMF Shrink Inventory Adjust Cost"
    },
    {
      "domain": "mfprcs",
      "measure": "drtyrinval",
      "fact": "drtyrinval",
      "fact_group": "tran",
      "base_intx": "weeksku_stor",
      "description": "This Year RMF Shrink Inventory Adjust Retail"
    },
    {
      "domain": "mfprcs",
      "measure": "drtyrinval",
      "fact": "drtyrinval",
      "fact_group": "tran",
      "base_intx": "weeksku_stor",
      "description": "This Year RMF Shrink Inventory Adjust Unit"
    },
    {
      "domain": "ascs",
      "measure": "iecpalsc",
      "fact": "iecpalsc",
      "fact_group": "iecp",
      "base_intx": "weekskupstor",
      "description": "Item Plan Store Exception Current Plan Sales Cost"
    },
    {
      "domain": "ascs",
      "measure": "iecptrafficu",
      "fact": "iecptrafficu",
      "fact_group": "iecp",
      "base_intx": "weekskupstor",
      "description": "Item Plan Store Exception Current Plan Traffic Count"
    },
    {
      "domain": "ascs",
      "measure": "iecptransactu",
      "fact": "iecptransactu",
      "fact_group": "iecp",
      "base_intx": "weekskupstor",
      "description": "Item Plan Store Exception Current Plan Transaction Count"
    }
  ],
  "hasMore": false,
  "limit": 0,
  "offset": 0,
  "count": 327,
  "links": [
    {
      "rel": "self",
      "href": "https://bur00cpe.us.oracle.com/ords/pdsam6/measures/all/"
    },
    {
      "rel": "describedby",
      "href": "https://bur00cpe.us.oracle.com/ords/pdsam6/metadata-catalog/measures/all/"
    }
  ]
}
```

Write PDS Web Service for Facts

Here is a sample payload.json file with the configuration values.

```
{
  "rejected_record_threshold_percentage": 40,
  "fact_names": [
    "drtyeopl",
    "drtyeopl",
    "drtycmkur"
  ],
  "intersection": [
    "week",
    "sku",
    "stor"
  ],
  "data_rows": [
    [
      "20200208",
      "67150969",
      "1002",
      1,
      100,
      200
    ],
    [
      "20200215",
      "67150969",
      "1007",
      2,
      400,
      800
    ]
  ]
}
```

Invoke the Web Service

Replace the bearer token with the value received in [Get Bearer Token](#)

Figure 3-33 Sample Output

```
{
  "items": [
    {
      "week": "w01_2023",
      "sku": "900001",
      "stor": "1001",
      "drtyeoplc": 55.0
    },
    {
      "week": "w01_2023",
      "sku": "900002",
      "stor": "1012",
      "drtyeoplc": 4.0
    }
  ],
  "hasMore": false,
  "limit": 100,
  "offset": 0,
  "count": 2,
  "links": [
    {
      "rel": "self",
      "href": "https://bur00cpe.us.oracle.com/ords/pdsam6/measuredata/drtyeoplc/"
    },
    {
      "rel": "describedby",
      "href": "https://bur00cpe.us.oracle.com/ords/pdsam6/metadata-catalog/measuredata/drtyeoplc/"
    },
    {
      "rel": "first",
      "href": "https://bur00cpe.us.oracle.com/ords/pdsam6/measuredata/drtyeoplc/"
    }
  ]
}
```

PDS Concurrency

PDS Concurrency is a locking mechanism for task exclusivity. In older versions, many tasks were configured to run in offline/exclusive mode. This means, when these tasks were in progress, other submitted/scheduled tasks remained in pending/scheduled state, irrespective of the application. The user access to application was also limited. The PDS concurrency mechanism uses locks in an Oracle database. Tasks acquire read and write locks only when required. Tasks release the locks on exit. This helps to attain high concurrency.

If there are no active locks, a task is granted a lock immediately and can begin its work. If only read locks are active, the task is granted a read lock immediately, but must wait for the write lock. The write lock is granted only once, all previous locks are completed.

Each operation has a default waiting period and an associated PDS property to override the default. The exception is `commit_asap_deadline`, a date time in which the timeout values are specified in milliseconds (for example, 4 minutes will be specified as 240000).

	Operation	PDS Property	Default Timeout
1	Wizard	<code>timeout_wb_op</code>	4 minutes
2	Workbook build through UI	<code>timeout_wb_main</code>	1 hour
3	Workbook build through OAT (wbatch)	<code>timeout_misc</code>	12 hours
4	Workbook refresh through UI	<code>timeout_wb_op</code>	4 minutes
5	Workbook refresh through OAT (wbatch)	<code>timeout_misc</code>	12 hours
6	DPM through UI	<code>timeout_wb_op</code>	4 minutes
7	DPM through webservice	<code>timeout_misc</code>	12 hours
8	Commit	<code>commit_asap_deadline</code>	Until deadline, which is 00:01 GMT by default.
9	Dashboard workbook build through OAT (scheduleDashboard)	<code>timeout_misc</code>	12 hours
10	Load Dimension Data & Load Fact Data (OAT or as part of batch)	<code>timeout_misc</code>	12 hours
11	System workbook commit	<code>timeout_batch</code>	24 hours
12	System workbook build	<code>timeout_batch</code>	24 hours
13	Batch Calc	<code>timeout_batch</code>	24 hours

The following table explains the lock behavior when two tasks are run in parallel. If there is lock contention, a message "in request_locks: waiting to acquire lock, sleeping 10s" will be displayed in the logs.

	Task 1	Task 2	Lock Contention
1	Load Dimension Data through OAT to load CLND hierarchy in MFP.	Load Dimension Data through EE Batch to load PROD hierarchy in MFP.	No
2	Load Dimension Data through EE Batch to load CLND hierarchy in MFP.	Load Dimension Data through EE Batch to load PROD hierarchy in MFP.	No
3	Load Dimension Data through OAT to load CLND hierarchy in MFP.	Load Dimension Data through OAT to load PROD hierarchy in MFP.	No
4	Load Dimension Data through OAT to load CLND hierarchy in MFP.	Load Dimension Data through OAT to load CLND hierarchy in AP.	Yes
5	Load Dimension Data through OAT to load CLND hierarchy in MFP.	Load Fact Data, whose intersection includes CLND, through EE Batch in MFP.	Yes
6	Load Dimension Data through OAT to load CLND hierarchy in MFP.	Load Fact Data, whose intersection includes CLND, through EE Batch in AP.	Yes
7	Load Fact Data through OAT to load measures in MFP.	Load Fact Data through EE Batch to load different measures in MFP.	No
8	Load Fact Data through EE Batch to load measures in MFP.	Load Fact Data through EE Batch to load different measures in MFP.	No
9	Load Fact Data through OAT to load measures in MFP.	Load Fact Data through OAT to load different measures in MFP.	No
10	Load Fact Data through OAT to load measures in MFP.	Load Fact Data through OAT to load same measures in AP.	Yes
11	Load Dimension Data through OAT to load CLND hierarchy in MFP.	User goes through CLND wizard in MFP.	Yes
12	Load Dimension Data through OAT to load CLND hierarchy in AP.	User goes through CLND wizard in MFP.	Yes
13	Load Dimension Data through OAT to load CLND hierarchy.	User goes through prod wizard.	No
14	Load Fact Data through OAT to load mask measure.	User goes through wizard that has pre range mask measure.	Yes
15	Run batch that loads the mask measure.	User goes through wizard that has pre range mask measure.	Yes
16	Load Dimension Data through OAT to load CLND hierarchy.	Workbook build that goes through CLND wizard.	Yes
17	Load Dimension Data through OAT to load CLND hierarchy.	Open existing workbook from recent plans.	No
18	Load Dimension Data through OAT to load CLND hierarchy.	Perform workbook calc.	No
19	Load Dimension Data through OAT to load CLND hierarchy.	Create scenario, promote scenario, change rollup, save format, restore format, and so on.	No
20	Load Dimension Data through OAT to load DPM enabled hierarchy.	DPM via workbook – add informal positions.	Yes
21	Run custom menu in a workbook that does not do commit.	Load Fact Data through OAT to load measures present in custom menu rules.	No
22	Run custom menu in a workbook that does a commit.	Load Fact Data through OAT to load measures that are part of custom menu rules.	Yes

Task 1	Task 2	Lock Contention
23 Workbook commit.	Load Fact Data through OAT to load facts that are part of commit rules.	Yes
24 Workbook commit.	Load Fact Data through OAT to load facts that are not part of commit rules.	No
25 Workbook commit.	Load Dimension Data through OAT to load CLND hierarchy.	Yes
26 Call DPM webservice that adds informal positions.	Load Dimension Data through OAT to load DPM enabled hierarchy.	Yes
27 Run batch calc group in MFP.	Load Dimension Data through OAT to load CLND hierarchy in ASCS.	Yes
28 Run batch calc group in MFP.	Load Fact Data to load ASCS only measures.	Yes (if there are shared measures in the batch rule group)
29 Run batch calc group in MFP.	Load Fact Data to load shared measures.	Yes
30 Load Dimension Data through OAT to load CLND hierarchy.	Build system workbook.	Yes
31 Load Dimension Data through OAT to load CLND hierarchy.	Commit system workbook.	Yes

With the introduction of PDS Concurrency, the number of tasks with an exclusive lock is reduced to three. These tasks are Build application, Patch application, and Unregister application. These tasks still require an exclusive lock because these can change fact tables that are used by all applications.

When these tasks are in progress, other tasks submitted/scheduled from all applications will remain in a pending/scheduled state. For example, when the Patch application is In Progress in AP, tasks submitted from all applications remains in a scheduled/pending state until the AP Patch application completes.

Similarly, these tasks will wait until all tasks In progress are completed. For example, when Run Batch Task Group is In Progress in MFP, the Build application in AP remains in Pending until the batch task completes.

Scenario	Behavior
1 Submit Run Batch Task Group task in MFP. While the task is in progress, submit Patch Application in MFP.	Prepatch Patch Report and Run Batch Task Group" executes in parallel. Patch Application remains in Pending until batch task completes.
2 Submit Run Batch Task Group task in MFP. While the task is in progress, submit "Patch Application" in AP.	Prepatch Patch Report and Run Batch Task Group executes in parallel. Patch Application remains in Pending until batch task completes.
3 Submit Run Batch Task Group task in MFP. While the task is in progress, submit Build Application in MFP.	Build Application remains in Pending until batch task completes.
4 Submit Run Batch Task Group task in MFP. While the task is in progress, submit Build Application in AP.	Build Application remains in Pending until batch task completes.

Scenario	Behavior
5 Submit Run Batch Task Group task in MFP. While the task is in progress, submit Unregister Application in MFP.	Unregister Application remains in Pending until batch task completes.
6 Submit Run Batch Task Group task in MFP. While the task is in progress, submit Unregister Application in AP.	Unregister Application remains in Pending until batch task completes.
7 Submit Patch Application in AP. When Patch Application is in progress, submit OAT Load Fact Data to load MFP only measures in MFP.	MFP Load Fact Data remains in pending state until AP Patch Application is complete.
8 Submit Patch Application in AP. When Patch Application is in progress, submit OAT Load Fact Data to load shared measures in MFP.	MFP Load Fact Data remains in pending state until AP Patch Application is complete.
9 Submit Patch Application task in AP. When Patch Application is in progress, submit Run Batch Calc Group in MFP.	Run Batch Calc Group from mfp remains in pending state until Patch Application is complete.
10 Submit Patch Application task in AP. When Patch Application is in progress, open any workbook in AP.	Cannot open workbook. DomainExclusiveException: Patch Application.
11 Submit Patch Application task in AP. When Patch Application is in progress, open any workbook in MFP.	Workbook open successfully.
12 Submit Patch Application task in AP. When Patch Application is in progress, perform workbook commit in MFP.	Commit submitted. Commit task added to queue. Task remains in pending state until "Patch Application" is complete.
13 Submit Patch Application task in AP. When Patch Application is in progress, perform workbook commit in AP.	Cannot submit commit. There was an error performing a commit: DomainExclusiveException: Patch Application.
14 Submit Patch Application task in AP. When Patch Application is in progress, perform workbook refresh in MFP.	Refresh completes successfully.
15 Submit Patch Application task in AP. When Patch Application is in progress, perform workbook refresh in AP.	Cannot refresh. There was an error refreshing: DomainExclusiveException: Patch Application.
16 Submit Patch Application in AP. Schedule load dimension data in MFP such that the start time is while Patch Application is in progress.	Load Dimension Data remains in Scheduled state until Patch Application is complete.
17 While Patch Application is in progress in MFP, perform the workbook operations in MFP.	Restore, Save, or Delete format, Create Scenario failed with DomainExclusiveException: Patch Application.
18 While Patch Application is in progress in MFP, perform the workbook operations in AP.	Restore, Save, or Delete format completed successfully. For adding scenario, Scenario copy task is added and remains in pending state until patch is completed. On patch completion, scenario copy task also completes successfully.

4

System Administration

This chapter describes the following system administration workbooks and wizards:

- [Hierarchy Maintenance Workbook](#)
- [Security Administration](#)
- [Withdrawing Administrative Privileges or User Access Rights](#)
- [Measure Analysis Workbook](#)
- [XML Schema for Importing Users and Groups](#)
- [List Logged-In Users](#)
- [Schedule Dashboard Build](#)

These workbooks and wizards are found in the Administration task in the taskflow.



Note:

The Translation Administration workbook is described in [Internationalization](#).

Hierarchy Maintenance Workbook

RPASCE can be used to set up and maintain user-named and user-defined dimensions within hierarchies. Hierarchy Maintenance is the means by which custom-created dimensions within a hierarchy can be established and maintained through the application interface in order to meet individual business needs.

The configurator can define the dimensions and hierarchical structures specific to the customer's organization. For example, the system can be built to recognize that SKUs roll up into styles, styles roll up into product classes, and so on, within the product hierarchy. Occasionally, you might want to group products according to some ad hoc personal design to suit a particular business need. You can group arbitrary items in a hierarchy to use in functions such as forecasting, replenishment, and measure analysis. These user-defined groupings act as normal dimensional levels. In other words, they allow the user to roll data up from lower levels of aggregation along the hierarchical paths that the user defines.

For example, suppose experience has shown that the accuracy of forecasts for your top 50 products (A products) reflects the relative accuracy of all forecasts. Therefore, you would like to group elements within a user-defined dimension as the top 50 products by designating them "A Products." Then, when you select products in a wizard or look at data in a view, you can change the rollup to your user-defined dimension to see your top 50 products grouped together.

 **Note:**

Your collection of 50 products may comprise elements from a wide range of product classes or departments, and your grouping scheme may have little to do with the normal dimensional relationships of these items in the product hierarchy. The group of items you designate as "A Products" may change over time as consumer preferences change. From this example, you can see that user-defined dimensions can be used to create any ad hoc groupings to provide additional support in analyzing, selecting, or summarizing data in demand forecasting. The Hierarchy Maintenance interface allows you to change the nature of the groupings as required. The number and names of user-definable dimensions are set by your company when an RPASCE-based solution is initially installed. The positions within each dimension and their associated labels can be altered and maintained through the hierarchy maintenance process.

User-definable dimensions can be only defined as leaf dimensions in the hierarchy. Stacking of user-definable dimensions or adding one in-between normal dimensions is not supported.

Remember that any hierarchy in RPASCE can have user-defined dimensions within it as long as they are set up by your company at the time of installation. The examples in this section refer to the product hierarchy, but other hierarchies can be maintained in the same way.

Hierarchy Maintenance Example

Suppose you want to designate subclasses in your product hierarchy as either A, B, or C products so that you can group these subclasses together when you view information such as forecasting, replenishment, or measure analysis reports.

To do this, you must maintain a user-defined dimension that allows you to map the subclasses to the various positions of your classification scheme (A, B, or C). The user-defined dimension used in the following example is named "Consignment". To maintain this user-defined dimension, use the Hierarchy Maintenance Wizard.

Hierarchy Maintenance Wizard

To access the Hierarchy Maintenance Wizard:

1. On the main page, click **Tasks**, then select **Administration**. The Administration group appears.

Figure 4-1 Tasks

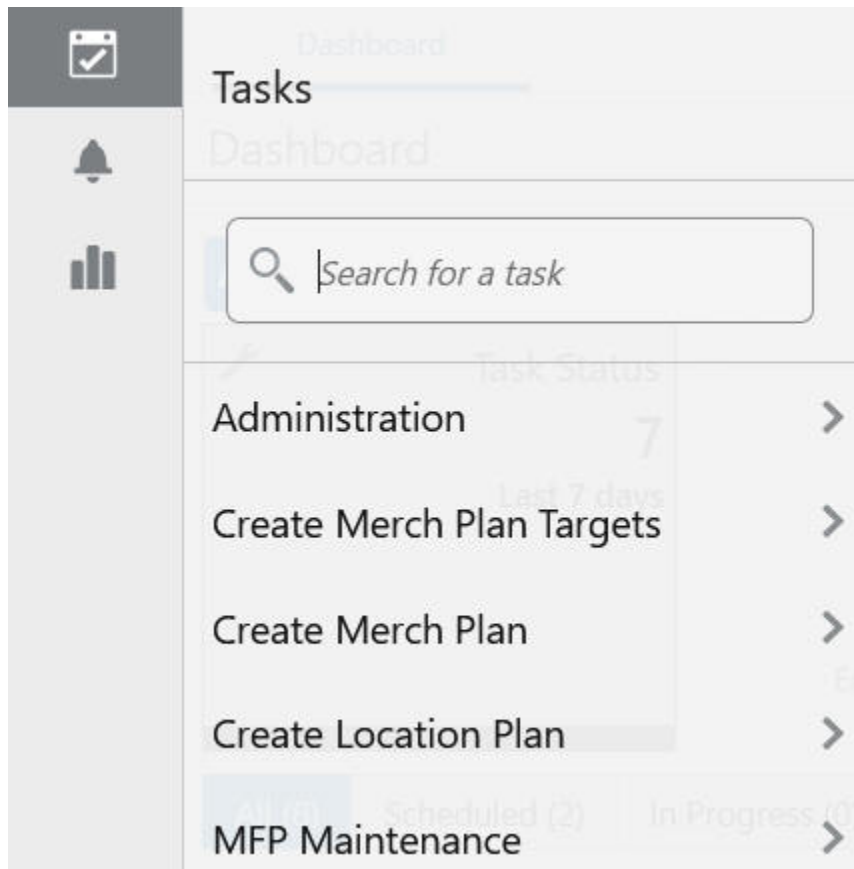

2. In the Administration group, select **System Administration**.

Figure 4-2 System Administration

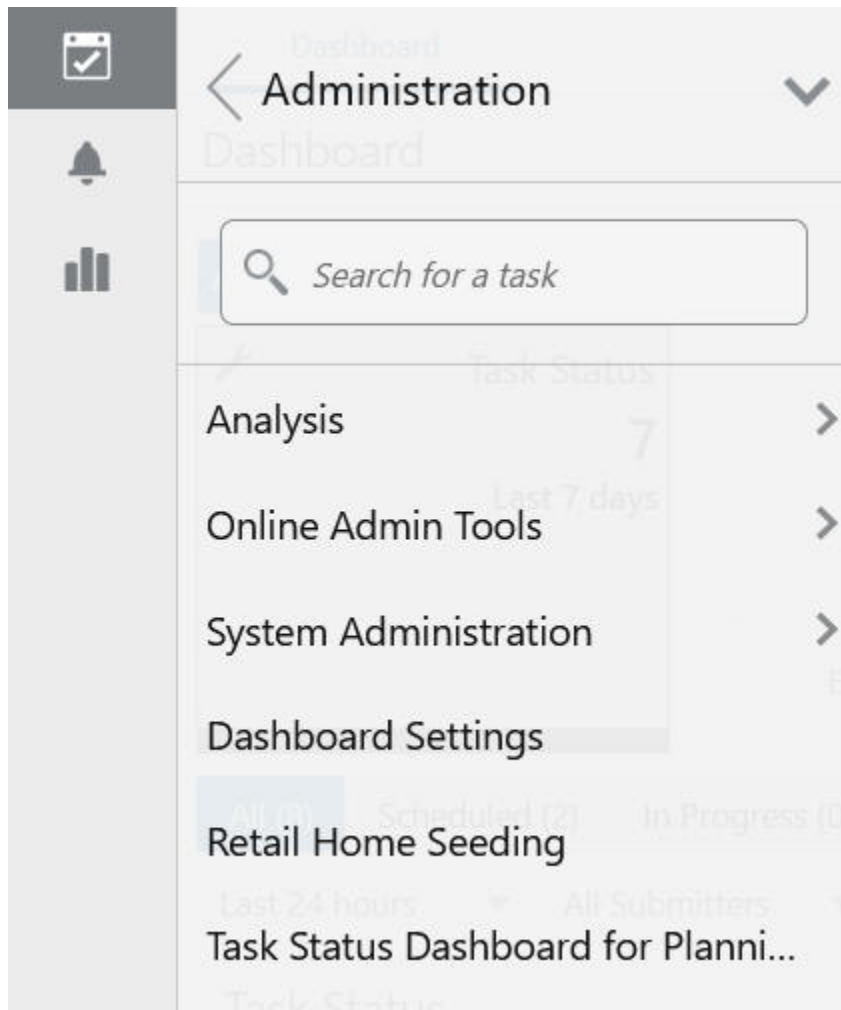

3. In the System Administration group, select **Hierarchy Maintenance**. A plan dialog box appears.

Figure 4-3 Hierarchy Maintenance

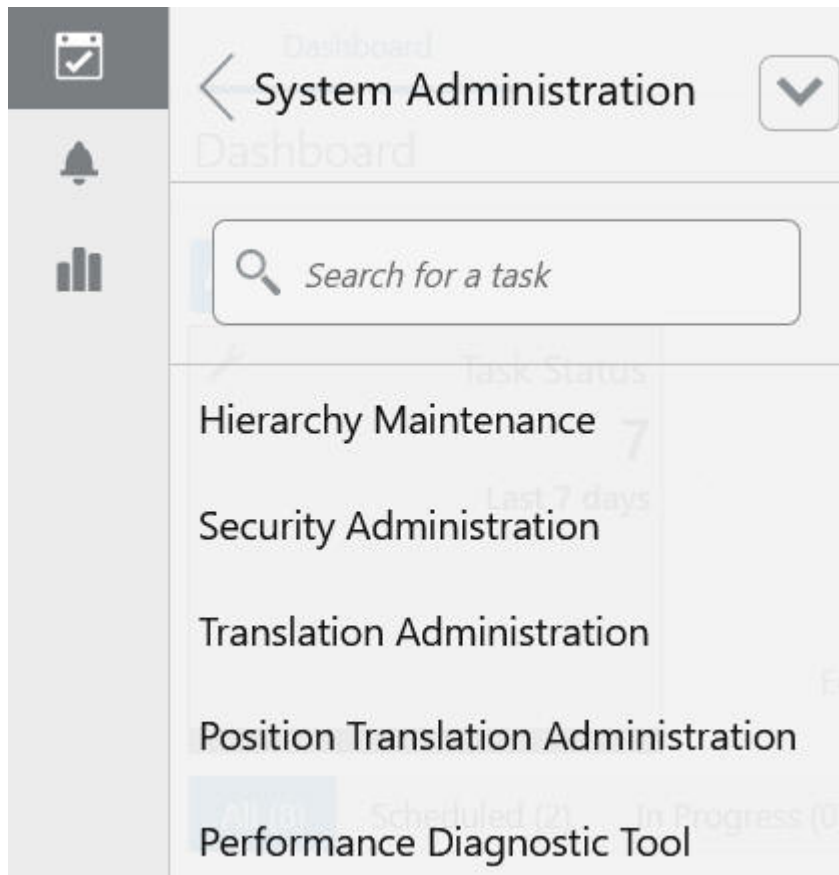

4. Click **Create New Plan** to create a new segment. If it is the first segment, the dialog box for entering the label will appear. Otherwise, click **Create New Plan**, as shown in [Figure 4-4](#), to enter the label for the new segment.

Figure 4-4 Create New Plan

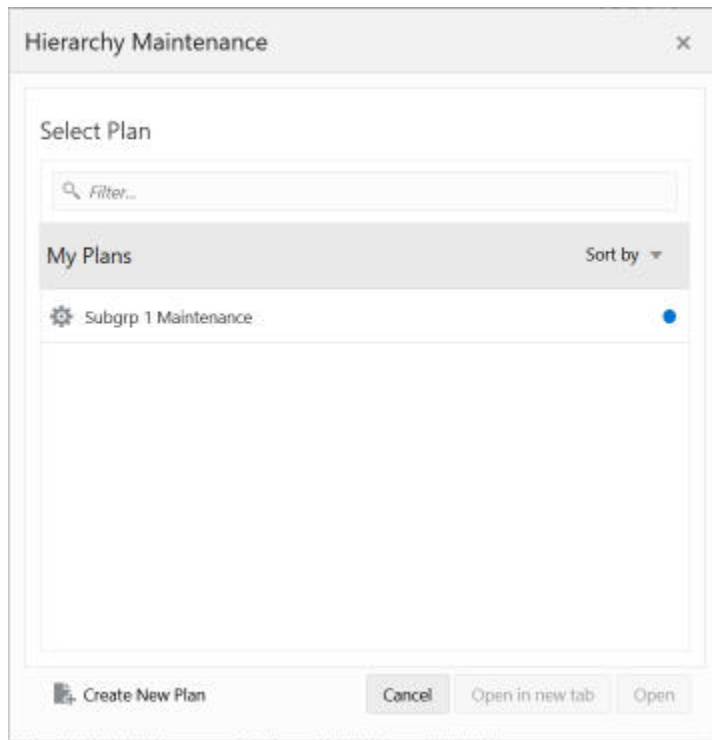

5. Provide a label for the segment.

Figure 4-5 Label

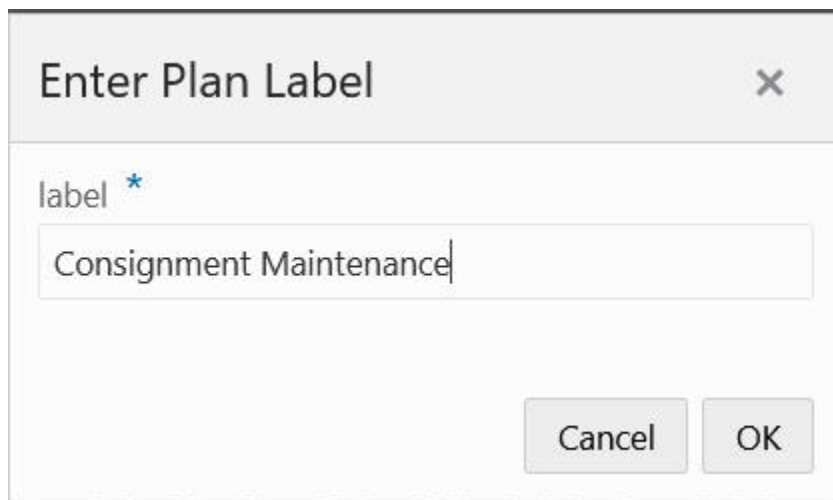

6. A wizard page appears to select the custom dimension to maintain. Select a custom dimension and click **Next**.
7. Select the positions to be included into the segment and click **Finish**.
8. The RPASCE server processes the request. Upon completion, a notification will be sent to the user interface, as shown in [Figure 4-6](#) and a link to open the segment will be available in the Recent Plans box, shown in [Figure 4-7](#).

Figure 4-6 Recent Plans Notification



Figure 4-7 Recent Plans Segment Link

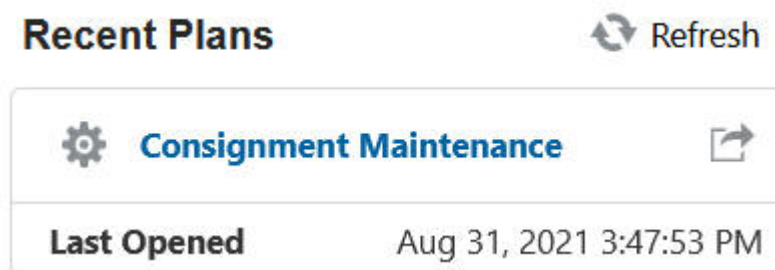

9. Click the link to open the segment.
10. In the position assignment field for the custom dimension, assign a value to each product or location position in the workbook. Enter any text string in a cell. Each unique string is treated as a separate user-defined position within the custom dimension.
11. After you make your selection, for the changes to take effect, click **Calculate** and then **Commit**.
12. To close the segment, click the **X** icon next to the segment label on the top of the page. The segment is saved automatically.

Hierarchy Maintenance View

The Hierarchy Maintenance view displays the position assignment fields for the selected custom dimension. Edit the cells associated with the custom dimension as required.

Returning to the example dimension Consignment: You want to classify each selected subclass in your segment as either a Consignment A, a Consignment B, or a Consignment C. This example provides only three positions, or values, in the Consignment dimension; however, you can enter any character string in an individual subclass's Consignment cell. This new string is treated as a separate user-defined grouping. If this is the first time a particular subclass has been mapped to the Consignment dimension, the label assigned to that subclass will not yet be defined. The Consignment field is automatically filled with "Unassigned."

Assign labels to each product with regard to the Consignment dimension. In the following example, products that were previously Unassigned are now designated as Consignment A, B, or C.

Figure 4-8 Hierarchy Maintenance View

Consignment Maintenance Views

Menu + 🔍 📅 ↶ ▼ ↷ ⌵

Subclass - Consignment/Non-Cons

Measure (unsaved) ✎

Product 📊 ✎

Product	Measure	Consignment/Non-Cons
30000 Loafers		Consignment A
30001 Boots		Consignment C
30002 Cap Toe		Consignment A
30003 Loafers		Consignment B
30004 Lace Ups		Consignment C
30005 Sport		Consignment B
30006 Low Heel		Unassigned
30007 High Heel		Consignment C
30008 Ankle		Unassigned
30009 Knee Length		Unassigned

 **Note:**

The RPASCE system is case sensitive when a new position label is entered in the Hierarchy Maintenance segment. After the segment is committed, the typing of the group name is not case sensitive. For example, Consignment B can later be entered as consignment b after the Consignment B group label has been committed.

After making the Consignment A, Consignment B, or Consignment C designations for the selected subclasses, you must calculate and commit the segment for any changes to take effect.

For this example, labels have now been assigned to the various positions within the Consignment/Non-Cons dimension, and selected products in the product hierarchy have been classified with regard to the custom dimension.

[Figure 4-9](#) displays the results when you access a quick menu in a wizard and change the rollup to the Consignment/Non-Cons dimension. The products shown here are classified according to the position values (Consignment A, Consignment B, or Consignment C) that were assigned while maintaining the Consignment/Non-Cons dimension.

Figure 4-9 Consignment/Non-Cons Dimension Results

Channel Subclass Week Window	
Calendar	8/14/2021
Product	
▲ Consignment A	
30000 Loafers	
30002 Cap Toe	
▲ Consignment B	
30003 Loafers	
30005 Sport	
▲ Consignment C	1
30001 Boots	
30004 Lace Ups	
30007 High Heel	
30009 Knee Length	
▲ Unassigned	1
30006 Low Heel	
30008 Ankle	

Maintaining a User-Defined Dimension Within a Hierarchy

Use this procedure to assign product or location items to custom-defined positions within a specialized dimension. Custom-created dimensions are distinct from those in the standard hierarchical roll-ups configured in the system implementation. You can use these dimensions in the same way that you use normal Demand Forecasting levels, aggregating data along these new hierarchical paths.

1. In the taskflow, select **Administration**. The Administration activity appears with all the subtasks.
2. Click **Hierarchy Maintenance**.

Figure 4-10 Hierarchy Maintenance Task

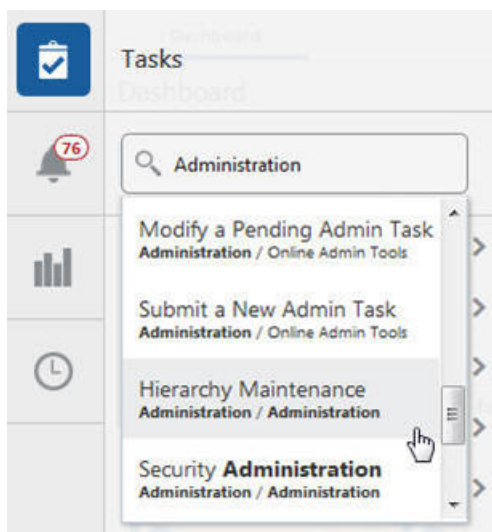

3. The segment dialog box opens. Select **Create New Plan** and enter the label of the segment. A Hierarchy Maintenance Wizard window appears.

Figure 4-11 Plan Label

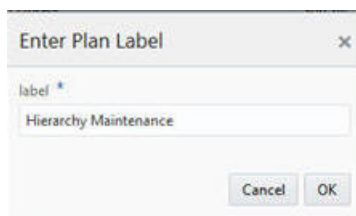

4. Select the hierarchy to specify a user-defined dimension (for example, Product or Location). Only the hierarchies that have been set up to contain user-defined dimensions appear here. Click **Next**.
5. Select the user-defined dimension to be updated. The number and names of available custom dimensions are set at installation. Click **Next**.
6. From the Available Items in the selection wizard, select the items to be mapped to positions within the custom dimension.

7. Use the Add, Add All, Remove, and Remove All buttons or the drag and drop action to move your selection to the Selected Items section.
8. After you have selected all the items to appear in your workbook, click **Finish**. The Hierarchy Maintenance segment is created with the given label and submitted for building the workbook. After the notification is provided, open the workbook.
9. In the position assignment field for the custom dimension, assign a value to each product or location position in the workbook. Enter any text string in a cell. Each unique string is treated as a separate user-defined position within the custom dimension.
10. After you make your selection, for the changes to take effect, click **Commit (F8)** in the bottom right corner. Commit notification will be sent once the commit is successful.
11. To close the workbook, click **X** on the top-right corner of the tab.
12. The Hierarchy Maintenance workbook is displayed. In the position assignment field for the custom dimension, assign a value to each product or location position in the workbook. Enter any text string in a cell. Each unique string is treated as a separate user-defined position within the custom dimension.

Security Administration

The security model in RPASCE includes workbook templates, workbooks, measures, and positions. The levels of security are defined as measure level, position level, and workbook level.

Security Overview

This section provides the basic information on the security model in RPASCE.

User and Group Security

During a RPASCE Client deployment, one or more user groups are specified via a deployment property. These groups must be created in OCI IAM. The Cloud Engineering team responsible for setting up the customer's application will have already created the application-specific groups.

Users created as members of these groups gain access to the Client UI.

It may be necessary to add and remove users. This can be done by adding and removing them from the OCI IAM directory.

Position Level Security

Position level security allows access control for dimensions on a position-by-position basis. This capability is completely optional. If position level security is not explicitly defined and configured, all users in an application have access to all positions in all hierarchies. After the position level security is defined, access to a position can be granted or denied for individual users, users in a group, or for all users.

Position level security is used when a user selects positions in the wizard before building a workbook. Only positions to which the user has access are available for selection in the wizard, which are then included in the build of the workbook.

Position level security can be defined for any hierarchy (except the calendar) at any level (for example, the class level in the product hierarchy). As positions are added at a level lower in the hierarchy than where the position level security is maintained, access to those positions is automatically granted if a user has access to the parent position. For example, if security is maintained at the subclass level, users are automatically granted access to all the SKUs in a given subclass if they have access to that subclass. This also includes new positions that were added after security was established.

Exactly one dimension in each hierarchy can be defined as the security dimension for the hierarchy. If a security dimension is defined for the hierarchy, all dimensions in the hierarchy have position level security enabled, but position security is set at or above the designated dimension. For example, if the class dimension is designated as the security dimension, an administrator can maintain access to positions in the class dimension or at any level above class.

To specify the security dimension for a hierarchy, the application designer must update the configuration and either rebuild or patch the application.

After a security dimension is defined for a hierarchy, all users in the application default to having access to all positions in any dimension in the hierarchy. Additionally, users automatically have access to any newly added positions. Views in the Security Administration workbook are used to control position access for individual users, user groups, or all users (referred to as world or default access). Three views are provided in this workbook for each hierarchy with a defined security dimension. The default view controls access to positions for all users (for instance, Prod Security Default); one view controls access to positions by user group (for instance, Prod Security Group); and the last view controls access to positions by individual users (for instance, Prod Security User).

Access must be granted at all levels for a user to have access to a position. This means that a position must have a value of true at the levels default/world, group, and user. [Table 4-1](#) demonstrates how access is granted or denied based on all combinations of settings.

In the table, the resulting access in case of different combinations of user, group, and world access is displayed. Based on the settings for User, User Group, and World, the user is either granted or denied access, as shown in the Resulting Access column.

Table 4-1 Grant or Denial of Access by a Combination of Settings

User	User Group	World	Resulting Access
Denied	Denied	Denied	Denied
Denied	Denied	Granted	Denied
Denied	Granted	Denied	Denied
Granted	Denied	Denied	Denied
Denied	Granted	Granted	Denied
Granted	Denied	Granted	Denied
Granted	Granted	Denied	Denied
Granted	Granted	Granted	Granted

 **Note:**

If a position filter measure is set for a hierarchy in the configuration, it overrides which positions are available for the hierarchy at the application level. Only those positions that are visible to the application can be used with the position level security for the application. For more information, refer to position filter measure section in the *Oracle Retail Predictive Application Server Cloud Edition Configuration Tools User Guide*.

Workbook Security

Workbook access is either granted or denied. If users have been granted access to a workbook, they can open, modify, and commit the workbook. No distinction is made between read-write-commit, read-write, and read-only access.

Workbook access is automatically granted to the user who built it.

 **Note:**

A user must have access to the workbook template in order to access the workbook, even if the workbook has world or group access rights.

Users with administration status automatically have access to all workbook templates.

Another aspect of workbook security is the ability to set limits for the number of workbooks that a user can have saved at any given time. Scenario copies created within a single workspace are also counted in the number of workbooks saved by a user. Limits can be set for a user per template, for a user group per template, or for a template for all users. The limits are evaluated in the above order, which means that a limit defined at user-template overrides any values defined at group-template or template. If the above limits are not defined, the default value is one billion.

The limits are checked when the workbook build process is initiated. When the limit is reached, an error message is displayed informing the user that the workbook build process cannot complete because the limit has been reached. The message also lets the user know what the limit is.

Administration users have full access to all workbook templates, regardless of the access rights that other administration users may assign to them in the Security Administration workbook. The administration user can build the Security Administration workbook to change the access right, so the assignment in the Security Administration workbook does not matter for administration users.

Non-administration users do not have access to the Security administration template, even if the administrator inadvertently assigns them access rights. [Table 4-2](#) provides a full list of such templates that cannot be accessed by non-administration users even if they have been provided the access rights by an administration user.

Table 4-2 Templates Unavailable to Non-Administration Users

Template Group	Template Name
Online Admin Tools	Copy from an Existing Admin Task
	Delete a Scheduled Admin Task
	Modify a Scheduled Admin Task
	Submit a New Admin Task
System Administration	Hierarchy Maintenance
	Security Administration
	Translation Administration
	Position Translation Administration
	Performance Diagnostic Tool
Task Status Dashboard	Task Status Dashboard
Dashboard Settings	Dashboard Settings

Security Administration Workbook

The Security Administration workbook is used for controlling the RPASCE-related security aspects of an RPASCE application. The Security Administration workbook is only accessible to administration users. To make sure the Security Administration workbook is current and in sync with the users and groups in the application, you must rebuild it before making any changes in case it is not freshly built. In a multi-application environment, the values set in the Security Administration workbook are application specific.



Note:

The Security Administration workbook needs to be committed for any changes made in the Security Administration workbook to take effect.

- Workbook Template Rights view
- Dimension Modification Rights view
- Position Level Security views
- Workbook Template Limits views
- Max Domain Session Limit view
- Max User Session Limit view
- Group Workbook Template Default Rights view

Workbook Template Rights View

The Workbook Template Rights view is used for setting and maintaining the access permissions of each user to specific workbook templates.

The view contains a drop-down list for each available workbook template and user combination. To grant a user access rights to a workbook template, select one of the following options from the drop-down list for that workbook template:

- Denied
- Read-Only
- Full Access

The Read-Only permission on a template applies only to actual workbooks created by the template. For templates that do not generate a workbook, but only run through a wizard process for other purposes, the Read-Only permission for a user on that template does not prevent the user from running through the wizard.

Dimension Modification Rights View

The Dimension Modification Rights view allows the administrator to determine which dimensions, if any, a user can modify. Its purpose is to provide a filtered list of user-defined dimensions to be shown on the dimension selection wizard page of the Hierarchy Maintenance template. The view contains a check box for each available user and dimension combination. A check mark in the cell indicates that the user is permitted to modify the specified dimension.

Note:

The dimension modification rights only apply to the Hierarchy Maintenance template, which is only available to administration users. Changing these rights for normal users has no effect. This view does not have any impact on the ability of the user to add, modify, or delete dimension positions using the Dynamic Position Maintenance feature.

Position Level Security Views

The Position Level Security views are used to grant or deny access to positions for individual users, user groups, or all users.

For each hierarchy that has position-level security enabled, three views are available, at the user level, the group level, and the world/all users level. For example, for the product hierarchy, the views are named prod/user position security, prod/group position security, and prod/all position security.

Workbook Template Limits Views

The Workbook Template Limit views are used to limit the number of workbooks that the user can have. The template limits can be set at the user level, the group level, or the all users level. The three views are named workbook limit per user/template, workbook limit per group/template and workbook limit per template. The limits set in the user view override the group view, which overrides the template view.

The limits are checked when the user begins the segment build process. If the limit has been reached, an error message appears that informs the user that the workbook build process cannot complete because the limit has been reached.

**Note:**

Scenario workbooks within the workspace are also included in the workbook count.

Max Domain Session Limit View

The Max Domain Session Limit view is used to limit the number of user sessions that can be created in an application by all users of that application. This limit is set at the application level.

The limit is checked during user login and when the limit has been reached, an error message is displayed to the user indicating that the login has failed because this limit has been reached.

Max User Session Limit View

The Max User Session Limit view is used to limit the number of concurrent user sessions that each user can create in an application. The administration user can control the maximum number of concurrent sessions that are allowed for any individual user using this view.

This limit is checked during user login and when the limit has been reached, an error message is displayed to the user indicating that the login has failed because this limit has been reached.

Group Workbook Template Default Rights View

The Group Workbook Template Default Rights view is used for setting and maintaining default access permissions for each user group for specific workbook templates. The worksheet contains a drop-down list of available rights for each available workbook template and user group combination.

To grant a user group access rights to a workbook template, select one of the following options from the drop-down list for that workbook template: Denied, Read Only, or Full Access.

Using the Security Administration Workbook

**Note:**

These tasks are performed through the Security Administration workbook. This workbook is only available to system administrators.

Accessing Security Administration

1. In the taskflow, select **Administration**. The Administration activity appears with all the subtasks.
2. Click **System Administration**. Then click **Security Administration**.

Figure 4-12 Security Administration Task

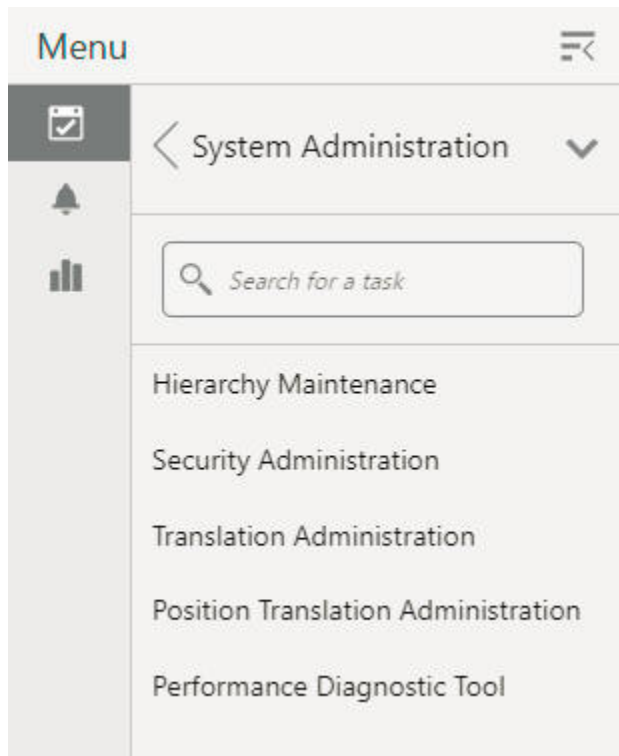

3. A new segment is created and a notification is issued. If the segment already exists, the existing workbook associated with the segment is re-opened.

Figure 4-13 New Segment Notification

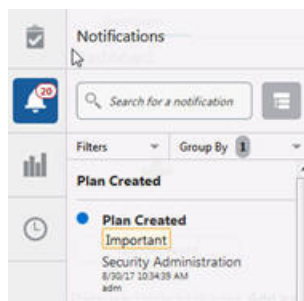

You can also open the segment from recent plans.

Figure 4-14 Recent Plans List



Setting or Modifying Users' Access to Workbook Templates

The Workbook Template Rights view enables you to set one of the following access privileges to each workbook template for a user:

- Denied
- Read-Only
- Full Access

To set or modify a user's access to workbook templates:

1. In the taskflow, select **Administration**.
2. Click **System Administration**.
3. Click **Security Administration**.
4. A new segment is created, and a notification is issued. If the segment already exists, the existing workbook associated to the segment is re-opened. You can also open the segment from recent plans.
5. On the Workbook Template Rights view, for each workbook template, select one of the access privileges for the users you want.
6. After you make your selection, for the changes to take effect, click **Commit (F8)**, located under the bottom right corner. A notification is issued once the commit is done.

The data modified is autosaved.

To close the workbook, click **X** on the top-right corner of the tab.

Changing a User's Ability to Modify Dimensions

1. In the taskflow, select **Administration**.
2. Click **System Administration**.
3. Click **Security Administration**.
4. A new segment is created, and a notification is issued. If the segment already exists, the existing workbook associated to the segment is re-opened. You can also open the segment from recent plans.
5. On the Dimension Modification Rights view, select each dimension for which the user needs modification rights. For dimensions that the user must not be able to modify, make sure there is no check mark.
6. After you make your selection, for the changes to take effect, click **Commit (F8)**, located under the bottom right corner. A notification is issued once the commit is completed.

The data modified is autosaved.

To close the workbook, click **X** on the top-right corner of the tab.

Setting or Modifying Access to Positions (if Position Level Security has been Enabled)

1. In the taskflow, select **Administration**.
2. Click **System Administration**.

3. Click **Security Administration**.
4. A new segment is created, and a notification is issued. If the segment already exists, the existing workbook associated to the segment is re-opened. You can also open the segment from recent plans.
5. On the Position Level Security view, select the view for which security must be set or modified: User, User Group, or World.
6. By default, the dimension (level) at which position level security is enabled appears. To manage security at a level above the designated level (only levels above are possible), right-click and select **Rollup** to view the available dimensions.
7. To grant access to a position, select the check box in the relevant cell.

 **Note:**

A user must have access at the User, User Group, and World levels to have access to a position.

8. After you make your selection, for the changes to take effect, click **Commit** (F8), located under the bottom right corner. A notification is issued once the commit is completed.

The data modified is autosaved.

To close the workbook, click **X** on the top-right corner of the tab.

Limiting the Number of Workbooks that a User Can Save

1. In the taskflow, select **Administration**.
2. Click **System Administration**.
3. Click **Security Administration**.
4. A new segment is created, and a notification is issued. If the segment already exists, the existing workbook associated to the segment is re-opened. You can also open the segment from recent plans.
5. On the Workbook Limit Per User/Template view, for a workbook template, set an appropriate value as the limit for a user.
6. After you make your selection, for the changes to take effect, click **Commit** (F8), located under the bottom right corner. A notification is issued once the commit is completed.

The data modified is autosaved.

To close the workbook, click **X** on the top-right corner of the tab.

Limiting the Number of Workbooks Per Template

1. In the taskflow, search for Administration activity.
2. Click **System Administration**.
3. Click **Security Administration**.

4. A new segment is created and a notification is issued. If the segment already exists the existing workbook associated to the segment is re-opened. You can also open the segment from recent plans.
5. On the Workbook Limit Per Template view, for a workbook template, set an appropriate value as the limit.
6. After you make your selection, for the changes to take effect, click the **Commit** (F8), located under the bottom right corner. A notification is issued once the commit is completed.

The data modified is autosaved.

To close the workbook, click **X** on the top-right corner of the tab.

Limiting the Number of Workbooks that a Group Can Save

1. In the taskflow, select **Administration**.
2. Click **System Administration**.
3. Click **Security Administration**.
4. A new segment is created, and a notification is issued. If the segment already exists, the existing workbook associated to the segment is re-opened. You can also open the segment from recent plans.
5. On the Workbook Limit Per Group/Template view, for a workbook template, set an appropriate value as the limit for the user group.
6. After you make your selection, for the changes to take effect, click **Commit** (F8), located under the bottom right corner. A notification is issued once the commit is completed.

The data modified is autosaved.

To close the workbook, click **X** on the top-right corner of the tab.

Withdrawing Administrative Privileges or User Access Rights

RPASCE uses a two-state authorization model. Users of the system are either administration or non-administration users. A number of interactions with the system are privileged and may only be performed by administration users. This section describes how the system reacts when the administrative privileges of administration users are removed but the users themselves are not removed from the system.

Such a case can occur as a result of a change of role in the customer organization or because a user is given temporary privileges in order to perform some operation that requires privileges. (Examples include working in an administrative template such as translation administration or measure analysis or in saving template-level formatting.)

Security Administration Workbook Withdrawal Scenario

This section describes the withdrawal scenario for the Security Administration Workbook.

Workbook Template

When a non-administration user's workbook template access is modified by the administrator, the server does the following:

The user is prompted with the following message when the user performs operations that are not permitted.

"Administrator has modified access to this template. You can either ask administrator to remove the restriction or you can delete the segment."

When a user's access right to a workbook template has been withdrawn, the user will be denied access to all segments and workbooks from that template.

When a user's access right to a workbook template has been changed to read-only, the user will not be allowed to perform any operation that may affect data in the application, including calc, commit, custom menu, and saving the format for group or template.

Commit Subsystem

Commit Subsystem will fail, pending commits from the template to which access rights have been withdrawn or changed to read-only for the submitter of the commit.

Measure Analysis Workbook

The Measure Analysis view allows the user to view specific measure data for the positions selected from the measure's associated hierarchies. Each Measure Analysis view is displayed at a different intersection, depending on the measure selections made in the wizard. This intersection is shown in the view title bar.

Although a common use of the Measure Analysis workbook is to view actual sales data, the workbook is not restricted to presenting sales data alone. The user can view any data loaded into the RPASCE master database, such as selling prices, shipments, and orders. The Measure Analysis Wizard provides a list of all stored measures that have an insertable measure property set to true. The user simply chooses the measures to be displayed in the new workbook.

Measure Analysis View

The Measure Analysis view allows the user to view the chosen measure data for the positions selected from the measure's associated hierarchies. Each Measure Analysis view is displayed at a different dimensional intersection, depending on the measure selections made in the wizard. This dimensional intersection is shown in the view title bar.

Figure 4-15 Measure Analysis View Example

The screenshot shows a software interface for 'Measure Analysis 01'. The main content is a table titled 'Channel Subclass Week Window'. The table has columns for dates: 8/14/2021, 8/21/2021, 8/28/2021, 9/4/2021, 9/11/2021, and 9/18/2021. The rows list shoe products such as '30000 Loafers', '30001 Boots', etc., with numerical sales values for each date. The interface includes navigation buttons like 'Calendar', 'Product', and 'Wp Sales R'.

Calendar	8/14/2021	8/21/2021	8/28/2021	9/4/2021	9/11/2021	9/18/2021
Product						
30000 Loafers	40236.99	37526.78	24231.14	24198.60	56483.01	26853.17
30001 Boots	36177.32	52420.63	28210.21	36203.26	68251.51	36213.32
30002 Cap Toe	31335.53	37981.59	17953.39	31355.12	107428.43	29005.30
30003 Loafers	69753.07	48347.63	69398.59	85729.71	187899.55	64369.46
30004 Lace Ups	40344.55	56337.12	36242.06	48270.08	181307.65	48311.52
30005 Sport	21407.00	45606.82	40227.98	37599.65	99007.52	32145.97
30006 Low Heel	80936.58	75081.69	26781.91	32201.04	182098.19	48204.54
30007 High Heel	37537.14	80199.49	53600.93	37562.53	193188.28	42855.48
30008 Ankle	26851.88	40261.67	37719.94	45710.73	104354.89	42943.69
30009 Knee Length	13065.47	22750.56	11711.21	20096.80	33613.99	22891.90

Figure 4-15 shows a Measure Analysis view that displays Sales data for several items in a particular store. The location/product/calendar dimensional intersection of this view, as shown in the title bar, is SubClass, Channel, WEEK. The Sales measure, because it is registered as a read/write measure, can be edited in this view. However, only an administration user can commit overwrites to writable measures in this workbook.

Accessing Measure Analysis

This section describes the process for accessing Measure Analysis.

1. In the taskflow, select **Administration**. The Administration activity appears with all the subtasks.
2. Click **Measure Analysis**.

Figure 4-16 Measure Analysis Task

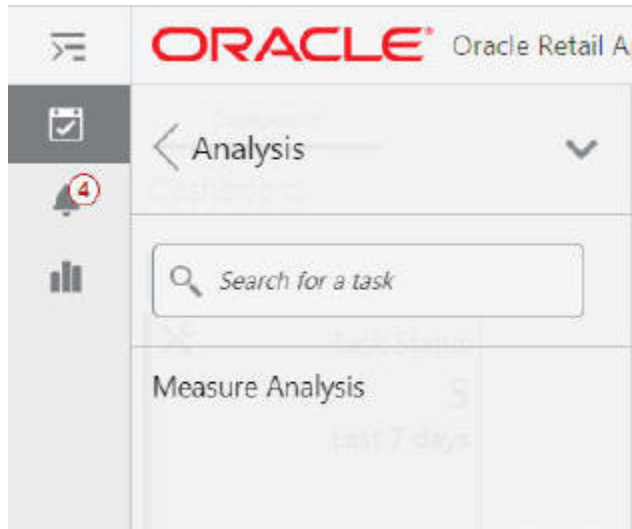

3. The segment dialog box opens. Select **Create New Plan** and enter the label of the segment.

Figure 4-17 Plan Label

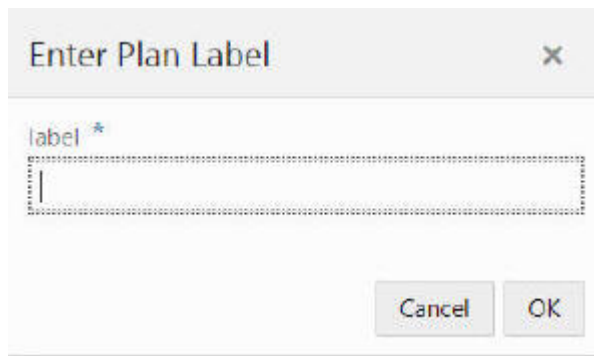

4. A Measure Analysis Wizard window appears. Only measures that are accessible to current users and have the insertable property set to true are displayed. Select the measures to be included in the workbook.

Figure 4-18 Measure Analysis Wizard

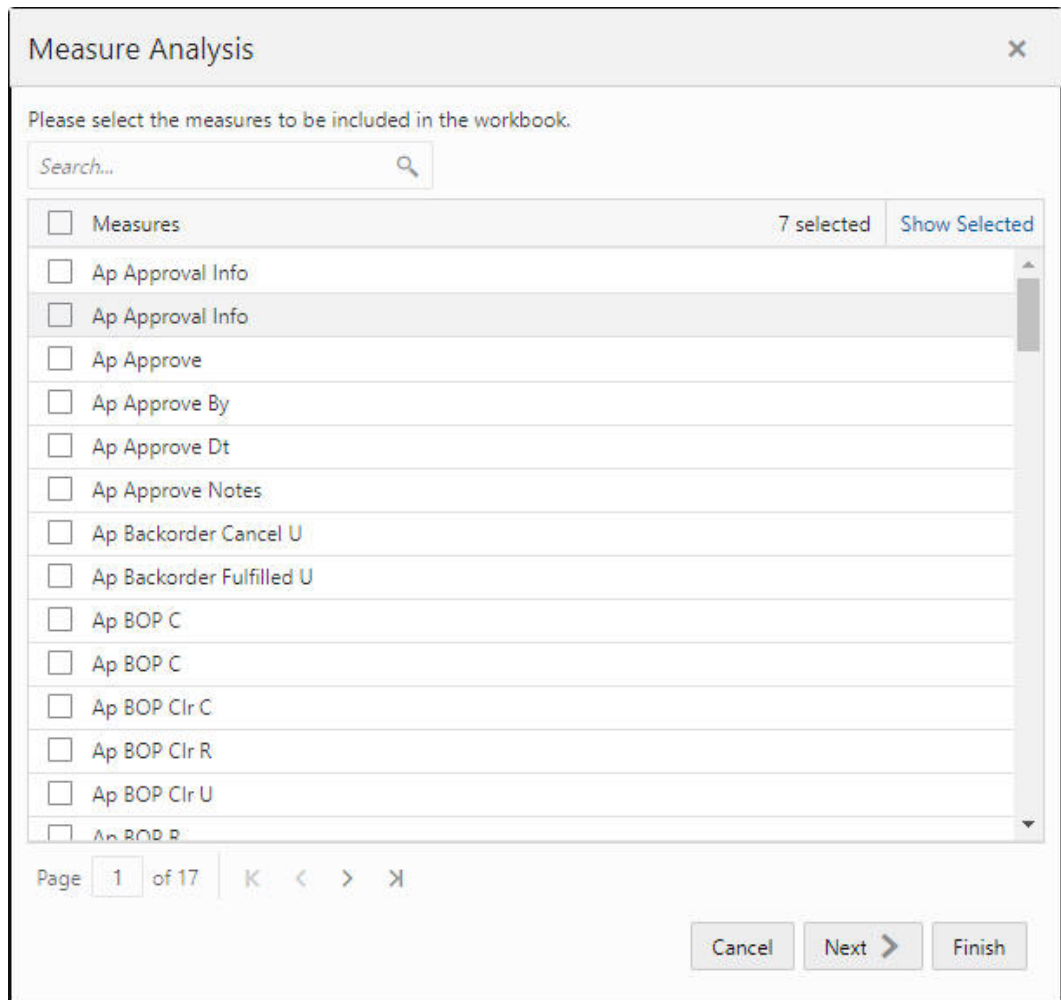

5. Based on the common base intersection of all the measures selected., a sequence of Hierarchy Selection wizards is displayed. Use these wizards to select the positions to be included in the workbook. The Location Selection wizard (as an example) is shown in [Figure 4-19](#).

Figure 4-19 Location Selection Wizard

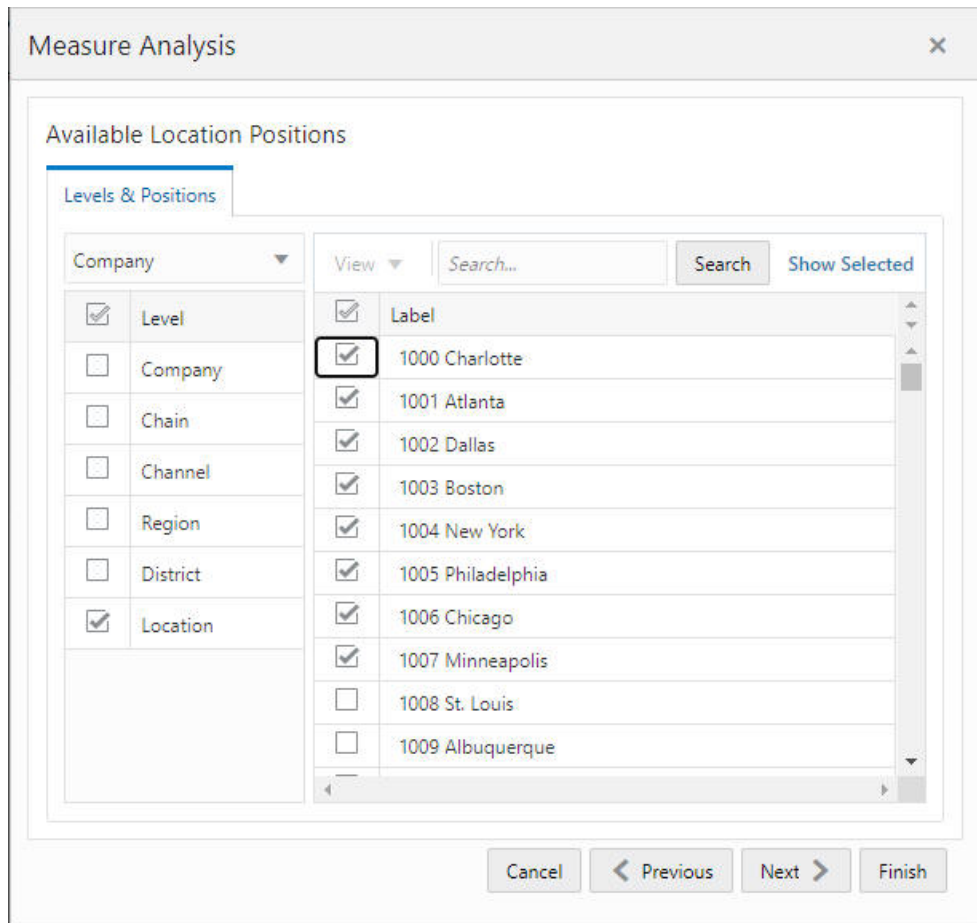







- Use the wizards to make the appropriate selections and click **Finish**. A segment is created, as shown in [Figure 4-20](#).

Figure 4-20 Created Segment

Description	Status	Task Type	Submitted by	Started/Scheduled	Completed
Measure Analysis 01	In Progress	WbBatch Build	oci.admin	9/1/21 7:40:19 AM	
MP After	Success	WbBatch Build	oci.admin	9/1/21 7:34:28 AM	9/1/21 7:39:55 AM
Consignment Maintenance	Success	WbBatch Build	oci.admin	9/1/21 7:19:51 AM	9/1/21 7:20:18 AM
MA 01	Success	WbBatch Build	oci.admin	9/1/21 7:14:02 AM	9/1/21 7:14:42 AM
Health-Check: Pendo Task	Scheduled	hc-pendo-task		9/1/21 8:00:00 PM	

You will receive a notification once the segment is built. You can open it from Recent Plans, as shown in [Figure 4-21](#).

Figure 4-21 Recent Plans

Recent Plans		Refresh
 Measure Analysis 01		
Last Opened	Sep 1, 2021 11:40:10 AM	
 MP After		
Last Opened	Sep 1, 2021 11:34:16 AM	
 MT after HierMain update		
Last Opened	Sep 1, 2021 11:32:11 AM	

7. Click the segment name to open the newly created Measure Analysis segment. The segment has one window per intersection, named with the level names. All measures that have the same base intersection will be added into the same window.

You can edit the measure at the base level if the measure's base state is Write and at the aggregated level if the measure's agg state is Write, provided a valid defSpread method has been configured.

Reviewing and Editing Sales or Other Registered Measure Data

1. In the taskflow, select **Administration**. The Administration activity appears with all the subtasks.
2. Click **Measure Analysis**.
3. The segment dialog box opens. Select **Create New Plan**, and enter the label of the segment. A Measure Analysis Wizard window appears.

Note:

To open an existing Measure Analysis workbook, users can open the segment dialog box from step 3, and then go to step 8.

4. In the Workbook Wizard window, select the measures you want to include in the new workbook. You can use the Search field to filter the list of items if it is available. Use the check boxes to select items or use the All options to select or deselect items in the multi-select list.
5. Click **Next**. Based on each hierarchy specified in the base intersection of the selected measures, a hierarchy wizard appears.
6. In the hierarchy wizard, select the relevant positions and then click **Next**. Repeat this step for each hierarchy wizard.
7. Click **Finish**. A segment is created, and you will receive a notification once the segment is built and can open it from recent plans.

8. On the Measure Analysis View(s), view the stored data associated with the measures and hierarchy positions selected in the wizard. Make any changes as required. As an administrator, you can commit the changes.

XML Schema for Importing Users and Groups

The XML schema contains information for all groups and users that are imported into the application. Since this file can be edited, it does not contain any password information. Each group and user contains an XML attribute with the group or user name as well as the inner tags listed in [Table 4-3](#).



Note:

All XML tags must be in all caps.

Table 4-3 XML Schema Tags

Outer Tag	Inner Tag	Description
GROUP	LABEL	The group's label.
USER	LABEL	The user's label.
USER	DFLT_GRP	The user's default group.
USER	OTHER_GRP	A comma-separated list that contains all the other groups that the user is associated with.
USER	ADMIN	If this value contains T , the user is an admin.
USER	LOCKED	If the value contains T , the user is locked when the file is imported.
USER	INHERITRIGHTS	If this value contains T , the user will inherit the default rights defined for all the groups the user belongs to.

Here is a sample users.xml file.

```
<?xml version="1.0" ?>
<VERSION>1.0</VERSION>
<USER_LIST version="2.0">
  <GROUPS>
    <GROUP NAME="grp1">
      <LABEL>Administrators</LABEL>
    </GROUP>
    <GROUP NAME="grp1">
      <LABEL>Group 1</LABEL>
    </GROUP>
    <GROUP NAME="grp2">
      <LABEL>Group 2</LABEL>
    </GROUP>
    <GROUP NAME="grp3">
      <LABEL>Group 3</LABEL>
    </GROUP>
  </GROUPS>
  <USERS>
    <USER NAME="adm1">
      <LABEL>admin 1</LABEL>
```

```
<DFLT_GRP>adms</DFLT_GRP>
<ADMIN>T</ADMIN>
</USER>
<USER NAME>="adm2">
<LABEL>admin 2</LABEL>
<DFLT_GRP>adms</DFLT_GRP>
<ADMIN>T</ADMIN>
<LOCKED>T</LOCKED>
</USER>
<USER NAME="usr1">
<LABEL>user_1</LABEL>
<DFLT_GRP>grp1</DFLT_GRP>
<OTHER_GRPS>grp2</OTHER_GRPS>
</USER>
<USER NAME="usr2">
<LABEL>user_2</LABEL>
<DFLT_GRP>grp2</DFLT_GRP>
<OTHER_GRPS>grp1,grp3</OTHER_GRPS>
</USER>
<USER NAME="usr3">
<LABEL>user_3</LABEL>
<DFLT_GRP>grp1</DFLT_GRP>
<OTHER_GRPS>grp1</OTHER_GRPS>
</USER>
</USERS>
</USER_LIST>
```

List Logged-In Users

The List Logged-In Users task can be used by the administrator to list all the users logged into the application.

Schedule Dashboard Build

The Dashboard is a feature in RPASCE that is loaded when a user first logs into the system. The dashboard gives you access to key statistics. You can use the dashboard to analyze the health of the business. The dashboard must be refreshed periodically, as new products and locations are added. This typically happens weekly, but depends on your administrator's settings. The measure data of existing products and locations in the dashboard can be refreshed at any time to view updated changes.

The dashboard is supported by a workbook template that must be configured based on the customer business. It also requires the configuration of a JSON file using the Config Tools and uploaded during the building of the application. See *Oracle Retail Predictive Application Server Cloud Edition Configuration Tools User Guide* for more information.

The dashboard workspace can be built using Schedule Dashboard Build, which can be accessed from the System Administration Tasks Online Admin task group.

Figure 4-22 Schedule Dashboard Build

Submit a New Admin Task ✕

Specify the arguments for task:

Task Label
Schedule Dashboard Build

Override RPAS_TODAY? Uncheck to default system setting

Range dimension
Year

Pre-Season Range
1

Post-Season Range
1

Delete and Recreate Dashboard Segment? (Warning : Use this option only if dashboard template styles are patched. Dashboard will loose all user formatting if we delete and recreate segment.)

For

All users

Group
MFP Admin

Users

Cancel < Previous Next > Finish

The following options are available:

 **Note:**

For the configured GA dashboard profiles, the preferred selections are
Range dimension: Half, Pre-Season Range: 1, and Post-Season Range: 1

- Task Label. Enter the name of the build task in order to review the status of a build.
- Override RPAS_TODAY (Optional). Select the check box to indicate that the task level RPAS_TODAY has priority over the application level RPAS_TODAY.
- Range dimension. The Calendar dimension against which the dashboard is pre-ranged.
- Pre-Season Range. The number of periods of the Range level that must be included before RPAS_TODAY.
- Post-Season Range. The number of periods of the Range level that must be included after RPAS_TODAY.

- Delete and Recreate Dashboard Segment. Use only if the dashboard template styles are patched. The use of this option results in the loss of all dashboard formats.

Note that if the Delete and Recreate Dashboard Segment is checked, the segment will not be deleted if the user is currently logged into the application. The task does not fail, but this message will be in the log: "Unable to delete the dashboard segment for the User." The effect of this is that the user will not see the dashboard template style changes (such as adding a new view) which necessitated the Delete and Recreate.

- Users. Select who can access the dashboard: All Users or User Groups.

5

Online Administration Tools

The RPASCE Online Administration interface allows the application administrator to manage back-end operations on a application from the RPASCE Client. The Online Administration interface consists of two parts. The first part is a set of activities in the taskflow that authorized users access in order to launch and manage back-end processes from the Client. The second part is a dashboard that an administrator uses to monitor the status of all the administration tasks after they have been submitted.

This chapter contains the following sections:

- [Online Administration Tools Templates](#)
- [Service Request Administration Tasks](#)
- [Bootstrap Administration Tasks](#)
- [Application Administration Tasks](#)

Online Administration Tools Templates

Several wizard-only workbook templates are available that the RPASCE administrator can use to manage RPASCE administration tasks on the RPASCE server. These templates are located in the workbook template group called Online Admin Tools, which is available from the task flow menu under Administration.

Use the following menu to access the administration tools.

Figure 5-1 Online Administration Tools

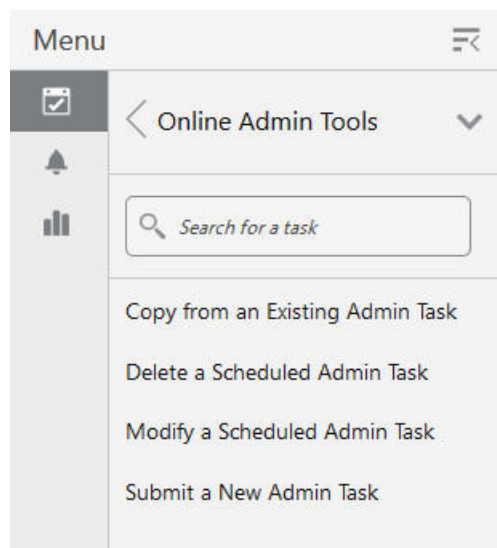

Copy from an Existing Admin Task

This template allows the administrator to copy a scheduled or completed administration task. The first wizard page provides a drop-down list for the user to select a task. Subsequent wizard pages are similar to those in the Submit a New Admin Task template, but with the argument selections populated with the values of the existing task.

A new label for the task must be entered.

Delete a Scheduled Admin Task

This template allows the user to delete an active task that has been scheduled but not yet started. The list only included scheduled tasks.

Modify a Scheduled Admin Task

This template allows the user to modify a scheduled administration task. The first wizard page provides a drop-down list for the user to select a task. Subsequent wizard pages are similar to those in the Submit a New Admin Task template, but with the argument selections populated with the values of the existing task.

A new label for the task must be entered.

Submit a New Admin Task

The Submit an Administration Task template is a multiple-page template in which the contents of each page are dependent upon the selection of the previous page.

The first wizard page prompts the user to choose one of the task lists available in the application.

The second wizard page is used for selecting one of the pre-defined tasks.

A job label is required that identifies the submitted task. A meaningful label is recommended since it is the identifier of the task when its status is displayed. The uniqueness of the job label is not checked. It is the user's responsibility to ensure that the name is recognizable.

From the third wizard page, the user selects or enters the command line arguments for the selected task. A job label is required that identifies the submitted task. A meaningful label is recommended since it is the identifier of the task when its status is displayed. The uniqueness of the job label is not checked. It is the user's responsibility to ensure that the name is recognizable.

If the argument list contains argument branches, another wizard page will be generated based on the user's selection of the branches. This is done recursively until all argument branches are exhausted. After all arguments are specified, the next and final wizard page, which is used for scheduling options, is displayed.

The user sees the Confirm Action page. Verify the options on this page and click **Finish** to submit this task for execution.

General Submission Workflow

All task submissions follow a common workflow.

Select a Task Group

The first step is to select the group to which the intended task belongs. Common groups are System Administration Tasks and Configured Batch Tasks.

Figure 5-2 Task Groups in the Online Admin Group

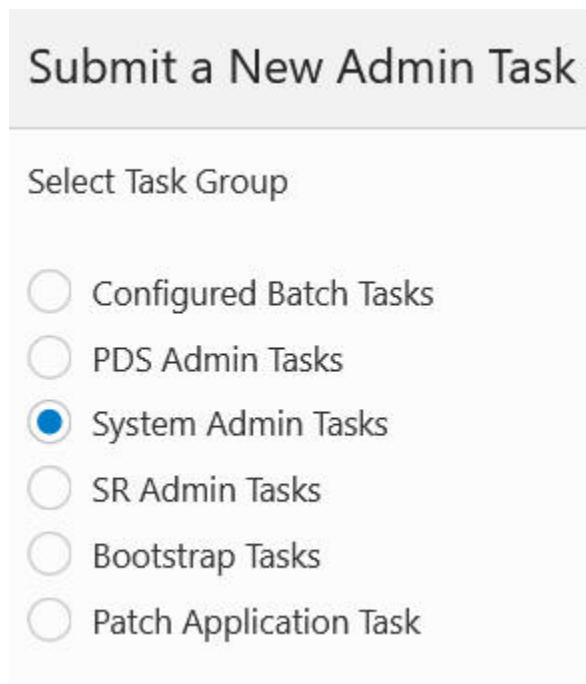

Submit a New Admin Task

Select Task Group

- Configured Batch Tasks
- PDS Admin Tasks
- System Admin Tasks
- SR Admin Tasks
- Bootstrap Tasks
- Patch Application Task

Select a Task

Click **Next**. The wizard shown in [Figure 5-3](#) provides a list of available tasks within the group.

Figure 5-3 Tasks in System Administration Task Group

The screenshot shows a web interface for submitting a new admin task. At the top, there is a header 'Submit a New Admin Task'. Below it, a section titled 'Select A Task From System Admin Tasks Group' contains a search input field with the placeholder text 'Search...' and a magnifying glass icon. Below the search field is a list of tasks, each in a separate row with a horizontal line separator. The task 'Manage Informal Positions' is highlighted with a light blue background. The tasks listed are: Enable/Disable Toggleable Features, Export Hierarchy Data, Export Measure Data, Expressions, Rules and Rule Groups Information, List Users Currently Logged-In, List/Set/Unset PDS Environment Variable, Load Interface Mappings, Manage Dimensions, Manage Hierarchies, Manage Informal Positions, Manage Users, Manage Workspaces, Measure Information, Oracle Support Administration, and Purge Tasks from Task Status Dashboard.

Task Name
Enable/Disable Toggleable Features
Export Hierarchy Data
Export Measure Data
Expressions, Rules and Rule Groups Information
List Users Currently Logged-In
List/Set/Unset PDS Environment Variable
Load Interface Mappings
Manage Dimensions
Manage Hierarchies
Manage Informal Positions
Manage Users
Manage Workspaces
Measure Information
Oracle Support Administration
Purge Tasks from Task Status Dashboard

Setting Parameters

Once you select a task, you must set the parameters using the wizard, as shown in [Figure 5-14](#). Common parameters are:

- Task Label - This is the label that is used to identify the task in the Task Dashboard, Copy Admin Task, Delete Admin Task, and Modify Admin Task.
- Exclusive Mode Message - The task is defined as an offline or exclusive task. The user can provide this optional message to be shown to other users while the task

is executing. The system is performing offline operation and the capability of the user session is limited.

- RPAS_TODAY Override - If the task supports the RPAS_TODAY override, then a check box and date/time control are available for the user to specify an RPAS_TODAY override value. Control is not visible if the override check box is unchecked.

Depending on the task selected, and the parameter provided in each wizard page, additional parameter pages may be added for the user to complete the selection of all parameters.

Schedule Task is available with the options One Time, Hourly, Daily, Weekly, Monthly scheduling as shown in [Figure 5-4](#) through [Figure 5-13](#).

Figure 5-4 One Time Schedule

Submit a New Admin Task

Schedule Task

Run ASAP

Run on a schedule

One time ▼

Local Start Date/Time:

2021/12/03 09:47:25 PM

Click **Next**. You see the confirmation.

Figure 5-5 One time Schedule Confirmation

Submit a New Admin Task

Verify and Confirm Before Clicking Finish

Action
Submit An Admin Task

Task
List Users Currently Logged-In (System Admin Tasks)

Description
Displays all the currently logged-in users & number of active sessions per user

Label
List Users Currently Logged-In

Execute:
Execute one time on 2021/12/03 09:47:25 PM

Click **Finish** to complete the task.

Figure 5-6 Hourly Schedule

The screenshot shows a web-based form titled "Submit a New Admin Task". Under the "Schedule Task" section, the "Run on a schedule" option is selected. The frequency is set to "Hourly". The start time is 08:00 and the stop time is 20:00. The task is scheduled to run every 1 hour. The days of the week are checked from Monday to Friday, with Sunday and Saturday unchecked.

Submit a New Admin Task

Schedule Task

Run ASAP

Run on a schedule

Hourly

Local Start Date/Time:
2021/12/03 09:47:25 PM

Local Stop Date/Time:
2021/12/30 10:47:26 PM

Recur Every:
1 Hour

Start Hour:
08:00

Stop Hour:
20:00

Sunday

Monday

Tuesday

Wednesday

Thursday

Friday

Saturday

Figure 5-7 Hourly Schedule Confirmation

Submit a New Admin Task

Verify and Confirm Before Clicking Finish

Action

Submit An Admin Task

Task

List Users Currently Logged-In (System Admin Tasks)

Description

Displays all the currently logged-in users & number of active sessions per user

Label

List Users Currently Logged-In

Execute:

Execute with a schedule (Hourly)

Recur every hour from 08:00 to 20:00 on Monday, Tuesday, Wednesday, Thursday, Friday

Scheduled to run from 2021/12/03 09:47:25 PM to 2021/12/30 10:47:26 PM

Figure 5-8 Daily Schedule

Submit a New Admin Task

Schedule Task

Run ASAP

Run on a schedule

Daily ▾

Local Start Date/Time:
2021/12/03 09:47:25 PM 

Local Stop Date/Time:
2021/12/30 10:47:26 PM 

Sunday

Monday

Tuesday

Wednesday

Thursday

Friday

Saturday

Figure 5-9 Daily Schedule Confirmation

Submit a New Admin Task

Verify and Confirm Before Clicking Finish

Action

Submit An Admin Task

Task

List Users Currently Logged-In (System Admin Tasks)

Description

Displays all the currently logged-in users & number of active sessions per user

Label

List Users Currently Logged-In

Execute:

Execute with a schedule (Daily)

on Monday, Tuesday, Wednesday, Thursday, Friday

Scheduled to run from 2021/12/03 09:47:25 PM to 2021/12/30 10:47:26 PM

Figure 5-10 Weekly Schedule

Submit a New Admin Task

Run ASAP

Run on a schedule

Weekly ▾

Local Start Date/Time:
2021/12/03 09:47:25 PM 

Local Stop Date/Time:
2021/12/30 10:47:26 PM 

Recur Every:
1 week on ▾

Sunday

Monday

Tuesday

Wednesday

Thursday

Friday

Saturday

Figure 5-11 Weekly Schedule Confirmation

Submit a New Admin Task

Verify and Confirm Before Clicking Finish

Action
Submit An Admin Task

Task
List Users Currently Logged-In (System Admin Tasks)

Description
Displays all the currently logged-in users & number of active sessions per user

Label
List Users Currently Logged-In

Execute:
Execute with a schedule (Weekly)
Recur every week on Monday, Tuesday, Wednesday, Thursday
Scheduled to run from 2021/12/03 09:47:25 PM to 2021/12/30 10:47:26 PM

Figure 5-12 Monthly Schedule

Submit a New Admin Task

Schedule Task

Run ASAP

Run on a schedule

Monthly ▾

Local Start Date/Time:
2021/12/03 09:47:25 PM 

Local Stop Date/Time:
2021/12/30 10:47:26 PM 

Recur Every:
2 months on ▾

Days:
1,2,5-8,20-28

Figure 5-13 Monthly Schedule Confirmation

Submit a New Admin Task

Verify and Confirm Before Clicking Finish

Action

Submit An Admin Task

Task

List Users Currently Logged-In (System Admin Tasks)

Description

Displays all the currently logged-in users & number of active sessions per user

Label

List Users Currently Logged-In

Execute:

Execute with a schedule (Monthly)

Recur every 2 months on 1,2,5-8,20-28

Scheduled to run from 2021/12/03 09:47:25 PM to 2021/12/30 10:47:26 PM

Figure 5-14 Sample Wizard Page - Accepting Parameter Input

Submit a New Admin Task

Specify the arguments for task:

Task Label

Exclusive Mode Message

Override RPAS_TODAY? Uncheck to default system setting

RPAS_TODAY



Batch Calculation Group

Log level

RPAS_TODAY Use Case

A customer wants to run one of the time-intensive tasks on Friday night. On the subsequent Monday morning, the customer checks the task status and finds it failed (due to either a mistake made in the input or an error in the batch script). After fixing the issue, the customer can re-run the batch using the date of last Friday to ensure any date-dependent calculation will have the correct values.

 **Note:**

This option is to set the RPAS_TODAY for, and only for, a particular task without changing the RPAS_TODAY on a systemwide basis. If a systemwide change is desired, the user must use the List/Set/Unset Environment Variable OAT task to change the value of RPAS_TODAY. The user is required to log out and re-log in to have his/her user session updated. Any tasks started after the ENV value is changed will have the new RPAS_TODAY set. Note that RPAS_TODAY is a static value. For example, if the value 20200201 is set today, tasks that are scheduled to run tomorrow will continue to have RPAS_TODAY=20200201.

Setting the Schedule

After all the parameters are set, use the next wizard page to set when the task will execute, as shown in [Figure 5-15](#) and [Figure 5-16](#).

- ASAP - as soon as the system is available to execute.
- On a schedule:
 - One time - specify a time in the future for the task to execute.
 - Hourly, Daily, Weekly, Monthly - specify a recurring setting for the task to execute.
- Start Date/Time - This is the time the task will execute for the first time. Note the first time execution. The recurring schedule will only be considered after the first run.
- Stop Date/Time - For recurring tasks, specify the time the schedule ends.

Figure 5-15 Schedule Task ASAP

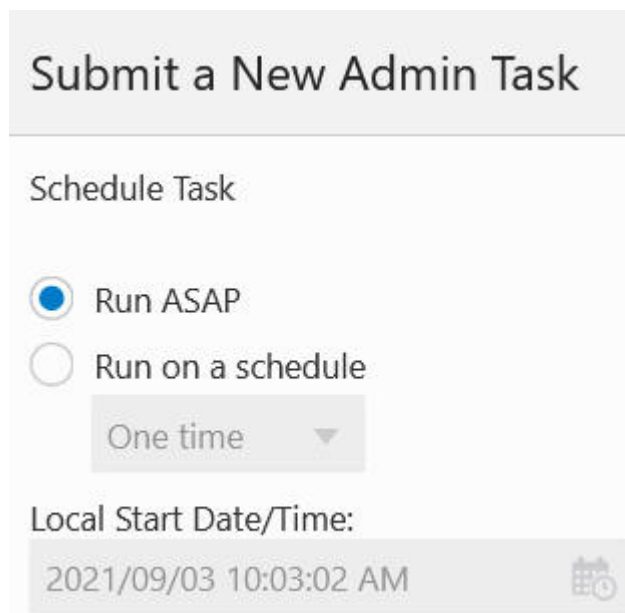

Submit a New Admin Task

Schedule Task

Run ASAP

Run on a schedule

One time ▼

Local Start Date/Time:

2021/09/03 10:03:02 AM 

Figure 5-16 Schedule Task By Time

Submit a New Admin Task

Schedule Task

Run ASAP

Run on a schedule

One time ▼

One time

Hourly AM

Daily

Weekly

Monthly

Confirmation

After you are finished setting the parameters, you see the confirmation page, as shown in [Figure 5-17](#). It lists out all the parameter settings and schedule settings. If everything is correct, click **Finish** to submit the task to the system. If the task supports `RPAS_TODAY` and the user overrides the value, the new value is also displayed on this page.

Figure 5-17 Confirmation for Task with Pending Submission

Submit a New Admin Task

Verify and Confirm Before Clicking Finish

Action
Submit An Admin Task

Task
Run Batch Calc Group (Configured Batch Tasks)

Label
Run Batch Calc Group

RPAS_TODAY
2023-01-01

Batch Calculation Group
Generate Forecast

Execute:
Execute with a schedule (Daily)
Recur every day
Scheduled to run from 2021/09/03 02:03:02 PM to 2021/09/03 03:03:03 PM

Task Status Dashboard

To check the status of the task, use the Task Status Dashboard template under the Administration, as shown in [Figure 5-18](#).

Figure 5-18 Access to Task Status Dashboard

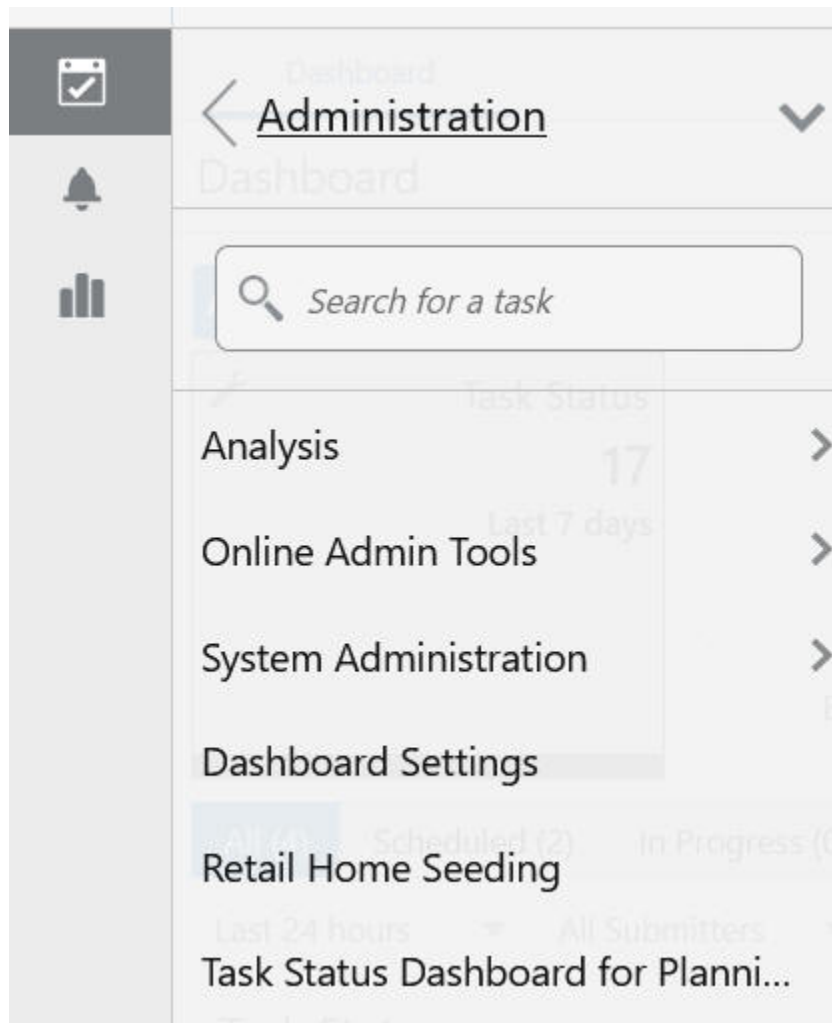

It displays a dashboard, shown in [Figure 5-19](#), that lists all the tasks and their status. The list can be filtered based on the date/time of the execution, the submitter/owner of the tasks, the type of the tasks, or the status of the tasks.

Figure 5-19 Task Status Dashboard View

All (23)
Scheduled (2)
In Progress (0)
Completed (16)
Failed (5)

Last 7 days
All Submitters
All Task Types

Task Status

Actions
View
 Refresh
 Detach
 Auto-Refresh
 Download Log
 Watch Live Log

Description	Status	Task Type	Submitted	Started/Sched	Completed	Record Status
Security Administrati...	Success	WbBatch Build	oci.ad...	9/3/21 1:5...	9/3/21 1:5...	—
Health-Check: Pendo...	Sched...	hc-pendo-task		9/3/21 8:0...		—
Perf Diag 03	Failed	WbBatch Build	oci.ad...	9/2/21 6:4...	9/2/21 6:4...	—
Perf Diag 02	Failed	WbBatch Build	oci.ad...	9/2/21 6:4...	9/2/21 6:4...	—
Perf Diag 01	Failed	WbBatch Build	oci.ad...	9/2/21 6:3...	9/2/21 6:3...	—
Perf Diag 01	Failed	WbBatch Build	oci.ad...	9/2/21 6:3...	9/2/21 6:3...	—
Health-Check: Pendo...	Success	hc-pendo-task		9/2/21 8:0...	9/2/21 7:5...	—
List Users Currently L...	Failed	List Users Currentl...	oci.ad...	9/1/21 10:...	9/1/21 10:...	—
Measure Analysis 01	Success	WbBatch Build	oci.ad...	9/1/21 7:4...	9/1/21 7:4...	—
MP After	Success	WbBatch Build	oci.ad...	9/1/21 7:3...	9/1/21 7:3...	—

For any completed task, the user can download the log by selecting the row and clicking **Watch Live Log** or **Download Log** to fetch the log for the task. See [Task Status Dashboard](#).

Email Notification for OAT Tasks

You can configure an email notification for each OAT task so that, when an OAT task ends, an email notification is sent the registered email addresses of the status of the task. Each OAT task and its success or failed status can be individually assigned one or more email addresses. This can be done through the Notification Administration interface of Retail Home.

Complete the following steps to configure email notifications.

1. Click the **Gear** icon on the bottom left corner of the page.

Figure 5-20 Access to Notifications Menu

List Users Currently L...	Failed	List Users Currentl...
Measure Analysis 01	Success	WbBatch Build
MP After	Success	WbBatch Build
Consignment Mainte...	Success	WbBatch Build
MA 01	Success	WbBatch Build
Health-Check: Pendo...	Success	hc-pendo-task
MT after HierMain u...	Success	WbBatch Build

- From the Settings menu, select Manage Notifications, as shown in [Figure 5-21](#).

Figure 5-21 Manage Notifications

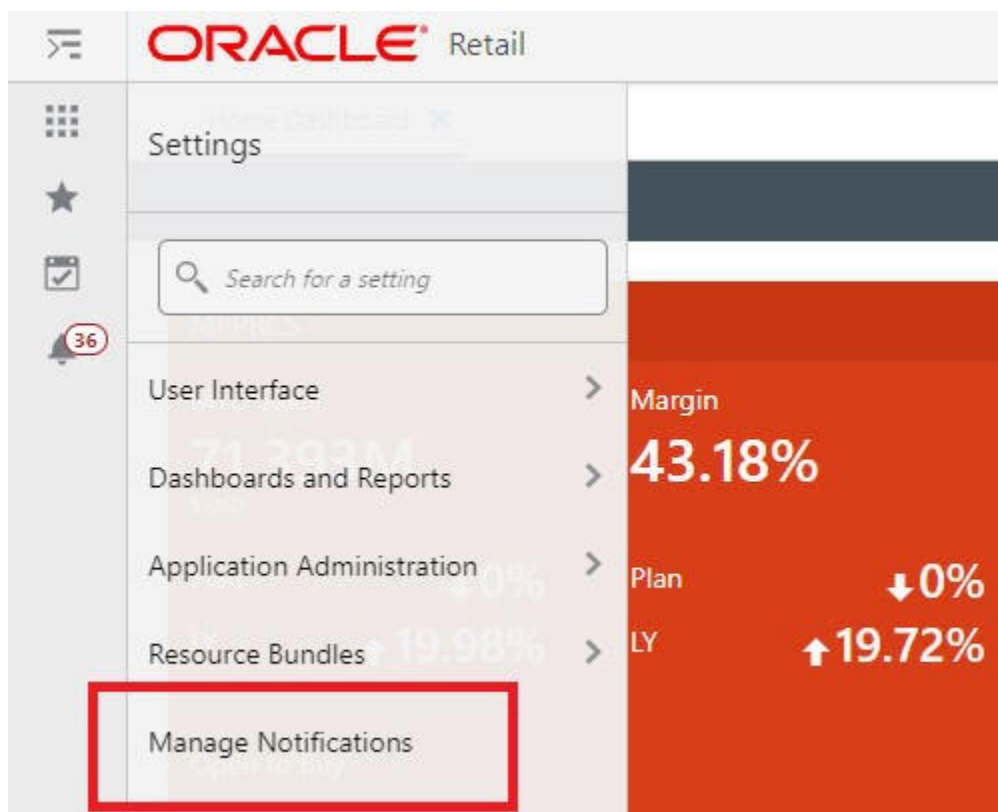

- Select the desired application from the drop-down list, as shown in [Figure 5-22](#).

Figure 5-22 Select Application



4. Select the notification for which you want to send email. Each OAT task has two corresponding notification types with the prefix Admin Task Failed - or Admin Task Success -, along with the task label for each.

Select the notification type for which you want to receive email.

Figure 5-23 Notification Types

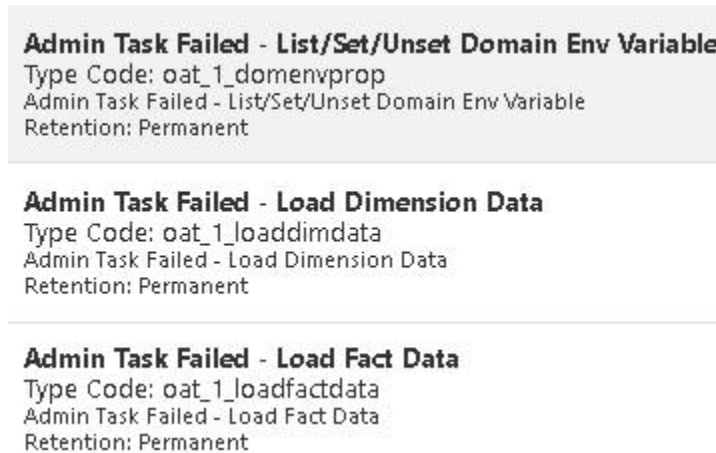

5. Select the **Pencil** icon to edit the notification type, as shown in [Figure 5-24](#).

Figure 5-24 Edit Notifications



6. In the Edit Notification Type dialog box shown in [Figure 5-24](#), enter the email address where the notification will be sent.

You can add one or more email addresses using the Edit Notification Type dialog box. Each address must be separated by either a space or a comma.

Do not modify the type code of the notification type.

Note that the generic Admin Task Complete and Admin Task Failed that does not have a task label suffix cannot be configured for email notification.

Figure 5-25 Edit Notification Type

Notification Type * Admin Task Failed - List/Set/Unset Dc
Name

Type Code * oat_1_domenvprop

Description * Admin Task Failed - List/Set/Unset
Domain Env Variable

Retention Permanent

Email Address

Cancel OK

Sample email notifications for a status of success and failed are shown in [Figure 5-26](#) and [Figure 5-27](#).

Figure 5-26 Email Notification: Success

Admin Task Notification: Check Domain Information

 Status - **Success**

Application: MFPRCS

Environment: Staging

Task Type: Domain Information

Started: Thu, 1 Jul 2021 05:26:50 GMT

Completed: Thu, 1 Jul 2021 05:26:50 GMT

Submitted by: justin@company.com

[Retail Predictive Application Server Cloud Edition Documentation](#)

Copyright © 2021, Oracle Corporation. All Rights Reserved.

Figure 5-27 Email Notification: Failed

Admin Task Notification: Backup domain Task

✘ Status - Failed

Application: MFPRCS

Environment: Production

Task Type: Backup Domain

Started: Thu, 1 Jul 2021 05:26:55 GMT

Completed: Thu, 1 Jul 2021 05:27:01 GMT

Error Message: Error: Process exited with status: 18

Submitted by: oci.admin

[Retail Predictive Application Server Cloud Edition Documentation](#)

Copyright © 2021, Oracle Corporation. All Rights Reserved.

System Administration Tasks

Table 5-1 lists the system administration tasks available for the RPASCE platform.

Table 5-1 System Administration Tasks

Administration Task Name	Administration Task Label	Description	RPAS_TODAY Available
dimensionMgr	Manage Dimensions	Display properties for the selected dimension.	
exportHier	Export Hierarchy Data	Export all the positions in a hierarchy, including their roll-up relations.	
exportMeasure	Export Measure Data	Export application/workbook (single/multiple) measure data to a CSV or a fixed-width file format.	

Table 5-1 (Cont.) System Administration Tasks

Administration Task Name	Administration Task Label	Description	RPAS_TODAY Available
hierarchyMgr	Manage Hierarchies	Display all the hierarchies in an application and their properties.	
informalPositionMgr	Manage Informal Positions	Maintain informal positions for DPM-enabled dimension in an application.	
listActiveUsers	List Users Currently Logged-In	Display all the currently logged-in users and number of active sessions per user. From the UI, to export a list of active users to the outgoing/logs folder in the object store, select the check box Export list of logged-in users file to outgoing/logs path in Object Store. A csv file will be created at the destination. When listActiveUsers run from the back end, append the argument -export to the task to generate the csv file.	
mace	Expressions, Rules and Rule Groups Information	Display information about expressions, rules, and rule groups.	
pdsProperties	View and Manage PDS Properties	Display, reset, and update different properties of an application.	
pdsProperties	List/Set/Unset PDS Env Variable	List, Set, or Unset the application environment variable.	
printMeasure	Measure Information	Display measure information.	
purgeOatQueues	Purge Tasks from Task Status Dashboard	The purgeOatQueues task in older versions of RPAS has been replaced with Purge Tasks from Task Status Dashboard Task. It is not possible to migrate or upgrade previously scheduled purgeOatQueues tasks automatically. You must reschedule using Purge Tasks from Task Status Dashboard Task instead.	
renamePositions	Rename Positions	Change the name of one or more positions.	
scheduledashboard	Schedule Dashboard Build	Schedule creation of a dashboard workbook for single user/all users/all users of a group.	X

Table 5-1 (Cont.) System Administration Tasks

Administration Task Name	Administration Task Label	Description	RPAS_TODAY Available
sqlldr and transferFiles	Load Interface Mappings	Load interface mappings between RDX and PDS.	
updateFeatureToggles	Enable/Disable Toggleable Features	Enable/disable toggleable business features.	
updateOptionalUIProperties	Oracle Support Administration	Enable optional UI properties for use in UI settings.	
usermgr	Manage Users	Manage user/group (add/remove/print/import/export/lock/unlock).	
wbatch	Segment/Workspace Batch Operation	Manage segment/workspace batch operations.	X
wbmgr	Manage Workspaces	Inspect or remove existing workbooks.	

Manage DimensionsTask

The Manage Dimensions task is used for displaying dimension properties.

Here is the list of properties that this argument returns:

- Dimension label
- Associated hierarchy of the dimension
- Width of the dimension
- Label width of the dimension
- DPM enabled
- Image enabled
- Attribute measure
- User-defined
- Used positions
- Translation enabled
- Spreads or aggs (that is, where the dimension fits in the rollup)
- If the dimension is at the base level of an indicated hierarchy
- Virtual dimension

Select Dimension

This is the drop-down list of dimensions. This task returns properties about the selected dimension. These properties can be used to check if DPM and translation are enabled for the dimension, if the dimension is image-enabled, and so on.

Dimension Attribute Manager Task

The Dimension Attribute Manager task is accessed from the Submit a New Admin Task. It can be used for the following actions.

- Register a dimension attribute
- Unregister a dimension attribute
- Report

Figure 5-28 Dimension Attribute Manager

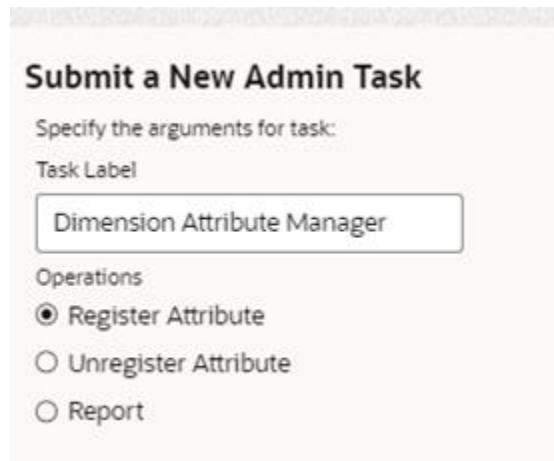

Submit a New Admin Task

Specify the arguments for task:

Task Label

Dimension Attribute Manager

Operations

Register Attribute

Unregister Attribute

Report

Register Attribute

Use this option to register a new dimension attribute. The register option shows only the relevant measures that are configured as an attribute measure in the configuration (for any hierarchy).

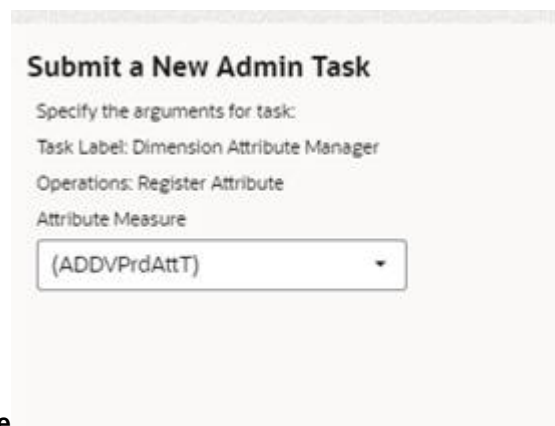

Submit a New Admin Task

Specify the arguments for task:

Task Label: Dimension Attribute Manager

Operations: Register Attribute

Attribute Measure

(ADDVPrdAttT)

Figure 5-29 Register Attribute

In the example shown in the above figure, the measure ADDVPrdAttT is visible because it is marked as the attribute measure for level skup in the configuration as shown in the following figure.

Figure 5-30 Attribute Measure

Dimensions																
Tool Name	Code	Start	Width	Label Start	Label Width	Aggr	Database	User Dimension	Translate	Cardinality	Re-indexing Threshold	Enable DPM	Enable Images	Attribute Measure	Virtual Dimension	
sku	0	1	25	26	250		skuat	<input type="checkbox"/>	<input checked="" type="checkbox"/>	Extremely Large (500K..)	419430	<input checked="" type="checkbox"/>	<input checked="" type="checkbox"/>		sku	
skup	1	276	45	321	250	sku	skuat	<input type="checkbox"/>	<input checked="" type="checkbox"/>	Extremely Large (500K..)	419430	<input checked="" type="checkbox"/>	<input checked="" type="checkbox"/>	ADDVPrdAttT	skup	
skup	4	571	23	596	250	skup	skuat	<input type="checkbox"/>	<input checked="" type="checkbox"/>	Very Large (100K-500K)	104837	<input checked="" type="checkbox"/>	<input checked="" type="checkbox"/>		skup	
scl	5	846	23	871	250	skup	skuat	<input type="checkbox"/>	<input checked="" type="checkbox"/>	Large (12K-100K)	13107	<input type="checkbox"/>	<input type="checkbox"/>		scl	
cls	6	1121	23	1146	250	scl	skuat	<input type="checkbox"/>	<input checked="" type="checkbox"/>	Large (12K-100K)	13107	<input type="checkbox"/>	<input type="checkbox"/>		cls	
dept	7	1396	23	1421	250	cls	skuat	<input type="checkbox"/>	<input checked="" type="checkbox"/>	Medium (80K-12K)	1658	<input type="checkbox"/>	<input type="checkbox"/>		dept	
ppp	8	1671	23	1696	250	dept	skuat	<input type="checkbox"/>	<input checked="" type="checkbox"/>	Small (100-800)	102	<input type="checkbox"/>	<input type="checkbox"/>		ppp	
div	9	1946	23	1971	250	ppp	skuat	<input type="checkbox"/>	<input checked="" type="checkbox"/>	Small (100-800)	102	<input type="checkbox"/>	<input type="checkbox"/>		div	

When you select the measure and click **Next**, you see a drop-down list containing all the attributes that are associated with attribute measure selected in the previous page. Select an attribute from the drop-down list that you want to be registered. In this example, the measure ADDVPrdAttT is the attribute measure for level skup. Level skup belongs to the prod hierarchy. The attribute hierarchy for prod hier is patr, as shown in the following figure.

Figure 5-31 Attribute Hierarchy

Hierarchies							
Tool Name	RPAS Name	User Label	Page Age	Order	Security Dimension	Attribute Hierarchy	
CLND	CLND	Calendar	10000	999			
PROD	PROD	Product	10000	1001	cls	PATR	
LOC	LOC	Location	10000	1002			
ADMU	ADMU	Admu	10000	1003			
LNGS	LNGS	Lngs	10000	1004			
PATR	PATR	Product Attributes	10000	1005			

In this example, the attributes in the drop-down list are positions that belong to the patr hierarchy.

Unregister Attribute

Use the Unregister Attribute option to unregister a dimension attribute that has already been registered in the PDS. The options and details are the same as the register option above.

Report

The Report option displays a log of dimension attributes that already exist in the PDS. To simplify the report to see only the necessary information, set the log level to error or warning. The report option includes the old format of dimension attributes - single dimension attributes.

Load Alternate Rollup Data Task

Load Alternate Rollup Data task is used to load data for alternate rollups in any hierarchy. This task is available under PDS Admin Tasks.

Figure 5-32 Select Alternate Rollup Data

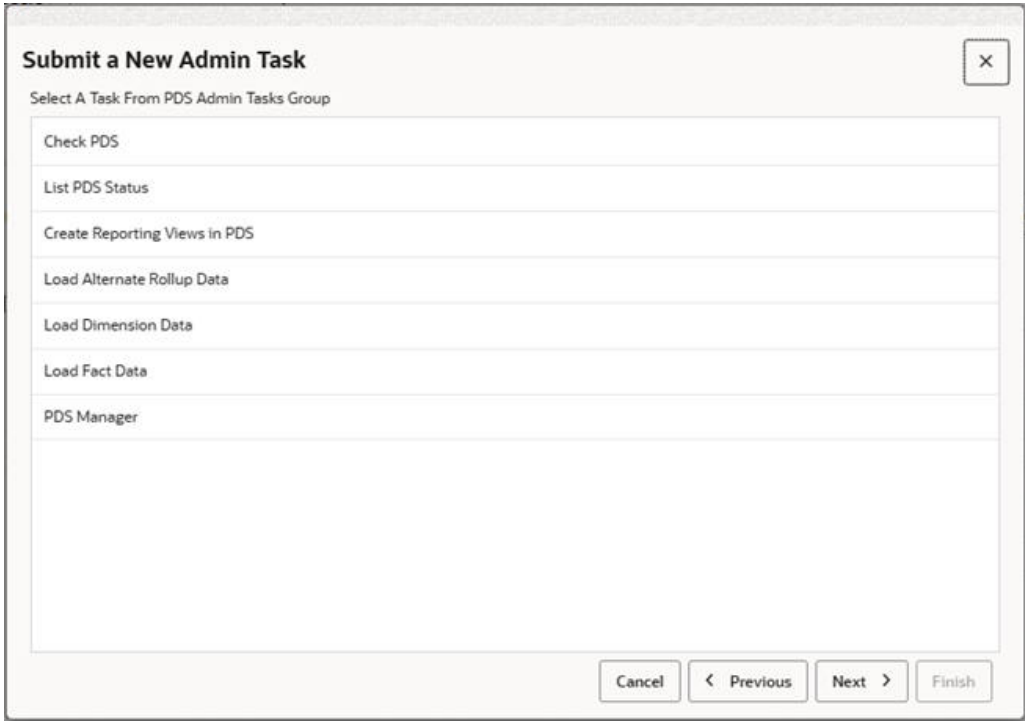
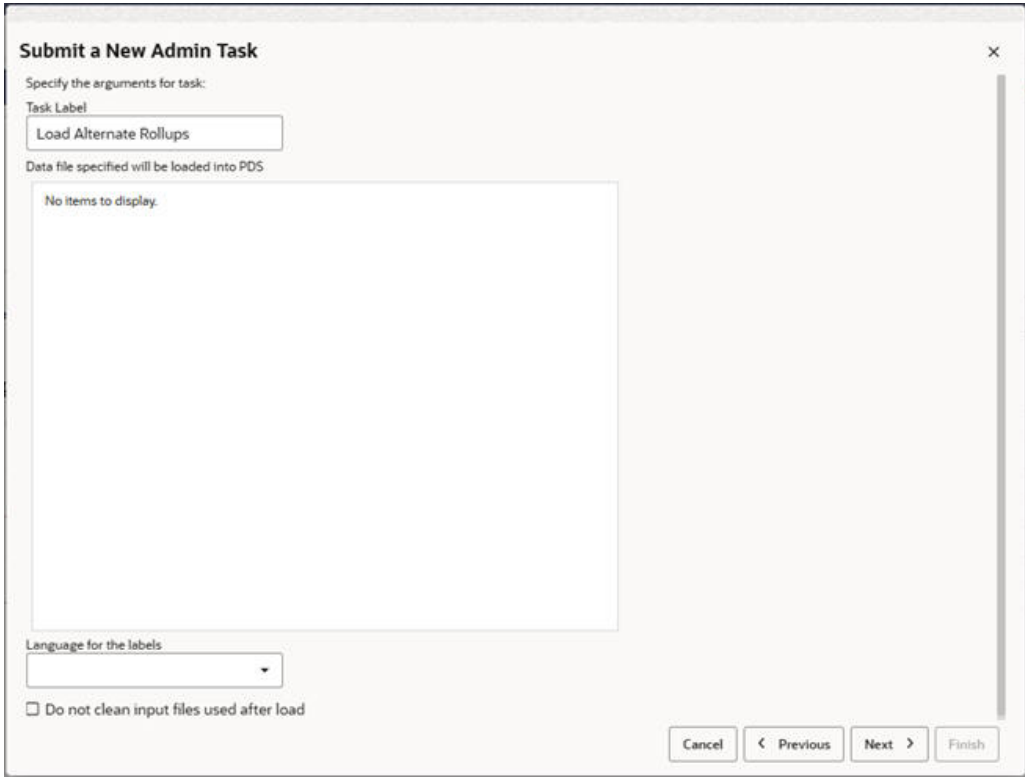

Figure 5-33 Load Alternate Rollups Task



An input file of type *.csv.dat is passed to the utility. The input file must contain the level below the alternate levels, followed by the alternate levels in that spine. Examples are listed below.

Consider the follow hierarchy.

Figure 5-34 Example Hierarchy



To load rgng, the input files are as follows:

regn, rgng,rgng_label

regn_1, rgng_1, rgng_1_label

To load chng, the input file is of type:

chan,chng,chng_label

chan_1, chng_1, chng_1_label

If there is another level above chng that is called chnr, then input file is of type:

chan,chng,chng_label,chnr,chnr_label

chan_1,chng_1,chng_1_label,chnr_1,chnr_1_label

Options for the Task

- Task Label
Provide a label for the task

- Data file specified to be loaded into PDS
The input files must be uploaded to Object Storage under incoming/input. Once the files are uploaded, they will be visible in the OAT Task under Data file specified will be loaded into PDS.
- Language for the labels
Select a language for the labels. If not specified, English US will be used.
- Do not clean input files after load
If checked, input files will not be deleted from Object Storage.

Oracle Support Administration

The Oracle Support Administration task enables additional UI settings for use in the System Configuration menu. Do not run this task unless instructed to do so by Oracle Support personnel.

See the *Oracle Retail Predictive Application Server Cloud Edition User Guide* for more details about this task.

Figure 5-35 Oracle Support Administration Task

Submit a New Admin Task ×

TASK LABEL
Oracle Support Administration

- Number of Positions to Pre-load for Workspace Wizard
- Maximum Selection Size for Cut, Copy and Paste
- Initial Wait Time (milliseconds)
- Submit Timeout Limit (milliseconds)
- Polling Interval
- Download Polling Interval
- Download Timeout
- Session Timeout (minutes)
- Session Timeout Warning (minutes)
- Maximum Number of Scenarios
- Display Retail Home Test Harness
- Domain-level Connection Interval (minutes)
- Symbol for Ambiguous Value
- Resource Bundle Expiry Time (milliseconds)

Figure 5-36 System Administration Menu

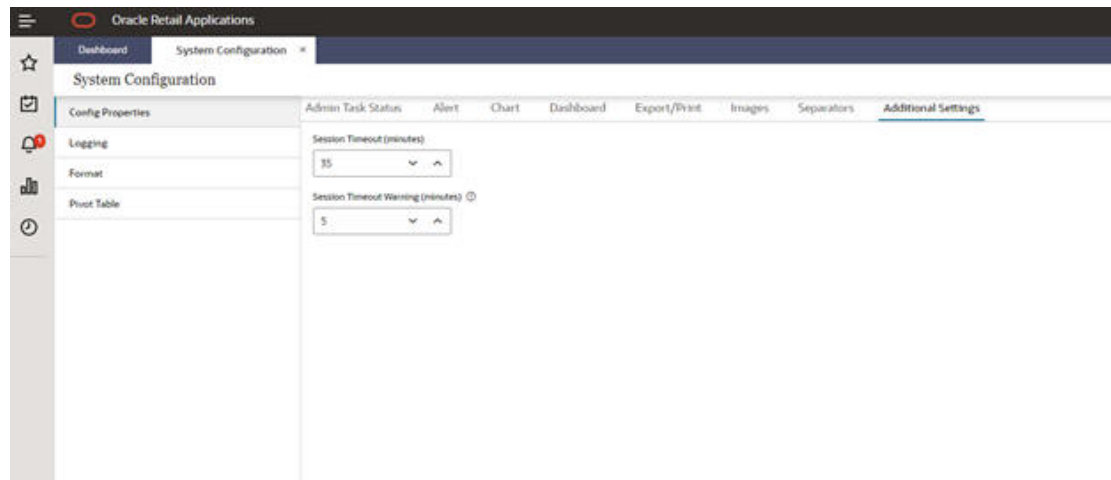

Disabling Default Sorting

The Disable Default Sorting property is available in the Additional Settings tab of the System Configuration menu. When Default Sorting is disabled, Alphanumeric Sorting is used.

See the *Oracle Retail Predictive Application Server Cloud Edition User Guide* for more details about this task.

Figure 5-37 Disable Default Sorting



List/Set/Unset PDS Integration Variables

This task is used to update integration options that are applied when moving data from Retail Insights or AIF Platform to Planning solutions or vice versa. Options are provided to list all the available integration variables and set or unset integration variables one at a time. For more information about these variables, see the Implementation Guides for the respective applications.

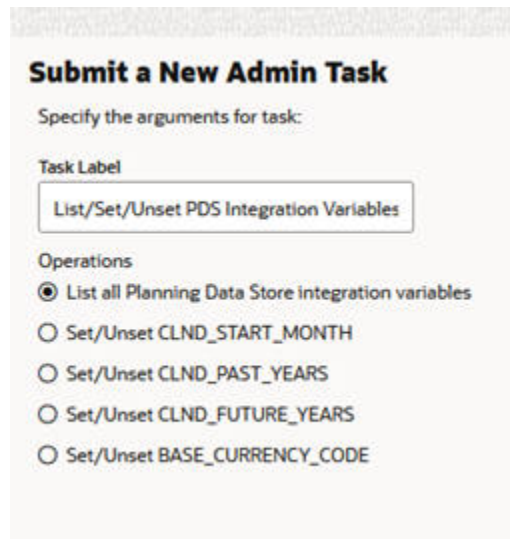
Figure 5-38 List/Set/Unset PDS Integration Variables

Submit a New Admin Task

Specify the arguments for task:

Task Label

List/Set/Unset PDS Integration Variables

Operations

- List all Planning Data Store integration variables
- Set/Unset CLND_START_MONTH
- Set/Unset CLND_PAST_YEARS
- Set/Unset CLND_FUTURE_YEARS
- Set/Unset BASE_CURRENCY_CODE

Set/Unset CLND_START_MONTH

CLND_START_MONTH refers to the month that maps to the month ID received from RMF CS. For example, if CLND_START_MONTH is set to 2, then the month ID 1 received from RMS refers to February.

Set/Unset CLND_PAST_YEARS

CLND_PAST_YEARS refers to the number of years in the history before the current year.

Set/Unset CLND_FUTURE_YEAR

CLND_FUTURE_YEAR refers to the number of years in the future period after current year. For example, if CLND_PAST_YEAR is set to 2 and CLND_FUTURE_YEAR set to 2 then there are five full years including the current year.

Set/Unset BASE_CURRENCY_CODE

The base currency code is set by default as USD to obtain the conversion rates for other currencies. This option is used to change the base currency code.

Load Interface Mappings

The Load Interface Mappings task is used to load interface mappings between RDX and PDS. Each interface can have a configuration specification defined as interface mapping that provides details about the mapping of source table columns to destination table columns. It can be provided by the customer admin user as a configuration file named interface.cfg. It must be uploaded to the incoming area of the Object Storage before running this task. This interface mapping file is parsed and loaded into an internal interface mapping table and can be used by generic importers/exporter packages to transfer data.

Figure 5-39 Load Interface Mappings

Submit a New Admin Task

Specify the arguments for task:

Task Label

Exclusive Mode Message

Export Hierarchy Data Task

The Export Hierarchy Data task is used to export all the positions in a hierarchy, including their rollup relations. The task exports all hierarchy positions by default. However, options are available to include only formal or informal positions.

Figure 5-40 Export Hierarchy Data Task

Submit a New Admin Task

Specify the arguments for task:

Task Label

Hierarchy Name

The name of the .dat file

Only include formal positions in the .dat file

Only include informal positions in the .dat file

Export all position names in uppercase

Export positions of user-defined dimensions

File to be created containing informal positions

Log level

Hierarchy Name

This is the drop-down list of available hierarchies for export.

The Name of the Output Data File

Only the file name must be specified. This is the output file containing the hierarchy positions.

Only Include Formal Positions in the Output

If this is specified, all informal positions will be skipped.

Only Include Informal Positions in the Output

If this is specified, all formal positions will be skipped.

Export All Position Names in Uppercase

If this is specified, all position names will be exported in all uppercase.

Export Positions of User-Defined Dimensions

By default, positions rollups for user-defined dimensions are not part of the export. This option will include those dimensions and can only be used in conjunction with the Only Include Formal or the Only Include Informal options.

File to be Created Containing Informal Positions

This creates a file containing all informal positions in a format that can be used with the Manage Informal Positions task.

Export Measure Data Task

The Export Measure Data task is used to export application or workbook measure data from RPASCE to either a CSV or a fixed-width file format. A single measure or multiple measures can be exported, based on a specified intersection.

If the measure's base intersection is not the same as the export intersection, the measure's default aggregation method will be used to aggregate data to an intersection higher than base, or replication will be used to spread the measure data if the data is required at an intersection lower than base. This utility supports the export of data in a user-specified range, which can be a single mask measure, in a range specified in the calendar dimension or in a combination of the two.

Figure 5-41 Export Measure Data Task

The screenshot shows a web form titled "Submit a New Admin Task". The form is for configuring an "Export Measure Data" task. It includes several input fields and options:

- Task Label:** A text input field containing "Export Measure Data".
- Export Intersection:** A text input field with the instruction "(Leave empty to use base intersection)".
- File name for data output:** A text input field containing "output.dat".
- Specify the range of CLND period:** A text input field with the instruction "(start pos:end pos)".
- Skip data based on measure value:** A dropdown menu set to "No export if all values are null".
- Export position names in upper case:** An unchecked checkbox.
- Use pipe separator instead of comma:** An unchecked checkbox.
- Log level:** A dropdown menu.
- Operations:** Two radio buttons: "Export one measure" (unchecked) and "Export multiple measures" (checked).

Task Label

Enter a descriptive and identifiable label for this task. This label is displayed on the Task Status Dashboard.

Export Intersection

This specifies the intersection at which to export measures. If the measure's base intersection is higher than the export intersection, replication is used to spread the measure down to the export intersection. If the measure's base intersection is lower than the export intersection, the measure's default method (defagg) is used for aggregation. The export intersection must be either at, above, or below the base intersection of the measure. The export intersection cannot have some dimensions above the dimension in the base intersection of the measure and some below. The RPASCE dimension names in an intersection must be four characters in length. If an RPASCE dimension name is less than four characters long, then an underscore character ("_") must be used as a filler at the end of a dimension name. This argument is optional.

File Name for Data Output

This specifies the data output file name. If the export intersection is not specified, all measures must be at the same intersection.

Export Position Names in Uppercase

If this option is selected, all position names will be converted to uppercase in the output file; if this option is not selected, all position names will be in lowercase, since they are stored as lowercase in the PDS.

Optionally, the output file can use the pipe (|) character as a field separator instead of a comma (,).

Optionally, specifies a range of positions along the innermost dimension. Only values in the range are considered for export. To have the correct ordering, use only for the CLND level.

Operations

Choose to export single or multiple measures. For a single measure, select one from the drop-down list; for multiple measures, enter a comma-separated list of measure names.

Figure 5-42 Export Multiple Measures

The screenshot shows a web form titled "Submit a New Admin Task". The form contains several fields and sections:

- Specify the arguments for task:**
 - Task Label: Export Measure Data
 - File name for data output: output.dat
 - Skip data based on measure value: No export if all values are null
 - Operations: Export multiple measures
- Select measures to export:**
 - A search bar with the placeholder text "Search..." and a magnifying glass icon.
 - A list of measures with checkboxes:
 - No selections
 - Ap Approval Info (lpapappint)
 - Ap Approval Info (mpapappint)
 - Ap Approve (mpapappb)
 - Ap Approve By (mpapappl)
 - Ap Approve Dt (mpapappd)
 - Ap Approve Notes (mpapappnt)
 - Ap BOP C (lpapbopc)
 - Ap BOP C (mpapbopc)
 - Navigation controls: Page 1 of 17, with arrows for navigation.
 - A dropdown menu labeled "Specify a mask measure name".

Note the following:

- Select the measure or measures to be exported. This depends on the operation selected in the first wizard.

- Optionally, specify a mask measure to be used to filter the export. It must be a valid Boolean measure.

Manage Hierarchies Task

The Manage Hierarchies task is used to list all the hierarchies in the PDS and their properties.

Figure 5-43 Display Product Hierarchy Properties

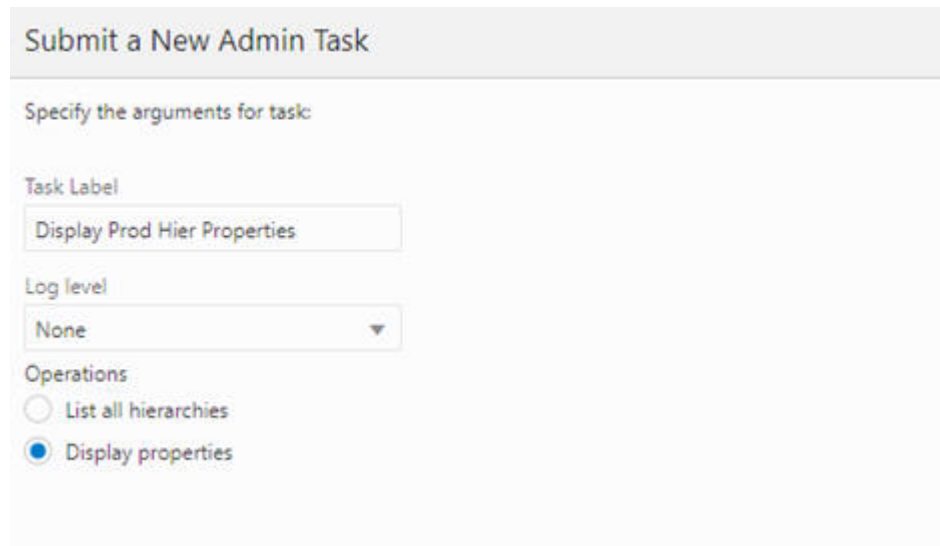

Submit a New Admin Task

Specify the arguments for task:

Task Label
Display Prod Hier Properties

Log Level
None

Operations
 List all hierarchies
 Display properties

List All Hierarchies in the PDS

All hierarchies in the application are listed.

Display Properties of the Hierarchy

Displays the detailed properties for a specific hierarchy. When the user selects this and clicks **Next**, the window to enter additional arguments for the operation is displayed.

Figure 5-44 Display Product Hierarchy Properties Log

Submit a New Admin Task

Specify the arguments for task:

Task Label: Display Prod Hier Properties

Log level: None

Operations: Display properties

Select hierarchy

Product ▼

Click **Next**. Select **Run ASAP** on the Scheduling page and click **Finish**. In the OAT dashboard, select the recently completed task to view the details of the hierarchy.

Figure 5-45 Sample Live Log Output for Manage Hierarchies Task

Live Log ✕

Manage Hierarchies - Manage Hierarchies

Submitted by: oci.admin Status: **Success**

Submitted: 8/31/21 8:05 AM Started: 8/31/21 8:05 AM

```

<B 2021-08-31T16:05:19.077Z r:D op:?> Note: Logs displayed below uses Universal Coordinated Ti
Hierarchy: Product (prod)
Order: 10010
Purge Age: 10000
Associated Attribute Hierarchy: None
Root Dimension: sku
Position-level Security: Enabled on dept dimension
PDS Shared: Yes
Dimensions: class cmpd dept dven pgrp scis sku scl1 scl2 cons clsg
<B 2021-08-31T16:05:20.681Z r:D op:?>
<B 2021-08-31T16:05:20.681Z r:D op:?> hierarchyMgr completed successfully
        
```

Auto-Refresh

Expressions, Rules, and Rule Groups Information Task

Mace is used to evaluate rule groups or expressions in order to manipulate measures.

Figure 5-46 Expressions, Rules, and Rule Groups Information

Submit a New Admin Task

Specify the arguments for task:

Task Label
Expressions, Rules and Rule Groups Infc

Log level
▼

Operations

Search for a specific string
[]

Print the specified rule
add1chnlmapb_calc ▼

Print the specified rule group
ad_calc ▼

Print all the rules and rule groups

Search for a Specific String

Searches all expressions for the specified printing of all the rules and rule groups that have these expressions.

Print the Specified Rule

Select from the drop-down list for the specific rule to print.

Print the Specified Rule Group

Select from the drop-down list for the specific group to print.

Print All the Rules and Rule Groups

All rules and rule groups are printed.

Manage Informal Positions Task

This task maintains informal positions for DPM-enabled dimensions in an application. It can convert positions from informal to formal, remove informal positions, create informal positions in bulk, and copy data slices between positions in measures.

Figure 5-47 Manage Informal Positions Task

The screenshot shows a web form titled "Submit a New Admin Task". Below the title, it says "Specify the arguments for task:". There are three main sections: "Task Label" with a text input field containing "Manage Informal Positions"; "Exclusive Mode Message" with an empty text input field; and "Operations" with three radio button options: "Select operation" (which is selected), "Create Informal Positions in Bulk", and "Data Slice Copying". The "Select operation" option has a dropdown menu currently showing "Formalize".

Select Operation

You can use only one of these operations.

- **Formalize.** The data file, [hierName].formalize, is required. The data file is in CSV format with two columns: level name and position name. All matching positions are converted to formal status and all positions that these positions roll up to in the hierarchy will also be converted to formal positions. For example, if one of the informal SCLS positions is specified to become a formal position, then its corresponding CLSS, DEPT, and so on, positions will also be converted to formal positions if they are informal.
- **Load.** Loads informal positions from an input file. The input file must be a CSV file with the name [hierName].informal.csv.dat. It must have the same format pattern/restriction as the data file for the Load Dimension Data task (PDS Admin Tasks group). All new positions are treated as informal and are loaded into the current application.
- **Remove.** Removes informal positions for the specific hierarchy. The data file, [hierName].remove, is fetched from Object Storage before processing. The data file is in CSV format with two columns: level name and position name.

The data listed above is fetched from the Object Storage before processing. These operations also require an additional parameter. Select hierarchy, which is shown when the user clicks **Next**.

Figure 5-48 Manage Informal Positions Sub-Task

Submit a New Admin Task

Specify the arguments for task:

Task Label: Manage Informal Positions

Operations: Select operation: Formalize

Select hierarchy

Location ▼

Select Hierarchy

Specify the hierarchy on which to operate.

Create Informal Positions in Bulk

This feature allows the user to create a number of informal positions on any DPM-enabled dimension. These positions are automatically named and labeled. However, the user must provide the applicable rollup and spread information so that these new positions can be properly placed in the hierarchy.

Figure 5-49 Create Informal Positions in Bulk

Submit a New Admin Task

Specify the arguments for task:

Task Label: Manage Informal Positions

Operations: Create Informal Positions in Bulk

Select dimension

Loc Attribute Value ▼

Number of positions to create on specified dimension

1 ▼

Specify the immediate rollup positions for the auto-generated positions (agg_dim1:pos1,agg_dim2:pos2,...)

Specify the spread counts for the auto-generated positions (dimA:countA,dimB:countB,...)

Select Dimension

Specify the dimension on which to operate.

Number of Positions to Create on Specified Dimension

Enter the number of positions to create on the specified dimension.

Specify the Rollup Positions for the Auto-Generated Positions

This specifies the rollup positions for the auto-generated positions. You must include the direct rollups for the new positions and the rollups for the descendents of these new positions on alternate branches, if applicable. The format is:
dimA:countA,dimB:countB,...

Specify the Spread Counts for the Auto-Generated Positions

This specifies the spread counts for the auto-generated positions. This is optional. It defaults to a value of 1 if not specified. The format is dimA:countA,dimB:countB,...

Data Slice Copying

This feature is used to copy data slices from one position to another. The XML file that contains the instructions for the operations must be placed in the input folder under the Object Storage. It must be named informal_copy.xml.

XML Input File Schema in XSD Format File

```
<?xml version="1.0" encoding="UTF-8"?>
<xsd:schema attributeFormDefault="unqualified" elementFormDefault="qualified"
version="1.0" xmlns:xsd=http://www.w3.org/2001/XMLSchema">
```

```

<xsd:element name="rpas" type="rpasType" />
<xsd:complexType name="rpasType">
  <xsd:sequence>
    <xsd:element name="copy" type="copyType" />
  </xsd:sequence>
</xsd:complexType>
<xsd:complexType name="copyType">
  <xsd:sequence>
    <xsd:element name="measure" type="measuresType" />
    <xsd:element name="positionMap" type="positionMapType" />
  <xsd:sequence>
    <xsd:attribute name="removesource" type="xsd:boolean" />
  </xsd:complexType>
<xsd:complexType name="positionMapType">
  <xsd:sequence>
    <xsd:element maxOccurs="unbounded" name="positions" type="xsd:string" />
  </xsd:sequence>
  <xsd:attribute name="dim" type="xsd:string" />
</xsd:complexType>
<xsd:complexType name="measuresType">
  <xsd:attribute name="option" type="xsd:string" />
</xsd:complexType>
</xsd:schema>

```

Sample XML Input File

```

<?xml version="1.0" encoding="UTF-8"?>
<rpas>
  <copy removeSource="true">
    <measures option="include">
      r_ex_demoa, r_ex_demob, r_ex_democ
    </measures>
    <positionMap dim="sku">
      <positions>sku_10000010, sku_10000008</positions>
      <positions>sku_22200001, sku_22200002</positions>
    </positionMap>
  </copy>
</rpas>

```

Table 5-2 XML Input File Settings

Section	Attribute	Description	Required	Format
copy		Settings for copying operation.	Yes	
copy	removeSource	Removes source data slices after copying.	Yes	True or False
measures		A list of measures.	No	Comma-delimited measure names
measures	option	The measure list is inclusive or exclusive.	Yes, if the measures section exists.	Include or Exclude
positionMap		Position mapping for the copying operation.	Yes	
positionMap	dim	The dimension of the mapped positions.	Yes	Dimension name

Table 5-2 (Cont.) XML Input File Settings

Section	Attribute	Description	Required	Format
	positions	Two positions. The first one is the position to copy from. The second one is the position to copy to.	Yes	Comma-delimited

Measure Information Task

The Measure Information task is used to print measure information on the measure to log.

Figure 5-50 Measure Information Task

Submit a New Admin Task

Specify the arguments for task:

Task Label

Measure Information

Log level

▼

Operations

- Lists all the Measures
- Print specification of the measure
- List the information of a measure at its base intersection

List All the Measures

This returns a list of all registered measures in the application.

Print Specification of the Measure

When the user selects this and clicks **Next**, the wizard page used to specify the measure to print is displayed.

List the Information of a Measure at its Base Intersection

This lists the number of dimensions, logical size, populated size, and density of a measure at its base intersection. When the user selects this and clicks **Next**, the wizard page used to enter additional arguments is displayed.

Purge Tasks from Task Status Dashboard Task

This task can be used to purge the completed OAT tasks from the Task Status Dashboard.

Figure 5-51 Purge Tasks from Task Status Dashboard

Submit a New Admin Task

Specify the arguments for task:

Task Label

Purge Tasks from Task Status Dashboar

Purge tasks that are older than

3 days ▼

Purge Tasks That are Older Than

This option is used to specify the age at which to purge tasks. It can remove all or remove only those older than 3, 5, or 7 days.

Rename Positions Task

The Rename Positions task is used to change the name of one or more positions. Positions that are to be renamed must be included in a hierarchy data file. After the hierarchy data files have been updated and placed in the designated location, an administrator must run the Rename Positions utility.

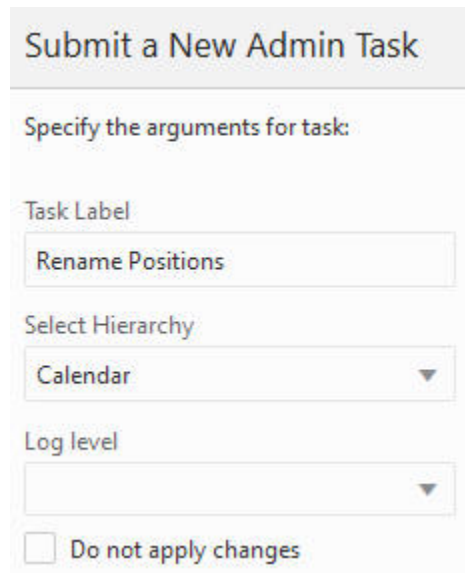
Figure 5-52 Rename Positions Task

The screenshot shows a web form titled "Submit a New Admin Task". Below the title, it says "Specify the arguments for task:". There are three input fields: "Task Label" with the text "Rename Positions", "Select Hierarchy" with a dropdown menu showing "Calendar", and "Log level" with an empty dropdown menu. At the bottom, there is a checkbox labeled "Do not apply changes" which is currently unchecked.

Hierarchy Name

This indicates the hierarchy for which positions are being renamed.

Do Not Apply Changes

This reports which changes are applied, but it does not apply the changes. A dry run still generates a log file.

Segment/Workspace Batch Operation Task

The Segment/Workspace Batch Operation task is used by the administrator to perform the following operations:

- Remove a segment
- Remove the workbook for a segment
- Remove all segments belonging to a specific user
- Remove all segments belonging to a specific template
- Remove all segments
- Build a Segment
- Commit a segment
- Refresh a segment
- Add a segment to the batch build queue
- Add a segment to the batch commit queue
- Add a segment to the batch refresh queue
- Remove a segment from the batch build queue
- Remove a segment from the batch commit queue

- Remove a segment from the batch refresh queue
- Start a batch operation
- Print a segment in a queue

Figure 5-53 Segment/Workspace Batch Operation Task

Submit a New Admin Task

Specify the arguments for task:

Task Label
Segment/Workspace Batch Operation

Override RPAS_TODAY? Uncheck to default system setting

Log level
▼

Operations

- Remove a segment
- Remove workbook for a segment
- Remove all segments belonging to a specific user
- Remove all segments belonging to a specific template
- Remove all segments
- Build a segment
- Commit a segment
- Refresh a segment
- Add segment to batch build queue
- Add segment to batch commit queue
- Add segment to batch refresh queue
- Remove segment from batch build queue
- Remove segment from batch commit queue
- Remove segment from batch refresh queue
- Start batch operation
All queues ▼
- Print segment in queue
All queues ▼

Enable/Disable Toggleable Features Task

This task can be used to enable or disable certain RPASCE features. The current state of these features can be determined from the state of the check boxes on the screen. For example, the feature dynamic position maintenance (DPM) is enabled by default for most applications. Users can disable this feature and later re-enable it by using the check box next to the feature name and submitting this OAT task.

Figure 5-54 Toggleable Features Task

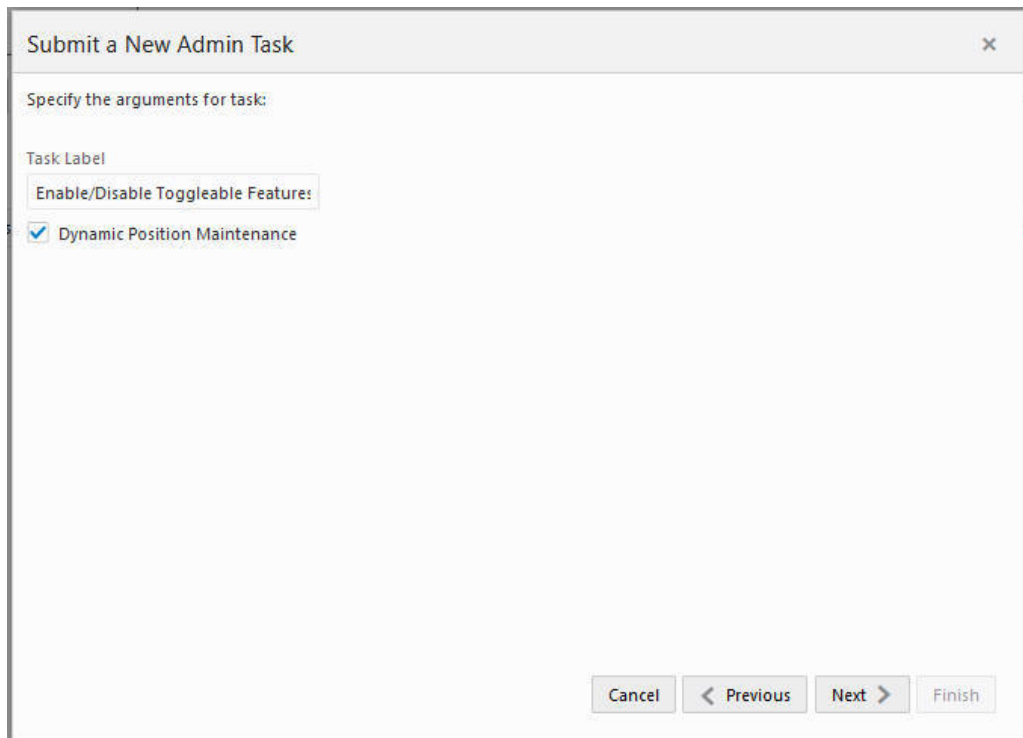

Submit a New Admin Task

Specify the arguments for task:

Task Label

Enable/Disable Toggleable Features:

Dynamic Position Maintenance

Cancel < Previous Next > Finish

Dynamic Position Maintenance

Use this feature to create hierarchy positions from workspaces in the UI. The workspace template must be configured correctly to use DPM for this feature to work. For more information, see *Oracle Retail Predictive Application Server Configuration Tools User Guide*.

Atomic User Management

This feature is not reversible and cannot be disabled.

Manage Workspaces Task

The Manage Workspaces task is use to inspect and remove existing workbooks.

Figure 5-55 Manage Workspaces Task

Submit a New Admin Task

Specify the arguments for task:

Task Label
Manage Workspaces

Log level
▼

Operations

- List all workbooks
- List workbooks belonging to a specific user
user3(Administrator) ▼
- List workbooks belonging to a specific template
Measure Analysis ▼
- Remove all workbooks
- Remove workbooks belonging to a specific user
user3(Administrator) ▼
- Remove workbooks belonging to a specific template
Measure Analysis ▼
- Remove selected workbooks
- Print detailed information about workbooks

Task Label

This is the label for the task.

Log Level

This is the log level for the task.

List All Workbooks

This lists workbooks in the application. This also has an option to show segment labels.

List Workbooks Belonging to a Specific User

This lists workbooks in the application belonging to a specific user. This also has an option to show segment labels.

List Workbooks Belonging to a Specific Template

This lists all workbooks in the application belonging to a specific template. This option can also be filtered based on users. This also has an option to show segment labels.

Remove All Workbooks

This removes all workbooks in the application. This also has an option to remove the segment. If this check box is selected, in addition to the workspace, the associated segment will also be removed.

Remove Workbooks Belonging to a Specific User

This removes workbooks from the application belonging to a specific user. This also has an option to remove the segment. If this check box is selected, in addition to the workspace, the associated segment will also be removed.

Remove Workbooks Belonging to a Specific Template

This removes all workbooks from the application belonging to a specific template. This option can also filter based on users. This also has an option to remove the segment. If this check box is selected, in addition to the workspace, the associated segment will also be removed.

Remove Selected Workbooks

This argument removes only the workbooks selected from the list. This argument also has an option to remove segments.

Print Detailed Information about Workbooks

This prints detailed information about workbooks selected from the list.

Note:

Removing the workbook from the application will always report success in OAT. If any workbook is open, it skips that workbook deletion and continues to delete the other workbooks. This functionality prevents the task from failing on the first failure to delete the workbook. Be sure to always check the log files after the task is completed.

Formats Users Security Export Task

Use this task to export all the user, security, and formatting data present in the environment.

The OAT task exports the following information:

- All user and group information
- Workbook template formats at the template, group, and user levels
- The following security settings:
 - Dimension Modification Rights

- Max User Session Limit
- Group Measure Default Rights
- Group Workbook Template Default Rights
- Max Domain Session Limit
- Measure Rights
- Workbook Template Limits
- Workbook Template Measure Rights
- Position Level Security (all position-related measures)

All exported data is saved in an archive file named FormatSecurityExport.tar.gz and placed in the outgoing object store location.

There are no options for this task other than the task label.

Formats Users Security Import Task

This task can be used to import user, group, security, and formatting data. The data archive file FormatSecurityExport.tar.gz created using the Formats/Users/Security - Export Task earlier must be first copied to the incoming/input object store location.

It is expected that the source environment matches the target environment with respect to configuration. If there are minor differences, patch the target environment with the last used configuration after running the import task. This is necessary to merge the changes in the configuration into the formatting information that has been overwritten during the importing process.

Figure 5-56 Formats Users Security Import Task

The screenshot shows a dialog box titled "Submit a New Admin Task" with a close button (X) in the top right corner. Below the title, it says "Specify the arguments for task:". Under "Task Label", there is a text input field containing "Import Formats,Users and/or Secu". Below this, under "Operations", there are two radio button options: "Import everything" (which is selected) and "Import individual components". At the bottom of the dialog, there are four buttons: "Cancel", "< Previous", "Next >", and "Finish".

The options are:

- Import everything. This option will import everything including formats, users, and security data.
- Import individual components. This option lets the user pick and choose the type of data to import.

Figure 5-57 Import Individual Components

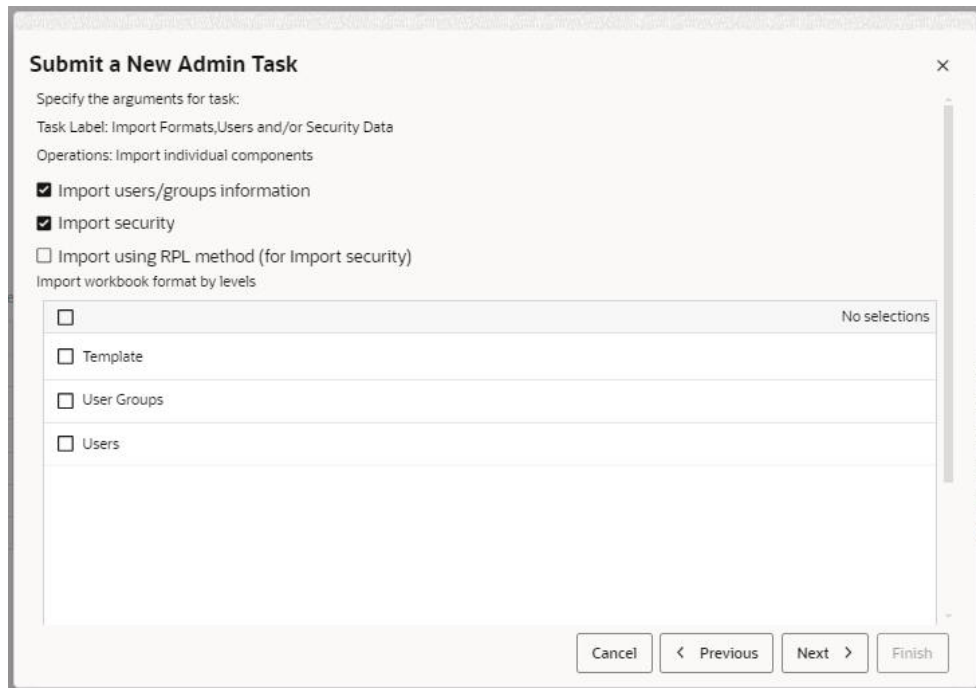

- Import users/group information. All users and groups that exist in the importing set will be added to the target environment. Users and groups that already exist in the target environment will not be changed.
- Import security. This option imports the security data from the input archive. Position level security will be completely reset if the security dimension in the source environment does not match the target environment. It is best to import users/groups as well when importing security. Otherwise, security information for users who have not already logged into the target environment will be skipped.
- Import using RPL method (for Import security). This will use replace mode to load the security measures. If the target environment has extra users than the import set, this option will wipe clean all security measures for those users. If this option is not used, ovr mode will be used which will only overlay the import security on top of current security.
- Import workbook format by levels. Pick and choose which formatting levels to import from the input archive. It can be any combination of the three levels. The format saved at the user/group/template level can only be imported at the level at which it was originally saved. For example, it is not possible to save the format at the user level in the source environment and import that format at the group level in the target environment using this task.

Service Request Administration Tasks

This section lists the tasks for the task group called "SR Admin Tasks." This task group covers all the diagnostic tasks and the operations and arguments specific to them. These tasks are based on the existing RPASCE utilities. The output from these tasks are used for diagnostic purposes.

These operations are supported as part of diagnostic tasks:

- Package Logs

Figure 5-58 Service Request Administration Tasks

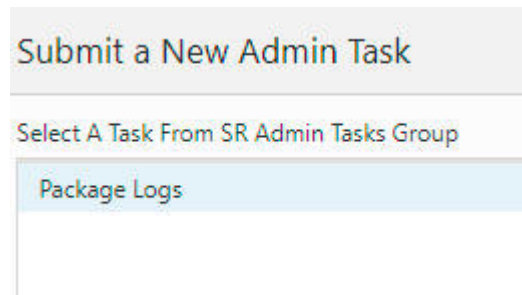

The Package Logs task create packages at a predetermined location on the back-end server that is identified by the application property, `r_oat_sr_dest`. This path must already exist and sufficient permissions granted to RPASCE Daemon for create/update/delete operations. This path must be outside of the RPASCE application and preferably on a separate mount. This path is used exclusively for this SR operation.

Table 5-3 Service Request Administration Task

Administration Task Name	Administration Task Type	Description
copyLogs	Package Logs	Used to copy OAT task logs and package them into a zip file.
transferFiles	Package Logs	Used to copy user session logs and package them into a zip file.

Package Logs Task

The Package Logs task has three options.

Task Label

This is the label for the task.

Figure 5-59 Package Log Options

Submit a New Admin Task [X]

Specify the arguments for task:

Task Label

Package Logs

Options

Copy user session logs

Copy OAT task logs

Copy all logs

Cancel < Previous Next > Finish

1. Copy user session logs: This option is used to copy the user session logs and package them into a .zip file. You can select the users to include their logs. There is also an option available called include logs from this date that denotes the starting date from which the logs must be included. The output package is named as logpackage_userlogs_<timestamp>.zip.

Figure 5-60 Copy User Session Logs

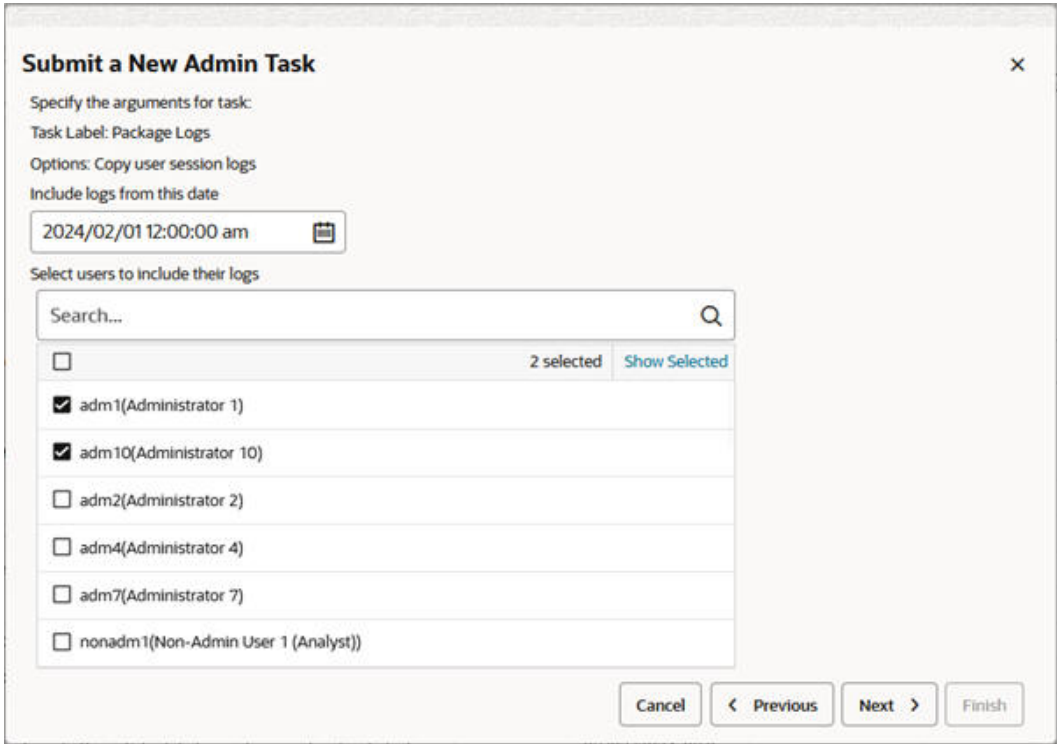

- 2. Copy OAT task logs: This sub-task is used to copy the OAT task logs and package them into a .zip. The output package is named as logpackage_task_<timestamp>.zip.

Figure 5-61 Copy Oat Task Logs

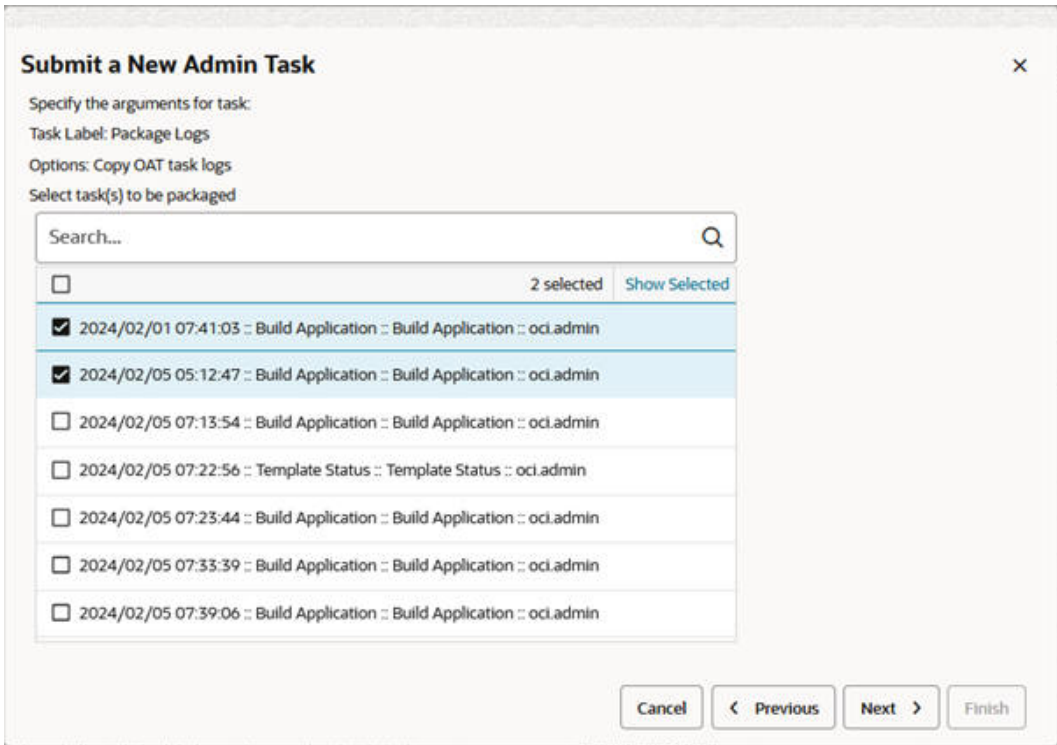

- Copy all logs: This sub-task can be used package both user session logs and OAT tasks logs. The output package is named as logpackage_all_<timestamp>.zip.

Figure 5-62 Copy All Logs

Submit a New Admin Task [X]

2024/02/06 11:12:35 am [Calendar Icon]

Select users to include their logs

Search... [Magnifying Glass]

2 selected Show Selected

adm10(Administrator 10)

adm2(Administrator 2)

adm4(Administrator 4)

adm7(Administrator 7)

nonadm1(Non-Admin User 1 (Analyst))

Select tasks to include their logs

Search... [Magnifying Glass]

1 selected Show Selected

2024/02/01 07:41:03 :: Build Application :: Build Application :: ocl.admin

Cancel Previous Next Finish

Bootstrap Administration Tasks

This section lists the tasks for the Bootstrap task group. This task group covers all the tasks that are required to build an application from the configuration. It is also possible to rebuild an existing application using the bootstrap tasks.

Applications override the base RPASCE version of the bootstrap task group with application specific bootstrap tasks. For complete details regarding the setup required for using the base bootstrap tasks that is not application specific, refer to the *Oracle Retail Predictive Application Server Cloud Edition Implementation Guide*. For application-specific bootstrap tasks, refer to the application's documentation. This section briefly describes the RPASCE bootstrap tasks and their parameters for quick reference.

Start by selecting the Submit a New Admin Task template that is attached to the bootstrap application. This opens up the screen shown in [Figure 5-63](#). These are the bootstrap tasks that are available.

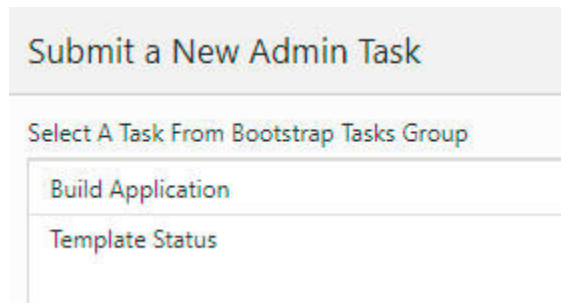
Figure 5-63 Bootstrap Tasks Group

Build Application Task

This task is used to build a new application. An empty application called the bootstrap application is used for building any new applications. Once this bootstrap task is executed, the logs can be found in the task dashboard of the bootstrap application or in the logs folder in the outgoing Object Storage location.

Prior to using this task, make sure the following prerequisites are met:

- The configuration has been uploaded to the config folder of the incoming Object Storage location.
- Input files have been uploaded to the input folder of the incoming Object Storage location.
- Batch control files have been uploaded to the batch_control folder of the incoming Object Storage location.
- Java special expression jar files, if required, must be located in the jse area of the Object Storage incoming location.

Figure 5-64 Build Application Task Arguments

Submit a New Admin Task

Specify the arguments for task:

Task Label
Build Application

Partition Dimension
dept

Use GA Configuration with no extensibility?

Use GA data?

JSE Jar files (optional, comma-separated list)

Overwrite Existing Application?

Set RPAS_TODAY in application

Batch Task Group to run after Application Build

Task Label

This is the label for the task; it can be any string. It is used to identify the task after it is submitted.

Partition Dimension

The dimension on which the application will be partitioned. If it is not provided, dept is the default.

Use GA Configuration with no Extensibility?

If this option is selected, the GA template configuration (no extensibility) will be used.

Use GA Data?

If this option is selected, the GA input data will be used.

JSE jar files (Optional, Comma-Separated)

If any Java Special Expression .jar files are used by the application configuration, they must be indicated here with the .jar file name only. If you are including multiple .jar files, provide a comma-separated list of .jar file names. This field is optional and must

be left blank if JSE extensions are not used. If listed, the .jar files named here must be present under jse in the incoming Object Storage location. If the named .jar file(s) are not present, the application build process will halt with an error.

Overwrite Existing Application?

Overwrite the existing application if the application has already been built once. The implementer must rebuild the application from scratch (perhaps because a non-patchable change has been made to the configuration). This option must be selected. If it not selected, then the application build process will halt and report an error, rather than overwrite the existing application.

Set RPAS_TODAY in Application

This option is used to set the PDS property rpas_today.

Batch Task Group to Run After Application Build

Once an application has been built successfully, a named group of batch operations may be specified (typically including measure data loads and mace calculations). This operation sequence must be one batch_type entry in the Batch Exec control file, batch_exec_list.txt. (For details, see the *Oracle Retail Predictive Application Server Cloud Edition Implementation Guide*.)

Template Status Task

This task is used to switch the application from template to EE or vice versa and perform the actions that must be done upon switching.

Figure 5-65 Template Status Task

Submit a New Admin Task

Specify the arguments for task:

Task Label
Template Status

List template status

Change template status
Activate
Deactivate

Task Label

This is the label for the task.

List Template Status

This option displays the current template status: activated or deactivated.

Change Template Status

This option is used to change the template status. If Activate is selected, the extensible template will be used. If Deactivate is selected, EE will be used.

Unregister Application

The Unregister Application task is used to undo the steps completed by the Build Application task and take the system back to a bootstrap state. From the bootstrap state, the application can then be built again. If multiple applications are registered, then only one of the applications can be unregistered. This will push only the unregistered application into the bootstrap state, and it can be built again. The other applications will stay in the built state. The bootstrap state is a state that contains only the foundation for building applications.

Figure 5-66 Unregister Application

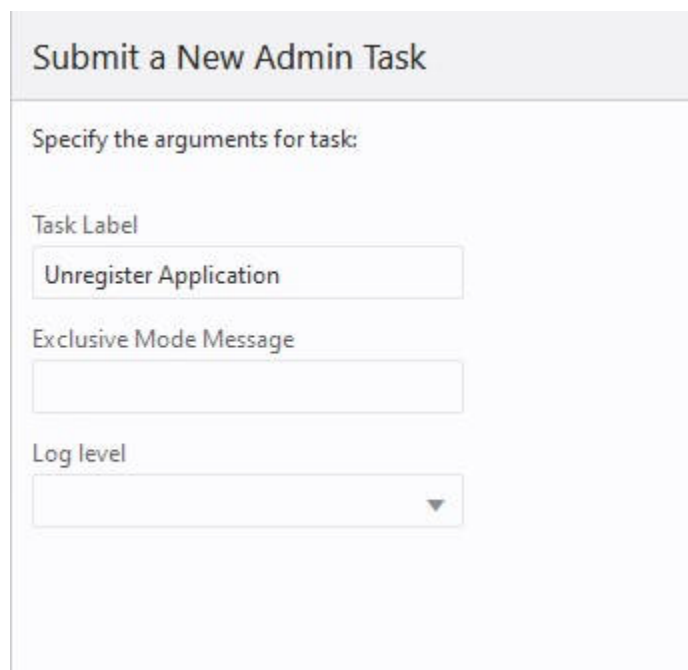

The screenshot shows a dialog box titled "Submit a New Admin Task". Below the title bar, it says "Specify the arguments for task:". There are three input fields: "Task Label" with the text "Unregister Application", "Exclusive Mode Message" which is empty, and "Log level" which is a dropdown menu.

Task Label

This is the label for the task; it can be any string. It is used to identify the task after it is submitted.

Exclusive Mode Message

Since this task requires offline level access to the application, the message entered here is shown when non-administration users try to log in or when administration users try to interact with the application.

Log Level

The drop-down list in this option is used to indicate the level of detail in the logs.

Retail Home Seeding

The Retail Home Seeding task is used to create custom Retail Home content for EE solutions. GA RPASCE solutions provide a default configuration for Retail Home content. However, EE solutions will often require custom configuration to support that solution's content in Retail Home.

This task consists of the following two steps:

1. Create a Retail Home configuration to define what content must be displayed within Retail Home.
2. Upload the Retail Home configuration and apply its content to the Retail Home system.

Retail Home Configuration

The process of creating the Retail Home configuration is similar to the creation of the RPASCE Dashboard configuration. The task is performed within the Configuration Tools and results in the creation of two files: RetailHomeConfig.json, which contains the configuration settings, and RHResources.properties, which contains the keys required to localize the strings displayed in the Retail Home content for the solution.

For information on the process of creating a Retail Home configuration file using the Configuration Tools, see the "Deployment Tool - Retail Home Dashboard Settings" and "Retail Home Translation Resources" sections in Chapter 11 of the *Oracle Retail Predictive Application Server Cloud Edition Configuration Tools User Guide*.

Updating Retail Home

The process of applying custom Retail Home content is performed from the Admin Tasks of the application. The process for updating Retail Home with configured content consists of the following two steps:

1. Upload both the RetailHomeConfig.json and the RHResources.properties file to Object Storage under prefix `planning/<SubNamespace>/incoming/config`
2. Run Retail Home Seeding as shown in [Figure 5-67](#) and [Figure 5-68](#). This task does not require any arguments. A message indicating success or failure will be returned upon completion of task.

Figure 5-67 Retail Home Seeding

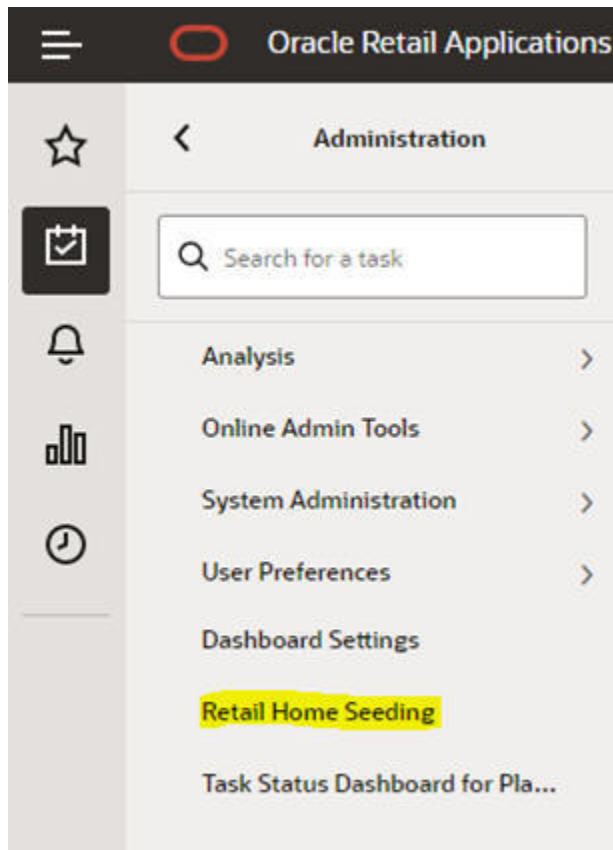
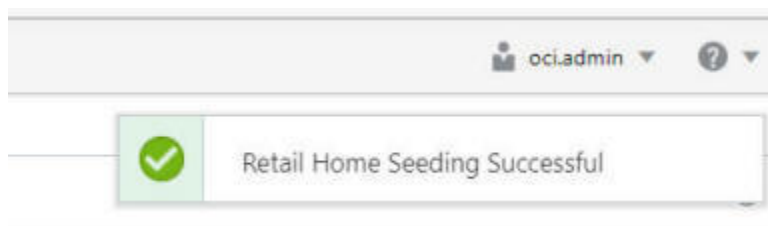

Figure 5-68 Retail Home Confirmation Message



Application Administration Tasks

Optionally, one or more sets of required application-specific administration tasks can be set up. These tasks are outside the scope of this document and are covered in the application-specific administration guides.

Task Status Dashboard

The Task Status Dashboard provides an interface that can be used to monitor the status of the tasks and download the log file when a task is completed. It allows the user to filter the submitted tasks by type, owner, or time. The status tiles show the percentage of tasks in that status and also act as a filter if the user clicks on them. The job name will become a hyperlink to the log file once the task is completed.

Figure 5-69 Accessing Task Status Dashboard

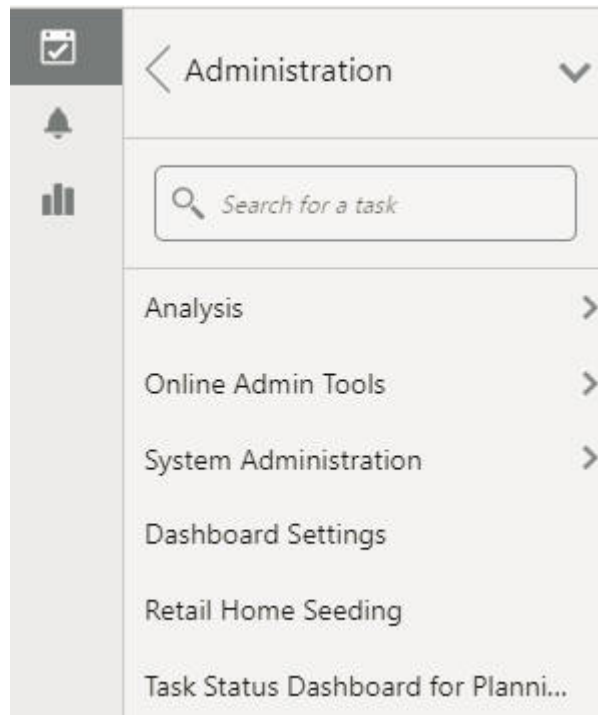

It can be accessed from the menu by clicking **Administration -> Task Status Dashboard for Planning Data Store**.

Figure 5-70 Status Dashboard

The screenshot shows the "Task Status Dashboard for Planning Data Store". At the top, there are filter buttons: "All (9)", "Scheduled (0)", "In Progress (0)", "Completed (1)", and "Failed (0)". To the right, there are dropdown menus for "All", "Last 24 hours", "All Submitters", and "All Task Types". Below the filters, there is a "Task Status" section with a table. The table has columns for Application, Description, Status, Task Type, Submitted by, Started/Scheduled, Completed, and Record Status. The table contains several rows of task data, including health checks and scheduled tasks.

Application	Description	Status	Task Type	Submitted by	Started/Scheduled	Completed	Record Status
Merchandise Financial Planning (infpsc)	Health-Check: Gather Schema Stats	Scheduled	hc-status-task		5/28/23, 4:00:00 AM		---
Retail Predictive Application Server (rpas)	Health-Check: Gather Schema Stats	Scheduled	hc-status-task		5/28/23, 4:00:00 AM		---
Merchandise Financial Planning (infpsc)	Health-Check: Purge Old Logs	Scheduled	hc-purgelogs-task		5/28/23, 3:00:00 AM		---
Retail Predictive Application Server (rpas)	Health-Check: Purge Old Logs	Scheduled	hc-purgelogs-task		5/28/23, 3:00:00 AM		---
Merchandise Financial Planning (infpsc)	Health-Check: Remove Orphaned Workbooks	Scheduled	hc-orphaned-objs		5/28/23, 1:00:00 AM		---
Retail Predictive Application Server (rpas)	Health-Check: Remove Orphaned Workbooks	Scheduled	hc-orphaned-objs		5/28/23, 1:00:00 AM		---
Retail Predictive Application Server (rpas)	Schedule Dashboard Build	Scheduled	Schedule Dashboard Build	ocladmin	5/26/23, 10:43:17 AM		---
Retail Predictive Application Server (rpas)	Run weekly Batch Task Group	Scheduled	Run Batch Task Group	ocladmin	5/23/23, 10:58:58 AM		---
Retail Predictive Application Server (rpas)	Health-Check: Remove Orphaned Workbooks	Success	hc-orphaned-objs		5/23/23, 5:32:04 AM	5/23/23, 5:32:10 AM	---

The Status Dashboard displays the details of all or some administration tasks, based on the filters that are applied. Logs are available for each task.

Dashboard Columns

The following data is displayed in the dashboard.

Description

This represents the task label provided by the user. You can use this field to differentiate between the various jobs that have been submitted or scheduled. For example, application Information is a task in the Online Administration Tool. You can schedule this task to run daily and assign the task label Information Daily to it. At the same time, you can schedule the same task to run weekly and assign the task label application Information Weekly to it.

Status

This represents the status of the task. The possible status values are Success, Failure, In Progress, Scheduled, and Pending. If the task fails, a message link is also provided that shows the failure message when you hover over the status field.

Task Type

This represents the name of the task. The name is unique for the task type. All labels are pre-defined and cannot be changed by the user.

Submitted by

This represents the login name of the user who submitted the task.

Started/Scheduled

This represents the time when the submitted started. The time displayed is in the time zone of the browser.

Completed

This represents the time when the task was completed or ended. If the status of a task is either In Progress or Scheduled, then this field is left blank. The time displayed is in the time zone of the browser.

Record Status

This represents the count of rejected records. If any batch steps have records that were rejected due to a validation error, the user will be able to see the count of the rejected records. This field is used only by the tasks that load dimension or fact data. The rejected records are visible at the child level and the sub-child level. The user can select the level in the UI and click the download Rejected Record button to download the set of rejected records for that level.

Other Dashboard Options

This section describes other dashboard options.

Sorting

The task list can be sorted by any column, with the exception of the Output column, by using the Sort Ascending and Sort Descending arrows that are visible when you hover over the column header.

Filtering

The task list can be filtered by type, owner, or time, using the icons shown in [Figure 5-71](#).

Figure 5-71 Filter Icons



The status tiles in [Figure 5-72](#) are also filters that when clicked will cause the task list to only show tasks of that status.

Figure 5-72 Status Tiles

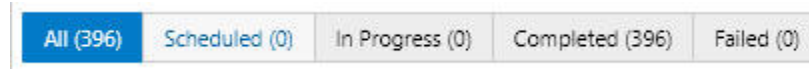

Accessing Logs

If a task contains subtasks, the description column will contain a hyperlink. Click the hyperlink to open up a new view, which contains only details about that task and its subtasks, as shown in [Figure 5-73](#).

Figure 5-73 View of Tasks and Subtasks

Application	Description	Status	Task Type	Submitted by	Started/Scheduled	Completed	Record Status
Retail Predictive Application Server (pas)	#1 Gathering schema statistics	Success	EE Gather Stats		5/11/23, 5:56:20 AM	5/11/23, 5:57:49 AM	—
Retail Predictive Application Server (pas)	#2 Loadmeasure set load_init	Success	EE Load Measure		5/11/23, 5:58:26 AM	5/11/23, 5:58:20 AM	Rejected records
Retail Predictive Application Server (pas)	#24.pcgt_weekly_images.csv.ovr	Success	Load Fact		5/11/23, 5:56:16 AM	5/11/23, 5:56:19 AM	0 of 4 failed
Retail Predictive Application Server (pas)	#23.pcgt_subclass1attr.csv.ovr	Success	Load Fact		5/11/23, 5:56:12 AM	5/11/23, 5:56:14 AM	18 of 18 failed
Retail Predictive Application Server (pas)	#22.pcgt_styl_media.csv.ovr	Success	Load Fact		5/11/23, 5:56:07 AM	5/11/23, 5:56:11 AM	1 of 17 failed
Retail Predictive Application Server (pas)	#21.pcgt_stdlinattr.csv.ovr	Success	Load Fact		5/11/23, 5:56:05 AM	5/11/23, 5:56:06 AM	0 of 23 failed
Retail Predictive Application Server (pas)	#20.pcgt_stattmange.csv.ovr	Success	Load Fact		5/11/23, 5:56:02 AM	5/11/23, 5:56:03 AM	0 of 1 failed
Retail Predictive Application Server (pas)	#19.pcgt_srcimage.csv.ovr	Success	Load Fact		5/11/23, 5:55:57 AM	5/11/23, 5:56:01 AM	0 of 10 failed

Any subtask of a given task can contain its own subtasks; these are by default collapsed in this view. Click the arrow icon in front of a subtask to expand that subtask and show the next level of subtasks. To collapse the view, click the arrow icon again.

If the task does not have any subtasks when it executed, the Description column will not have a hyperlink, as shown in [Figure 5-74](#).

Figure 5-74 Tasks Without Subtasks

Application	Description	Status	Task Type	Submitted By	Started/Scheduled	Completed	Record Status
Retail Predictive Application Server (rpaas)	Schedule Dashboard Build	Scheduled	Schedule Dashboard Build	ocladmn	5/26/23, 10:45:17 AM		
Retail Predictive Application Server (rpaas)	Run weekly Batch Task Group	Failed	Run Batch Task Group	ocladmn	5/23/23, 10:59:15 AM	5/23/23, 11:00:09 AM	
Retail Predictive Application Server (rpaas)	Security Administration	Success	WBatch Build	ocladmn	5/22/23, 7:50:54 AM	5/22/23, 7:50:45 AM	
Retail Predictive Application Server (rpaas)	ag	Success	WBatch Build	ocladmn	5/19/23, 11:58:18 AM	5/19/23, 11:58:31 AM	
Retail Predictive Application Server (rpaas)	ag3	Success	WBatch Build	ocladmn	5/19/23, 11:49:58 AM	5/19/23, 11:50:11 AM	
Retail Predictive Application Server (rpaas)	ag2	Success	WBatch Build	ocladmn	5/19/23, 11:36:58 AM	5/19/23, 11:36:51 AM	
Retail Predictive Application Server (rpaas)	ag	Success	WBatch Build	ocladmn	5/19/23, 11:31:18 AM	5/19/23, 11:31:30 AM	
Retail Predictive Application Server (rpaas)	agg1	Failed	WBatch Build	ocladmn	5/19/23, 11:20:48 AM	5/19/23, 11:25:46 AM	
Retail Predictive Application Server (rpaas)	agg1	Success	WBatch Build	ocladmn	5/19/23, 10:57:58 AM	5/19/23, 10:57:51 AM	
Retail Predictive Application Server (rpaas)	agg1	Success	WBatch Build	ocladmn	5/19/23, 10:19:18 AM	5/19/23, 10:19:58 AM	
Retail Predictive Application Server (rpaas)	aggSpreadLine	Success	WBatch Build	ocladmn	5/15/23, 7:40:40 AM	5/15/23, 7:40:52 AM	

You can also use the right click menu to access options to expand and collapse subtasks.

Select the task or subtask whose log you want to view. Click **Watch live log** (highlighted in Figure 5-75) to see the logs in a pop-up window that has navigation buttons. This button can be used even after the task has finished executing.

Figure 5-75 Watch Live Log

Optionally, you can download the log by clicking **Download Log** (highlighted in Figure 5-76). This downloads all the logs of main task and its nested subtasks, if any, in either .zip format or .txt format.

Figure 5-76 Download Log

Select a task or subtask and click Download Rejected Records to download rejected records. This button is active for the tasks that have a rejected record count under the Record Status column.

You can use the Auto-Refresh toggle button, shown in Figure 5-77, to automatically refresh the Administration Dashboard.

Figure 5-77 Auto-Refresh Toggle Button

To return to the task dashboard that has information on all the tasks, click **Task Status** (highlighted in [Figure 5-78](#)).

Figure 5-78 Task Status

The screenshot shows a dashboard with a navigation bar at the top containing filters: All (34), Scheduled (0), In Progress (0), Completed (34), and Failed (0). The main heading is 'Task Status > Run Batch Task Group - Post Build'. Below the heading are several action buttons: Actions, View, Detach, Auto-Refresh (checked), Download Log, Watch Live Log, and Download. The main content is a table with the following data:

Application	Description	Status	Task Type
Merchandise Financial Planning (mfpsc)	#2 Gathering schema statistics	Success	EE Gather Stats
Merchandise Financial Planning (mfpsc)	#2 Loadmeasure set load_init	Success	EE Load Measure
Merchandise Financial Planning (mfpsc)	#1 Execute set load_hier	Success	EE Execute

Cancel Task

Use this feature is to cancel those tasks with a status of pending or in-progress that have remained in that status for too long. Only the administration user of the logged-in solution can cancel the task.

When you select the tasks with a status of pending or in-progress that belong to the logged-in solution, the Cancel Task button/Actions menu/Context menu is enabled.

Figure 5-79 Task Status

The screenshot shows a dashboard with filters: All (18), Scheduled (9), In Progress (1), Completed (7), Failed (0). There are also filters for 'Last 24 hours', 'All Submitters', and 'All Task Types'. The main heading is 'Task Status'. Below the heading are action buttons: Actions, View, Detach, Auto-Refresh (checked), Download Log, Watch Live Log, Download Rejected Records, and Cancel Task. The main content is a table with the following data:

Application	Description	Status	Task Type	Submitted by	Started/Scheduled	Completed	Record Status
Retail Predictive Application Serve...	Health-Check: Purge Old Logs	Scheduled	hc-purgelogs-task		9/10/23, 3:00:00 ...		—
Retail Predictive Application Serve...	Health-Check: Purge Old Logs	Scheduled	hc-purgelogs-task		9/10/23, 3:00:00 ...		—
Merchandise Financial Planning (...)	Health-Check: Remove Orphaned ...	Scheduled	hc-orphaned-objs		9/10/23, 1:00:00 ...		—
Retail Predictive Application Serve...	Health-Check: Remove Orphaned ...	Scheduled	hc-orphaned-objs		9/10/23, 1:00:00 ...		—
Retail Predictive Application Serve...	Health-Check: Remove Orphaned ...	Scheduled	hc-orphaned-objs		9/10/23, 1:00:00 ...		—
Retail Predictive Application Serve...	ag	Pending	WbBatch Build	ocladmin	9/7/23, 9:31:29 AM		—
Retail Predictive Application Serve...	ag	Cancelled	WbBatch Build	ocladmin	9/7/23, 9:27:04 AM	9/7/23, 9:27:15 AM	—
Retail Predictive Application Serve...	ag	Success	WbBatch Build	ocladmin	9/7/23, 9:24:24 AM	9/7/23, 9:24:47 AM	—

Click **Cancel Task**. You see a confirmation pop-up.

Figure 5-80 Cancel Task Confirmation



In the Confirmation popup, click **Close** to close the pop-up. Click **Download Log** to download the trace log of the task.

At this stage, after you check the logs, you can decide whether to continue with Cancel Task or not. If you have questions, you can raise an SR with the downloaded trace log to Oracle support. Click **OK** to send the request to cancel the task. You will see a notification message regarding the status of the request.

Figure 5-81 Cancel Message

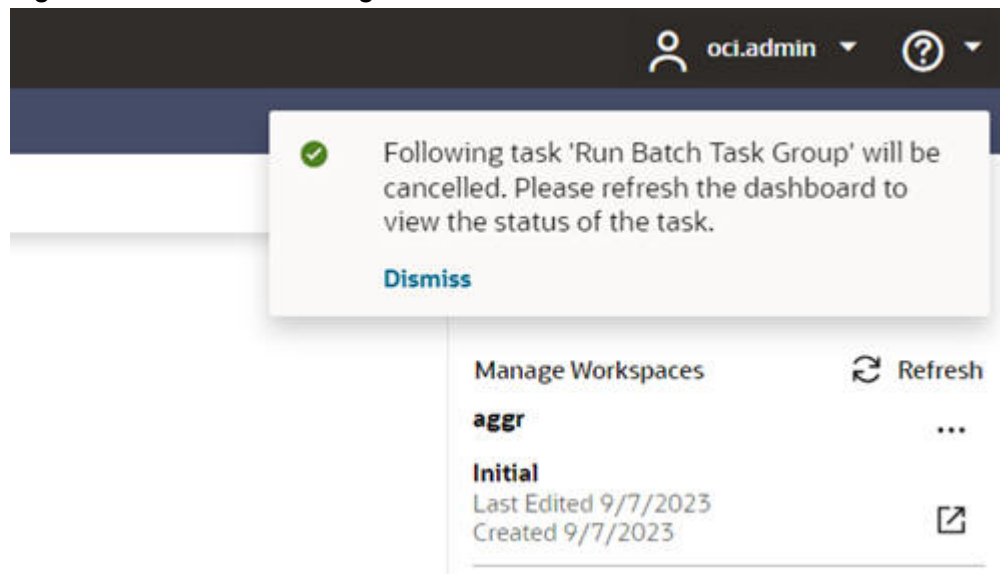

After you refresh the Task Status, you will the status of Cancelled. You can view the log file that shows the administration user who cancelled the task.

Figure 5-82 Task Status Details

Application	Description	Status	Task Type	Submitted by	Started/Scheduled	Completed	Record Status
Retail Predictive Application Serve...	Health-Check: Remove Orphaned ...	Scheduled	hc-orphaned-objs		9/10/23, 1:00:00 ...		---
Retail Predictive Application Serve...	Health-Check: Remove Orphaned ...	Scheduled	hc-orphaned-objs		9/10/23, 1:00:00 ...		---
Retail Predictive Application Serve...	Run Batch Task Group	Cancelled	Run Batch Task Group	occladmin	9/7/23, 9:39:02 AM	9/7/23, 9:39:02 AM	---
Retail Predictive Application Serve...	ag	Success	Wbatch Build	occladmin	9/7/23, 9:51:44 AM	9/7/23, 9:52:00 AM	---
Retail Predictive Application Serve...	ag	Cancelled	Wbatch Build	occladmin	9/7/23, 9:27:04 AM	9/7/23, 9:27:15 AM	---
Retail Predictive Application Serve...	ag	Success	Wbatch Build	occladmin	9/7/23, 9:26:24 AM	9/7/23, 9:26:47 AM	---
Retail Predictive Application Serve...	Oracle Support Administration	Success	Oracle Support Administr...	occladmin	9/7/23, 9:10:34 AM	9/7/23, 9:10:37 AM	---

The status of a task is set to failed once it has been running for 24 hours (or 86400 seconds) and the status of all its child tasks that are pending or running are set to failed too. This 86400 seconds limit can be configured using the PDS environment variable `RPAS_SCRIPT_TIMEOUT`. If `RPAS_SCRIPT_TIMEOUT` is set, the task is set to failed after running for `RPAS_SCRIPT_TIMEOUT` seconds. If not set, the default value of 24 hours is used. The `RPAS_SCRIPT_TIMEOUT` applies for all tasks.

For a workbook build via UI and OAT, the PDS environment variable `RPAS_WORKBOOK_BUILD_TIMEOUT` can be set. If `RPAS_WORKBOOK_BUILD_TIMEOUT` is set, the workbook build task fails after running for `RPAS_WORKBOOK_BUILD_TIMEOUT` seconds. If not set, `RPAS_SCRIPT_TIMEOUT` will be used. If both are not set, the default of 24 hours will be used.

Restore Size

Administration users can resize the administration dashboard Task Status columns width. This makes it easy to read text displayed in the cells. The user can resize the column width by dragging the column header cell border using the mouse or by using the context menu option (right click on mouse). Only one column can be resized at a time. After a column is resized, when the table size is increased, the horizontal scroll bar is displayed. This change to the size is retained only for that session. After resizing a column, the user can revert the changes by clicking View menu -> Restore Size. The Restore Size option is checked when the task status table is initially loaded.

Figure 5-83 Restore Size

Application	Description	Status	Task Type	Submitted by	Started/Scheduled	Completed	Record Status
Merchandise Financial Planning (inf...	Health-Check: Gather Schema Stats	Scheduled	hc-stats-task		12/17/2023, 4:00...		---
Retail Predictive Application Server ...	Health-Check: Gather Schema Stats	Scheduled	hc-stats-task		12/17/2023, 4:00...		---
Retail Predictive Application Server ...	Health-Check: Gather Schema Stats	Scheduled	hc-stats-task		12/17/2023, 4:00...		---
Merchandise Financial Planning (inf...	System-Task: Update Offer Metrics	Scheduled	sys-offermetrics		12/17/2023, 3:00...		---
Merchandise Financial Planning (inf...	Health-Check: Purge Old Logs	Scheduled	hc-purgeoldlogs-task		12/17/2023, 3:00...		---
Retail Predictive Application Server ...	System-Task: Update Offer Metrics	Scheduled	sys-offermetrics		12/17/2023, 3:00...		---
Retail Predictive Application Server ...	Health-Check: Purge Old Logs	Scheduled	hc-purgeoldlogs-task		12/17/2023, 3:00...		---
Retail Predictive Application Server ...	System-Task: Update Offer Metrics	Scheduled	sys-offermetrics		12/17/2023, 3:00...		---

When the user resizes the column, this option is unchecked. When the user clicks this, changes are reverted, and the grid is refreshed to the default columns width.

Figure 5-84 Resize Restore

Application	Description	Status	Task Type	Submitted by	Start/Sche
Merchandise Financial Planning (mfpncs)	Health-Check: Gather Schema Stats	Scheduled	hc-stats-task		12/17/2021
Retail Predictive Application Server (ppa2)	Health-Check: Gather Schema Stats	Scheduled	hc-stats-task		12/17/2021
Retail Predictive Application Server (ppa2)	Health-Check: Gather Schema Stats	Scheduled	hc-stats-task		12/17/2021
Merchandise Financial Planning (mfpncs)	System-Task: Update Offer Metrics	Scheduled	sys-offermetrics		12/17/2021
Merchandise Financial Planning (mfpncs)	Health-Check: Purge Old Logs	Scheduled	hc-purgelogs-task		12/17/2021
Retail Predictive Application Server (ppa2)	System-Task: Update Offer Metrics	Scheduled	sys-offermetrics		12/17/2021
Retail Predictive Application Server (ppa2)	Health-Check: Purge Old Logs	Scheduled	hc-purgelogs-task		12/17/2021
Retail Predictive Application Server (ppa2)	System-Task: Update Offer Metrics	Scheduled	sys-offermetrics		12/17/2021

Active Users

The Active Users dashboard tile, shown in Figure 5-85, provides information on all users currently accessing the application. This information can be used to determine who is currently in the system; an administrator can use this information when notifying users to log out prior to running an administrative task.

Figure 5-85 Active Users

Application	Username	User Label	Groups	Last Login	# of Sessions
Retail Predictive Application ...	oracleuser	Oracle Internal User	Admin	5/23/23, 9:34:48 AM	1
Merchandise Financial Plann...	adm1	adm1	Administrator,MFP Admin,M...	5/23/23, 9:55:13 AM	1
Retail Predictive Application ...	ocladmin	OCI Admin	Administrator	5/23/23, 9:53:59 AM	1

The Active Users profile lists all users currently logged into the application. For each active user, the following information is provided.

- Logged-in user's application name
- Logged-in user's name
- Logged-in user's label
- Logged-in user's groups
- Logged-in user's last login time
- Number of active sessions for the user

Other Active User Options

The following Active User options are available.

Manage Columns

The Active Users table columns can be managed by using the View menu -> Manage Columns option or from the column header context menu -> Manage Columns option. Administrators can use Manage Columns, shown in [Figure 5-86](#), to hide unwanted columns in the Active Users table.

Figure 5-86 Manage Columns

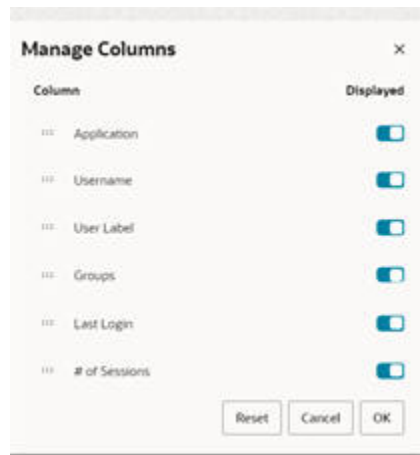

Detach

The Active Users table can be detached using the toolbar Detach action, using the View menu -> Detach option, or from the column header/row context menu -> Detach option, as shown in [Figure 5-87](#).

Figure 5-87 Detach

Active Users

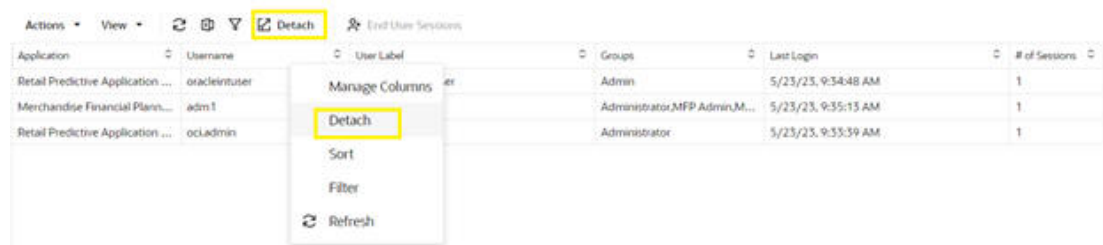

Sorting

The Active Users table can be sorted by any column by using the Sort Ascending and Sort Descending arrows that are visible when you hover over the column header, as shown in [Figure 5-88](#). The Active Users list can also be sorted by using the View menu -> Sort option or from the column header context menu -> Sort option.

Figure 5-88 Sorting

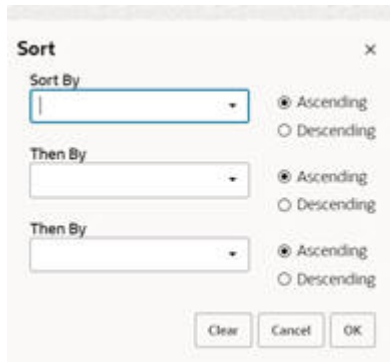

Filtering

The Active Users table can be filtered by any columns. The user can also use the View menu -> Filter option or the column header/row context menu -> Filter option to obtain filtered results, as shown in [Figure 5-89](#).

Figure 5-89 Filtering

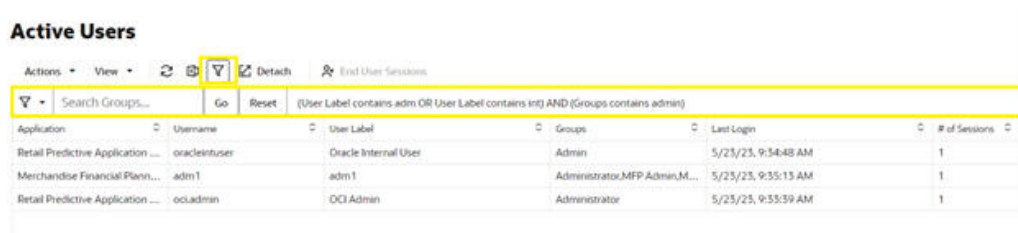

Select All

All of the Active Users table rows can be selected using the Action menu -> Select All option or using the row context menu -> Select All option, as shown in [Figure 5-90](#).

Figure 5-90 Select All

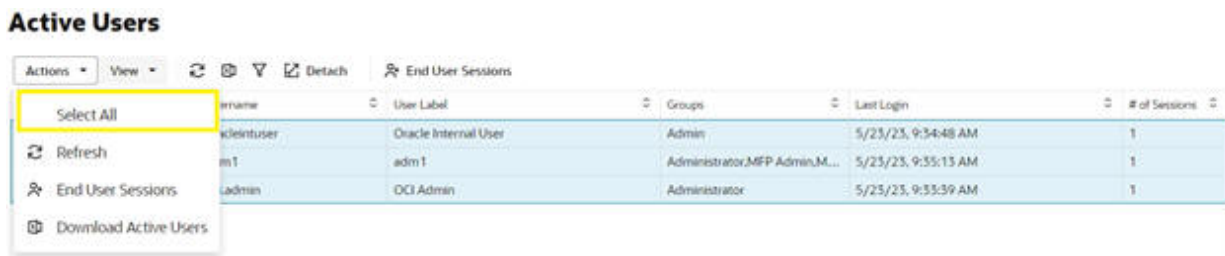

Refresh

The Active Users table data can be reloaded using the refresh toolbar action, from the Action menu -> Refresh option, or from the column header context menu -> Refresh option, as shown in [Figure 5-91](#).

Figure 5-91 Refresh

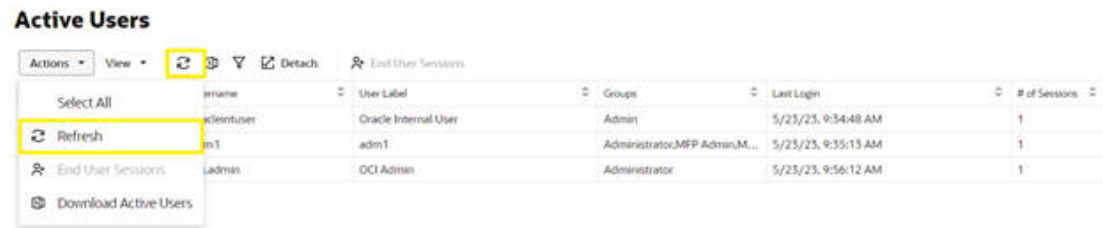

Download Active Users

The user can download the active users' details in the format of an Excel spreadsheet using either the toolbar Download Active Users action or from the Action menu -> Download Active Users option, as shown in [Figure 5-92](#).

Figure 5-92 Download Active Users

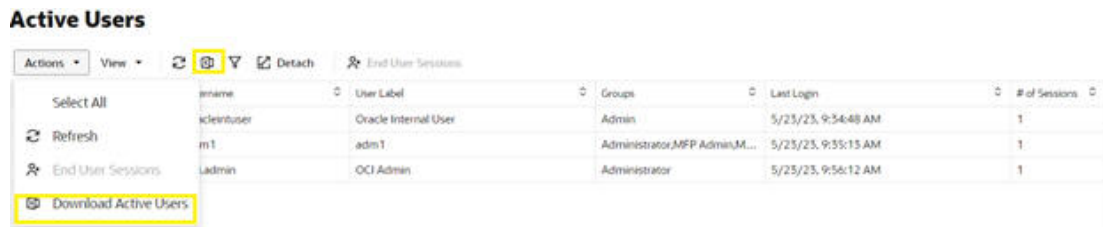

End User Sessions

An administrator can end a user's session of the same application if the user has left the session idle for long using either from toolbar End User Sessions action or from Action menu -> End User Sessions option or from row context menu -> End User Sessions option.

Figure 5-93 End User Sessions

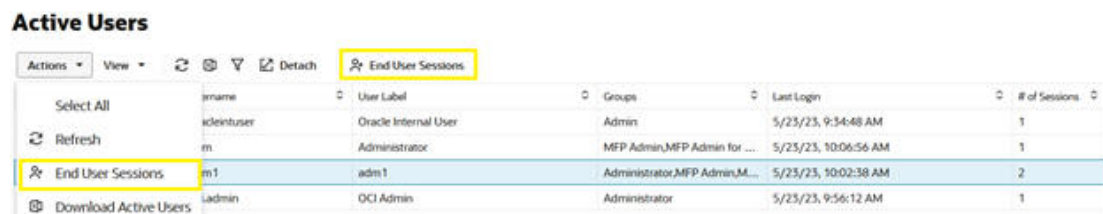

6

Data Administration

This chapter addresses the following tasks.

- [CSV File Format](#)
- [Hierarchy Management](#)
- [Modifying Hierarchies](#)
- [Managing Dimension Data](#)
- [Managing Informal Positions](#)
- [Exporting Hierarchy Data](#)
- [Loading Measure/Fact Data](#)
- [Exporting Measure Data](#)

CSV File Format

For those tasks that use a comma-separated value (CSV) file, the following formatting applies for any commas or double quotation marks in the data:

- If the data does not contain any commas or double quotation marks, it does not require any special formatting.
- If the data contains a comma, the string must be enclosed between the opening and closing double quotation marks.
- If the data contains quotation marks, the string must be enclosed between the opening and closing double quotation marks and any embedded quotation marks must be paired.

[Table 6-1](#) shows examples of the formatting.

Table 6-1 Example CSV File Formatting

Data	Formatted Data
Item 001	Item 001
Item 001, Soda	"Item 001, Soda"
"Large Screen" TV	""Large Screen"" TV"
Item 002, "Generic Brand" Cereal	"Item 002, ""Generic Brand"" Cereal"

Hierarchy Management

The following key concepts and processes are critical to the hierarchy management process:

- Hierarchy structures are loaded into an application using the load hierarchy data administration task.

- RPASCE uses integer indexing for simplified hierarchy administration. A set number of hierarchy positions, based on bit size, are allocated to each dimension. The pre-allocation of positions reduces the need for updating the measure data structures.
- The length of position names is 24 characters or less by default. Changes to the position length require updating the application configuration and patching the application.
- A position name cannot be an empty string and must not contain any of the following characters:
"(), \^{}[]!#=% + ` any ctrl char any space equivalent
ASCII uppercase characters in the position name are converted to lowercase by the application.

Modifying Hierarchies

The patching process supports adding new dimensions or removing existing dimensions. The new dimensions can be added anywhere in the hierarchy. Changes to the existing roll-up relationship of existing dimensions are not supported by the patching process.

The following example shows PROD hierarchy in original configuration, and some changes made to it.

Figure 6-1 shows the original configuration.

Figure 6-1 Original Configuration

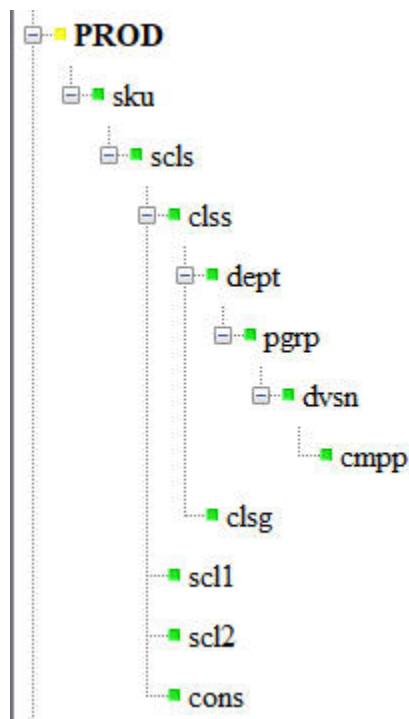

Figure 6-2 shows an example of adding new dimensions (new, new2) to construct a new branch off the existing hierarchy.

Figure 6-2 Adding New Branch

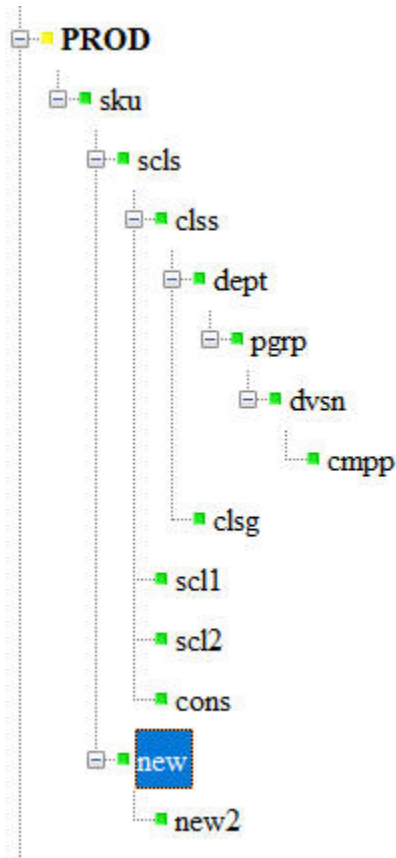

Figure 6-3 and Figure 6-4 show more examples of adding new dimensions in two cases.

Figure 6-3 Adding New Dimensions - Example 1

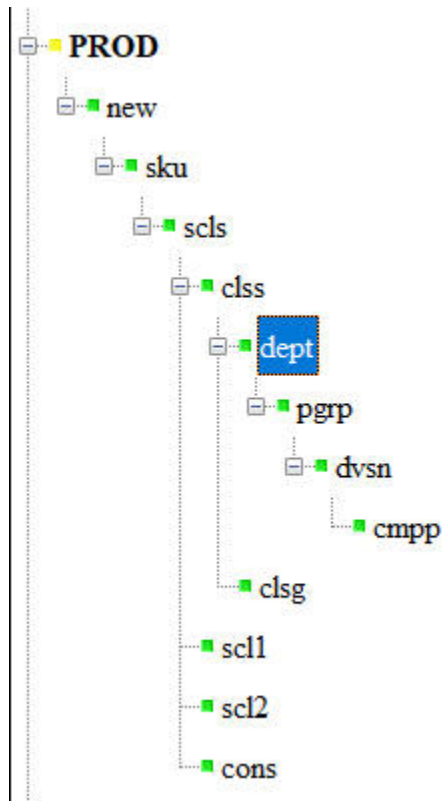
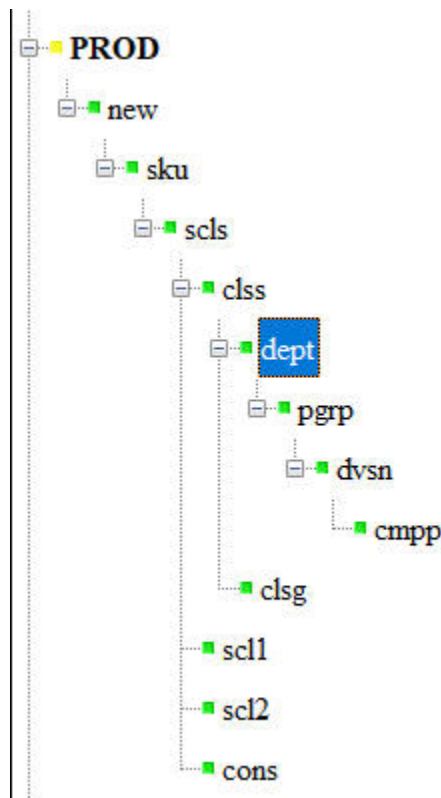

Figure 6-4 Adding New Dimensions - Example 2



For the steps to patch your existing application, see your application's Administration Guide.

In general, the configuration tools do not allow this use case; however, it is possible that this use case can occur when using plug-ins. If the RPASCE name of the new level being added collides with RPASCE name of any existing level in any hierarchy, then the patching of the application will fail. Users must use unique dimension names when modifying the configuration.

Managing Dimension Data

RPASCE provides two methods for updating dimension/hierarchy data, The Load Dimension Data (PDS Admin Tasks group) administration task and the Configured Batch Task. The operation supports comma-separated values (CSV) with a header line for loading only. The load file requires either a csv.dat or a hdr.csv.dat file extension. Multiple input files can be loaded for the same hierarchy. The extra input files must be named with a secondary extension (for example, prod.csv.dat.1) and they can be loaded only with the main input file. For example, you cannot load prod.csv.dat.1 by itself in a separate Load Dimension Data task. It must be loaded along with the main input, prod.csv.dat. Every data file must contain a header line, and if multiple data files are provided, all data files must have the same header line. Multiple files are often used when the hierarchy load data comes from different sources.

The process supports the loading of new positions, the purging of outdated positions, and the updating of rollup structure of positions in one operation. It will maintain a consistent rollup structure defined by the configuration.

For details on the Configured Batch Task and the usage of control files, see [Batch Administration](#) and *Oracle Retail Predictive Application Server Cloud Service Implementation Guide*.

For an example on submitting the Load Dimension Data task, see [Planning Data Schema Administration](#).

Reclassification

During reclassification, the data of the reclassified entities are moved under the new parent.

For example:

- If Department 100 has 20 SKUs and 10 SKUs from Department 100 are moved to Department 200, then the data of these 10 SKUs is moved under Department 200 and the aggregations for Department 100 and 200 are refreshed to cover the reclassification.
- If Department 300 has 10 SKUs and all of them are moved to Department 400, then the data of these 10 SKUs is moved under Department 400 and the aggregations for Department 400 are refreshed to cover the reclassification. Department 300 is removed from PDS.

Managing Informal Positions

The Manage Informal Positions OAT task is a task that maintains informal positions for a Dynamic Position Maintenance-enabled dimension in the application. Informal positions are ad-hoc positions created using the workbook interface. Positions created by the Load Dimension Data process are considered to be formal positions. This task can convert positions from formal to informal or from informal to formal. It can also remove informal positions, create informal positions in bulk, and copy data slices between positions in measures. Limited operations are also provided in the Batch Framework through the batch service catalog. See [Batch Administration](#) and *Oracle Retail Predictive Application Server Cloud Service Implementation Guide*.

For example of how to submit the Manage Informal Positions OAT task, see the relevant section in [Online Administration Tools](#).

Exporting Hierarchy Data

The Export Hierarchy Data OAT task is used to export all the positions in a hierarchy, including their rollup relations. By default, the utility exports files in the CSV flat file format. The utility exports all hierarchy positions, but the operation may optionally include only formal or informal positions. The resulting file can then be used as an input file to a Load Dimension Data task.

For an example of submitting an Export Hierarchy OAT Task, see the relevant section in [Online Administration Tools](#).

Loading Measure/Fact Data

The Load Measure Data task (loadMeasure task) is used to load measure data from text files into the application. The administrator must specify the measure names. The

Load Measure Data task supports the use of fixed width and CSV files for loading measure data. RPASCE recommends the use of CSV files to reduce the size of the load file and to reduce disk I/O time. To load measure data, system administrators must create and transfer one or more load files in the input folder of the application directory. The administrator can then submit the Load Measure Data task to load data.

For an example of submitting a Load Fact Data OAT Task, see the relevant section in [Planning Data Schema Administration](#).

Exporting Measure Data

The Export Measure Data task can be used to export an application from RPASCE in .csv file format. A single measure or multiple measures may be exported, based on a specified intersection. If the intersection is not specified, then the base intersection of the measure will be used. If the measure's base intersection is not the same as the export intersection, the measure's default aggregation method will be used to aggregate data to an intersection higher than the base intersection, or replication will be used for spreading measure data if the data is required at an intersection lower than the base intersection.

The Export Measure Data task supports the export of data in a user-specified range by providing a single mask measure, a range specified on the Calendar dimension, or a combination of the two.

For an example of submitting an Export Measure OAT Task, see the relevant section in [Online Administration Tools](#).

For details on exporting data using the Batch Framework, see [Batch Administration](#) and *Oracle Retail Predictive Application Server Cloud Service Implementation Guide*.

Placeholder Web Service

There are multiple ways to create new informal hierarchy positions using Dynamic Position Maintenance (DPM). New hierarchy positions can be added in a workspace or using the informal position manager oat task. Additionally, there is a webservice available that can create new informal positions.

For a list of possible webservice endpoints and their descriptions go to the swagger deploy at `BASEURL/rpasce-ui-ws/placeholder.html` on a browser.

The BASEURL will be like below for an environment in the IAD region. `https://rap.retail.us-ashburn-1.ocs.oraclecloud.com/<subnamespace name>`

Example:

<https://rap.retail.us-phoenix-1.ocs.oc-test.com/rgbu-rap-test-env1-rpasce/rpasce-ui-ws/placeholder.html>

7

Batch Administration

This chapter addresses the following batch administration tasks:

- [Run Batch Task Group](#)
- [Run Batch Measure Load Group](#)
- [Run Batch Measure Export Group](#)
- [Run Batch Calc Group](#)
- [Uploading and Downloading Data Files](#)

Application-Specific Batch Tasks

The application-configured batch tasks are a set of tasks that help the administrator perform routine batch processing operations, either in a recurring schedule (such as nightly and/or weekly) or loading and exporting a predefined set of data and hierarchies. These tasks are found in the Online Administration Tools as Configured Batch Tasks.

Each task in turn calls one or more batch services to do the required tasks. The catalog of available batch services to configure is listed and described in the *Oracle Retail Predictive Application Server Cloud Edition Implementation Guide*.

. Some tasks require data files (such as measure/fact load files or hierarchy/dimension load files) as input. These files must be uploaded via Object Storage before the tasks are scheduled. Some tasks export files from the application's data store. Those files are copied to the Object Storage location, and Administrators can download these exported files. For more information, see [Uploading and Downloading Data Files](#)

The following table shows the list of Online Admin task entries available for running or scheduling the application-configured batch tasks. Note that these are only a selection of the configured task types available. Any that are not directly available here may be run by executing the Batch Task Group of which they are a part.

Configured Batch Tasks

Run Batch Task Group
Run Batch Measure Load Group
Run Batch Measure Export Group
Run Batch Calc Group

Run Batch Task Group

This task is used to schedule a predefined set of batch tasks in a sequential order. The batch control file `batch_exec_list.txt` defines the steps in the specific order that will be executed during batch task execution. This task is typically used to schedule a daily or weekly batch. If any task aborts, a log is created and the process terminates. This task has the option to restart from the last failed service rather than running all the completed services again.

Depending on the type of application implementation, the Run Batch Task Group task can either be extended (see the application-specific Implementation Guides) or completely customized (see RPASCE Implementation Guide), via the `batch_exec_list.txt` control file. For more details about the list of internal services this task can call and how to change the order of services to this task, see the *Oracle Retail Predictive Application Server Cloud Edition Implementation Guide*.

Run Batch Measure Load Group

This task is used to load a predefined set of measures grouped as a measure set in the batch control file `batch_loadmeas_list.txt`. All required data files must be uploaded to the Object Storage location before scheduling this task. For more information, see [Uploading and Downloading Data Files](#). If no file is present to load a particular measure in that measure set, it will be logged as not found and skipped. This process will only load the data into those measures and will not run any subsequent calculations. (If follow-on operations such as calculations or workbook refreshes are desired, then the Batch Task Group must be used, rather than the Measure Load Group.)

The Run Batch Measure Load Group task can be customized to load different sets of measures by making changes to the batch control file. For information about changing the batch control files and how to upload them, see the *Oracle Retail Predictive Application Server Cloud Edition Implementation Guide*.

Run Batch Measure Export Group

This task exports a predefined set of measure data into flat files. The set of measures to be exported are defined in the batch control file `batch_exportmeas_list.txt`. This set of exported data can be used for integration with other applications. Exported files from this task are put into the Object Storage location; the administrator can download the files from this location. For more information, see [Uploading and Downloading Data Files](#).

The Run Batch Measure Export Group task can be customized by changes to the batch control file. For information about changing the batch control files and how to upload them, see the *Oracle Retail Predictive Application Server Cloud Edition Implementation Guide*.

Run Batch Calc Group

This task is used to run a predefined set of batch rules to do the necessary data processing, as defined in the batch control file `batch_calc_list.txt`. The Run Batch Calc group task can be customized to change the batch calculations and the order in which they run against the application by changing the batch control file. For information about changing the batch control files and how to upload them, see the *Oracle Retail Predictive Application Server Cloud Edition Implementation Guide*.

Uploading and Downloading Data Files

Oracle Cloud Infrastructure Object Storage service is used to upload and download data files for batch processing.

A public API has been provided to perform various actions on Object Storage.

A sample script is available in *Retail Analytics Platform Implementation Guide*. Download and save the script and update the environment variables in the script. Sample usages of scripts assuming the script has been saved as `fts.sh`.

- `fts.sh ping`
- `fts.sh listprefixes`
- `fts.sh listfiles <prefix>`
- `fts.sh uploadfiles <prefix> <file1 <file2>`
- `fts.sh downloadfiles <prefix> <file1> <file2>`
- `fts.sh deletefiles <prefix> <file1>`

Here is an example prefix: `planning/<Your-SubNameSpace>/incoming/input`.

8

RPASCE Batch Schedule with POM

Process Orchestration and Monitoring (POM) is the enterprise batch-scheduling solution for retail applications migrating to the cloud. It provides the functionality for automating the running and monitoring of both nightly batch executions and ad-hoc batch executions.

RPASCE Batch Framework provides a catalog of batch services from which the customer can define batch jobs by specifying one or more sequences of services in a control file. Each sequence has its own identifier that is used to schedule the batch job. In order for the RPASCE batch operations to fit into the POM framework, a process flow is created to include all regularly scheduled jobs, and each job is associated with an RPASCE batch control set. Additionally, an ad-hoc process is defined for each application that allows the customer to make a one-time request to execute any batch control set.

The execution of each job is carried out by the native Online Admin Tools (OAT) on the RPASCE server. The POM submits the jobs to OAT and waits for them to finish before retrieving their high level logs. The job status and high-level logs can be monitored and downloaded on the POM web interface. The job status and detailed logs are available on the OAT Dashboard of RPASCE Client.

RPASCE Batch Schedule

Table 8-1 lists the processes and jobs of the pre-defined RPASCE Batch Schedule. Each job has a corresponding batch control set in the RPASCE Batch Framework on the RPASCE server, except when the it is "no_op", in which case, the job is just a placeholder on POM to mark the start or end of a process.

Table 8-1 RPASCE Batch Schedule Jobs and Processes

Process Name	Job Name	Description	Batch Control Set	Application	Module
RPASCE_START_PROCESS	RPASCE_START_JOB	RPASCE Daily Start Job	no_op	RPASCE	
RPASCE_END_PROCESS	RPASCE_END_JOB	RPASCE Daily End Job	no_op	RPASCE	
RPASCE_HIER_IMP_PROCESS	RPASCE_HIER_IMP_START_JOB	RPASCE Common Hierarchy Import Start Job	no_op	RPASCE	
RPASCE_HIER_IMP_PROCESS	RPASCE_HIER_IMP_END_JOB	RPASCE Common Hierarchy Import End Job	no_op	RPASCE	
RPASCE_DATA_IMP_PROCESS	RPASCE_DATA_IMP_START_JOB	RPASCE Common Data Import Start Job	no_op	RPASCE	

Table 8-1 (Cont.) RPASCE Batch Schedule Jobs and Processes

Process Name	Job Name	Description	Batch Control Set	Application	Module
RPASCE_DATA_IMP_PROCESS	RPASCE_DATA_IMP_END_JOB	RPASCE Common Data Import End Job	no_op	RPASCE	
RPASCE_POST_IMP_PROCESS	RPASCE_POST_IMP_START_JOB	RPASCE Post Import Start Job	no_op	RPASCE	
RPASCE_POST_IMP_PROCESS	RPASCE_POST_IMP_END_JOB	RPASCE Post Import End Job	no_op	RPASCE	
MFP_PRE_EXPORT_PROCESS	MFP_PRE_EXPORT_START_JOB	MFP Pre Exports Start Job	no_op	MFP	MFP_Daily
MFP_PRE_EXPORT_PROCESS	MFP_PRE_EXPORT_RDX_D_JOB	MFP Pre Exports to RDX Daily Job	MFP_PRE_EXPORT_RDX_D	MFP	MFP_Daily
MFP_PRE_EXPORT_PROCESS	MFP_PRE_EXPORT_OBS_D_JOB	MFP Pre Exports to Files Daily Job	MFP_PRE_EXPORT_OBS_D	MFP	MFP_Daily
MFP_PRE_EXPORT_PROCESS	MFP_PRE_EXPORT_RDX_W_JOB	MFP Pre Exports to RDX Weekly Job	MFP_PRE_EXPORT_RDX_W	MFP	MFP_Daily
MFP_PRE_EXPORT_PROCESS	MFP_PRE_EXPORT_OBS_W_JOB	MFP Pre Exports to Files Weekly Job	MFP_PRE_EXPORT_OBS_W	MFP	MFP_Daily
MFP_PRE_EXPORT_PROCESS	MFP_PRE_EXPORT_END_JOB	MFP Pre Exports End Job	no_op	MFP	MFP_Daily
MFP_COMMON_HIER_IMPORT_PROCESS	MFP_COMMON_HIER_IMPORT_START_JOB	MFP Common Hierarchy Imports Start Job	no_op	MFP	MFP_Daily
MFP_COMMON_HIER_IMPORT_PROCESS	MFP_COMMON_HIER_IMPORT_RDX_D_JOB	MFP Common Hierarchy Imports from RDX Daily Job	MFP_COMMON_HIER_IMPORT_RDX_D	MFP	MFP_Daily
MFP_COMMON_HIER_IMPORT_PROCESS	MFP_COMMON_HIER_IMPORT_OBS_D_JOB	MFP Common Hierarchy Imports from Files Daily Job	MFP_COMMON_HIER_IMPORT_OBS_D	MFP	MFP_Daily
MFP_COMMON_HIER_IMPORT_PROCESS	MFP_COMMON_HIER_IMPORT_RDX_W_JOB	MFP Common Hierarchy Imports from RDX Weekly Job	MFP_COMMON_HIER_IMPORT_RDX_W	MFP	MFP_Daily

Table 8-1 (Cont.) RPASCE Batch Schedule Jobs and Processes

Process Name	Job Name	Description	Batch Control Set	Application	Module
MFP_COM_HIER_IMP_PROC ESS	MFP_COM_HIER_IMP_OBS_ W_JOB	MFP Common Hierarchy Imports from Files Weekly Job	MFP_COM_HIER_IMP_OBS_ W	MFP	MFP_Daily
MFP_COM_HIER_IMP_PROC ESS	MFP_COM_HIER_IMP_END_ JOB	MFP Common Hierarchy Imports End Job	no_op	MFP	MFP_Daily
MFP_COM_DATA_IMP_PROC ESS	MFP_COM_DATA_IMP_STAR T_JOB	MFP Common Data Imports Start Job	no_op	MFP	MFP_Daily
MFP_COM_DATA_IMP_PROC ESS	MFP_COM_DATA_IMP_RDX_ D_JOB	MFP Common Data Imports from RDX Daily Job	MFP_COM_DATA_IMP_RDX_ D	MFP	MFP_Daily
MFP_COM_DATA_IMP_PROC ESS	MFP_COM_DATA_IMP_OBS_ D_JOB	MFP Common Data Imports from Files Daily Job	MFP_COM_DATA_IMP_OBS_ D	MFP	MFP_Daily
MFP_COM_DATA_IMP_PROC ESS	MFP_COM_DATA_IMP_RDX_ W_JOB	MFP Common Data Imports from RDX Weekly Job	MFP_COM_DATA_IMP_RDX_ W	MFP	MFP_Weekly
MFP_COM_DATA_IMP_PROC ESS	MFP_COM_DATA_IMP_OBS_ W_JOB	MFP Common Data Imports from Files Weekly Job	MFP_COM_DATA_IMP_OBS_ W	MFP	MFP_Weekly
MFP_COM_DATA_IMP_PROC ESS	MFP_COM_DATA_IMP_END_ JOB	MFP Common Data Imports End Job	no_op	MFP	MFP_Daily
MFP_HIER_IMP_PROCESS	MFP_HIER_IMP_START_ JOB	MFP Hierarchy Imports Start Job	no_op	MFP	MFP_Daily
MFP_HIER_IMP_PROCESS	MFP_HIER_IMP_RDX_D_ JOB	MFP Hierarchy Imports from RDX Daily Job	MFP_HIER_IMP_RDX_D	MFP	MFP_Daily
MFP_HIER_IMP_PROCESS	MFP_HIER_IMP_OBS_D_ JOB	MFP Hierarchy Imports from Files Daily Job	MFP_HIER_IMP_OBS_D	MFP	MFP_Daily
MFP_HIER_IMP_PROCESS	MFP_HIER_IMP_RDX_W_ JOB	MFP Hierarchy Imports from RDX Weekly Job	MFP_HIER_IMP_RDX_W	MFP	MFP_Weekly
MFP_HIER_IMP_PROCESS	MFP_HIER_IMP_OBS_W_ JOB	MFP Hierarchy Imports from Files Weekly Job	MFP_HIER_IMP_OBS_W	MFP	MFP_Weekly

Table 8-1 (Cont.) RPASCE Batch Schedule Jobs and Processes

Process Name	Job Name	Description	Batch Control Set	Application	Module
MFP_HIER_IMP_PROCESS	MFP_HIER_IMP_END_JOB	MFP Hierarchy Imports End Job	no_op	MFP	MFP_Daily
MFP_PRE_DATA_IMPORT_PROCESS	MFP_PRE_DATA_IMPORT_START_JOB	MFP Pre Data Imports Start Job	no_op	MFP	MFP_Daily
MFP_PRE_DATA_IMPORT_PROCESS	MFP_PRE_DATA_IMPORT_RDX_D_JOB	MFP Pre Data Imports from RDX Daily Job	MFP_PRE_DATA_IMPORT_RDX_D	MFP	MFP_Daily
MFP_PRE_DATA_IMPORT_PROCESS	MFP_PRE_DATA_IMPORT_OBS_D_JOB	MFP Pre Data Imports from Files Daily Job	MFP_PRE_DATA_IMPORT_OBS_D	MFP	MFP_Daily
MFP_PRE_DATA_IMPORT_PROCESS	MFP_PRE_DATA_IMPORT_RDX_W_JOB	MFP Pre Data Imports from RDX Weekly Job	MFP_PRE_DATA_IMPORT_RDX_W	MFP	MFP_Weekly
MFP_PRE_DATA_IMPORT_PROCESS	MFP_PRE_DATA_IMPORT_OBS_W_JOB	MFP Pre Data Imports from Files Weekly Job	MFP_PRE_DATA_IMPORT_OBS_W	MFP	MFP_Weekly
MFP_PRE_DATA_IMPORT_PROCESS	MFP_PRE_DATA_IMPORT_END_JOB	MFP Pre Data Imports End Job	no_op	MFP	MFP_Daily
MFP_BATCH_AGG_PROCESS	MFP_BATCH_AGG_START_JOB	MFP Batch Calculations Start Job	no_op	MFP	MFP_Daily
MFP_BATCH_AGG_PROCESS	MFP_BATCH_AGG_D_JOB	MFP Batch Calculations Daily Job	MFP_BATCH_AGG_D	MFP	MFP_Daily
MFP_BATCH_AGG_PROCESS	MFP_BATCH_AGG_W_JOB	MFP Batch Calculations Weekly Job	MFP_BATCH_AGG_W	MFP	MFP_Weekly
MFP_BATCH_AGG_PROCESS	MFP_BATCH_AGG_END_JOB	MFP Batch Calculations End Job	no_op	MFP	MFP_Daily
MFP_POST_DATA_IMPORT_PROCESS	MFP_POST_DATA_IMPORT_START_JOB	MFP Post Data Imports Start Job	no_op	MFP	MFP_Daily
MFP_POST_DATA_IMPORT_PROCESS	MFP_POST_DATA_IMPORT_RDX_D_JOB	MFP Post Data Imports from RDX Daily Job	MFP_POST_DATA_IMPORT_RDX_D	MFP	MFP_Daily
MFP_POST_DATA_IMPORT_PROCESS	MFP_POST_DATA_IMPORT_OBS_D_JOB	MFP Post Data Imports from Files Daily Job	MFP_POST_DATA_IMPORT_OBS_D	MFP	MFP_Daily

Table 8-1 (Cont.) RPASCE Batch Schedule Jobs and Processes

Process Name	Job Name	Description	Batch Control Set	Application	Module
MFP_POST_D ATA_IMP_PRO CESS	MFP_POST_D ATA_IMP_RDX _W_JOB	MFP Post Data Imports from RDX Weekly Job	MFP_POST_D ATA_IMP_RDX _W	MFP	MFP_Weekly
MFP_POST_D ATA_IMP_PRO CESS	MFP_POST_D ATA_IMP_OBS _W_JOB	MFP Post Data Imports from Files Weekly Job	MFP_POST_D ATA_IMP_OBS _W	MFP	MFP_Weekly
MFP_POST_D ATA_IMP_PRO CESS	MFP_POST_D ATA_IMP_END _JOB	MFP Post Data Imports End Job	no_op	MFP	MFP_Daily
MFP_POST_E XP_PROCESS	MFP_POST_E XP_START_JO B	MFP Post Exports Start Job	no_op	MFP	MFP_Daily
MFP_POST_E XP_PROCESS	MFP_POST_E XP_RDX_D_J OB	MFP Post Exports to RDX Daily Job	MFP_POST_E XP_RDX_D	MFP	MFP_Daily
MFP_POST_E XP_PROCESS	MFP_POST_E XP_OBS_D_J OB	MFP Post Exports to Files Daily Job	MFP_POST_E XP_OBS_D	MFP	MFP_Daily
MFP_POST_E XP_PROCESS	MFP_POST_E XP_RDX_W_J OB	MFP Post Exports to RDX Weekly Job	MFP_POST_E XP_RDX_W	MFP	MFP_Weekly
MFP_POST_E XP_PROCESS	MFP_POST_E XP_OBS_W_J OB	MFP Post Exports to Files Weekly Job	MFP_POST_E XP_OBS_W	MFP	MFP_Weekly
MFP_POST_E XP_PROCESS	MFP_POST_E XP_END_JOB	MFP Post Exports End Job	no_op	MFP	MFP_Daily
MFP_WB_BUIL D_PROCESS	MFP_WB_BUI LD_START_JO B	MFP Workbook Build/Refresh Start Job	no_op	MFP	MFP_Daily
MFP_WB_BUIL D_PROCESS	MFP_WB_BUI LD_D_JOB	MFP Workbook Build/Refresh Daily Job	MFP_WB_BUI LD_D	MFP	MFP_Daily
MFP_WB_BUIL D_PROCESS	MFP_WB_BUI LD_W_JOB	MFP Workbook Build/Refresh Weekly Job	MFP_WB_BUI LD_W	MFP	MFP_Weekly
MFP_WB_BUIL D_PROCESS	MFP_WB_BUI LD_END_JOB	MFP Workbook Build/Refresh End Job	no_op	MFP	MFP_Daily
MFP_STATS_P ROCESS	MFP_STATS_S TART_JOB	MFP Stats Start Job	no_op	MFP	MFP_Daily
MFP_STATS_P ROCESS	MFP_STATS_O FFER_W_JOB	MFP Stats Offer Metrics Job	MFP_STATS_ OFFER_W	MFP	MFP_Weekly

Table 8-1 (Cont.) RPASCE Batch Schedule Jobs and Processes

Process Name	Job Name	Description	Batch Control Set	Application	Module
MFP_STATS_PROCESS	MFP_STATS_END_JOB	MFP Stats End Job	no_op	MFP	MFP_Daily
MFP_ADHOC_01_PROCESS	MFP_ADHOC_01_JOB	MFP Adhoc 01 Job	#SysOpt.mfpAdhoc01	MFP	MFP_Adhoc
MFP_ADHOC_02_PROCESS	MFP_ADHOC_02_JOB	MFP Adhoc 02 Job	#SysOpt.mfpAdhoc02	MFP	MFP_Adhoc
MFP_ADHOC_03_PROCESS	MFP_ADHOC_03_JOB	MFP Adhoc 03 Job	#SysOpt.mfpAdhoc03	MFP	MFP_Adhoc
MFP_ADHOC_04_PROCESS	MFP_ADHOC_04_JOB	MFP Adhoc 04 Job	#SysOpt.mfpAdhoc04	MFP	MFP_Adhoc
MFP_ADHOC_05_PROCESS	MFP_ADHOC_05_JOB	MFP Adhoc 05 Job	#SysOpt.mfpAdhoc05	MFP	MFP_Adhoc
MFP_ADHOC_06_PROCESS	MFP_ADHOC_06_JOB	MFP Adhoc 06 Job	#SysOpt.mfpAdhoc06	MFP	MFP_Adhoc
MFP_ADHOC_07_PROCESS	MFP_ADHOC_07_JOB	MFP Adhoc 07 Job	#SysOpt.mfpAdhoc07	MFP	MFP_Adhoc
MFP_ADHOC_08_PROCESS	MFP_ADHOC_08_JOB	MFP Adhoc 08 Job	#SysOpt.mfpAdhoc08	MFP	MFP_Adhoc
MFP_ADHOC_09_PROCESS	MFP_ADHOC_09_JOB	MFP Adhoc 09 Job	#SysOpt.mfpAdhoc09	MFP	MFP_Adhoc
MFP_ADHOC_10_PROCESS	MFP_ADHOC_10_JOB	MFP Adhoc 10 Job	#SysOpt.mfpAdhoc10	MFP	MFP_Adhoc
AP_PRE_EXP_PROCESS	AP_PRE_EXP_START_JOB	AP Pre Exports Start Job	no_op	AP	AP_Daily
AP_PRE_EXP_PROCESS	AP_PRE_EXP_RDX_D_JOB	AP Pre Exports to RDX Daily Job	AP_PRE_EXP_RDX_D	AP	AP_Daily
AP_PRE_EXP_PROCESS	AP_PRE_EXP_OBS_D_JOB	AP Pre Exports to Files Daily Job	AP_PRE_EXP_OBS_D	AP	AP_Daily
AP_PRE_EXP_PROCESS	AP_PRE_EXP_RDX_W_JOB	AP Pre Exports to RDX Weekly Job	AP_PRE_EXP_RDX_W	AP	AP_Weekly
AP_PRE_EXP_PROCESS	AP_PRE_EXP_OBS_W_JOB	AP Pre Exports to Files Weekly Job	AP_PRE_EXP_OBS_W	AP	AP_Weekly
AP_PRE_EXP_PROCESS	AP_PRE_EXP_END_JOB	AP Pre Exports End Job	no_op	AP	AP_Daily
AP_COM_HIER_IMPORTS_PROCESS	AP_COM_HIER_IMPORTS_START_JOB	AP Common Hierarchy Imports Start Job	no_op	AP	AP_Daily

Table 8-1 (Cont.) RPASCE Batch Schedule Jobs and Processes

Process Name	Job Name	Description	Batch Control Set	Application	Module
AP_COM_HIE R_IMP_PROCE SS	AP_COM_HIE R_IMP_RDX_D _JOB	AP Common Hierarchy Imports from RDX Daily Job	AP_COM_HIE R_IMP_RDX_ D	AP	AP_Daily
AP_COM_HIE R_IMP_PROCE SS	AP_COM_HIE R_IMP_OBS_D _JOB	AP Common Hierarchy Imports from Files Daily Job	AP_COM_HIE R_IMP_OBS_ D	AP	AP_Daily
AP_COM_HIE R_IMP_PROCE SS	AP_COM_HIE R_IMP_RDX_ W_JOB	AP Common Hierarchy Imports from RDX Weekly Job	AP_COM_HIE R_IMP_RDX_ W	AP	AP_Weekly
AP_COM_HIE R_IMP_PROCE SS	AP_COM_HIE R_IMP_OBS_ W_JOB	AP Common Hierarchy Imports from Files Weekly Job	AP_COM_HIE R_IMP_OBS_ W	AP	AP_Weekly
AP_COM_HIE R_IMP_PROCE SS	AP_COM_HIE R_IMP_END_J OB	AP Common Hierarchy Imports End Job	no_op	AP	AP_Daily
AP_COM_DAT A_IMP_PROCE SS	AP_COM_DAT A_IMP_START _JOB	AP Common Data Imports Start Job	no_op	AP	AP_Daily
AP_COM_DAT A_IMP_PROCE SS	AP_COM_DAT A_IMP_RDX_D _JOB	AP Common Data Imports from RDX Daily Job	AP_COM_DAT A_IMP_RDX_D	AP	AP_Daily
AP_COM_DAT A_IMP_PROCE SS	AP_COM_DAT A_IMP_OBS_D _JOB	AP Common Data Imports from Files Daily Job	AP_COM_DAT A_IMP_OBS_D	AP	AP_Daily
AP_COM_DAT A_IMP_PROCE SS	AP_COM_DAT A_IMP_RDX_ W_JOB	AP Common Data Imports from RDX Weekly Job	AP_COM_DAT A_IMP_RDX_ W	AP	AP_Weekly
AP_COM_DAT A_IMP_PROCE SS	AP_COM_DAT A_IMP_OBS_ W_JOB	AP Common Data Imports from Files Weekly Job	AP_COM_DAT A_IMP_OBS_ W	AP	AP_Weekly
AP_COM_DAT A_IMP_PROCE SS	AP_COM_DAT A_IMP_END_J OB	AP Common Data Imports End Job	no_op	AP	AP_Daily
AP_HIER_IMP _PROCESS	AP_HIER_IMP _START_JOB	AP Hierarchy Imports Start Job	no_op	AP	AP_Daily

Table 8-1 (Cont.) RPASCE Batch Schedule Jobs and Processes

Process Name	Job Name	Description	Batch Control Set	Application	Module
AP_HIER_IMP_PROCESS	AP_HIER_IMP_RDX_D_JOB	AP Hierarchy Imports from RDX Daily Job	AP_HIER_IMP_RDX_D	AP	AP_Daily
AP_HIER_IMP_PROCESS	AP_HIER_IMP_OBS_D_JOB	AP Hierarchy Imports from Files Daily Job	AP_HIER_IMP_OBS_D	AP	AP_Daily
AP_HIER_IMP_PROCESS	AP_HIER_IMP_RDX_W_JOB	AP Hierarchy Imports from RDX Weekly Job	AP_HIER_IMP_RDX_W	AP	AP_Weekly
AP_HIER_IMP_PROCESS	AP_HIER_IMP_OBS_W_JOB	AP Hierarchy Imports from Files Weekly Job	AP_HIER_IMP_OBS_W	AP	AP_Weekly
AP_HIER_IMP_PROCESS	AP_HIER_IMP_END_JOB	AP Hierarchy Imports End Job	no_op	AP	AP_Daily
AP_PRE_DATA_IMP_PROCESS	AP_PRE_DATA_IMP_START_JOB	AP Pre Data Imports Start Job	no_op	AP	AP_Daily
AP_PRE_DATA_IMP_PROCESS	AP_PRE_DATA_IMP_RDX_D_JOB	AP Pre Data Imports from RDX Daily Job	AP_PRE_DATA_IMP_RDX_D	AP	AP_Daily
AP_PRE_DATA_IMP_PROCESS	AP_PRE_DATA_IMP_OBS_D_JOB	AP Pre Data Imports from Files Daily Job	AP_PRE_DATA_IMP_OBS_D	AP	AP_Daily
AP_PRE_DATA_IMP_PROCESS	AP_PRE_DATA_IMP_RDX_W_JOB	AP Pre Data Imports from RDX Weekly Job	AP_PRE_DATA_IMP_RDX_W	AP	AP_Weekly
AP_PRE_DATA_IMP_PROCESS	AP_PRE_DATA_IMP_OBS_W_JOB	AP Pre Data Imports from Files Weekly Job	AP_PRE_DATA_IMP_OBS_W	AP	AP_Weekly
AP_PRE_DATA_IMP_PROCESS	AP_PRE_DATA_IMP_END_JOB	AP Pre Data Imports End Job	no_op	AP	AP_Daily
AP_BATCH_AGG_PROCESS	AP_BATCH_AGG_START_JOB	AP Batch Calculations Start Job	no_op	AP	AP_Daily
AP_BATCH_AGG_PROCESS	AP_BATCH_AGG_D_JOB	AP Batch Calculations Daily Job	AP_BATCH_AGG_D	AP	AP_Daily
AP_BATCH_AGG_PROCESS	AP_BATCH_AGG_W_JOB	AP Batch Calculations Weekly Job	AP_BATCH_AGG_W	AP	AP_Weekly

Table 8-1 (Cont.) RPASCE Batch Schedule Jobs and Processes

Process Name	Job Name	Description	Batch Control Set	Application	Module
AP_BATCH_AGG_PROCESS	AP_BATCH_AGG_END_JOB	AP Batch Calculations End Job	no_op	AP	AP_Daily
AP_EGRS_EXPORT_PROCESS	AP_EGRS_EXPORT_START_JOB	AP Egress Exports Start Job	no_op	AP	AP_Daily
AP_EGRS_EXPORT_PROCESS	AP_EGRS_EXPORT_RDX_DJOB	AP Egress Exports to RDX Daily Job	AP_EGRS_EXPORT_RDX_D	AP	AP_Daily
AP_EGRS_EXPORT_PROCESS	AP_EGRS_EXPORT_RDX_WJOB	AP Egress Exports to RDX Weekly Job	AP_EGRS_EXPORT_RDX_W	AP	AP_Weekly
AP_EGRS_EXPORT_PROCESS	AP_EGRS_EXPORT_END_JOB	AP Egress Exports End Job	no_op	AP	AP_Daily
AP_POST_DATA_IMPORT_PROCESS	AP_POST_DATA_IMPORT_START_JOB	AP Post Data Imports Start Job	no_op	AP	AP_Daily
AP_POST_DATA_IMPORT_PROCESS	AP_POST_DATA_IMPORT_RDX_DJOB	AP Post Data Imports from RDX Daily Job	AP_POST_DATA_IMPORT_RDX_D	AP	AP_Daily
AP_POST_DATA_IMPORT_PROCESS	AP_POST_DATA_IMPORT_OBS_DJOB	AP Post Data Imports from Files Daily Job	AP_POST_DATA_IMPORT_OBS_D	AP	AP_Daily
AP_POST_DATA_IMPORT_PROCESS	AP_POST_DATA_IMPORT_RDX_WJOB	AP Post Data Imports from RDX Weekly Job	AP_POST_DATA_IMPORT_RDX_W	AP	AP_Weekly
AP_POST_DATA_IMPORT_PROCESS	AP_POST_DATA_IMPORT_OBS_WJOB	AP Post Data Imports from Files Weekly Job	AP_POST_DATA_IMPORT_OBS_W	AP	AP_Weekly
AP_POST_DATA_IMPORT_PROCESS	AP_POST_DATA_IMPORT_END_JOB	AP Post Data Imports End Job	no_op	AP	AP_Daily
AP_POST_EXPORT_PROCESS	AP_POST_EXPORT_START_JOB	AP Post Exports Start Job	no_op	AP	AP_Daily
AP_POST_EXPORT_PROCESS	AP_POST_EXPORT_RDX_DJOB	AP Post Exports to RDX Daily Job	AP_POST_EXPORT_RDX_D	AP	AP_Daily
AP_POST_EXPORT_PROCESS	AP_POST_EXPORT_OBS_DJOB	AP Post Exports to Files Daily Job	AP_POST_EXPORT_OBS_D	AP	AP_Daily
AP_POST_EXPORT_PROCESS	AP_POST_EXPORT_RDX_WJOB	AP Post Exports to RDX Weekly Job	AP_POST_EXPORT_RDX_W	AP	AP_Weekly

Table 8-1 (Cont.) RPASCE Batch Schedule Jobs and Processes

Process Name	Job Name	Description	Batch Control Set	Application	Module
AP_POST_EX P_PROCESS	AP_POST_EX P_OBS_W_JO B	AP Post Exports to Files Weekly Job	AP_POST_EX P_OBS_W	AP	AP_Weekly
AP_POST_EX P_PROCESS	AP_POST_EX P_END_JOB	AP Post Exports End Job	no_op	AP	AP_Daily
AP_WB_BUILD _PROCESS	AP_WB_BUILD _START_JOB	AP Workbook Build/Refresh Start Job	no_op	AP	AP_Daily
AP_WB_BUILD _PROCESS	AP_WB_BUILD _D_JOB	AP Workbook Build/Refresh Daily Job	AP_WB_BUIL D_D	AP	AP_Daily
AP_WB_BUILD _PROCESS	AP_WB_BUILD _W_JOB	AP Workbook Build/Refresh Weekly Job	AP_WB_BUIL D_W	AP	AP_Weekly
AP_WB_BUILD _PROCESS	AP_WB_BUILD _END_JOB	AP Workbook Build/Refresh End Job	no_op	AP	AP_Daily
AP_STATS_PR OCESS	AP_STATS_ST ART_JOB	AP Stats Start Job	no_op	AP	AP_Daily
AP_STATS_PR OCESS	AP_STATS_OF FER_W_JOB	AP Stats Offer Metrics Job	AP_STATS_OF FER_W	AP	AP_Weekly
AP_STATS_PR OCESS	AP_STATS_EN D_JOB	AP Stats End Job	no_op	AP	AP_Daily
AP_ADHOC_0 1_PROCESS	AP_ADHOC_0 1_JOB	AP Adhoc 01 Job	#SysOpt.APA d hoc01	AP	AP_Adhoc
AP_ADHOC_0 2_PROCESS	AP_ADHOC_0 2_JOB	AP Adhoc 02 Job	#SysOpt.APA d hoc02	AP	AP_Adhoc
AP_ADHOC_0 3_PROCESS	AP_ADHOC_0 3_JOB	AP Adhoc 03 Job	#SysOpt.APA d hoc03	AP	AP_Adhoc
AP_ADHOC_0 4_PROCESS	AP_ADHOC_0 4_JOB	AP Adhoc 04 Job	#SysOpt.APA d hoc04	AP	AP_Adhoc
AP_ADHOC_0 5_PROCESS	AP_ADHOC_0 5_JOB	AP Adhoc 05 Job	#SysOpt.APA d hoc05	AP	AP_Adhoc
AP_ADHOC_0 6_PROCESS	AP_ADHOC_0 6_JOB	AP Adhoc 06 Job	#SysOpt.APA d hoc06	AP	AP_Adhoc
AP_ADHOC_0 7_PROCESS	AP_ADHOC_0 7_JOB	AP Adhoc 07 Job	#SysOpt.APA d hoc07	AP	AP_Adhoc
AP_ADHOC_0 8_PROCESS	AP_ADHOC_0 8_JOB	AP Adhoc 08 Job	#SysOpt.APA d hoc08	AP	AP_Adhoc
AP_ADHOC_0 9_PROCESS	AP_ADHOC_0 9_JOB	AP Adhoc 09 Job	#SysOpt.APA d hoc09	AP	AP_Adhoc
AP_ADHOC_1 0_PROCESS	AP_ADHOC_1 0_JOB	AP Adhoc 10 Job	#SysOpt.APA d hoc10	AP	AP_Adhoc

Table 8-1 (Cont.) RPASCE Batch Schedule Jobs and Processes

Process Name	Job Name	Description	Batch Control Set	Application	Module
IPO_INIT_EXP_PROCESS	IPO_INIT_EXP_START_JOB	IPO Initial Exports Start Job	no_op	IPO	IPO_Daily
IPO_INIT_EXP_PROCESS	IPO_INIT_EXP_RDX_D_JOB	IPO Initial Exports to RDX Daily Job	IPO_INIT_EXP_RDX_D	IPO	IPO_Daily
IPO_INIT_EXP_PROCESS	IPO_INIT_EXP_OBS_D_JOB	IPO Initial Exports to Files Daily Job	IPO_INIT_EXP_OBS_D	IPO	IPO_Daily
IPO_INIT_EXP_PROCESS	IPO_INIT_EXP_RDX_W_JOB	IPO Initial Exports to RDX Weekly Job	IPO_INIT_EXP_RDX_W	IPO	IPO_Weekly
IPO_INIT_EXP_PROCESS	IPO_INIT_EXP_OBS_W_JOB	IPO Initial Exports to Files Weekly Job	IPO_INIT_EXP_OBS_W	IPO	IPO_Weekly
IPO_INIT_EXP_PROCESS	IPO_INIT_EXP_END_JOB	IPO Initial Exports End Job	no_op	IPO	IPO_Daily
IPO_COM_HIER_IMPORT_PROCESS	IPO_COM_HIER_IMPORT_START_JOB	IPO Common Hierarchy Imports Start Job	no_op	IPO	IPO_Daily
IPO_COM_HIER_IMPORT_PROCESS	IPO_COM_HIER_IMPORT_RDX_D_JOB	IPO Common Hierarchy Imports from RDX Daily Job	IPO_COM_HIER_IMPORT_RDX_D	IPO	IPO_Daily
IPO_COM_HIER_IMPORT_PROCESS	IPO_COM_HIER_IMPORT_OBS_D_JOB	IPO Common Hierarchy Imports from Files Daily Job	IPO_COM_HIER_IMPORT_OBS_D	IPO	IPO_Daily
IPO_COM_HIER_IMPORT_PROCESS	IPO_COM_HIER_IMPORT_RDX_W_JOB	IPO Common Hierarchy Imports from RDX Weekly Job	IPO_COM_HIER_IMPORT_RDX_W	IPO	IPO_Weekly
IPO_COM_HIER_IMPORT_PROCESS	IPO_COM_HIER_IMPORT_OBS_W_JOB	IPO Common Hierarchy Imports from Files Weekly Job	IPO_COM_HIER_IMPORT_OBS_W	IPO	IPO_Weekly
IPO_COM_HIER_IMPORT_PROCESS	IPO_COM_HIER_IMPORT_END_JOB	IPO Common Hierarchy Imports End Job	no_op	IPO	IPO_Daily
IPO_COM_HIER_IMPORT_PROCESS	IPO_COM_DATA_IMPORT_START_JOB	IPO Common Data Imports Start Job	no_op	IPO	IPO_Daily

Table 8-1 (Cont.) RPASCE Batch Schedule Jobs and Processes

Process Name	Job Name	Description	Batch Control Set	Application	Module
IPO_COM_HIER_IMP_PROCESS	IPO_COM_DATA_IMP_RDX_D_JOB	IPO Common Data Imports from RDX Daily Job	IPO_COM_DATA_IMP_RDX_D	IPO	IPO_Daily
IPO_COM_HIER_IMP_PROCESS	IPO_COM_DATA_IMP_OBS_D_JOB	IPO Common Data Imports from Files Daily Job	IPO_COM_DATA_IMP_OBS_D	IPO	IPO_Daily
IPO_COM_HIER_IMP_PROCESS	IPO_COM_DATA_IMP_RDX_W_JOB	IPO Common Data Imports from RDX Weekly Job	IPO_COM_DATA_IMP_RDX_W	IPO	IPO_Weekly
IPO_COM_HIER_IMP_PROCESS	IPO_COM_DATA_IMP_OBS_W_JOB	IPO Common Data Imports from Files Weekly Job	IPO_COM_DATA_IMP_OBS_W	IPO	IPO_Weekly
IPO_COM_HIER_IMP_PROCESS	IPO_COM_DATA_IMP_END_JOB	IPO Common Data Imports End Job	no_op	IPO	IPO_Daily
IPO_HIER_IMP_PROCESS	IPO_HIER_IMP_START_JOB	IPO Hierarchy Imports Start Job	no_op	IPO	IPO_Daily
IPO_HIER_IMP_PROCESS	IPO_HIER_IMP_RDX_D_JOB	IPO Hierarchy Imports from RDX Daily Job	IPO_HIER_IMPORT_RDX_D	IPO	IPO_Daily
IPO_HIER_IMP_PROCESS	IPO_HIER_IMP_OBS_D_JOB	IPO Hierarchy Imports from Files Daily Job	IPO_HIER_IMPORT_OBS_D	IPO	IPO_Daily
IPO_HIER_IMP_PROCESS	IPO_HIER_IMP_RDX_W_JOB	IPO Hierarchy Imports from RDX Weekly Job	IPO_HIER_IMPORT_RDX_W	IPO	IPO_Weekly
IPO_HIER_IMP_PROCESS	IPO_HIER_IMP_OBS_W_JOB	IPO Hierarchy Imports from Files Weekly Job	IPO_HIER_IMPORT_OBS_W	IPO	IPO_Weekly
IPO_HIER_IMP_PROCESS	IPO_HIER_IMP_END_JOB	IPO Hierarchy Imports End Job	no_op	IPO	IPO_Daily
IPO_PRE_DATA_IMP_PROCESS	IPO_PRE_DATA_IMP_START_JOB	IPO Pre Data Imports Start Job	no_op	IPO	IPO_Daily
IPO_PRE_DATA_IMP_PROCESS	IPO_PRE_DATA_IMP_RDX_D_JOB	IPO Pre Data Imports from RDX Daily Job	IPO_PRE_DATA_IMP_RDX_D	IPO	IPO_Daily
IPO_PRE_DATA_IMP_PROCESS	IPO_PRE_DATA_IMP_OBS_D_JOB	IPO Pre Data Imports from Files Daily Job	IPO_PRE_DATA_IMP_OBS_D	IPO	IPO_Daily

Table 8-1 (Cont.) RPASCE Batch Schedule Jobs and Processes

Process Name	Job Name	Description	Batch Control Set	Application	Module
IPO_PRE_DAT A_IMP_PROCE SS	IPO_PRE_DAT A_IMP_RDX_ W_JOB	IPO Pre Data Imports from RDX Weekly Job	IPO_PRE_DAT A_IMP_RDX_ W	IPO	IPO_Weekly
IPO_PRE_DAT A_IMP_PROCE SS	IPO_PRE_DAT A_IMP_OBS_ W_JOB	IPO Pre Data Imports from Files Weekly Job	IPO_PRE_DAT A_IMP_OBS_ W	IPO	IPO_Weekly
IPO_PRE_DAT A_IMP_PROCE SS	IPO_PRE_DAT A_IMP_END_J OB	IPO Pre Data Imports End Job	no_op	IPO	IPO_Daily
IPO_PRE_BAT CH_PROCESS	IPO_PRE_BAT CH_START_JO B	IPO Pre Batch Calculations Start Job	no_op	IPO	IPO_Daily
IPO_PRE_BAT CH_PROCESS	IPO_PRE_BAT CH_D_JOB	IPO Pre Batch Calculations Daily Job	IPO_PRE_BAT CH_D	IPO	IPO_Daily
IPO_PRE_BAT CH_PROCESS	IPO_PRE_BAT CH_W_JOB	IPO Pre Batch Calculations Weekly Job	IPO_PRE_BAT CH_W	IPO	IPO_Weekly
IPO_PRE_BAT CH_PROCESS	IPO_PRE_BAT CH_END_JOB	IPO Pre Batch Calculations End Job	no_op	IPO	IPO_Daily
IPO_PRE_EXP _PROCESS	IPO_PRE_EXP _START_JOB	IPO Pre Exports Start Job	no_op	IPO	IPO_Daily
IPO_PRE_EXP _PROCESS	IPO_PRE_EXP _RDX_D_JOB	IPO Pre Exports to RDX Daily Job	IPO_PRE_EXP _RDX_D	IPO	IPO_Daily
IPO_PRE_EXP _PROCESS	IPO_PRE_EXP _OBS_D_JOB	IPO Pre Exports to Files Daily Job	IPO_PRE_EXP _OBS_D	IPO	IPO_Daily
IPO_PRE_EXP _PROCESS	IPO_PRE_EXP _RDX_W_JOB	IPO Pre Exports to RDX Weekly Job	IPO_PRE_EXP _RDX_W	IPO	IPO_Weekly
IPO_PRE_EXP _PROCESS	IPO_PRE_EXP _OBS_W_JOB	IPO Pre Exports to Files Weekly Job	IPO_PRE_EXP _OBS_W	IPO	IPO_Weekly
IPO_PRE_EXP _PROCESS	IPO_PRE_EXP _END_JOB	IPO Pre Exports End Job	no_op	IPO	IPO_Daily
IPO_EGRS_EX P_PROCESS	IPO_EGRS_EX P_START_JOB	IPO Egress Exports Start Job	no_op	IPO	IPO_Daily
IPO_EGRS_EX P_PROCESS	IPO_EGRS_EX P_RDX_D_JO B	IPO Egress Exports to RDX Daily Job	IPO_EGRS_E XP_RDX_D	IPO	IPO_Daily
IPO_EGRS_EX P_PROCESS	IPO_EGRS_EX P_RDX_W_JO B	IPO Egress Exports to RDX Weekly Job	IPO_EGRS_E XP_RDX_W	IPO	IPO_Weekly

Table 8-1 (Cont.) RPASCE Batch Schedule Jobs and Processes

Process Name	Job Name	Description	Batch Control Set	Application	Module
IPO_EGRS_EXPORT_PROCESS	IPO_EGRS_EXPORT_JOB	IPO Egress Exports End Job	no_op	IPO	IPO_Daily
IPO_POST_DATA_IMPORT_PROCESS	IPO_POST_DATA_IMPORT_START_JOB	IPO Post Data Imports Start Job	no_op	IPO	IPO_Daily
IPO_POST_DATA_IMPORT_PROCESS	IPO_POST_DATA_IMPORT_RDX_JOB	IPO Post Data Imports from RDX Daily Job	IPO_POST_DATA_IMPORT_RDX_D	IPO	IPO_Daily
IPO_POST_DATA_IMPORT_PROCESS	IPO_POST_DATA_IMPORT_OBS_JOB	IPO Post Data Imports from Files Daily Job	IPO_POST_DATA_IMPORT_OBS_D	IPO	IPO_Daily
IPO_POST_DATA_IMPORT_PROCESS	IPO_POST_DATA_IMPORT_RDX_WEEK_JOB	IPO Post Data Imports from RDX Weekly Job	IPO_POST_DATA_IMPORT_RDX_W	IPO	IPO_Weekly
IPO_POST_DATA_IMPORT_PROCESS	IPO_POST_DATA_IMPORT_OBS_WEEK_JOB	IPO Post Data Imports from Files Weekly Job	IPO_POST_DATA_IMPORT_OBS_W	IPO	IPO_Weekly
IPO_POST_DATA_IMPORT_PROCESS	IPO_POST_DATA_IMPORT_END_JOB	IPO Post Data Imports End Job	no_op	IPO	IPO_Daily
IPO_POST_BATCH_PROCESS	IPO_POST_BATCH_START_JOB	IPO Post Batch Calculations Start Job	no_op	IPO	IPO_Daily
IPO_POST_BATCH_PROCESS	IPO_POST_BATCH_D_JOB	IPO Post Batch Calculations Daily Job	IPO_POST_BATCH_D	IPO	IPO_Daily
IPO_POST_BATCH_PROCESS	IPO_POST_BATCH_WEEK_JOB	IPO Post Batch Calculations Weekly Job	IPO_POST_BATCH_WEEK	IPO	IPO_Weekly
IPO_POST_BATCH_PROCESS	IPO_POST_BATCH_END_JOB	IPO Post Batch Calculations End Job	no_op	IPO	IPO_Daily
IPO_LIFECYCLE_BATCH_PROCESS	IPO_LIFECYCLE_BATCH_START_JOB	IPO Lifecycle Batch Start Job	no_op	IPO	IPO_Daily
IPO_LIFECYCLE_BATCH_PROCESS	IPO_LIFECYCLE_BATCH_D_JOB	IPO Lifecycle Batch Daily Job	IPO_LIFECYCLE_BATCH_D	IPO	IPO_Lifecycle_Daily
IPO_LIFECYCLE_BATCH_PROCESS	IPO_LIFECYCLE_BATCH_WEEK_JOB	IPO Lifecycle Batch Weekly Job	IPO_LIFECYCLE_BATCH_WEEK	IPO	IPO_Lifecycle_Weekly
IPO_LIFECYCLE_BATCH_PROCESS	IPO_LIFECYCLE_BATCH_END_JOB	IPO Lifecycle Batch End Job	no_op	IPO	IPO_Daily
IPO_LIFECYCLE_BATCH_ID_1_PROCESS	IPO_LIFECYCLE_BATCH_ID_1_JOB	IPO Lifecycle Batch Intra-Day 1 Job	#SysOpt.ipolntraDay1	IPO	IPO_IntraDay

Table 8-1 (Cont.) RPASCE Batch Schedule Jobs and Processes

Process Name	Job Name	Description	Batch Control Set	Application	Module
IPO_LIFECYCLE_BATCH_ID_2_PROCESS	IPO_LIFECYCLE_BATCH_ID_2_JOB	IPO Lifecycle Batch Intra-Day 2 Job	#SysOpt.ipolntraDay2	IPO	IPO_IntraDay
IPO_POST_EXPORT_PROCESS	IPO_POST_EXPORT_START_JOB	IPO Post Exports Start Job	no_op	IPO	IPO_Daily
IPO_POST_EXPORT_PROCESS	IPO_POST_EXPORT_RDX_D_JOB	IPO Post Exports to RDX Daily Job	IPO_POST_EXPORT_RDX_D	IPO	IPO_Daily
IPO_POST_EXPORT_PROCESS	IPO_POST_EXPORT_OBS_D_JOB	IPO Post Exports to Files Daily Job	IPO_POST_EXPORT_OBS_D	IPO	IPO_Daily
IPO_POST_EXPORT_PROCESS	IPO_POST_EXPORT_RDX_W_JOB	IPO Post Exports to RDX Weekly Job	IPO_POST_EXPORT_RDX_W	IPO	IPO_Weekly
IPO_POST_EXPORT_PROCESS	IPO_POST_EXPORT_OBS_W_JOB	IPO Post Exports to Files Weekly Job	IPO_POST_EXPORT_OBS_W	IPO	IPO_Weekly
IPO_POST_EXPORT_PROCESS	IPO_POST_EXPORT_END_JOB	IPO Post Exports End Job	no_op	IPO	IPO_Daily
IPO_WB_BUILD_PROCESS	IPO_WB_BUILD_START_JOB	IPO Workbook Build/Refresh Start Job	no_op	IPO	IPO_Daily
IPO_WB_BUILD_PROCESS	IPO_WB_BUILD_D_JOB	IPO Workbook Build/Refresh Daily Job	IPO_WB_BUILD_D	IPO	IPO_Daily
IPO_WB_BUILD_PROCESS	IPO_WB_BUILD_W_JOB	IPO Workbook Build/Refresh Weekly Job	IPO_WB_BUILD_W	IPO	IPO_Weekly
IPO_WB_BUILD_PROCESS	IPO_WB_BUILD_END_JOB	IPO Workbook Build/Refresh End Job	no_op	IPO	IPO_Daily
IPO_ADHOC_01_PROCESS	IPO_ADHOC_01_JOB	IPO Adhoc 01 Job	#SysOpt.IPOAdhoc01	IPO	IPO_Adhoc
IPO_ADHOC_02_PROCESS	IPO_ADHOC_02_JOB	IPO Adhoc 02 Job	#SysOpt.IPOAdhoc02	IPO	IPO_Adhoc
IPO_ADHOC_03_PROCESS	IPO_ADHOC_03_JOB	IPO Adhoc 03 Job	#SysOpt.IPOAdhoc03	IPO	IPO_Adhoc
IPO_ADHOC_04_PROCESS	IPO_ADHOC_04_JOB	IPO Adhoc 04 Job	#SysOpt.IPOAdhoc04	IPO	IPO_Adhoc
IPO_ADHOC_05_PROCESS	IPO_ADHOC_05_JOB	IPO Adhoc 05 Job	#SysOpt.IPOAdhoc05	IPO	IPO_Adhoc
IPO_ADHOC_06_PROCESS	IPO_ADHOC_06_JOB	IPO Adhoc 06 Job	#SysOpt.IPOAdhoc06	IPO	IPO_Adhoc
IPO_ADHOC_07_PROCESS	IPO_ADHOC_07_JOB	IPO Adhoc 07 Job	#SysOpt.IPOAdhoc07	IPO	IPO_Adhoc
IPO_ADHOC_08_PROCESS	IPO_ADHOC_08_JOB	IPO Adhoc 08 Job	#SysOpt.IPOAdhoc08	IPO	IPO_Adhoc

Table 8-1 (Cont.) RPASCE Batch Schedule Jobs and Processes

Process Name	Job Name	Description	Batch Control Set	Application	Module
IPO_ADHOC_09_PROCESS	IPO_ADHOC_09_JOB	IPO Adhoc 09 Job	#SysOpt.IPOA dhoc09	IPO	IPO_Adhoc
IPO_ADHOC_10_PROCESS	IPO_ADHOC_10_JOB	IPO Adhoc 10 Job	#SysOpt.IPOA dhoc10	IPO	IPO_Adhoc
RPASCE_POM_VPROCESS	RPASCE_VALIDATION_JOB	RPASCE POM Validation Job	ping	RPASCE	

The modules in the schedule are mapped to MDF modules on Retail Home, as shown in the following table.

Table 8-2 Application/Module to MDF Module Path Mappings

Application	Module	MDF Module Path on Retail Home
MFP	MFP_Daily	/MFPEECS/MFP_Daily
MFP	MFP_Weekly	/MFPEECS/MFP_Weekly
MFP	MFP_Adhoc	/MFPEECS/MFP_Adhoc
AP	AP_Daily	/APCS/AP_Daily
AP	AP_Weekly	/APCS/AP_Weekly
AP	AP_Adhoc	/APCS/AP_Adhoc
IPO	IPO_Daily	/IPOCS/IPO_Daily
IPO	IPO_Weekly	/IPOCS/IPO_Weekly
IPO	IPO_Lifecycle_Daily	/IPOCS/IPO_Lifecycle_Daily
IPO	IPO_Lifecycle_Weekly	/IPOCS/IPO_Lifecycle_Weekly
IPO	IPO_Adhoc	/IPOCS/IPO_Adhoc
IPO	IPO_IntraDay	/IPOCS/IPO_IntraDay

Batch Schedules for Additional Instances of RPASCE Applications

The general RPASCE batch schedule supports only one instance each of the MFP, AP, or IPO applications. If the customer has additional instances of MFP or AP, each instance will have its own batch schedule in POM.

For an additional MFP instance, the name of the schedule is RPASCEMF x , where x is the index number of the application instance code (such as 2 in MFPSCS2). Similarly, for AP, the name of the schedule is RPASCEAP x .

Figure 8-1 Multiple RPASCE Batch Schedules

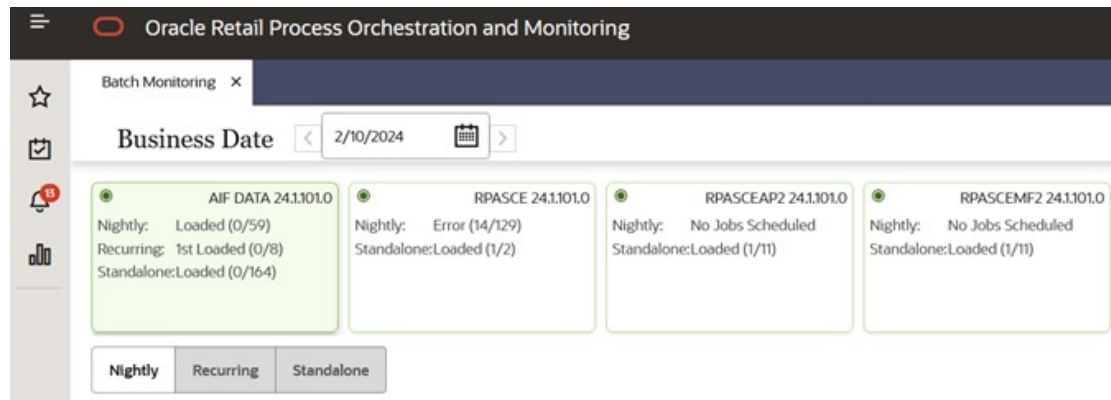

The following table shows the processes and jobs of a single application batch schedule. Note that the prefix PDSXX is replaced with the application instance code during deployment (for example, APCS2).

Process Name	Job Name	Description	Batch Control Set	Application	Module
PDSXX_START_PROCESS	PDSXX_START_JOB	PDSXX Daily Start Job	no_op	PDSXX	PDSXX_Daily
PDSXX_END_PROCESS	PDSXX_END_JOB	PDSXX Daily End Job	no_op	PDSXX	PDSXX_Daily
PDSXX_PRE_EXP_PROCESS	PDSXX_PRE_EXP_START_JOB	PDSXX Pre Exports Start Job	no_op	PDSXX	PDSXX_Daily
PDSXX_PRE_EXP_PROCESS	PDSXX_PRE_EXP_RDX_D_JOB	PDSXX Pre Exports to RDX Daily Job	PDSXX_PRE_EXP_RDX_D	PDSXX	PDSXX_Daily
PDSXX_PRE_EXP_PROCESS	PDSXX_PRE_EXP_OBS_D_JOB	PDSXX Pre Exports to Files Daily Job	PDSXX_PRE_EXP_OBS_D	PDSXX	PDSXX_Daily
PDSXX_PRE_EXP_PROCESS	PDSXX_PRE_EXP_RDX_W_JOB	PDSXX Pre Exports to RDX Weekly Job	PDSXX_PRE_EXP_RDX_W	PDSXX	PDSXX_Weekly
PDSXX_PRE_EXP_PROCESS	PDSXX_PRE_EXP_OBS_W_JOB	PDSXX Pre Exports to Files Weekly Job	PDSXX_PRE_EXP_OBS_W	PDSXX	PDSXX_Weekly
PDSXX_PRE_EXP_PROCESS	PDSXX_PRE_EXP_END_JOB	PDSXX Pre Exports End Job	no_op	PDSXX	PDSXX_Daily
PDSXX_HIER_IMP_PROCESS	PDSXX_HIER_IMP_START_JOB	PDSXX Hierarchy Imports Start Job	no_op	PDSXX	PDSXX_Daily
PDSXX_HIER_IMP_PROCESS	PDSXX_HIER_IMP_RDX_D_JOB	PDSXX Hierarchy Imports from RDX Daily Job	PDSXX_HIER_IMP_RDX_D	PDSXX	PDSXX_Daily

Process Name	Job Name	Description	Batch Control Set	Application	Module
PDSXX_HIER_IMP_PROCESSES	PDSXX_HIER_IMP_OBS_DJOB	PDSXX Hierarchy Imports from Files Daily Job	PDSXX_HIER_IMP_OBS_D	PDSXX	PDSXX_Daily
PDSXX_HIER_IMP_PROCESSES	PDSXX_HIER_IMP_RDX_WJOB	PDSXX Hierarchy Imports from RDX Weekly Job	PDSXX_HIER_IMP_RDX_W	PDSXX	PDSXX_Weekly
PDSXX_HIER_IMP_PROCESSES	PDSXX_HIER_IMP_OBS_WJOB	PDSXX Hierarchy Imports from Files Weekly Job	PDSXX_HIER_IMP_OBS_W	PDSXX	PDSXX_Weekly
PDSXX_HIER_IMP_PROCESSES	PDSXX_HIER_IMP_END_JOB	PDSXX Hierarchy Imports End Job	no_op	PDSXX	PDSXX_Daily
PDSXX_PRE_DATA_IMP_PROCESS	PDSXX_PRE_DATA_IMP_START_JOB	PDSXX Pre Data Imports Start Job	no_op	PDSXX	PDSXX_Daily
PDSXX_PRE_DATA_IMP_PROCESS	PDSXX_PRE_DATA_IMP_RDX_DJOB	PDSXX Pre Data Imports from RDX Daily Job	PDSXX_PRE_DATA_IMP_RDX_D	PDSXX	PDSXX_Daily
PDSXX_PRE_DATA_IMP_PROCESS	PDSXX_PRE_DATA_IMP_OBS_DJOB	PDSXX Pre Data Imports from Files Daily Job	PDSXX_PRE_DATA_IMP_OBS_D	PDSXX	PDSXX_Daily
PDSXX_PRE_DATA_IMP_PROCESS	PDSXX_PRE_DATA_IMP_RDX_WJOB	PDSXX Pre Data Imports from RDX Weekly Job	PDSXX_PRE_DATA_IMP_RDX_W	PDSXX	PDSXX_Weekly
PDSXX_PRE_DATA_IMP_PROCESS	PDSXX_PRE_DATA_IMP_OBS_WJOB	PDSXX Pre Data Imports from Files Weekly Job	PDSXX_PRE_DATA_IMP_OBS_W	PDSXX	PDSXX_Weekly
PDSXX_PRE_DATA_IMP_PROCESS	PDSXX_PRE_DATA_IMP_ENDJOB	PDSXX Pre Data Imports End Job	no_op	PDSXX	PDSXX_Daily
PDSXX_BATCH_H_AGG_PROCESS	PDSXX_BATCH_H_AGG_STARTJOB	PDSXX Batch Calculations Start Job	no_op	PDSXX	PDSXX_Daily
PDSXX_BATCH_H_AGG_PROCESS	PDSXX_BATCH_H_AGG_DJOB	PDSXX Batch Calculations Daily Job	PDSXX_BATCH_H_AGG_D	PDSXX	PDSXX_Daily
PDSXX_BATCH_H_AGG_PROCESS	PDSXX_BATCH_H_AGG_WJOB	PDSXX Batch Calculations Weekly Job	PDSXX_BATCH_H_AGG_W	PDSXX	PDSXX_Weekly

Process Name	Job Name	Description	Batch Control Set	Application	Module
PDSXX_BATCH_AGG_PROC ESS	PDSXX_BATCH_AGG_END_ JOB	PDSXX Batch Calculations End Job	no_op	PDSXX	PDSXX_Daily
PDSXX_POST_DATA_IMP_P ROCESS	PDSXX_POST_DATA_IMP_ST ART_JOB	PDSXX Post Data Imports Start Job	no_op	PDSXX	PDSXX_Daily
PDSXX_POST_DATA_IMP_P ROCESS	PDSXX_POST_DATA_IMP_R DX_D_JOB	PDSXX Post Data Imports from RDX Daily Job	PDSXX_POST_DATA_IMP_R DX_D	PDSXX	PDSXX_Daily
PDSXX_POST_DATA_IMP_P ROCESS	PDSXX_POST_DATA_IMP_O BS_D_JOB	PDSXX Post Data Imports from Files Daily Job	PDSXX_POST_DATA_IMP_O BS_D	PDSXX	PDSXX_Daily
PDSXX_POST_DATA_IMP_P ROCESS	PDSXX_POST_DATA_IMP_R DX_W_JOB	PDSXX Post Data Imports from RDX Weekly Job	PDSXX_POST_DATA_IMP_R DX_W	PDSXX	PDSXX_Weekly
PDSXX_POST_DATA_IMP_P ROCESS	PDSXX_POST_DATA_IMP_O BS_W_JOB	PDSXX Post Data Imports from Files Weekly Job	PDSXX_POST_DATA_IMP_O BS_W	PDSXX	PDSXX_Weekly
PDSXX_POST_DATA_IMP_P ROCESS	PDSXX_POST_DATA_IMP_E ND_JOB	PDSXX Post Data Imports End Job	no_op	PDSXX	PDSXX_Daily
PDSXX_POST_EXP_PROCE SS	PDSXX_POST_EXP_START_ JOB	PDSXX Post Exports Start Job	no_op	PDSXX	PDSXX_Daily
PDSXX_POST_EXP_PROCE SS	PDSXX_POST_EXP_RDX_D_ JOB	PDSXX Post Exports to RDX Daily Job	PDSXX_POST_EXP_RDX_D	PDSXX	PDSXX_Daily
PDSXX_POST_EXP_PROCE SS	PDSXX_POST_EXP_OBS_D_ JOB	PDSXX Post Exports to Files Daily Job	PDSXX_POST_EXP_OBS_D	PDSXX	PDSXX_Daily
PDSXX_POST_EXP_PROCE SS	PDSXX_POST_EXP_RDX_W_ JOB	PDSXX Post Exports to RDX Weekly Job	PDSXX_POST_EXP_RDX_W	PDSXX	PDSXX_Weekly
PDSXX_POST_EXP_PROCE SS	PDSXX_POST_EXP_OBS_W_ JOB	PDSXX Post Exports to Files Weekly Job	PDSXX_POST_EXP_OBS_W	PDSXX	PDSXX_Weekly
PDSXX_POST_EXP_PROCE SS	PDSXX_POST_EXP_END_ JOB	PDSXX Post Exports End Job	no_op	PDSXX	PDSXX_Daily
PDSXX_WB_BUILD_ PROC	PDSXX_WB_BUILD_START_ JOB	PDSXX Workbook Build/Refresh Start Job	no_op	PDSXX	PDSXX_Daily

Process Name	Job Name	Description	Batch Control Set	Application	Module
PDSXX_WB_B UILD_PROCES S	PDSXX_WB_B UILD_D_JOB	PDSXX Workbook Build/Refresh Daily Job	PDSXX_WB_B UILD_D	PDSXX	PDSXX_Daily
PDSXX_WB_B UILD_PROCES S	PDSXX_WB_B UILD_W_JOB	PDSXX Workbook Build/Refresh Weekly Job	PDSXX_WB_B UILD_W	PDSXX	PDSXX_Weekl y
PDSXX_WB_B UILD_PROCES S	PDSXX_WB_B UILD_END_JO B	PDSXX Workbook Build/Refresh End Job	no_op	PDSXX	PDSXX_Daily
PDSXX_ADHO C_01_PROCE SS	PDSXX_ADHO C_01_JOB	PDSXX Adhoc 01 Job	#SysOpt.pdsAd hoc01	PDSXX	PDSXX_Adhoc
PDSXX_ADHO C_02_PROCE SS	PDSXX_ADHO C_02_JOB	PDSXX Adhoc 02 Job	#SysOpt.pdsAd hoc02	PDSXX	PDSXX_Adhoc
PDSXX_ADHO C_03_PROCE SS	PDSXX_ADHO C_03_JOB	PDSXX Adhoc 03 Job	#SysOpt.pdsAd hoc03	PDSXX	PDSXX_Adhoc
PDSXX_ADHO C_04_PROCE SS	PDSXX_ADHO C_04_JOB	PDSXX Adhoc 04 Job	#SysOpt.pdsAd hoc04	PDSXX	PDSXX_Adhoc
PDSXX_ADHO C_05_PROCE SS	PDSXX_ADHO C_05_JOB	PDSXX Adhoc 05 Job	#SysOpt.pdsAd hoc05	PDSXX	PDSXX_Adhoc
PDSXX_ADHO C_06_PROCE SS	PDSXX_ADHO C_06_JOB	PDSXX Adhoc 06 Job	#SysOpt.pdsAd hoc06	PDSXX	PDSXX_Adhoc
PDSXX_ADHO C_07_PROCE SS	PDSXX_ADHO C_07_JOB	PDSXX Adhoc 07 Job	#SysOpt.pdsAd hoc07	PDSXX	PDSXX_Adhoc
PDSXX_ADHO C_08_PROCE SS	PDSXX_ADHO C_08_JOB	PDSXX Adhoc 08 Job	#SysOpt.pdsAd hoc08	PDSXX	PDSXX_Adhoc
PDSXX_ADHO C_09_PROCE SS	PDSXX_ADHO C_09_JOB	PDSXX Adhoc 09 Job	#SysOpt.pdsAd hoc09	PDSXX	PDSXX_Adhoc
PDSXX_ADHO C_10_PROCE SS	PDSXX_ADHO C_10_JOB	PDSXX Adhoc 10 Job	#SysOpt.pdsAd hoc10	PDSXX	PDSXX_Adhoc
PDSXX_POM_ VPROCESS	PDSXX_VALID ATION_JOB	PDSXX POM Validation Job	ping	PDSXX	PDSXX_Adhoc

The following modules in the schedule are mapped to the MDF modules on Retail Home after the PDSXX is replaced by the application instance code during deployment, as shown at the lower portion of the following figure.

Application	Module	MDF Module Path on Retail Home
PDSXX	PDSXX Daily	/PDSXX/PDSXX Daily
PDSXX	PDSXX Weekly	/PDSXX/PDSXX Weekly
PDSXX	PDSXX Adhoc	/PDSXX/PDSXX Adhoc

The following figure shows MDF modules from the Customer Modules Management page of Retail Home

Figure 8-2 MDF Modules from Customer Modules Management of Retail Home

The screenshot shows the 'Customer Modules Management' page in the Retail Home interface. The page title is 'RPASINT Modules'. The table below lists various modules categorized by application and type, with columns for Module Code, Module Name, Type, Offer, and Active status.

Module Code	Module Name	Type	Offer	Active
▼ APEECS	Oracle Retail Assortment Planning Cloud Service Advanced Edition	Application	B95639	Yes <input type="checkbox"/>
AP_Adhoc	AP Adhoc Jobs	Module	B95639	Yes <input type="checkbox"/>
AP_Daily	AP Daily Jobs	Module	B95639	Yes <input type="checkbox"/>
AP_Weekly	AP Weekly Jobs	Module	B95639	Yes <input type="checkbox"/>
▼ IPOCS	Oracle Retail Inventory Planning Optimization Cloud Service Advanced Edition	Application	B98182	Yes <input type="checkbox"/>
IPO_Adhoc	IPO Adhoc Jobs	Module	B98182	Yes <input type="checkbox"/>
IPO_Daily	IPO Daily Jobs	Module	B98182	Yes <input type="checkbox"/>
IPO_IntraDay	IPO IntraDay Jobs	Module	B98182	Yes <input type="checkbox"/>
IPO_Lifecycle_Daily	IPO Lifecycle Daily Jobs	Module	B98182	Yes <input type="checkbox"/>
IPO_Lifecycle_Weekly	IPO Lifecycle Weekly Jobs	Module	B98182	Yes <input type="checkbox"/>
IPO_Weekly	IPO Weekly Jobs	Module	B98182	Yes <input type="checkbox"/>
▼ MFPEECS	Oracle Retail Merchandise Financial Planning Cloud Service Advanced Edition	Application	B95654	Yes <input type="checkbox"/>
MFP_Adhoc	MFP Adhoc Jobs	Module	B95654	Yes <input type="checkbox"/>
MFP_Daily	MFP Daily Jobs	Module	B95654	Yes <input type="checkbox"/>
MFP_Weekly	MFP Weekly Jobs	Module	B95654	Yes <input type="checkbox"/>
▼ MFPSCS2	Oracle Retail Merchandise Financial Planning Cloud Service Advanced Edition (MFPSCS2)	Application	B95654_MFPSCS2	Yes <input type="checkbox"/>
MFPSCS2_Adhoc	MFPSCS2 Adhoc Jobs	Module	B95654_MFPSCS2	Yes <input type="checkbox"/>
MFPSCS2_Daily	MFPSCS2 Daily Jobs	Module	B95654_MFPSCS2	Yes <input type="checkbox"/>
MFPSCS2_Weekly	MFPSCS2 Weekly Jobs	Module	B95654_MFPSCS2	Yes <input type="checkbox"/>

POM Batch Monitoring

This and the following sections provide basic information regarding managing RPASCE batch jobs on POM. For more information regarding the POM user interface, refer to the POM online help, which can be reached by using the Help list menu (the question mark icon) on the top right of the window to open the tab for the Application Help.

The POM Batch Monitoring page, shown in [Figure 8-3](#), is the dashboard for the batch process flows and jobs. On the monitor page, each job can be viewed and acted on and the business date can be viewed and modified. The business date is passed to RPASCE as the

value of RPAS_TODAY for batch execution. The Nightly batch include all jobs in the process flow in [Table 8-1](#). The Standalone batch includes only the ad-hoc job.

Figure 8-3 POM Batch Monitoring

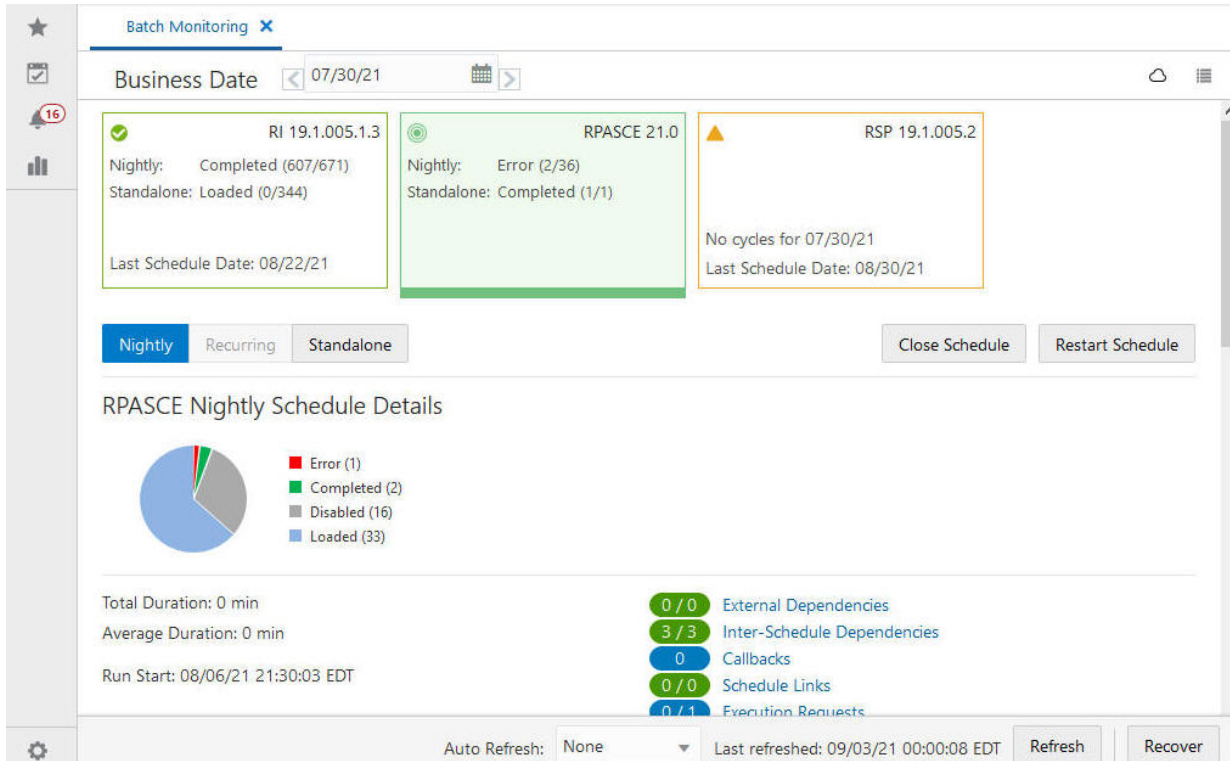

POM System Administration

On the POM System Administration page, shown in [Figure 8-4](#), schedule properties can be modified that include System Options, Settings, Throttling, and Environment.

Figure 8-4 POM System Configuration

The screenshot displays the 'System Configuration' interface with three columns representing different schedules. The 'System' tab is active, and buttons for 'Global Edit' and 'Configure New Schedule' are visible. The left sidebar contains navigation icons for home, checkmarks, notifications (3), and a bar chart.

RI 0.0.0.0	RPASCE 21.0.002	RSP
Business Date: 06/18/21	Business Date: 06/18/21	Business Date: 06/18/21
Last Schedule Update:	Last Schedule Update:	Last Schedule Update:
Settings	Settings	Settings
Data Retention Days: 30	Data Retention Days: 30	Data Retention Days: 30
Long Run Average Time Multiplier: 2	Long Run Average Time Multiplier: 2	Long Run Average Time Multiplier: 2
External Dependencies: Enabled	External Dependencies: Enabled	External Dependencies: Enabled
InterSchedule Dependencies: Enabled	InterSchedule Dependencies: Enabled	InterSchedule Dependencies: Enabled
Throttling	Throttling	Throttling
	Job Agent RPASCE Throttle Limit: 10	
Environment	Environment	Environment
RIPOMAGENT: Unknown	RPASCE: Unknown	RSP: Unknown

The System Options, shown in [Figure 8-5](#), contain some values that are used in the job parameters. The logLevel is used by the server to determine the detail level of the log for the jobs. The values can be error, warning, information, debug, or all, with increasing details. The mfpAdhoc is used by the ad-hoc job as its batch control set name. The System Options variable is referred to as #SysOpt.{name} in the job parameters attribute.

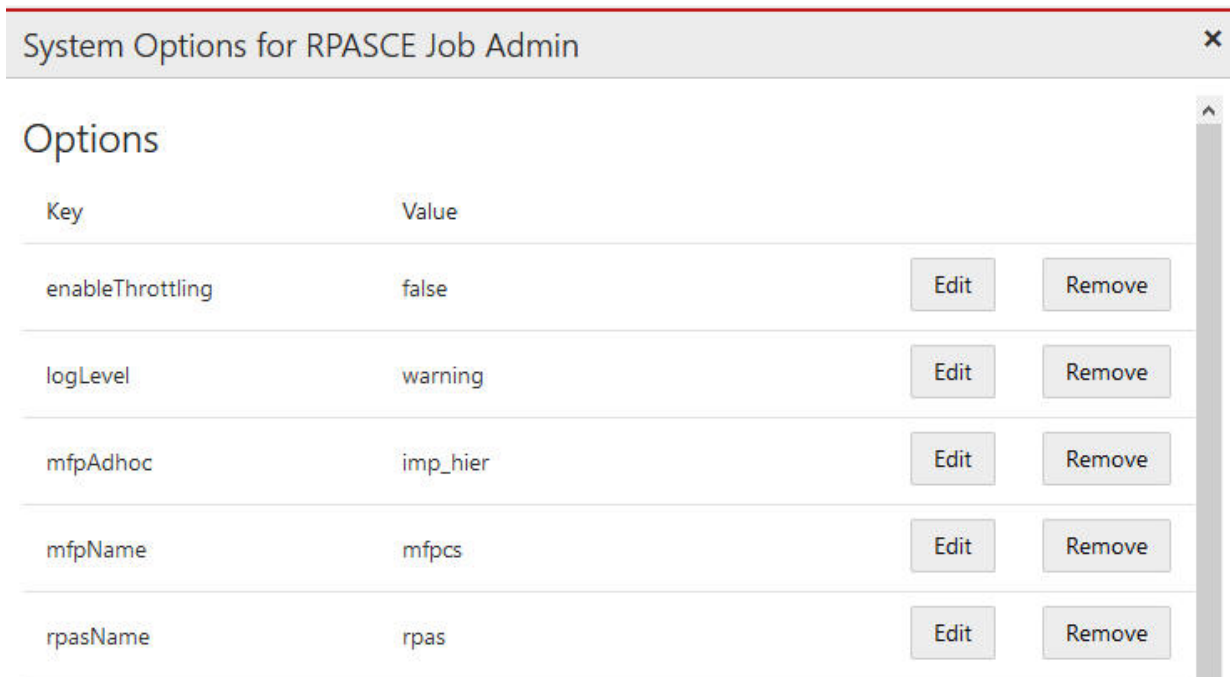
Figure 8-5 POM System Options

Key	Value	Edit	Remove
enableThrottling	false	Edit	Remove
logLevel	warning	Edit	Remove
mfpAdhoc	imp_hier	Edit	Remove
mfpName	mfpcs	Edit	Remove
rpasName	rpas	Edit	Remove

POM Batch Administration

On the POM Batch Administration page, shown in [Figure 8-6](#), each job in the Nightly batch can be enabled/disabled or modified. Clicking on the job brings up a dialog box, shown in [Figure 8-7](#), where dependencies can be modified.

Figure 8-6 POM Batch Administration

Batch Administration ✕

Batch	Nightly	Recurring	Standalone
RI 0.0.0.0	0	0	0
RPASCE 21.0.002	52	0	1
RSP 0.0.0.0	0	0	0

RPASCE Nightly

Actions ▾ View ▾

Filter	Filter	Filter	Filter
Enabled	Job	Process Name	
<input checked="" type="checkbox"/> Yes	MFP_BATCH_AGG_D_JOB	MFP_BATCH_AGG_PROCESS	
<input checked="" type="checkbox"/> Yes	MFP_BATCH_AGG_END_JOB	MFP_BATCH_AGG_PROCESS	
<input checked="" type="checkbox"/> Yes	MFP_BATCH_AGG_START_JOB	MFP_BATCH_AGG_PROCESS	
<input type="checkbox"/> No	MFP_BATCH_AGG_W_JOB	MFP_BATCH_AGG_PROCESS	
<input type="checkbox"/> No	MFP_COM_DATA_IMP_END_JOB	MFP_COM_DATA_IMP_PROCESS	
<input type="checkbox"/> No	MFP_COM_DATA_IMP_OBS_D_JOB	MFP_COM_DATA_IMP_PROCESS	
<input type="checkbox"/> No	MFP_COM_DATA_IMP_OBS_W_JOB	MFP_COM_DATA_IMP_PROCESS	

Figure 8-7 Editing POM Batch Administration Dependencies

×
Edit MFP_BATCH_AGG_D_JOB

Job Type

Enable Job Enabled

Parameters

External Status Update

Skip On Error Disabled

* Threshold Run Time (Sec)

Notes

* Days of the Week

- Sunday
- Monday
- Tuesday
- Wednesday
- Thursday
- Friday
- Saturday

In the Edit dialog box, the parameters consist of name and value pairs separated by double vertical bars in the following format:

```
solution=#SysOpt.mfpName||batchid=MFP_BATCH_AGG_D||loglevel=#SysOpt.logLevel||
rpastoday=#JobCtxt.businessDate
```

The #SysOpt values come from the System Options of the schedule, which can be modified from the System Configuration page. It is not recommended to modify the parameters on the Edit page. Instead, the System Options value must be changed.

An additional parameter, exclusive, can be added to the ad-hoc job. By default, all RPASCE jobs submitted by POM are executed in exclusive mode; that is, online users cannot access the application while the batch jobs are running. If the exclusive parameter is set to 0, online users are allowed to access the application during job execution. Use this parameter cautiously to avoid any side effects.

```
solution=#SysOpt.mfpName||batchid=#SysOpt.mfpAdhoc||loglevel=#SysOpt.logLevel||
rpastoday=#JobCtxt.businessDate||exclusive=0
```

The Days of the Week check boxes are used to enable the job on the checked day. For example, for a weekly job, only Saturday is checked.

Controlling POM Batch Execution Using Retail Home Customer Module Management

RPASCE Cloud Services provide support for Customer Module Management through Retail Home. Customer Module Management provides a mechanism for customers to see which services they are subscribed to and provides a framework to manage enabling and disabling optional modules for those services.

Figure 8-8 Customer Module Management Page of Retail Home

Module Code	Module Name	Type	Offer	Active
MFPECS	Oracle Retail Merchandise Financial Planning Cloud Service Advanced Edition	Application	B95654	Yes <input type="checkbox"/>
MFP_Adhoc	MFP Adhoc Jobs	Module	B95654	Yes <input checked="" type="checkbox"/>
MFP_Daily	MFP Daily Jobs	Module	B95654	No <input type="checkbox"/>
MFP_Weekly	MFP Weekly Jobs	Module	B95654	No <input type="checkbox"/>
Oam	Process Orchestration and Monitoring	Application	POM_OFFER	Yes <input type="checkbox"/>
RASO	Oracle Retail Assortment and Space Optimization Cloud Service	Application	B95653	Yes <input type="checkbox"/>
RH	Retail Home	Application	RH_OFFER	Yes <input type="checkbox"/>
RIO	Oracle Retail Inventory Optimization	Application	B95641	Yes <input type="checkbox"/>

The RPASCE application defines three modules for every subscription. These three modules - Daily, Weekly, and Ad Hoc - correspond to the three modules used for specifying POM batch schedules, as described above. Customers who wish to disable the batch jobs defined for one or all of these modules can do so by disabling the module within the Customer Module Management screen of Retail Home.

This can be valuable in cases where a customer wants to avoid running any POM batch activities for a given subscription. For example, a customer who had purchased multiple subscriptions but who is implementing the subscriptions in a phased manner can disable the modules for all RPASCE applications except the initial implementation. When the implementation of the next application begins, the POM batch schedules for that application can then be enabled, and so on.

In order for the changes made through enabling or disabling modules within the Customer Module Management screen to be applied to POM batch schedules, customers must access the POM Batch Administration task and perform the Sync with MDF operation. This will cause POM to query Retail Home for an up-to-date list of modules that are and are not enabled and enable and disable the POM schedules to reflect the status of the enabled modules.

Figure 8-9 POM Batch Administration Screen with Sync with MDF Action

The screenshot displays the 'Batch Administration' interface. At the top, three batch configurations are shown:

- RPASCE 23.1.101.0**: Nightly: 177, Recurring: 0, Standalone: 30
- RSP 22.2.401.0**: Nightly: 883, Recurring: 2184, Standalone: 161
- RI 22.2.401.0.2**: Nightly: 1486, Recurring: 1956, Standalone: 962

Below these, the 'RPASCE Nightly' batch is selected, showing 177 Nightly, 0 Recurring, and 30 Standalone jobs. The interface includes buttons for 'Sync with MDF', 'Export Config', and 'Import Config'. A table of jobs is displayed below:

Enabled	Job	Process Name	Application	Module	Parameters
<input type="radio"/>	AP_BATCH_AGG_O_JOB	AP_BATCH_AGG_PROCESS	AP	AP_Daily	solution=#SysOpt.apName@batchid=AP_BATCH_AGG_O_JOB
<input type="radio"/>	AP_BATCH_AGG_END_JOB	AP_BATCH_AGG_PROCESS	AP	AP_Daily	solution=#SysOpt.apName@batchid=no_op
<input type="radio"/>	AP_BATCH_AGG_START_JOB	AP_BATCH_AGG_PROCESS	AP	AP_Daily	solution=#SysOpt.apName@batchid=no_op
<input type="radio"/>	AP_BATCH_AGG_W_JOB	AP_BATCH_AGG_PROCESS	AP	AP_Weekly	solution=#SysOpt.apName@batchid=AP_BATCH_AGG_W_JOB
<input type="radio"/>	AP_COM_DATA_IMP_END_JOB	AP_COM_DATA_IMP_PROCESS	AP	AP_Daily	solution=#SysOpt.apName@batchid=no_op

For more information on using the Retail Home Customer Module Management screen, see the chapter "Customer Module Management" of the *Oracle Retail Home Administration Guide*. For more information on working with POM batch schedules see the "Batch Administration" section of the chapter "Process Orchestration and Monitoring" of the *Oracle Retail Process Orchestration and Monitoring User Guide*.

POM Batch Scheduling

The batch scheduling is done through the Scheduler Administration page. The Nightly batch, shown in [Figure 8-10](#), is run every day, and only the start time can be scheduled. The Standalone batch, shown in [Figure 8-11](#), has more scheduling flexibility, and it is used to schedule the ad-hoc jobs. Both frequency and start time can be specified.

Figure 8-10 POM Nightly Batch

The screenshot shows the Scheduler Administration interface. At the top, there are three summary cards for different flows: RI 0.0.0.0, RPASCE 21.0.002, and RSP 0.0.0.0. The RPASCE 21.0.002 card is highlighted in blue. Below these cards are three tabs: 'Nightly (1)', 'Recurring (0)', and 'Standalone (1)'. The 'Nightly (1)' tab is selected. The main section is titled 'RPASCE Nightly Scheduler Task'. It includes a toolbar with 'Actions', 'View', a refresh icon, a dropdown menu, and a 'Detach' button. Below the toolbar is a table with the following data:

Enabled	Flow Name	Schedule Time	Time Zone
<input checked="" type="checkbox"/> Yes	Nightly	12:00 AM	UTC

Figure 8-11 POM Standalone Batch

The screenshot shows the Scheduler Administration interface. At the top, there are three summary cards for different flows: RI 0.0.0.0, RPASCE 21.0.002, and RSP 0.0.0.0. The RPASCE 21.0.002 card is highlighted in blue. Below these cards are three tabs: 'Nightly (1)', 'Recurring (0)', and 'Standalone (1)'. The 'Standalone (1)' tab is selected. The main section is titled 'RPASCE Adhoc Scheduler Tasks'. It includes a toolbar with 'Actions', 'View', a plus icon, a refresh icon, a dropdown menu, and a 'Detach' button. Below the toolbar is a table with the following data:

Enabled	Process Name	Descripti	Frequency	Limit occurrences	Prevent start during nightlv	Schedule Time
<input checked="" type="checkbox"/> Yes	MFP_ADHOC_PR...		Every 30 minutes	10	<input checked="" type="checkbox"/>	09:00 A

Batch Integration through Restful Endpoints

In addition to the scheduling capability from the UI, POM also provides restful endpoints for end-to-end integration. These web service endpoints can be used in a script or invoked manually. For manual operation, it is recommended to use a Chrome extension for HTTP request, such as Advanced REST client, to submit the request to start the nightly schedule or an ad-hoc process. All POM endpoints are protected by the OAuth authorization protocol. To invoke an endpoint in POM, a customer application must use an Access Token that was generated using the OAuth Client Credentials Grant.

Refer to *Retail Process Orchestration and Monitoring Implementation Guide* for further details.

Execution Request Creation

The specification of the ReST service to start the POM cycle execution is shown here:

HTTP Method	POST
Path	<p>http://<pom-server-host>/ProcessServices/services/private/executionEngine/schedules/<Schedule_Name>/execution</p> <p>Note: <pom-server-host> and <Schedule_Name> variables must be changed according to the target environment and schedule. For RPASCE applications, the schedule name is RPASCE.</p>
HTTP Headers	<p>Content-Type = application/json</p> <p>Authorization = Bearer <<OAuth_Token_FROM_IDCS_or_OCI_IAM>></p>
Request Body	<pre>{ "cycleName": "<Cycle Name>", "flowName": "<Flow Name>", "processName": "<Process Name>", "requestParameters": "<Comma Separated Key Value Pairs>" }</pre> <p>Notes:</p> <ul style="list-style-type: none"> • The processName attribute required only for Ad hoc cycles. • The requestParameters attribute is optional. This is useful if external systems would like to provide custom identifiers to POM and expect them to be returned on callbacks sent from POM.
Response Body	<pre>{ "value": "171" -Execution Request ID, "cycleName": "CycleName", "flowName": "FlowName", "processName": "ProcessName", "jobName": "JobName", "requestType": "requestType", "requestParameters": "<Comma Separated Key Value Pairs>" "executionEngineInfo": "STARTED", "hyperMediaContent": {} }</pre>

Invocation	Request Payload
Nightly Cycle invocation.	<pre data-bbox="641 289 1369 426"> { "cycleName" : "Nightly", "flowName" : "Nightly", "requestParameters" : "callerId=XXX,correlationId=123" } </pre> <p data-bbox="641 457 1450 510">Note: The Nightly Cycle contains a single flow, hence a single invocation will suffice to start the Nightly Flow.</p>
Hourly Cycle invocation. (Currently no hourly cycles are defined for RPASCE schedule)	<pre data-bbox="641 541 1369 678"> { "cycleName" : "Hourly_Cycle_<N>", "flowName" : "<FLOW_NAME>", "requestParameters" : "callerId=XXX,correlationId=456" } </pre> <p data-bbox="641 716 995 741"><N> is the cycle number (1 to 24)</p> <p data-bbox="641 751 1458 804"><FLOW_NAME> is name of the flow (Process Group) to invoke. For example, SALESPROCESS_CYCLE.</p> <pre data-bbox="641 831 1417 968"> { "cycleName" : "Hourly_Cycle_1", "flowName" : "SALESPROCESS_CYCLE", "requestParameters": "callerId=Sys_Name,correlationId=456" } </pre> <p data-bbox="641 999 1458 1052">Note: The Hourly Cycles comprise of many distinct flows, and for each flow a separate invocation is required.</p>

Invocation	Request Payload
Ad hoc Cycle invocation. In case of Adhoc processes, the parameters for Jobs can be overridden by parameters specified as part of the invocation request.	<pre>{ "cycleName" : "Adhoc", "flowName" : "Adhoc", "processName" : "<ADHOC_PROCESS_NAME>", "requestParameters" : "callerId=xxx,correlationId=789" }</pre> <p>Example:</p> <pre>{ "cycleName": "Adhoc", "flowName": "Adhoc", "processName": "MFP_ADHOC_01_PROCESS", "requestParameters": "callerId=Ext_System_Name, correlationId= 789" }</pre> <p>Example with overriding job parameters:</p> <pre>{ "cycleName": "Adhoc", "flowName": "Adhoc", "processName": "MFP_ADHOC_01_PROCESS", "requestParameters": "callerId=Ext_System_Name, correlationId=789,jobParams.MFP_ADHOC_01_JOB=solution=#SysOpt.mfp Name batchid=export_meas1 loglevel=#SysOpt.logLevel rpastoday=#JobCtxt.businessDate exclusive=0" }</pre> <p>Note: Ad hoc Cycles are composed of many discrete individual Processes. For each Process, a separate invocation is required.</p>

Execution Request Status Tracking

The following endpoints provide the ability to check the status of an execution request in POM:

HTTP Method	GET
Path	<p>http://<pom-server-host>/ProcessServices/services/private/executionEngine/schedules/<scheduleName>/requests/{executionId}</p> <p>Note: Replace <pom-server-host> according to the target environment. <scheduleName>: Name of the schedule. For RPASCE applications, the schedule name is RPASCE. <executionId>: ID of the execution request returned by POM when the execution request was submitted.</p>
HTTP Headers	<p>Content-Type = application/json Authorization = Bearer <<OAuth_Token_FROM_IDCS_or_OCI_IAM>></p>

HTTP Method	GET
Response Body	<ul style="list-style-type: none"> executionId - ID of the execution request. scheduleName - Name of the schedule for which this execution request was created. <p>Sample values: RPASCE, MERCH, RDE, and so on.</p> <ul style="list-style-type: none"> cycleName - Name of the Cycle for which this execution request was created. <p>Sample values: Nightly, Hourly, or Adhoc.</p> <ul style="list-style-type: none"> flowName - Name of the Flow for which the execution request was created. <p>Sample Values: For Ad hoc Cycle: Adhoc For Nightly Cycle: Nightly For Hourly Cycle: Name of the flow such as DEAL_PURGE_CYCLE, and so on.</p> <ul style="list-style-type: none"> processName - Name of the Process for which the execution request was created. <p>Sample Values: For Ad hoc: Name of the process such as MFP_ADHOC_01_PROCESS, and so on. For Nightly/Hourly: Always set to ALL.</p> <ul style="list-style-type: none"> requestParameters - Parameters associated with the execution request. status - Status of the execution request. <p>Possible Values:</p> <ul style="list-style-type: none"> QUEUED: Request is queued up for execution. RUNNING: Jobs from this request are being executed. ERROR: One of the jobs in this request has failed. Note that a failed job will be restarted by POM Admin; there is no need to re-submit the execution request. COMPLETED: All jobs from this request have been executed successfully.

Custom Batch Schedule

While the process flow in the generic batch schedule provided by Oracle should cover the most common use cases, customers can upload their own custom batch schedule with their own tailored jobs and process flows. The whole batch schedule is defined in a Microsoft Excel spreadsheet. The generic batch schedule spreadsheet can be obtained from Oracle support and used as the base for further customization. Refer to the Retail Process Orchestration and Monitoring Implementation Guide for instructions on how to define and validate jobs and processes in the spreadsheet. [Table 8-3](#) contains the fields to be filled in for an RPASCE batch job:

Table 8-3 RPASCE Batch Job Fields

Field Name	Value	Note
JobName	Meaningful job name with underscores (for example, MFP_DAILY_JOB)	

Table 8-3 (Cont.) RPASCE Batch Job Fields

Field Name	Value	Note
Description	Description of the job (for example, MFP daily batch job)	
RmsBatch		Leave blank
ScriptFolder		Leave blank
RmsWrapper		Leave blank
ParameterValue	solution=#SysOpt.mfpName batchid={batch_control_set} loglevel=#SysOpt.logLevel rpastoday=#JobCtx.businessDate exclusive=1	The batch control set name must be defined in the batch control file of RPASCE Batch Framework. The parameters are explained in " POM Batch Administration ".
ApplicationName	Must be one of the pre-defined application names in the spreadsheet (for example, MFP)	
Modules	Must be one of the pre-defined module names in the spreadsheet (for example, MFP_Daily)	
FixedParameterInd	Y	
ParameterUpdated	N	
SkipOnError	N	
JobType	RPAS	Fixed value to indicate RPAS web service is used for this job.

After the custom spreadsheet is ready, it can be imported to the Schedule Maintenance page of the POM website, shown in [Figure 8-12](#).

Figure 8-12 POM Schedule Maintenance Page

The screenshot displays the 'Schedule Maintenance' page in a web application. At the top, there are three tabs: 'Batch Monitoring', 'Scheduler Administration', and 'Schedule Maintenance'. The 'Schedule Maintenance' tab is active. On the left sidebar, there are icons for a star, a calendar, a notification bell with '29', and a bar chart. The main content area shows a green box with a checkmark and the text 'RPASCE 19.0.003.02'. Below this is a section titled 'Versions' with an 'Import Latest Schedule' button. A table lists the versions with columns for Upgrade Status, Version, Date Upgraded, and Description. The current version is highlighted in blue. At the bottom, there is an 'Auto Refresh' dropdown set to 'None', a 'Last refreshed' timestamp, and a 'Refresh' button.

Upgrade Status	Version	Date Upgraded	Description
<input checked="" type="radio"/> Current Version	19.0.003.02	10/22/21 11:42:15 EDT	RPASCE Batch Schedule
<input type="radio"/> Past Version	19.0.003.01	10/22/21 09:59:57 EDT	NA
<input type="radio"/> Past Version	19.0.003	06/01/21 07:41:39 EDT	NA

9

Internationalization

Internationalization is the process of creating software that can be translated into different languages more easily. Changes to the code are not specific to any particular market. This chapter describes configuration settings and features of the software that ensure that the base application can handle multiple languages. Oracle Retail applications have been internationalized to support multiple languages.

This chapter contains the following sections:

- [Translation in RPASCE](#)
- [Browser Setup](#)
- [Translation Administration Workspaces](#)
- [Loading Internal Translation Measures](#)
- [Translation Tasks](#)
- [Miscellaneous](#)
- [Taskflow Components Translation](#)

Translation in RPASCE

Translation is the process of interpreting and adapting text from one language into another. Although the code itself is not translated, components of the application that are translated include the following:

- Graphical user interface (GUI)
- Error messages
- Taskflow components

The following components are not translated:

- Documentation (online help, release notes, installation guide, user guide, operations guide)
- Batch programs and messages
- Log files
- Reports
- Demonstration data
- Training materials

The user interface has been translated into the following languages:

Table 9-1 Supported Languages with Language Identifiers

Language	Language Identifier
Chinese (Simplified)	CHINESE_SIMPLIFIED
Chinese (Traditional)	CHINESE_TRADITIONAL
Croatian	CROATIAN
Dutch	DUTCH
English	ENGLISH
English (Australia)	ENGLISH_AU
English (Canada)	ENGLISH_CA
English (Great Britain)	ENGLISH_GB
English (United States)	ENGLISH_US
French	FRENCH
German	GERMAN
Greek	GREEK
Hungarian	HUNGARIAN
Italian	ITALIAN
Japanese	JAPANESE
Korean	KOREAN
Polish	POLISH
Portuguese (Brazilian)	PORTUGUESE
Russian	RUSSIAN
Spanish	SPANISH
Swedish	SWEDISH
Turkish	TURKISH

 **Note:**

The language identifiers mentioned in [Table 9-1](#) are RPASCE position names for the lngs hierarchy. In most cases, they do not match the browser language IDs.

Translation in RPASCE can be handled in the following ways.

- Build the translation-related workspaces, edit translation strings and commit.
- Load the internal translation measures directly using the load Facts Data OAT task.
- Manage translation using Translation Tasks.

**Note:**

The Multi-Language setting in the Configuration Tool properties is now obsolete. Applications are by default multilingual.

Browser Setup

Before translated strings can be viewed in the client, the following steps must be followed to change the Web browser's locale settings to the desired language. If you are using Chrome, go to Settings. The language settings are under the Advanced options.

Figure 9-1 Browser Setup

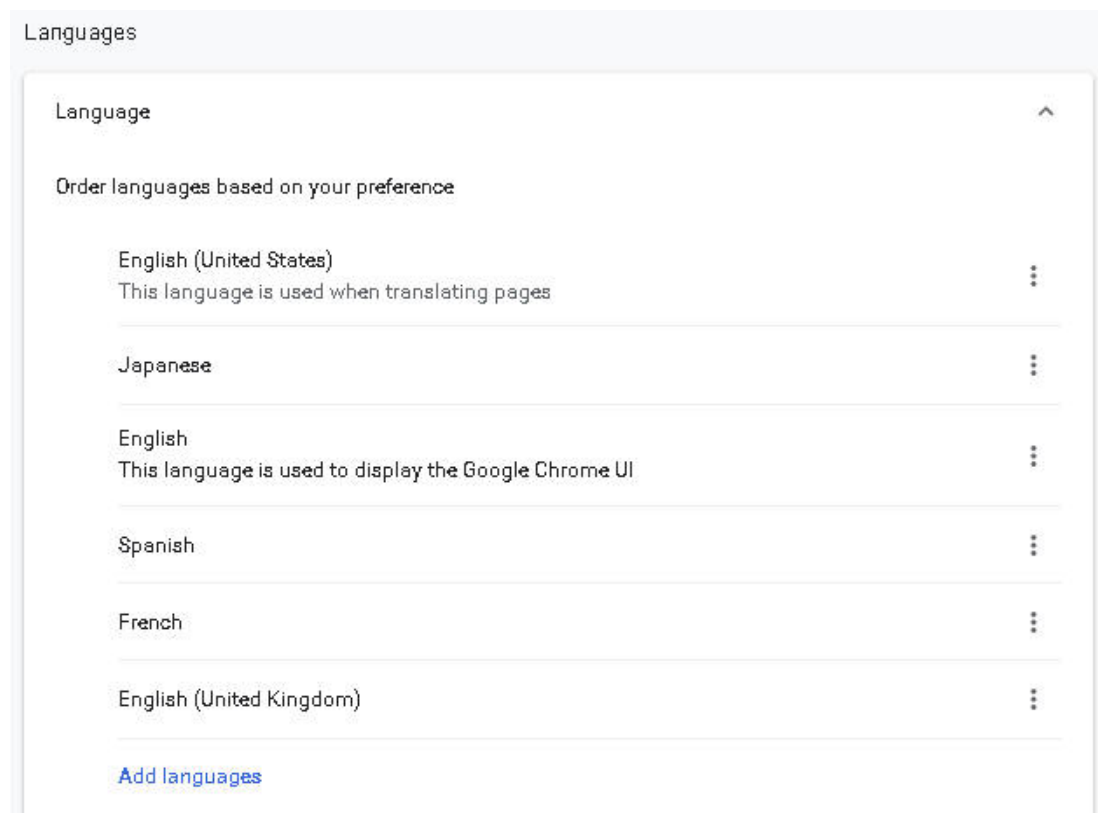

If the language you require is not present, add it using the Add languages option. However, note that only languages in [Table 9-1](#) are supported by RPASCE.

Click the menu next to your language and select Move to the top. Then, select Display Google Chrome in this language.

Figure 9-2 Chrome Setup



If you are using Firefox, go to Settings. Under Language and Appearance, select the button next to Choose your preferred language for displaying pages. Move the language you want to the top.

Figure 9-3 Firefox Setup

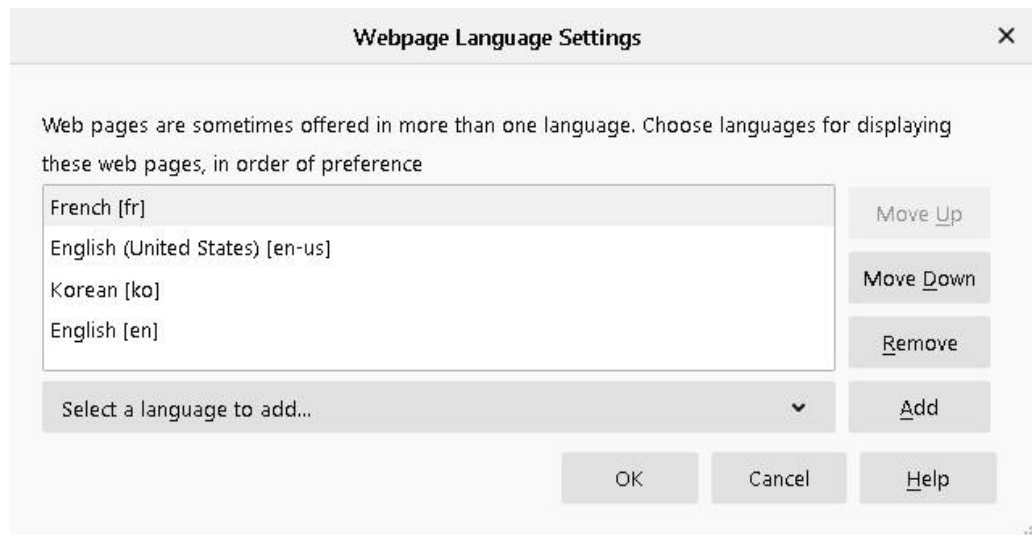

For the updates to take effect, close and then re-open your browser.

Translation Administration Workspaces

Two translation-related workspaces are available. The "[Translation Administration Workspace](#)" is used for all translation changes except position translations. The "[Position Translation Administration Workspace](#)" is used for all position label translation changes.

Note that the translation changes do not take effect until the user commits the relevant workspace.

Figure 9-4 Translation Administration Workspaces

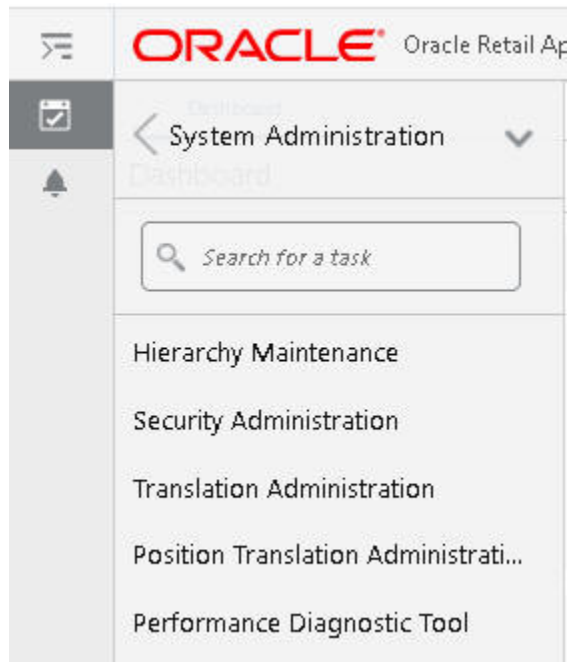

Translation Administration Workspace

The Translation Administration workspace contains views for translating text used in measure labels, workspace template names, template group names, user group labels, and general areas (for example, wizard instructions, and error messages).

No wizard is available for this workspace. Select Translation Administration, as shown in [Figure 9-5](#). You will receive a notification when the workspace has been built and is ready to use.

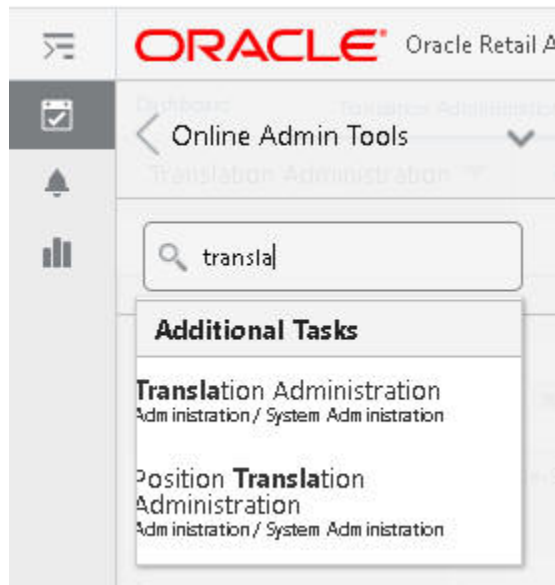
Figure 9-5 Translation Administration

Dimension

The Dimension Labels view allows the user to view and edit the translations of dimension labels.

Hierarchy

The Hierarchy Labels view allows the user to view and edit the translations of hierarchy labels.

Measure

The Measure Translations view allows the user to view and edit the translations of measure labels, measure descriptions, and measure picklists.

Message

Messages contain many different types of translation strings. They consist mainly of the messages that are shown to the user in case of error or for user input. Messages can contain the measure's label override based on the template as well as the translation of a picklist range overridden based on the template. Direct messages are easy to override using this view. For measure overrides, it is best to directly load the translation measure_r_msglabel. Details can be found in [Loading Internal Translation Measures](#)



Note:

RPASCE and solution-specific messages to the user must not be modified. If changes are made to these messages, they may be overwritten when patching occurs

Rule Group

The Rule Group Labels view allows the user to view and edit the translations of rule group labels displayed to users in the RPASCE Client.

Template

The Template Translation view allows the user to view and edit the translations of workbook template names.

Template Group

The Template Group Translations view allows the user to view and edit the translations of template group names.

User Group

The User Group Translations view allows the user to view and edit the translations of user group labels. The list of user groups includes the Administration, Default, and any other user group names set up by the system administrator. For products in the Oracle Retail Predictive Planning Suite, the list of user groups also includes the various planning roles.

Position Translation Administration Workspace

Position labels in a dimension are translatable. However, there are no default translations for the position labels. If translated labels are not loaded, workspaces show position labels from the hierarchy load file.

Search for translation in the taskbar search window and select Position Translation Administration, as shown in [Figure 9-5](#). There is no wizard for this workspace. You will receive a notification when the workspace is built and ready to use.

Building a Position Translation Administration Workspace

To build a position translation administration workspace, complete the following steps.

1. Select the level to be translated, as shown in [Figure 9-6](#).

Figure 9-6 Translation Levels

Position Translation Administration

Please select a dimension.

CLASS
DEPARTMENT
GROUP
SKU
STYLE
STYLE/COLOR
SUBCLASS

2. Further define the level, as shown in [Figure 9-7](#).

Figure 9-7 Define the Translation Level

Position Translation Administration

Available Product Positions

Levels & Positions

DIVISION	View	Search...	Search	Show Selected
<input checked="" type="checkbox"/> Level	<input type="checkbox"/> Label			
<input type="checkbox"/> DIVISION	<input type="checkbox"/> Ceiling Fans			
<input type="checkbox"/> GROUP	<input type="checkbox"/> COOKING APPLIANCES			
<input type="checkbox"/> DEPARTMENT	<input type="checkbox"/> Cordless Tools			
<input checked="" type="checkbox"/> CLASS	<input type="checkbox"/> Fluorescent Fixtures			
	<input type="checkbox"/> IRONS			
	<input type="checkbox"/> Power Tools			
	<input type="checkbox"/> VCR'S			

Cancel Previous Finish

3. In the Position Translation Administration workbook, a different view for each level selected in the wizard is provided. Enter the position label for the language to be translated to and select **Commit**, as shown in [Figure 9-8](#).

Figure 9-8 Position Label for Language

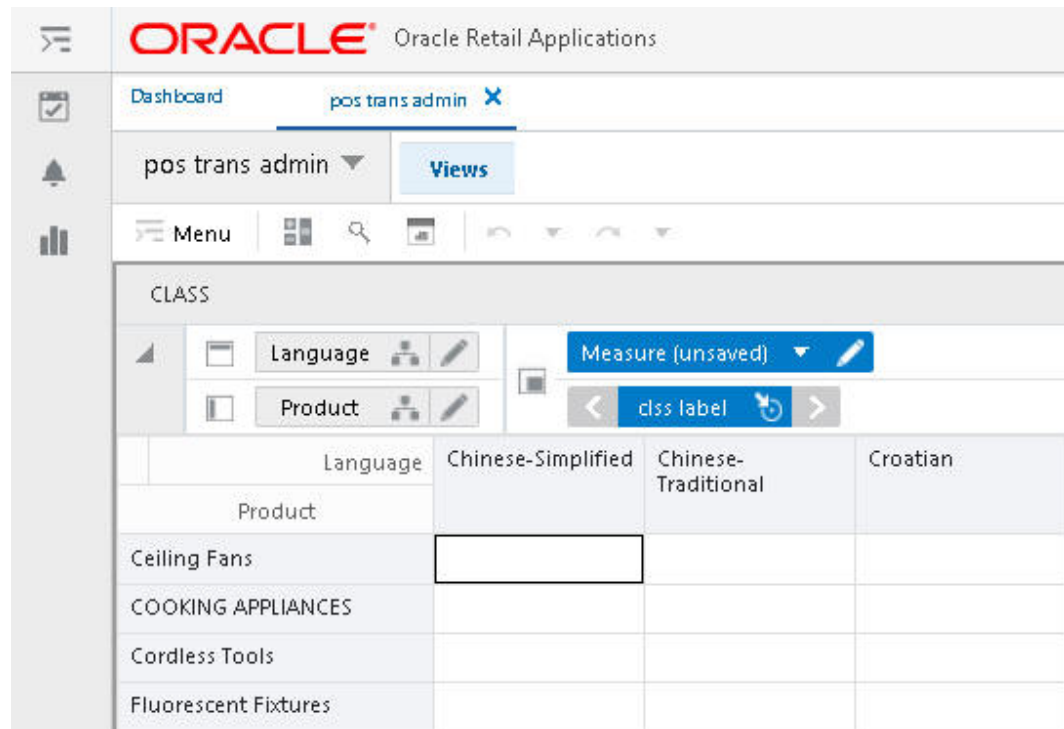

Loading Internal Translation Measures

This section discusses loading the internal measures directly using the Load Fact Data task. (For details, see [Online Administration Tools](#).) It also describes managing translations using the Translation task, which is described in [Translation Tasks](#)

[Table 9-2](#) lists the internal measures corresponding to the type of translation supported by RPASCE.

Table 9-2 Internal Translation Measures

Translation Type	Translation Measure	Base Intersection	Table Name
Level label	r_dimlabel	langdim_	RP_APP_LEVELLABEL_FT
Dimension label	r_hierlabel	langhier	RP_APP_DIMENSIONLABEL_FT
Measure description	r_measdescription	langmeas	RP_APP_MEASLABEL_FT
Measure labels	r_measlabel	langmeas	RP_APP_MEASLABEL_FT
Pick list measure labels	r_measpicklist	langmeas	RP_APP_MEASLABEL_FT
Rule group labels	r_rgrplabel	rgrplang	RP_APP_RGRPLABEL_FT
Template labels	r_wbtlabel	langwbt_	RP_APP_WBTLABEL_FT

Table 9-2 (Cont.) Internal Translation Measures

Translation Type	Translation Measure	Base Intersection	Table Name
Template group labels	r_wbtglabel	langwbtg	RP_APP_WBTGLABEL_FT
User group labels	r_grplabel	langgrp_	RP_APP_GRPLABEL_FT
Internal messages and other strings	r_msglabel	langmsg_	RP_APP_MSGLABEL_FT
Position label	r_<levelName>label	lang<levelName>	e.g: RP_APP_STORLABEL_FT

Example

The following example illustrates how to create the measure input file for internal translation measures.

Assume you are adding translation for the picklist measure. For this, the internal translation measure r_measpicklist must be loaded with the translation strings.

Create a CSV input file r_measpicklist.csv.ovr file with the translations for the picklist measure. Each row is in the format below.

```
<picklistMeasureName>, <languageId> , "value1(value1Label), value2(value2Label),
valueN(valueNLabel) "
```

Here is sample content for a picklist measure named picklist1.

```
picklist1,swedish,"0(Nekad),1(Skrivskyddad),2(Fullständig åtkomst)"
picklist1,turkish,"0(Reddedildi),1(Salt Okunur),2(Tam Erişim)"
picklist1,croatian,"0(Odbijeno),1(Samo za itanje),2(Puni pristup)"
picklist1,dutch,"0(Geweigerd),1(Alleen-lezen),2(Volledige toegang)"
picklist1,french,"0(Refusé),1(Lecture seule),2(Accès complet) "
```

Position Translation

Dimension-specific position translation measures are named as r_<levelName>label, where <levelName> must be replaced with the name of the level from the configuration. For example, if the SKU level positions are to be translated, load the r_skulabel measure with translations. These position translation measures must be loaded after loading the hierarchy because RPASCE can only load translations for already loaded positions.

The position label translation measure files have three columns. The first column contains the position names, the second column contains the language identifier, and the third column contains the translation for the position label in that row.

For example, a translation measure input file for the dept level must be named r_deptlabel.csv.ovr and have the content formatted as follows:

```
2100,english,department
2100,spanish,Departamento
2100,dutch,afdeling
2100,french,département
2100,polish,dziaż
```

Template-Based Override for Measures

It is possible to override a measure label or measure picklist labels based on the template in the configuration. For translating such overridden labels, see the following example.

The internal translation measure that holds the translation is `r_msglabel`. The ID to load the translation is as follows.

For label:

```
measName + '-' + templateName + '-' + l
```

For picklist label:

```
measName + '-' + templateName + '-' + pl
```

Example:

```
meas1-templatel-1,english,test  
meas1-templatel-1,spanish,prueba  
meas1-templatel-1,dutch,toets  
meas1-templatel-1,dutch,testa
```

Translation Tasks

The RPASCE platform and its applications update the default translations in the application as part of the regular upgrade and patch process. If the user has custom translations, such as message strings or measure labels, for any of the default RPASCE strings, these translations may be deleted after a patch or upgrade. To ensure that the custom translations are maintained through patches and upgrades, use the Translations task. Using the OAT task Translation Tasks, a user can upload custom translations to the PDS. Custom translations for both the server and the UI components can be uploaded using this task. This task can be found under the patch task group.

Upload Custom Translations Task

Use this task to upload and apply custom translations. The translations archive file name does not have any special restrictions but must have a `.zip` extension. The translations files in it must be either without a top-level folder or with one folder containing all the files. If there is a top-level folder, the name of the archive must match the folder name. The task looks for input translation archives in the Object Storage location under Translations.

The second page of the upload task provides a drop-down list of all available translation archives. The user can select one and continue. The translation measures files found in the input archive are loaded into the fact tables present in the PDS. The UI translation files are also uploaded to the right location in the PDS. In addition, a copy of all the uploaded translation files is uploaded to the PDS. This helps to list and download just the custom translations.

Here is an example of the translation archive file.

```
$ unzip -l tr.zip tr/  
  
tr/MultiSolutionBundle_de.properties  
tr/MultiSolutionBundle.properties  
tr/MultiSolutionBundle_es.properties
```

```
tr/r_langattr.csv.ovr
tr/MultiSolutionBundle_it.properties
tr/r_measdescripti.csv.ovr
tr/MultiSolutionBundle_en_US.properties
tr/MultiSolutionBundle_pt.properties
tr/r_measlabel.csv.ovr
tr/MultiSolutionBundle_ja.properties
tr/MultiSolutionBundle_en_AU.properties
tr/MultiSolutionBundle_fr.properties
tr/r_dimlabel.csv.ovr
tr/r_grplabel.csv.ovr
tr/r_mslabel.csv.ovr
```

 **Note:**

Be sure to include only translation changes in the input translation archive. For example, if you want to translate only five messages in the `r_mslabel` measure, include only those five in the input file and do not include the full `r_mslabel` exported from the PDS.

Remove Custom Translations Task

This task has the following options:

- **Remove server.** Remove the custom server translations and re-load the default server translations.
- **Remove UI.** Remove the custom UI translations and re-load the default UI translations. The changes will take effect once the UI is restarted.
- **Remove server and UI.** Remove the custom server and UI translations. Re-load the default server translations into the PDS. Re-load the default UI translations. The changes will take effect once the UI is restarted.

The next page of the Remove task provides a check box. Delete the uploaded translations. If this is not checked, the custom server and UI translation files will not be deleted from the PDS. They can be re-applied using the Apply Custom Translation task from the other translations tasks drop-down list. If this option is checked, the custom translations must be uploaded again.

Other Translation Tasks

This task consists of the following subtasks.

Apply Custom Translations Task

If translation files have previously been uploaded using the Upload Custom Translations task, they must now be applied to the PDS using this task. However, the Upload task also applies the translations, and the patch scripts automatically call the Apply task during the application patch process. Therefore, in a regular upgrade and patch scenario, the manual execution of this task is not required. However, this option is exposed through OAT to be used if required. For example, if the Remove Custom Translations task is executed without the Delete Uploaded Translation option, the Apply task can be run in order to re-apply the previously uploaded custom translations.

Download Custom Translations Task

This task exports only the custom translations that are currently in use by the server and UI. The resulting archive file is sent to Object Storage under Planning/Outgoing. The name of the file is in the format CustomTranslations_<timestamp>.zip.

List Custom Translations Task

This task lists the custom translations that are currently in use by the server and UI. To view the output of this task, examine the task log in the OAT dashboard.

Supported Translation Measures

The following translation measures are supported by the Translation task:

- r_msglabel
- r_rgrplabel
- r_wbtlabel
- r_wbtglabel
- r_measpicklist
- r_measlabel
- r_hierlabel
- r_dimlabel
- r_cmsdlabel
- r_grplabel
- r_measdescripti

Miscellaneous

Note the following:

- Rebuild segments to see the updated translations in a segment.
- Use the OAT task Translation Tasks to ensure that the custom translations are not deleted because of a patch or upgrade.
- Virtual hierarchy position labels cannot be loaded differently, compared to the actual hierarchy. As a result, views for virtual hierarchy levels are not included in the translation administration workspace for position label translation.
- The following are translatable for OAT tasks. Search the contents of the translation measure r_msglabel to find the ID of the current string that can be replaced.
 - Administration task list label
 - Administration task label
 - Administration task description
 - Argument branches label
 - Argument label

Taskflow Components Translation

UI-side translations are done using a properties file used in the UI named `MultiSolutionBundle.properties`. This file contains the strings for labels, descriptions, and instructions for Activity Groups, Activities, Tasks, and Steps. This file also contains application information for a multi-solution installation. Additional files can be created that contain strings for translated languages. These files are in the format of `MultiSolutionBundle_XX.properties`, where `XX` is the language code.

Notes

- Decimal digit and separator formatting cannot be configured in the RPASCE Client. It relies on the user's browser locale for this, where the choice of the decimal and digit grouping separator characters is derived from the language specified in the user's browser session.
- Characters with an accent must be represented in Unicode. For example, you must represent "è" as `\u00E9`.
- The displayed label of the profile can be modified by creating or updating the translation entry for the profile label in the `MultiSolution` taskflow bundle for the application. The key to modify is `<solution name>.dashboard.profile.<profile name>`.

For example, for the profile `MFP-IN` in the solution `mfpcss`, the key is `mfpcss.dashboard.profile.MFP-IN`.

10

Resource Bundle Customization

This chapter describes the customization of the resource strings in Retail Home. Resources strings can be edited via the Resource Bundle task.

Editing Resource Strings

This section describes the process for editing resource strings.

Roles

In order to edit the resource strings via the Resource Bundle task of Retail Home, the user must be assigned one of the following roles:

- RETAIL_HOME_ADMIN (or RETAIL_HOME_ADMIN_PREPROD)
- PLATFORM_SERVICES_ADMINISTRATOR

Editing Process

You can edit the resource strings through the Resource Bundle task of Retail Home.

From the Retail Home Settings menu, a Retail Home admin user can access the Resource Text Strings link under the Resource Bundles submenu. Use the Resource Text Strings screen to customize the resources present in the resource bundles of an application. To search the resources in an application, use the Application, Bundle, Language, Resource, Text and Contains Custom Text fields, as shown in [Figure 10-1](#).

Figure 10-1 Search Resource Text Strings

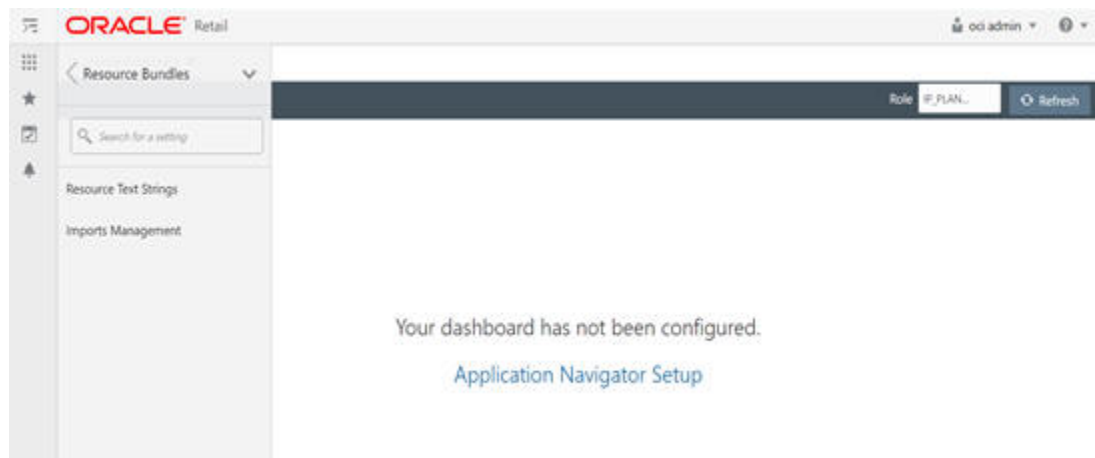

The results table in the Resource Text Strings screen, shown in [Figure 10-2](#), displays the Resource, Base Text, Current Text, Updated Date, and Updated By columns for the

resources matching the entered search criteria. If a custom value is present for a resource, it will be displayed in the Current Text column, along with the date and the user who customized that entry. If no custom value is present for a resource, the Current Text column will display the base text and the Updated Date and Updated By columns will be empty. The user can edit or remove custom text for a resource using this screen.

Figure 10-2 Resource Text String Table

Resource	Base Text	Current Text	Updated Date	Updated By
adminTaskStatus.all	All	All		
adminTaskStatus.allDays	All	All		
adminTaskStatus.allSubmittedBy	All Submitters	All Submitters Names	7/14/21 11:34:30 PM	ociadmin
adminTaskStatus.allTasks	All Task Types	All Task Categories	7/14/21 11:56:36 PM	ociadmin
adminTaskStatus.autoRefresh	Auto-Refresh	Auto-Refresh Progress	7/14/21 11:34:55 PM	ociadmin
adminTaskStatus.completed	Completed	Completed		
adminTaskStatus.errors	Failed	Failed		

The Resource Text String page contains the following search options to search the translation strings.

Application

The unique code associated with a retail application.

Bundles

For any application, three sets of bundles can be customized:

- Translations - These bundles contribute to most of the strings present in the application.
- Oracle.rgbu.ard. resources.rpas.resources.RpasBundle - This bundle contains strings that are mainly seen in the Admin Task Dashboard and Log Levels.
- Oracle.rgbu.ard. resources.rpas.resources.RpasMessages - This bundle has strings that are mainly seen after Dynamic Position Maintenance Imports and errors in the Wizard.

Languages

[Table 10-1](#) lists the languages that are supported.

Table 10-1 Supported Languages

Language	Retail Home Language Code
Arabic	Ar
Deutsch (German)	De
Greek	El
English - United States	En
English - Great Britain	en-GB
Spanish	Es
French	Fr
Croatian	Hr
Hungarian	Hu
Italian	It
Japanese	Ja
Korean	Ko
Dutch	Nl
Polish	Pl
Brazilian Portuguese	pt_BR
Russian	Ru
Swedish	Sv
Turkish	Tr
Chinese - China (Simplified Chinese)	zh_CN
Chinese - Taiwan (Traditional Chinese)	zh_TW

Resource

The unique keys used to identify the resource strings. The most frequently used resource keyword are listed in [Table 10-2](#).

Text

The exact text seen in the labels and snack bar messages in the RPASCE application. The user can search and customize any text that is visible in the UI. For example, the text from any dialog box, snack bar notification, or menu can be selected and copied using the browser copy functionality. The same text can be used for a keyword search to find the string in Retail Home.

In [Figure 10-3](#), the text "Attribute Display Order" has been selected using Copy - Ctrl + C.

Figure 10-3 Example Text Search

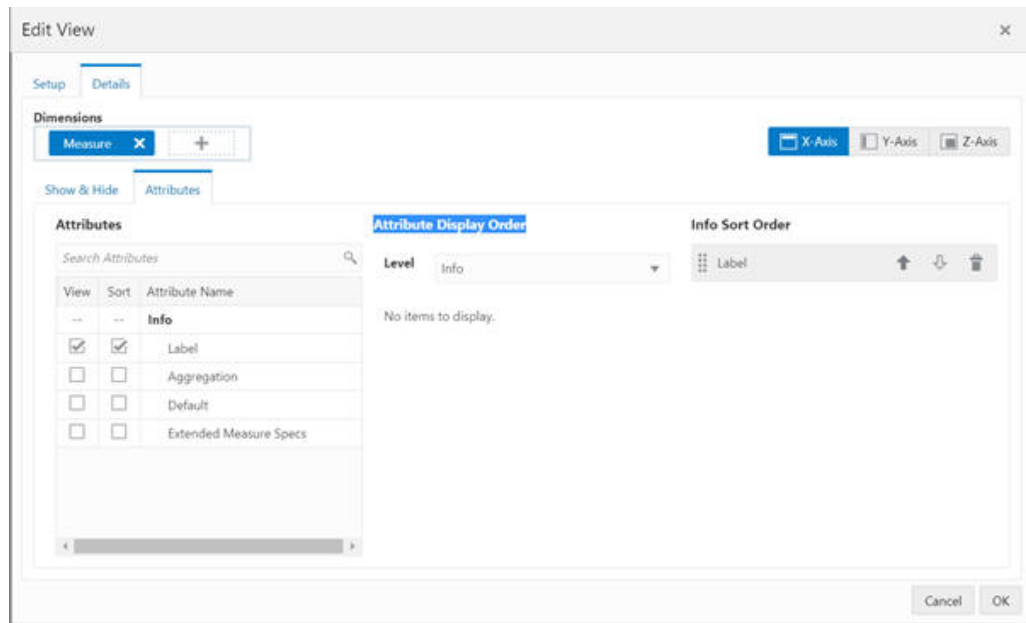
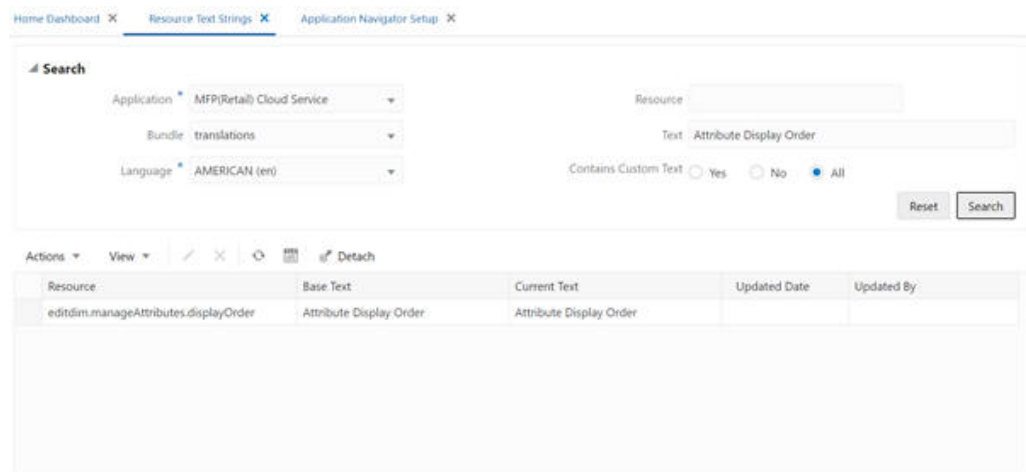

Figure 10-4 shows the same search in Retail Home.

Figure 10-4 Example Text Search in Retail Home



Add or Edit

The user can add or edit the custom text for a resource using the Edit menu or the Pencil icon. If no custom text is present for a resource, new custom text will be added. If custom text is already present for a resource, it will be modified. The Updated Date and Updated By columns will be changed to reflect the addition or modification. The Edit option opens a pop-up that displays the resource, its base text, and the editable custom text, as shown in Figure 10-5. Only one record can be edited at a time in a pop-up.

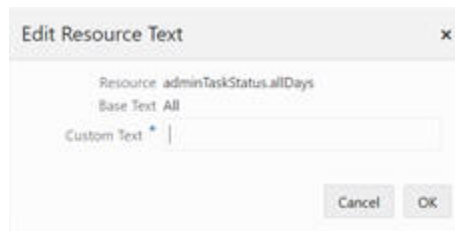
Figure 10-5 Edit Resource Text

Remove Customization

The user can remove the custom text for a selected resource using the Delete menu or the Cross icon. The user can select a single record and remove the custom value for the record. The base text is not impacted by the delete operation. After the delete operation is complete, a snack bar notification is displayed. The user can either undo the delete action or dismiss the notification.

Settings for the RPASCE UI

The Time-to-live (ttl) for application resource bundles on the Additional Settings tab of System Configuration is used to determine the refresh time until the `rpasBundle` and `rpasMessages` custom strings are reflected in the UI. The default value is 600,000 ms.(that is, 10 minutes). With this default value, any changes to `rpasBundle` or `rpasMessages` bundles will take 10 minutes to be reflected in the application. This value can be reduced to a lesser value; however, reducing this value can result in slower performance.

This property is applicable only to `rpasMessages` and `rpasBundle`. Any changes to the translation bundle are implemented immediately. The user does not have to wait to see the custom Translation Bundle strings in the application.

Settings for Retail Home

The resource bundle customization feature must be enabled for the specific application using the Application Administration and Application Navigator Setup Task. The resource bundle customization check box must be checked to enable this feature, as shown in [Figure 10-6](#).

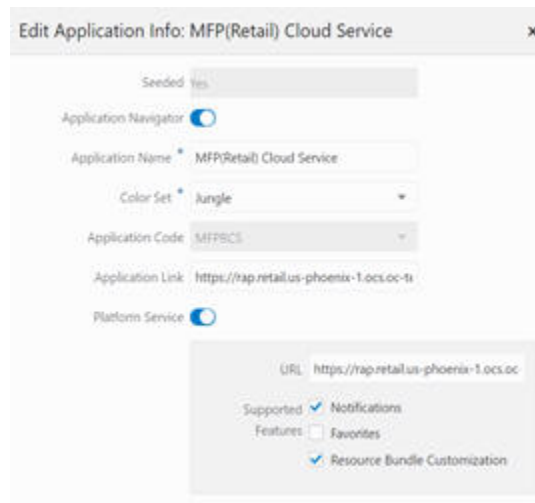
Figure 10-6 Retail Home Settings

Resource Keywords

Table 10-2 list the resource keywords that are most frequently used to search for a group of strings corresponding to a particular feature. These resource keywords belong to the translation bundle.

Table 10-2 Resource Keywords

Resource Keyword	Corresponding Feature
global	Buttons used globally: OK, Cancel, Save, Remove, Delete, Next, Previous, Last, First, and so on.
snackbar	The messages displayed in the snackbar notifications.
session	The labels and messages for session expiration and timeout.
Editview	Labels and messages in the Edit View window.
EditDim	Labels and messages in the Edit Dimension window.
charts	Labels and messages for the charts.
segment	Labels and messages for the segments.
wizardDialog	Labels and messages for the Wizard dialog box.
contextMenu	Labels for context menu options.
preferencetab	Tab names, labels, hints, and messages in the System Configuration.
userPreferences	Labels and messages corresponding to user preferences.
workbook	Menus and labels corresponding to the workbooks.
pivotTable	Menus such as Undo and Redo and messages for features such as Copy/Paste, Lock/Unlock, and so on.
alerts	Labels and messages for the alerts feature.
Dashboard	Labels and messages for the Dashboard.
adminTaskStatus	Labels and messages used in Online Admin Tasks.
positionFiltering	Labels and messages used for Position Filtering.

Table 10-2 (Cont.) Resource Keywords

Resource Keyword	Corresponding Feature
find	Labels in the Find tab.
export	Labels and Messages of export dialog
format	Labels and messages used in the format dialog box.

11

Informational Utilities

This chapter describes informational utilities. It contains the following sections:

Printing Measure Information

The administration task Measure Information is used to print measure information.

Submitting a Measure Information Task

To submit a Measure Information task, complete the following steps:

1. From Administration > Online Admin Tools > Submit a New Admin Task > System Admin Tasks, select Measure Information and click Next.
2. From the list of all available system administration tasks, select **Measure** Information and click **Next**.

Figure 11-1 Measure Information

Submit a New Admin Task

Select A Task From System Admin Tasks Group

Search...

- Enable/Disable Toggleable Features
- Export Hierarchy Data
- Export Measure Data
- Expressions, Rules and Rule Groups Information
- List Users Currently Logged-In
- List/Set/Unset PDS Environment Variable
- Load Interface Mappings
- Manage Dimensions
- Manage Hierarchies
- Manage Informal Positions
- Manage Users
- Manage Workspaces
- Measure Information
- Oracle Support Administration
- Purge Tasks from Task Status Dashboard

3. Enter a descriptive label in the Task Label text box.
Select a log level. Then select one of the following operations:
 - Lists all the Measures. Returns a list of all measures registered in the application.
 - Print the specification of the measure. Returns the list of measure properties.
 - List the information of a measure at its base intersection. Lists the number of dimensions, logical size, populated size, and density of a measure at its base intersection.

Figure 11-2 Measure Information

Submit a New Admin Task

Specify the arguments for task:

Task Label

Measure Information

Log level

Warning

Operations

Lists all the Measures

Print specification of the measure

List the information of a measure at its base intersection

4. Click **Next**. You see Schedule Task, where you can choose to run the task ASAP or on a schedule.

Figure 11-3 Schedule Task

Submit a New Admin Task

Schedule Task

Run ASAP

Run on a schedule

One time

Server Start Date/Time:

12/18/18 02:37 PM

5. Click **Next** to navigate to the next page, where you verify and confirm the task information entered.

Click **Previous** to make changes and click **Finish** to submit the task.

Figure 11-4 Verify Selections

Submit a New Admin Task

Verify and Confirm Before Clicking Finish

Action
Submit An Admin Task

Task
Measure Information (System Admin Tasks)

Description
Display Measure Information

Label
Measure Information

Log level
Warning

Operations
Lists all the Measures

Execute:
Execute Immediate(ASAP)

12

Operational Utilities

This chapter details the following operational utilities of RPASCE:

- [Setting Miscellaneous PDS Properties](#)
- [Setting Date and Time Variables](#)
- [Accessing the Calculation Engine Using mace](#)
- [Managing Segments Using wbbatch](#)
- [Managing Workbooks Using wbmgr](#)

Setting Miscellaneous PDS Properties

This section describes the PDS Property Service task.

Submit Online Admin Task for the PDS Property Service

The PDS Property Utility service is used by the administrator to inspect and reset the properties of a PDS. The supported functions include:

- Display the current value of named PDS properties
- Update the property to the value provided (name=value)

To submit a task for the PDS property utility, complete the following steps:

1. From Administration > Online Administration Tools > Submit an New Admin Task select **System Admin Tasks**, as shown in [Figure 12-1](#), and click **Next**.

Figure 12-1 System Admin Tasks

Submit a New Admin Task

Select Task Group

- Configured Batch Tasks
- PDS Admin Tasks
- System Admin Tasks
- SR Admin Tasks
- Bootstrap Tasks
- Patch Application Task

2. From the list of all available system administration tasks shown in [Figure 12-2](#), select **View and Manage PDS Properties** and click **Next**.

Figure 12-2 PDS Property Utility

Submit a New Admin Task

Select A Task From System Admin Tasks Group



List Users Currently Logged-In
List/Set/Unset PDS Environment Variable
Load Interface Mappings
Manage Dimensions
Manage Hierarchies
Manage Informal Positions
Manage Users
Manage Workspaces
Measure Information
Oracle Support Administration
Purge Tasks from Task Status Dashboard
Rename Positions
Schedule Dashboard Build
Segment/Workspace Batch Operation
View and Manage PDS Properties

3. Enter a descriptive label in the Task Label text box.
Select from the following operations shown in [Figure 12-3](#):
 - [Display the Current Value of the Named PDS Property](#)
 - [Update PDS Property to Value Provided \(name=value\)](#)

Figure 12-3 Select Operation

Submit a New Admin Task

Specify the arguments for task:

Task Label

View and Manage PDS Properties

Operations

Display current value of named pds property

Update pds property to value provided(name=value)

Each available task may also have extra input boxes for the administrator to provide arguments for that task.

Display the Current Value of the Named PDS Property

To display the current value of a particular PDS property, complete the following steps.

1. Once you have entered the task label and selected **Display current value of named PDS property**, you see Schedule Task shown in [Figure 12-4](#), where you can run the task ASAP or on a schedule. If you choose to run on a schedule, you can select a frequency or a specific start and stop date and time.

Figure 12-4 Schedule Task

Submit a New Admin Task

Schedule Task

Run ASAP

Run on a schedule

One time ▼

Server Start Date/Time:

12/17/18 12:57 AM 

2. Click **Next** to navigate to the next page shown in [Figure 12-5](#), where you verify and confirm the task information entered.

Click **Previous** to make changes or **Finish** to submit the task.

Figure 12-5 Verify and Confirm

Submit a New Admin Task

Verify and Confirm Before Clicking Finish

Action
Submit An Admin Task

Task
View and Manage PDS Properties (System Admin Tasks)

Description
Display / Reset / Update Different properties of a PDS

Label
View and Manage PDS Properties

Operations
Display current value of named pds property: domain_type

Execute:
Execute Immediate(ASAP)

3. You see the just-scheduled task in the dashboard shown in [Figure 12-6](#).

Figure 12-6 Status

The screenshot shows a 'Task Status' dashboard. At the top, there are filters for 'All (1)', 'Scheduled (0)', 'In Progress (0)', 'Completed (1)', and 'Failed (0)'. Below the filters, there are controls for 'Last 24 hours', 'oci.admin', and 'All Task Types'. The main area contains a table with the following data:

Description	Status	Task Type	Submitted by	Started/Scheduled	Completed	Record Status
View and Manage PDS Properties	Success	View and Manage PDS Properties	ociadmin	9/3/21 4:31:08 AM	9/3/21 4:31:49 AM	—

4. Select the task and click **Watch Live Log** to view the logs, as shown in [Figure 12-7](#). Alternatively, click **Download Log** to download the log file.

Figure 12-7 PDS Properties Log

Update PDS Property to Value Provided (name=value)

To update the value of a particular PDS property, complete the following steps.

1. Once you have entered the task label, select **Update property to value provided** and type in the name=value expression in the input box right beneath it.
2. Click **Next**. Specify the value type of the property. For the property `navalue_opt`, select boolean or numeric, as shown in [Figure 12-8](#).

Figure 12-8 Property Value Type

The screenshot shows the 'Submit a New Admin Task' form. The title bar reads 'Submit a New Admin Task'. Below the title bar, the form content is as follows:

Specify the arguments for task:

Task Label: Change_NAValue_Opt

Operations: Update pds property to value provided(name=value): navalue_opt=false

Property is numeric

Property is boolean

3. You see Schedule Task as shown in [Figure 12-9](#), where you can run the task ASAP or on a schedule. If you choose to run on a schedule, you can select a frequency or a specific start and stop date and time.

Figure 12-9 Schedule Task

Submit a New Admin Task

Schedule Task

Run ASAP

Run on a schedule

One time ▼

Server Start Date/Time:

12/17/18 12:57 AM

4. Click **Next** to navigate to the next page, where you verify and confirm the task information entered, as shown in [Figure 12-10](#).

Click **Previous** to make changes or **Finish** to submit the task.

Figure 12-10 Verify and Confirm

Submit a New Admin Task

Verify and Confirm Before Clicking Finish

Action
Submit An Admin Task

Task
View and Manage PDS Properties (System Admin Tasks)

Description
Display / Reset / Update Different properties of a PDS

Label
Change_NAValue_Opt

Operations
Update pds property to value provided(name=value): navalue_opt=false

Property is boolean

Execute:
Execute Immediate(ASAP)

5. You see the just-scheduled task in the dashboard, as shown in [Figure 12-11](#).

Figure 12-11 Status

Description	Status	Task Type	Submitted by	Started/Scheduled	Completed	Record Status
Change_NAValue_Opt	Success	View and Manage PDS Properties	oci.admin	9/3/21 4:49:47 AM	9/3/21 4:50:23 AM	—

6. Click the task to see the log.

Available PDS Properties

Table 12-1 Available PDS Properties

Property Name	Type	Description
commit_asap_deadline	Time	Indicates the time of the day when a timeout has occurred for all outstanding commit ASAP operations. If a commit ASAP operation is submitted after this time, a timeout will not occur until the deadline on the next day. This string must have the following format: HH:MM. For example, 13:30 refers to 1:30 PM. The default value is 00:01 in GMT.
max_active_wb_per_user	Integer	The maximum number of workbooks that can be opened simultaneously for a user is determined by this PDS property. The actual count is one more than the value for the property to account for dashboard workbooks that are automatically opened when the user logs in.
ovr_def_admin_privileges	Boolean	Using the Security Administration workbook, administrators can set workbook template access for every user in the system. Non-administrative users cannot access the workbook templates to which they have not explicitly been given access. However, if a user is an administrator, by default, that user can see all the workbooks in the system. Some retailers want to prevent this from happening. Reasons for this include reducing clutter and having different kind of administrators manage different administrative tasks in their RPASCE systems. The ability to control template access for administrators from the Security Administration workbook is made possible by setting this PDS property to true. By default, this property is false.
subgroup_max_parallel	Integer	The mace utility runs in parallel, using up to the given value of subgroup_max_parallel where its value is an integer greater than 0.

Setting Date and Time Variables

Customers previously set the RPAS_TODAY and RPAS_LOG_LEVEL environment variables as global settings. These settings were then applied to all their tasks and operations scheduled through OAT. In order to accomplish this, customers contacted a cloud administrator (or raise an SR); the administrator would then set these environment variables and restart all services.

Now, the RPAS_PDS_TIMEZONE setting helps customers whose home time zone is distant from Greenwich Mean Time to set their chosen local time zone. All Oracle servers are required to run using the GMT time zone setting for the server. For customers who want to have the batches, system downtime, system availability, and RPASCE values such as today and now to be calculated based on their own chosen time zone rather than GMT, this setting may be used.

Customers themselves can set these variables using the OAT task (as a PDS property and not as an environment variable). They do not need to call a cloud administrator or

raise an SR. Once the customer has set the variables, these properties are applied to all processes. In order for the RPAS_PDS_TIMEZONE time change to take effect, Idip must be restarted after changing RPAS_PDS_TIMEZONE.

 **Note:**

The following priority order list is adhered to by these settings:

1. RPAS_TODAY and/or RPAS_LOG_LEVEL set during the batch process using the OAT task wizards that take the highest precedence.
2. Then, RPAS_TODAY and/or RPAS_LOG_LEVEL set using the OAT task List/Set /Unset Domain Env Variable.
3. Then, the RPAS_TODAY environment variable set in the backend shell before the services are started.
4. RPAS_PDS_TIMEZONE is only used in calculations when RPAS_TODAY is not set.

You can access the List/Set/Unset PDS Environment Variables task by selecting the option List/Set/Unset PDS Environment Variables from System Admin Tasks. You see the Submit An Admin Task dialog box, as shown in [Figure 12-12](#).

Figure 12-12 List/Set/Unset PDS Environment Variables Task

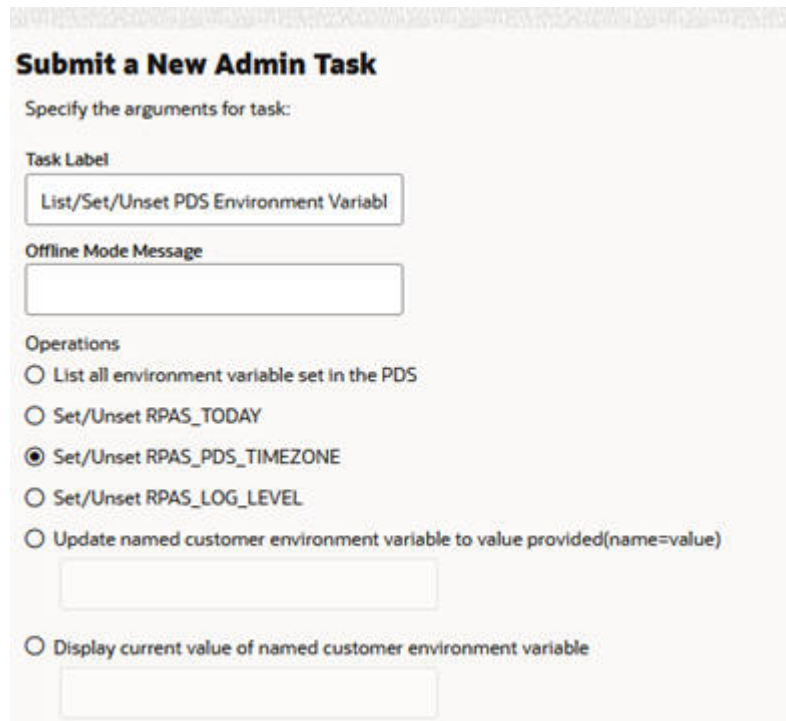

Submit a New Admin Task

Specify the arguments for task:

Task Label
List/Set/Unset PDS Environment Variabl

Offline Mode Message

Operations

List all environment variable set in the PDS

Set/Unset RPAS_TODAY

Set/Unset RPAS_PDS_TIMEZONE

Set/Unset RPAS_LOG_LEVEL

Update named customer environment variable to value provided(name=value)

Display current value of named customer environment variable

The following options are available:

- List all environment variable set in the application. Use this option to see the current values for the RPAS_TODAY and or RPAS_LOG_LEVEL. This also lists the timezone property, if set.
- Set/Unset RPAS_TODAY. Use this option to manage the RPAS_TODAY application property.
- Set/Unset RPAS_LOG_LEVEL. Use this option to manage the RPAS_LOG_LEVEL PDS property.
- Set/Unset RPAS_PDS_TIMEZONE. Use this option to manage the RPAS_PDS_TIMEZONE property.

When you select Set/Unset RPAS_TODAY and click **Next**, you see the dialog box shown in [Figure 12-13](#).

Figure 12-13 RPAS_TODAY Additional Options

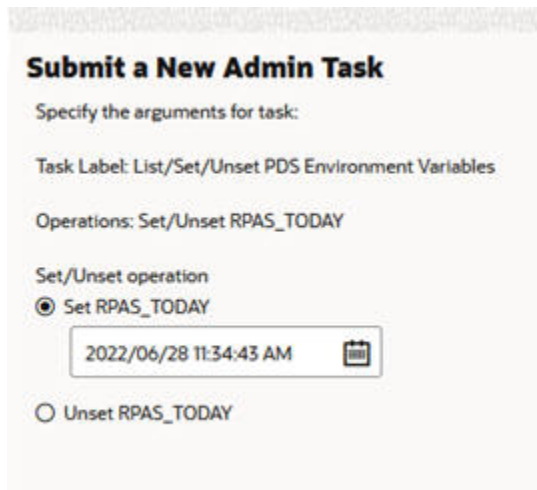

Submit a New Admin Task

Specify the arguments for task:

Task Label: List/Set/Unset PDS Environment Variables

Operations: Set/Unset RPAS_TODAY

Set/Unset operation

Set RPAS_TODAY

2022/06/28 11:34:43 AM 

Unset RPAS_TODAY

The following additional options are available:

- Set RPAS_TODAY. With this option and with the date selection, you can set the RPAS_TODAY PDS property.
- Unset RPAS_TODAY. Use this option to clear the RPAS_TODAY PDS property.

If you selected Set/Unset RPAS_LOG_LEVEL in the first option page, you see the dialog box shown in [Figure 12-14](#).

Figure 12-14 RPAS_LOG_LEVEL Additional Options

Submit a New Admin Task

Specify the arguments for task:

Task Label: List/Set/Unset PDS Environment Variables

Operations: Set/Unset RPAS_LOG_LEVEL

Set/Unset operation

Set RPAS_LOG_LEVEL

Basic ▾

Unset RPAS_LOG_LEVEL

The following additional options are available:

- Set RPAS_LOG_LEVEL. With this option and the level drop-down list, you can set the RPAS_LOG_LEVEL application property.
- Unset RPAS_LOG_LEVEL. Use this option to clear the RPAS_LOG_LEVEL application property.

Note that this task is automatically run in offline mode. As a result, all non-administrative users will be logged off and the task will be executed. This prevents users from running any batch or workbook operations while these settings are updated in the application.

If you selected Set/Unset RPAS_PDS_TIMEZONE in the first option page, you see the dialog box shown in [Figure 12-15](#).

Figure 12-15 RPAS_PDS_TIMEZONE Additional Options

Submit a New Admin Task

Specify the arguments for task:

Task Label: List/Set/Unset PDS Environment Variables

Operations: Set/Unset RPAS_PDS_TIMEZONE

Set/Unset operation

Set RPAS_PDS_TIMEZONE

Africa/Abidjan ▾

Unset RPAS_PDS_TIMEZONE

The following additional options are available:

- Set RPAS_PDS_TIMEZONE. With this option and the timezone drop-down list, you can set the RPAS_PDS_TIMEZONE. The values shown in the drop-down list are all the standard timezone names recognized by the system.
- Unset RPAS_PDS_TIMEZONE. Clear the RPAS_PDS_TIMEZONE PDS property using this option.

Accessing the Calculation Engine Using mace

The mace service (Multi-Dimensional Array Calculation Engine) is for informational use only. The administrator can use the service to inspect the rule and rule group information currently configured in the application. It does not allow the administrator to modify any existing rule or rule groups or run any expressions or rule groups in the application to modify application measure data. The supported functions include:

- Search for a specific string
- Print the specified rule
- Print the specified rule group
- Print all rule and rule groups

Submit Online Admin Task for Mace Service

To submit a mace service task, complete the following steps:

1. From Administration > Online Admin Tools > Submit a New Admin Task, select **System Admin Tasks**, as shown in [Figure 12-16](#), and click **Next**.

Figure 12-16 System Admin Tasks

Submit a New Admin Task

Select Task Group

- Configured Batch Tasks
- PDS Admin Tasks
- System Admin Tasks
- SR Admin Tasks
- Bootstrap Tasks
- Patch Application Task

- From the list of all available system administration tasks shown in [Figure 12-17](#), select **Expressions, Rules, and Rule Groups Information** and click **Next**.

Figure 12-17 System Administration Tasks

Submit a New Admin Task

Select A Task From System Admin Tasks Group

Search...

- Enable/Disable Toggleable Features
- Export Hierarchy Data
- Export Measure Data
- Expressions, Rules and Rule Groups Information**
- List Users Currently Logged-In
- List/Set/Unset PDS Environment Variable
- Load Interface Mappings
- Manage Dimensions
- Manage Hierarchies
- Manage Informal Positions
- Manage Users
- Manage Workspaces
- Measure Information
- Oracle Support Administration
- Purge Tasks from Task Status Dashboard

- Enter a descriptive label in the Task Label text box.
Select an operation from the following list of operations., as shown in [Figure 12-18](#).
 - Search for a specific string
 - Print the specified rule
 - Print the specified rule group
 - Print all the rules and rule groups

Figure 12-18 Search for a Specific String Operation

The screenshot shows a web form titled "Submit a New Admin Task". Below the title, it says "Specify the arguments for task:". The form has several fields and options:

- Task Label:** A text input field containing "Expressions, Rules and Rule Groups Inf".
- Log level:** A dropdown menu that is currently empty.
- Operations:** A section with four radio button options:
 - Search for a specific string: This option is selected. Below it is an empty text input field.
 - Print the specified rule: Below it is a dropdown menu showing "add1chnlmapb_calc".
 - Print the specified rule group: Below it is a dropdown menu showing "ad_calc".
 - Print all the rules and rule groups: This option is not selected.

Search for a Specific String

This service finds all occurrences of a user-specified string in all the expressions configured in the application. The string search is case insensitive. If a user searches for "ttlSales", expressions such as "TtlSales=..." and "TTLSALES = ..." will be identified. A user can search for any meaningful text in the expressions, not just measure names. For example, a user can search for function names to show all expressions configured to evaluate that function. Or a user can search for a modifier such as "level([clnd],[week])" to show all expressions that used that modifier.

The most common use for this function is to discover how a certain measure is calculated or referenced by rules configured in the application. In this case, the

administrator can search for the measure name as a string. Mace will return all rules that reference the measure.

1. Select **Search for a specific string**, enter the search term (here, TotalSales) in the Search for a specific string text box, as shown in [Figure 12-19](#), and click **Next**.

Figure 12-19 Search for Specific String

Submit a New Admin Task

Specify the arguments for task:

Task Label

Expressions, Rules and Rule Groups Info

Log level

Operations

Search for a specific string

totalsales

Print the specified rule

add1chnlmapb_calc

Print the specified rule group

ad_calc

Print all the rules and rule groups

2. You see Schedule Task, shown in [Figure 12-20](#), where you can run the task ASAP or on a schedule. If you choose to run on a schedule, you can select a frequency or a specific start and stop date and time.

Figure 12-20 Schedule Task

Submit a New Admin Task

Schedule Task

Run ASAP

Run on a schedule

One time ▼

Server Start Date/Time:

12/17/18 12:57 AM 

3. Click **Next** to navigate to the next page, where you verify and confirm the task information entered, as shown in [Figure 12-21](#).

Click **Previous** to make changes or **Finish** to submit the task.

Figure 12-21 Verify and Confirm

Submit a New Admin Task

Verify and Confirm Before Clicking Finish

Action
Submit An Admin Task

Task
Expressions, Rules and Rule Groups Information (System Admin Tasks)

Description
Display information about Expressions, Rules and Rule Groups

Label
Expressions, Rules and Rule Groups Information





Operations
Search for a specific string: totalsales

Execute:
Execute Immediate (ASAP)

- You see the just-scheduled task in the dashboard, as shown in [Figure 12-22](#).

Figure 12-22 Status

Task Status

Actions ▾ View ▾   Detach Auto-Refresh  Download Log  Watch Live Log  Download

Description	Status	Task Type	Submitted	Started/Sched	Completed	Record Status
Expressions, Rules an...	Success	Expressions, Rules a...	oci.ad...	9/3/21 6:2...	9/3/21 6:2...	—

- Select the task and click **Watch Live Log** to view the logs. Alternatively, click **Download Log** to download the log file and search for measure name totalsales in the log file that is named after the task type.

Print the Specified Rule

This service prints out all the configured expressions in the user-specified rule. The administrator can use this service to inspect the content of the rule.

1. Select **Print the specified rule**, enter the rule name to be printed, as shown in [Figure 12-23](#), and click **Next**.

Figure 12-23 Print Operation for Specified Rule

Submit a New Admin Task

Specify the arguments for task:

Task Label
Expressions, Rules and Rule Groups Info

Log level
▼

Operations

Search for a specific string

Print the specified rule
add1chnlmapb_calc ▼

Print the specified rule group
ad_calc ▼

Print all the rules and rule groups

2. You see Schedule Task, shown in [Figure 12-24](#), where you can run the task ASAP or on a schedule. If you choose to run on a schedule, you can select a frequency or a specific start and stop date and time.

Figure 12-24 Schedule Task

Submit a New Admin Task

Schedule Task

Run ASAP

Run on a schedule

One time ▼

Server Start Date/Time:

12/17/18 12:57 AM 

3. Click **Next** to navigate to the next page, where you verify and confirm the task information entered, as shown in [Figure 12-25](#).

Click **Previous** to make changes or **Finish** to submit the task.

Figure 12-25 Verify and Confirm

Submit a New Admin Task

Verify and Confirm Before Clicking Finish

Action
 Submit An Admin Task

Task
 Expressions, Rules and Rule Groups Information (System Admin Tasks)

Description
 Display information about Expressions, Rules and Rule Groups

Label
 Expressions, Rules and Rule Groups Information

Operations
 Print the specified rule: add1chnlmapb_calc

Execute:
 Execute Immediate(ASAP)

4. You see the just scheduled task in the dashboard, as shown in [Figure 12-26](#).

Figure 12-26 Status

Task Status

Actions ▼ View ▼ ↻ 📄 Detach 🔄 Auto-Refresh 📄 Download Log 📺 Watch Live Log 📄 Download

Description	Status	Task Type	Submitted	Started/Sched	Completed	Record Status
Expressions, Rules an...	Success	Expressions, Rules ...	oci.ad...	9/3/21 7:0...	9/3/21 7:0...	—

5. Select the task and click **Watch Live Log** to view the logs. Alternatively, click **Download Log** to download the log file.

Print the Specified Rule Group

This mace service prints out all rules and the expressions configured for a particular rule group. The administrator can use this service to inspect the content of a complete rule group.

1. Select **Print the specified rule group**, enter the rule group name to be printed, and click **Next**, as shown in [Figure 12-27](#).

Figure 12-27 Print Rule Group Operation

2. You see Schedule Task, shown in [Figure 12-28](#), where you can run the task ASAP or on a schedule. If you choose to run on a schedule, you can select a frequency or a specific start and stop date and time.

Figure 12-28 Schedule Task

3. Click **Next** to navigate to the next page, where you verify and confirm the task information entered, as shown in [Figure 12-29](#).
 Click **Previous** to make changes or **Finish** to submit the task.

Figure 12-29 Verify and Confirm

Submit a New Admin Task

Verify and Confirm Before Clicking Finish

Action
Submit An Admin Task

Task
Expressions, Rules and Rule Groups Information (System Admin Tasks)

Description
Display information about Expressions, Rules and Rule Groups

Label
Print the rule group

Operations
Print the specified rule group: ad_calc

Execute:
Execute Immediate(ASAP)

4. You see the just-scheduled task in the dashboard, as shown in [Figure 12-30](#).

Figure 12-30 Task Status

Task Status

Actions ▾
View ▾
 Detach
 Auto-Refresh
 Download Log
 Watch Live Log
 Downlo

Description	Status	Task Type	Submitted	Started/Sched	Completed	Record Status
Print the rule group	Success	Expressions, Rules ...	oci.ad...	9/3/21 7:0...	9/3/21 7:0...	—

5. Select the task and click **Watch Live Log** to view the logs. Alternatively, click **Download Log** to download the log file.

Print All the Rules and Rule Groups

This mace service prints out all the expressions configured for all rule groups in the application. The administrator can use this service to inspect the content of all rule groups.

1. Select **Print all the rules and rule groups**, as shown in [Figure 12-31](#), and click **Next**.

Figure 12-31 Print All Rule Groups Arguments

The screenshot shows a web form titled "Submit a New Admin Task". Below the title, it says "Specify the arguments for task:". The form contains several fields and options:

- Task Label:** A text input field containing "Print rules and rule groups".
- Log level:** A dropdown menu that is currently empty.
- Operations:** A section with four radio button options:
 - Search for a specific string: This option is followed by a greyed-out text input field.
 - Print the specified rule: This option is followed by a dropdown menu containing "add1chnlmapb_calc".
 - Print the specified rule group: This option is followed by a dropdown menu containing "ad_calc".
 - Print all the rules and rule groups: This option is selected, indicated by a blue dot in the radio button.

2. You see Schedule Task, shown in [Figure 12-32](#), where you can run the task ASAP or on a schedule. If you choose to run on a schedule, you can select a frequency or a specific start and stop date and time.

Figure 12-32 Schedule Task

Submit a New Admin Task

Schedule Task

Run ASAP

Run on a schedule

One time ▼

Server Start Date/Time:

12/17/18 12:57 AM 

3. Click **Next** to navigate to the next page, where you verify and confirm the task information entered, as shown in [Figure 12-33](#).

Click **Previous** to make changes or **Finish** to submit the task.

Figure 12-33 Verify and Confirm

Submit a New Admin Task

Verify and Confirm Before Clicking Finish

Action

Submit An Admin Task

Task

Expressions, Rules and Rule Groups Information (System Admin Tasks)

Description

Display information about Expressions, Rules and Rule Groups

Label

Print rules and rule groups

Operations

Print all the rules and rule groups





Execute:

Execute Immediate(ASAP)

4. You see the just-scheduled task in the dashboard, as shown in [Figure 12-34](#).

Figure 12-34 Task Status

Task Status

Actions ▾ View ▾   Detach Auto-Refresh  Download Log  Watch Live Log  Downlo

Description	Status	Task Type	Submittec	Started/Sched	Completed	Record Status
Print rules and rule g...	Success	Expressions, Rules ...	oci.ad...	9/3/21 7:4...	9/3/21 7:4...	—

5. Select the task and click **Watch Live Log** to view the log. Alternatively, click Download Log to download the log file.

Managing Segments Using wbatch

The Segment/Workspace Batch Operation Task, highlighted in [Figure 12-35](#), is used by the administrator to perform the following operations.

Figure 12-35 Segment/Workspace Batch Operation Task

Submit a New Admin Task

Select A Task From System Admin Tasks Group



List Users Currently Logged-In
List/Set/Unset PDS Environment Variable
Load Interface Mappings
Manage Dimensions
Manage Hierarchies
Manage Informal Positions
Manage Users
Manage Workspaces
Measure Information
Oracle Support Administration
Purge Tasks from Task Status Dashboard
Rename Positions
Schedule Dashboard Build
Segment/Workspace Batch Operation
View and Manage PDS Properties

- Remove a segment
- Remove a workbook for a segment
- Remove all segments belonging to a specific user
- Remove all segments belonging to a specific template

- Remove all segments
- Build a Segment
- Commit a segment
- Refresh a segment
- Add a segment to the batch build queue
- Add a segment to the batch commit queue
- Add a segment to the batch refresh queue
- Remove a segment from the batch build queue
- Remove a segment from the batch commit queue
- Remove a segment from the batch refresh queue
- Start a batch operation on all/build/commit/refresh queues
- Print a segment in all/build/commit/refresh queues

Remove a Segment

The Remove Segment option, shown in [Figure 12-36](#), is used to select the segment from the drop-down list and remove the segment from the application, as shown in [Figure 12-37](#) and [Figure 12-38](#). It also deletes all the workbooks that are built based on this segment.

Figure 12-36 Remove a Segment

Submit An Admin Task

Specify the arguments for task:

Task Label
task1

Override RPAS_TODAY? Uncheck to default system setting

Log level
▼

Operations

- Remove a segment
- Remove workbook for a segment
- Remove all segments belonging to a specific user
- Remove all segments belonging to a specific template
- Remove all segments in the domain
- Build a segment
- Commit a segment
- Refresh a segment
- Add segment to batch build queue
- Add segment to batch commit queue

Cancel < Previous Next > Finish

Figure 12-37 Remove a Segment Argument: Select User and Template

Submit a New Admin Task

Specify the arguments for task:

Task Label: Remove segment

Operations: Remove a segment

For user

oci.admin(Administrator) ▼

Segment of template

Security Administration ▼

Figure 12-38 Remove a Segment Task Argument: Select Segment

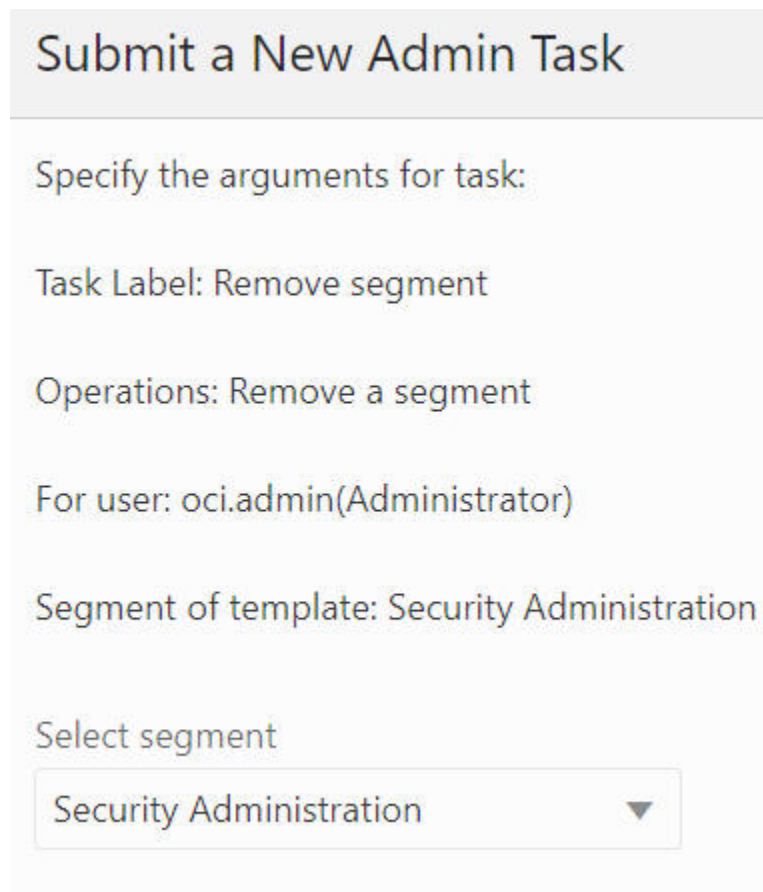

The screenshot shows a web form titled "Submit a New Admin Task". Below the title, it says "Specify the arguments for task:". The form contains several text input fields: "Task Label: Remove segment", "Operations: Remove a segment", "For user: oci.admin(Administrator)", and "Segment of template: Security Administration". At the bottom, there is a dropdown menu labeled "Select segment" with "Security Administration" selected and a downward arrow icon.

Remove Workbook for a Segment

The Remove Workbook for a Segment option, shown in [Figure 12-39](#), is used to select the segment and delete its workbook, as shown in [Figure 12-40](#) and [Figure 12-41](#), built based on this selected segment, while this segment remains.

Figure 12-39 Remove Workbook for a Segment

Submit a New Admin Task

Specify the arguments for task:

Task Label

Override RPAS_TODAY? Uncheck to default system setting

Log level

Operations

- Remove a segment
- Remove workbook for a segment
- Remove all segments belonging to a specific user
- Remove all segments belonging to a specific template
- Remove all segments
- Build a segment
- Commit a segment
- Refresh a segment
- Add segment to batch build queue
- Add segment to batch commit queue

Figure 12-40 Remove Workbook for a Segment: Select User and Template

The screenshot shows a web interface for submitting an admin task. At the top, there is a header "Submit a New Admin Task". Below this, the text "Specify the arguments for task:" is followed by "Task Label: Remove workbook" and "Operations: Remove workbook for a segment". There are two dropdown menus: "For user" with the selected value "oci.admin(Administrator)" and "Segment of template" with the selected value "Security Administration".

Submit a New Admin Task

Specify the arguments for task:

Task Label: Remove workbook

Operations: Remove workbook for a segment

For user

oci.admin(Administrator) ▼

Segment of template

Security Administration ▼

Figure 12-41 Remove Segment Task Argument: Select Segment

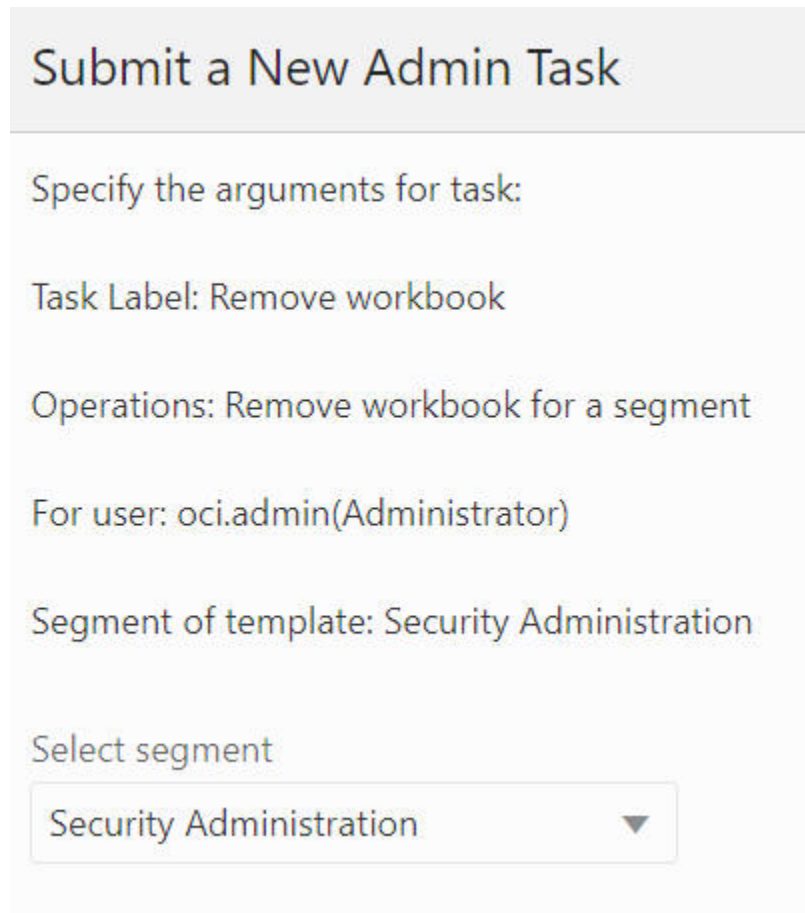

The screenshot shows a web form titled "Submit a New Admin Task". Below the title, there is a section labeled "Specify the arguments for task:". The form contains several text input fields with the following values: "Task Label: Remove workbook", "Operations: Remove workbook for a segment", "For user: oci.admin(Administrator)", and "Segment of template: Security Administration". At the bottom, there is a "Select segment" label above a dropdown menu. The dropdown menu is currently open, showing "Security Administration" as the selected option.

Remove All Segments Belonging to a Specific User

The Remove All Segments Belong to a specific User, shown in [Figure 12-42](#) and [Figure 12-43](#), option is used to select the user from the drop-down list and remove all the segments belonging to that specific user from the application.

Figure 12-42 Remove All Segments Belonging to Specific User

Submit a New Admin Task

Specify the arguments for task:

Task Label

Override RPAS_TODAY? Uncheck to default system setting

Log level

Operations

- Remove a segment
- Remove workbook for a segment
- Remove all segments belonging to a specific user
- Remove all segments belonging to a specific template
- Remove all segments
- Build a segment
- Commit a segment
- Refresh a segment
- Add segment to batch build queue
- Add segment to batch commit queue

**Figure 12-43 Remove All Segments Belonging to a Specific User Task Argument:
Select User**

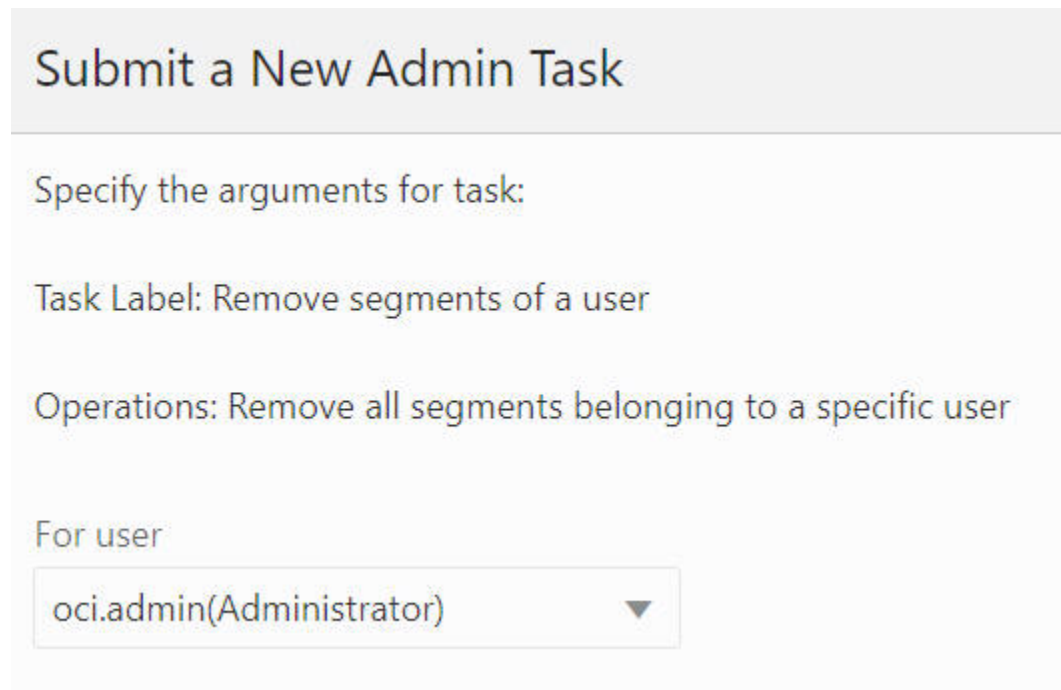

Submit a New Admin Task

Specify the arguments for task:

Task Label: Remove segments of a user

Operations: Remove all segments belonging to a specific user

For user

oci.admin(Administrator) ▼

Remove All Segments Belonging to a Specific Template

The Remove All Segments Belonging to a Specific Template option, shown in [Figure 12-44](#) and [Figure 12-45](#), is used to select the template from the drop-down list and remove all the segments belonging to that specific template from the application.

Figure 12-44 Remove Segments Belonging to Specific Template

Submit a New Admin Task

Specify the arguments for task:

Task Label

Remove segments of a template

Override RPAS_TODAY? Uncheck to default system setting

Log level

Operations

- Remove a segment
- Remove workbook for a segment
- Remove all segments belonging to a specific user
- Remove all segments belonging to a specific template
- Remove all segments
- Build a segment
- Commit a segment
- Refresh a segment
- Add segment to batch build queue
- Add segment to batch commit queue

Figure 12-45 Remove All Segments Belonging to a Specific Template Task Argument: Select Template

The screenshot shows a web form titled "Submit a New Admin Task". The form contains the following fields:

- Specify the arguments for task:**
- Task Label:** Remove segments of a template
- Operations:** Remove all segments belonging to a specific template
- Segment of template:** A dropdown menu with the following options:
 - Create Location Plan
 - Merch Plan
 - Merch Target
 - Performance Diagnostic Tool
 - Placeholder
 - Plan Admin
 - Planner Dashboard
 - Security Administration
 - Translation Administration

Remove All Segments

The Remove All Segments option, shown in [Figure 12-46](#), is used to remove all the segments in the application.

Figure 12-46 Remove All Segments

Submit a New Admin Task

Specify the arguments for task:

Task Label

Override RPAS_TODAY? Uncheck to default system setting

Log level

Operations

- Remove a segment
- Remove workbook for a segment
- Remove all segments belonging to a specific user
- Remove all segments belonging to a specific template
- Remove all segments
- Build a segment
- Commit a segment
- Refresh a segment
- Add segment to batch build queue
- Add segment to batch commit queue

Build a Segment

The Build a Segment option, shown in [Figure 12-47](#) and [Figure 12-48](#), is used to select a segment from the segment drop-down list and build a workbook based on it. The segments that already have their associated workbook are filtered from this drop-down list.

 **Note:**

This online administration task can also be used to schedule all the administration templates (for example, Performance Diagnostic Tools, Security Administration, Translation Administration, and Measure Analysis).

If the user defines a segment by specifying Rolling Calendar PQD on the calendar wizard, and then uses OAT to schedule a segment build, the actual calendar positions included in the built segment will be the result of the evaluation of the Rolling Calendar PQD at the time of the actual segment build. For example, the user defines the segment at the time 2020 Jan 01, and specifies that two days after the day must be included in the segment, (assuming the calendar wizard is at DAY) level. Then, the user schedules the segment to be rebuilt on 2020 March 1st. The actual days included in the built segment in this case would be March 1st, 2nd, 3rd of 2020.

Figure 12-47 Build a Segment

Submit a New Admin Task

Specify the arguments for task:

Task Label

Override RPAS_TODAY? Uncheck to default system setting

Log level

Operations

- Remove a segment
- Remove workbook for a segment
- Remove all segments belonging to a specific user
- Remove all segments belonging to a specific template
- Remove all segments
- Build a segment
- Commit a segment
- Refresh a segment
- Add segment to batch build queue
- Add segment to batch commit queue

Figure 12-48 Build Segment Arguments

Submit a New Admin Task

Specify the arguments for task:

Task Label: Build a segment

Operations: Build a segment

For user

oci.admin(OCI Admin) ▼

Segment of template

Enable Op Approval ▼

- Create Location Plan ▲
- Create Location Targets
- Enable Op Approval
- Hierarchy Maintenance
- Load Validate
- Location Setup
- Measure Analysis
- Merch Plan ▼

Commit a Segment

The Commit Segment option, shown in [Figure 12-49](#) and [Figure 12-50](#), is used to select a segment and commit its change in the workbook to the application. The drop-down list only retains those segments that have their associated workbooks in the application. If this segment is in the commit queue, it will be taken out once this commit operation completes.

Figure 12-49 Specify Segment Arguments

Submit a New Admin Task

Specify the arguments for task:

Task Label

Override RPAS_TODAY? Uncheck to default system setting

Log level

Operations

- Remove a segment
- Remove workbook for a segment
- Remove all segments belonging to a specific user
- Remove all segments belonging to a specific template
- Remove all segments
- Build a segment
- Commit a segment
- Refresh a segment
- Add segment to batch build queue
- Add segment to batch commit queue

Figure 12-50 Commit Segment Arguments

The screenshot shows a web form titled "Submit a New Admin Task". Below the title, it says "Specify the arguments for task:". The form contains the following fields and values:

- Task Label: Segment/Workspace Batch Operation
- Operations: Commit a segment
- For user: oci.admin(Administrator) (dropdown menu)
- Segment of template: Create Location Plan (dropdown menu with a list of options: Create Location Plan, Create Location Targets, Enable Op Approval, Hierarchy Maintenance, Load Validate, Location Setup, Measure Analysis, Merch Plan)

Refresh a Segment

The Refresh a Segment option, shown in [Figure 12-51](#) and [Figure 12-52](#), is used to select a segment and refresh its workbook data from the application. The drop-down list only retains those segments that have their associated workbooks in the application.

Figure 12-51 Refresh Segment

Submit a New Admin Task

Specify the arguments for task:

Task Label

Override RPAS_TODAY? Uncheck to default system setting

Log level

Operations

- Remove a segment
- Remove workbook for a segment
- Remove all segments belonging to a specific user
- Remove all segments belonging to a specific template
- Remove all segments
- Build a segment
- Commit a segment
- Refresh a segment
- Add segment to batch build queue
- Add segment to batch commit queue

Figure 12-52 Refresh Segment Arguments

The screenshot shows a web form titled "Submit a New Admin Task". The form contains the following fields and options:

- Specify the arguments for task:**
 - Task Label: Refresh segment
 - Operations: Refresh a segment
- For user:** A dropdown menu with "adm(Administrator)" selected.
- Segment of template:** A dropdown menu with "Create Location Plan" selected. The dropdown is open, showing a list of options: "Create Location Plan", "Create Location Targets", "Enable Op Approval", "Hierarchy Maintenance", "Load Validate", "Location Setup", "Measure Analysis", and "Merch Plan".

Add Segment to Batch Build Queue

The Add Segment to Batch Build Queue option, shown in [Figure 12-53](#) and [Figure 12-54](#), is used to add the selected segments to the build queue. The segment list includes all the segments in the application, and it supports multiple segment selection operation.

Figure 12-53 Add Segment to Batch Build Queue

Submit a New Admin Task

Specify the arguments for task:

Task Label

Add segment to batch build queue

Override RPAS_TODAY? Uncheck to default system setting

Log level

Operations

- Remove a segment
- Remove workbook for a segment
- Remove all segments belonging to a specific user
- Remove all segments belonging to a specific template
- Remove all segments
- Build a segment
- Commit a segment
- Refresh a segment
- Add segment to batch build queue
- Add segment to batch commit queue

Figure 12-54 Add Segment Arguments

Submit a New Admin Task

Specify the arguments for task:

Task Label: Add segment to batch build queue

Operations: Add segment to batch build queue

For user

adm(Administrator) ▼

Segment of template

- Create Location Plan ▼
- Create Location Plan ▲
- Create Location Targets
- Enable Op Approval
- Hierarchy Maintenance
- Load Validate
- Location Setup
- Measure Analysis
- Merch Plan

Add Segment to Batch Commit Queue

The Add Segment to Batch Commit Queue option, shown in [Figure 12-55](#) and [Figure 12-56](#), is used to add the selected segments to the commit queue. The segment list includes all the segments that have their associated workbook in the application, and it supports multiple segment selection operation.

Figure 12-55 Segment Batch Commit Queue

Submit a New Admin Task

Specify the arguments for task:

Task Label

Override RPAS_TODAY? Uncheck to default system setting

Log level

Operations

- Remove a segment
- Remove workbook for a segment
- Remove all segments belonging to a specific user
- Remove all segments belonging to a specific template
- Remove all segments
- Build a segment
- Commit a segment
- Refresh a segment
- Add segment to batch build queue
- Add segment to batch commit queue

Figure 12-56 Segment Batch Commit Queue Arguments

Submit a New Admin Task

Specify the arguments for task:

Task Label: Add segment to batch commit queue

Operations: Add segment to batch commit queue

For user

adm(Administrator) ▼

Segment of template

Create Location Plan ▼

- Create Location Plan ▲
- Create Location Targets
- Enable Op Approval
- Hierarchy Maintenance
- Load Validate
- Location Setup
- Measure Analysis
- Merch Plan ▼

Add Segment to Batch Refresh Queue

The Add Segment to Batch Refresh Queue option, shown in [Figure 12-57](#) and [Figure 12-58](#), is used to add the selected segments to the refresh queue. The segment list includes all the segments that have their associated workbook in the application, and it supports multiple segment selection operations.

Figure 12-57 Add Segment to Batch Refresh Queue

Submit a New Admin Task

Task Label

Override RPAS_TODAY? Uncheck to default system setting

Log level

Operations

- Remove a segment
- Remove workbook for a segment
- Remove all segments belonging to a specific user
- Remove all segments belonging to a specific template
- Remove all segments
- Build a segment
- Commit a segment
- Refresh a segment
- Add segment to batch build queue
- Add segment to batch commit queue
- Add segment to batch refresh queue

Figure 12-58 Add Segment to Batch Refresh Queue Arguments

Submit a New Admin Task

Specify the arguments for task:

Task Label: Add segment to batch refresh queue

Operations: Add segment to batch refresh queue

For user

adm(Administrator)

Segment of template

- Create Location Plan
- Create Location Plan
- Create Location Targets
- Enable Op Approval
- Hierarchy Maintenance
- Load Validate
- Location Setup
- Measure Analysis
- Merch Plan

Remove Segment from Batch Build Queue

The Remove Segment from Batch Build Queue option, shown in [Figure 12-59](#) and [Figure 12-60](#), is used to remove the selected segments from the build queue. The segment list includes all the segments in the application, and it supports multiple segment selection

operations. If the selected segment is not in the queue, it will provide a warning message in the output log file.

Figure 12-59 Remove Segment from Batch Build Queue

Submit a New Admin Task

Override RPAS_TODAY? Uncheck to default system setting

Log level

Operations

- Remove a segment
- Remove workbook for a segment
- Remove all segments belonging to a specific user
- Remove all segments belonging to a specific template
- Remove all segments
- Build a segment
- Commit a segment
- Refresh a segment
- Add segment to batch build queue
- Add segment to batch commit queue
- Add segment to batch refresh queue
- Remove segment from batch build queue
- Remove segment from batch commit queue
- Remove segment from batch refresh queue

Figure 12-60 Remove Segment from Batch Build Queue Arguments

The screenshot shows a web interface for submitting an admin task. At the top, there is a header 'Submit a New Admin Task'. Below it, the text 'Specify the arguments for task:' is followed by two lines of text: 'Task Label: Remove segment from batch build queue' and 'Operations: Remove segment from batch build queue'. Under the heading 'For user', there is a dropdown menu with 'adm(Administrator)' selected. Below that, under the heading 'Segment of template', there is a dropdown menu with a list of options: 'Create Location Plan', 'Create Location Targets', 'Enable Op Approval', 'Hierarchy Maintenance', 'Load Validate', 'Location Setup', 'Measure Analysis', and 'Merch Plan'. The 'Create Location Plan' option is currently selected and highlighted.

Remove Segment from Batch Commit Queue

The Remove Segment from Batch Commit Queue option, shown in [Figure 12-61](#), [Figure 12-62](#), and [Figure 12-63](#), is used to remove the selected segments from the commit queue. The segment list includes all the segments that have their associated workbook in the

application, and it supports multiple segment selection operations. If the selected segment is not in the queue, it will provide a warning message in the output log file.

Figure 12-61 Remove Segment from Batch Commit Queue

Submit a New Admin Task

Override RPAS_IODAY? Uncheck to default system setting

Log level

Operations

- Remove a segment
- Remove workbook for a segment
- Remove all segments belonging to a specific user
- Remove all segments belonging to a specific template
- Remove all segments
- Build a segment
- Commit a segment
- Refresh a segment
- Add segment to batch build queue
- Add segment to batch commit queue
- Add segment to batch refresh queue
- Remove segment from batch build queue
- Remove segment from batch commit queue
- Remove segment from batch refresh queue

Figure 12-62 Remove Segment from Batch Commit Queue Arguments: Select User and Template

The screenshot shows a web form titled "Submit a New Admin Task". Below the title, it says "Specify the arguments for task:". The form contains the following fields:

- Task Label: Remove segment from batch commit queue
- Operations: Remove segment from batch commit queue
- For user: A dropdown menu with "oci.admin(OCI Admin)" selected.
- Segment of template: A dropdown menu with "Merch Target" selected. The dropdown is open, showing a list of options: "Merch Target", "Create Location Plan", "Create Location Targets", "Enable Op Approval", "Hierarchy Maintenance", "Load Validate", "Location Setup", "Measure Analysis", "Merch Plan", and "Merch Target".

Figure 12-63 Remove Segment form Batch Commit Queue Argument: Select Segment

Submit a New Admin Task

Specify the arguments for task:

Task Label: Remove segment from batch commit queue

Operations: Remove segment from batch commit queue

For user: oci.admin(OCI Admin)

Segment of template: Merch Target

Segment

		1 selected
<input checked="" type="checkbox"/>	CrtMrchPlnTgts1	

Remove Segment from Batch Refresh Queue

The Remove Segment from Batch Refresh Queue option, shown in [Figure 12-64](#) and [Figure 12-65](#), is used to remove the selected segments from the refresh queue. The segment list includes all the segments that have their associated workbook in the application, and it supports multiple segment selection operations. If the selected segment is not in the queue, it will provide a warning message in the output log file.

Figure 12-64 Remove Segment from Batch Refresh Queue

Submit a New Admin Task

Override RPAS_IODAY? Uncheck to default system setting

Log level

Operations

- Remove a segment
- Remove workbook for a segment
- Remove all segments belonging to a specific user
- Remove all segments belonging to a specific template
- Remove all segments
- Build a segment
- Commit a segment
- Refresh a segment
- Add segment to batch build queue
- Add segment to batch commit queue
- Add segment to batch refresh queue
- Remove segment from batch build queue
- Remove segment from batch commit queue
- Remove segment from batch refresh queue

Figure 12-65 Remove Segment form Batch Refresh Queue Arguments

The screenshot shows a web form titled "Submit a New Admin Task". Below the title, it says "Specify the arguments for task:". The form contains the following fields:

- Task Label:** Remove segment from batch refresh queue
- Operations:** Remove segment from batch refresh queue
- For user:** A dropdown menu with "oci.admin(Administrator)" selected.
- Segment of template:** A dropdown menu with "Merch Target" selected. The dropdown is open, showing a list of options: "Create Location Plan", "Create Location Targets", "Enable Op Approval", "Hierarchy Maintenance", "Load Validate", "Location Setup", "Measure Analysis", and "Merch Plan".

Start Batch Operation on All/Build/Commit/Refresh Queues

This option is used to batch process all the segments in the all/build/commit/refresh queues.

Figure 12-66 Start Batch Operation

Submit a New Admin Task

- Remove workbook for a segment
- Remove all segments belonging to a specific user
- Remove all segments belonging to a specific template
- Remove all segments
- Build a segment
- Commit a segment
- Refresh a segment
- Add segment to batch build queue
- Add segment to batch commit queue
- Add segment to batch refresh queue
- Remove segment from batch build queue
- Remove segment from batch commit queue
- Remove segment from batch refresh queue
- Start batch operation

All queues ▼

- All queues
- Build queue
- Commit queue
- Refresh queue

Print Segment in All/Build/Commit/Refresh Queues

The Print Segment in All/Build/Commit/Refresh Queues option, shown in [Figure 12-67](#), is used to print out the detailed information of the segments in the all/build/commit/refresh queues.

Figure 12-67 Print Segment in All/Build/Commit/Refresh Queues

Submit a New Admin Task

- Remove workbook for a segment
- Remove all segments belonging to a specific user
- Remove all segments belonging to a specific template
- Remove all segments
- Build a segment
- Commit a segment
- Refresh a segment
- Add segment to batch build queue
- Add segment to batch commit queue
- Add segment to batch refresh queue
- Remove segment from batch build queue
- Remove segment from batch commit queue
- All queues
- Build queue
- Commit queue
- Refresh queue
- All queues

FAQ

Question: How to build/commit/refresh multiple segments at the same time.

Answer: Add those segments into the build/commit/refresh queue, then start a batch operation on that queue.

Managing Workbooks Using wbmgr

The Workbook Manager Utility, WbMgr, is the administration task that can be used to inspect or remove existing workbooks. It supports workbook application transparency, which means a user can use it to manage all the workbooks throughout the application.

Figure 12-68 Workbook Manager

Submit a New Admin Task

Select A Task From System Admin Tasks Group



Enable/Disable Toggleable Features
Export Hierarchy Data
Export Measure Data
Expressions, Rules and Rule Groups Information
List Users Currently Logged-In
List/Set/Unset PDS Environment Variable
Load Interface Mappings
Manage Dimensions
Manage Hierarchies
Manage Informal Positions
Manage Users
Manage Workspaces
Measure Information
Oracle Support Administration
Purge Tasks from Task Status Dashboard

WbMgr provides the following functionality:

- List all the workbooks
- List workbooks belonging to a specific user
- List workbooks belonging to a specific template
- Remove all workbooks
- Remove workbooks belonging to a specific user

- Remove workbooks belonging to a specific template
- Remove selected workbooks
- Print detailed information about workbooks

List All Workbooks

The List All Workbooks option, shown in [Figure 12-69](#) and [Figure 12-70](#), is used to list all the workbooks in the application. A wizard page provides an optional argument to display the segment label in the output file.

Figure 12-69 List All Workbooks

Submit a New Admin Task

Specify the arguments for task:

Task Label

Log level

Operations

- List all workbooks
- List workbooks belonging to a specific user
- List workbooks belonging to a specific template
- Remove all workbooks
- Remove workbooks belonging to a specific user
- Remove workbooks belonging to a specific template

Figure 12-70 List All Workbooks Arguments

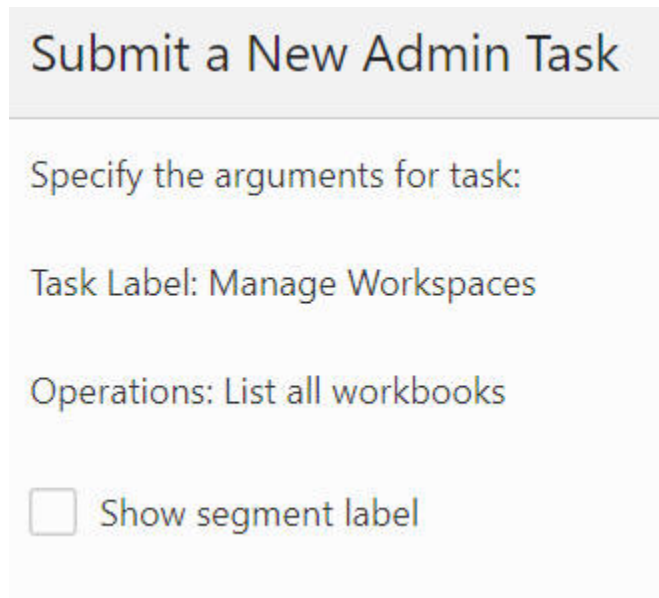

Submit a New Admin Task

Specify the arguments for task:

Task Label: Manage Workspaces

Operations: List all workbooks

Show segment label

List Workbooks Belonging to a Specific User

The List Workbooks Belonging to a Specific User option, shown in [Figure 12-71](#) and [Figure 12-72](#), is used to list all the workbooks owned by a specific user (from the user drop-down list) in the application. A wizard page provides an optional argument to display the segment label in the output file.

Figure 12-71 Workbooks Belonging to a Specific User

Submit a New Admin Task

Specify the arguments for task:

Task Label

Log level

Operations

- List all workbooks
- List workbooks belonging to a specific user
- List workbooks belonging to a specific template
- Remove all workbooks
- Remove workbooks belonging to a specific user
- Remove workbooks belonging to a specific template

Figure 12-72 Workbooks Belonging to a Specific User Arguments

Submit a New Admin Task

Specify the arguments for task:

Task Label: Manage Workspaces

Operations: List workbooks belonging to a specific user: oci.admin(Administrator)

Show segment label

List Workbooks Belonging to a Specific Template

The List Workbooks Belonging to a Specific Template option, shown in [Figure 12-73](#) and [Figure 12-74](#), is used to list all the workbooks built based on the workbook template (from workbook template drop-down list) in the application. A wizard page provides two optional arguments, a segment label to display the segment label in the output file and user filtering by the workbook owner (from the user drop-down list).

Figure 12-73 Workbooks Belonging to a Specific Template

Submit a New Admin Task

Specify the arguments for task:

Task Label

Log level

Operations

- List all workbooks
- List workbooks belonging to a specific user
- List workbooks belonging to a specific template
 - Load Validate
 - Location Setup
 - Measure Analysis
 - Merch Plan
 - Merch Target
 - Placeholder

Figure 12-74 Workbooks Belonging to a Specific Template Arguments

Submit a New Admin Task

Specify the arguments for task:

Task Label: Manage Workspaces

Operations: List workbooks belonging to a specific template: Merch Plan

List workbooks belonging to a specific user

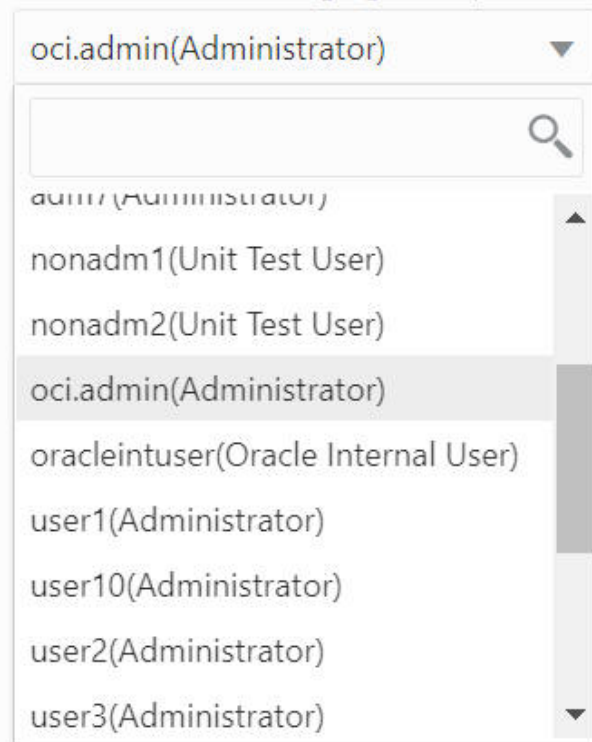

The image shows a dropdown menu with the following items:

- oci.admin(Administrator) (selected)
- admin (Administrator)
- nonadm1(Unit Test User)
- nonadm2(Unit Test User)
- oci.admin(Administrator)
- oracleintuser(Oracle Internal User)
- user1(Administrator)
- user10(Administrator)
- user2(Administrator)
- user3(Administrator)

Remove All Workbooks

The Remove All workbooks option, shown in [Figure 12-75](#), is used to delete all the workbooks in the application.

Figure 12-75 Remove All Workbooks

Submit a New Admin Task

Specify the arguments for task:

Task Label

Log level

Operations

List all workbooks

List workbooks belonging to a specific user

List workbooks belonging to a specific template

Remove all workbooks

Remove workbooks belonging to a specific user

Remove workbooks belonging to a specific template

Remove Workbooks Belonging to a Specific User

The Remove Workbooks Belonging to a specific User option, shown in [Figure 12-76](#) and [Figure 12-77](#), is used to delete all the workbooks owned by a specific user (from the user drop-down list) in the application. A wizard page can be used to select multiple workbooks to be deleted.

Figure 12-76 Remove Workbooks Belonging to a Specific User

Submit a New Admin Task

Manage Workspaces remove workboo

Log

Open

adm1(Administrator)

adm10(Administrator)

adm2(Administrator)

adm4(Administrator)

adm7(Administrator)

nonadm1(Unit Test User)

nonadm2(Unit Test User)

oci.admin(Administrator)

oci.admin(Administrator)

Remove workbooks belonging to a specific template

Measure Analysis

Remove selected workbooks

Print detailed information about workbooks

Figure 12-77 Remove Workbooks Belonging to a Specific User Arguments

Submit a New Admin Task

Specify the arguments for task:

Task Label: Manage Workspaces remove workbooks of a user

Operations: Remove workbooks belonging to a specific user: oci.admin(Administrator)

Remove segment also

Remove Workbooks Belonging to a Specific Template

The Remove Workbooks Belonging to a Specific Template option, shown in [Figure 12-78](#) and [Figure 12-79](#), is used to delete all the workbooks built based on the workbook template (from the workbook template drop-down list) in the application. A wizard page provides the option to filter the workbook by the workbook owner (from the user drop-down list).

Figure 12-78 Remove Workbooks Belonging to a Specific Template

Submit a New Admin Task

Remove workbooks of a template

Log level

Operations

- List all workbooks
- Create Location Plan
- Create Location Targets
- Enable Op Approval
- Hierarchy Maintenance
- Load Validate
- Location Setup
- Measure Analysis
- Merch Plan
- Merch Target
- Remove selected workbooks
- Print detailed information about workbooks

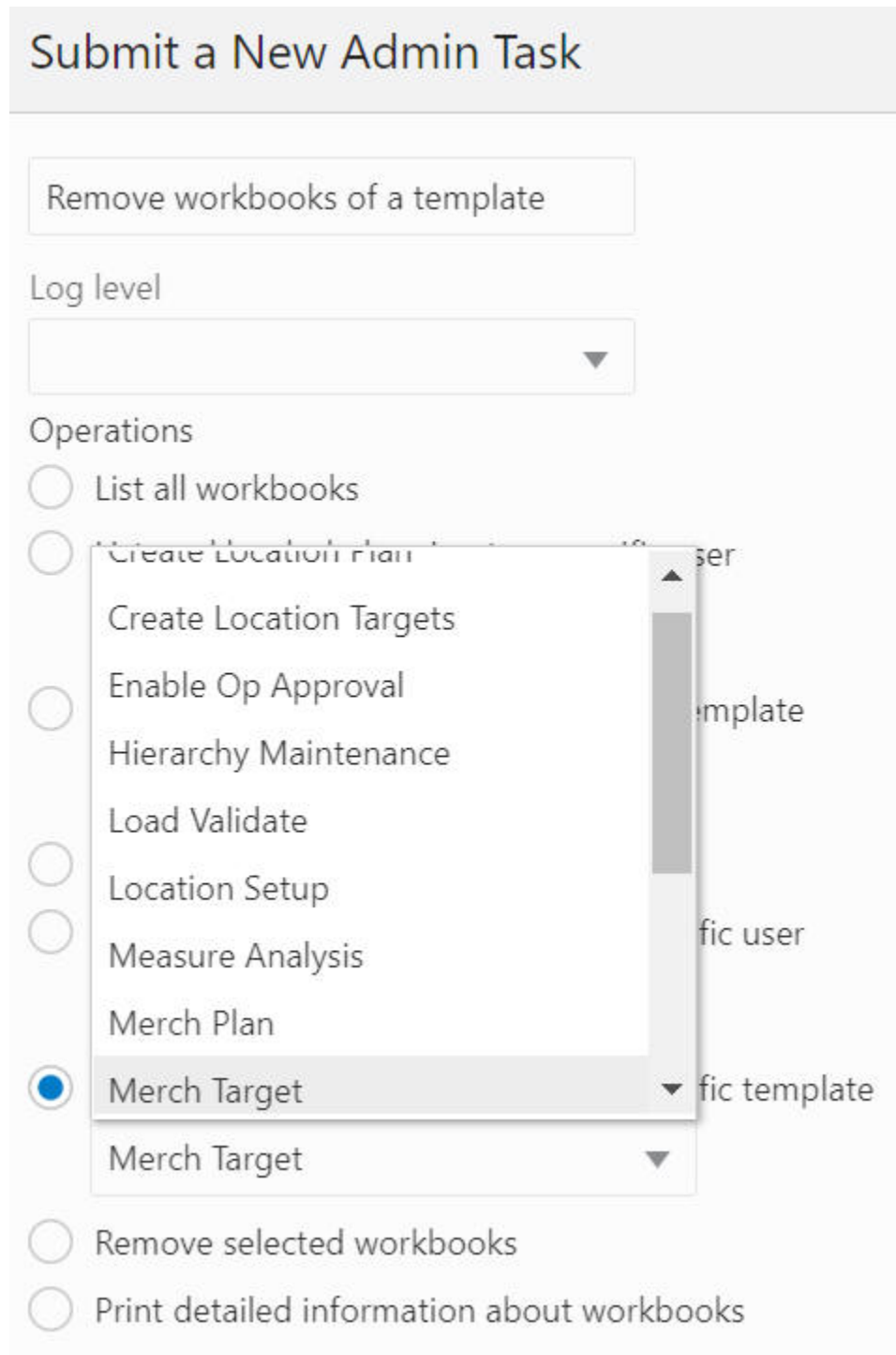

Figure 12-79 Remove Workbooks Belonging to a Specific Template Arguments

Submit a New Admin Task

Specify the arguments for task:

Task Label: Remove workbooks of a template

Operations: Remove workbooks belonging to a specific template: Merch Target

Remove workbooks belonging to a specific user

adm7(Administrator)
nonadm1(Unit Test User)
nonadm2(Unit Test User)
oci.admin(Administrator)
oracleintuser(Oracle Internal User)
user1(Administrator)
user10(Administrator)
user2(Administrator)

Remove Selected Workbooks

The Remove Selected Workbooks option, shown in [Figure 12-80](#) and [Figure 12-81](#), is used to delete selected workbooks in the application.

Figure 12-80 Remove Selected Workbooks

Submit a New Admin Task

- List workbooks belonging to a specific user
- List workbooks belonging to a specific template
- Remove all workbooks
- Remove workbooks belonging to a specific user
- Remove workbooks belonging to a specific template
- Remove selected workbooks
 - 1 selected [Show Selected](#)
 - oci.admin : Security Administration : Initial
 - oci.admin : Translation Administration : Initial
- Print detailed information about workbooks

Figure 12-81 Remove Selected Workbooks Arguments

Submit a New Admin Task

Specify the arguments for task:

Task Label: Remove selected workbooks

Operations: Remove selected workbooks: oci.admin : Translation Administration : Initial

Remove segment also

Print Detailed Information About Workbooks

The Print Detailed Information About Workbooks option, shown in [Figure 12-82](#), is used to print out the detailed information about the workbook selected by the user. It supports the selection of multiple workbooks. The detailed information about workbook includes Label, Last opened by, User privilege, Group privilege, World privilege, User ID, User Name, Group, Created, Modified, and Committed.

Figure 12-82 Print Detailed Information About Workbooks

Submit a New Admin Task

- List all workbooks
- List workbooks belonging to a specific user
user3(Administrator) ▼
- List workbooks belonging to a specific template
Measure Analysis ▼
- Remove all workbooks
- Remove workbooks belonging to a specific user
user3(Administrator) ▼
- Remove workbooks belonging to a specific template
Measure Analysis ▼
- Remove selected workbooks
- Print detailed information about workbooks

<input type="checkbox"/>	1 selected	Show Selected
<input checked="" type="checkbox"/>	oci.admin : Security Administration : Initial	
<input type="checkbox"/>	oci.admin : Translation Administration : Initial	

13

Planning Data Schema Diagnostic Tool (PDS Explorer)

This chapter describes the RPASCE Planning Data Schema Diagnostic Tool called PDS Explorer. The PDS Explorer is a set of administrative web-based tools that an application administrator or system integrator can use to identify and review many RPASCE data schema issues. In this way, the system administrator or system integrator has access to the information necessary to take action to diagnose the issue related to configuration, hierarchies, and measure data.

Interface

The Home page, shown in [Figure 13-1](#), provides access to the following main pages.

Figure 13-1 PDS Explorer Home Page

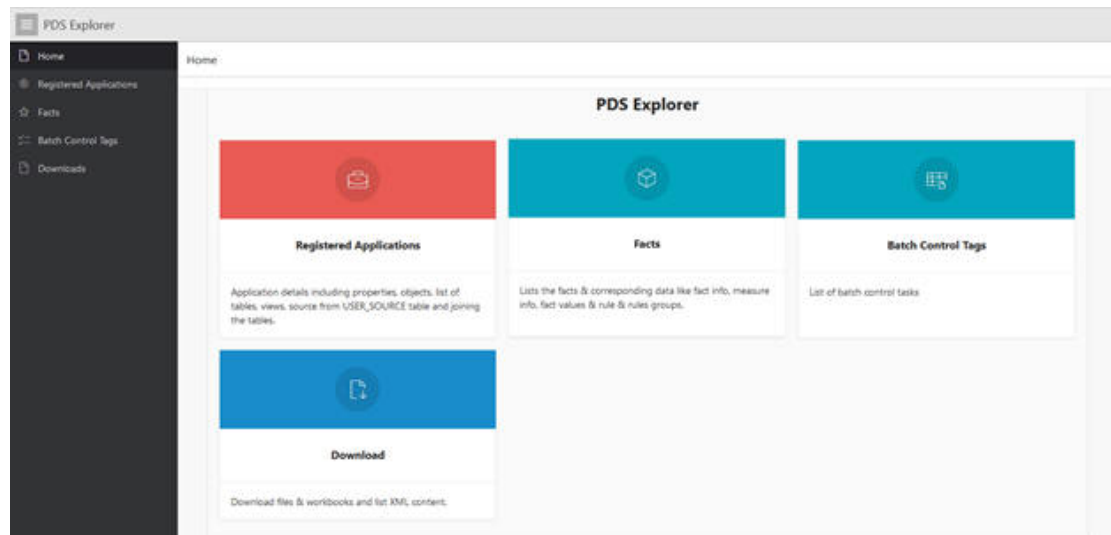

Click the appropriate card to access each page.

- Registered Applications - the applications that are registered in the PDS.
- Facts - details about the facts and their associated data.
- Batch Control Tags - a list of the batch control tags.
- Downloads - the files available for download.

Registered Applications

The Application Details page, shown in [Figure 13-2](#), has two tabs: Applications and History.

Figure 13-2 Application Details Page with the Applications Tab

R App Id	R Deploy Id	App Name	App State
0	app1	asics	register
1	app33	bootstrap	preregister
2	app2	rdf	register
			Total 3

The Applications tab, shown in [Figure 13-2](#), lists the applications, along with App ID, the Deploy ID, the App Name, and the App State.

The History tab, shown in [Figure 13-3](#), provides details about the PDS Upgrade history and the Config Patch history.

Figure 13-3 Application Details Page with the History Tab

Event Id	Schema Version	Rpsn Version	Last Dev Tag	Utility	Action	Time Taken
0	1	22.2.303.00.04.1463	2022062600	rdm4gr	Create	+00000000-00:00:00.000000000
1	1	22.2.481.00.01.1465	2022081300	upgradeRdm	Load SQL Packages	+00000000-00:00:00.000000000
2	1	22.2.481.00.01.1465	2022081300	upgradeRdm	Update	+00000000-00:00:00.000000000
						Total 3

Facts

The Fact Details page has three tabs: Fact Data, Dimensions, and Levels.

Fact Data

The Fact Data tab, shown in [Figure 13-4](#), displays information about facts and associated data.

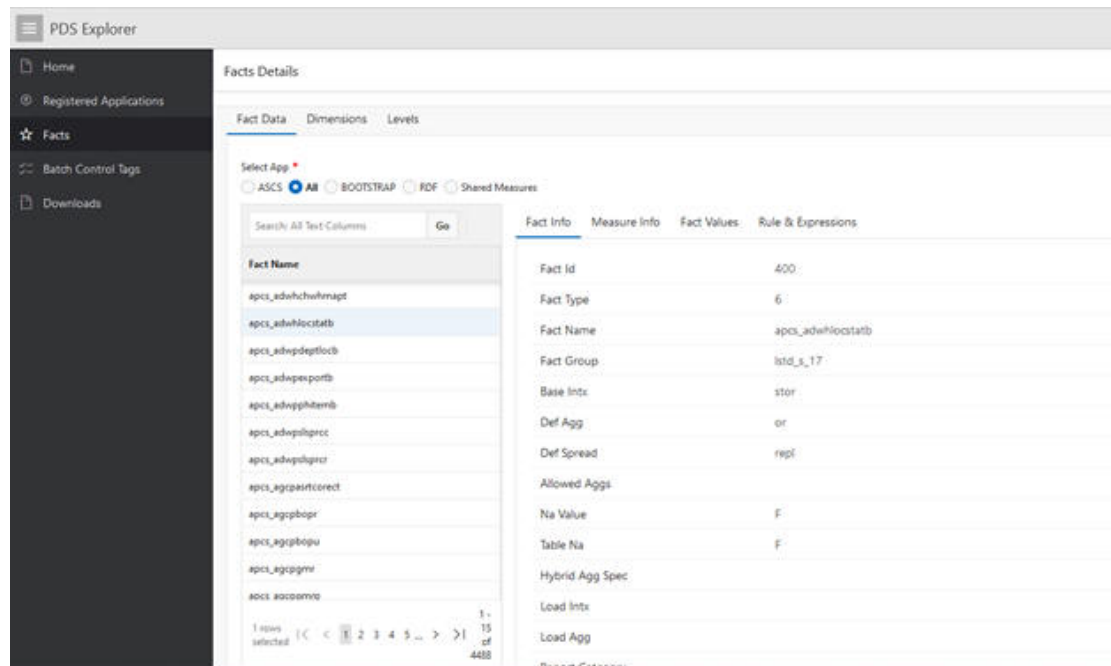
Figure 13-4 Fact Details Page with the Fact Data Tab and Fact Info Sub-Tab

You can filter the facts to be displayed by enabling the button for a specific application.

The Fact Data tab has four sub-tabs: Fact Info, Measure Info, Fact Values, and Rules & Expressions.

Fact Info

This sub-tab displays the details for the selected fact, including the Fact Name, Fact Group, Base Intersection, and NA Value, as shown in [Figure 13-4](#).

Measure Info

This sub-tab displays the details shown in [Figure 13-5](#) for the selected fact, including ID information.

Figure 13-5 Fact Details Page with the Fact Data Tab and Measure Info Sub-Tab

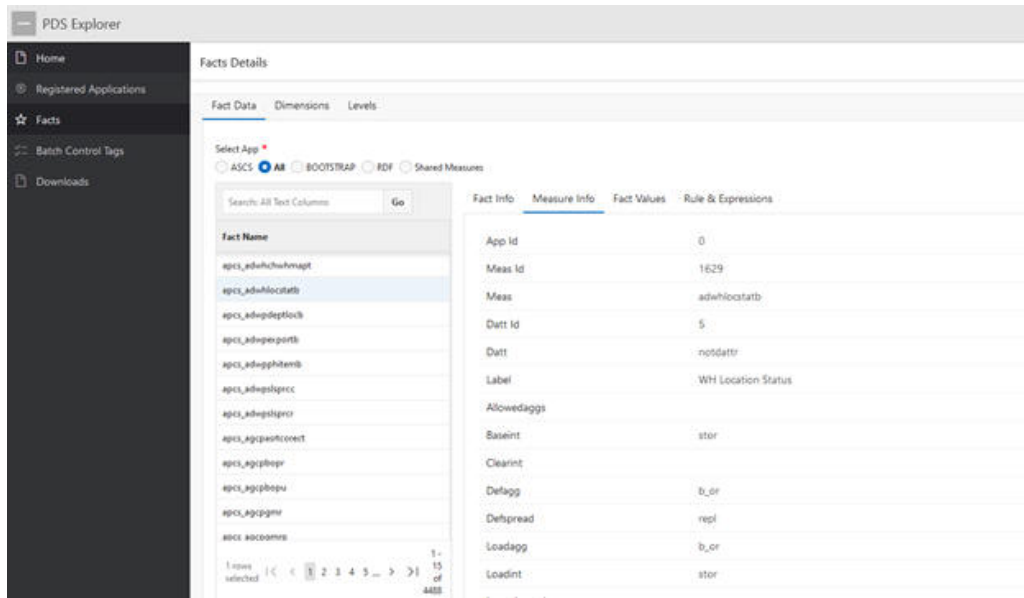

Fact Values

This sub-tab displays the values for the selected fact, as shown in Figure 13-6. The base intersection of the fact is taken into consideration and the associated values are displayed in tabular format. The fact values can be filtered based on the level values.

Figure 13-6 Fact Details Page with the Fact Data Tab and Fact Values Sub-Tab

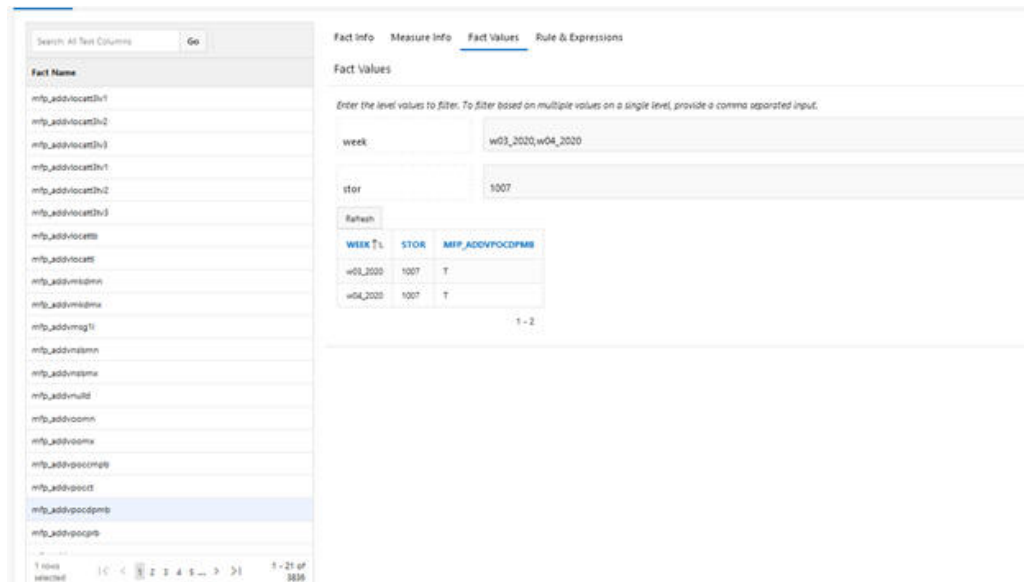

Rules & Expressions

This sub-tab, shown in Figure 13-7 lists all the rules and expressions in which the selected fact is used.

Figure 13-7 Fact Details Page with the Fact Data Tab and Rules & Expressions Sub-Tab

The screenshot shows the PDS Explorer interface. On the left is a navigation sidebar with options: Home, Registered Applications, Facts, Batch Control Tags, and Downloads. The main area is titled 'Facts Details' and has three tabs: Fact Data, Dimensions, and Levels. The 'Fact Data' tab is active, and the 'Rule & Expressions' sub-tab is selected. Below the sub-tab, there is a search bar and a table with columns: App ID, Rule ID, Seq Num, Rule, and Expression. The table contains five rows of data.

App ID	Rule ID	Seq Num	Rule	Expression
0	176	1	adhlocstab_agg	ADHLocStab = # (ADHLocStab = "Closed" & ADHLocStab & ADHLocStab) ? Yes, No
0	306	1	adhlocstab_rpt	ADHONMMagB = ADHLocStab
0	307	1	adhlocstab_calc	ADHONMMagT = # (ADHLocStab, DRDValT, attribute("tab"), Div(1+0))
0	308	1	adhlocstab_calc	ADHONMMagT = # (ADHLocStab, ADHONMMagT, DRDValT)
0	309	1	adhlocstab_agg	ADHLocStab.level(Div(1+0)) = # (getfrom(Div(1+0)) = "W", true, false)

Dimensions

The Dimensions tab, shown in [Figure 13-8](#), displays the Partition Dimension and the Partition Count. When the user selects a dimension from the list of dimension names, the adjacent table displays the Level ID, Dimension ID, Dimension Name, Agg From, Partition Format, and Virtual Level for that dimension.

Figure 13-8 Dimensions Tab

The screenshot shows the PDS Explorer interface with the 'Dimensions' tab selected. It displays a 'Partition Dimension' section with a search bar and a list of dimension names. A 'Partition Count' section shows a count of 3. Below these is a table with columns: Level ID, Level Name, Dimension ID, Dimension Name, Agg From, Partition Format, and Virtual Level. The 'dept' dimension is selected, and its details are shown in the table.

Level ID	Level Name	Dimension ID	Dimension Name	Agg From	Partition Format	Virtual Level
03	day	2	dept	day		
4	year	2	dept	year		
5	half	2	dept	year		
6	qtr	2	dept	month		
7	month	2	dept	week		
8	half	2	dept	week		
9	year	2	dept	week		
10	year	2	dept	week		
11	half	2	dept	week		
12	year	2	dept	week		
13	week	2	dept	day		
14	day	2	dept		YYYYMMDD	

Levels

The Levels tab displays the Level Details for the selected level, as shown in [Figure 13-9](#).

Figure 13-9 Levels Tab

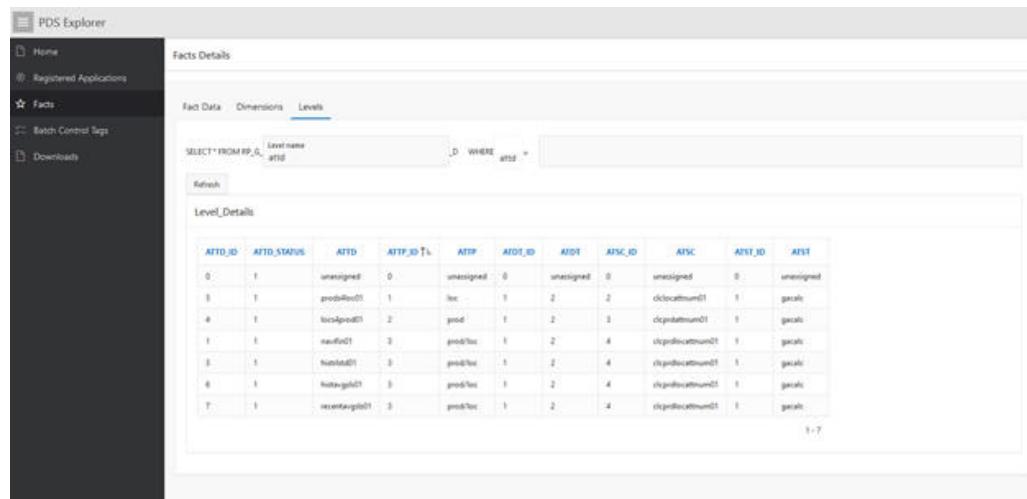

Batch Control Tags

The Batch Control Tags page, shown in Figure 13-10, lists the batch control tags.

Figure 13-10 Batch Control Tags Page

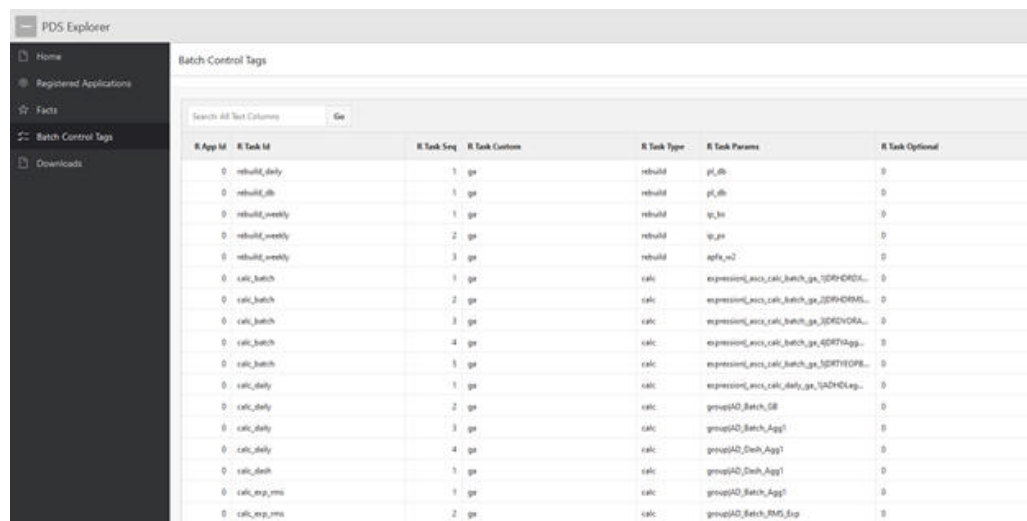

Downloads

The Downloads page, shown in Figure 13-11, has one tab: Files. This tab lists the files, such as xml, template, and compressed rdm folder, that can be downloaded by clicking **Download**.

Figure 13-11 Downloads Page with File Tab

The screenshot shows the 'Downloads' page in PDS Explorer. On the left is a navigation sidebar with options: Home, Registered Applications, Facts, Batch Control Tags, and Downloads. The main area displays a table of downloaded files. The table has four columns: 'App Id', 'File Type', 'File Name', and 'File Content'. Each row represents a downloaded file, with a 'Download' link in the 'File Content' column.

App Id	File Type	File Name	File Content
2	report	style/style.xml	Download
2	report	templateStyles/attm401.xml	Download
2	report	templateStyles/bafflowm.xml	Download
2	report	templateStyles/cst_f401.xml	Download
2	report	templateStyles/cstbrev01.xml	Download
2	report	templateStyles/cstma.xml	Download
2	report	templateStyles/workbook0.xml	Download
2	report	templates/LC/cst_f401.html.rtf	Download
2	report	templates/LC/cstbrev01.html.rtf	Download
2	report	templates/NewItems/Items.html.rtf	Download
2	report	templates/NewItems/Items.html.rtf	Download
2	report	templates/RuleEng/attm401.html.rtf	Download
2	report	templates/RuleEng/qsadm.html.rtf	Download
2	report	templates/RuleEng/subseq01.html.rtf	Download
2	report	templates/Unassigned/pt_01.html.rtf	Download

RPASCE Test Automation

This chapter describes an RPASCE utility called "rpc" (RPASCE Pluggable Automation Component). It can be used to perform various tests on an existing application, based on a set of test cases contained in XML files.

This appendix contains the following sections:

- [Introduction](#)
- [RPAC in Batch Framework](#)
- [Writing Test Cases](#)
- [Example](#)
- [Output](#)
- [Schema](#)

Introduction

The rpc utility is used to run highly customizable automated test suites for the RPASCE server. The XML-based framework allows rapid development of tests and ensures that test cases can be quickly copied across locations. The flexible XML schema allows the user to test a large number of RPASCE features, such as writing data to PDS, building a workbook, running custom menu options, and verifying the results.

The XML framework also introduces consistency, accuracy, and reproducibility in the test results. To reproduce a test case, all that is needed is the XML file and a copy of PDS.

Note that rpc operates directly against the PDS itself and therefore does not test any Client/Server interactions.

RPAC in Batch Framework

The rpc utility is supported for use with enterprise deployments. RPAC tests are specified in XML-format text files and cover a range of RPASCE PDS and Workbook activities. In order to support the validation of a newly installed or patched environment, in the context of configured daily or weekly batch operations, RPAC for Cloud deployments are supported through new entries in the EE Batch task catalog. These tasks allow a pre-production PDS to be set to a known state through a combination of dimension load and fact load files; then both application and Workbook measures can then be compared to known values represented either directly in the test XML files or in data comparison files (similar to a measure data load file, but used only for comparison rather than for loading).

Three types of collateral files are involved in the RPAC testing process:

- **Input data file set:** a group of hierarchy (.dat) and measure (.ovr, .clr, or .rpl) data files that should be loaded into the PDS before any RPAC tests are run. Uploaded to Object Storage in the rpc directory as input.zip.

- **Test file set:** one or more .xml files where tests and test suites are defined using the available set of RPAC tags and attributes. Uploaded to Object Storage in the rpac directory as tests.zip.
- **Comparison data file set:** an optional way to efficiently validate that one or more measures currently contain an expected set of values. Uploaded to Object Storage in the rpac directory as compare.zip.

Each of these collateral file archives, once uploaded to Object Storage, will be kept internally to be used every time an RPAC-enabled batch execution sequence is run. Updates to the collateral files can be uploaded to Object Storage before the next call of the initrpc batch task and will be brought into the active environment at that time. Note that when any of the collateral file archives is updated, the previous contents are entirely removed from the internal storage area, so the replacement archive file must be a complete set of files of that type. (This prevents stale test scripts or data files from being left in the environment.)

The two EE Batch tasks, initrpc and runrpc, are detailed in the batch task catalog in "Initialize Testing Environment: initrpc" and "Execute Automated Tests: runrpc" in the Implementation Guide. The initrpc task is expected to be run once, at the start of the RPAC-enabled batch exec sequence; the runrpc task can be called multiple times, including at separate points during the batch exec sequence, if needed. Here is an example batch execution sequence that shows how an existing weekly batch specification might be augmented with RPAC tests:

```
# Standard Weekly Batch Cycle
weekly | unpack | weekly_sales.zip~ftp
weekly | hierload | prod~14~N
weekly | hierload | loc~14~N
weekly | measload | load_oo_list
weekly | calc | batch_fcst
weekly | autobuild |
# RPAC-enhanced Batch Cycle
validate | initrpc |
validate | hierload | prod~14~N
validate | hierload | loc~14~N
validate | measload | load_oo_list
validate | runrpc | RPAC_Tests~Tests.xml
validate | calc | batch_fcst
validate | runrpc | RPAC_Workbook_Tests~WorkbookTests.xml
```

The first section, labeled "weekly", represents a weekly batch sequence that might run at midnight every Saturday. Note that updated hierarchy and measure data files for the week are uploaded to Object Storage in an archive file named "weekly_sales.zip" using the unpack task.

The second section shows how the weekly batch sequence has been augmented with RPAC tests and named "validate". Note that the unpack task from the weekly sequence has been left out, and in its place initrpc is called to place the test data input files into the PDS. If new or updated RPAC test collateral files have been uploaded to Object Storage, they will be brought in at this point and used.

There are two sets of RPAC tests in this sequence, specified by the runrpc task entries. The first runs immediately after the hierarchy and measure files are loaded, and validates expected values in the PDS. The second test set is executed after some further calculations have been run, and builds one or more workbooks, then validates values within them as well.

When RPAC-enabled batch sequences are run, the primary log file (available through the Online Administration dashboard as well as through the log archive package uploaded to Object Storage) will show a brief summary of test results. Full test details and log files are available in the complete log archive package from the batch exec run, available in Object Storage once the execution has completed.

Note that the latest version of this guide specifies which RPAC features are available for Cloud deployments. Due to Cloud security constraints, some RPAC features, primarily the <SHELL> tag, have been disabled; however, inclusion of RPAC tests as a step in existing batch execution sequences should fully compensate for this restriction.

Writing Test Cases

The structure of an rpac test script is defined by the following tags.

Table 14-1 Test Case Tags

Tag	Description
<testscript>	The outermost tag for the test script. This tag contains one or more <testsuite> tags.
<testsuite>	This tag defines a suite of tests that are designed to run together. Each suite contains its own <setup>, <teardown>, <testcase>, and <workbook-operations> tags. This tag has a name attribute that can be used with the -suite command line attribute to specify which suites are executed in this run.
<once>	The once tag contains tag elements used to set up the environment once before the first test case is executed. It is a tag like setup, but only happens once at the start of a test suite. The once tag has been added to allow a set of measures to be backed up once during the run of the test suite.
<finalize>	The finalize tag contains tag elements used to restore the environment after the final test case is executed.
<setup>	This tag sets the preconditions that are common to all test cases. Operations inside this tag are run before every test case is executed. Example operations: <ul style="list-style-type: none"> • Set RpasToday so the test date is consistent for every test run. • Pre-set measure values so tests operate in a known state. • Check any preconditions to make sure this test run is valid.
<teardown>	This tag contains cleanup code that is run after all test cases. Operations inside this tag are run after every test case is executed. This is used to restore PDS or a workbook to its default state to remove dependencies between independent test cases. Example operations: <ul style="list-style-type: none"> • Set measure values back to their initial state. • Run batch scripts to remove any test-specific files that were generated.
<testcase>	This tag is where the code to perform each test goes. It should perform operations, then use the assert tags to verify the results. The name of this tag is used in the output to log timing results and success/failure. Note: Code in the <setup> tag is executed prior to each test case, and code in the <teardown> tag is executed after each test case.

Some tags handle access to an Oracle SQL database. These tag require an access role name. The tag testsuite has an optional attribute role used to set the database access role. Valid database role values are data_mart, patch, batch, dimload, factload, hiermgr, wkbk, rdonly, etl, report, and bdi.

The role assigned to the testsuite tag affects all test cases, and if no role is assigned to once, setup, and teardown, the role assigned to the testsuite tag will affect these tags as well. A role assigned to the once tag is applied to the tags contained in once, and if no role is assigned to setup and teardown, then this role will apply to these tags as well. A role assigned to the setup tag is applied to the tags contained in setup, and if no role is assigned to teardown, then this role will apply to teardown as well. A role assigned to the teardown tag only applies to the tags contained in teardown.

If a role is required for a test suite and the test suite does not have a valid role attribute, then RPAC will throw an error.

It is recommended that the teardown section restore the application to its previous state. This removes dependencies between test cases and ensures consistency from one run to the next.

The tags once, setup, and teardown are unique. Only the first occurrence of each of these tags is used. These tags can appear in any order under the testsuite tag, and all of these tags are optional. The code contained in these tags is executed at a set point during the run of unit test code. However, for the tag testcase, the order of occurrence in the testsuite is the order of execution.

Example

This section provides a sample XML file that contains some rpac tests that run against an MFP application. This test illustrates how the setup and teardown methods work, as well as how to use the various workbook operations.

The first test case demonstrates building the workbook. The test makes the wizard selections and builds the workbook. Once the workbook is built, an assertion verifies that the load rules correctly set the workbook value.

Once this test case is complete, the teardown code is executed, along with the setup code for the next test case. The test verifies that the teardown code correctly set the workbook's measure value to false and then issues a commit. Once the workbook is committed, the measure value is checked to see if it was properly updated. Once again, the teardown code is executed and the setup code is run at the beginning of the next test case.

For the third test case, the setup code should have initialized the measure value back to true, and the workbook value back to false. The test case verifies these operations, then performs a workbook refresh and verifies that the workbook value has been correctly set to true.

After that, the workbook is closed and the test suite is complete.

Note:

Because the teardown code modifies workbook data, the workbook close step cannot be encapsulated inside of a test case. If it was, the teardown code would try to modify a workbook that was no longer there and produce a failing result.

```
<testsuite name="Workbook Operations Tags" role="wkbk">  
  <once>
```

```
<rpas-today>20070122</rpas-today>
</once>

<finalize>
  <workbook-operations>
    <close/>
  </workbook-operations>
</finalize>

<!-- Setup executed at the beginning of every testcase -->
<setup>
  <set-application-measure name="[MEAS]" namedkeys="[NKEY]" value="true"/>
</setup>

<!-- Teardown executed at the end of every testcase -->
<teardown>
  <edit-workbook-measure name="[MEAS]" namedkeys="[NKEY]" value="false"/>
</teardown>

<testcase name="Workbook Build">
  <!-- Build Merch Plan workbook -->
  <workbook-operations>
    <build template-name="MP_WB" label="Merch Plan" user="adm">
      <wizard-page-settings id="wiz_MP_WBhalf">
        <set-tree-selections control-name="tree1" dim-name="half" rollup-
name="half">
          h1_2022
        </set-tree-selections>
      </wizard-page-settings>
      <wizard-page-settings id="wiz_MP_WBchnl">
        <set-tree-selections control-name="tree1" dim-name="chnl" rollup-
name="chnl">
          1
        </set-tree-selections>
      </wizard-page-settings>
      <wizard-page-settings id="wiz_MP_WBdept">
        <set-tree-selections control-name="tree1" dim-name="dept" rollup-
name="dept" >
          300
        </set-tree-selections>
      </wizard-page-settings>
    </build>
  </workbook-operations>
  <!-- Validate the load rule worked correctly -->
  <assert-workbook-measure-value-eq name="[MEAS]" namedkeys="[NKEY]" value="true"/>
</testcase>

<!-- Commit the workbook and assert the measure values in pds-->
<testcase name="Enable OP Approval Workbook: Commit">
  <assert-application-measure-value-eq name="[MEAS]" namedkeys="[NKEY]" value="true"/>
  <assert-workbook-measure-value-eq name="[MEAS]" namedkeys="[NKEY]" value="false"/>
  <workbook-operations>
    <commit type="now" template-name="EnableOp" user="adm"/>
  </workbook-operations>
  <!-- Validate the commit rule worked correctly -->
  <assert-application-measure-value-eq name="[MEAS]" namedkeys="[NKEY]"
value="false"/>
</testcase>

<!-- Refresh the workbook and assert measure values in workbook and pds-->
<testcase name="Enable OP Approval Workbook: Refresh">
```

```

    <assert-application-measure-value-eq name="[MEAS]" namedkeys="[NKEY]"
value="true"/>
    <assert-workbook-measure-value-eq name="[MEAS]" namedkeys="[NKEY]"
value="false"/>
    <workbook-operations>
        <refresh user="adm"/>
    </workbook-operations>
    <!-- Validate the refresh rule worked correctly -->
    <assert-workbook-measure-value-eq name="[MEAS]" namedkeys="[NKEY]"
value="true"/>
</testcase>
</testsuite>
</testsuite>

```

Output

The `rpac` command now has a switch to create an HTML document of its tags and their usage. The HTML document `rpac.html` for RPAC is contained in the `RPAS_HOME/doc/rpac` directory.

When RPAC executes, it prints the status of the current execution to the console. Once all the test cases are complete, the summary of test cases is stored in `unittest.log` and `unittest.xml` under the current directory. The content of this simple text file `unittest.log` for a working example will be:

```

ran 3 tests: 0 skips: 0 errors, 0 failures in 1 minute 9.92 seconds for
RPAC (LDIP): RPAS_UT Tests

```

And for `unittest.xml`:

```

<unittest elapsedTime="1 minute 9.92 seconds" name="RPAC (LDIP): RPAS_UT Tests"
os="Windows" runcount="3" timestamp="2018-11-16 11:17:29"
version="18.0.002.00.001">
</unittest>

```

If something goes wrong the output for `unittest.log` will be:

```

ran 3 tests: 0 skips: 1 errors, 0 failures in 1 minute 9.20 seconds for
RPAC (LDIP): RPAS_UT Tests

```

Errors:

```

    TestName: MFP RPAC Test 11.Enable OP Approval Workbook: Commit
    Exception: TestCase got OciNamedException: Test/testcases/rpac.xml at line
19 for suite 'MFP RPAC Test 11'.
throw at line 414 of file
'd:\usr\rpas\edgetrunk\rpas\11\libraries\rpas\private\sqlsession.cpp'
    Location: 90 'testcases/rpac.xml'

```

And for `unittest.xml`:

```

<unittest elapsedTime="1 minute 9.20 seconds" name="RPAC (LDIP): RPAS_UT Tests"
os="Windows" runcount="3" timestamp="2018-11-16 12:01:03"
version="18.0.002.00.001">
    <errorlist>
        <error>
            <testname>MFP RPAC Test 11.Enable OP Approval Workbook: Commit</testname>
            <exception>TestCase got OciNamedException: Test/testcases/rpac.xml at
line 19 for suite &apos;MFP RPAC Test 11&apos;.
throw at line 414 of file
&apos;d:\usr\rpas\edgetrunk\rpas\11\libraries\rpas\private\sqlsession.cpp

```



```

    &apos;</exception>
        <file>testcases/rpac.xml</file>
        <line>90</line>
    </error>
</errorlist>
</unittest>

```

Schema

This section provides schema details.

RPAC Attributes, Values, and Variables

All HTML tags may contain attributes and values. RPAC does an initial processing of the attributes and tag value strings. This initial processing replaces any occurrence of the string enclosed with square brackets with the current variable matching the enclosed string. For example the string "Rpas Today is [RPAS_TODAY]" would be replaced with "Rpas Today is 20180802" if either the process environmental variable "RPAS_TODAY" had the value of "20180802" or the RPAC tag "set-environment-variable" had been used to set the variable "RPAS_TODAY" to the value of "20180802".

There are environment variables internal to RPAC "[RPAC_DATE]", "[RPAC_DATA]", "[RPAC_WORK]", "[RPAC_TEST_SUITE]", "[RPAC_TEST_CASE]", "[PLATFORM]", "[PDS_PATH]", "[PDS_NAME]", "[PDS_ID]", "[SEGMENT_ID]", "[WORKBOOK_NAME]" and "[TASK_ID]".

These internal environment variables cannot be changed using the RPAC tag set-environment-variable. And these variables are not normally exported to any processes RPAC is requested to start. For a process that RPAC is requested to start to see any internal RPAC variables use the set-environment-variable. For example:

```
<set-environment-variable name="RPAC_PDS_PATH" value="[PDS_PATH]" export="true"/>
```

This tag will export the internal "PDS_PATH" to the environmental variable "RPAC_PDS_PATH".

The internal environment variable "[RPAC_DATE]" always returns the current date/time as a string value. The format of the data time string can be changed using the RPAC tag "set-date-format". The default format is "%Y%m%d".

The internal environment variable "[RPAC_DATA]" is the location of the input directory known to RPAC.

The internal environment variable "[RPAC_WORK]" is the location of the output directory known to RPAC.

The internal environment variable "[RPAC_TEST_SUITE]" is name of the current test suite.

The internal environment variable "[RPAC_TEST_CASE]" is name of the current test case.

The internal environment variable "[PDS_PATH]" is the location of the PDS directory.

The internal environment variable "[PDS_NAME]" is the application name for PDS.

The internal environment variable "[PDS_ID]" is the application id for PDS.

The internal environment variable "[DEPLOY_ID]" is the deploy id for PDS.

The internal environment variable "[PLATFORM]" contains either the string "Windows" or the string "Linux" based on the platform RPAC is running on.

The internal environment variable "[SEGMENT_ID]" is segment id of the last workbook build.

The internal environment variable "[WORKBOOK_NAME]" is name of the current workbook or blank if there is no current workbook.

The internal environment variable "[TASK_ID]" is the current task Id of the last task started.

The internal variables "[WORKBOOK_NAME]", and "[SEGMENT_ID]" will be updated after workbook "build" tag is executed.

The internal variables "[TASK_ID]" will be updated after RPAC starts any tasks.

The "set-environment-variable" can be used to copy one environment variable into another environment variable.

1. RPAC Structure Tag

This section provides details about the top-level parent tag.

1.1 testscript

The testscript is the top-level tag, which contains all the rpac tags.

1.2 testsuite

The testsuite contains setup, teardown, and testcase tag elements.

Table 14-2 Testsuite

Attribute	Required	Description
name	Yes	Name of the test suite
role	No	Role of the test suite
category	No	Category name; light, normal, intense, performance, or debug
stop-on-failure	No	Boolean to indicate if test suite should exit when error or failure occurs (Defaults to false)
skip	No	Skip this tag if true (defaults to false)
stop	No	Stop rpac execution if true (defaults to false)
debug	No	Wait for debugger if true (defaults to false)

1.3 testcase

The testcase contains a list of tag elements to be executed.

Table 14-3 Testcase

Attribute	Required	Description
name	Yes	Name of the test case
category	No	Category name; light, normal, intense, performance, or debug
exception	No	Expected exception
role	No	Role of the contain tags (defaults to role of testSuite)
skip	No	Skip this tag if true (defaults to false)
stop	No	Stop rpac execution if true (defaults to false)
debug	No	Wait for debugger if true (defaults to false)

1.4 once

The once tag contains tag elements used to set up the environment once before the first test case is executed.

Table 14-4 Once

Attribute	Required	Description
role	No	Role of the contain tags (defaults to role of testSuite)
skip	No	Skip this tag if true (defaults to false)
stop	No	Stop rpac execution if true (defaults to false)
debug	No	Wait for debugger if true (defaults to false)

Example:

```
<once>
  <set-environment-variable name="DBPATH" value="data/rpacTest"/>
</once>
```

1.5 finalize

The finalize tag contains tag elements used to restore the environment after the final test case is executed.

Table 14-5 Finalize

Attribute	Required	Description
role	No	Role of the contain tags (defaults to role of testSuite)
skip	No	Skip this tag if true (defaults to false)
stop	No	Stop rpac execution if true (defaults to false)
debug	No	Wait for debugger if true (defaults to false)

1.6 setup

The setup tag contains tag elements used to set up the environment before each test case is executed. These can include initializing measure values, setting the date, or running batch scripts to prepare the application.

Table 14-6 Setup

Attribute	Required	Description
role	No	Role of the contain tags (defaults to role of testSuite)
skip	No	Skip this tag if true (defaults to false)
stop	No	Stop rpac execution if true (defaults to false)
debug	No	Wait for debugger if true (defaults to false)

1.7 teardown

The teardown tag contains tag elements used to restore the environment to a default state after each test case is executed. This can include returning measures to their default values or running batch scripts to clean up the application.

Table 14-7 Teardown

Attribute	Required	Description
role	No	Role of the contain tags (defaults to role of testSuite)
skip	No	Skip this tag if true (defaults to false)
stop	No	Stop rpac execution if true (defaults to false)
debug	No	Wait for debugger if true (defaults to false)

2. Application Measure Tags

This section provides details about application measure tags.

2.1 assert-application-measure-exists

This tag asserts an application measure exists.

Table 14-8 assert-application-measure-exists

Attribute	Required	Description
name	Yes	Application measure name
skip	No	Skip this tag if true (defaults to false)
stop	No	Stop rpac execution if true (defaults to false)
debug	No	Wait for debugger if true (defaults to false)

Example:

```
<assert-application-measure-exists name="[mpwpgmmx]"/>
```

2.2 assert-application-measure-intx

This tag asserts a application measure base intersection matches an expected value.

Table 14-9 assert-application-measure-intx

Attribute	Required	Description
name	Yes	Application measure name
intx	Yes	Intersection string to compare with
skip	No	Skip this tag if true (defaults to false)
stop	No	Stop rpac execution if true (defaults to false)
debug	No	Wait for debugger if true (defaults to false)

Example:

```
<assert-application-measure-intx name="[mpwpgmmx]" intx="chnlscls"/>
```

2.3 assert-application-measure-value-eq

This tag asserts a application measure value is equal to an expected value.

Table 14-10 assert-application-measure-value-eq

Attribute	Required	Description
name	Yes	Application measure name
value	No	Expected value of application measure. (Defaults to NA). Date value must be provided in one of six formats '%Y%m%d%H%M%S', '%Y%m%d%H%M', '%Y%m%d', '%m/%d/%Y %H:%M:%S', '%m/%d/%Y %H:%M', or '%m/%d/%Y'. For boolean measure valid values are 't' or 'true' of any case while all other values are false.
precision	No	The number of decimal places to be considered for assertion
namedkeys	No	List of colon separated position names
skip	No	Skip this tag if true (defaults to false)
stop	No	Stop rpac execution if true (defaults to false)
debug	No	Wait for debugger if true (defaults to false)

Example:

```
<testcase>
  <assert-application-measure-value-eq name="r_ex_demoa"
    namedkeys="w02_2009,w03_2009,w04_2009:dept03:str1000" value="10"/>
</testcase>
```

2.4 assert-application-measure-value-ge

This tag asserts a application measure value is greater than or equal to an expected value.

Table 14-11 assert-application-measure-value-ge

Attribute	Required	Description
name	Yes	Application measure name
value	No	Expected value of application measure. (Defaults to NA). Date value must be provided in one of six formats '%Y%m%d%H%M%S', '%Y%m%d%H%M', '%Y%m%d', '%m/%d/%Y %H:%M:%S', '%m/%d/%Y %H:%M', or '%m/%d/%Y'. For boolean measure valid values are 't' or 'true' of any case while all other values are false.
precision	No	The number of decimal places to be considered for assertion
namedkeys	No	List of colon separated position names
skip	No	Skip this tag if true (defaults to false)
stop	No	Stop rpc execution if true (defaults to false)
debug	No	Wait for debugger if true (defaults to false)

Example:

```
<assert-application-measure-value-ge name="r_ex_demoa"
namedkeys="w02_2009,w03_2009,w04_2009:dept03:str1000" val
```

2.5 assert-application-measure-value-gt

This tag asserts a application measure value is greater than an expected value.

Table 14-12 assert-application-measure-value-gt

Attribute	Required	Description
name	Yes	Application measure name
value	No	Expected value of application measure. (Defaults to NA). Date value must be provided in one of six formats '%Y%m%d%H%M%S', '%Y%m%d%H%M', '%Y%m%d', '%m/%d/%Y %H:%M:%S', '%m/%d/%Y %H:%M', or '%m/%d/%Y'. For boolean measure valid values are 't' or 'true' of any case while all other values are false.
precision	No	The number of decimal places to be considered for assertion
namedkeys	No	List of colon separated position names
skip	No	Skip this tag if true (defaults to false)
stop	No	Stop rpc execution if true (defaults to false)
debug	No	Wait for debugger if true (defaults to false)

Example:

```
<assert-application-measure-value-gt name="r_ex_demoa"
namedkeys="w02_2009,w03_2009,w04_2009:dept03:str1000" value="10"/>
```

2.6 assert-application-measure-value-le

This tag asserts a application measure value is less than or equal to an expected value.

Table 14-13 assert-application-measure-value-le

Attribute	Required	Description
name	Yes	Application measure name
value	No	Expected value of application measure. (Defaults to NA). Date value must be provided in one of six formats '%Y%m%d%H%M%S', '%Y%m%d%H%M', '%Y%m%d', '%m/%d/%Y %H:%M:%S', '%m/%d/%Y %H:%M', or '%m/%d/%Y'. For boolean measure valid values are 't' or 'true' of any case while all other values are false.
precision	No	The number of decimal places to be considered for assertion
namedkeys	No	List of colon separated position names
skip	No	Skip this tag if true (defaults to false)
stop	No	Stop rpac execution if true (defaults to false)
debug	No	Wait for debugger if true (defaults to false)

Example:

```
<assert-application-measure-value-le name="r_ex_demoa"
namedkeys="w02_2009,w03_2009,w04_2009:dept03:str1000" value="10"/>
```

2.7 assert-application-measure-value-lt

This tag asserts a application measure value is less than an expected value.

Table 14-14 assert-application-measure-value-lt

Attribute	Required	Description
name	Yes	Application measure name
value	No	Expected value of application measure. (Defaults to NA). Date value must be provided in one of six formats '%Y%m%d%H%M%S', '%Y%m%d%H%M', '%Y%m%d', '%m/%d/%Y %H:%M:%S', '%m/%d/%Y %H:%M', or '%m/%d/%Y'. For boolean measure valid values are 't' or 'true' of any case while all other values are false.
precision	No	The number of decimal places to be considered for assertion
namedkeys	No	List of colon separated position names
skip	No	Skip this tag if true (defaults to false)
stop	No	Stop rpac execution if true (defaults to false)
debug	No	Wait for debugger if true (defaults to false)

Example:

```
<assert-application-measure-value-lt name="r_ex_demoa"
namedkeys="w02_2009,w03_2009,w04_2009:dept03:str1000" value="10"/>
```

2.8 assert-application-measure-value-ne

This tag asserts a application measure value is not equal to an expected value.

Table 14-15 assert-application-measure-value-ne

Attribute	Required	Description
name	Yes	Application measure name
value	No	Expected value of application measure. (Defaults to NA). Date value must be provided in one of six formats '%Y%m%d%H%M%S', '%Y%m%d%H%M', '%Y%m%d', '%m/%d/%Y %H:%M:%S', '%m/%d/%Y %H:%M', or '%m/%d/%Y'. For boolean measure valid values are 't' or 'true' of any case while all other values are false.
precision	No	The number of decimal places to be considered for assertion
namedkeys	No	List of colon separated position names
skip	No	Skip this tag if true (defaults to false)
stop	No	Stop rpac execution if true (defaults to false)
debug	No	Wait for debugger if true (defaults to false)

Example:

```
<assert-application-measure-value-ne name="r_ex_demoa"
namedkeys="w02_2009,w03_2009,w04_2009:dept03:str1000"/>
```

2.9 assert-application-measures-match

This tag asserts application measures have matching content. The content of this tag can limit the comparison to a sub-set of the measure data. The format is DimName0:dim0pos0,dim0pos1,dim0pos3|DimName1:dim1pos0. Which is N number of dimension/positions lines with a vertical bar separator. Each dimension/positions lines has a dimension name followed by a colon separator and N position names with a comma separator between each name. This is an optional value.

Table 14-16 assert-application-measures-match

Attribute	Required	Description
lhs-measure	Yes	LHS measure used for comparison
rhs-measure	Yes	RHS measure used for comparison
output-file	No	Output file name containing list of differences (Defaults to unique name base on tag line number and xml file name containing tag).
max-diffs	No	Maximum number of differences allow before stopping match (defaults to 32)
skip	No	Skip this tag if true (defaults to false)
stop	No	Stop rpac execution if true (defaults to false)
debug	No	Wait for debugger if true (defaults to false)

Example:

```
<testcase>
  <assert-application-measures-match lhs-measure="rm1" rhs-measure="rm2">
    week:w45_2009,w46_2009,w47_2009|sku:sku_22200001,sku_22200002
  </assert-application-measures-match>
  <assert-application-measures-match lhs-measure="rm1" rhs-measure="rm2"/>
</testcase>
```

2.10 assert-application-popcount-value-eq

This tag asserts a application pop count is equal to an expected value.

Table 14-17 assert-application-popcount-value-eq

Attribute	Required	Description
name	Yes	Application measure name
pop-count	No	Expected popcount (Defaults to zero)
skip	No	Skip this tag if true (defaults to false)
stop	No	Stop rpac execution if true (defaults to false)
debug	No	Wait for debugger if true (defaults to false)

Example:

```
<assert-application-popcount-value-eq name="r_ex_demoa" pop-count="1"/>
```

2.11 assert-application-popcount-value-ge

This tag asserts a application pop count is greater than or equal to an expected value.

Table 14-18 assert-application-popcount-value-ge

Attribute	Required	Description
name	Yes	Application measure name
pop-count	No	Expected popcount (Defaults to zero)
skip	No	Skip this tag if true (defaults to false)
stop	No	Stop rpac execution if true (defaults to false)
debug	No	Wait for debugger if true (defaults to false)

Example:

```
<assert-application-popcount-value-ge name="r_ex_demoa" pop-count="1"/>
```

2.12 assert-application-popcount-value-gt

This tag asserts a application pop count is greater than an expected value.

Table 14-19 assert-application-popcount-value-gt

Attribute	Required	Description
name	Yes	Application measure name
pop-count	No	Expected popcount (Defaults to zero)
skip	No	Skip this tag if true (defaults to false)
stop	No	Stop rpac execution if true (defaults to false)
debug	No	Wait for debugger if true (defaults to false)

Example:

```
<assert-application-popcount-value-gt name="r_ex_demoa" pop-count="1"/>
```

2.13 assert-application-popcount-value-le

This tag asserts a application pop count is less than or equal to an expected value.

Table 14-20 assert-application-popcount-value-le

Attribute	Required	Description
name	Yes	Application measure name
pop-count	No	Expected popcount (Defaults to zero)
skip	No	Skip this tag if true (defaults to false)
stop	No	Stop rpac execution if true (defaults to false)
debug	No	Wait for debugger if true (defaults to false)

Example:

```
<assert-application-popcount-value-le name="r_ex_demoa" pop-count="1"/>
```

2.14 assert-application-popcount-value-lt

This tag asserts a application pop count is less than an expected value.

Table 14-21 assert-application-popcount-value-lt

Attribute	Required	Description
name	Yes	Application measure name
pop-count	No	Expected popcount (Defaults to zero)
skip	No	Skip this tag if true (defaults to false)
stop	No	Stop rpac execution if true (defaults to false)
debug	No	Wait for debugger if true (defaults to false)

Example:

```
<assert-application-popcount-value-lt name="r_ex_demoa" pop-count="1"/>
```

2.15 assert-application-popcount-value-ne

This tag asserts a application pop count is not equal to an expected value.

Table 14-22 assert-application-popcount-value-ne

Attribute	Required	Description
name	Yes	Application measure name
pop-count	No	Expected popcount (Defaults to zero)
skip	No	Skip this tag if true (defaults to false)
stop	No	Stop rpac execution if true (defaults to false)
debug	No	Wait for debugger if true (defaults to false)

Example:

```
<assert-application-popcount-value-ne name="r_ex_demoa" pop-count="1"/>
```

2.16 set-application-measure

This tag set the value of a application measure based on provided attributes.

Table 14-23 set-application-measure

Attribute	Required	Description
name	Yes	Application measure name
value	No	Value to set application measure value to. (Defaults to NA). Date value must be provided in one of six formats '%Y%m%d%H%M%S', '%Y%m%d%H%M', '%Y%m%d', '%m/%d/%Y %H:%M:%S', '%m/%d/%Y %H:%M', or '%m/%d/%Y'. For boolean measure valid values are 't' or 'true' of any case while all other values are false.
keyint	No	Intersection of namedKey attribute if not provided intersection of namedKey is base intersection of the measure.
namedkeys	No	List of colon separated position specs. There must be one position specs for each dimension of the measure. A position specs is a comma separate list of sub-specs. A sub-spec can be a position name, a range of position names like 'w01_1997-w18_1997', or an asterisk. An asterisk '*' indicates all positions of the given dimension will be used. A position name can be replace with a position index.
skip	No	Skip this tag if true (defaults to false)
stop	No	Stop rpac execution if true (defaults to false)
debug	No	Wait for debugger if true (defaults to false)

Example:

```
<testcase>
  <set-application-measure name="r_ex_demoa"
    namedkeys="w02_2009,w03_2009,w04_2009:dept03:str1000" value="10"/>
  <set-application-measure name="r_ex_demob" namedkeys="w02_2009-
    w04_2009:dept03:str1000" value="10"/>
```

```

    <set-application-measure name="r_ex_demo" namedkeys="w02_2009-
w04_2009:*:str1000" value="10"/>
    <set-application-measure name="r_ex_demo" namedkeys="w02_2009-
w04_2009:*:str1001"/>
</testcase>

```

2.17 register-measure

This tag registers a measure with the provided properties to the current store either a workbook or application PDS table.

Table 14-24 register-measure

Attribute	Required	Description
name	Yes	Measure name
type	No	Type of measure (Defaults to real). Acceptable values are int, real, string, date, or boolean.
intx	No	Base intersection
defagg	No	Default aggregation method
naval	No	Value to set the measure NaValue. (Defaults to NA). Date value must be provided in one of six formats '%Y%m%d%H%M%S', '%Y%m%d%H%M', '%Y%m%d', '%m/%d/%Y %H:%M:%S', '%m/%d/%Y %H:%M', or '%m/%d/%Y'. For boolean measure valid values are 't' or 'true' of any case while all other values are false.
fnhbi	No	Force non HBI measure (Defaults to false)
dbpath	No	Database path of measure (Defaults to 'data/rpac')
basestate	No	Base state of measure (Defaults to none)
skip	No	Skip this tag if true (defaults to false)
stop	No	Stop rpac execution if true (defaults to false)
debug	No	Wait for debugger if true (defaults to false)

Example:

```

<testcase>
  <set-environment-variable name="MEAS0" value="tst_int"/>
  <set-environment-variable name="MEAS1" value="tst_real"/>
  <set-environment-variable name="MEAS2" value="tst_string"/>
  <set-environment-variable name="MEAS3" value="tst_date"/>
  <set-environment-variable name="MEAS4" value="tst_boolean"/>
  <set-environment-variable name="INTX" value="str_week"/>
  <register-measure name="[MEAS0]" type="int" intx="[INTX]"
basestate="write" naval="0"/>
  <register-measure name="[MEAS1]" type="real" intx="[INTX]"
basestate="write" naval="0"/>
  <register-measure name="[MEAS2]" type="string" intx="[INTX]"
basestate="write" naval="Test"/>
  <register-measure name="[MEAS3]" type="date" intx="[INTX]"
basestate="write"/>
  <register-measure name="[MEAS4]" type="boolean" intx="[INTX]"
basestate="write"/>
</testcase>

```

2.18 unregister-measure

This tag unregisters a measure from the current store either a workbook or from the application PDS meta table.

Table 14-25 unregister-measure

Attribute	Required	Description
name	Yes	Measure name
skip	No	Skip this tag if true (defaults to false)
stop	No	Stop rpac execution if true (defaults to false)
debug	No	Wait for debugger if true (defaults to false)

Example:

```
<testcase>
  <set-environment-variable name="MEAS0" value="tst_int"/>
  <set-environment-variable name="MEAS1" value="tst_real"/>
  <unregister-measure name="[MEAS0]"/>
  <unregister-measure name="[MEAS1]"/>
  <unregister-measure name="test_measure"/>
</testcase>
```

2.19 unregister-measures

This tag unregisters a list of measures from the current store either a workbook or from the application PDS meta table.

Table 14-26 unregister-measures

Attribute	Required	Description
name	Yes	List of measure names
skip	No	Skip this tag if true (defaults to false)
stop	No	Stop rpac execution if true (defaults to false)
debug	No	Wait for debugger if true (defaults to false)

2.20 get-measure-property

This tag gets property for given measure. Valid properties are ('factname', 'factgroup', 'facttable', 'baseintx', 'aggMethod', 'nvalue', 'rpastype', or 'materialized'). Any property that is an empty string will be show as the string constant 'Blank'.

Table 14-27 get-measure-property

Attribute	Required	Description
measure-name	Yes	Name of measure to get property for
property	Yes	Name of property to get fetch valid values ('factname', 'factgroup', 'facttable', 'baseintx', 'aggMethod', 'nvalue', 'rpastype', or 'materialized')

Table 14-27 (Cont.) get-measure-property

Attribute	Required	Description
variable	Yes	Name of variable to update with property value
skip	No	Skip this tag if true (defaults to false)
stop	No	Stop rpac execution if true (defaults to false)
debug	No	Wait for debugger if true (defaults to false)

2.21 clear-application-measure-list

This tag clears a list of application measures of all data. Must provide either the attribute 'filename' where the list of measures is contain in a file. Or the attribute 'measures' where the value of the attribute is a comma separated list measures names.

Table 14-28 clear-application-measure-list

Attribute	Required	Description
filename	No	Filename of file containing application measures names
measures	No	Comma separated list of application measure names
skip	No	Skip this tag if true (defaults to false)
stop	No	Stop rpac execution if true (defaults to false)
debug	No	Wait for debugger if true (defaults to false)

Example:

```
<clear-application-measure-list measures="rm1,rm2"/>
```

2.22 clear-application-measure

This tag clears a application measure of all data.

Table 14-29 clear-application-measure

Attribute	Required	Description
name	Yes	Application measure name
skip	No	Skip this tag if true (defaults to false)
stop	No	Stop rpac execution if true (defaults to false)
debug	No	Wait for debugger if true (defaults to false)

Example:

```
<clear-application-measure name="r_ex_pick_real" />
```

2.23 backup-appl-measure

This tag backs up an application measure fact table data to the CSV backup file contained in the PDS directory.

Table 14-30 backup-appl-measure

Attribute	Required	Description
measure-name	Yes	Measure name
skip	No	Skip this tag if true (defaults to false)
stop	No	Stop rpac execution if true (defaults to false)
debug	No	Wait for debugger if true (defaults to false)

Example:

```
<testcase>
  <backup-appl-measure measure-name="[MEAS1]" />
</testcase>
```

2.24 dump-appl-measure

This tag dumps an application measure data to a CSV file.

Table 14-31 dump-appl-measure

Attribute	Required	Description
measure-name	Yes	Measure name
csv-path	Yes	Path of CSV file to dump measure data into. A relative path value uses the RPAC work directory.
skip	No	Skip this tag if true (defaults to false)
stop	No	Stop rpac execution if true (defaults to false)
debug	No	Wait for debugger if true (defaults to false)

Example:

```
<testcase>
  <dump-appl-measure measure-name="[MEAS1]" csv-path="measure1.csv" />
</testcase>
```

2.25 load-appl-measure

This tag loads an application measure data to a CSV file.

Table 14-32 load-appl-measure

Attribute	Required	Description
measure-name	Yes	Measure name
csv-path	Yes	Path of CSV file to dump measure data into. A relative path value uses the RPAC work directory.

Table 14-32 (Cont.) load-appl-measure

Attribute	Required	Description
overlay	No	When true overlay data into fact table. (defaults to false).
skip	No	Skip this tag if true (defaults to false)
stop	No	Stop rpac execution if true (defaults to false)
debug	No	Wait for debugger if true (defaults to false)

Example:

```
<testcase>
  <load-appl-measure measure-name="[MEAS1]" csv-path="measure1.csv"/>
</testcase>
```

2.26 restore-all-appl-measure

This tag restores all application measures fact tables data from backup files contained in the PDS directory

Table 14-33 restore-all-appl-measure

Attribute	Required	Description
skip	No	Skip this tag if true (defaults to false)
stop	No	Stop rpac execution if true (defaults to false)
debug	No	Wait for debugger if true (defaults to false)

Example:

```
<testcase>
  <restore-all-appl-measures/>
</testcase>
```

3. Dimension Tags

This section provides details about the Dimension tags.

3.1 assert-hier-exists

This tag asserts a hierarchy exists.

Table 14-34 assert-hier-exists

Attribute	Required	Description
name	Yes	Hierarchy name
exists	Yes	If flag is true then check if hierachy exist (Defaults to true)
skip	No	Skip this tag if true (defaults to false)
stop	No	Stop rpac execution if true (defaults to false)

Table 14-34 (Cont.) assert-hier-exists

Attribute	Required	Description
debug	No	Wait for debugger if true (defaults to false)

Example:

```
<assert-hier-exists name="prod" exists="true"/>
```

3.2 assert-dimension-contain

This tag asserts a dimension contains or does not contain a position name.

Table 14-35 assert-dimension-contain

Attribute	Required	Description
name	Yes	Dimension name
posname	Yes	List of comma separated position names
containflag	Yes	If flag is true then position names are checked to see if they are contained in the dimension
skip	No	Skip this tag if true (defaults to false)
stop	No	Stop rpac execution if true (defaults to false)
debug	No	Wait for debugger if true (defaults to false)

Example:

```
<assert-dimension-contain name="scls" posname="10000001" containflag="true"/>
```

3.3 assert-dimension-exists

This tag asserts a dimension name exists.

Table 14-36 assert-dimension-exists

Attribute	Required	Description
name	Yes	Hierarchy name
skip	No	Skip this tag if true (defaults to false)
stop	No	Stop rpac execution if true (defaults to false)
debug	No	Wait for debugger if true (defaults to false)

Example:

```
<assert-dimension-exists name="dim"/>
```

3.4 assert-dimension-size

This tag asserts a dimension size is between a minimum and a maximum value.

Table 14-37 assert-dimension-size

Attribute	Required	Description
name	Yes	Dimension name
min	Yes	Minimum value
max	Yes	Maximum value
skip	No	Skip this tag if true (defaults to false)
stop	No	Stop rpac execution if true (defaults to false)
debug	No	Wait for debugger if true (defaults to false)

Example:

```
<assert-dimension-size name="dim" min="10" max="100"/>
```

4. Directory and File Tags

This section provides details about the Directory and File tags.

4.1 assert-directory-does-not-exists

This tag asserts that a directory does not exist.

Table 14-38 assert-directory-does-not-exists

Attribute	Required	Description
path	Yes	Path of directory to verify does not exist
skip	No	Skip this tag if true (defaults to false)
stop	No	Stop rpac execution if true (defaults to false)
debug	No	Wait for debugger if true (defaults to false)

Example:

```
<assert-directory-does-not-exists path="[PDS_PATH]/emptyDir" />
```

4.2 assert-directory-exists

This tag asserts that a directory exists.

Table 14-39 assert-directory-exists

Attribute	Required	Description
path	Yes	Path of directory to verify does not exist
skip	No	Skip this tag if true (defaults to false)
stop	No	Stop rpac execution if true (defaults to false)
debug	No	Wait for debugger if true (defaults to false)

Example:

```
<testcase>
  <set-environment-variable name="INPUT"      value="[PDS_PATH]/input"/>
  <set-environment-variable name="PROCESSED"  value="[INPUT]/processed"/>
  <assert-directory-exists path="[PROCESSED]"/></testcase>
```

4.3 assert-directory-is-empty

This tag asserts that a directory exists and contain no files.

Table 14-40 assert-directory-is-empty

Attribute	Required	Description
path	Yes	Path of directory to verify does not exists
skip	No	Skip this tag if true (defaults to false)
stop	No	Stop rpac execution if true (defaults to false)
debug	No	Wait for debugger if true (defaults to false)

Example:

```
<testcase>
  <set-environment-variable name="TESTDIR" value="[RPAC_WORK]/emptyDir"/>
  <assert-directory-is-empty path="[TESTDIR]"/>
</testcase>
```

4.4 assert-directory-structure

This tag asserts that a directory exists and has a certain directory structure. The value of the tag contains the expected directory structure. Each line of the directory structure must use a vertical bar '|' between lines. The path attribute is the location of the directory structure.

Table 14-41 assert-directory-structure

Attribute	Required	Description
path	Yes	Path of directory to verify does not exists
skip	No	Skip this tag if true (defaults to false)
stop	No	Stop rpac execution if true (defaults to false)
debug	No	Wait for debugger if true (defaults to false)

Example:

```
<assert-directory-structure path="[RPAC_WORK]/rdm">
  tasks/ |
  tasks/booking/ |
  tasks/pending/ |
  tasks/working/ |
  tasks/working/test.log
</assert-directory-structure>
```

4.5 assert-file-contains

This tag asserts range of N:M occurrences of text are contain in a file. Must provide either 'text' attribute, 'text-from-file' attribute or tag value. If 'text' attribute is provided then the value

of the attribute will be split base on the separator attribute. If 'text-from-file' attribute is provide then each line is a separate pattern. If tag value is provide then each line of the tag value will be a separate pattern.

Table 14-42 assert-file-contains

Attribute	Required	Description
path	Yes	File path of file to search
range	Yes	Range of number of occurrences to expect. IE 4:6 indicates at least four and up to and including six occurrences
test	No	Text patterns to search for, if separator is provided the text string is split into different patterns
text-from-file	No	File path containing text patterns to search for. Each line of the file being a pattern
erase	No	Erase file if assert is valid (defaults to true)
case-sensitive	No	Case sensitive (defaults to false)
separator	No	Separator to use (defaults to " "), use "none" if text does not need to be split
skip	No	Skip this tag if true (defaults to false)
stop	No	Stop rpac execution if true (defaults to false)
debug	No	Wait for debugger if true (defaults to false)

Example:

```
<testsuite name="example" role="batch">
  <once>
    <set-environment-variable name="PATTERNS1" value="[PLATFORM]/
patterns1.txt"/>
    <set-environment-variable name="MACE_CMD" value="mace -d [SANDBOX] -run -
expression"/>
  </once>

  <testcase name="Test 1">
    <shell unique-file="LOG_PATH">
      [MACE_CMD] "rpacMeasure = if(rpacMaskMeasure, rand(123, 170), 0)"
    </shell>
    <assert-file-contains path="[LOG_PATH]" erase="false" range="1:1" text-
from-file="[PATTERNS1]"/>
    <assert-file-contains path="[LOG_PATH]" erase="true" range="1:8"
text="IllegalParse"/>
  </testcase>
</testsuite>
```

4.6 assert-file-does-not-exists

This tag asserts that a file does not exists.

Table 14-43 assert-file-does-not-exists

Attribute	Required	Description
path	Yes	Path of file to verify does not exists

Table 14-43 (Cont.) assert-file-does-not-exists

Attribute	Required	Description
skip	No	Skip this tag if true (defaults to false)
stop	No	Stop rpac execution if true (defaults to false)
debug	No	Wait for debugger if true (defaults to false)

Example:

```
<testcase>
  <set-environment-variable name="INPUT"      value="[PDS_PATH]/input"/>
  <set-environment-variable name="PROCESSED" value="[INPUT]/processed"/>
  <assert-file-does-not-exists path="[INPUT]/prod.dat"/>
  <assert-file-does-not-exists path="[PROCESSED]/users.xml"/>
</testcase>
```

4.7 assert-file-exists

This tag asserts that a file exists.

Table 14-44 assert-file-exists

Attribute	Required	Description
path	Yes	Path of file to verify does not exists
skip	No	Skip this tag if true (defaults to false)
stop	No	Stop rpac execution if true (defaults to false)
debug	No	Wait for debugger if true (defaults to false)

Example:

```
<testcase>
  <set-environment-variable name="INPUT"      value="[PDS_PATH]/input"/>
  <set-environment-variable name="PROCESSED" value="[INPUT]/processed"/>
  <assert-file-does-not-exists path="[INPUT]/prod.dat"/>
  <assert-file-does-not-exists path="[PROCESSED]/users.xml"/>
  <assert-directory-exists   path="[PROCESSED]"/>
  <assert-file-exists       path="[PROCESSED]/msgs.dat.20190822004042"/>
</testcase>
```

4.8 assert-file-is-empty

This tag asserts that a file exists and contain no data.

Table 14-45 assert-file-is-empty

Attribute	Required	Description
path	Yes	Path of file to verify does not exists
skip	No	Skip this tag if true (defaults to false)
stop	No	Stop rpac execution if true (defaults to false)

Table 14-45 (Cont.) assert-file-is-empty

Attribute	Required	Description
debug	No	Wait for debugger if true (defaults to false)

Example:

```
<testcase>
  <set-environment-variable name="TESTTXTFILE" value="[RPAC_WORK]/emptyDir/
test.txt"/>
  <assert-file-is-empty path="[TESTTXTFILE]"/>
</testcase>
```

4.9 assert-file-is-read-lock

This tag asserts the given file is read locked.

Table 14-46 assert-file-is-read-lock

Attribute	Required	Description
path	Yes	Path of file to verify does not exists
skip	No	Skip this tag if true (defaults to false)
stop	No	Stop rpc execution if true (defaults to false)
debug	No	Wait for debugger if true (defaults to false)

Example:

```
<testcase>
  <set-environment-variable name="TESTLCKFILE" value="[RPAC_WORK]/emptyDir/
test.lck"/>
  <read-lock-file path="[TESTLCKFILE]"/>
  <assert-file-is-read-lock path="[TESTLCKFILE]"/>
</testcase>
```

4.10 assert-file-is-write-lock

This tag asserts the given file is write locked.

Table 14-47 assert-file-is-write-lock

Attribute	Required	Description
path	Yes	Path of file to verify does not exists
skip	No	Skip this tag if true (defaults to false)
stop	No	Stop rpc execution if true (defaults to false)
debug	No	Wait for debugger if true (defaults to false)

```
<testcase>
  <set-environment-variable name="TESTLCKFILE" value="[RPAC_WORK]/emptyDir/
test.lck"/>
  <write-lock-file path="[TESTLCKFILE]"/>
```

```
<assert-file-is-write-lock path="[TESTLCKFILE]"/>
</testcase>
```

4.11 compare-file-content

This tag compares content of file to xml data.

Table 14-48 compare-file-content

Attribute	Required	Description
path	Yes	Path of file content is to be compare with
erase	No	Erase file if matches content (defaults to true)
skip	No	Skip this tag if true (defaults to false)
stop	No	Stop rpac execution if true (defaults to false)
debug	No	Wait for debugger if true (defaults to false)

Example:

```
<testcase>
  <set-environment-variable name="MEAS" value="rpacMeasure %s NA NA"/>
  <set-environment-variable name="DIM" value="week 0 %s 1"/>
  <get-unique-file-path name="FILEPATH"/>
  <shell>exportData -d [RPAC_DOMAIN] -meas "[MEAS]" -dim "[DIM]" -out [FILEPATH]</
shell>
  <compare-file-content path="[FILEPATH]">
    "w02_2007Test1"|
    "w03_2007Test2"|
    "w04_2007Test3"
  </compare-file-content>
</testcase>
```

4.12 compare-files

This tag compares content of two files.

Table 14-49 compare-files

Attribute	Required	Description
input	Yes	Path to input gold file
output	Yes	Path to output file to compare to
ignore-trailing-blank-line	No	Ignore blank lines at end of file (defaults to false)
skip	No	Skip this tag if true (defaults to false)
stop	No	Stop rpac execution if true (defaults to false)
debug	No	Wait for debugger if true (defaults to false)

Example:

```
<testcase
  name="Verify working directory attribute works">
  <set-environment-variable name="EXPECTED" value="[RPAC_DATA]/rpas_utilities.txt"/>
  <shell unique-file="[ACTUAL]">ls -l [RPAC_HOME]</shell> <compare-files
```

```
input="[EXPECTED]" output="[ACTUAL]"/>
</testcase>
```

4.13 copy-directory

This tag copy a directory.

Table 14-50 copy-directory

Attribute	Required	Description
src-path	Yes	Path of directory to be copied
dst-path	Yes	Path to copy directory to
skip	No	Skip this tag if true (defaults to false)
stop	No	Stop rpc execution if true (defaults to false)
debug	No	Wait for debugger if true (defaults to false)

Example:

```
<testcase>
  <set-environment-variable name="TESTDIR" value="[RPAC_WORK]/emptyDir"/>
  <copy-directory src-path="[TESTDIR]/testDir1" dst-path="[TESTDIR]/testDir2"/>
</testcase>
```

4.14 copy-file

This tag copy a file.

Table 14-51 copy-file

Attribute	Required	Description
src-path	Yes	Path of directory to be copied
dst-path	Yes	Path to copy directory to
expand	No	Expand environmental variables (defaults to false)
skip	No	Skip this tag if true (defaults to false)
stop	No	Stop rpc execution if true (defaults to false)
debug	No	Wait for debugger if true (defaults to false)

Example:

```
<testcase>
  <set-environment-variable name="TESTTXTFILE1" value="[RPAC_WORK]/emptyDir/
test1.txt"/>
  <set-environment-variable name="TESTTXTFILE2" value="[RPAC_WORK]/emptyDir/
test2.txt"/>
  <copy-file src-path="[TESTTXTFILE1]" dst-path="[TESTTXTFILE2]"/>
</testcase>
```

4.15 create-directory

This tag creates a directory.

Table 14-52 create-directory

Attribute	Required	Description
path	Yes	Path of directory to create
create-parent	No	Create parent directory if true (defaults to false)
skip	No	Skip this tag if true (defaults to false)
stop	No	Stop rpac execution if true (defaults to false)
debug	No	Wait for debugger if true (defaults to false)

Example:

```
<testcase>
  <set-environment-variable name="TESTDIR" value="[RPAC_WORK]/emptyDir"/>
  <create-directory path="[TESTDIR]"/>
</testcase>
```

4.16 create-file

This tag creates a file.

Table 14-53 create-file

Attribute	Required	Description
path	Yes	Path of directory to create
create-parent	No	Create parent directory if true (defaults to false)
skip	No	Skip this tag if true (defaults to false)
stop	No	Stop rpac execution if true (defaults to false)
debug	No	Wait for debugger if true (defaults to false)

Example:

```
<testcase>
  <set-environment-variable name="TESTTXTFILE" value="[RPAC_WORK]/emptyDir/test.txt"/>
  <create-file path="[TESTTXTFILE]">test</create-file>
</testcase>
```

4.17 erase-file

This tag erases a file.

Table 14-54 erase-file

Attribute	Required	Description
path	Yes	Path to output file to erase
skip	No	Skip this tag if true (defaults to false)
stop	No	Stop rpac execution if true (defaults to false)
debug	No	Wait for debugger if true (defaults to false)

Example:

```
<testcase>
  <set-environment-variable name="TESTTXTFILE" value="[RPAC_WORK]/emptyDir/
test.txt"/>
  <erase-file path="[TESTTXTFILE]"/>
</testcase>
```

4.18 rename-file

This tag renames a file or directory.

Table 14-55 rename-file

Attribute	Required	Description
src-path	Yes	Old name of file or directory
dst-path	Yes	New name of file or directory
skip	No	Skip this tag if true (defaults to false)
stop	No	Stop rpac execution if true (defaults to false)
debug	No	Wait for debugger if true (defaults to false)

Example:

```
<testcase>
  <set-environment-variable name="TESTTXTFILE1" value="[RPAC_WORK]/emptyDir/
test1.txt"/>
  <set-environment-variable name="TESTTXTFILE2" value="[RPAC_WORK]/emptyDir/
test2.txt"/>
  <rename-file src-path="[TESTTXTFILE1]" dst-path="[TESTTXTFILE2]"/>
</testcase>
```

4.19 remove-directory

This tag removes a directory.

Table 14-56 remove-directory

Attribute	Required	Description
path	Yes	Path of directory to remove
skip	No	Skip this tag if true (defaults to false)
stop	No	Stop rpac execution if true (defaults to false)
debug	No	Wait for debugger if true (defaults to false)

Example:

```
<testcase>
  <set-environment-variable name="TESTDIR" value="[RPAC_WORK]/emptyDir"/>
  <remove-directory path="[TESTDIR]"/>
</testcase>
```

4.20 read-lock-file

This tag attempts to read lock the given file.

Table 14-57 read-lock-file

Attribute	Required	Description
path	Yes	Path of file being check for lock status
wait-for	No	Number of seconds to wait acquiring lock (Defaults to 2 minutes)
skip	No	Skip this tag if true (defaults to false)
stop	No	Stop rpc execution if true (defaults to false)
debug	No	Wait for debugger if true (defaults to false)

Example:

```
<testcase>
  <set-environment-variable name="TESTLCKFILE" value="[RPAC_WORK]/emptyDir/test.lck"/>
  <read-lock-file path="[TESTLCKFILE]"/>
</testcase>
```

4.21 write-lock-file

This tag attempts to write locks the given file.

Table 14-58 write-lock-file

Attribute	Required	Description
path	Yes	Path of file being check for lock status
wait-for	No	Number of seconds to wait acquiring lock (Defaults to 2 minutes)
skip	No	Skip this tag if true (defaults to false)
stop	No	Stop rpc execution if true (defaults to false)
debug	No	Wait for debugger if true (defaults to false)

Example:

```
<testcase>
  <set-environment-variable name="TESTLCKFILE" value="[RPAC_WORK]/emptyDir/test.lck"/>
  <write-lock-file path="[TESTLCKFILE]"/>
</testcase>
```

4.22 unlock-file

This tag attempts to unlock the given file.

Table 14-59 unlock-file

Attribute	Required	Description
path	Yes	Path of file being check for lock status
wait-for	No	Number of seconds to wait acquiring lock (Defaults to 2 minutes)
skip	No	Skip this tag if true (defaults to false)
stop	No	Stop rpac execution if true (defaults to false)
debug	No	Wait for debugger if true (defaults to false)

Example:

```
<testcase>
  <set-environment-variable name="TESTLCKFILE" value="[RPAC_WORK]/emptyDir/
test.lck"/>
  <unlock-file path="[TESTLCKFILE]"/>
</testcase>
```

4.23 assert-file-size-eq

This tag asserts the size of the file is equal to an expected value.

Table 14-60 assert-file-size-eq

Attribute	Required	Description
path	Yes	Path of file to verify size of.
value	No	File size to compare to. (Defaults to zero)
skip	No	Skip this tag if true (defaults to false)
stop	No	Stop rpac execution if true (defaults to false)
debug	No	Wait for debugger if true (defaults to false)

Example:

```
<once>
  <set-environment-variable name="PATH" value="[RPAC_DATA]/measure1.csv"/>
</once>
<testcase name="Check equal 0">
  <assert-file-size-eq path="[PATH]" value="0"/>
</testcase>
```

4.24 assert-file-size-ge

This tag asserts the size of the file is greater than or equal to an expected value.

Table 14-61 assert-file-size-ge

Attribute	Required	Description
path	Yes	Path of file to verify size of.
value	No	File size to compare to. (Defaults to zero)

Table 14-61 (Cont.) assert-file-size-ge

Attribute	Required	Description
skip	No	Skip this tag if true (defaults to false)
stop	No	Stop rpac execution if true (defaults to false)
debug	No	Wait for debugger if true (defaults to false)

Example:

```
<once>
  <set-environment-variable name="PATH" value="[RPAC_DATA]/measure1.csv"/>
</once>

<testcase name="Check greater than or equal 0">
  <assert-file-size-ge path="[PATH]" value="0"/>
</testcase>
```

4.25 assert-file-size-gt

This tag asserts the size of the file is greater than an expected value.

Table 14-62 assert-file-size-gt

Attribute	Required	Description
path	Yes	Path of file to verify size of.
value	No	File size to compare to. (Defaults to zero)
skip	No	Skip this tag if true (defaults to false)
stop	No	Stop rpac execution if true (defaults to false)
debug	No	Wait for debugger if true (defaults to false)

Example:

```
<once>
  <set-environment-variable name="PATH" value="[RPAC_DATA]/measure1.csv"/>
</once>

<testcase name="Check greater than 0">
  <assert-file-size-gt path="[PATH]" value="0"/>
</testcase>
```

4.26 assert-file-size-le

This tag asserts the size of the file is less than or equal to an expected value.

Table 14-63 assert-file-size-le

Attribute	Required	Description
path	Yes	Path of file to verify size of.
value	No	File size to compare to. (Defaults to zero)
skip	No	Skip this tag if true (defaults to false)

Table 14-63 (Cont.) assert-file-size-le

Attribute	Required	Description
stop	No	Stop rpc execution if true (defaults to false)
debug	No	Wait for debugger if true (defaults to false)

Example:

```
<once>
  <set-environment-variable name="PATH" value="[RPAC_DATA]/measure1.csv"/>
</once>

<testcase name="Check less than or equal 0">
  <assert-file-size-le path="[PATH]" value="0"/>
</testcase>
```

4.27 assert-file-size-lt

This tag asserts the size of the file is less than an expected value.

Table 14-64 assert-file-size-lt

Attribute	Required	Description
path	Yes	Path of file to verify size of.
value	No	File size to compare to. (Defaults to zero)
skip	No	Skip this tag if true (defaults to false)
stop	No	Stop rpc execution if true (defaults to false)
debug	No	Wait for debugger if true (defaults to false)

Example:

```
<once>
  <set-environment-variable name="PATH" value="[RPAC_DATA]/measure1.csv"/>
</once>

<testcase name="Check less than 0">
  <assert-file-size-lt path="[PATH]" value="0"/>
</testcase>
```

4.28 assert-file-size-ne

This tag asserts the size of the file is not equal to an expected value.

Table 14-65 assert-file-size-ne

Attribute	Required	Description
path	Yes	Path of file to verify size of.
value	No	File size to compare to. (Defaults to zero)
skip	No	Skip this tag if true (defaults to false)
stop	No	Stop rpc execution if true (defaults to false)

Table 14-65 (Cont.) assert-file-size-ne

Attribute	Required	Description
debug	No	Wait for debugger if true (defaults to false)

Example:

```
<once>
  <set-environment-variable name="PATH" value="[RPAC_DATA]/measure1.csv"/>
</once>

<testcase name="Check not equal 0">
  <assert-file-size-ne path="[PATH]" value="0"/>
</testcase>
```

5. Sql Query Tags

This section describes the SQL Query tags.

5.1 assert-sql-query-eq

This tag asserts the SQL query value is equal to an expected value.

Table 14-66 assert-sql-query-eq

Attribute	Required	Description
value	Yes	Expected value
type	Yes	Must provide type of value as one of these strings 'string', 'slong32', or 'double'
commit	No	True if the SQL query should be committed (defaults to false)
nullable	No	True if the SQL query results could be null (defaults to false)
bind-name	No	Provides a name for store procedure query like 'begin rp_xx_pkg.get_name(:name); end;'. For this call the parameter must be set to ':name'.
skip	No	Skip this tag if true (defaults to false)
stop	No	Stop rpac execution if true (defaults to false)
debug	No	Wait for debugger if true (defaults to false)

Example:

```
<testcase
  name="assert-sql-query-eq">
  <set-environment-variable name="QUERY" value="select count(*) from rp_g_scls_d
  where scls='10000001'"/>
  <assert-sql-query-eq value="1" type="slong32">
    [QUERY]
  </assert-sql-query-eq>
</testcase>
```

5.2 assert-sql-query-ge

This tag asserts the SQL query value is greater than or equal to an expected value.

Table 14-67 assert-sql-query-ge

Attribute	Required	Description
value	Yes	Expected value
type	Yes	Must provide type of value as one of these strings 'string', 'slong32', or 'double'
commit	No	True if the SQL query should be committed (defaults to false)
nullable	No	True if the SQL query results could be null (defaults to false)
bind-name	No	Provides a name for store procedure query like 'begin rp_xx_pkg.get_name(:name); end;'. For this call the parameter must be set to ':name'.
skip	No	Skip this tag if true (defaults to false)
stop	No	Stop rpc execution if true (defaults to false)
debug	No	Wait for debugger if true (defaults to false)

Example:

```
<testcase
  name="assert-sql-query-ge eq case">
  <set-environment-variable name="QUERY" value="select count(*) from
rp_g_scls_d where scls='10000001'"/>
  <assert-sql-query-ge value="1" type="slong32">
    [QUERY]
  </assert-sql-query-ge>
</testcase>
```

5.3 assert-sql-query-gt

This tag asserts the SQL query value is greater than an expected value.

Table 14-68 assert-sql-query-gt

Attribute	Required	Description
value	Yes	Expected value
type	Yes	Must provide type of value as one of these strings 'string', 'slong32', or 'double'
commit	No	True if the SQL query should be committed (defaults to false)
nullable	No	True if the SQL query results could be null (defaults to false)
bind-name	No	Provides a name for store procedure query like 'begin rp_xx_pkg.get_name(:name); end;'. For this call the parameter must be set to ':name'.

Table 14-68 (Cont.) assert-sql-query-gt

Attribute	Required	Description
skip	No	Skip this tag if true (defaults to false)
stop	No	Stop rpac execution if true (defaults to false)
debug	No	Wait for debugger if true (defaults to false)

Example:

```
<testcase
  name="assert-sql-query-gt">
  <set-environment-variable name="QUERY" value="select count(*) from rp_g_scls_d
where scls='10000001'"/>
  <assert-sql-query-gt value="0" type="slong32">
    [QUERY]
  </assert-sql-query-gt>
</testcase>
```

5.4 assert-sql-query-le

This tag asserts the SQL query value is less than or equal to an expected value.

Table 14-69 assert-sql-query-le

Attribute	Required	Description
value	Yes	Expected value
type	Yes	Must provide type of value as one of these strings 'string', 'slong32', or 'double'
commit	No	True if the SQL query should be committed (defaults to false)
nullable	No	True if the SQL query results could be null (defaults to false)
bind-name	No	Provides a name for store procedure query like 'begin rp_xx_pkg.get_name(:name); end;'. For this call the parameter must be set to ':name'.
skip	No	Skip this tag if true (defaults to false)
stop	No	Stop rpac execution if true (defaults to false)
debug	No	Wait for debugger if true (defaults to false)

Example:

```
<testcase
  name="assert-sql-query-le lt case">
  <set-environment-variable name="QUERY" value="select count(*) from rp_g_scls_d
where scls='10000001'"/>
  <assert-sql-query-le value="2" type="slong32">
    [QUERY]
  </assert-sql-query-le>
</testcase>
```

5.5 assert-sql-query-lt

This tag asserts the SQL query value is less than an expected value.

Table 14-70 assert-sql-query-lt

Attribute	Required	Description
value	Yes	Expected value
type	Yes	Must provide type of value as one of these strings 'string', 'slong32', or 'double'
commit	No	True if the SQL query should be committed (defaults to false)
nullable	No	True if the SQL query results could be null (defaults to false)
bind-name	No	Provides a name for store procedure query like 'begin rp_xx_pkg.get_name(:name); end;'. For this call the parameter must be set to ':name'.
skip	No	Skip this tag if true (defaults to false)
stop	No	Stop rpc execution if true (defaults to false)
debug	No	Wait for debugger if true (defaults to false)

Example:

```
<testcase
  name="assert-sql-query-lt">
  <set-environment-variable name="QUERY" value="select count(*) from
rp_g_scls_d where scls='10000001'"/>
  <assert-sql-query-lt value="2" type="slong32">
    [QUERY]
  </assert-sql-query-lt>
</testcase>
```

5.6 assert-sql-query-ne

This tag asserts the SQL query value is not equal to an expected value.

Table 14-71 assert-sql-query-ne

Attribute	Required	Description
value	Yes	Expected value
type	Yes	Must provide type of value as one of these strings 'string', 'slong32', or 'double'
commit	No	True if the SQL query should be committed (defaults to false)
nullable	No	True if the SQL query results could be null (defaults to false)
bind-name	No	Provides a name for store procedure query like 'begin rp_xx_pkg.get_name(:name); end;'. For this call the parameter must be set to ':name'.

Table 14-71 (Cont.) assert-sql-query-ne

Attribute	Required	Description
skip	No	Skip this tag if true (defaults to false)
stop	No	Stop rpac execution if true (defaults to false)
debug	No	Wait for debugger if true (defaults to false)

Example:

```
<testcase
  name="assert-sql-query-ne">
  <set-environment-variable name="QUERY" value="select count(*) from rp_g_scls_d
where scls='10000001'"/>
  <assert-sql-query-ne value="2" type="slong32">
    [QUERY]
  </assert-sql-query-ne>
</testcase>
```

5.7 call-rule-group

This tag execute a rule group contain in the PDS database.

Table 14-72 call-rule-group

Attribute	Required	Description
rule-group	Yes	Name of rule group to execute
skip	No	Skip this tag if true (defaults to false)
stop	No	Stop rpac execution if true (defaults to false)
debug	No	Wait for debugger if true (defaults to false)

5.8 call-special-expression

This tag calls a special expression in the PDS database.

Table 14-73 call-special-expression

Attribute	Required	Description
expression	Yes	Special expression to call
lhs-measures	Yes	LHS comma separated list of measures
rhs-measures	Yes	RHS comma separated list of measures
skip	No	Skip this tag if true (defaults to false)
stop	No	Stop rpac execution if true (defaults to false)
debug	No	Wait for debugger if true (defaults to false)

5.9 dump-database-tables

This tag dump one or more SQL tables to CSV text file given a list of SQL tables. The CSV test files created will be contain in the RPAC data directory unless the attribute dst-directory is

used to specify the directory to contain these files. One and only one of these attributes 'sql-tables' and 'sql-tables-file' must be provided.

Table 14-74 dump-database-tables

Attribute	Required	Description
sql-tables	No	List of SQL table names to dump to CSV text files.
sql-tables-file	No	File containing list of SQL table names to dump to CSV text files. This path is relative to the RPAC data directory.
dst-directory	No	Path of directory to contain the CSV text files. This path is relative to the RPAC data directory. If not provide the CSV text files will be written into the RPAC data directory. If the directory does not exists it will be created.
sorted	No	Use the table keys to sort the rows (Defaults to false).
skip	No	Skip this tag if true (defaults to false)
stop	No	Stop rpac execution if true (defaults to false)
debug	No	Wait for debugger if true (defaults to false)

5.10 execute-bdi-extractor

This tag executes the request BDI extractor. The return control identifier is contain in the variable 'EXTRACTOR_CONTROL_ID'.

Table 14-75 execute-bdi-extractor

Attribute	Required	Description
extractor	Yes	Extractor name
job-context	Yes	Job context
control-id	No	Control identifier (defaults to 0)
skip	No	Skip this tag if true (defaults to false)
stop	No	Stop rpac execution if true (defaults to false)
debug	No	Wait for debugger if true (defaults to false)

5.11 execute-bdi-importer

This tag executes the request BDI importer.

Table 14-76 execute-bdi-importer

Attribute	Required	Description
importer	Yes	Importer name
appl-name	Yes	Application name
module	Yes	Name of module
date-set-type	Yes	Data set type

Table 14-76 (Cont.) execute-bdi-importer

Attribute	Required	Description
job-context	Yes	Job context
data-set-id	No	Data set identifier (defaults to 0)
skip	No	Skip this tag if true (defaults to false)
stop	No	Stop rpac execution if true (defaults to false)
debug	No	Wait for debugger if true (defaults to false)

5.12 execute-sql-query

This tag executes the SQL query provided as the value of this tag.

Table 14-77 execute-sql-query

Attribute	Required	Description
commit	No	True if the SQL query will be committed
skip	No	Skip this tag if true (defaults to false)
stop	No	Stop rpac execution if true (defaults to false)
debug	No	Wait for debugger if true (defaults to false)

Example:

```
<execute-sql-query>
  DELETE FROM RP_G_STR_D WHERE STR IN
    ('1194s', '1195s', '1197s', '1198s', '1200s', '8888s', '1193s', '1196s', '9999s',
    '1199s')
</execute-sql-query>
```

5.13 load-database-tables

This tag loads one or more tables from CSV text file given a list of text files or directories contain these files. Each file must have a '.csv' extension. The file path will be relative to the RPAC data directory. The table will be truncated before loading the data from the CSV text file.

Table 14-78 load-database-tables

Attribute	Required	Description
csv-files	Yes	List of CSV text files or directories containing these files. Each file must have a '.csv' extension. The file path will be relative to the RPAC data directory.
skip	No	Skip this tag if true (defaults to false)
stop	No	Stop rpac execution if true (defaults to false)
debug	No	Wait for debugger if true (defaults to false)

5.14 set-database-role

This tag sets the role used to access the database.

Table 14-79 set-database-role

Attribute	Required	Description
role	Yes	Role used to access the database
skip	No	Skip this tag if true (defaults to false)
stop	No	Stop rpac execution if true (defaults to false)
debug	No	Wait for debugger if true (defaults to false)

Example:

```
<set-database-role role="data_mart"/>
```

5.15 sql-start-trace

This tag enables tracing of SQL queries to a text file.

Table 14-80 sql-start-trace

Attribute	Required	Description
trace-path	No	Text file path. (Defaults to 'trace.txt')
skip	No	Skip this tag if true (defaults to false)
stop	No	Stop rpac execution if true (defaults to false)
debug	No	Wait for debugger if true (defaults to false)

5.16 sql-stop-trace

This tag stops tracing SQL queries.

Table 14-81 sql-stop-trace

Attribute	Required	Description
skip	No	Skip this tag if true (defaults to false)
stop	No	Stop rpac execution if true (defaults to false)
debug	No	Wait for debugger if true (defaults to false)

5.17 truncate-database-tables

This tag truncates comma separated list of database tables provided as the value of this tag.

Table 14-82 truncate-database-tables

Attribute	Required	Description
skip	No	Skip this tag if true (defaults to false)
stop	No	Stop rpac execution if true (defaults to false)
debug	No	Wait for debugger if true (defaults to false)

6. Workbook Measures Tags

This section describes the Workbook measures tags.

6.1 assert-workbook-measure-exists

This tag asserts a workbook measure exists.

Table 14-83 assert-workbook-measure-exists

Attribute	Required	Description
name	Yes	Workbook measure name
skip	No	Skip this tag if true (defaults to false)
stop	No	Stop rpac execution if true (defaults to false)
debug	No	Wait for debugger if true (defaults to false)

Example:

```
<assert-workbook-measure-exists name="mpwpslsr"/>
```

6.2 assert-workbook-measure-intx

This tag asserts a workbook measure base intersection matches an expected value.

Table 14-84 assert-workbook-measure-intx

Attribute	Required	Description
name	Yes	Workbook measure name
intx	Yes	Intersection string to compare with
skip	No	Skip this tag if true (defaults to false)
stop	No	Stop rpac execution if true (defaults to false)
debug	No	Wait for debugger if true (defaults to false)

Example:

```
<assert-workbook-measure-intx name="mpwpslsr" intx="chnlsclsweek"/>
```

6.3 assert-workbook-measure-value-eq

This tag asserts a workbook measure value is equal to an expected value.

Table 14-85 assert-workbook-measure-value-eq

Attribute	Required	Description
name	Yes	Workbook measure name
value	No	Expected value of workbook measure. (Defaults to NA). Date value must be provided in one of six formats '%Y%m%d%H%M%S', '%Y%m%d%H%M', '%Y%m%d', '%m/%d/%Y %H:%M:%S', '%m/%d/%Y %H:%M', or '%m/%d/%Y'. For boolean measure valid values are 't' or 'true' of any case while all other values are false.
precision	No	The number of decimal places to be considered for assertion
namedkeys	No	List of colon separated position specs. There must be one position specs for each dimension of the measure. A position specs is a comma separate list of sub-specs. A sub-spec can be a position name, a range of position names like 'w01_1997-w18_1997', or an asterisk. An asterisk '*' indicates all positions of the given dimension will be used. A position name can be replace with a position index.
intersection	No	Intersection to assert measure at (defaults to base intersection)
skip	No	Skip this tag if true (defaults to false)
stop	No	Stop rpac execution if true (defaults to false)
debug	No	Wait for debugger if true (defaults to false)

Example:

```
<assert-workbook-measure-value-eq name="r_ex_demoa"
namedkeys="w02_2009,w03_2009,w04_2009:dept03:str1000" value="10"/>
```

6.4 assert-workbook-measure-value-ge

This tag asserts a workbook measure value is greater than or equal to an expected value

Table 14-86 assert-workbook-measure-value-ge

Attribute	Required	Description
name	Yes	Workbook measure name
value	No	Expected value of workbook measure. (Defaults to NA). Date value must be provided in one of six formats '%Y%m%d%H%M%S', '%Y%m%d%H%M', '%Y%m%d', '%m/%d/%Y %H:%M:%S', '%m/%d/%Y %H:%M', or '%m/%d/%Y'. For boolean measure valid values are 't' or 'true' of any case while all other values are false.
precision	No	The number of decimal places to be considered for assertion

Table 14-86 (Cont.) assert-workbook-measure-value-ge

Attribute	Required	Description
namedkeys	No	List of colon separated position specs. There must be one position specs for each dimension of the measure. A position specs is a comma separate list of sub-specs. A sub-spec can be a position name, a range of position names like 'w01_1997-w18_1997', or an asterisk. An asterisk '*' indicates all positions of the given dimension will be used. A position name can be replace with a position index.
intersection	No	Intersection to assert measure at (defaults to base intersection)
skip	No	Skip this tag if true (defaults to false)
stop	No	Stop rpc execution if true (defaults to false)
debug	No	Wait for debugger if true (defaults to false)

Example:

```
<assert-workbook-measure-value-ge name="r_ex_demoa"
namedkeys="w02_2009,w03_2009,w04_2009:dept03:str1000" value="10"/>
```

6.5 assert-workbook-measure-value-gt

This tag asserts a workbook measure value is greater than an expected value

Table 14-87 assert-workbook-measure-value-gt

Attribute	Required	Description
name	Yes	Workbook measure name
value	No	Expected value of workbook measure. (Defaults to NA). Date value must be provided in one of six formats '%Y%m%d%H%M%S', '%Y%m%d%H%M', '%Y%m%d', '%m/%d/%Y %H:%M:%S', '%m/%d/%Y %H:%M', or '%m/%d/%Y'. For boolean measure valid values are 't' or 'true' of any case while all other values are false.
precision	No	The number of decimal places to be considered for assertion
namedkeys	No	List of colon separated position specs. There must be one position specs for each dimension of the measure. A position specs is a comma separate list of sub-specs. A sub-spec can be a position name, a range of position names like 'w01_1997-w18_1997', or an asterisk. An asterisk '*' indicates all positions of the given dimension will be used. A position name can be replace with a position index.
intersection	No	Intersection to assert measure at (defaults to base intersection)
skip	No	Skip this tag if true (defaults to false)
stop	No	Stop rpc execution if true (defaults to false)
debug	No	Wait for debugger if true (defaults to false)

Example:

```
<assert-workbook-measure-value-gt name="r_ex_demoa"
namedkeys="w02_2009,w03_2009,w04_2009:dept03:str1000" value="10"/>
```

6.6 assert-workbook-measure-value-le

This tag asserts a workbook measure value is less than or equal to an expected value

Table 14-88 assert-workbook-measure-value-le

Attribute	Required	Description
name	Yes	Workbook measure name
value	No	Expected value of workbook measure. (Defaults to NA). Date value must be provided in one of six formats '%Y%m%d%H%M%S', '%Y%m%d%H%M', '%Y%m%d', '%m/%d/%Y %H:%M:%S', '%m/%d/%Y %H:%M', or '%m/%d/%Y'. For boolean measure valid values are 't' or 'true' of any case while all other values are false.
precision	No	The number of decimal places to be considered for assertion
namedkeys	No	List of colon separated position specs. There must be one position specs for each dimension of the measure. A position specs is a comma separate list of sub-specs. A sub-spec can be a position name, a range of position names like 'w01_1997-w18_1997', or an asterisk. An asterisk '*' indicates all positions of the given dimension will be used. A position name can be replace with a position index.
intersection	No	Intersection to assert measure at (defaults to base intersection)
skip	No	Skip this tag if true (defaults to false)
stop	No	Stop rpac execution if true (defaults to false)
debug	No	Wait for debugger if true (defaults to false)

Example:

```
<assert-workbook-measure-value-le name="r_ex_demoa"
namedkeys="w02_2009,w03_2009,w04_2009:dept03:str1000" value="10"/>
```

6.7 assert-workbook-measure-value-lt

This tag asserts a workbook measure value is less than an expected value

Table 14-89 assert-workbook-measure-value-lt

Attribute	Required	Description
name	Yes	Workbook measure name

Table 14-89 (Cont.) assert-workbook-measure-value-lt

Attribute	Required	Description
value	No	Expected value of workbook measure. (Defaults to NA). Date value must be provided in one of six formats '%Y%m%d%H%M%S', '%Y%m%d%H%M', '%Y%m%d', '%m/%d/%Y %H:%M:%S', '%m/%d/%Y %H:%M', or '%m/%d/%Y'. For boolean measure valid values are 't' or 'true' of any case while all other values are false.
precision	No	The number of decimal places to be considered for assertion
namedkeys	No	List of colon separated position specs. There must be one position specs for each dimension of the measure. A position specs is a comma separate list of sub-specs. A sub-spec can be a position name, a range of position names like 'w01_1997-w18_1997', or an asterisk. An asterisk '*' indicates all positions of the given dimension will be used. A position name can be replace with a position index.
intersection	No	Intersection to assert measure at (defaults to base intersection)
skip	No	Skip this tag if true (defaults to false)
stop	No	Stop rpac execution if true (defaults to false)
debug	No	Wait for debugger if true (defaults to false)

Example:

```
<assert-workbook-measure-value-lt name="r_ex_demoa"
namedkeys="w02_2009,w03_2009,w04_2009:dept03:str1000" value="10"/>
```

6.8 assert-workbook-measure-value-ne

This tag asserts a workbook measure value is not equal to an expected value.

Table 14-90 assert-workbook-measure-value-ne

Attribute	Required	Description
name	Yes	Workbook measure name
value	No	Expected value of workbook measure. (Defaults to NA). Date value must be provided in one of six formats '%Y%m%d%H%M%S', '%Y%m%d%H%M', '%Y%m%d', '%m/%d/%Y %H:%M:%S', '%m/%d/%Y %H:%M', or '%m/%d/%Y'. For boolean measure valid values are 't' or 'true' of any case while all other values are false.
precision	No	The number of decimal places to be considered for assertion

Table 14-90 (Cont.) assert-workbook-measure-value-ne

Attribute	Required	Description
namedkeys	No	List of colon separated position specs. There must be one position specs for each dimension of the measure. A position specs is a comma separate list of sub-specs. A sub-spec can be a position name, a range of position names like 'w01_1997-w18_1997', or an asterisk. An asterisk '*' indicates all positions of the given dimension will be used. A position name can be replace with a position index.
intersection	No	Intersection to assert measure at (defaults to base intersection)
skip	No	Skip this tag if true (defaults to false)
stop	No	Stop rpac execution if true (defaults to false)
debug	No	Wait for debugger if true (defaults to false)

Example:

```
Example<testcase>
  <assert-workbook-measure-value-ne name="r_ex_demoa"
  namedkeys="w02_2009,w03_2009,w04_2009:dept03:str1000" value="10"/>
</testcase>
```

6.9 assert-workbook-measures-match

This tag asserts workbook measures have matching content. The content of this tag can limit the comparison to a sub-set of the measure data. The format is DimName0:dim0pos0,dim0pos1,dim0pos3|DimName1:dim1pos0. Which is N number of dimension/positions lines with a vertical bar separator. Each dimension/positions lines has a dimension name followed by a colon separator and N position names with a comma separator between each name. This is an optional value.

Table 14-91 assert-workbook-measures-match

Attribute	Required	Description
lhs-measure	Yes	LHS measure used for comparison
rhs-measure	Yes	RHS measure used for comparison
output-file	No	Output file name containing list of differences (Defaults to unique name base on tag line number and xml file name containing tag).
max-diffs	No	Maximum number of differences allow before stopping match (defaults to 32)
skip	No	Skip this tag if true (defaults to false)
stop	No	Stop rpac execution if true (defaults to false)
debug	No	Wait for debugger if true (defaults to false)

Example:

```
<testcase>
  <assert-workbook-measures-match lhs-measure="rm1" rhs-measure="rm2">
```

```

week:w45_2009,w46_2009,w47_2009|sku:sku_22200001,sku_22200002
</assert-workbook-measures-match>
<assert-workbook-measures-match lhs-measure="rm1" rhs-measure="rm2"/>
</testcase>

```

6.10 assert-workbook-popcount-value-eq

This tag asserts a workbook pop count is equal to an expected value.

Table 14-92 assert-workbook-popcount-value-eq

Attribute	Required	Description
name	Yes	Workbook measure name
pop-count	No	Expected popcount (Defaults to zero)
skip	No	Skip this tag if true (defaults to false)
stop	No	Stop rpac execution if true (defaults to false)
debug	No	Wait for debugger if true (defaults to false)

Example:

```
<assert-workbook-popcount-value-eq name="mpwpslsr" pop-count="1"/>
```

6.11 assert-workbook-popcount-value-ge

This tag asserts a workbook pop count is greater than or equal to an expected value.

Table 14-93 assert-workbook-popcount-value-ge

Attribute	Required	Description
name	Yes	Workbook measure name
pop-count	No	Expected popcount (Defaults to zero)
skip	No	Skip this tag if true (defaults to false)
stop	No	Stop rpac execution if true (defaults to false)
debug	No	Wait for debugger if true (defaults to false)

Example:

```
<assert-workbook-popcount-value-ge name="mpwpslsr" pop-count="1"/>
```

6.12 assert-workbook-popcount-value-gt

This tag asserts a workbook pop count is greater than an expected value.

Table 14-94 assert-workbook-popcount-value-gt

Attribute	Required	Description
name	Yes	Workbook measure name
pop-count	No	Expected popcount (Defaults to zero)
skip	No	Skip this tag if true (defaults to false)

Table 14-94 (Cont.) assert-workbook-popcount-value-gt

Attribute	Required	Description
stop	No	Stop rpac execution if true (defaults to false)
debug	No	Wait for debugger if true (defaults to false)

Example:

```
<assert-workbook-popcount-value-gt name="mpwpslsr" pop-count="0"/>
```

6.13 assert-workbook-popcount-value-le

This tag asserts a workbook pop count is less than or equal to an expected value.

Table 14-95 assert-workbook-popcount-value-le

Attribute	Required	Description
name	Yes	Workbook measure name
pop-count	No	Expected popcount (Defaults to zero)
skip	No	Skip this tag if true (defaults to false)
stop	No	Stop rpac execution if true (defaults to false)
debug	No	Wait for debugger if true (defaults to false)

Example:

```
<assert-workbook-popcount-value-le name="mpwpslsr" pop-count="1"/>
```

6.14 assert-workbook-popcount-value-lt

This tag asserts a workbook pop count is less than an expected value.

Table 14-96 assert-workbook-popcount-value-lt

Attribute	Required	Description
name	Yes	Workbook measure name
pop-count	No	Expected popcount (Defaults to zero)
skip	No	Skip this tag if true (defaults to false)
stop	No	Stop rpac execution if true (defaults to false)
debug	No	Wait for debugger if true (defaults to false)

Example:

```
<assert-workbook-popcount-value-lt name="mpwpslsr" pop-count="1000"/>
```

6.15 assert-workbook-popcount-value-ne

This tag asserts a workbook pop count is not equal to an expected value.

Table 14-97 assert-workbook-popcount-value-ne

Attribute	Required	Description
name	Yes	Workbook measure name
pop-count	No	Expected popcount (Defaults to zero)
skip	No	Skip this tag if true (defaults to false)
stop	No	Stop rpac execution if true (defaults to false)
debug	No	Wait for debugger if true (defaults to false)

Example:

```
<assert-workbook-popcount-value-ne name="mpwpslsr" pop-count="10"/>
```

6.16 set-workbook-measure

This tag sets the value of a workbook measure based on provided attributes.

Table 14-98 set-workbook-measure

Attribute	Required	Description
name	Yes	Workbook measure name
value	No	Value to set workbook cell to. (Defaults to NA). Date value must be provided in one of six formats '%Y%m%d%H%M%S', '%Y%m%d%H%M', '%Y%m%d', '%m/%d/%Y %H:%M:%S', '%m/%d/%Y %H:%M', or '%m/%d/%Y'. For boolean measure valid values are 't' or 'true' of any case while all other values are false.
keyint	No	Intersection of namedKey attribute if not provided intersection of namedKey is base intersection of the measure.
namedkeys	No	List of colon separated position specs. There must be one position specs for each dimension of the measure. A position specs is a comma separate list of sub-specs. A sub-spec can be a position name, a range of position names like 'w01_1997-w18_1997', or an asterisk. An asterisk '*' indicates all positions of the given dimension will be used. A position name can be replace with a position index.
incremental	No	True if evaluation is to be incremental (Defaults to false)
skip	No	Skip this tag if true (defaults to false)
stop	No	Stop rpac execution if true (defaults to false)
debug	No	Wait for debugger if true (defaults to false)

Example:

```
<testcase>
  <set-workbook-measure name="r_ex_demoa"
    namedkeys="w02_2009,w03_2009,w04_2009:dept03:str1000" value="10"/>
  <set-workbook-measure name="r_ex_demob" namedkeys="w02_2009-
w04_2009:dept03:str1000" value="10"/>
  <set-workbook-measure name="r_ex_democ" namedkeys="w02_2009-w04_2009*:str1000"
```

```

value="10"/>
  <set-workbook-measure name="r_ex_democ" namedkeys="w02_2009-
w04_2009*:str1001"/>
  <set-workbook-measure name="r_ex_demod" namedkeys="w02_2009-
w04_2009*:str1000" value="10" incremental="true"/>
</testcase>

```

6.17 edit-workbook-measure

This tag edits the value of a workbook measure based on provided attributes.

Table 14-99 edit-workbook-measure

Attribute	Required	Description
name	Yes	Workbook measure name
value	No	Value to set workbook cell to. (Defaults to NA). Date value must be provided in one of six formats '%Y%m%d%H%M%S', '%Y%m%d%H%M', '%Y%m%d', '%m/%d/%Y %H:%M:%S', '%m/%d/%Y %H:%M', or '%m/%d/%Y'. For boolean measure valid values are 't' or 'true' of any case while all other values are false.
keyint	No	Intersection of namedKey attribute if not provided intersection of namedKey is base intersection of the measure.
namedkeys	No	List of colon separated position specs. There must be one position specs for each dimension of the measure. A position specs is a comma separate list of sub-specs. A sub-spec can be a position name, a range of position names like 'w01_1997-w18_1997', or an asterisk. An asterisk '*' indicates all positions of the given dimension will be used. A position name can be replace with a position index.
incremental	No	True if evaluation is to be incremental (Defaults to false)
skip	No	Skip this tag if true (defaults to false)
stop	No	Stop rpac execution if true (defaults to false)
debug	No	Wait for debugger if true (defaults to false)

Example:

```

<testcase>
  <edit-workbook-measure name="[MEAS]" namedkeys="[KEY0]" value="Measure
Analysis Test"/>
  <edit-workbook-measure name="r_ex_demoa"
namedkeys="w02_2009,w03_2009,w04_2009:dept03:str1000" value="10"/>
  <edit-workbook-measure name="r_ex_demob" namedkeys="w02_2009-
w04_2009:dept03:str1000" value="10"/>
  <edit-workbook-measure name="r_ex_democ" namedkeys="w02_2009-
w04_2009*:str1000" value="10"/>
  <edit-workbook-measure name="r_ex_democ" namedkeys="w02_2009-
w04_2009*:str1001"/>
</testcase>

```

6.18 clear-workbook-measure-list

This tag clears a list of workbook measures of all data. Must provide either the attribute 'filename' where the list of measures is contain in a file. Or the attribute 'measures' where the value of the attribute is a comma separated list measures names.

Table 14-100 clear-workbook-measure-list

Attribute	Required	Description
filename	No	Filename of file containing workbook measures names
measures	No	Comma separated list of workbook measure names
skip	No	Skip this tag if true (defaults to false)
stop	No	Stop rpac execution if true (defaults to false)
debug	No	Wait for debugger if true (defaults to false)

Example:

```
<clear-workbook-measure-list measures="mpwpslsr,mtwpappstt"/>
```

6.19 clear-workbook-measure

This tag clears a workbook measure of all data.

Table 14-101 clear-workbook-measure

Attribute	Required	Description
name	Yes	Workbook measure name
skip	No	Skip this tag if true (defaults to false)
stop	No	Stop rpac execution if true (defaults to false)
debug	No	Wait for debugger if true (defaults to false)

Example:

```
<clear-workbook-measure name="mpwpslsr"/>
```

6.20 assert-measure-is-not-protected

This tag asserts a measures is not protected based on previous edited.

Table 14-102 assert-measure-is-not-protected

Attribute	Required	Description
name	Yes	Name of workbook measure to assert is not protected
variable	No	Name of RPAC or environment variable to true/false based on the status of the measure not being protected. If not provided, tag will report an error if the measure is protected.
skip	No	Skip this tag if true (defaults to false)

Table 14-102 (Cont.) assert-measure-is-not-protected

Attribute	Required	Description
stop	No	Stop rpac execution if true (defaults to false)
debug	No	Wait for debugger if true (defaults to false)

Example:

```
<testsuite name="Assert measure is not protected">

<testcase name="fails if measure is not protected">
  <assert-measure-is-not-protected name="[MEAS]" />
</testcase>

<testcase name="set variable MSG1 to false/true base on measure not being
protected">
  <assert-measure-is-not-protected name="[MEAS]" variable="MSG1"/>
</testcase>

</testsuite>
```

6.21 assert-measure-is-protected

This tag asserts a measures is protected based on previous edited.

Table 14-103 assert-measure-is-not-protected

Attribute	Required	Description
name	Yes	Name of workbook measure to assert is not protected
variable	No	Name of RPAC or environment variable to true/false based on the status of the measure being protected. If not provided, tag will report an error if the measure is not protected.
skip	No	Skip this tag if true (defaults to false)
stop	No	Stop rpac execution if true (defaults to false)
debug	No	Wait for debugger if true (defaults to false)

Example:

```
<testsuite name="Assert measure is protected">

<testcase name="fails if measure is not protected">
  <assert-measure-is-protected name="[MEAS]" />
</testcase>

<testcase name="set variable MSG1 to false/true base on measure being protected">
  <assert-measure-is-protected name="[MEAS]" variable="MSG1"/>
</testcase>

</testsuite>
```

7. Workbook Operations Tags

This section describes the Workbook Operations tags.

7.1 assert-window-contain-measure

This tag asserts current workbook named window either contains or does not contain a list of measures.

Table 14-104 assert-window-contain-measure

Attribute	Required	Description
name	Yes	Window name of current workbook
measures	No	Comma separated list of measures names
containflag	No	If true measures are expected to be contained in the current workbook windows.
skip	No	Skip this tag if true (defaults to false)
stop	No	Stop rpac execution if true (defaults to false)
debug	No	Wait for debugger if true (defaults to false)

Example:

```
<testcase>
  <set-environment-variable name="WINNAME" value="chnlscls_W"/>
  <set-environment-variable name="MEAS1" value="mpwpgmmx"/>
  <assert-window-contain-measure name="[WINNAME]" containflag="true"
measures="[MEAS1]"/>
</testcase>
```

7.2 assert-window-exists

This tag asserts if a window exists in the current workbook

Table 14-105 assert-window-exists

Attribute	Required	Description
name	Yes	Window name
skip	No	Skip this tag if true (defaults to false)
stop	No	Stop rpac execution if true (defaults to false)
debug	No	Wait for debugger if true (defaults to false)

Example:

```
<assert-window-exists name="MP_TB02_WS01"/>
```

7.3 assert-window-intersection

This tag asserts window intersection matches provided intersection.

Table 14-106 assert-window-intersection

Attribute	Required	Description
name	Yes	Window name
baseint	No	Intersection string to compare with
skip	No	Skip this tag if true (defaults to false)
stop	No	Stop rpac execution if true (defaults to false)
debug	No	Wait for debugger if true (defaults to false)

Example:

```
<assert-window-intersection name="MP_TB02_WS01" baseint="sclschnl"/>
```

7.4 assert-window-not-exists

This tag asserts if a window does not exist in the current workbook.

Table 14-107 assert-window-not-exists

Attribute	Required	Description
name	Yes	Window name
skip	No	Skip this tag if true (defaults to false)
stop	No	Stop rpac execution if true (defaults to false)
debug	No	Wait for debugger if true (defaults to false)

Example:

```
<assert-window-not-exists name="MP_TB02_TEST"/>
```

7.5 build

This tag builds workbook based on provided tag data.

Note that this tag can only be used within the workbook-operations tag. This tag supports these subtag wizard-page-settings.

Table 14-108 build

Attribute	Required	Description
template-name	Yes	Template name
user	Yes	User used to access workbook
label	No	Label for workbook (defaults to blank)
skip	No	Skip this tag if true (defaults to false)
stop	No	Stop rpac execution if true (defaults to false)
debug	No	Wait for debugger if true (defaults to false)

Example:

```

<workbook-operations>
  <build template-name="measureanalysis" label="MEAS AN" user="oci.admin">
    <wizard-page-settings id="ExtraMeasuresPage">
      <set-selections control-name="lb1">mpwpgmmx</set-selections>
    </wizard-page-settings>
    <wizard-page-settings id="scls">
      <set-tree-selections dim-name="scls" rollup-name="scls">10000001</set-tree-
selections>
    </wizard-page-settings>
    <wizard-page-settings id="chnl">
      <set-tree-selections dim-name="chnl" rollup-name="chnl">1</set-tree-
selections>
    </wizard-page-settings>
  </build>
</workbook-operations>

```

7.6 calc

This tag does workbook calc.

Note that this tag can only be used within the workbook-operations tag.

Table 14-109 calc

Attribute	Required	Description
template-name	Yes	Template name
user	Yes	User used to access workbook
skip	No	Skip this tag if true (defaults to false)
stop	No	Stop rpac execution if true (defaults to false)
debug	No	Wait for debugger if true (defaults to false)

Example:

```

<workbook-operations>
  <calc template-name="measureanalysis" user="oci.admin"/>
</workbook-operations>

```

7.7 close

This tag does workbook close.

Note that this tag can only be used within the workbook-operations tag.

Table 14-110 close

Attribute	Required	Description
skip	No	Skip this tag if true (defaults to false)
stop	No	Stop rpac execution if true (defaults to false)
debug	No	Wait for debugger if true (defaults to false)

Example:

```

<testcase>
  <workbook-operations>

```

```

    </close/>
  </workbook-operations>
</testcase>

```

7.8 commit

This tag does workbook commit.

Note that this tag can only be used within the workbook-operations tag.

Table 14-111 commit

Attribute	Required	Description
template-name	Yes	Template name
user	Yes	User used to access workbook
name	No	Name to use to refer to this commit ASAP (defaults to bank)
wait-for	No	Number of seconds to wait for the commit to complete. (defaults to 8 hours)
skip	No	Skip this tag if true (defaults to false)
stop	No	Stop rpac execution if true (defaults to false)
debug	No	Wait for debugger if true (defaults to false)

Example:

```

<workbook-operations>
  <commit template-name="measureanalysis" user="oci.admin"/>
</workbook-operations>

```

7.9 custom-menu

This tag handles a custom menu.

Note that this tag can only be used within the workbook-operations tag.

Table 14-112 custom-menu

Attribute	Required	Description
template-name	Yes	Template name
user	Yes	User used to access workbook
menu-label	Yes	Menu label for this custom menu
menu-exist	No	Flag to set to 'true' or 'false' to enable throwing an exception if the menu item is or is not found
skip	No	Skip this tag if true (defaults to false)
stop	No	Stop rpac execution if true (defaults to false)
debug	No	Wait for debugger if true (defaults to false)

Example:

```

<workbook-operations>
  <calc template-name="MP_WB" user="oci.admin"/>

```

```
<custom-menu template-name="MP_WB" user="oci.admin" menu-label="menuItem10101"/>
</workbook-operations>
```

7.10 set-hier-selection

This tag sets the selected of wizard page.

Note that this tag can only be used within the wizard-page-settings tag.

Table 14-113 set-hier-selection

Attribute	Required	Description
control-name	Yes	Name of the control for a wizard page
selection	Yes	Text for the selection operation
dim-name	Yes	Dimension name for the tree selection
skip	No	Skip this tag if true (defaults to false)
stop	No	Stop rpac execution if true (defaults to false)
debug	No	Wait for debugger if true (defaults to false)

7.11 set-selected

This tag sets the selected of wizard page.

Note that this tag can only be used within the wizard-page-settings tag.

Table 14-114 set-selected

Attribute	Required	Description
control-name	Yes	Name of the control for a wizard page
selected	Yes	Text for the selected operation
skip	No	Skip this tag if true (defaults to false)
stop	No	Stop rpac execution if true (defaults to false)
debug	No	Wait for debugger if true (defaults to false)

7.12 set-selection

This tag set the selection of wizard page.

Note that this tag can only be used within the wizard-page-settings tag.

Table 14-115 set-selection

Attribute	Required	Description
control-name	Yes	Name of the control for a wizard page
selection	Yes	Text for the selection operation
skip	No	Skip this tag if true (defaults to false)
stop	No	Stop rpac execution if true (defaults to false)

Table 14-115 (Cont.) set-selection

Attribute	Required	Description
debug	No	Wait for debugger if true (defaults to false)

7.13 set-selections

This tag set the selections of wizard page.

Note that this tag can only be used within the wizard-page-settings tag.

Table 14-116 set-selections

Attribute	Required	Description
control-name	Yes	Name of the control for a wizard page
skip	No	Skip this tag if true (defaults to false)
stop	No	Stop rpac execution if true (defaults to false)
debug	No	Wait for debugger if true (defaults to false)

Example:

```
<workbook-operations>
  <build template-name="measureanalysis" label="MEAS AN" user="oci.admin">
    <wizard-page-settings id="ExtraMeasuresPage">
      <set-selections control-name="lb1">mpwpgmmx</set-selections>
    </wizard-page-settings>
    <wizard-page-settings id="scls">
      <set-tree-selections dim-name="scls" rollup-name="scls">10000001</set-
tree-selections>
    </wizard-page-settings>
    <wizard-page-settings id="chnl">
      <set-tree-selections dim-name="chnl" rollup-name="chnl">1</set-tree-
selections>
    </wizard-page-settings>
  </build>
</workbook-operations>
```

7.14 set-text

This tag set the text of wizard page.

Note that this tag can only be used within the wizard-page-settings tag.

Table 14-117 set-text

Attribute	Required	Description
control-name	Yes	Name of the control for a wizard page
text	Yes	Text for the operation
skip	No	Skip this tag if true (defaults to false)
stop	No	Stop rpac execution if true (defaults to false)

Table 14-117 (Cont.) set-text

Attribute	Required	Description
debug	No	Wait for debugger if true (defaults to false)

7.15 set-tree-selections

This tag set the tree selections of wizard page.

Note that this tag can only be used within the wizard-page-settings tag.

Table 14-118 set-tree-selections

Attribute	Required	Description
rollup-name	Yes	Roll up name for the tree selection
dim-name	Yes	Dimension name for the tree selection
skip	No	Skip this tag if true (defaults to false)
stop	No	Stop rpc execution if true (defaults to false)
debug	No	Wait for debugger if true (defaults to false)

Example:

```
<workbook-operations>
  <build template-name="measureanalysis" label="MEAS AN" user="oci.admin">
    <wizard-page-settings id="ExtraMeasuresPage">
      <set-selections control-name="lb1">mpwpgmmx</set-selections>
    </wizard-page-settings>
    <wizard-page-settings id="scls">
      <set-tree-selections dim-name="scls" rollup-name="scls">10000001</set-tree-
selections>
    </wizard-page-settings>
    <wizard-page-settings id="chnl">
      <set-tree-selections dim-name="chnl" rollup-name="chnl">1</set-tree-
selections>
    </wizard-page-settings>
  </build>
</workbook-operations>
```

7.16 wizard-page-settings

This tag contains the settings for a wizard page.

Note that this tag can only be used within the build tag. This tag support the following subtags: set-hier-selection, set-selected, set-selection, set-selections, set-text, set-tree-selections.

Table 14-119 wizard-page-settings

Attribute	Required	Description
id	Yes	ID used to match up settings with wizard pages
skip	No	Skip this tag if true (defaults to false)

Table 14-119 (Cont.) wizard-page-settings

Attribute	Required	Description
stop	No	Stop rpc execution if true (defaults to false)
debug	No	Wait for debugger if true (defaults to false)

Example:

```

<workbook-operations>
  <build template-name="measureanalysis" label="MEAS AN" user="oci.admin">
    <wizard-page-settings id="ExtraMeasuresPage">
      <set-selections control-name="lb1">mpwpgmmx</set-selections>
    </wizard-page-settings>
    <wizard-page-settings id="scls">
      <set-tree-selections dim-name="scls" rollup-name="scls">10000001</set-
tree-selections>
    </wizard-page-settings>
    <wizard-page-settings id="chnl">
      <set-tree-selections dim-name="chnl" rollup-name="chnl">1</set-tree-
selections>
    </wizard-page-settings>
  </build>
</workbook-operations>

```

7.17 workbook-operations

This tag contains the workbook operation to be executed.

Note that this tag support the following subtags: build, calc, close, commit, custom-menu, open, rebuild, refresh, update-dpm.

Table 14-120 workbook-operations

Attribute	Required	Description
skip	No	Skip this tag if true (defaults to false)
stop	No	Stop rpc execution if true (defaults to false)
debug	No	Wait for debugger if true (defaults to false)

7.18 open

This tag opens given workbook.

Note that this tag can only be used within the workbook-operations tag.

Table 14-121 open

Attribute	Required	Description
workbook-name	Yes	Name of workbook
user	Yes	User that created the workbook
skip	No	Skip this tag if true (defaults to false)
stop	No	Stop rpc execution if true (defaults to false)

Table 14-121 (Cont.) open

Attribute	Required	Description
debug	No	Wait for debugger if true (defaults to false)

Example:

```
<testcase>
  <workbook-operations>
    <open workbook-name="[NEW_WORKBOOK]" user="[USER]"/>
  </workbook-operations>
</testcase>
```

7.19 rebuild

This tag rebuilds workbook base on segment Id of previous build of the workbook.

Note that this tag can only be used within the workbook-operations tag.

Table 14-122 rebuild

Attribute	Required	Description
segment-id	Yes	Segment ID of workbook to rebuild
user	Yes	User used to access the workbook
label	No	Label for workbook (defaults to blank)
skip	No	Skip this tag if true (defaults to false)
stop	No	Stop rpac execution if true (defaults to false)
debug	No	Wait for debugger if true (defaults to false)

Example:

```
<testcase>
  <workbook-operations>
    <rebuild segment-id="[NEW_SEGMENT]" user="[USER]" label="Translation Workbook"/>
  </workbook-operations>
</testcase>
```

7.20 refresh

This tag does workbook refresh.

Note that this tag can only be used within the workbook-operations tag.

Table 14-123 refresh

Attribute	Required	Description
user	Yes	User used to access the workbook
skip	No	Skip this tag if true (defaults to false)
stop	No	Stop rpac execution if true (defaults to false)
debug	No	Wait for debugger if true (defaults to false)

Example:

```
<testcase>
  <workbook-operations>
    <refresh user="[USER]"/>
  </workbook-operations>
</testcase>
```

7.21 delete-informal-position

This tag deletes the DPM data.

Table 14-124 delete-informal-position

Attribute	Required	Description
user	Yes	User used to access the workbook
skip	No	Skip this tag if true (defaults to false)
stop	No	Stop rpac execution if true (defaults to false)
debug	No	Wait for debugger if true (defaults to false)

Example:

```
<delete-informal-position levelname="str" position="strdpm_ut2"/>
```

7.22 update-dpm

This tag updates the DPM data.

Note that this tag can only be used within the workbook-operations tag.

Table 14-125 update-dpm

Attribute	Required	Description
skip	No	Skip this tag if true (defaults to false)
stop	No	Stop rpac execution if true (defaults to false)
debug	No	Wait for debugger if true (defaults to false)

7.23 update-informal-positions

This tag updates the informal positions.

Note that this tag support this subtag: dpmposinfo.

Table 14-126 update-informal-positions

Attribute	Required	Description
skip	No	Skip this tag if true (defaults to false)
stop	No	Stop rpac execution if true (defaults to false)
debug	No	Wait for debugger if true (defaults to false)

Example:

```

<update-informal-positions>
  <dpmposinfo lang="english">
    <dpmposentry levelname="dstr" position="dstr34" isnewpos="false" label="34
    SPAIN" oldposition="dstr34" type="0" count="1"/>
    <dpmposentry levelname="str" position="strdpm_ut2" isnewpos="true" label="Store
    DPM UT 1" oldposition="" type="0" count="1"/>
  </dpmposinfo>
</update-informal-positions>

```

7.24 dpmposentry

DPM position Entry.

Note that this tag can only be used within the dpmposinfo tag.

Table 14-127 dpmposentry

Attribute	Required	Description
levelname	Yes	Level Name
isnewpos	Yes	True for new position and false for modify
position	Yes	position name
label	No	position label
oldposition	No	old position name
type	No	type
count	No	count
skip	No	Skip this tag if true (defaults to false)
stop	No	Stop rpac execution if true (defaults to false)
debug	No	Wait for debugger if true (defaults to false)

Example:

```

<update-informal-positions>
  <dpmposinfo lang="english">
    <dpmposentry levelname="dstr" position="dstr34" isnewpos="false" label="34
    SPAIN" oldposition="dstr34" type="0" count="1"/>
    <dpmposentry levelname="str" position="strdpm_ut2" isnewpos="true" label="Store
    DPM UT 1" oldposition="" type="0" count="1"/>
  </dpmposinfo>
</update-informal-positions>

```

7.25 dpmposinfo

DPM position info.

Note that this tag can only be used within the update-informal-positions tag. This tag support this subtag: dpmposentry.

Table 14-128 dpmposinfo

Attribute	Required	Description
lang	Yes	Language attribute
skip	No	Skip this tag if true (defaults to false)
stop	No	Stop rpc execution if true (defaults to false)
debug	No	Wait for debugger if true (defaults to false)

Example:

```
<update-informal-positions>
  <dpmposinfo lang="english">
    <dpmposentry levelname="dstr" position="dstr34" isnewpos="false" label="34
SPAIN" oldposition="dstr34" type="0" count="1"/>
    <dpmposentry levelname="str" position="strdpm_ut2" isnewpos="true"
label="Store DPM UT 1" oldposition="" type="0" count="1"/>
  </dpmposinfo>
</update-informal-positions>
```

8. Workbook Execute Expression Tag

This section describes the Workbook Execute Expression tag.

8.1 workbook-execute-expression

This tag executes an expression in a workbook.

Table 14-129 workbook-execute-expression

Attribute	Required	Description
expression	Yes	The expression to execute/calculate
skip	No	Skip this tag if true (defaults to false)
stop	No	Stop rpc execution if true (defaults to false)
debug	No	Wait for debugger if true (defaults to false)

8.2 rule-debug-log

This tag logs a message to detail rule debug logging. Each occurrence of the message will be replaced with a new line.

Table 14-130 rule-debug-log

Attribute	Required	Description
msg	Yes	Message to be logged. Each occurrence of the message will be replaced with a new line.
skip	No	Skip this tag if true (defaults to false)
stop	No	Stop rpc execution if true (defaults to false)
debug	No	Wait for debugger if true (defaults to false)

Example:

```

<testsuite name="Rule detail debug example">

<testcase name="Default path">
  <rule-debug-start/>
  <rule-debug-log msg="This is a test
This is line2
This is line3"/>
  <rule-debug-stop/>
</testcase>

<testcase name="Given path">
  <rule-debug-start log-path="Larry"/>
  <rule-debug-log msg="This is the second test
This is line2
This is line3"/>
  <rule-debug-stop/>
</testcase>

</testsuite>

```

8.3 rule-debug-start

This tag starts the detail rule debug log.

Table 14-131 rule-debug-start

Attribute	Required	Description
log-path	No	The path which to send the detail rule logging. (This defaults to Rule_0000b00.log, where the first four zeros are replaced with the current line number and two zeros after the b are used to make the file name unique.)
skip	No	Skip this tag if true (defaults to false)
stop	No	Stop rpac execution if true (defaults to false)
debug	No	Wait for debugger if true (defaults to false)

Example:

```

<testsuite name="Rule detail debug example">

<testcase name="Default path">
  <rule-debug-start/>
  <rule-debug-log msg="This is a test
This is line2
This is line3"/>
  <rule-debug-stop/>
</testcase>

<testcase name="Given path">
  <rule-debug-start log-path="Larry"/>
  <rule-debug-log msg="This is the second test
This is line2
This is line3"/>
  <rule-debug-stop/>
</testcase>

```

```
</testsuite>
```

8.4 rule-debug-stop

This tag closes the detail rule debug logging.

Table 14-132 rule-debug-start

Attribute	Required	Description
skip	No	Skip this tag if true (defaults to false)
stop	No	Stop rpac execution if true (defaults to false)
debug	No	Wait for debugger if true (defaults to false)

Example:

```
<testsuite name="Rule detail debug example">

  <testcase name="Default path">
    <rule-debug-start/>
    <rule-debug-log msg="This is a test
This is line2
This is line3"/>
    <rule-debug-stop/>
  </testcase>

  <testcase name="Given path">
    <rule-debug-start log-path="Larry"/>
    <rule-debug-log msg="This is the second test
This is line2
This is line3"/>
    <rule-debug-stop/>
  </testcase>

</testsuite>
```

9. Processes, Tasks, Environment Variables, and DateTime Tags

This section describes the processes, tasks, environment variables, and DateTime tags.

9.1 task-log

Given a task id, a variable will be updated to the full path of the task log.

Table 14-133 task-log

Attribute	Required	Description
task-id	Yes	Task ID of the log wanted
name	Yes	Name of the variable to contain log file path
skip	No	Skip this tag if true (defaults to false)
stop	No	Stop rpac execution if true (defaults to false)

Table 14-133 (Cont.) task-log

Attribute	Required	Description
debug	No	Wait for debugger if true (defaults to false)

Example:

```
<testcase>
  <task-log task-id="[TASK_ID]" name="TASK_LOG"/>
  <assert-file-contains path="[TASK_LOG]" range="1:1" erase="true" text="[DATA]"/>
</testcase>
```

9.2 task-start

This tag starts a task process with the command line provided as the value of this tag.

Table 14-134 task-log

Attribute	Required	Description
is-script	No	Boolean to indicate that the process is a Task script (Defaults to false)
no-wait	No	Boolean to determine if RPAC will wait for process to exit (Defaults to false)
check-status	No	Boolean to determine if a non-zero return status will throw an exception (defaults to true)
assert-status-equal	No	Assert return status equals provide value (value defaults to zero)
assert-status-not-equal	No	Assert return status does not equals provide value (value defaults to zero)
task-name	No	Name to use for task (defaults to blank string)
task-label	No	Label to use for task (defaults to blank string)
task-domain-access	No	Limit access (None, Restricted, Offline) Restricted allow other processes limited access, Offline only allows admin processes to monitor tasks (defaults to None)
message	No	Message to use for either Full or Offline access (defaults to blank string)
wait-for	No	Number of seconds to wait for the task to complete (defaults to 8 hours)
timeout	No	Number of seconds to wait to access when using access modes Restricted or Offline (defaults to 2 hours)
skip	No	Skip this tag if true (defaults to false)
stop	No	Stop rpac execution if true (defaults to false)
debug	No	Wait for debugger if true (defaults to false)

Example:

```
<testcase>
  <task-start
    task-name ="Start domaininfo task"
    task-label="Start domaininfo task"
```

```

    wait-for ="120">
      domaininfo -d [PDS_PATH] -domaininversion
    </task-start>
  </testcase>

```

9.3 task-wait

This tag waits for RPAC created task to exit.

Table 14-135 task-wait

Attribute	Required	Description
task-id	Yes	Task id to wait for
check-status	No	Boolean to determine if a non-zero return status will throw an exception (defaults to true)
assert-status-equal	No	Assert return status equals provide value (value defaults to zero)
assert-status-not-equal	No	Assert return status does not equals provide value (value defaults to zero)
wait-for	No	Number of seconds to wait for (defaults to 8 hours)
skip	No	Skip this tag if true (defaults to false)
stop	No	Stop rpac execution if true (defaults to false)
debug	No	Wait for debugger if true (defaults to false)

Example:

```

<testcase>
  <task-wait task-id="[TASK_ID]"/>
</testcase>

```

9.4 sleep

This tag sleeps for 1 second or value provide with attributes.

Table 14-136 sleep

Attribute	Required	Description
seconds	No	Number of seconds for sleep
milliseconds	No	Number of milliseconds for sleep
skip	No	Skip this tag if true (defaults to false)
stop	No	Stop rpac execution if true (defaults to false)
debug	No	Wait for debugger if true (defaults to false)

Example:

```

<sleep seconds="1"/>

```

9.5 shell

This tag starts a shell process with the command provided as the value of this tag.

Table 14-137 shell

Attribute	Required	Description
working-directory	No	Directory to use for shell, if not provided then the current working directory is used
is-shell	No	Boolean to indicate that the process is a shell script
check-status	No	Boolean to determine if a non-zero return status will throw an exception (defaults to true)
append-to-log	No	Boolean to determine if process should append to output log
remove-output	No	Boolean to determine if output is erase if there are no errors (defaults to true)
assert-status-equal	No	Assert return status equals provide value
assert-status-not-equal	No	Assert return status does not equals provide value
output	No	File name to which shell command will redirect its output
no-wait	No	Boolean to determine if RPAC will wait for process to exit
wait-for	No	Number of seconds to wait for
name	No	Name to use for process
unique-file	No	Name of the environmental variable to contain unique file path. Output of process will be log to this file path.
timer-file	No	File name to which process execution time will be appended to.
skip	No	Skip this tag if true (defaults to false)
stop	No	Stop rpac execution if true (defaults to false)
debug	No	Wait for debugger if true (defaults to false)

Example:

```
<shell check-status="true" is-shell="false">mkdir "[PDS_PATH]/emptyDir"</shell>
```

9.6 set-date-format

This tag sets the date/time format of that [RPAC_DATE] variable with use.

Table 14-138 set-date-format

Attribute	Required	Description
calue	Yes	Date/time format to use for [RPAC_DATE] variable
skip	No	Skip this tag if true (defaults to false)
stop	No	Stop rpac execution if true (defaults to false)
debug	No	Wait for debugger if true (defaults to false)

9.7 set-environment-variable

This tag sets the value of an environmental variable.

Table 14-139 set-environment-variable

Attribute	Required	Description
name	Yes	Name of the environmental variable
value	Yes	Value of the environmental variable
export	No	Boolean to determine if variable will be exported (defaults to false)
normalize	No	Boolean to indicate variable is file path that should be normalize (defaults to false)
skip	No	Skip this tag if true (defaults to false)
stop	No	Stop rpac execution if true (defaults to false)
debug	No	Wait for debugger if true (defaults to false)

Example:

```
<testcase>
  <set-environment-variable name="INPUT" value="[PDS_PATH]/input"/>
  <set-environment-variable name="PROCESSED" value="[INPUT]/processed"/>
  <set-environment-variable name="MY_WORKBOOK" value="[WORKBOOK_NAME]"
export="true"/>
</testcase>
```

9.8 rpas-today

This tag sets the RpasToday environmental variable to value of this tag.

Table 14-140 rpas-today

Attribute	Required	Description
skip	No	Skip this tag if true (defaults to false)
stop	No	Stop rpac execution if true (defaults to false)
debug	No	Wait for debugger if true (defaults to false)

Example:

```
<rpas-today>20070101</rpas-today>
```

Where: the date is given in yyyyymmdd format.

9.9 process-stop

This tag stops RPAC created process.

Table 14-141 process-stop

Attribute	Required	Description
name	Yes	Name used for the process
skip	No	Skip this tag if true (defaults to false)

Table 14-141 (Cont.) process-stop

Attribute	Required	Description
stop	No	Stop rpac execution if true (defaults to false)
debug	No	Wait for debugger if true (defaults to false)

9.10 process-wait

This tag waits for RPAC created process to exit.

Table 14-142 process-wait

Attribute	Required	Description
name	Yes	Name used for the process
wait-for	No	Number of seconds to wait for
assert-status-equal	No	Assert return status equals provide value
assert-status-not-equal	No	Assert return status does not equals provide value
remove-output	No	Boolean to determine is output is erase if there is no error (defaults to true)
throw-error	No	Boolean to determine if wait will throw an exception if process does not exit (defaults to true)
skip	No	Skip this tag if true (defaults to false)
stop	No	Stop rpac execution if true (defaults to false)
debug	No	Wait for debugger if true (defaults to false)

9.11 get-unique-file-path

This tag sets the value of an environmental variable to a unique file path.

Table 14-143 get-unique-file-path

Attribute	Required	Description
name	Yes	Name of the environmental variable to contain unique file path
export	No	Boolean to determine if variable will be exported (defaults to false)
extension	No	File extension to used (defaults to .log) (defaults to false)
skip	No	Skip this tag if true (defaults to false)
stop	No	Stop rpac execution if true (defaults to false)
debug	No	Wait for debugger if true (defaults to false)

Example:

```
<testcase>
  <set-environment-variable name="MEAS" value="rpacMeasure %s NA NA"/>
```

```

<get-unique-file-path name="FILEPATH"/>
<shell>exportMeasure -rdm [PDS_PATH] -meas "[MEAS]" -out [FILEPATH]</shell>
<compare-file-content path="[FILEPATH]">
  "w02_2007Test1"|
  "w03_2007Test2"|
  "w04_2007Test3"
</compare-file-content>
</testcase>

```

9.12 assert-numeric-value-eq

This tag asserts an RPAC or environment variable is equal to an expected value.

Table 14-144 assert-numeric-value-eq

Attribute	Required	Description
name	Yes	Name of RPAC or the environmental variable.
value	No	Expected value (defaults to 0)
type	No	Must provide type of value as one of these strings slong32, or double (defaults to double).
skip	No	Skip this tag if true (defaults to false)
stop	No	Stop rpac execution if true (defaults to false)
debug	No	Wait for debugger if true (defaults to false)

Example:

```

<once>
  <set-environment-variable name="VALUE1" value="32"/>
  <set-environment-variable name="VALUE2" value="3.145"/>
</once>

<testcase name="Check equal 32">
  <assert-numeric-value-eq name="VALUE1" value="32" type="slong32"/>
</testcase>

<testcase name="Check equal 3.145">
  <assert-numeric-value-eq name="VALUE2" value="3.145" type="double"/>
</testcase>

<testcase name="Check equal 3.145">
  <assert-numeric-value-eq name="VALUE2" value="3.145"/>
</testcase>

```

9.13 assert-numeric-value-ge

This tag asserts an RPAC or environment variable is greater than or equal to an expected value.

Table 14-145 assert-numeric-value-ge

Attribute	Required	Description
name	Yes	Name of RPAC or the environmental variable.
value	No	Expected value (defaults to 0)

Table 14-145 (Cont.) assert-numeric-value-ge

Attribute	Required	Description
type	No	Must provide type of value as one of these strings slong32, or double (defaults to double).
skip	No	Skip this tag if true (defaults to false)
stop	No	Stop rpac execution if true (defaults to false)
debug	No	Wait for debugger if true (defaults to false)

Example:

```

<once>
  <set-environment-variable name="VALUE1" value="32"/>
  <set-environment-variable name="VALUE2" value="3.145"/>
</once>

<testcase name="Check great than or equal 32">
  <assert-numeric-value-ge name="VALUE1" value="32" type="slong32"/>
</testcase>

<testcase name="Check great than or equal 3.145">
  <assert-numeric-value-ge name="VALUE2" value="3.145" type="double"/>
</testcase>

<testcase name="Check great than or equal 3.145">
  <assert-numeric-value-ge name="VALUE2" value="3.145"/>
</testcase>

```

9.14 assert-numeric-value-gt

This tag asserts an RPAC or environment variable is greater than an expected value.

Table 14-146 assert-numeric-value-gt

Attribute	Required	Description
name	Yes	Name of RPAC or the environmental variable.
value	No	Expected value (defaults to 0)
type	No	Must provide type of value as one of these strings slong32, or double (defaults to double).
skip	No	Skip this tag if true (defaults to false)
stop	No	Stop rpac execution if true (defaults to false)
debug	No	Wait for debugger if true (defaults to false)

Example:

```

<once>
  <set-environment-variable name="VALUE1" value="32"/>
  <set-environment-variable name="VALUE2" value="3.145"/>
</once>

<testcase name="Check great than 32">
  <assert-numeric-value-gt name="VALUE1" value="33" type="slong32"/>

```

```

</testcase>

<testcase name="Check great than 3.145">
  <assert-numeric-value-gt name="VALUE2" value="3.146" type="double"/>
</testcase>

<testcase name="Check great than 3.145">
  <assert-numeric-value-gt name="VALUE2" value="3.146"/>
</testcase>

```

9.15 assert-numeric-value-le

This tag asserts an RPAC or environment variable is less than or equal to an expected value.

Table 14-147 assert-numeric-value-le

Attribute	Required	Description
name	Yes	Name of RPAC or the environmental variable.
value	No	Expected value (defaults to 0)
type	No	Must provide type of value as one of these strings slong32, or double (defaults to double).
skip	No	Skip this tag if true (defaults to false)
stop	No	Stop rpac execution if true (defaults to false)
debug	No	Wait for debugger if true (defaults to false)

Example:

```

<once>
  <set-environment-variable name="VALUE1" value="32"/>
  <set-environment-variable name="VALUE2" value="3.145"/>
</once>

<testcase name="Check less than or equal 32">
  <assert-numeric-value-le name="VALUE1" value="32" type="slong32"/>
</testcase>

<testcase name="Check less than or equal 3.145">
  <assert-numeric-value-le name="VALUE2" value="3.145" type="double"/>
</testcase>

<testcase name="Check less than or equal 3.145">
  <assert-numeric-value-le name="VALUE2" value="3.145"/>
</testcase>

```

9.16 assert-numeric-value-lt

This tag asserts an RPAC or environment variable is less than an expected value.

Table 14-148 assert-numeric-value-lt

Attribute	Required	Description
name	Yes	Name of RPAC or the environmental variable.

Table 14-148 (Cont.) assert-numeric-value-lt

Attribute	Required	Description
value	No	Expected value (defaults to 0)
type	No	Must provide type of value as one of these strings slong32, or double (defaults to double).
skip	No	Skip this tag if true (defaults to false)
stop	No	Stop rpac execution if true (defaults to false)
debug	No	Wait for debugger if true (defaults to false)

Example:

```

<once>
  <set-environment-variable name="VALUE1" value="32"/>
  <set-environment-variable name="VALUE2" value="3.145"/>
</once>

<testcase name="Check less than 32">
  <assert-numeric-value-lt name="VALUE1" value="31" type="slong32"/>
</testcase>

<testcase name="Check less than 3.145">
  <assert-numeric-value-lt name="VALUE2" value="3.14" type="double"/>
</testcase>

<testcase name="Check less than 3.145">
  <assert-numeric-value-lt name="VALUE2" value="3.14"/>
</testcase>

```

9.17 assert-numeric-value-ne

This tag asserts an RPAC or environment variable is not equal to an expected value.

Table 14-149 assert-numeric-value-ne

Attribute	Required	Description
name	Yes	Name of RPAC or the environmental variable.
value	No	Expected value (defaults to 0)
type	No	Must provide type of value as one of these strings slong32, or double (defaults to double).
skip	No	Skip this tag if true (defaults to false)
stop	No	Stop rpac execution if true (defaults to false)
debug	No	Wait for debugger if true (defaults to false)

Example:

```

<once>
  <set-environment-variable name="VALUE1" value="32"/>
  <set-environment-variable name="VALUE2" value="3.145"/>
</once>

<testcase name="Check not equal 32">

```

```

    <assert-numeric-value-ne name="VALUE1" value="33" type="slong32"/>
</testcase>

<testcase name="Check not equal 3.145">
  <assert-numeric-value-ne name="VALUE2" value="3.146" type="double"/>
</testcase>

<testcase name="Check not equal 3.145">
  <assert-numeric-value-ne name="VALUE2" value="3.146"/>
</testcase>

```

9.18 assert-string-value-contains

This tag asserts an RPAC or environment variable contains an expected value.

Table 14-150 assert-string-value-contains

Attribute	Required	Description
name	Yes	Name of RPAC or the environmental variable.
value	No	Expected value (defaults to 0)
case-sensitive	No	Case sensitive (defaults to false)
skip	No	Skip this tag if true (defaults to false)
stop	No	Stop rpac execution if true (defaults to false)
debug	No	Wait for debugger if true (defaults to false)

Example:

```

<once>
  <set-environment-variable name="VALUE" value="Alpha"/>
</once>

<testcase name="Check equal Alpha">
  <assert-string-value-contains name="VALUE" value="Alpha"/>
</testcase>

<testcase name="Check equal ALPHA">
  <assert-string-value-contains name="VALUE" value="ALPHA" case-
sensitive="true"/>
</testcase>

```

9.19 assert-string-value-does-not-contain

This tag asserts an RPAC or environment variable does not contain an expected value.

Table 14-151 assert-string-value-does-not-contain

Attribute	Required	Description
name	Yes	Name of RPAC or the environmental variable.
value	No	Expected value (defaults to 0).
case-sensitive	No	Case sensitive (defaults to false)
skip	No	Skip this tag if true (defaults to false)

Table 14-151 (Cont.) assert-string-value-does-not-contain

Attribute	Required	Description
stop	No	Stop rpac execution if true (defaults to false)
debug	No	Wait for debugger if true (defaults to false)

Example:

```
<once>
  <set-environment-variable name="VALUE" value="Alpha"/>
</once>

<testcase name="Check equal Alpha">
  <assert-string-value-does-not-contain name="VALUE" value="Alpha"/>
</testcase>

<testcase name="Check equal ALPHA">
  <assert-string-value-does-not-contain name="VALUE" value="ALPHA" case-
sensitive="true"/>
</testcase>
```

9.20 assert-string-value-equal

This tag asserts an RPAC or environment variable is equal to an expected value.

Table 14-152 assert-string-value-equal

Attribute	Required	Description
name	Yes	Name of RPAC or the environmental variable.
value	No	Expected value (defaults to 0).
case-sensitive	No	Case sensitive (defaults to false)
skip	No	Skip this tag if true (defaults to false)
stop	No	Stop rpac execution if true (defaults to false)
debug	No	Wait for debugger if true (defaults to false)

Example:

```
<once>
  <set-environment-variable name="VALUE" value="Alpha"/>
</once>

<testcase name="Check equal Alpha">
  <assert-string-value-equal name="VALUE" value="Alpha"/>
</testcase>

<testcase name="Check equal ALPHA">
  <assert-string-value-equal name="VALUE" value="ALPHA" case-sensitive="true"/>
</testcase>
```

9.21 assert-string-value-not-equal

This tag asserts an RPAC or environment variable is not equal to an expected value.

Table 14-153 assert-string-value-not-equal

Attribute	Required	Description
name	Yes	Name of RPAC or the environmental variable.
value	No	Expected value (defaults to 0).
case-sensitive	No	Case sensitive (defaults to false)
skip	No	Skip this tag if true (defaults to false)
stop	No	Stop rpac execution if true (defaults to false)
debug	No	Wait for debugger if true (defaults to false)

Example:

```

<once>
  <set-environment-variable name="VALUE" value="Alpha"/>
</once>

<testcase name="Check equal Alpha">
  <assert-string-value-not-equal name="VALUE" value="Alpha"/>
</testcase>

<testcase name="Check equal ALPHA">
  <assert-string-value-not-equal name="VALUE" value="ALPHA" case-
sensitive="true"/>
</testcase>

```

9.22 if-numeric-value-eq-then-set

This tag asserts if an RPAC or environment variable is equal to an expected value then update RPAC variable to set value.

Table 14-154 if-numeric-value-eq-then-set

Attribute	Required	Description
name	Yes	Name of RPAC or the environmental variable to test.
variable	Yes	Name of RPAC or environment variable to set when comparison is true.
type	No	Must provide type of value as one of these strings slong32 or double (defaults to double).
value	No	Expected value (defaults to 0)
set-value	No	Value to assign to given variable if comparison is true (Defaults to true).
export	No	Boolean to determine if variable will be exported (defaults to false)
skip	No	Skip this tag if true (defaults to false)
stop	No	Stop rpac execution if true (defaults to false)
debug	No	Wait for debugger if true (defaults to false)

Example:

```

<once>
  <set-environment-variable name="VALUE1" value="32"/>
  <set-environment-variable name="VALUE2" value="3.145"/>
</once>

<testcase name="Check equal 32">
  <if-numeric-value-eq-then-set name="VALUE1" variable="VALUE3" value="32"
type="slong32"/>
</testcase>

<testcase name="Check equal 3.145">
  <if-numeric-value-eq-then-set name="VALUE2" variable="VALUE4" value="3.145"
type="double"/>
</testcase>

<testcase name="Check equal 3.145">
  <if-numeric-value-eq-then-set name="VALUE2" variable="VALUE5" value="3.145"/>
</testcase>

<testcase name="Check equal 32">
  <if-numeric-value-eq-then-set name="VALUE1" variable="VALUE6" value="32"
type="slong32" set-value="Value is 32"/>
</testcase>

```

9.23 if-numeric-value-ge-then-set

This tag asserts if an RPAC or environment variable is greater than or equal to an expected value then update RPAC variable to set value.

Table 14-155 if-numeric-value-ge-then-set

Attribute	Required	Description
name	Yes	Name of RPAC or the environmental variable to test.
variable	Yes	Name of RPAC or environment variable to set when comparison is true.
type	No	Must provide type of value as one of these strings slong32 or double (defaults to double).
value	No	Expected value (defaults to 0)
set-value	No	Value to assign to given variable if comparison is true (Defaults to true).
export	No	Boolean to determine if variable will be exported (defaults to false)
skip	No	Skip this tag if true (defaults to false)
stop	No	Stop rpac execution if true (defaults to false)
debug	No	Wait for debugger if true (defaults to false)

Example:

```

<once>
  <set-environment-variable name="VALUE1" value="32"/>
  <set-environment-variable name="VALUE2" value="3.145"/>
</once>

<testcase name="Check greater than or equal 32">
  <if-numeric-value-ge-then-set name="VALUE1" variable="VALUE3" value="32"

```

```

type="slong32"/>
</testcase>

<testcase name="Check greater than or equal 3.145">
  <if-numeric-value-ge-then-set name="VALUE2" variable="VALUE4" value="3.145"
type="double"/>
</testcase>

<testcase name="Check greater than or equal 3.145">
  <if-numeric-value-ge-then-set name="VALUE2" variable="VALUE5" value="3.145"/>
</testcase>

<testcase name="Check greater than or equal 32">
  <if-numeric-value-ge-then-set name="VALUE1" variable="VALUE6" value="32"
type="slong32" set-value="Value is 32"/>
</testcase>

```

9.24 if-numeric-value-gt-then-set

This tag asserts if an RPAC or environment variable is greater than an expected value then update RPAC variable to set value.

Table 14-156 if-numeric-value-gt-then-set

Attribute	Required	Description
name	Yes	Name of RPAC or the environmental variable to test.
variable	Yes	Name of RPAC or environment variable to set when comparison is true.
type	No	Must provide type of value as one of these strings slong32 or double (defaults to double).
value	No	Expected value (defaults to 0)
set-value	No	Value to assign to given variable if comparison is true (Defaults to true).
export	No	Boolean to determine if variable will be exported (defaults to false)
skip	No	Skip this tag if true (defaults to false)
stop	No	Stop rpac execution if true (defaults to false)
debug	No	Wait for debugger if true (defaults to false)

Example:

```

<once>
  <set-environment-variable name="VALUE1" value="32"/>
  <set-environment-variable name="VALUE2" value="3.145"/>
</once>

<testcase name="Check greater than 32">
  <if-numeric-value-gt-then-set name="VALUE1" variable="VALUE3" value="32"
type="slong32"/>
</testcase>

<testcase name="Check greater than 3.145">
  <if-numeric-value-gt-then-set name="VALUE2" variable="VALUE4" value="3.145"
type="double"/>
</testcase>

```

```

<testcase name="Check greater than 3.145">
  <if-numeric-value-gt-then-set name="VALUE2" variable="VALUE5" value="3.145"/>
</testcase>

<testcase name="Check greater than 32">
  <if-numeric-value-gt-then-set name="VALUE1" variable="VALUE6" value="32"
type="slong32" set-value="Value is 32"/>
</testcase>

```

9.25 if-numeric-value-le-then-set

This tag asserts if an RPAC or environment variable is less than or equal to an expected value then update RPAC variable to set value.

Table 14-157 if-numeric-value-le-then-set

Attribute	Required	Description
name	Yes	Name of RPAC or the environmental variable to test.
variable	Yes	Name of RPAC or environment variable to set when comparison is true.
type	No	Must provide type of value as one of these strings slong32 or double (defaults to double).
value	No	Expected value (defaults to 0)
set-value	No	Value to assign to given variable if comparison is true (Defaults to true).
export	No	Boolean to determine if variable will be exported (defaults to false)
skip	No	Skip this tag if true (defaults to false)
stop	No	Stop rpac execution if true (defaults to false)
debug	No	Wait for debugger if true (defaults to false)

Example:

```

<once>
  <set-environment-variable name="VALUE1" value="32"/>
  <set-environment-variable name="VALUE2" value="3.145"/>
</once>

<testcase name="Check less than or equal 32">
  <if-numeric-value-le-then-set name="VALUE1" variable="VALUE3" value="32"
type="slong32"/>
</testcase>

<testcase name="Check less than or equal 3.145">
  <if-numeric-value-le-then-set name="VALUE2" variable="VALUE4" value="3.145"
type="double"/>
</testcase>

<testcase name="Check less than or equal 3.145">
  <if-numeric-value-le-then-set name="VALUE2" variable="VALUE5" value="3.145"/>
</testcase>

<testcase name="Check less than or equal 32">
  <if-numeric-value-le-then-set name="VALUE1" variable="VALUE6" value="32"

```

```
type="slong32" set-value="Value is 32"/>
</testcase>
```

9.26 if-numeric-value-lt-then-set

This tag asserts if an RPAC or environment variable is less than an expected value then update RPAC variable to set value.

Table 14-158 if-numeric-value-lt-then-set

Attribute	Required	Description
name	Yes	Name of RPAC or the environmental variable to test.
variable	Yes	Name of RPAC or environment variable to set when comparison is true.
type	No	Must provide type of value as one of these strings slong32 or double (defaults to double).
value	No	Expected value (defaults to 0)
set-value	No	Value to assign to given variable if comparison is true (Defaults to true).
export	No	Boolean to determine if variable will be exported (defaults to false)
skip	No	Skip this tag if true (defaults to false)
stop	No	Stop rpac execution if true (defaults to false)
debug	No	Wait for debugger if true (defaults to false)

Example:

```
<once>
  <set-environment-variable name="VALUE1" value="32"/>
  <set-environment-variable name="VALUE2" value="3.145"/>
</once>

<testcase name="Check less than 32">
  <if-numeric-value-lt-then-set name="VALUE1" variable="VALUE3" value="32"
type="slong32"/>
</testcase>

<testcase name="Check less than 3.145">
  <if-numeric-value-lt-then-set name="VALUE2" variable="VALUE4" value="3.145"
type="double"/>
</testcase>

<testcase name="Check less than 3.145">
  <if-numeric-value-lt-then-set name="VALUE2" variable="VALUE5" value="3.145"/>
</testcase>

<testcase name="Check less than 32">
  <if-numeric-value-lt-then-set name="VALUE1" variable="VALUE6" value="32"
type="slong32" set-value="Value is 32"/>
</testcase>
```

9.27 if-numeric-value-ne-then-set

This tag asserts if an RPAC or environment variable is not equal to an expected value then update RPAC variable to set value.

Table 14-159 if-numeric-value-ne-then-set

Attribute	Required	Description
name	Yes	Name of RPAC or the environmental variable to test.
variable	Yes	Name of RPAC or environment variable to set when comparison is true.
type	No	Must provide type of value as one of these strings slong32 or double (defaults to double).
value	No	Expected value (defaults to 0)
set-value	No	Value to assign to given variable if comparison is true (Defaults to true).
export	No	Boolean to determine if variable will be exported (defaults to false)
skip	No	Skip this tag if true (defaults to false)
stop	No	Stop rpc execution if true (defaults to false)
debug	No	Wait for debugger if true (defaults to false)

Example:

```
<once>
  <set-environment-variable name="VALUE1" value="32"/>
  <set-environment-variable name="VALUE2" value="3.145"/>
</once>

<testcase name="Check not equal 32">
  <if-numeric-value-ne-then-set name="VALUE1" variable="VALUE3" value="32"
  type="slong32"/>
</testcase>

<testcase name="Check not equal 3.145">
  <if-numeric-value-ne-then-set name="VALUE2" variable="VALUE4" value="3.145"
  type="double"/>
</testcase>

<testcase name="Check not equal 3.145">
  <if-numeric-value-ne-then-set name="VALUE2" variable="VALUE5" value="3.145"/>
</testcase>

<testcase name="Check not equal 32">
  <if-numeric-value-ne-then-set name="VALUE1" variable="VALUE6" value="32"
  type="slong32" set-value="Value is 32"/>
</testcase>
```

9.28 if-string-value-contains-then-set

This tag asserts if an RPAC or environment variable contains an expected value then update the RPAC variable to set value.

Table 14-160 if-string-value-contains-then-set

Attribute	Required	Description
name	Yes	Name of RPAC or the environmental variable to test.
variable	Yes	Name of RPAC or environment variable to set when comparison is true.
value	No	Expected value (defaults to empty string)
set-value	No	Value to assign to given variable if comparison is true (defaults to true).
case-sensitive	No	Case sensitive (defaults to false)
export	No	Boolean to determine if variable will be exported (defaults to false)
skip	No	Skip this tag if true (defaults to false)
stop	No	Stop rpac execution if true (defaults to false)
debug	No	Wait for debugger if true (defaults to false)

Example:

```

<once>
  <set-environment-variable name="VALUE1" value="Alpha"/>
</once>

<testcase name="Assign Value2="true" if VALUE1 contains Alpha">
  <if-string-value-contains-then-set name="VALUE1" variable="VALUE2"
value="Alpha"/>
</testcase>

<testcase name="Assign Value3="Is Alpha" if VALUE1 contains Alpha">
  <if-string-value-contains-then-set name="VALUE1" variable="VALUE3"
value="Alpha" set-value="Is Alpha"/>
</testcase>

<testcase name="Assign Value4="true" if VALUE1 contains alpha">
  <if-string-value-contains-then-set name="VALUE1" variable="VALUE4"
value="alpha" case-sensitive="false"/>
</testcase>

```

9.29 if-string-value-does-not-contain-then-set

This tag asserts if an RPAC or environment variable does not contain an expected value then update the RPAC variable to set value.

Table 14-161 if-string-value-does-not-contain-then-set

Attribute	Required	Description
name	Yes	Name of RPAC or the environmental variable to test.
variable	Yes	Name of RPAC or environment variable to set when comparison is true.
value	No	Expected value (defaults to empty string)

Table 14-161 (Cont.) if-string-value-does-not-contain-then-set

Attribute	Required	Description
set-value	No	Value to assign to given variable if comparison is true (defaults to true).
case-sensitive	No	Case sensitive (defaults to false)
export	No	Boolean to determine if variable will be exported (defaults to false)
skip	No	Skip this tag if true (defaults to false)
stop	No	Stop rpac execution if true (defaults to false)
debug	No	Wait for debugger if true (defaults to false)

Example:

```
<once>
  <set-environment-variable name="VALUE1" value="Alpha"/>
</once>

<testcase name="Assign Value2="true" if VALUE1 does not contain Alpha">
  <if-string-value-does-not-contain-then-set name="VALUE1" variable="VALUE2"
value="Alpha"/>
</testcase>

<testcase name="Assign Value3="Is Alpha" if VALUE1 does not contain Alpha">
  <if-string-value-does-not-contain-then-set name="VALUE1" variable="VALUE3"
value="Alpha" set-value="Is Alpha"/>
</testcase>

<testcase name="Assign Value4="true" if VALUE1 does not contain alpha">
  <if-string-value-does-not-contain-then-set name="VALUE1" variable="VALUE4"
value="alpha" case-sensitive="false"/>
</testcase>
```

9.30 if-string-value-equal-then-set

This tag asserts if an RPAC or environment variable is equal to an expected value then update the RPAC variable to set value.

Table 14-162 if-string-value-equal-then-set

Attribute	Required	Description
name	Yes	Name of RPAC or the environmental variable to test.
variable	Yes	Name of RPAC or environment variable to set when comparison is true.
value	No	Expected value (defaults to empty string)
set-value	No	Value to assign to given variable if comparison is true (defaults to true).
case-sensitive	No	Case sensitive (defaults to false)
export	No	Boolean to determine if variable will be exported (defaults to false)

Table 14-162 (Cont.) if-string-value-equal-then-set

Attribute	Required	Description
skip	No	Skip this tag if true (defaults to false)
stop	No	Stop rpac execution if true (defaults to false)
debug	No	Wait for debugger if true (defaults to false)

Example:

```

<once>
  <set-environment-variable name="VALUE1" value="Alpha"/>
</once>

<testcase name="Assign Value2="true" if VALUE1 equal Alpha">
  <if-string-value-equal-then-set name="VALUE1" variable="VALUE2"
value="Alpha"/>
</testcase>

<testcase name="Assign Value3="Is Alpha" if VALUE1 equal Alpha">
  <if-string-value-equal-then-set name="VALUE1" variable="VALUE3" value="Alpha"
set-value="Is Alpha"/>
</testcase>

<testcase name="Assign Value4="true" if VALUE1 equal alpha">
  <if-string-value-equal-then-set name="VALUE1" variable="VALUE4" value="alpha"
case-sensitive="false"/>
</testcase>

```

9.30 if-string-value-not-equal-then-set

This tag asserts if an RPAC or environment variable is not equal to an expected value then update the RPAC variable to set value.

Table 14-163 if-string-value-not-equal-then-set

Attribute	Required	Description
name	Yes	Name of RPAC or the environmental variable to test.
variable	Yes	Name of RPAC or environment variable to set when comparison is true.
value	No	Expected value (defaults to empty string)
set-value	No	Value to assign to given variable if comparison is true (defaults to true).
case-sensitive	No	Case sensitive (defaults to false)
export	No	Boolean to determine if variable will be exported (defaults to false)
skip	No	Skip this tag if true (defaults to false)
stop	No	Stop rpac execution if true (defaults to false)
debug	No	Wait for debugger if true (defaults to false)

Example:

```

<once>
  <set-environment-variable name="VALUE1" value="Alpha"/>
</once>

<testcase name="Assign Value2="true" if VALUE1 not equal Alpha">
  <if-string-value-not-equal-then-set name="VALUE1" variable="VALUE2" value="Alpha"/>
</testcase>

<testcase name="Assign Value3="Is Alpha" if VALUE1 not equal Alpha">
  <if-string-value-not-equal-then-set name="VALUE1" variable="VALUE3" value="Alpha"
set-value="Is Alpha"/>
</testcase>

<testcase name="Assign Value4="true" if VALUE1 equal not alpha">
  <if-string-value-not-equal-then-set name="VALUE1" variable="VALUE4" value="alpha"
case-sensitive="false"/>
</testcase>

```

10. Misc Tags

This section describes the miscellaneous tags.

10.1 clear-all-measures

This tag clears all measures changed since starting RPAC.

Table 14-164 clear-all-measures

Attribute	Required	Description
skip	No	Skip this tag if true (defaults to false)
stop	No	Stop rpac execution if true (defaults to false)
debug	No	Wait for debugger if true (defaults to false)

Example:

```

<testcase
  name="clear all measures">
  <clear-all-measures/>
</testcase>

```

10.2 fail

This tag creates a failure message.

Table 14-165 fail

Attribute	Required	Description
msg	No	Message to used in failure text
skip	No	Skip this tag if true (defaults to false)
stop	No	Stop rpac execution if true (defaults to false)
debug	No	Wait for debugger if true (defaults to false)

10.3 log

This tag logs a message to the console.

Table 14-166 log

Attribute	Required	Description
msg	No	Message to be logged to the console
level	No	Level to log message at
skip	No	Skip this tag if true (defaults to false)
stop	No	Stop rpac execution if true (defaults to false)
debug	No	Wait for debugger if true (defaults to false)

Example:

```
<log level="basic" msg="Testing log tag"/>
```

10.4 reset-seq-generator

This tag restarts a SQL sequence generator back to 1.

Table 14-167 reset-seq-generator

Attribute	Required	Description
skip	No	Skip this tag if true (defaults to false)
stop	No	Stop rpac execution if true (defaults to false)
debug	No	Wait for debugger if true (defaults to false)

Performance Diagnostic Tool

This chapter describes the RPASCE Performance Diagnostic Tool. It contains the following sections:

- [Overview](#)
- [Collecting and Managing Performance Metrics](#)
- [Analyzing Workbook Performance](#)

Overview

The Performance Diagnostic Tool is a set of administrative reports that an application administrator or system integrator can use to monitor, identify, and review any RPASCE performance issues. In this way, the system administrator or system integrator has access to the information necessary to take action. The Performance Diagnostic Tool Template is accessed in the System Administration Tasks tab and is available to administration users. It provides details about potential performance trouble areas, focusing on common workbook and batch operations, including workbook open, commit, and calculations. The data can be viewed at aggregate levels or down at the user level, if an administrator must work with a specific end user who has expressed concerns regarding RPASCE system performance. Based on the information provided in the Performance Diagnostic Tool, the administration user has a clearer understanding of where the issue is, which can help the user address the issue.

Collecting and Managing Performance Metrics

The Performance Diagnostic Tool monitors and analyzes operational performance data.

Operational performance data includes elapsed time for various workbook operations. Workbook operations include Workbook Build, Open, Refresh, Commit, Custom Menu, and Calc. For Workbook Build, Refresh, Commit, and Custom Menu, elapsed time is also collected for each expression.

RPASCE collects operational performance data in real time with minimal impact. The collection of operational performance data is built into the RPASCE core and does not need to be turned on or off. Data collection is available.

Since these performance files are text files without outside dependency, to preserve disk space, it is recommended that batch jobs be set up on the server to remove files older than a pre-defined number of days, such as 15 days. The system only retains the performance data for the last 15 days to preserve disk space. However, if any performance issues are observed for a particular period of time, it is recommended that the relevant performance data be preserved for analysis.

Analyzing Workbook Performance

The Performance Diagnostic Tool is available to administration users as a workbook template, located in the template group System Administration, available from the task flow

menu under Administration. To access the template, the user must log in as an administration user, go to the System Administration Task Flow, and select the Performance Diagnostic Tool, shown in [Figure 15-1](#).

Figure 15-1 Select Performance Diagnostic Tool

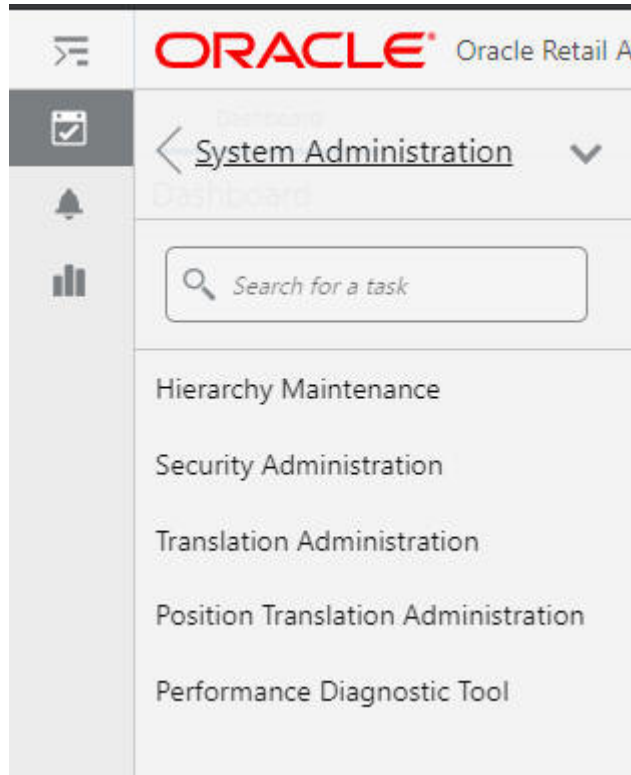

The Segment dialog box, which shows all previously defined segments, is displayed, as shown in [Figure 15-2](#). This is used to select a predefined segment in order to modify it or copy it.

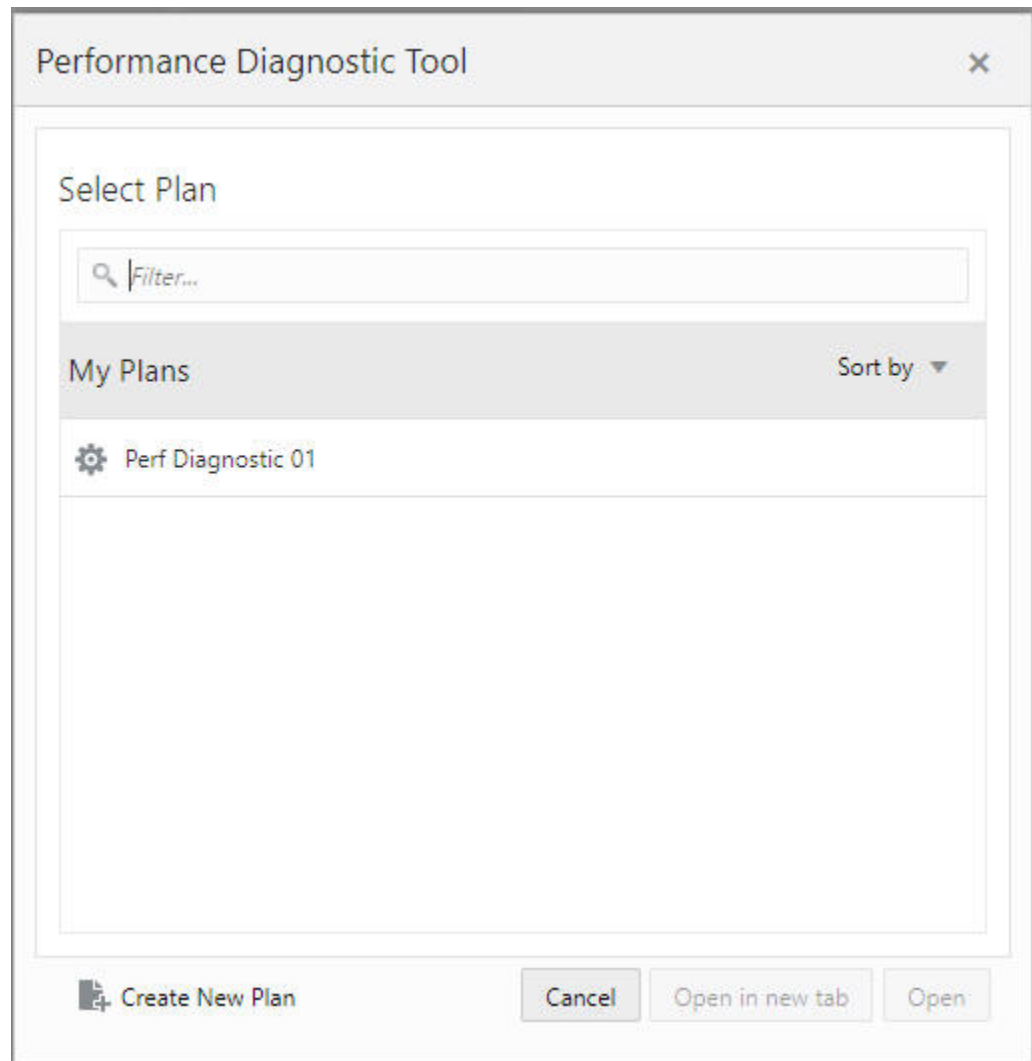
Figure 15-2 Segment Dialog Box

To define a new segment, select **Create New Plan**. The Enter Plan Label dialog box is displayed. Enter a label and click **OK**.

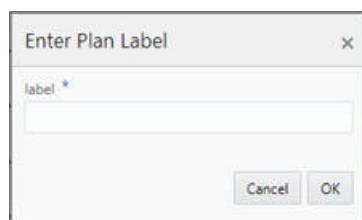
Figure 15-3 Enter Plan Label

Then, select users from the list of users in the Levels and Positions tab shown in [Figure 15-4](#). The contents of this list depend on whether or not performance data exists for this user. The administration user must pick at least one user to examine the performance data.

Figure 15-4 Levels and Positions

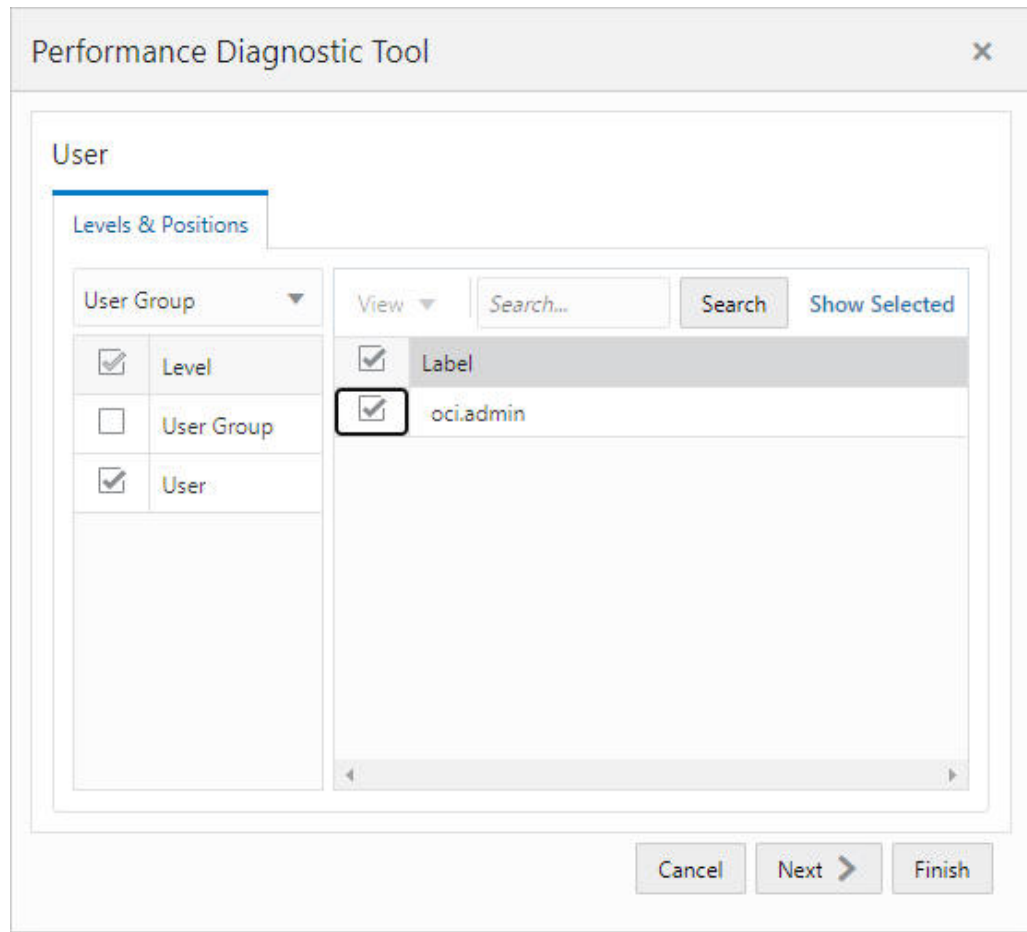

Select the calendar range, as shown in [Figure 15-5](#). The calendar range is defined at the lowest calendar level in the PDS, usually the day level. The days are arranged by the availability of performance data for the previously selected user.

Figure 15-5 Calendar Range

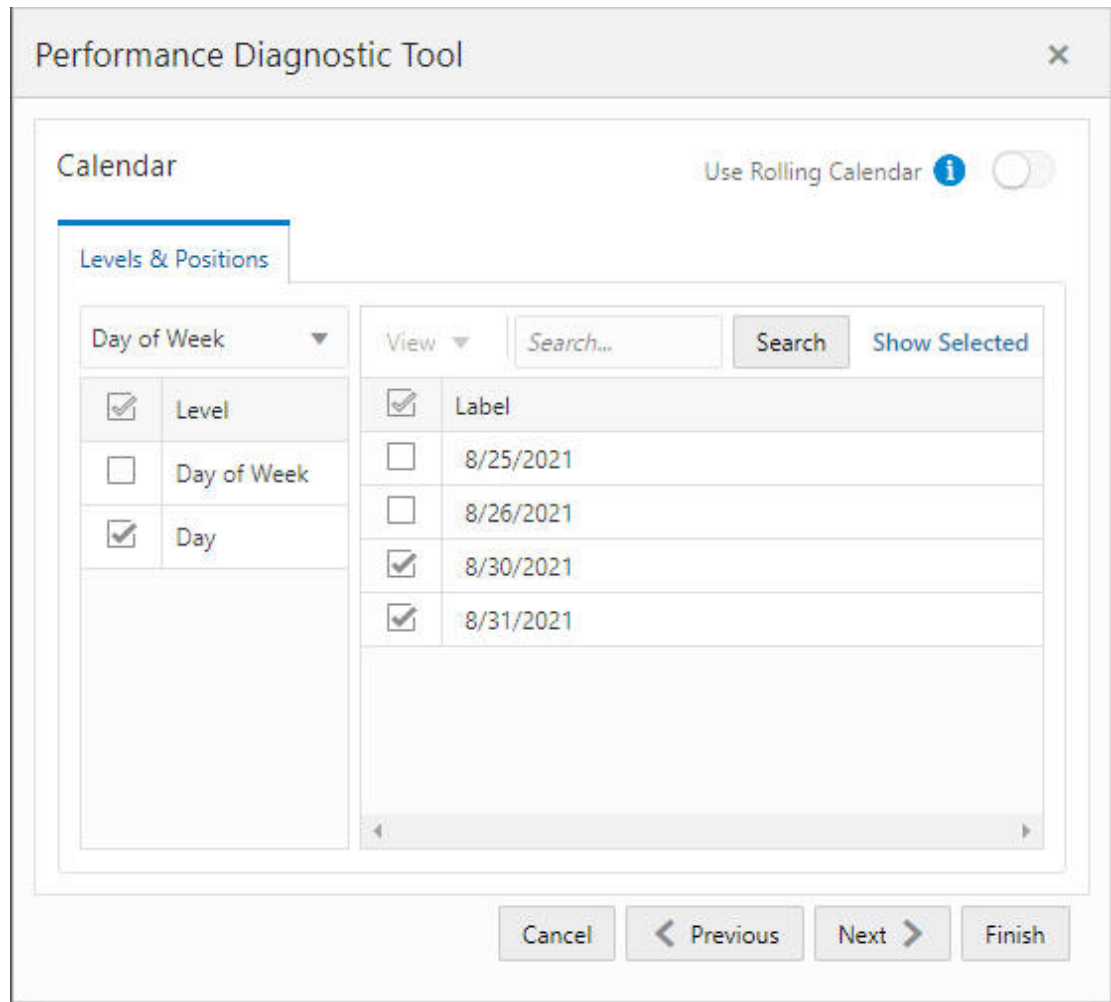

Select either Workbook or Batch, as shown in [Figure 15-6](#).

Figure 15-6 Select Workbook or Batch

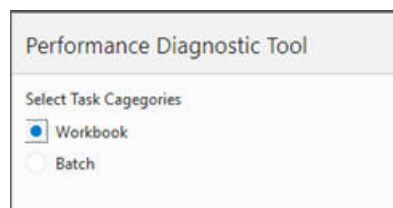

The segment, once fully specified, is submitted to the RPASCE Task Daemon to build the workbook. The status of the workbook build can be tracked using the Task Status Dashboard or the Notification tab. When the workbook is being built, the performance data is loaded using a set of RPASCE rules that create the customized hierarchies for examining the performance data and the actual performance measure that holds the performance data. Once the workbook is successfully built, it can be opened via the Notification tab or from the

segment window. Once the workbook is open, the user can see All Operations, as shown in [Figure 15-7](#).

Figure 15-7 All Operations High Level View

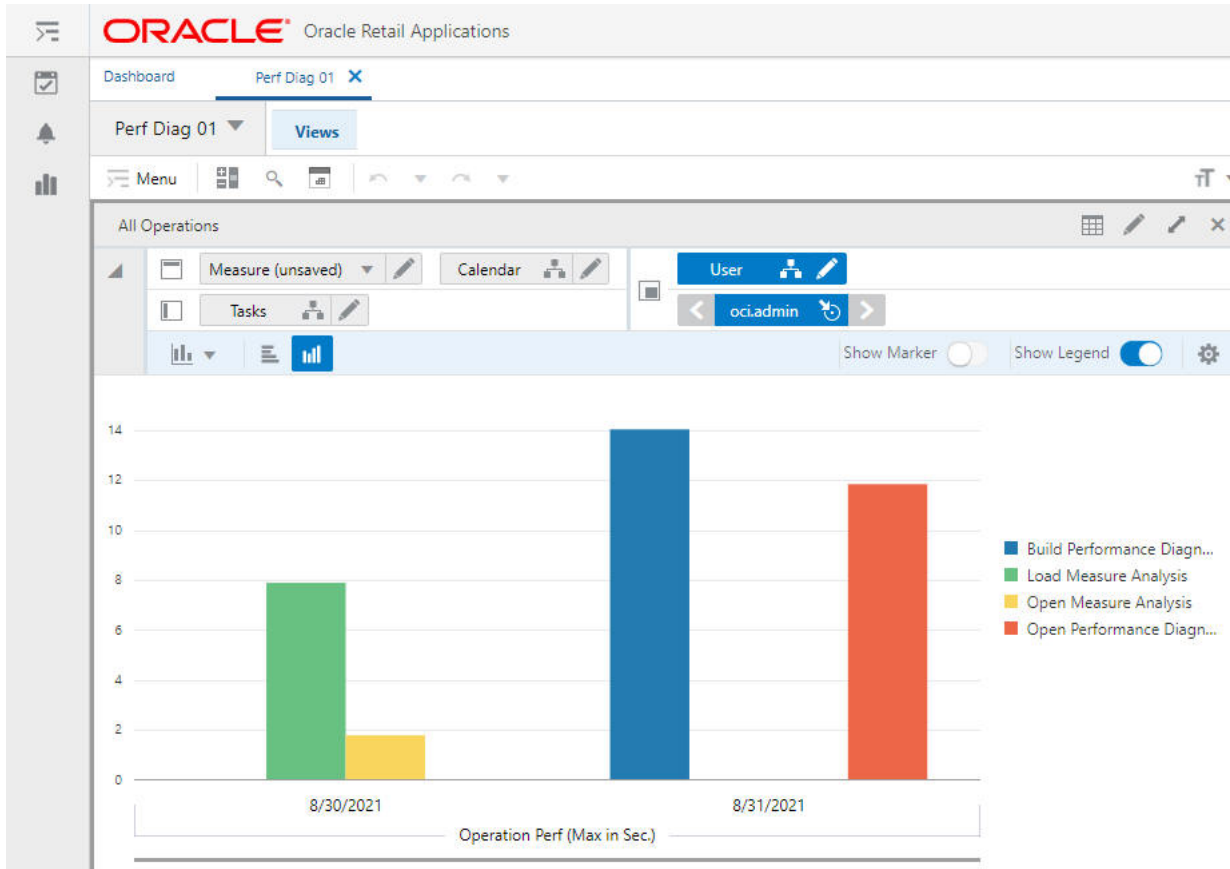

This view displays the Maximum Running Time, in seconds, for different types of Workspace operations such as Build, Open, Refresh, and Commit, along with the calendar dimension. This window is best presented if viewed in a bar chart. The maximum running time is shown at the aggregated level. For example, the maximum build time for a particular day is the maximum build time for all the workbooks that the specific user built on that day. Using this view, administration users can identify the type of workbook operations that require the longest time and how that time changes from day to day.

Since the data is presented at a high level in this view, the administration user can use this as a starting point for an investigation to identify which workbook build is actually taking the most time. For more detailed information, the administration user can drill down to a specific day/user combination, as shown in [Figure 15-8](#).

Figure 15-8 All Operations View

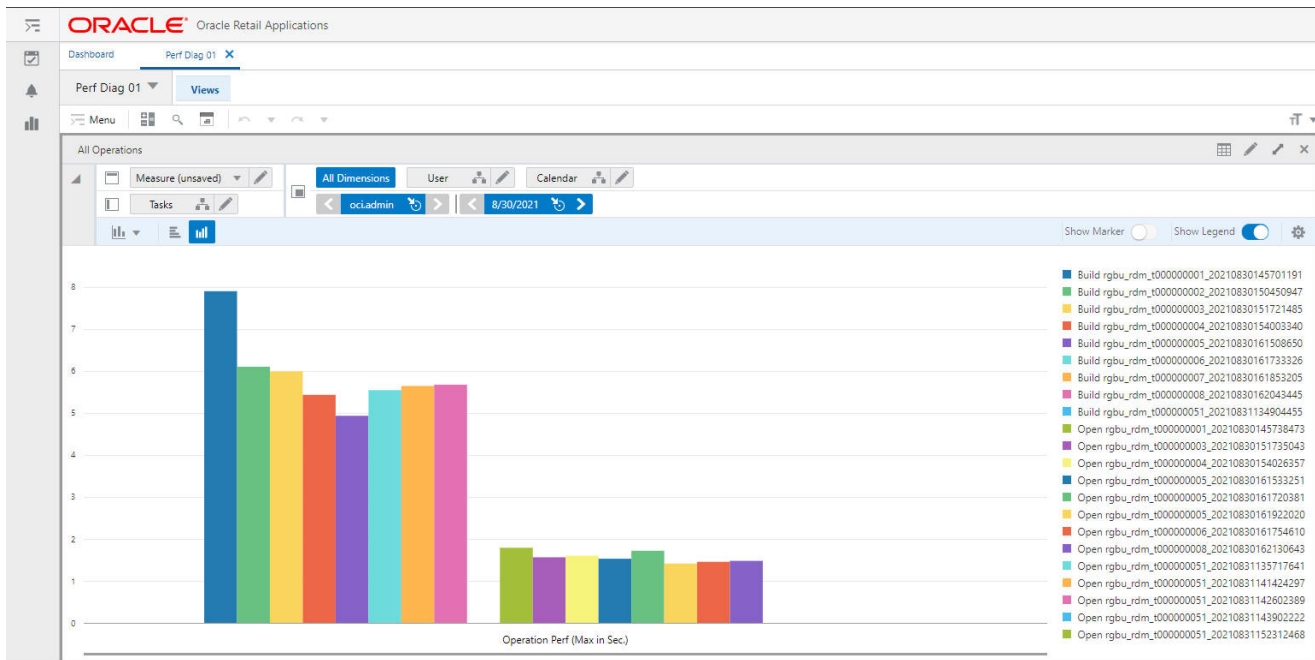

The Tasks hierarchy is built on demand when the workbook is created, using the data in the performance log files. The user can arrange the Tasks hierarchy to drill down to operations belonging to a specific workbook template or to a specific workbook. The user can arrange and manipulate the Tasks hierarchy using the Tasks tab, via the Tasks Hierarchy dialog box shown in [Figure 15-9](#).

Figure 15-9 Task Hierarchy

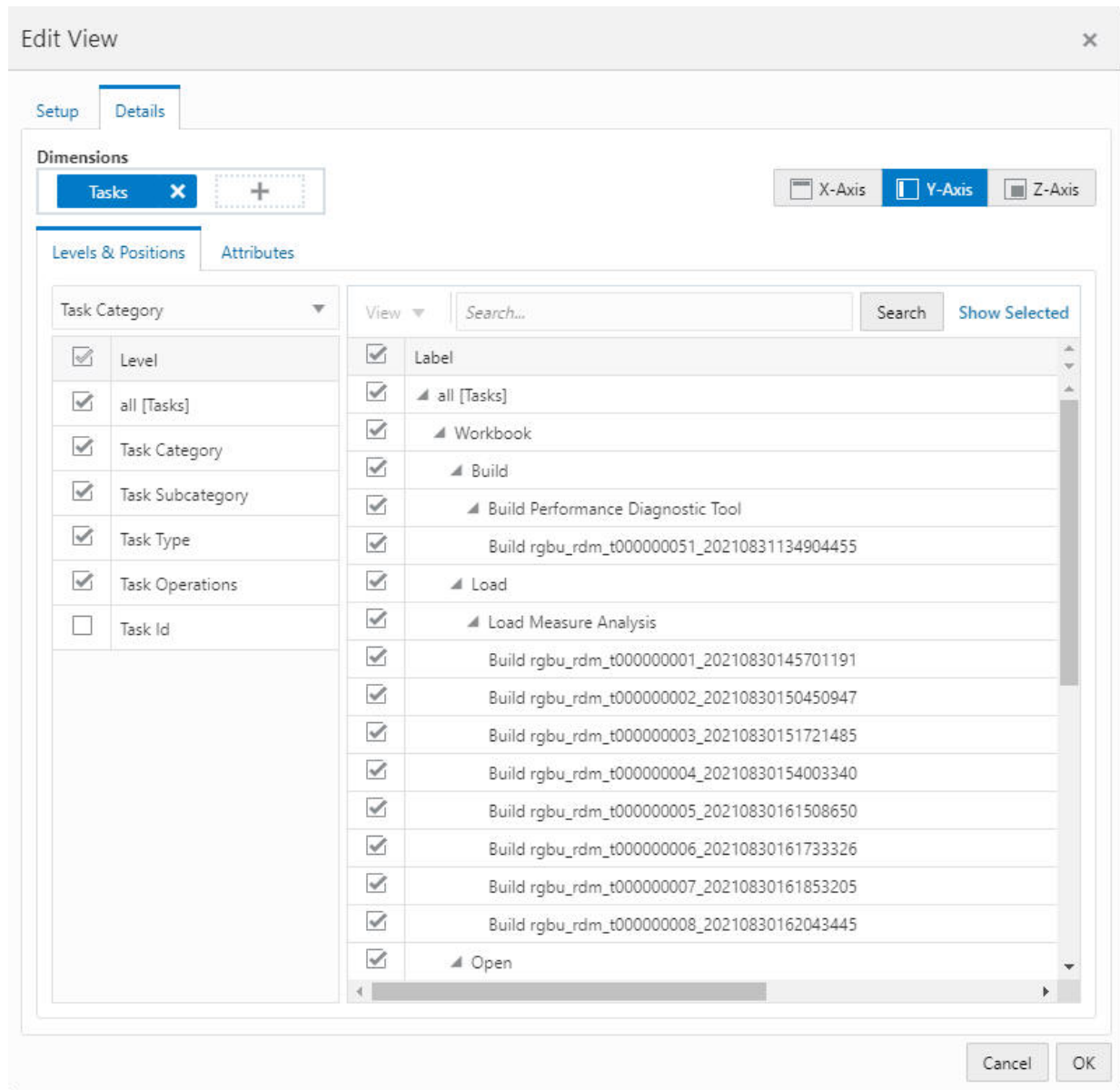

The Task hierarchy is made up of five levels.

- The lowest level is Task ID, which is used by the Expression level view. Each Task ID represents an individual expression evaluation. Currently, expression runs in PDS are not logged. Task ID aggregates to the Task Operation level, which maps to each specific workbook operation, such as Build Operation for workbook pcgd_t00003.
- The Task Operations level is the level shown in the All Operations view. Task Operations aggregates to the Task Type level, which maps to a specific workbook operation type/template name combination (for example, Build Operation for Measure Analysis template).

- The Task Type level aggregates to the Task Subcategory level, which is the level shown in the All Operations - High Level view.
- The Task subcategory maps to each of the workbook operations, such as Build, Calc, Custom Menu, Commit, and Refresh.
- The top level of the Task Hierarchy is the Task Category, which has only two positions: Workbook and Batch. Currently, only Workbook can be used for the Performance Diagnostic workbook. The level names in the Task Hierarchy are generic, such as Categories, IDs, or Types, because the hierarchy definition is shared between the Workbook and Batch operations.

16

Service Administration

This chapter provides details about service administration for RPASCE.

System Configuration

System Configuration provides administrators with the capability to update client-side system properties from the application. The administrator can now update various properties relating to administration status tasks, alert, chart, dashboard, export, image, logging, and separators, and format properties from the application. This feature lets you manage and support your team's operational needs.

The administration user can access the self-service feature from the Settings icon available at the bottom of the left sidebar menu.

Figure 16-1 Self-Service Feature

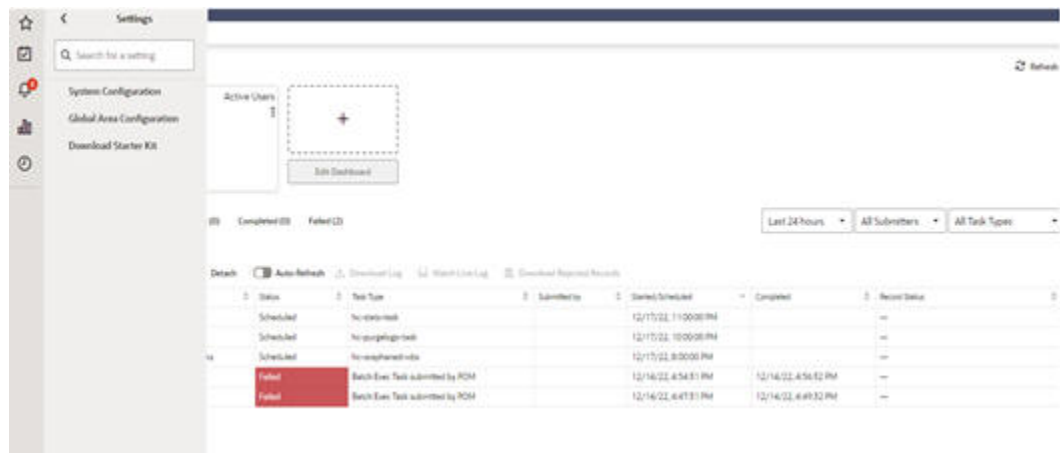

You can use the system configuration to manage the following:

Config Properties

Use this tab, shown in [Figure 16-2](#), to manage the system parameters saved in the config.properties file for various functions such as administration status tasks, alert, chart, dashboard, export, image, logging, and separators. A form-based interface is displayed for updating the properties. Indicators for certain properties give a brief description of property.

All the numeric value property field indicate the allowed range of values for each property. The tab name appears in italics to show where the changes have been made.

Figure 16-2 Config Properties Tab

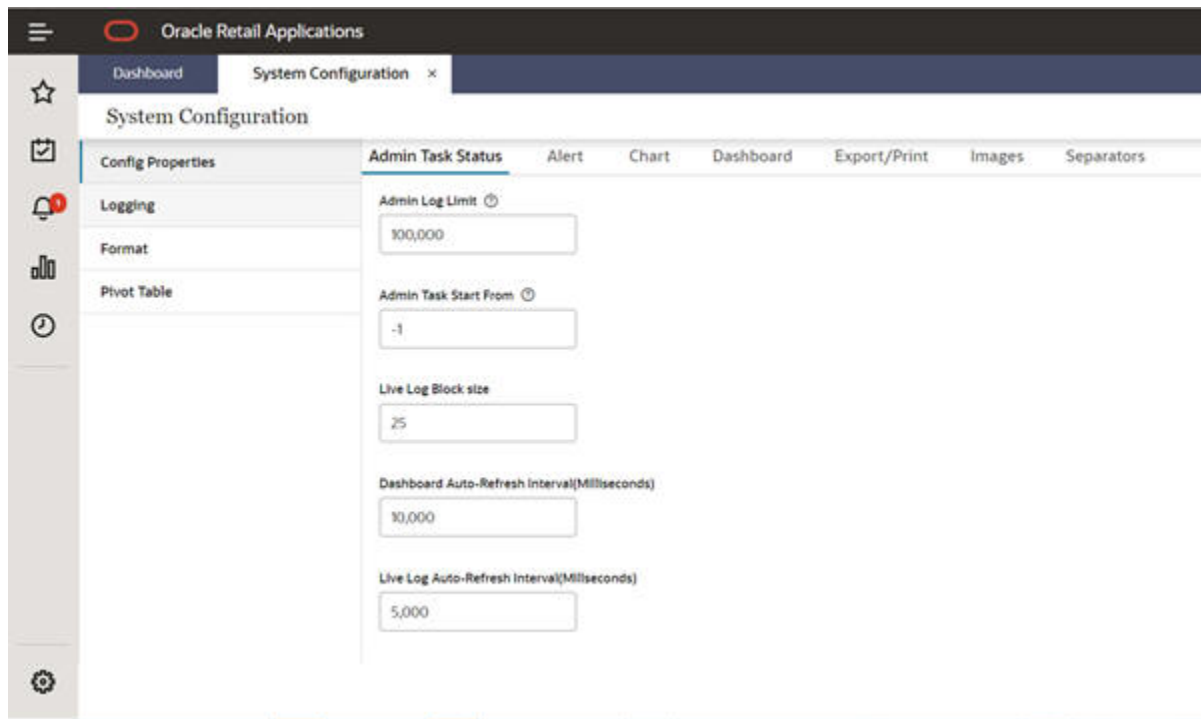

Admin Task Status

Use this tab, shown in [Figure 16-3](#), to update the properties related to administration task status. The following properties can be updated:

- Admin log Limit - Specify the number of lines in the administration logs. The range of permitted values is between 5,000 and 200,000.
- Admin Task start from - Define the logging start from start (0) or end (-1) of the file.
- Live Log Block Size - Enter the block size of the live log. The range of permitted values is between 20 and 30.
- Use short name for entities - Toggle button to indicate whether you require short names for the entities in the status.
- Dashboard Auto-Refresh interval - Update the auto-refresh interval time for the administration dashboard in milliseconds. The range of permitted values is between 1,000 and 86,400,000.
- Live Log Auto-Refresh interval - Update the auto-refresh interval time for the live log. This is in milliseconds. The range of permitted values is between 1,000 and 86,400,000.

Figure 16-3 Admin Task Status

The screenshot shows the 'System Configuration' window with the 'Admin Task Status' tab selected. The left sidebar contains 'Config Properties', 'Logging', 'Format', and 'Pivot Table'. The main area contains the following configuration items:

Property	Value
Admin Log Limit	100,000
Admin Task Start From	-1
Live Log Block size	25
Dashboard Auto-Refresh Interval(Milliseconds)	10,000
Live Log Auto-Refresh Interval(Milliseconds)	5,000

Buttons at the bottom right: Cancel, Save and Close, Save.

Alert

Use this tab, shown in [Figure 16-4](#), to update the alert properties. You can update the maximum number of alerts allowed. The range of permitted values is between 1,000 and 10,000 alerts.

Figure 16-4 Alert Tab

The screenshot shows the 'System Configuration' window with the 'Alert' tab selected. The left sidebar contains 'Config Properties', 'Logging', 'Format', and 'Pivot Table'. The main area contains the following configuration item:

Property	Value
Maximum Number of Alerts Allowed	5,001

By default, the alerts displayed in the Select drop-down list are sorted by the ascending order of priority assigned to each alert during alert configuration. To change the default behavior,

enable the Disable Priority Sorting on the Alerts property in Systems Configuration. You access this property in the Additional Setting Tab under Oracle Support Administration. The default setting for Disable Priority Sorting on Alerts is false. When default sorting is disabled, the alerts will be sorted as defined in the setting value of Disable Default Sorting.

Figure 16-5 Disable Priority Sorting

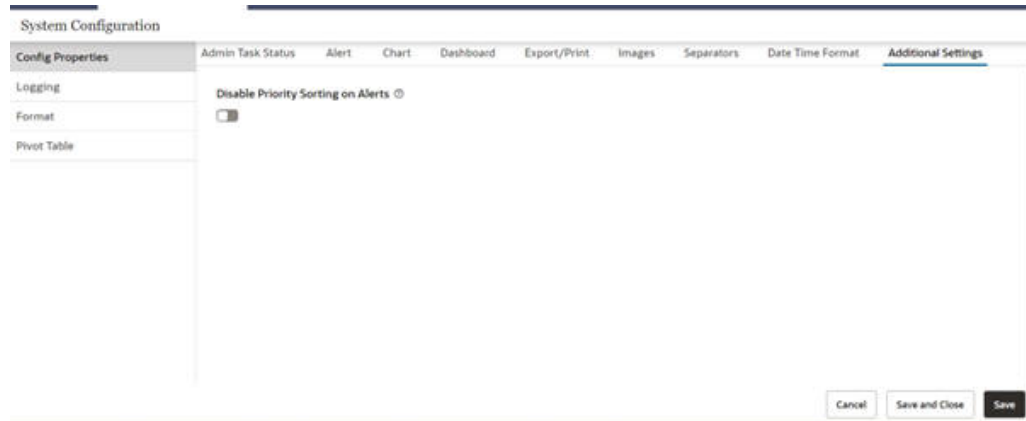

Chart

Use this tab, shown in [Figure 16-6](#), to update the chart properties. The following properties can be updated:

- Maximum chart series - The maximum number of series allowed in charts. The range of permitted values is between 100 and 200.
- Maximum chart group - The maximum number of groups allowed to plot in charts. The range of permitted values is between 100 and 200.
- X-axis Label Orientation - Select x-axis label orientation. The auto-rotate option is used to select the orientation of the x-axis labels, depending on the number of items in charts. The horizontal orientation option is used to display the x-axis label horizontally.

Figure 16-6 Chart Tab

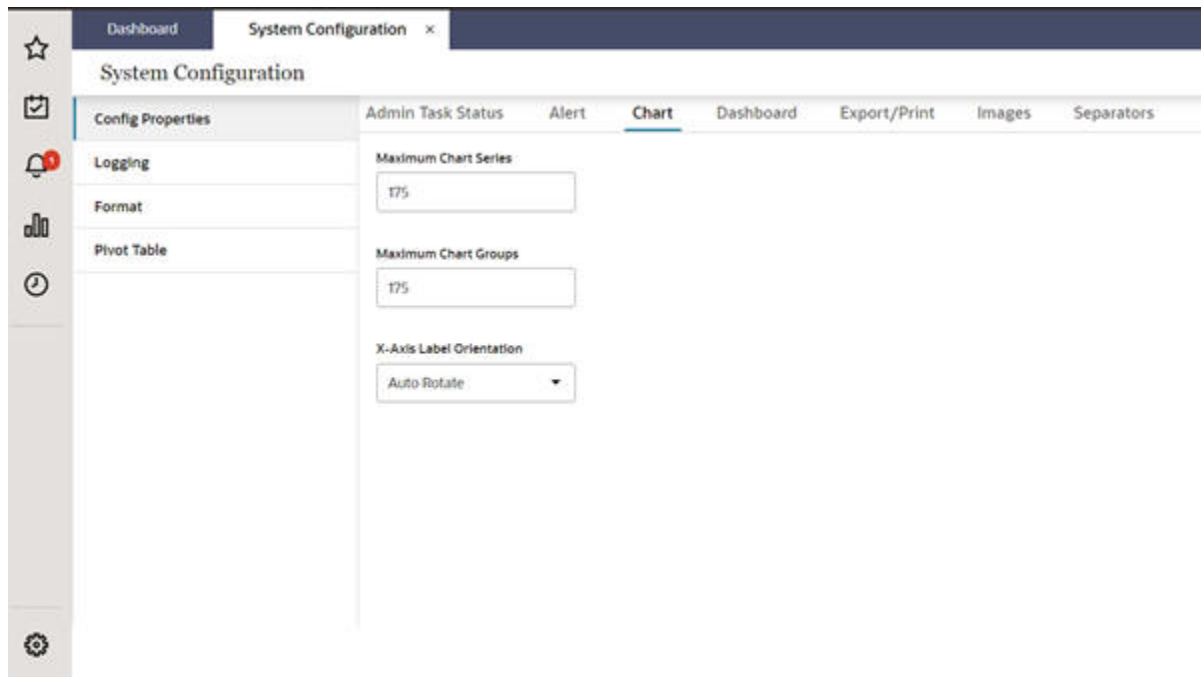

Dashboard

Use this tab, shown in [Figure 16-7](#), to update the properties related to dashboards.

- Maximum Dashboard Plans - The maximum number of plans for a dashboard. The range of permitted values is between 0 and 50.
- Maximum Dashboard Filter - The maximum number of filters permitted in a dashboard. The range of permitted values is between 0 and 100,000.
- Dashboard Filter Cap - The filter cap for a dashboard. The range of permitted values is between 0 and 1,000.
- Show Retail Home Tasks - Toggle button used to show/hide retail home tasks.

Figure 16-7 Dashboard Tab

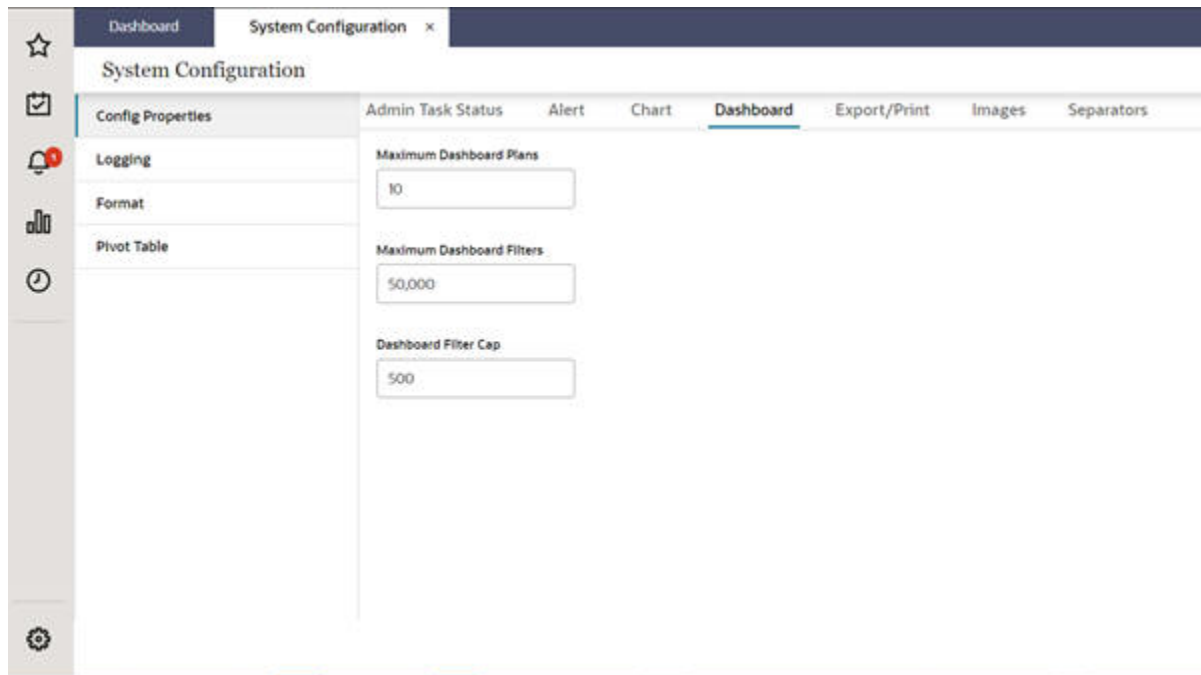

Export/Print

Use this tab, shown in [Figure 16-8](#), to update the properties related to export and print functionality. The following properties can be updated:

- Maximum print/Export cells - The number of cells that can be exported from the system. The range of permitted values is between 0 and 5,000,000.

Note that this limit applies to both Excel and txt export of the current slice. This limit does not apply to the txt export of all slices.

Note that in the Export/Print tab, you can set the property for the maximum print/export cells. If this property is set to 0, all the cells are exported. However, an out-of-memory error may occur on the server, depending on the size of the data being exported. Use this setting with caution. Users can use the export All slice feature for exporting a large amount of data.

Even if the property is set to 0 to export all the cells, the export will comply with the Excel limit. Excel supports only 1,048,576 rows and 16,384 columns. If the data you are exporting exceeds this limit, you will see one of the following failure messages:

- There are too many rows in the view. The file cannot be exported with more than 1,048,576 rows and 16,384 columns. Please reduce the amount of rows and try again.
 - There are too many columns in the view. The file cannot be exported with more than 1,048,576 rows and 16,384 columns. Please reduce the amount of columns and try again.
- Cell Image height and width - Use this to provide the cell image height and width allowed during export. The range of permitted values is between 50 and 200.

- Large Image height and width - Use this to provide the large image height and width allowed during export. The range of permitted values is between 100 and 500.
- Image Type - Specify the type of image to be exported in the output file.

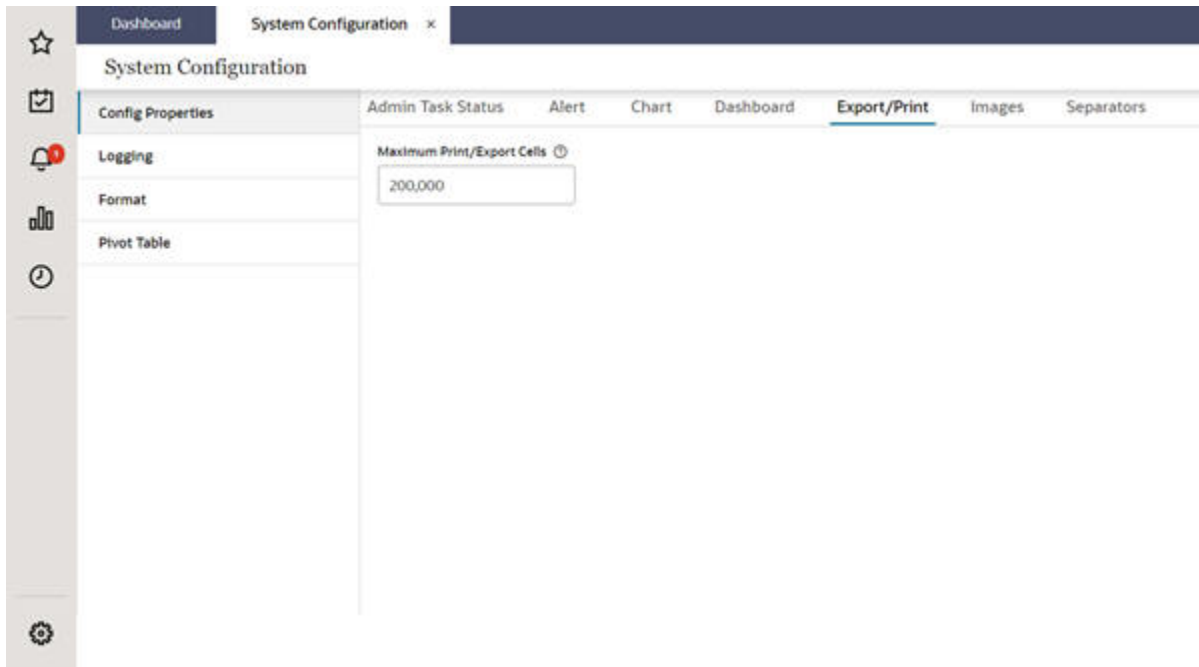
Figure 16-8 Export/Print Tab

Images

Use this tab, shown in [Figure 16-9](#), to update the following image-related properties.

Figure 16-9 Images Tab

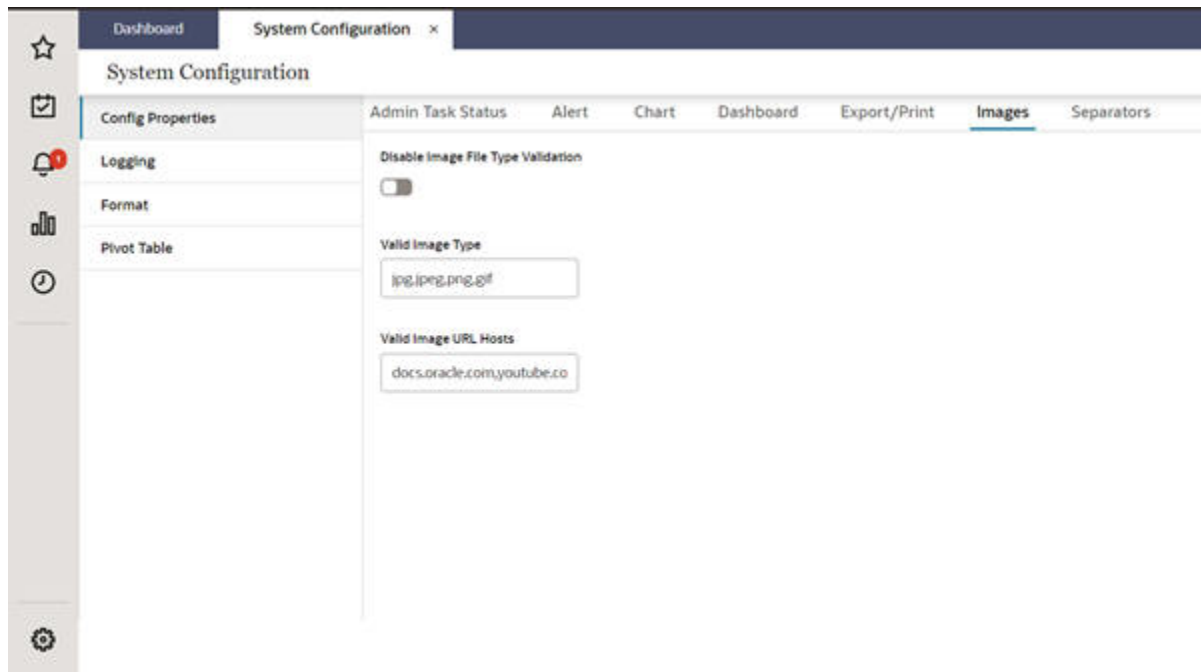

- Disable Image file type Validation - Toggle button to indicate whether or not you require file type validation for the images in your system.
- Valid image type - The image file types that are valid for your application.
- Valid Image URL hosts - The valid URL hosts for your application.

Logging Properties

Use this tab, shown in [Figure 16-10](#), to specify the logging properties. You can update the following:

- Server log levels - Update the log levels as per the requirement (that is, info, debug, error).
- Enable Latency logging - Toggle button to enable or disable latency logging.
- Latency Logging interval - Set the latency logging interval between the server and browser. The range of permitted values is between 15 and 900 milliseconds.
- Enable latency measurement - Toggle button to enable or disable the latency measurement.
- Latency Measurement Threshold - Set the value for the maximum tolerable latency in milliseconds. The range of permitted values is between 50 and 400.
- Enable transaction logging - Toggle button to enable or disable transaction logging.
- Maximum selection size for cut, copy, paste - Set the maximum selection size for cut, copy, paste, fill, or clear operations. The range of permitted values is between 5,000 and 15,000.
- Enable Performance Measurement - Toggle button to enable or disable the performance measurement.

Figure 16-10 Logging

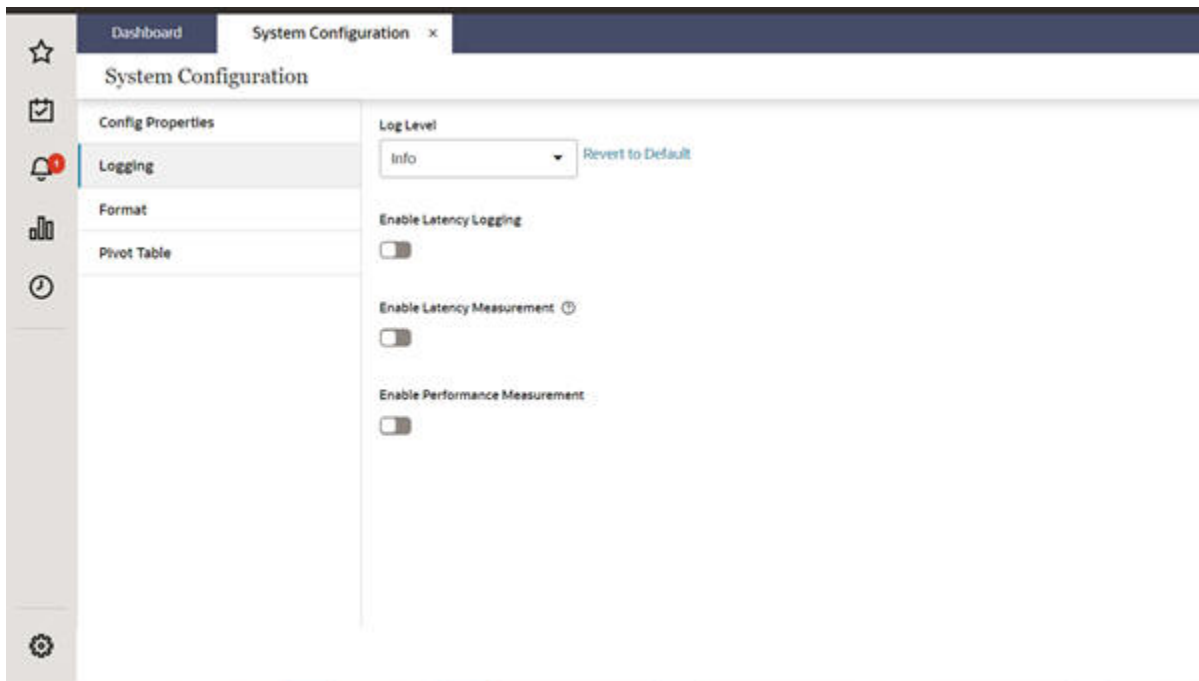

Separators

Use this tab, shown in [Figure 16-11](#), to set the separators.

- Decimal separator override
- Decimal group separator override

Note the following:

- Either both or neither of the separators must be defined.
- The value of both the separators must be unique.
- If a decimal group separator override must be a space, then you must enter the word "space" instead of the character space.

Figure 16-11 Separator Tab

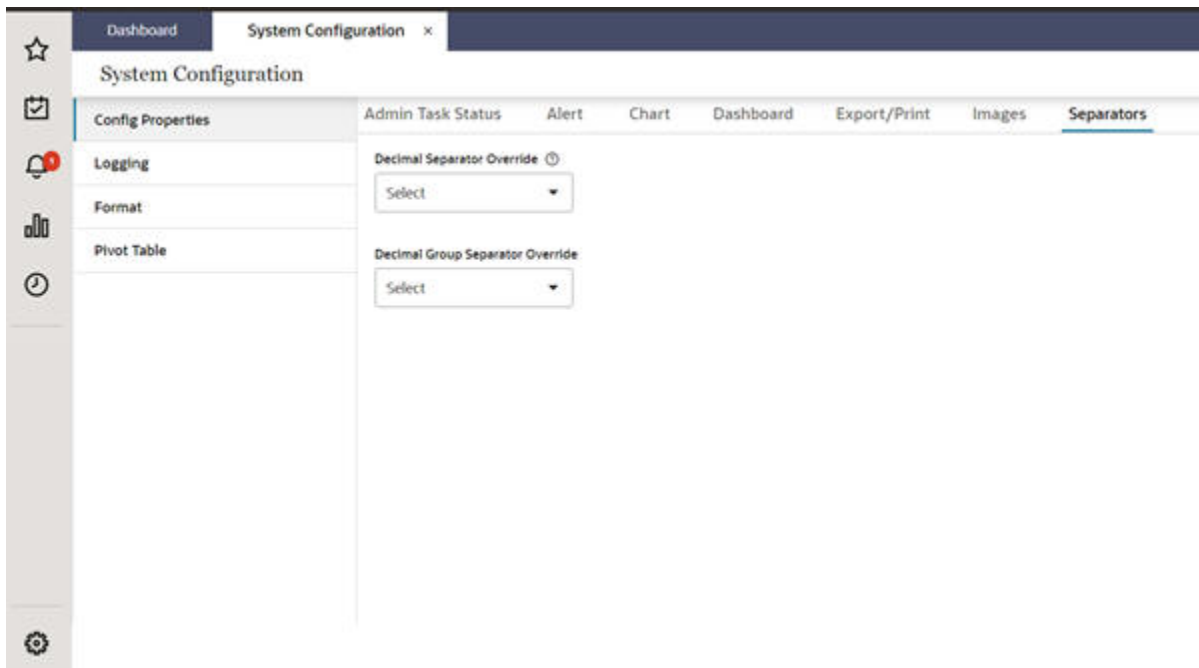

Date Time Format

This tab provides a Date Format option and a Time Format option.

Use the Date Format option to specify a global date format that overrides the format specified in the application. The format selected is applied to the application for all users. Three formats are available:

- DD/MM/YYYY
- MM/DD/YYYY
- YYYY/MM/DD

Figure 16-12 Date Format Option

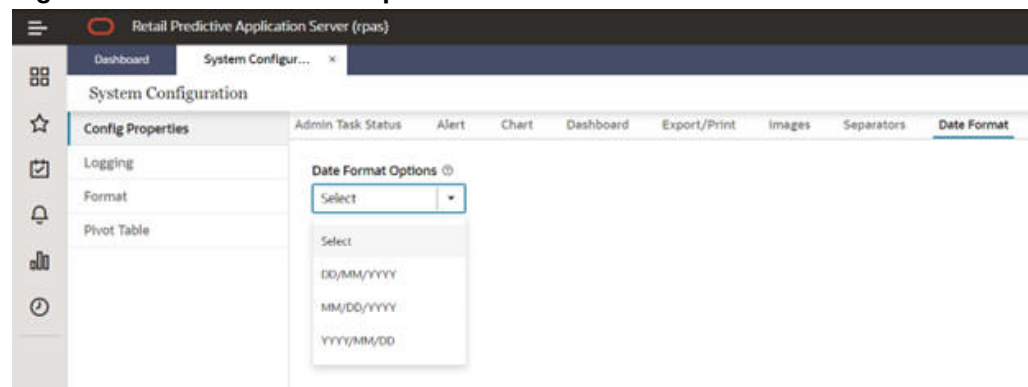

When the user applies the date format, the change is applied to the Pivot Table, the Recent Plan, the Last Commit (bottom bar), and the Admin Dashboard.

When you select an option, the sample date format to be applied is displayed.

Figure 16-13 Sample Date Option

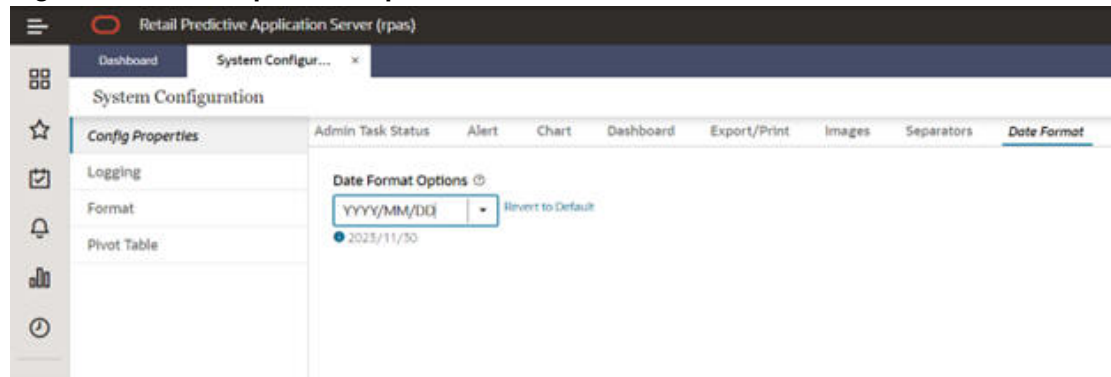

The Time Format option provides a global format settings for time that is independent of language of application. The user can change the time format as required and the selected format will be applied to the application for all users.

A user can select one of the four time formats from the drop-down list to override the time format in the application:

- hh:mm:ss
- hh:mm
- hh:mm:ss a
- hh:mm a

Figure 16-14 Time Format Option

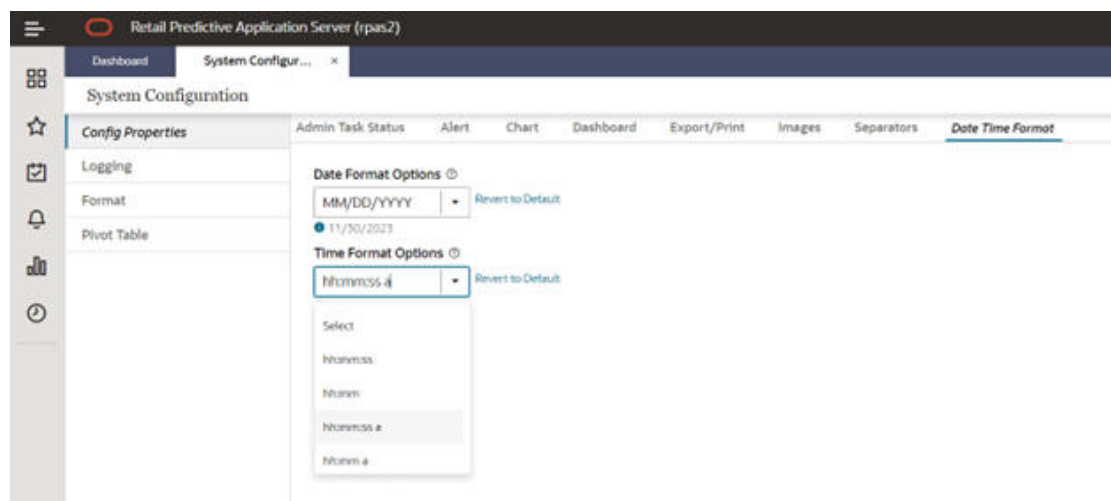

The format the user selects are applied to:

- Pivot Table
- Last Commit (bottom bar)
- Admin Dashboard

Selecting an option also displays the sample time format that will be applied.

Figure 16-15 Sample Time Format

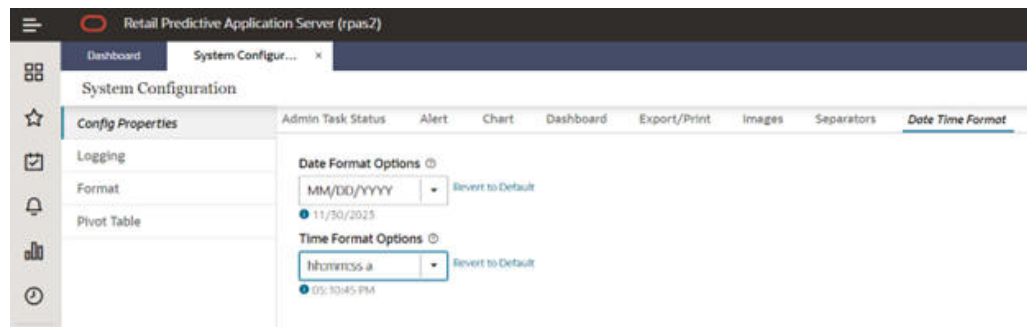

Additional Settings

This tab, shown in [Figure 16-18](#), is hidden by default and can be accessed via Online Admin Tools.

1. Launch Online Admin Tools and select the System Admin Tasks. Click **Next**.
2. Select Oracle Support Administration, as shown in [Figure 16-16](#).

Figure 16-16 Oracle Support Administration

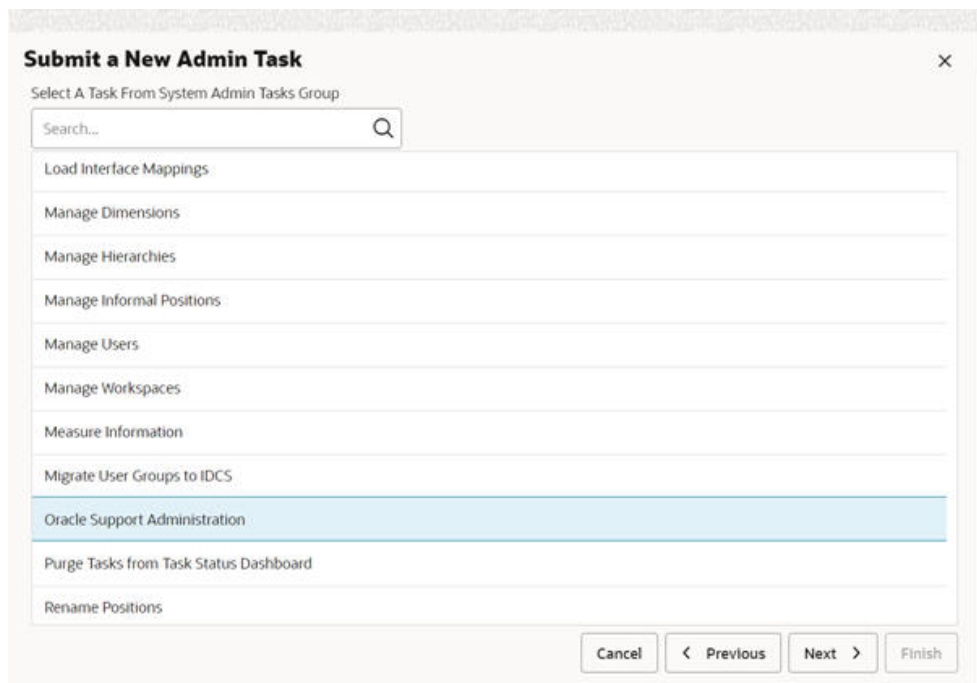

3. Select the appropriate settings, as shown in [Figure 16-17](#), and submit the task.

Figure 16-17 Oracle Support Administration Settings

4. Once the task is complete, the Additional Settings tab, shown in [Figure 16-18](#), becomes visible and the settings/configuration properties selected in the task are available.

Figure 16-18 Additional Settings Tab

Oracle Guided Learning

Customers can realize their cloud application's value more quickly with Oracle's Digital Adoption Platform, Oracle Guided Learning (OGL). OGL accelerates user adoption with guided and contextual learning and also helps to manage continuous business change. In an OGL-enabled environment, users will see guided content from Oracle.

Customers can further customize the content as per their business need. There are two new properties under Additional Settings to configure for OGL, shown in [Figure 16-17](#):

- Oracle Guided Learning App ID- the unique identifier for your OGL account
- Oracle Guided Learning Source URL - source from which to pull the guides and content

Logging

Use this tab, shown in [Figure 16-19](#), to set the log level and enable/disable latency-logging, latency-measurements, and performance-measurements. You must save and log in again in order for the changes to take effect.

Figure 16-19 Logging Tab

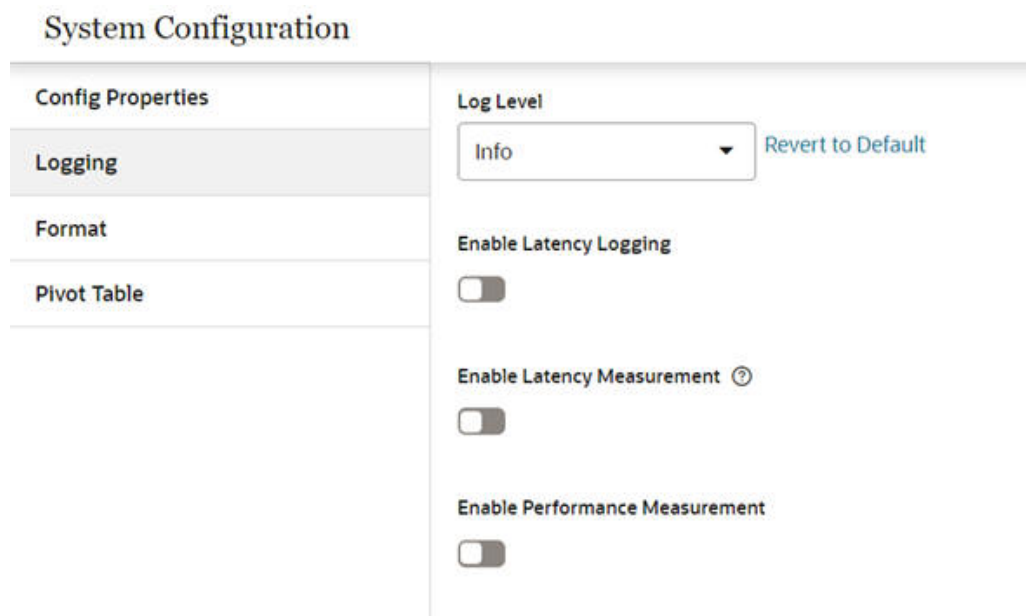

The screenshot shows the 'System Configuration' interface with the 'Logging' tab selected. The left sidebar contains a menu with 'Config Properties', 'Logging', 'Format', and 'Pivot Table'. The main content area is titled 'Log Level' and features a dropdown menu set to 'Info' with a 'Revert to Default' link. Below this are three toggle switches: 'Enable Latency Logging' (disabled), 'Enable Latency Measurement' (disabled, with a help icon), and 'Enable Performance Measurement' (disabled).

Log Level

Use the log level drop-down list to select appropriate log levels. The RPASCE Client application supports the following log levels.

Table 16-1 Log Levels

Log Level Name	Log Level Definition
Off	Used to turn off all logs.
Fatal	Used to log severe errors that require immediate attention. These situations either impact the normal operation of the entire application or a component within the application.
Error	Used to log errors. Critical errors and information are logged at this level.
Warn	Used to log messages regarding potentially harmful situations. These situations do not affect the running of the RPASCE Client application, but may not give the desired result. For this reason, it is preferable to warn the user about such situations.
Audit	Used to log messages that indicate a change, including workbook builds, save, commit, and so on. Most of these may already be reflected in the UI or are available on Admin Task Status.
Info	Used to log general information about user actions and main events (for example, if the login was successful or not). This is the default log level.
Profile	Used to log performance characteristics of user actions.
Debug	Used for debug logging. At this level, more logging occurs than at the other levels. Debug information that can help in application debugging is provided at this level. This must only be used for debugging purposes, as the number of logs generated may cause performance issues. When a customer wishes to report a defect, customer support can advise the customer to turn on logging at this level, run the problem scenario, capture the logs, and attach them to the trouble report.
Verbose	Used for very detailed logging. At this level, more logging occurs than at the debug level. Fine-grained information that can help in application debugging is provided at this level. This must be used only for debugging purposes, as the number of logs generated may cause performance issues. When a customer wishes to report a defect, customer support can advise the customer to turn on logging at this level, run the problem scenario, capture the logs, and attach them to the trouble report.
All	Used to turn on all the logging.

Enable Latency Logging

Use the toggle button to enable or disable latency logging. Once enabled, the network latency from the user browser to the application is measured and logged at defined intervals. This can help the customer administrator to work with Oracle support on any network latency-related performance issues.

Enable Latency Measurement

Use the toggle button to enable or disable latency measurement. Latency measurements depends on Latency Logging and so that must also be enabled, along with latency measurements.

Once this is enabled, users will see the following warning when their network latency exceeds certain thresholds.

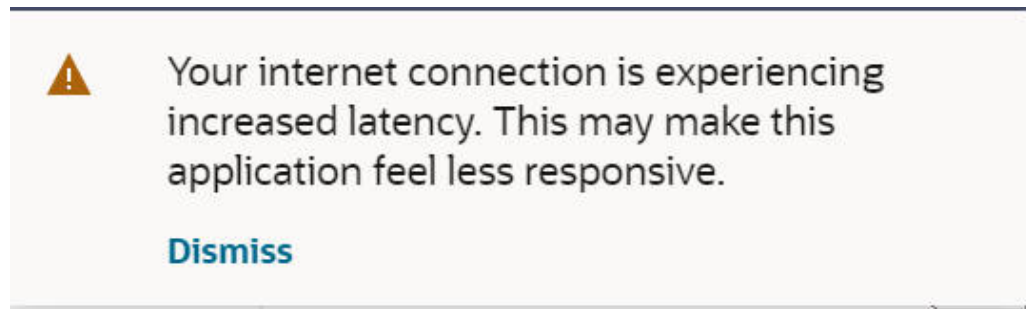
Figure 16-20 Network Latency Warning

They will see the following information once their network latency returns to normal.

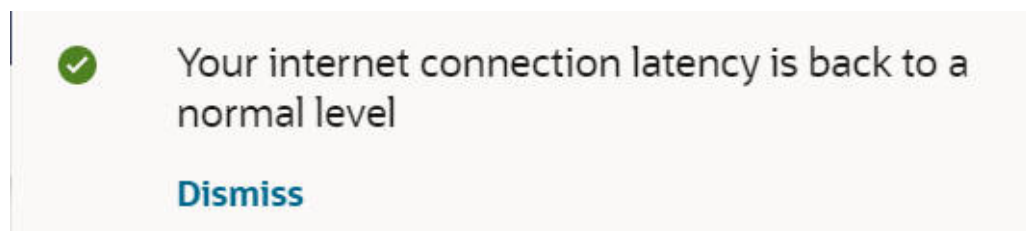
Figure 16-21 Normal Network Latency

Enable Performance Measurement

Use the toggle button to enable or disable performance measurement. Once this is enabled, the performance timing icon appears on the left task menu (after the user logs in again). The performance values for the current user can be exported or displayed using appropriate sub-menu links.

Logging Level

You can edit the `log4jconfig.xml` file. This file is mainly used to change the logging level of the application as needed.



Note:

It is advised to only change the logging level attributes in the `loggers` tag and not change any other parameters.

You can update the following:

Format

Use this tab, shown in [Figure 16-22](#), to change the `FormatConfig.xml` file, which controls the formatting properties for the application (that is, currency, percentage, and millions separator).

To save your changes, click **Save** or **Save & Close**.

**Note:**

To apply the saved changes, you must re-log into the application.

Figure 16-22 File Contents of FormatConfig.xml

```

<?xml version="1.0" encoding="UTF-8" ?>
<formatGlobal>
  <quickFormat name="currency">
    <label>format.popup.numb.apply.quickFormat.currency</label>
    <prefix>$</prefix>
    <suffix></suffix>
    <scale>1</scale>
    <showSeparator=true</showSeparator>
    <precision>2</precision>
  </quickFormat>
  <quickFormat name="percentage">
    <label>format.popup.numb.apply.quickFormat.percentage</label>
    <prefix></prefix>
    <suffix>%</suffix>
    <scale>0.01</scale>
    <showSeparator=false</showSeparator>
    <precision>0</precision>
  </quickFormat>
  <quickFormat name="thousands">
    <label>format.popup.numb.apply.quickFormat.thousands</label>
    <prefix></prefix>
    <suffix>k</suffix>
    <scale>1000</scale>
    <showSeparator=true</showSeparator>
    <precision>0</precision>
  </quickFormat>

```

Pivot Table

Use this tab, shown in [Figure 16-23](#), to change the format style of edited uncalculated cells. You can update the color of the edited cell background, edited cell text color, and style.

Figure 16-23 Pivot Table

Edited Cell Style

Edited Text Style

Read Only Style

Note the following:

- The system configuration can be edited only by one administration user at a time. If a second administration user tries to edit the configuration, the following message is displayed: "Configuration is currently being edited by <username>".
- You cannot navigate to another tab if an error occurs on the current tab.
- You cannot submit the page if errors occur until those errors are resolved.
- The property not exposed through the Self-Service system will go through the regular service request process.
- For more details about property files, refer to the sections of this chapter.

Global Area Configuration

The Global Area Configuration page allows an administration user to configure certain components of the branding area, including the application name and the logo.

Note:

The PLATFORM_SERVICES_ADMINISTRATOR_ABSTRACT group must be assigned to the user in IDCS or OCI IAM or the user will experience a 403 forbidden error after attempting to save.

Figure 16-24 Global Area Configuration Page

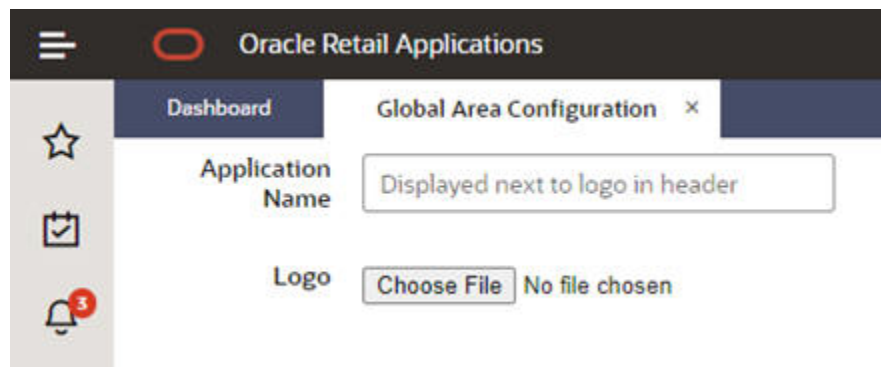

The Global Area Configuration page can be reached through the Settings menu (Settings > User Interface > Global Area Configuration). After making changes, including updating the application name and uploading the logo, on this page, click **Save** or **Save and Close** to apply the new settings. To revert to the default settings, remove the custom value and click **Save**.

Downloading the Starter Kit

The Download Starter Kit option provides administrators with the capability to download the Configuration Tools starter kit for their applications. An administration user can access the Download Starter Kit menu from the Settings gear icon, as shown in [Figure 16-25](#).

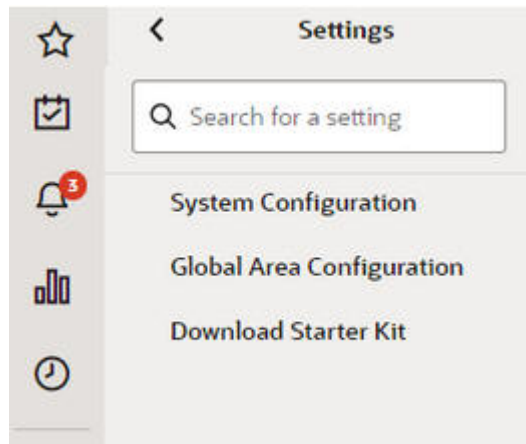
Figure 16-25 Download Starter Kit Option

A dialog box is displayed that lists the available Configuration Tools starter kit versions specific to the application. Select the appropriate version and click **OK**. The started kit file will be downloaded to the user's system.

Monitoring Subscription Usage in Retail Home

All Oracle Retail cloud service subscriptions include a subscription metric that defines in some way the capacity of the systems provisioned as a part of the subscription. The actual metric varies across Oracle Retail cloud services.

For RPASCE applications, the subscription metric is tens of millions of annual sales in units, or 10M annual Sales Units, as it often appears. Users with administrative rights for Retail Home can view information on the quantity of units defined for their subscription and see information on actual usage over time for RPASCE application subscriptions (and any other Oracle Retail cloud service subscriptions) as well as for the AI Foundation component that is a part of every Oracle Retail cloud service subscription. This information is accessible on the Application Dashboard screen of Retail Home, shown in [Figure 16-26](#).

Figure 16-26 Retail Home Application Dashboard

Subscription Start	Subscription End	Subscription Time Left	Metric Description	Quantity	Total Purchased	Consumed	Remaining
07/20/2022	07/20/2025	31 Months	10M Annual Sales Units	11	110M	nullM	nullM

Version Installed: 23.1.101.0.4.1022
Installed: 12/12/2022

Subscription Usage Information is unavailable.

For more information on accessing the Application Dashboard, as well as information on the information presented on that screen, refer to the chapter "Application Dashboard" of the *Oracle Retail Home Administration Guide*.

DV Report Configuration

An administrative user can use the DV Report Configuration page to configure Data Visualization (DV) Reports that are created in the Oracle Analytics DV Environment. The user can add, rename, and delete DV Reports. The user can access the DV Report Configuration feature from the Settings icon available at the bottom of the left sidebar menu, as shown in [Figure 25](#).

Figure 16-27 DV Report Configuration

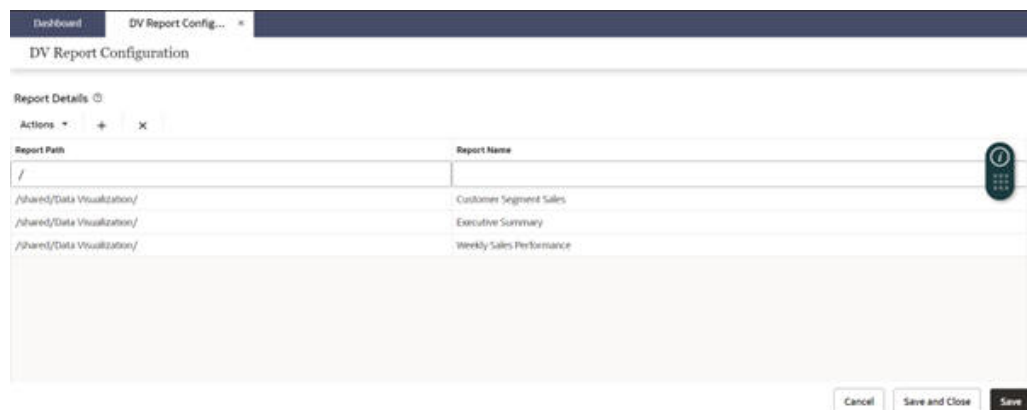

Indicators for Report Details provide a brief description of report path and report name properties. Log into the Oracle Analytics DV environment to obtain the report path and report name. DV Reports in the Oracle Analytics environment are stored with or without subdirectories under My Folders or Shared Folders as the parent directory. The report path for the Shared Folders starts with /shared and My Folders starts with /users.

Figure 16-28 DV Report Environment Path

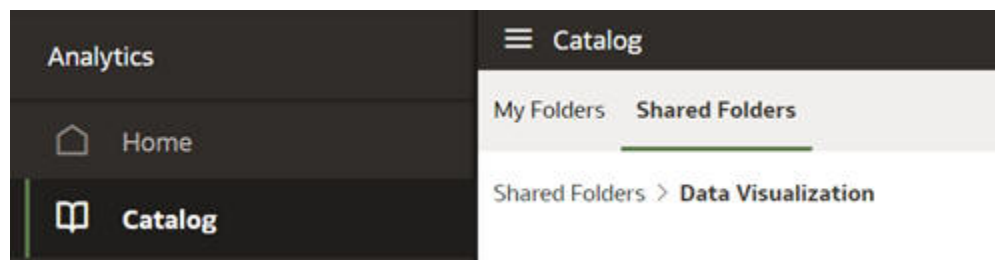

You can add and delete reports using either the + / x buttons or the Action menus..

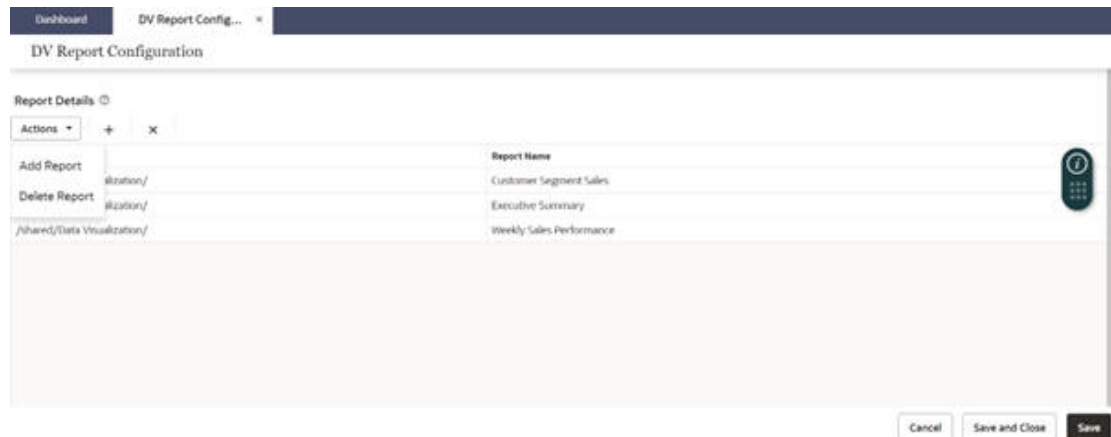
Figure 16-29 DV Reports Adding and Deleting

Once you have configured your reports, click **Save** or **Save & Close** to save your changes. Note that, to apply the saved changes, you must re-log into the application.

Images and Contextual Help

Valid Hosts: Users can specify a web URL as the source of an image(s) (typically the content management server) or source for contextual help. Due to security reasons, the RPASCE client will only use images or contextual help links from these configured hosts. Users are only allowed to enter URLs from the hosts defined by this setting in System Configuration.

The dimension for which the images are to be displayed must have a dimension attribute measure registered of type string that has the UI Type property set to media. For example, consider that the name of the dimension attribute measure is `addvskupimgt` for dimension `skup`. The measure must be loaded into PDS using Load Fact Data.

Each record in the input file is a position ID followed by the image URL wrapped in the `<image>` tag. The example input file below is in the .csv format and hence named `addvskupimgt.csv.ovr`.

```
70063172,"<image id=""main"" label=""Front""><url
size=""thumb"">http://127.0.0.1:7001/contentserver/imgfetch/1000396_Front_full.jpg</
url></image>"
73137693,"<image id=""main"" label=""Front""><url
size=""thumb"">http://127.0.0.1:7001/contentserver/imgfetch/CardiganLS.jpg</url></
image>"
96880516,"<image id=""main"" label=""Front""><url
size=""thumb"">http://127.0.0.1:7001/contentserver/imgfetch/1000399_Front_full.jpg
88805005,http://127.0.0.1:7001/contentserver/imgfetch/1000378_Front_full.jpg
72939751,http://127.0.0.1:7001/contentserver/imgfetch/1000439_Front_full.jpg
96666402,http://127.0.0.1:7001/contentserver/imgfetch/1000440_Back_full.jpg
```

The use of the double quotes in the lines above is the standard way of escaping double quotes in any RPASCE measure's csv input files.

RPASCE Health Check and System Tasks

RPASCE provides a health-check framework that automatically runs diagnostic tasks every night to verify that the application is in a healthy state. These tasks include the following:

- Remove Orphaned Workbooks
- System Task for updating Offer Metrics
- Purge Notifications

These tasks are listed only for information purposes. Except the nightly application backup task, the admin user cannot configure the health check tasks.

Figure 17-1 Online Administration Dashboard

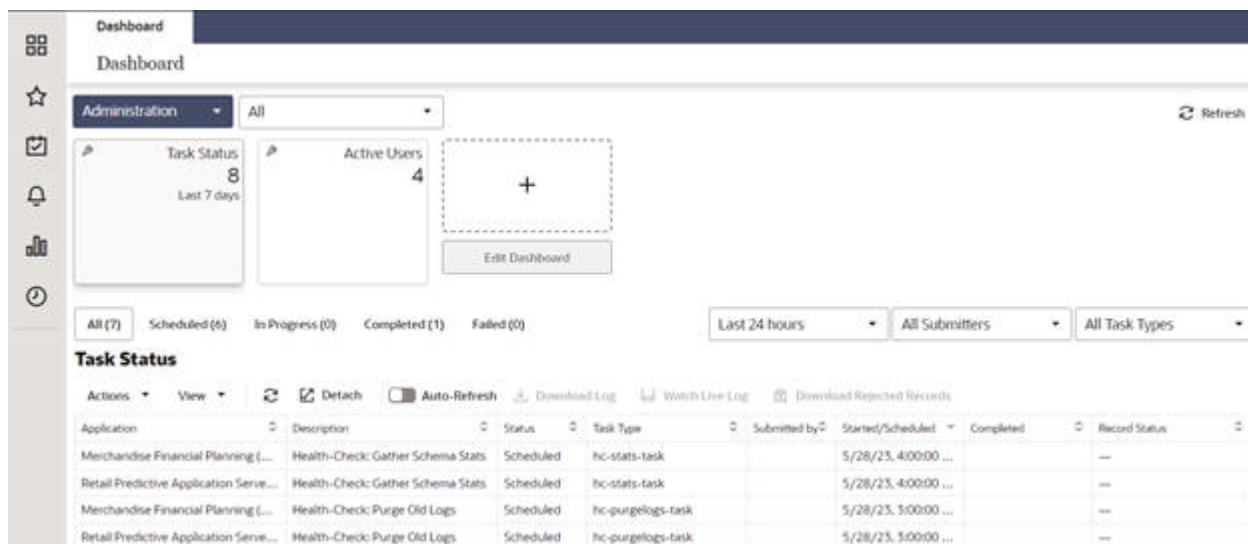

Remove Orphaned Workbooks

This task detects and removes workbooks that are not associated with any segments. Workbooks that are not associated with any segments are those that remain after an unexpected application error occurs. These workbooks will not appear in recent plans without an associated segment; since there is no way the workbooks can be salvaged, they will be removed to save space.

System Task for Updating Offer Metrics

Offer metrics are metrics calculated for each implementation that typically show the Annual Sales Units for each implemented planning solutions; customers may be charged for their application-level usage based on these metrics. The Application Dashboard in Retail Home allows customers to view the usage metrics for their subscriptions. This system task is scheduled to run on a weekly basis to calculate the offer metrics and update the database used by Retail Home.

Purge Notifications

This task purges RAF notifications in the database periodically to ensure the notification service runs smoothly and efficiently. Notifications older than 90 days are purged on a weekly basis.

18

Maintenance Tasks

[RPASCE Health Check Tasks](#) addresses the automatic maintenance that can be performed on the RPASCE application. This chapter describes the periodic maintenance tasks that must be performed by an administrator. These actions are required to keep the system running smoothly over a long period of time.

Clean Up Old Workbooks

It is possible to list all the workbooks in the application and determine which ones are old. "[Managing Workbooks Using wbmgr](#)" describes using the option Manage Workspaces to list all the workbooks in the application. From this output, all the old and obsolete workbooks can be found. These old workbooks can be removed using the same Managing Workbooks task. Removing only the workbook and keeping the associated segment can help to rebuild the workbook later using the same selections if required. Segments without their workbooks do not require much space. Alternately, the entire segment can be removed using the Managing Segments task.

Clean Up Old Administration Tasks

The tasks in the OAT dashboard grow over time and take up valuable system resources. It is recommended that an Admin user periodically purge unused admin tasks. The task to perform the purge operation is described in "[Purge Tasks from Task Status Dashboard Task](#)".

Performance Diagnostic Tool

The performance diagnostic tool contains valuable options to analyze system resources. See "[Analyzing Workbook Performance](#)" on how to efficiently find workbooks that can be cleaned up.

Logging Framework

The logging framework improves existing log output to provide substantially more data. This utility also provides functionality to convert the server log to json logs, which can be further consumed by modern cloud-based logging frameworks such as Kibana.

Log File and Format

Each server log has both a regular log file with extension .log and an accompanying metadata file. For the task log, the metadata file is task_result.json. For the user's log, the metadata file is the log file with an extra .json extension.

The json file includes the following:

- **taskId.** This is derived from the task data. TaskID is optional. The logs in the user's directory do not contain it.
- **sessionId.** The session ID for the log. Optional.
- **userId.** The user ID of the user who submits the task or starts the session.
- **source.** This can be derived from the task data. For logs in the user directory, the source is convoserver.
- **status.** The status of the task or session. Values are success, failed, and aborted.

In the log file, in addition to the log message, each log line must have the following components:

- **TimeStamp.** TimeStamp is in the format of: 2021-08-30T14:56:55.357Z.
- **Severity.** Log level for Severity. It is the first character after the opening < in each logline. D is for Debug, P is for Profile, U is for Audit, I is for Information, W is for Warning, E is for Error, N is for None, and B is for Basic. The log level can be manually set as a PDS property for all users using the OAT task. See the task List/Set/Unset PDS environment variable in [Online Administration Tools](#) for setting and unsetting the log level.
- **Role.** The intended role for the log. This entry is important for errors and exceptions. In the log file, the role is logged as r:X, where X is the value D, S, C, or U. D indicates Developer, S indicates Support, U indicates User, and C indicates Customer. This is to make the log line as short as possible.
- **Operation.** Optional. In the log file, the operation is logged as op:XXXX. If omitted, it will default to a question mark (?). It usually indicates that there is no valid operation at the time of logging (for example, logging generated during program starts or exits). The valid Operations include Workbook Build, Open, Calc, Refresh, Commit, Custom Menu, Batch (Generic), Batch Calc, Batch Load Dim, and Batch Load Fact.

If the log represents an exception or error, the following information is also logged.

- **MsgCode.** This field is optional and is for error logs only. It is displayed in the format [Component]-[Sub-component]-[Number] format (for example, UIS-LOGN-0017). The MsgCode is attached to the end of the translated message with a prefix of msgcode:.

- **InstanceID.** In addition to error code, each exception must have a unique uuid ErrorInstance code generated. This is used to identify and locate the error in the logs. The instance ID is attached to the end of the translated message with a prefix instanceid:.

Access to Logs

The user can access the log files using the Task Status Dashboard, shown in [Figure 19-1](#).

Figure 19-1 Task Dashboard

Description	Status	Task Type	Submitted by	Started/Scheduled	Completed	Record Status
Measure Analytic DT	Success	WebBatch Build	ociadmin	8/1/21 7:40:19 AM	8/1/21 7:40:42 AM	---
MP Alter	Success	WebBatch Build	ociadmin	8/1/21 7:34:28 AM	8/1/21 7:36:55 AM	---
Consignment Maintenance	Success	WebBatch Build	ociadmin	8/1/21 7:19:31 AM	8/1/21 7:20:18 AM	---
MA 01	Success	WebBatch Build	ociadmin	8/1/21 7:14:02 AM	8/1/21 7:14:42 AM	---
Health-Check Perido Task	Success	hc-period-task	ociadmin	8/1/21 8:00:13 PM	8/1/21 8:00:58 PM	---
MT after HierMain update	Success	WebBatch Build	ociadmin	8/31/21 12:08:21 PM	8/31/21 12:14:04 PM	---
Consignment Maintenance	Success	WebBatch Build	ociadmin	8/31/21 11:47:59 AM	8/31/21 11:48:01 AM	---
Consignment Maintenance	Success	WebBatch Build	ociadmin	8/31/21 11:45:20 AM	8/31/21 11:45:51 AM	---
Subgrp 1 Maintenance	Success	WebBatch Build	ociadmin	8/31/21 11:39:29 AM	8/31/21 11:39:33 AM	---
Security Administration	Success	WebBatch Build	ociadmin	8/31/21 11:32:28 AM	8/31/21 11:33:35 AM	---
MP01	Success	Commit	ociadmin	8/31/21 7:30:42 AM	8/31/21 7:31:32 AM	---
MP01	Success	WebBatch Build	ociadmin	8/31/21 7:13:40 AM	8/31/21 7:21:40 AM	---
Run Batch Task Group - Post Deploy	Success	Run Batch Task Group	ociadmin	8/31/21 6:00:23 AM	8/31/21 7:09:41 AM	---
Health-Check Perido Task	Success	hc-period-task	ociadmin	8/31/21 8:00:13 PM	8/31/21 8:00:58 PM	---

If the user highlights a particular task, the buttons **Download Log** and **Watch Live Log** will be enabled. Click **Download Log** to start a download process that will download the complete task log. Click **Watch Live Log** to see a pop-up showing the beginning of the log, as shown in [Figure 19-2](#).

Figure 19-2 Live Log View

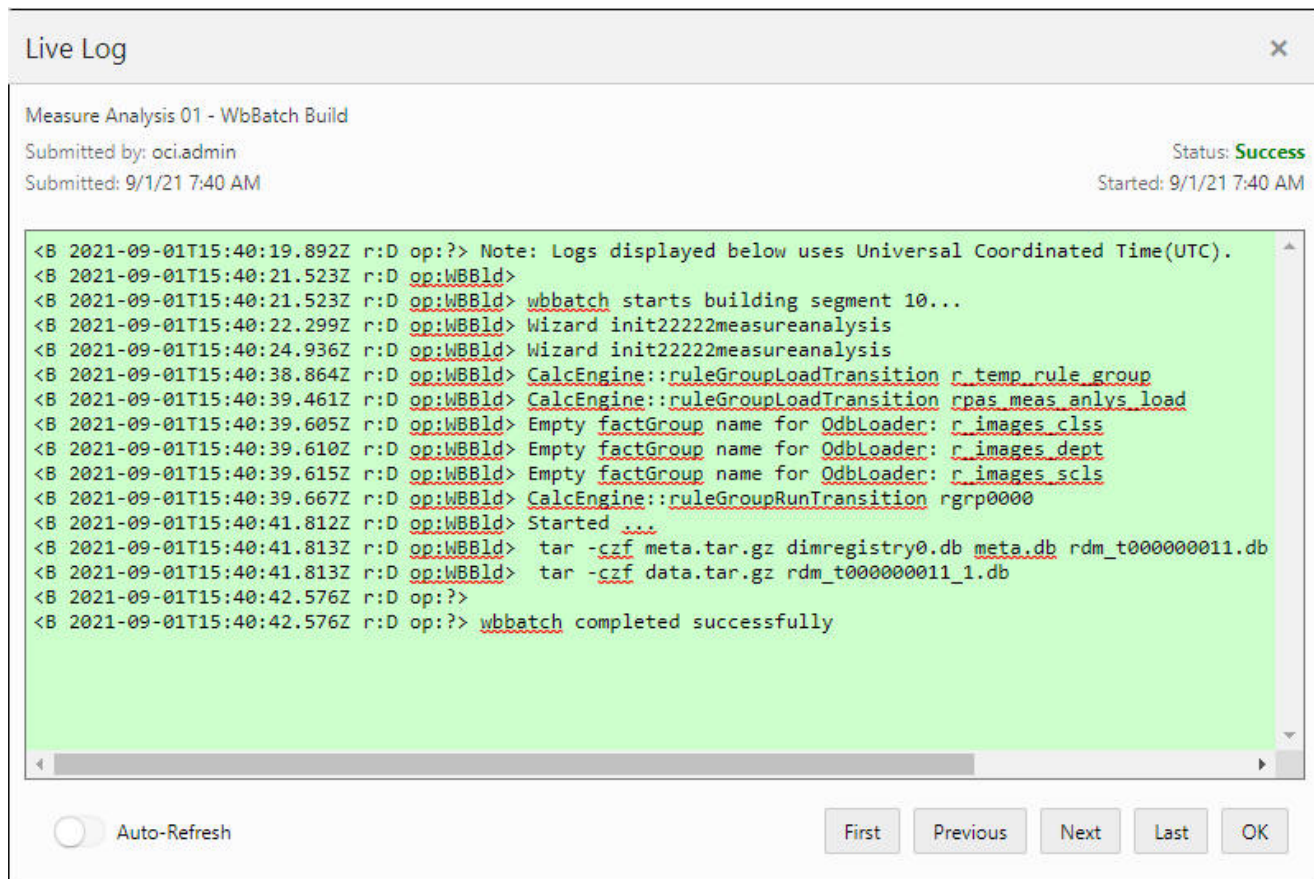

The window displays the first section of the task's log. Click **Next** to display the next N lines of logs. Use **First** and **Last** to show the current first or last section of the log.

If the task has not yet finished, the user can enable the Auto-Refresh slide control; the display will then automatically refresh every few seconds to show the latest logs, including the database logs for the task.

logAggregator Utility

The logAggregator utility translates the plain rpas logs into json strings that can be consumed by ELK. The utility runs in the background on a timer. Every n seconds, it wakes up and checks the output directories in the RDM for any update log files.

If any log file have been updated since the last time it checked, the utility converts the newly generated logs into json line by line, injecting extra json fields as it sees fit, and casts the json object to the output console for the ELK to ingest.

logAggregator Syntax / Usage

logAggregator -pds \$RDM_PATH -interval \$INTV The interval arguments specifies the interval before the utility must wait to wake up again. If the interval is too long, it may force the utility to process too much data at once. If the interval is too short, it may impact overall performance.

The utility must be started at the time the container is started, and it must run to the time the container stops.

Watch Log Directories on Wake up

Once the utility wakes up, it monitors the `rdm` output directory for updated log files. For each log file it finds, it also looks for the `json` file for metadata. It starts to process the log file once the metadata is provided, and stop processing once the status entry in the metadata indicates that the process has completed successfully or has failed. Once `logAggregator` determines that the logging process is complete and has processed all the loglines in the log file, it will removed the log file from the disk.

Generate Json Log Entries

The `logAggregator` utility translates each log line into a json object, based on the information provided in the log and the metadata. Once the json object is generated, the `logAggregator` will print the json to standard output for ELK.

Json Log Format

The `logAggregator` utility translates the logline to json objects with the following entries:

- **id.** The transaction ID that identifies the origin of the log. This can be the `taskId` if the log is for a task, or `sessionId` if it is for a user session.
- **userid.** The login user or the user who started the task.
- **timestamp.** In the format required.
- **source.** The source of the log. This can be a Classname (Java/C++) or a binary name (`convoserver`, `mace`, `wbbatch`, `loadDimData`, `loadFactData`, `registerApp`, and so on).
- **severity.** The log level.
- **role.** The roles to which the log is targeted.
- **msgcode.** For error logging. A message-code in the format `[Component]-[Sub-component]-[Number]` (for example, `UIS-LOGN-0017`). This indicates a login sub-component from the UI Server.
- **instanceid.** For error logging. A unique UUID for each instance of a logged message.
- **msg.** The actual log message, which can contain the log message as well as an exception trace.
- **operation.** The type of operation that produced the log (for example, `WBBuild`, `Calc`, `Commit`, `Refresh`, `CustomMenu action`, `Batch`, and so on). This helps the user identify the functional area that cannot be identified by the source field, as most RPASCE logs are generated by the `Convoserver` utility.

20

Best Practices

This chapter describes the best practices for PDS.

Measure to Fact Mapping and Optimal Fact Grouping

This section describes measure to fact mapping and optimal fact grouping.

Measure to Fact Mapping

When working with multiple applications, a configurator is expected to carefully map the application measures to facts, especially for the measures/facts shared by multiple applications. Incorrect or missing mapping may not only unnecessarily increase the number of facts, but also result in issues in data integration later at run time. For example, app1/measureA and app2/measureB are meant to be a shared measure and must be mapped to the same fact. If this mapping is not identified, instead of having a shared fact1, the configurator incorrectly creates two facts. Such incorrect mapping not only unnecessarily creates more facts than needed, but also breaks the integration between app1/measureA and app2/measureB.

Optimal Fact Grouping

In PDS, facts are grouped and facts in the same group are stored in the same fact table. Optimal fact grouping is automatically done by ConfigTools based on the facts' base intersection, batch and workbook commit rules, facts' input source, and so on. (see *Oracle Retail Predictive Application Server Cloud Edition Configuration Tools User Guide* for details).

Fact grouping has a direct performance impact on data loading, batch calculation, and workbook commit. The configurator is expected to carefully configure all rules and rule groups, assign measures' base intersections, and file name attributes, which defines the measures' input source.

Data Loading

Facts can be loaded from flat files or RDX interfaces. To achieve optimal performance, each input file or RDX interface must contain all measures/facts with the same file name attribute. In other words, each file or RDX interface must cover *all* facts of the target fact tables. (Mapping of one file/interface to two+ fact tables is fine.)

Free Expressions in Batch Control File

Free expressions are supported in batch control file, but their execution is not optimal, for two reasons. They are translated into PL/SQL blocks and executed expression by expression, in the order that they appear in the batch control file. The free expressions are not taken into consideration in optimal fact grouping as they do not appear as batch rule groups in the application configuration.

It is recommended that the users minimize the use of free expressions. An alternative way is to configure them as rule group(s).

A

Appendix: Troubleshooting

This appendix provides troubleshooting information.

Time Zone

RPASCE in the cloud environment always runs in the UTC time zone. All the downloaded log files, as well as the live logs you view, display information in the UTC time zone only.

The following message is displayed in every log file for all OAT tasks:

<B 2021-08-31T15:17:15.154Z r:D op:?> Note: Logs displayed below uses Universal Coordinated Time(UTC).

Note that when you schedule an OAT task or view the timestamps for a task in the dashboard, the time will match your browser time zone. This is done to prevent confusion when you are scheduling the task.

Figure A-1 Log File - Time Zone

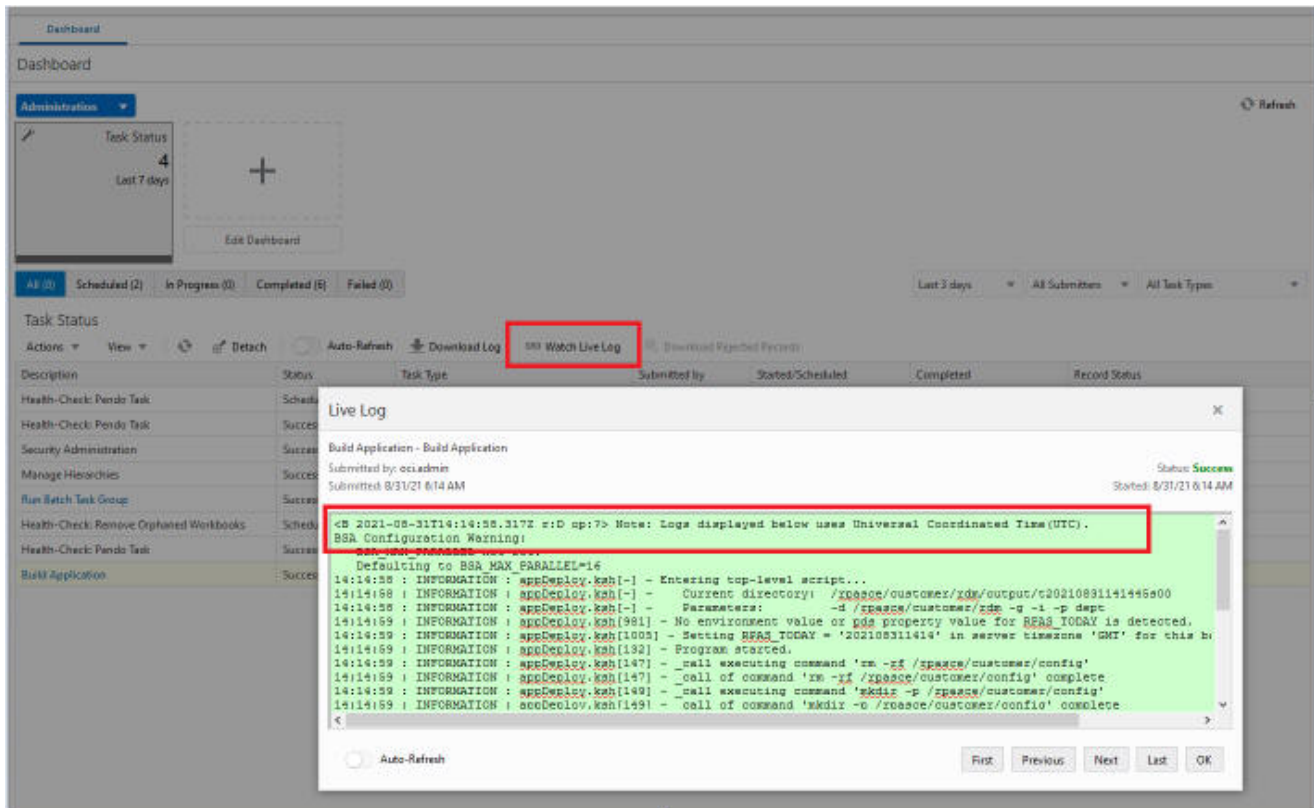

Stopping a Running Process

If you need to stop an in-progress OAT task that appears to be stuck, see the Cancel Task section under [Application Administration Tasks](#) for details on how to proceed.

Drilling Down to Actual Logs

The Dashboard provides the functionality to drill down through the OAT task log files for long-running OAT tasks. This is useful for monitoring tasks that are in a running state; it can also be used to drill down to failed tasks and open the log files.

Figure A-2 shows drilling down to actual logs.

Figure A-2 Drilling Down - Actual Logs

The screenshot shows the Oracle Retail Applications Dashboard. The 'Task Status' section is active, displaying a summary card with 'Task Status: 13 Last 7 days'. Below the card, a table lists tasks. The 'Run Batch Task Group' is highlighted in orange, indicating it is in progress. The table has columns for Description, Status, Task Type, Submitted by, Started/Scheduled, Completed, and Record Status.

Description	Status	Task Type	Submitted by	Started/Scheduled	Completed	Record Status
Run Batch Task Group	In Progress	Run Batch Task Group	oci.admin	9/2/21 12:21:00 PM		—

Figure A-3 shows drilling down to actual logs for a running task.

Figure A-3 Drilling Down - Running Task

The screenshot shows the Oracle Retail Applications Dashboard with the 'Task Status' section for 'Run Batch Task Group' expanded. The table below shows detailed task logs, including sub-steps like 'Execute set report_all', 'Calculate set calc_exp_set', and 'Batch_GB'. The 'Batch_GB' step is highlighted in orange, indicating it is in progress.

Description	Status	Task Type	Submitted by	Started/Scheduled	Completed	Record Status
#3 Execute set report_all	In Progress	EE Execute	oci.admin	9/2/21 12:22:13 PM		—
Calculate set calc_exp_set	In Progress	EE Calc	oci.admin	9/2/21 12:22:23 PM		—
#1 Batch_GB	Success	EE Calc Group	oci.admin	9/2/21 12:22:18 PM	9/2/21 12:23:04 PM	—
#2 Batch_Exp_Set	In Progress	EE Calc Group	oci.admin	9/2/21 12:23:07 PM		—
Step 1	Success	Calc Step	oci.admin	9/2/21 12:23:14 PM	9/2/21 12:23:27 PM	—
Step 2	In Progress	Calc Step	oci.admin	9/2/21 12:23:28 PM		—

Figure A-4, Figure A-5, and Figure A-6 show drilling down to actual logs for a failed task.

Figure A-4 Drilling Down - Failed Task Part 1

Oracle Retail Applications Dashboard

Task Status: 13 Last 7 days

Filters: All (13) | Scheduled (2) | In Progress (0) | Completed (10) | Failed (1)

Description	Status	Task Type	Submitted by	Started/Scheduled	Completed	Record Status
Run Batch Task Group	Failed	Run Batch Task Group	ocladmin	9/2/21 12:13:26 PM	9/2/21 12:15:40 PM	—
Expressions, Rules and Rule Groups Information	Success	Expressions, Rules and Rule Groups Information	ocladmin	9/2/21 12:08:47 PM	9/2/21 12:09:25 PM	—
HelloTASKLABEL	Success	Expressions, Rules and Rule Groups Information	ocladmin	9/2/21 12:00:08 PM	9/2/21 12:00:06 PM	—
Search for String	Success	Expressions, Rules and Rule Groups Information	ocladmin	9/2/21 11:53:40 AM	9/2/21 11:53:40 AM	—
Expressions, Rules and Rule Groups Information	Success	Expressions, Rules and Rule Groups Information	ocladmin	9/2/21 11:38:07 AM	9/2/21 11:38:57 AM	—

Figure A-5 Drilling Down - Failed Task Part 2

Oracle Retail Applications Dashboard

Task Status: 13 Last 7 days

Filters: All (13) | Scheduled (0) | In Progress (0) | Completed (1) | Failed (12)

Task Status > Run Batch Task Group

Description	Status	Task Type	Submitted by	Started/Scheduled	Completed	Record Status
#1 Execute set load_hier	Failed	EE Execute	ocladmin	9/2/21 12:13:50 PM	9/2/21 12:14:42 PM	—
Load prod dimension	Success	EE Load PDS Dimension	ocladmin	9/2/21 12:14:03 PM	9/2/21 12:14:24 PM	—
Load prod dimension	Failed	EE Load PDS Dimension	ocladmin	9/2/21 12:14:25 PM	9/2/21 12:14:42 PM	—

Figure A-6 Drilling Down - Failed Task Part 3

The screenshot shows the Oracle Retail Applications dashboard. The main content area displays the 'Task Status' for a 'Run Batch Task Group'. The status is 'Failed (2)'. Below this, there are filters for 'All (3)', 'Scheduled (0)', 'In Progress (0)', 'Completed (1)', and 'Failed (2)'. The 'Download Log' button is highlighted with a red box. Below the filters, there is a table of task details.

Description	Status	Task Type	Submitted by	Started/Scheduled	Completed	Recent Status
#1 Execute set load_hier	Failed	EE Execute	occladmin	9/2/21 12:13:50 PM	9/2/21 12:14:42 PM	—
Load cnd dimension	Success	EE Load PDS Dimension	occladmin	9/2/21 12:14:03 PM	9/2/21 12:14:24 PM	—
Load prod dimension	Failed	EE Load PDS Dimension	occladmin	9/2/21 12:14:29 PM	9/2/21 12:14:42 PM	—

Missing Batch Task Group in OAT Wizard

After uploading the batch control files to the PDS, if you see that a batch task group is missing from the drop-down list, check the batch control file `batch_oat_list.txt` that was uploaded. This file holds keys to the value seen in the dropdown.

Figure A-7 Missing Batch Control File

Submit a New Admin Task

Specify the arguments for task:

Task Label
Run Batch Task Group

Offline Mode Message

Batch Task Group
Daily Batch (leave blank to run all steps)

- Daily Batch
- Export All Approved Plans
- Export All Working Plans
- Export Plans to RI
- Exports to Shared Services
- Import Actuals
- Import Forecasts
- Import Hierarchies

Stale Segments

When a weekly batch or a daily batch runs, it may load new hierarchy files, and this might cause some existing segments to become out of sync with the hierarchy in the PDS. Although in most cases the segments will still be useful to an extent, committing data from the stale segment can cause unusual issues. The commit must work for all valid positions in the segment and ignore invalid positions. However, if a large number of reclassification and other hierarchy changes are made, the commit can run into issues in some rare cases. Therefore, you should rebuild segments if many changes are made to the hierarchy in the PDS.

Log Level During Batch

Do not run weekly and daily batches with log-level debug or log-level all. Doing so puts an unnecessary burden on the system. The log level profile provides sufficient information for most customer analysis of batch runs.

Download Rejected Records

Load Dimension Data and Load Fact Data can generate rejected records. These rejected records are stored separately from the normal log files. The **Download Rejected Records** button is only activated when rejected records are generated in the process.

Figure A-8 Rejected Records

Task Status

Actions View Auto-Refresh Download Log Watch Live Log **Download Rejected Records**

Application	Description	Status	Task Type	SubmittedBy	Started/Scheduled	Completed	Record Status
Merchandise Financial Pla...	Health-Check: Gather Sch...	Scheduled	hc-stats-task		7/9/23, 12:0...		---
Merchandise Financial Pla...	Health-Check: Purge Old ...	Scheduled	hc-purgelogs-task		7/8/23, 11:0...		---
Merchandise Financial Pla...	Health-Check: Remove Or...	Scheduled	hc-orphaned-rvbs		7/8/23, 9:00...		---
Merchandise Financial Pla...	Load Prod	Failed	Load Dimension D...	oci.admin	7/7/23, 10:3...	7/7/23, 10:4...	3 of 21 failed
Merchandise Financial Pla...	Run Batch Task Group	Success	Run Batch Task Gr...	oci.admin	7/7/23, 10:2...	7/7/23, 10:2...	---
Merchandise Financial Pla...	Build Application	Success	Build Application	oci.admin	7/7/23, 9:30...	7/7/23, 9:36...	Rejected records
Merchandise Financial Pla...	Template Status	Success	Template Status	oci.admin	7/7/23, 9:14...	7/7/23, 9:14...	---

 **Note:**

The lines contained in the rejected record file may be different than the original data file because of the different column order between the data file vs. the configuration or data file that contains unused columns. The user must use the root position names to look up the original line in the source.